



EUROPEAN COMMISSION

**Integrated Pollution Prevention and Control**

Reference Document on  
Best Available Techniques for the Manufacture of

**Large Volume Inorganic  
Chemicals – Solids and Others  
industry**

August 2007

This document is one of a series of foreseen documents as below (at the time of writing, not all documents have been completed):

<b>Reference Document on Best Available Techniques . . .</b>	<b>Code</b>
Large Combustion Plants	LCP
Mineral Oil and Gas Refineries	REF
Production of Iron and Steel	I&S
Ferrous Metals Processing Industry	FMP
Non Ferrous Metals Industries	NFM
Smitheries and Foundries Industry	SF
Surface Treatment of Metals and Plastics	STM
Cement and Lime Manufacturing Industries	CL
Glass Manufacturing Industry	GLS
Ceramic Manufacturing Industry	CER
Large Volume Organic Chemical Industry	LVOC
Manufacture of Organic Fine Chemicals	OFC
Production of Polymers	POL
Chlor – Alkali Manufacturing Industry	CAK
Large Volume Inorganic Chemicals - Ammonia, Acids and Fertilisers Industries	LVIC-AAF
<i>Large Volume Inorganic Chemicals - Solid and Others industry</i>	<i>LVIC-S</i>
Production of Speciality Inorganic Chemicals	SIC
Common Waste Water and Waste Gas Treatment/Management Systems in the Chemical Sector	CWW
Waste Treatments Industries	WT
Waste Incineration	WI
Management of Tailings and Waste-Rock in Mining Activities	MTWR
Pulp and Paper Industry	PP
Textiles Industry	TXT
Tanning of Hides and Skins	TAN
Slaughterhouses and Animals By-products Industries	SA
Food, Drink and Milk Industries	FDM
Intensive Rearing of Poultry and Pigs	ILF
Surface Treatment Using Organic Solvents	STS
Industrial Cooling Systems	CV
Emissions from Storage	ESB
<b>Reference Document . . .</b>	
General Principles of Monitoring	MON
Economics and Cross-Media Effects	ECM
Energy Efficiency Techniques	ENE

Electronic versions of draft and finalised documents are publically available and can be downloaded from <http://eippcb.jrc.es>

## EXECUTIVE SUMMARY

### Introduction

The BAT (Best Available Techniques) Reference Document (BREF) entitled Large Volume Inorganic Chemicals – Solids and Others (LVIC-S) industry reflects an information exchange carried out under Article 16(2) of Council Directive 96/61/EC (IPPC Directive). This Executive Summary describes the main findings, a summary of the principal BAT conclusions and the associated consumption and emission levels. It should be read in conjunction with the preface, which explains this document's objectives; how it is intended to be used and legal terms. It can be read and understood as a standalone document but, as a summary, it does not represent all the complexities of this full document. It is therefore not intended as a substitute for this full document as a tool in BAT decision making.

### Scope of this document

The BREF on the LVIC-S industry is a neighbour to the Chlor-alkali (CAK), Large Volume Inorganic Chemicals – Ammonia, Acids and Fertilisers (LVIC-AAF), and Speciality Inorganic Chemicals (SIC) BREFs.

A homogeneous and strictly defined LVIC-S industry does not really exist, and there are no clear borderlines between the above-mentioned four inorganic chemical industry groups and the four associated BREFs.

The scope of this document is, in principle, relevant to industrial activities covered in Annex I to the IPPC Directive (96/61/EC) Section 4.2. 'Chemical installations for the production of basic inorganic chemicals', in particular to activities covered in points 4.2.d and 4.2.e.

Annex I to the IPPC Directive does not give any threshold value of the capacity for chemical industry plants, neither does it define the concepts of 'large volume', 'cornerstone' and 'selected illustrative' LVIC-S products used in this document, however, the following criteria were adopted for the selection of the processes covered in this document:

- scale and economic importance of the production
- number of plants and their distribution in different Member States
- impact of a given industry on the environment
- accordance of the industrial activities with the structure of Annex I to the Directive
- representativeness for a wide range of technologies applied in the LVIC-S industry
- validated data and information on LVIC-S products sufficient to formulate 'Techniques to consider in the determination of BAT' and to draw BAT conclusions for the manufacture of these products.

The LVIC-S products addressed in this document include:

I. Five products at the so-called 'cornerstone' level, addressed in Chapters 2 through to 6:

- soda ash (sodium carbonate, including sodium bicarbonate)
- titanium dioxide (chloride and sulphate process routes)
- carbon black (rubber and speciality grades)
- synthetic amorphous silica (pyrogenic silica, precipitated silica, and silica gel)
- inorganic phosphates (detergent, food and feed phosphates).

### II. 17 LVIC-S products at the so-called ‘selected illustrative’ level, addressed at a lesser level of detail in Chapter 7 (Sections 7.1 to 7.17):

- aluminium fluoride (two process routes: starting from fluorspar and from fluosilicic acid)
- calcium carbide (a high temperature electrothermic process, starting from lime and carbon)
- carbon disulphide (the methane process, based on the reaction of sulphur with natural gas)
- ferrous chloride (the process-integrated with the production of TiO<sub>2</sub> by the chloride route)
- copperas and related products (co-products in the manufacture of TiO<sub>2</sub> by the sulphate route)
- lead oxide (production processes for the manufacture of red lead and litharge, from pure lead)
- magnesium compounds (produced by the wet process route to magnesium chloride and oxide)
- sodium silicate (covering the production of water glass by the melting and hydrothermal routes)
- silicon carbide (a high temperature electrochemical process starting from silica and carbon)
- zeolites (production processes to synthetic aluminosilicates, including zeolites A and Y)
- calcium chloride (processes routes related to soda ash and magnesia, and the HCl-CaCO<sub>3</sub> route)
- precipitated calcium carbonate (production by the reaction of calcium hydroxide with CO<sub>2</sub>)
- sodium chlorate (produced by the electrolysis of an aqueous solution of sodium chloride)
- sodium perborate (produced by the reaction of borax and NaOH, and the reaction with H<sub>2</sub>O<sub>2</sub>)
- sodium percarbonate (produced by the crystallisation and the spray-granulation process routes)
- sodium sulphite and related products (the family of sodium products obtained by the reaction of SO<sub>2</sub> with an alkali)
- zinc oxide (obtained by the direct process, the five indirect processes, and the chemical process).

The following points indicate the main structure of this document:

- the executive Summary gives concise information on the main findings from the chapters in this document
- the preface explains the status and objectives of this document, and how to use it
- the scope gives details on the scope of the TWG work and the structure of this document
- Chapter 1 gives a general description of the LVIC-S industry, its potential and characteristics
- Chapters 2, 3, 4, 5 and 6 give description of five cornerstone LVIC-S products, including a BAT chapter for each cornerstone product
- Chapter 7 gives descriptions of 17 selected illustrative LVIC-S groups of processes, including a BAT chapter for each illustrative process
- Chapter 8 illustrates common abatement measures applied in the LVIC-S industry
- Chapter 9 gives description of Emerging Techniques in the LVIC-S industry
- Chapter 10 gives the Concluding Remarks relevant to this document
- the references detail the main sources of information used in developing this document
- the glossary of terms and abbreviations is meant to help the user understand this document
- the annexes provide additional information relevant to this document and, in particular:
  - Annex 3 – includes ‘good environmental practices (GEP) in the LVIC-S industry’.

As it was considered important not to lose even partial or incomplete information on the LVIC-S products, an ‘Additional information submitted during the information exchange on LVIC-S industry’ document, accessible through the EIPPCB website <http://eippcb.jrc.es>, contains partial data and information related to nine ‘selected illustrative’ LVIC-S products, which could not have been used to draw BAT conclusions. These are: 1. Aluminium chloride; 2. Aluminium sulphate; 3. Chromium compounds; 4. Ferric chloride; 5. Potassium carbonate; 6. Sodium sulphate; 7. Zinc chloride; 8. Zinc sulphate; and 9. Sodium bisulphate.

The ‘Additional Information...’ document was not peer reviewed and information within it was neither validated nor endorsed by the TWG or the European Commission, however, it is hoped that this partial information may be used for the revision of the four inorganic chemical industry BREFs.

## Chapter 1 – General information on LVIC-S industry

The EU chemical industry has a growth rate about 50 % higher than that of the EU economy, and when the growth of the EU chemical industry (3.1 %) is compared by sector, the production growth of basic inorganic chemicals is the least dynamic (0.2 %).

The share of the EU in global production of chemicals is dropping, the dynamism of the chemical industry derives not only from its growth but also from rapid technological change that is one of the industry’s outstanding features.

The chemical industry supplies all sectors of the economy, and the EU chemical industry is both its own principal supplier and customer. This is due to the processing chains that involve many intermediate steps in the transformation of chemicals. The manufacture of large volume chemicals is not only the subject of the economy of scale, but is also much more efficient in highly integrated industrial complexes than in isolated plants.

The LVIC-S industry is one of the main pillars of the whole EU chemical industry sector and, without this somewhat mature industry characterised by a relatively slow production growth, it would be impossible to meet the basic needs of the whole economy.

The following table shows the production scale in the European LVIC-S ‘cornerstone’ industry:

LVIC-S product	EU capacity	World share	Number of plants	Range of capacities
Soda ash	7700 kt/year	18 %	14	160 – 1020 kt/year
Titanium dioxide	1500 kt/year	37 %	20	30 – 130 kt/year
Carbon black	1700 kt/year	21 %	22	10 – 120 kt/year
Synthetic amorphous silica	620 kt/year	30 %	18	12 – 100 kt/year
Inorganic phosphates	3000 kt/year (*)	48 %	26 (**)	30 – 165 kt/year (***)
(*) Approximate data; (**) Detergent, food, and feed-grade phosphate plants; (***) For detergent-grade phosphates				

Out of the total of 100 LVIC-S cornerstone plants identified, 21 plants are located in Germany, 10 plants in the UK, nine plants in France, seven plants in Spain, six plants in the Netherlands, and five cornerstone plants respectively in Belgium, Italy and Poland. Austria, the Czech Republic, Finland, Hungary, Norway, Portugal, Slovenia and Sweden each have less than five cornerstone plants. Denmark, Greece, Ireland, Luxembourg, Slovakia, Lithuania, Latvia and Estonia are not represented at the LVIC-S industry cornerstone level.

In addition, over 300 installations are reported to exist in the EU-25 for the production of the ‘selected illustrative’ LVIC-S products, but it can be assumed that ~ 400 installations, with a broad range of capacities and using many production processes, are associated with the LVIC-S industry in the EU.

### Chapter 2 – Soda ash

Soda ash is a fundamental raw material to the glass, detergent and chemical industries and, as such, is of strategic importance in the European and global manufacturing framework.

As trona deposits are not available in Europe, soda ash in the EU is almost entirely manufactured by the Solvay process, using the locally available salt brine and limestone of the required quality. The Solvay process was developed in the 19<sup>th</sup> century and the first soda ash plants in Europe date from that period. All the plants have been modernised and revamped several times to implement technology upgrades and their capacities have been increased to follow market demand.

The European soda ash capacities amount to over 15 million tonnes per year, half of which are in the EU-25. At several sites, soda ash plants have associated refined sodium bicarbonate plants.

The quality of the selected raw materials and geographical location of the production plants have a direct influence on composition, volume and treatment of effluents. The key environmental impacts of the Solvay process are the atmospheric emissions of CO<sub>2</sub>, and aqueous emissions associated with the waste waters from the ‘distillation’ stage of the process.

In some locations – due to long term soda ash operations and the volume and composition of the post-distillation slurry (inorganic chlorides, carbonates, sulphates, alkali, ammonia and suspended solids, including heavy metals derived from the raw materials) – the disposal of the post-distillation effluent is a significant environmental issue, if not managed properly.

The post-distillation slurry is either directed to the aquatic environment for total dispersion (mostly the soda ash plants located at the seaside) or – after liquid/solid separation (mostly from land-locked soda ash plants) – the outgoing clear liquid is directed to the aquatic receptor.

When concluding on BAT for the production of soda ash by the Solvay process, the following key environmental issues have been identified for the sector:

- limited material efficiency of the Solvay process, due to intractable chemical equilibrium limitations, which has a direct impact of the production of soda ash on the environment
- the influence of the quality of the raw materials used (including the heavy metals content), in particular limestone, for the overall impact of the production of soda ash on the environment
- the relatively high volume of the waste waters discharged from the process to the aquatic environment
- the load of suspended solids in the waste waters, including heavy metals derived from the raw materials, and the limited possibilities to separate them from the waste waters in all soda ash producing sites. The best management option depends on local conditions, however, in several locations total dispersion is used without any separation of suspended solids.

13 BAT conclusions have been drawn for soda ash plants in the EU-25 based on the Solvay process, and the following are examples of accepted BAT conclusions which illustrate the drivers for environmental improvement in the soda ash industry sector (all BAT figures relate to yearly average).

#### BAT 2

Total consumption of limestone at the plant inlet in the range of 1.1 – 1.5 tonne per tonne of soda ash, although the consumption of up to 1.8 tonne limestone per tonne of soda ash produced may be justifiable for plants where good quality limestone is not available (i.e. limestone of lower carbonate content, poor burning characteristics and stone friability).

**BAT 3**

Selection of appropriate quality limestone, including:

- high CaCO<sub>3</sub> content, preferably in the range between 95 – 99 % (low MgCO<sub>3</sub>, SiO<sub>2</sub>, SO<sub>3</sub>, and Al<sub>2</sub>O<sub>3</sub>+Fe<sub>2</sub>O<sub>3</sub> content)
- appropriate physical limestone characteristics required in the process (particle size, hardness, porosity, burning properties)
- limited content of heavy metals (As, Cd, Cr, Cu, Hg, Ni, Pb and Zn) in either the purchased limestone or limestone from the currently exploited own deposit.

In cases where the limestone deposit of lower grade, with a content of 85 to 95 % CaCO<sub>3</sub>, is used, and where other limestone of better quality are not readily available, low MgCO<sub>3</sub>, SiO<sub>2</sub>, SO<sub>3</sub>, and Al<sub>2</sub>O<sub>3</sub>+Fe<sub>2</sub>O<sub>3</sub> content is not achievable.

**BAT 5**

Optimised operation of the soda ash plant, to maintain the emissions of CO<sub>2</sub> from the process in the range of 0.2 – 0.4 tonne of 100 % CO<sub>2</sub> per tonne of soda ash produced (integrated production of soda ash with refined sodium bicarbonate at the site can lead to much lower emission levels).

**BAT 8**

The quantity of waste waters discharged from the distillation unit to a local watercourse, in the range of 8.5 – 10.7 m<sup>3</sup> per tonne of soda ash produced.

**BAT 10**

With regard to the impact of waste waters (containing suspended solids and associated heavy metals) discharged from the production of soda ash to the aquatic environment:

A. Where the final discharge is made to the marine environment (to the sea or into an estuary of a river under tidal influence, depending on local considerations), to ensure dispersion of the solids avoiding localised build-up of deposited solids and in any case to minimise the discharge of heavy metals using feedstock selection.

B. Where the final discharge is made to a fresh water body, to:

minimise the emission of heavy metals by the application of at least one of the following techniques:

- selection of appropriate feedstocks
- removal of coarse solids from waste waters
- deposition/dispersion – settling ponds
- deposition/dispersion – underground disposal.

minimise the emission of suspended solids by the application of at least one of the following techniques, depending on the characteristics of the receiving water body:

- selection of appropriate feedstocks
- removal of coarse solids from waste waters
- deposition/dispersion – settling ponds
- deposition/dispersion – underground disposal.

### Chapter 3 – Titanium dioxide

Chapter 3 on Titanium dioxide covers two totally different process routes used for the manufacture of TiO<sub>2</sub> pigments, namely:

- the chloride process (continuous process operations, chlorine inventory involved); and
- the sulphate process (batch process operations, utilisation of spent sulphuric acid involved).

Therefore, Chapter 3 covers the following main issues in an integrated way:

- Section 3.1 – General information on the titanium dioxide industry
- Section 3.2 – Titanium dioxide – the chloride process
- Section 3.3 – Titanium dioxide – the sulphate process
- Section 3.4 – Comparison of the chloride and sulphate processes; and
- Section 3.5 – Best Available Techniques for the production of titanium dioxide.

The titanium dioxide industry has developed dynamically over the past few decades. It is a global industry in which about 1.5 million tonnes of titanium dioxide per year is produced in the EU. Approximately 30 % of this is produced by the chloride process, and the remainder is made by the sulphate process.

Over the past 20 years, the European TiO<sub>2</sub> industry has invested as much as EUR 1400 million in environmental improvement. This expenditure was initiated in the 1970s and was boosted as a result of the TiO<sub>2</sub> Harmonisation Directives: 78/176/EEC; 82/883/EEC and 92/112/EEC, prescribing minimum environmental performance standards for the TiO<sub>2</sub> industry, to which the industry is required to comply. Most of this investment has been put into the sulphate process, and the EU TiO<sub>2</sub> industry believes that environmentally there is little difference between a modern sulphate and chloride process.

However, following the analysis of 12 ‘Techniques to consider in the determination of BAT’ for the chloride process, and 13 ‘Techniques to consider in the determination of BAT’ for the sulphate process, the findings of this document are that the new TiO<sub>2</sub> plants in the EU are more likely to adopt the chloride process route, as it offers better energy efficiency.

Subject to maintaining low chlorine inventory and measures to reduce the environmental risks associated with chlorine and titanium tetrachloride handling (the SEVESO II Directive – Council Directive 96/82/EC on the control of major accident hazards involving dangerous substances), the chloride process is preferable from the point of view of overall environmental impact in the EU. However, given the availability of the TiO<sub>2</sub> feedstock and the findings of the Life Cycle Analysis, neither process route is de facto selected as BAT, and conclusions for both processes are presented in this document in parallel.

When concluding on BAT for the production of titanium dioxide, the following key environmental issues have been identified for the sector:

- the environmental impact outside of the EU due to the upgrading of titanium ores prior to the production of titanium dioxide
- precautions regarding chlorine inventory in the chloride process route
- measures adopted to utilise spent post-hydrolytic sulphuric acid in the sulphate process route
- substantial energy use involved in both routes, in particular in the sulphate process.



Different feedstocks, within a range of 44 – 96 % TiO<sub>2</sub> content, are used for the production of titanium dioxide. For the chloride process, natural TiO<sub>2</sub> ores or synthetic TiO<sub>2</sub> feedstocks are selected, while for the sulphate process, titanium slag and ilmenite can be chosen and used either separately or in blends. Therefore, the principal BAT conclusion for the TiO<sub>2</sub> industry, in both the chloride and sulphate process, relate to cost-effective choice of feedstock, based on, e.g. LCA considerations, with a low as practical level of harmful impurities, in order to reduce consumption of raw materials and energy, to reduce waste generation, and to provide the lowest environmental burden at the TiO<sub>2</sub> plant site.

The application of this principal BAT is connected with environmental impacts upstream of the TiO<sub>2</sub> plant site (ore mining and upgrading), therefore, an integrated approach and good industrial practice should be applied in each case of TiO<sub>2</sub> feedstock selection, in order to achieve a high general level of protection of the environment as a whole.

The reported consumption and emission figures are given in terms of 1 tonne of TiO<sub>2</sub> pigment, but as the TiO<sub>2</sub> content in the produced pigments varies and no data per 1 tonne of 100 % pure TiO<sub>2</sub> are available, it is difficult to draw quantitative BAT conclusions on the production of titanium dioxide. However, two quantitative BAT conclusions on the consumption of energy in both process routes have been drawn, as quoted below.

#### Chloride process, BAT 13

Improve the overall energy efficiency in the chloride process to the range of 17 – 25 GJ/t TiO<sub>2</sub> pigment (for plants operated at full capacity level), noting that the finishing section consumes majority of the total energy (in the range of 10 – 15 GJ/t TiO<sub>2</sub> pigment), the energy use being highly dependent on the characteristics of the final product. An increase of energy required in the wet treatment and finishing operations is foreseen if customer specifications call for a finer particle size in the final pigment product.

#### Sulphate process, BAT 17

Improve the overall energy efficiency in the sulphate process (for plants operated at full capacity level) to the range of 23 – 41 GJ/t TiO<sub>2</sub> pigment, and from this:

- 1) 23 – 29 GJ/t TiO<sub>2</sub> pigment in the process with sulphuric acid neutralisation
- 2) 33 – 41 GJ/t TiO<sub>2</sub> pigment in the process with sulphuric acid re-concentration.

Given different combinations of systems used across the EU TiO<sub>2</sub> industry for acid neutralisation and/or acid reconcentration, the extreme ranges as in 1) and 2) above apply only as indicative levels for the estimation of the overall energy efficiency in the TiO<sub>2</sub> plant in question.

Note also that the finishing section consumes a large share of the total energy (in the range of 10 – 15 GJ/t TiO<sub>2</sub> pigment), the energy use being highly dependent on the characteristics of the final product. An increase of energy required in the finishing operations is foreseen if customer specifications call for finer particle size in the final pigment product. Increased sulphate removal from liquid effluent streams requires higher energy usage.

Finally, the reader should note that for both process routes, BAT AELs to air and water, in particular the BAT AELs relevant to the emissions of heavy metals to water, have been drawn in this document.

### **Chapter 4 – Carbon black**

About 65 % of the world's consumption of carbon black is used in the production of tyres and tyre products for automobiles and other vehicles. Roughly 30 % goes into other rubber products, with the remainder being used in plastics, printing ink, paint, paper and miscellaneous applications.

## Executive Summary

Today, the global installed capacity is approximately eight million tonnes per year, with a worldwide demand for carbon black in the order of six million tonnes per year. This quantity is produced by more than 150 carbon black plants situated in 35 countries, of that 1.7 million tonnes per year in 22 plants situated in 12 Member States of the EU-25.

Mixtures of gaseous or liquid hydrocarbons represent the raw materials preferable for the industrial production of carbon black. Since aliphatic hydrocarbons give lower yields than aromatic hydrocarbons, the latter are primarily used.

The sulphur content in the carbon black feedstock is of key importance for the assessment of the environmental impact of the European carbon black plants.

The most important process today is the furnace black process. It accounts for more than 95 % of the total worldwide carbon black production. Nearly all rubber grades and a significant part of pigment-grade carbon blacks are now manufactured by the furnace black process. It is a continuous process, and its advantages are its great flexibility and its better economy compared to other processes. The typical production rate is approximately 2000 kg/h for a modern furnace black reactor.

When concluding on BAT for the carbon black industry, the following key environmental issues have been taken into consideration:

- dependence of the European carbon black industry on the availability of petrochemical and carbochemical feedstocks with a high carbon to hydrogen ratio and high aromatic content, which result in the highest yields and reduced impact on the environment
- the sulphur content in the feedstock used in the production of carbon black and its influence on the emissions of SO<sub>x</sub> to air
- the modern furnace process used in the European carbon black industry which allows high plant throughput, the most characteristic environmental features of this process being high energy intensity, and the emissions of NO<sub>x</sub>, SO<sub>x</sub> and dust to air
- process-integrated measures, including primary NO<sub>x</sub> and SO<sub>x</sub> reduction, and tail-gas combustion with energy recovery, followed by possible end-of-pipe measures with the aim to reduce the emissions of NO<sub>x</sub>, SO<sub>x</sub> and dust to air, in order to lessen the impact of the production of carbon black in the EU-25 on the environment.

Several distinct BAT conclusions have been drawn for carbon black plants in the EU-25 based on the furnace process, including the usage of low sulphur feedstock, the carbon black content in the filtered tail-gas, flaring, NO<sub>x</sub> emissions, and dust emissions.

Of these, the most illustrative is the sequence of actions in concluding on BAT for sulphur content in the carbon black feedstock, to finally come to the following BAT conclusion:

### BAT 1

Use low sulphur feedstock: The use of low sulphur primary feedstock with a sulphur content in the range of 0.5 – 1.5 % as a yearly average. The corresponding specific emission level associated with BAT is 10 – 50 kg SO<sub>x</sub> (as SO<sub>2</sub>) per tonne of rubber-grade carbon black produced, as a yearly average. These levels are achieved assuming that the secondary feedstock is natural gas. Other liquid or gaseous hydrocarbons can be used as well.

In the production of speciality grade carbon black (high surface pigment blacks), higher emission levels are expected.

## **Chapter 5 – Synthetic amorphous silica**

Synthetic amorphous silica is produced either by the thermal process (a high temperature hydrolysis of chlorosilanes – pyrogenic silica) or by the wet process (precipitation of a water glass solution with acids – precipitated silica and silica gel) and is used in a wide range of applications, such as synthetic resins, plastics, rubbers, cosmetics, nutritional products and drugs, fillers or anti-caking agents.

When concluding on BAT for the synthetic amorphous silica industry, the following key environmental issues have been taken into consideration:

- for the production of synthetic amorphous pyrogenic silica, the key environmental issue is to reduce the chlorine emission by applying process-integrated measures (hydrogen injection, methane and hydrogen injection, incineration), followed by the removal of hydrogen chloride from the off-gas and, finally, by using the end-of-pipe technique of scrubbing residual chlorine from the off-gas and treatment of the resulting sodium hypochlorite stream either with hydrogen peroxide or by catalytic conversion to obtain sodium chloride
- for the production of synthetic amorphous precipitated silica and silica gel, the most important environmental issue is proper selection and integration of liquid/solid separation and silica drying techniques in order to save energy and reduce the associated emissions of CO<sub>2</sub>, SO<sub>x</sub> and NO<sub>x</sub> to air.

## Chapter 6 – Inorganic phosphates

This document covers the production of three groups of inorganic phosphates:

- detergent phosphates, in particular sodium tripolyphosphate (STPP)
- food phosphates (human food or pharmaceutical ingredients), in particular sodium tripolyphosphate (STPP)
- feed phosphates (animal feed supplements), in particular dicalcium phosphate (DCP).

When concluding on BAT for the inorganic phosphates industry sector, the following key environmental issues have been taken into consideration:

- inorganic phosphates are derived from phosphate rock and, depending on the quality of the rock and the pretreatment (purification) of the intermediate phosphoric acid used, the impact on the environment varies, with the cross-media effects also varying to a large degree. Detailed comparisons are difficult as the data on the purification of non-fertiliser grade wet phosphoric acid are very limited (this process stage is situated outside of the scope of this document)
- for detergent-grade STPP, based on the ‘green’ phosphoric acid route, two main environmental process-related issues can be identified: in the wet stage of the process – the cakes of gypsum and other impurities originating from the raw materials used, and in the dry stage of the process – emissions of fluorine, P<sub>2</sub>O<sub>5</sub> droplets and STPP dust are produced
- for food and detergent-grade STPP, based on the purified non-fertiliser grade wet phosphoric acid, the main environmental impact is located upstream in the wet stage of acid purification. In the dry stage of the STPP process, the main issues are again the emissions of fluorine, P<sub>2</sub>O<sub>5</sub> droplets and dust
- for feed-grade DCP, in the phosphoric acid route, based on the purified non-fertiliser grade wet phosphoric acid, the main environmental impact is located upstream in the wet stage of acid purification. In the dry stage of the DCP process, the key issues are the emissions of dust to air and phosphorus to water. In turn, in the hydrochloric acid route, the key issues are the emissions of dust and HCl to air, phosphorus to water, and solids waste to land.

## Chapter 7 – ‘Selected illustrative’ LVIC-S products

Chapter 7 covers in total 17 ‘selected illustrative’ LVIC-S products, addressed in this document at a lesser level of detail than the ‘cornerstone’ LVIC-S products.

Given the limitations of the text in the Executive Summary, and the size of Chapter 7, which exceeds 240 pages, it is impossible to even briefly comment on all the process routes applied in the production of ‘selected illustrative’ LVIC-S products, the ‘Techniques to consider in the determination of BAT’ analysed, and the detailed BAT conclusions drawn in this chapter.

However, it should be noted that, when concluding on BAT for the ‘selected illustrative’ products, a total of 126 Best Available Techniques were identified.

An attempt had been made to look for the commonalities in the BAT proposals for these 17 LVIC-S products, but apart from some similarities regarding abatement techniques for dust collection, no other common BAT conclusions in this group were drawn.

### **Chapter 8 – Common abatement measures applied in the LVIC-S industry**

Following IPPC Directive Annex IV considerations, which need to be taken into account when determining BAT, Chapter 8 gives information on the sources of emissions to air, techniques available for reducing emissions to air, as well as on the emissions to water and emissions of solid waste in the LVIC-S industry. The description of the environmental management tools and, finally, the conclusion on Best Available Technique for the environmental management follows. Closely related to Chapter 8 is Annex 3, ‘good environmental practices (GEP) for the use of technology, plant design, maintenance, operation, environmental protection, and decommissioning in the LVIC-S industry’.

### **Chapter 9 – Emerging Techniques in the LVIC-S industry**

The review of techniques currently available in the LVIC-S industry indicates that there is little information on emerging techniques. Innovations and emerging techniques defined in this document are relevant to the production of soda ash, titanium dioxide, carbon black, and silicon carbide.

### **Chapter 10 – Concluding Remarks**

The Concluding Remarks chapter contains background information on the kick-off meeting on LVIC-S, the milestones in developing this document, and the degree of consensus reached on BAT proposals for the process Chapters 2 through to 7, and on generic BAT proposals for the LVIC-S industry. Recommendations for further research and information gathering on LVIC-S are given and, finally, recommendations for updating this document.

The EC is launching and supporting, through its RTD programmes, a series of projects dealing with clean technologies and management strategies. Potentially these projects could provide a useful contribution to future BREF reviews. Readers are therefore invited to inform the EIPPCB of any research results which are relevant to the scope of this document (see also the preface of this document).

---

## PREFACE

### 1. Status of this document

Unless otherwise stated, references to “the Directive” in this document means the Council Directive 96/61/EC on integrated pollution prevention and control. As the Directive applies without prejudice to Community provisions on health and safety at the workplace, so does this document.

This document forms part of a series presenting the results of an exchange of information between EU Member States and industries concerned on best available technique (BAT), associated monitoring, and developments in them. It is published by the European Commission pursuant to Article 16(2) of the Directive, and must therefore be taken into account in accordance with Annex IV of the Directive when determining “best available techniques”.

### 2. Relevant legal obligations of the IPPC Directive and the definition of BAT

In order to help the reader understand the legal context in which this document has been drafted, some of the most relevant provisions of the IPPC Directive, including the definition of the term ‘best available techniques’, are described in this preface. This description is inevitably incomplete and is given for information only. It has no legal value and does not in any way alter or prejudice the actual provisions of the Directive.

The purpose of the Directive is to achieve integrated prevention and control of pollution arising from the activities listed in its Annex I, leading to a high level of protection of the environment as a whole. The legal basis of the Directive relates to environmental protection. Its implementation should also take account of other Community objectives such as the competitiveness of the Community’s industry thereby contributing to sustainable development.

More specifically, it provides for a permitting system for certain categories of industrial installations requiring both operators and regulators to take an integrated, overall look at the polluting and consuming potential of the installation. The overall aim of such an integrated approach must be to improve the management and control of industrial processes so as to ensure a high level of protection for the environment as a whole. Central to this approach is the general principle given in Article 3 that operators should take all appropriate preventative measures against pollution, in particular through the application of best available techniques enabling them to improve their environmental performance.

The term ‘best available techniques’ is defined in Article 2(11) of the Directive as ‘the most effective and advanced stage in the development of activities and their methods of operation which indicate the practical suitability of particular techniques for providing in principle the basis for emission limit values designed to prevent and, where that is not practicable, generally to reduce emissions and the impact on the environment as a whole’. Article 2(11) goes on to clarify further this definition as follows:

‘techniques’ includes both the technology used and the way in which the installation is designed, built, maintained, operated and decommissioned;

‘available’ techniques are those developed on a scale which allows implementation in the relevant industrial sector, under economically and technically viable conditions, taking into consideration the costs and advantages, whether or not the techniques are used or produced inside the Member State in question, as long as they are reasonably accessible to the operator;

‘best’ means most effective in achieving a high general level of protection of the environment as a whole.

Furthermore, Annex IV of the Directive contains a list of ‘considerations to be taken into account generally or in specific cases when determining best available techniques bearing in mind the likely costs and benefits of a measure and the principles of precaution and prevention’. These considerations include the information published by the Commission pursuant to Article 16(2).

Competent authorities responsible for issuing permits are required to take account of the general principles set out in Article 3 when determining the conditions of the permit. These conditions must include emission limit values, supplemented or replaced where appropriate by equivalent parameters or technical measures. According to Article 9(4) of the Directive, these emission limit values, equivalent parameters and technical measures must, without prejudice to compliance with environmental quality standards, be based on the best available techniques, without prescribing the use of any technique or specific technology, but taking into account the technical characteristics of the installation concerned, its geographical location and the local environmental conditions. In all circumstances, the conditions of the permit must include provisions on the minimisation of long-distance or transboundary pollution and must ensure a high level of protection for the environment as a whole.

Member States have the obligation, according to Article 11 of the Directive, to ensure that competent authorities follow or are informed of developments in best available techniques.

### 3. Objective of this document

Article 16(2) of the Directive requires the Commission to organise ‘an exchange of information between Member States and the industries concerned on best available techniques, associated monitoring and developments in them’, and to publish the results of the exchange.

The purpose of the information exchange is given in recital 25 of the Directive, which states that ‘the development and exchange of information at Community level about best available techniques will help to redress the technological imbalances in the Community, will promote the worldwide dissemination of limit values and techniques used in the Community and will help the Member States in the efficient implementation of this Directive.’

The Commission (Environment DG) established an information exchange forum (IEF) to assist the work under Article 16(2) and a number of technical working groups have been established under the umbrella of the IEF. Both IEF and the technical working groups include representation from Member States and industry as required in Article 16(2).

The aim of this series of documents is to reflect accurately the exchange of information which has taken place as required by Article 16(2) and to provide reference information for the permitting authority to take into account when determining permit conditions. By providing relevant information concerning best available techniques, these documents should act as valuable tools to drive environmental performance.

### 4. Information sources

This document represents a summary of information collected from a number of sources, including in particular the expertise of the groups established to assist the Commission in its work, and verified by the Commission services. All contributions are gratefully acknowledged.

### 5. How to understand and use this document

The information provided in this document is intended to be used as an input to the determination of BAT in specific cases. When determining BAT and setting BAT-based permit conditions, account should always be taken of the overall goal to achieve a high level of protection for the environment as a whole.

The rest of the Preface describes the type of information that is provided in each section of the document.

As outlined in the Scope section, this document is structured in a different way compared to a standard BREF. After Chapter 1, which provides general information on the industrial sector concerned and on the industrial processes used within the sector, it contains five LVIC-S cornerstone chapters: Chapter 2 – Soda ash, Chapter 3 – Titanium dioxide (covering two different titanium dioxide process routes: chloride and sulphate), Chapter 4 - Carbon black, Chapter 5 - Synthetic amorphous silica, and Chapter 6 – Detergent, food and feed phosphates. Chapter 7 contains information on 17 selected illustrative LVIC-S. Within Chapters 2 through 7, standard BREF sections are built, as follows.

- Sections 1 and 2 of each chapter provide general information on the industrial sector concerned and on the industrial processes used within the sector.
- Section 3 provides data and information concerning present consumption and emission levels reflecting the situation in existing installations at the time of writing.
- Section 4 of each chapter describes in more detail the emission reduction and other techniques that are considered to be most relevant for determining BAT and BAT-based permit conditions. This information includes the consumption and emission levels considered achievable by using the technique, some idea of the costs and the cross-media issues associated with the technique, and the extent to which the technique is applicable to the range of installations requiring IPPC permits, for example new, existing, large or small installations. Techniques that are generally seen as obsolete are not included.
- Section 5 of each chapter presents the techniques and the consumption and emission levels that are considered to be compatible with BAT in a general sense. The purpose is thus to provide general indications regarding the consumption and emission levels that can be considered as an appropriate reference point to assist in the determination of BAT-based permit conditions or for the establishment of general binding rules under Article 9(8). It should be stressed, however, that this document does not propose emission limit values. The determination of appropriate permit conditions will involve taking account of local, site-specific factors such as the technical characteristics of the installation concerned, its geographical location and the local environmental conditions. In the case of existing installations, the economic and technical viability of upgrading them also needs to be taken into account. Even the single objective of ensuring a high level of protection for the environment as a whole will often involve making trade-off judgements between different types of environmental impact, and these judgements will often be influenced by local considerations.

Although an attempt is made to address some of these issues, it is not possible for them to be considered fully in this document. The techniques and levels presented in Section 5 of each chapter will therefore not necessarily be appropriate for all installations. On the other hand, the obligation to ensure a high level of environmental protection including the minimisation of long-distance or transboundary pollution implies that permit conditions cannot be set on the basis of purely local considerations. It is therefore of the utmost importance that the information contained in this document is fully taken into account by permitting authorities.

Since the best available techniques change over time, this document will be reviewed and updated as appropriate. All comments and suggestions should be made to the European IPPC Bureau at the Institute for Prospective Technological Studies at the following address:

European Commission  
Institute for Prospective Technological Studies, Edificio Expo  
C/ Inca Garcilaso s/n  
E-41092 Seville, Spain

Telephone: +34 95 4488 284  
Fax: +34 95 4488 426  
e-mail: [JRC-IPTS-EIPPCB@ec.europa.eu](mailto:JRC-IPTS-EIPPCB@ec.europa.eu)  
Internet: <http://eippcb.jrc.es>

---

# Best Available Techniques Reference Document on Large Volume Inorganic Chemicals – Solids and Others (LVIC-S) Industry

<b>EXECUTIVE SUMMARY</b> .....	<b>I</b>
<b>PREFACE</b> .....	<b>XI</b>
<b>SCOPE</b> .....	<b>XLI</b>
<b>1 GENERAL INFORMATION ON LARGE VOLUME INORGANIC CHEMICALS – SOLID AND OTHERS (LVIC-S) INDUSTRY</b> .....	<b>1</b>
1.1 Overview of the European LVIC-S industry .....	1
1.1.1 The European chemical industry sector .....	1
1.1.1.1 Profile of the chemical industry .....	1
1.1.1.2 International trade .....	4
1.1.1.3 Growth of the chemical industry .....	4
1.1.1.4 Costs and prices .....	6
1.1.1.5 Energy .....	6
1.1.1.6 Employment .....	7
1.1.1.7 Investment and R&D .....	7
1.1.1.8 Sustainable development .....	8
1.1.2 Inorganic compounds .....	10
1.1.3 Characteristics of the LVIC-S industry .....	10
1.1.4 Cornerstone and selected illustrative products in the scope of this document .....	14
1.1.4.1 Main affiliations between compounds within the LVIC-S industry .....	15
1.1.4.2 Main uses .....	15
1.1.4.3 Economic aspects .....	15
1.1.5 Production scale in the European LVIC-S industry .....	16
1.1.5.1 Soda ash .....	16
1.1.5.2 Titanium dioxide .....	16
1.1.5.3 Carbon black .....	17
1.1.5.4 Synthetic amorphous silica .....	17
1.1.5.5 Inorganic phosphates .....	17
1.1.5.5.1 Detergent phosphates .....	17
1.1.5.6 Production potential of the LVIC-S industry in the EU-25 .....	17
1.1.5.7 Distribution of the LVIC-S plants in the EU-25 .....	18
1.2 Key LVIC-S production processes .....	20
1.2.1 Soda ash with refined sodium bicarbonate .....	20
1.2.2 Titanium dioxide .....	20
1.2.2.1 The sulphate process .....	20
1.2.2.2 The chloride process .....	20
1.2.2.3 Wet treatment (coating) .....	20
1.2.3 Carbon black .....	20
1.2.3.1 Post-treatment .....	21
1.2.4 Synthetic amorphous silica .....	21
1.2.4.1 Synthetic amorphous pyrogenic silica .....	21
1.2.4.2 Synthetic amorphous precipitated silica .....	21
1.2.4.3 Silica gel .....	21
1.2.5 Inorganic detergent, food and feed phosphates .....	21
1.2.5.1 Detergent and food phosphates – sodium tripolyphosphate .....	21
1.2.5.2 Feed phosphates – dicalcium phosphate .....	22
1.3 Overview of environmental issues in the LVIC-S industry .....	22
1.3.1 Main raw materials .....	22
1.3.2 Secondary feedstock and energy .....	23
1.3.3 Use of water .....	23
1.3.4 Emissions to air .....	23
1.3.5 Emissions to water .....	24
1.3.6 By-products and solid wastes .....	24
1.4 Unit processes and infrastructure in the LVIC-S industry .....	25
1.4.1 Unit processes and unit operations in the LVIC-S industry .....	25
1.4.2 Characteristics of a typical LVIC-S production plant .....	26



1.4.3	Infrastructure at a LVIC-S production site .....	26
1.4.3.1	Energy supply .....	26
1.4.3.2	Cooling .....	27
1.4.3.3	Refrigeration .....	28
1.4.3.4	Storage and handling .....	28
1.4.3.5	Vacuum .....	28
1.4.3.6	Utility fluids .....	28
1.5	Best Available Techniques for the LVIC-S industry .....	29
<b>2</b>	<b>SODA ASH .....</b>	<b>31</b>
2.1	General information .....	31
2.1.1	Introduction .....	31
2.1.2	Overview about the type of production .....	33
2.1.2.1	Solvay process .....	33
2.1.2.2	Trona and nahcolite based process .....	34
2.1.2.2.1	Trona .....	34
2.1.2.2.2	Nahcolite .....	34
2.1.2.3	Nepheline syenite process .....	35
2.1.2.4	Carbonation of caustic soda .....	35
2.1.2.5	Soda ash as a by-product from the production of caprolactam .....	35
2.1.3	Uses in industrial sectors .....	35
2.1.4	Production capacity in the world and in Europe .....	36
2.1.4.1	Worldwide .....	36
2.1.4.2	European Union .....	37
2.1.5	Socio-economic aspects .....	39
2.1.5.1	Social integration – employment .....	39
2.1.5.2	Capital intensity in the EU soda ash industry .....	39
2.1.5.3	General economic standing .....	39
2.1.5.4	Environmental taxes and levies .....	39
2.1.5.5	Manufacturing and operating cost .....	40
2.2	Applied processes and techniques .....	41
2.2.1	The Solvay process .....	41
2.2.1.1	Main chemical reactions .....	41
2.2.1.2	Process steps .....	42
2.2.1.2.1	Brine purification .....	43
2.2.1.2.2	Lime kilns and milk of lime production .....	43
2.2.1.2.3	Absorption of ammonia .....	44
2.2.1.2.4	Precipitation of sodium bicarbonate .....	44
2.2.1.2.5	Separation of sodium bicarbonate from the mother liquor .....	44
2.2.1.2.6	Sodium bicarbonate calcination .....	45
2.2.1.2.7	Ammonia recovery .....	45
2.2.1.3	Product storage and handling .....	46
2.2.2	Raw materials .....	46
2.2.2.1	Brine .....	46
2.2.2.1.1	Typical brine composition .....	47
2.2.2.2	Limestone .....	47
2.2.2.2.1	Typical limestone composition .....	48
2.2.2.3	Carbon for limestone burning in the lime kiln .....	49
2.2.2.3.1	Typical coke composition .....	49
2.2.2.4	Ammonia .....	49
2.2.2.4.1	Ammonia characteristics .....	49
2.2.2.4.2	Ammonia storage .....	49
2.2.2.5	Miscellaneous additives .....	50
2.2.3	Main output streams .....	50
2.2.4	Options for process optimisation and improvement .....	50
2.2.4.1	Purity of raw materials .....	50
2.2.4.1.1	Heavy metals in raw materials used for the production of soda ash .....	51
2.2.4.2	Raw materials consumption .....	52
2.2.4.3	Energy .....	52
2.3	Present consumption and emission levels .....	53
2.3.1	Raw materials .....	54
2.3.2	Utilities .....	54
2.3.2.1	Steam .....	54

2.3.2.2	Process water.....	55
2.3.2.3	Cooling waters .....	55
2.3.2.4	Electricity .....	55
2.3.3	Emissions to air.....	56
2.3.3.1	Particulate dust.....	56
2.3.3.2	Carbon dioxide and monoxide .....	57
2.3.3.3	Nitrogen oxides.....	57
2.3.3.4	Sulphur oxides.....	57
2.3.3.5	Ammonia.....	58
2.3.3.6	Hydrogen sulphide .....	58
2.3.4	Emissions to water .....	59
2.3.4.1	Waste water from distillation .....	59
2.3.4.1.1	Suspended solids and heavy metals discharged with waste waters .....	60
2.3.4.1.2	Waste water emissions from example plants.....	61
2.3.4.2	Waste water from brine purification .....	63
2.3.5	Solid wastes .....	63
2.3.5.1	Fines of limestone .....	63
2.3.5.2	Non-recycled stone grits at the slaker .....	63
2.3.6	Co-products.....	64
2.3.6.1	Calcium chloride.....	64
2.3.6.2	Refined sodium bicarbonate.....	64
2.3.6.2.1	Background information.....	64
2.3.6.2.2	Process description.....	65
2.3.6.2.3	Major environmental impact .....	66
2.3.7	Energy management in the production of soda ash.....	67
2.3.7.1	Energy conversion of primary fuels .....	67
2.3.7.2	Energy saving in the process.....	68
2.3.7.2.1	Heat recovery .....	68
2.3.7.2.2	Energy minimisation .....	68
2.3.8	Management of air emissions.....	69
2.3.8.1	Calcination of limestone.....	69
2.3.8.1.1	Quantity of lime kiln gas produced .....	69
2.3.8.1.2	Composition of lime kiln gas .....	70
2.3.8.2	Precipitation of crude sodium bicarbonate.....	71
2.3.8.3	Filtration of the bicarbonate .....	72
2.3.8.4	Production of dense soda ash .....	72
2.3.8.5	Conveying and storage of light and dense soda ash .....	72
2.3.9	Measures applied for the reduction of emissions to water .....	72
2.3.9.1	Ammonia.....	73
2.3.9.2	Suspended solids.....	74
2.3.10	Management of emissions to water .....	74
2.3.10.1	Total dispersion.....	75
2.3.10.1.1	Marine outfalls .....	75
2.3.10.1.2	Lake and river discharge .....	75
2.3.10.2	Deposition/dispersion.....	76
2.3.10.2.1	Settling ponds.....	76
2.3.10.2.2	Underground disposal.....	76
2.3.10.3	Liquid effluent discharge options.....	76
2.3.10.3.1	Equalisation in modulation basins.....	76
2.3.10.3.2	Adjustment of pH.....	77
2.3.10.4	By-products recovery and re-use.....	77
2.3.10.4.1	Dissolved CaCl <sub>2</sub> in distillation waste water .....	77
2.3.10.4.2	Suspended solids in distillation waste water .....	77
2.3.10.4.3	Product from brine purification.....	78
2.3.11	Solid materials management .....	78
2.3.11.1	Limestone fines .....	78
2.3.11.2	Large lumps of unburnt limestone.....	78
2.4	Techniques to consider in the determination of BAT.....	79
2.4.1	Integrated design and operation of soda ash plants .....	80
2.4.2	Energy conversion of primary fuels .....	81
2.4.3	Optimisation of the soda ash process to avoid excessive CO <sub>2</sub> emissions.....	82
2.4.4	Vertical shaft kiln for the production of concentrated CO <sub>2</sub> gas and reactive lime .....	84
2.4.5	Centrifugation of crude sodium bicarbonate – energy saving.....	85

2.4.6	Ammonia recovery in the distillation section .....	87
2.4.7	Management of waste waters from the production of soda ash .....	88
2.4.7.1	Selection of appropriate quality limestone, salt brine and coke .....	90
2.4.7.2	Total dispersion of waste waters – via an extended marine outfall .....	91
2.4.7.3	Removal of coarse solids from waste waters – particularly for lake and river discharge .....	93
2.4.7.4	Deposition/dispersion – settling ponds .....	95
2.4.7.5	Deposition/dispersion – underground disposal .....	97
2.5	Best Available Techniques for the production of soda ash by the Solvay process .....	99
<b>3</b>	<b>TITANIUM DIOXIDE .....</b>	<b>103</b>
3.1	General information .....	103
3.1.1	Introduction .....	103
3.1.2	General description of the European titanium dioxide industry .....	104
3.1.3	History of markets .....	105
3.1.4	Producer companies .....	106
3.2	Titanium dioxide – the chloride process .....	108
3.2.1	Introduction .....	108
3.2.2	Applied processes and techniques – the chloride process .....	108
3.2.2.1	Raw material import and preparation .....	108
3.2.2.2	Chlorination .....	110
3.2.2.3	Solids separation .....	110
3.2.2.4	Waste solid metal chlorides treatment .....	111
3.2.2.5	Condensation .....	111
3.2.2.6	Waste gas treatment .....	111
3.2.2.7	Distillation .....	111
3.2.2.8	Vanadium oxychloride removal .....	111
3.2.2.9	Oxidation .....	111
3.2.2.10	Cooling and separation .....	112
3.2.2.11	Absorption/desorption process .....	112
3.2.2.12	Direct chlorine recycling process .....	112
3.2.2.13	Finishing .....	112
3.2.2.14	Abatement systems for gases .....	112
3.2.2.15	Abatement systems for solids .....	113
3.2.2.16	Abatement systems for liquids .....	113
3.2.2.17	Co-products for sale or re-use .....	114
3.2.2.18	Purified titanium tetrachloride for sale .....	114
3.2.3	Present consumption and emission levels – the chloride process .....	114
3.2.3.1	Current environmental performance .....	114
3.2.3.2	Raw materials consumption .....	114
3.2.3.2.1	Chlorination .....	114
3.2.3.2.2	Solids separation and waste solid metal chlorides treatment .....	115
3.2.3.2.3	TiCl <sub>4</sub> purification .....	116
3.2.3.2.4	Oxidation .....	116
3.2.3.2.5	Cooling and separation .....	116
3.2.3.2.6	Finishing .....	116
3.2.3.2.7	Abatement systems for gases .....	116
3.2.3.2.8	Abatement systems for liquids .....	117
3.2.3.3	Utilities consumption – energy and water .....	117
3.2.3.3.1	Energy .....	117
3.2.3.3.2	Water .....	118
3.2.3.4	Emissions to air .....	118
3.2.3.4.1	Raw material import and preparation .....	118
3.2.3.4.2	Chlorination .....	119
3.2.3.4.3	Solids separation .....	119
3.2.3.4.4	Waste solid metal chlorides treatment .....	120
3.2.3.4.5	Condensation .....	120
3.2.3.4.6	Waste gas treatment .....	120
3.2.3.4.7	Oxidation .....	120
3.2.3.4.8	Finishing .....	120
3.2.3.4.9	Abatement systems for gases .....	121
3.2.3.5	Emissions to water .....	121
3.2.3.5.1	Waste solid metal chlorides treatment .....	121

3.2.3.5.2	Condensation and gas scrubbing .....	122
3.2.3.5.3	Finishing .....	122
3.2.3.5.4	Abatement systems for gases .....	122
3.2.3.5.5	Abatement systems for liquids .....	123
3.2.3.6	Solid wastes .....	123
3.2.3.6.1	Chlorination .....	123
3.2.3.6.2	Waste solid metal chlorides treatment .....	123
3.2.3.6.3	Distillation and vanadium oxychloride removal .....	123
3.2.3.7	Environmental performance – Greatham Works 2002 .....	123
3.2.4	Techniques to consider in the determination of BAT – the chloride process .....	126
3.2.4.1	Raw material import and preparation .....	127
3.2.4.1.1	Dry titanium dioxide ore .....	127
3.2.4.1.2	TiO <sub>2</sub> ore dedusting systems .....	127
3.2.4.1.3	Low sulphur content in feedstock granular coke .....	128
3.2.4.1.4	Low chlorine inventory .....	129
3.2.4.2	Chlorination .....	130
3.2.4.3	Solids separation – coke and ferrous chloride recovery .....	131
3.2.4.4	Waste solid metal chlorides neutralisation with chalk or lime .....	132
3.2.4.5	TiCl <sub>4</sub> condensation and waste gas treatment .....	133
3.2.4.6	Purification of raw TiCl <sub>4</sub> and vanadium oxychloride removal .....	134
3.2.4.7	Oxidation .....	135
3.2.4.8	Cooling and separation .....	136
3.2.4.9	Direct chlorine recycling process .....	137
3.2.4.10	Abatement systems for gases, solids and liquids .....	138
3.2.4.10.1	Abatement systems for gases .....	138
3.2.4.10.2	Abatement systems for solids .....	138
3.2.4.10.3	Abatement systems for liquids .....	138
3.2.4.11	Co-products for sale or re-use .....	139
3.2.4.12	Energy usage .....	140
3.3	Titanium dioxide – the sulphate process .....	142
3.3.1	Introduction .....	142
3.3.2	Applied processes and techniques – the sulphate process .....	142
3.3.2.1	Raw material import and preparation .....	142
3.3.2.2	Digestion .....	143
3.3.2.3	Reduction .....	144
3.3.2.4	Clarification and crystallisation .....	145
3.3.2.5	Hydrolysis (hydrate precipitation) .....	145
3.3.2.6	Filtration and washing .....	146
3.3.2.7	Calcination .....	146
3.3.2.8	Effluent treatment .....	146
3.3.2.9	Finishing section .....	147
3.3.2.9.1	Coating .....	147
3.3.2.9.2	Final processing .....	147
3.3.2.10	Abatement systems for aqueous emissions from the sulphate process .....	147
3.3.2.10.1	Acid recycling .....	148
3.3.2.10.2	Neutralisation .....	149
3.3.2.10.3	Waste water from post treatment .....	150
3.3.2.10.4	Cooling waters .....	150
3.3.2.10.5	Co-products .....	150
3.3.3	Present consumption and emission levels – the sulphate process .....	151
3.3.3.1	Raw materials consumption .....	151
3.3.3.1.1	Digestion .....	151
3.3.3.1.2	Reduction .....	152
3.3.3.1.3	Clarification and crystallisation .....	152
3.3.3.1.4	Hydrolysis, filtration and washing .....	152
3.3.3.1.5	Calcination .....	152
3.3.3.1.6	Effluent treatment .....	152
3.3.3.1.7	Finishing .....	152
3.3.3.1.8	Abatement systems for aqueous emissions from the sulphate process .....	152
3.3.3.1.9	Abatement systems for gaseous emissions from the sulphate process .....	153
3.3.3.2	Utilities consumption – energy and water .....	153
3.3.3.2.1	Energy .....	153
3.3.3.2.2	Water consumption .....	155

3.3.3.3	Emissions to air .....	156
3.3.3.3.1	Raw material import and preparation.....	156
3.3.3.3.2	Digestion.....	156
3.3.3.3.3	Reduction.....	157
3.3.3.3.4	Hydrolysis, filtration and washing.....	157
3.3.3.3.5	Calcination.....	157
3.3.3.3.6	Finishing.....	158
3.3.3.3.7	Abatement systems atmospheric emissions – the sulphate process .....	158
3.3.3.4	Emissions to water.....	158
3.3.3.4.1	Hydrolysis, filtration and washing.....	158
3.3.3.4.2	Finishing .....	159
3.3.3.5	Solid wastes.....	160
3.3.3.5.1	Clarification and crystallisation .....	160
3.3.3.5.2	Abatement systems for aqueous emissions from the sulphate process .....	160
3.3.3.6	Environmental performance – Grimsby Works 2002.....	161
3.3.4	Techniques to consider in the determination of BAT – the sulphate process.....	164
3.3.4.1	Raw material choice from import.....	165
3.3.4.2	Raw material preparation.....	167
3.3.4.3	Digestion of the ore .....	167
3.3.4.4	Reduction.....	169
3.3.4.5	Clarification and crystallisation .....	170
3.3.4.6	Hydrolysis (hydrate precipitation).....	171
3.3.4.7	Filtration and washing .....	172
3.3.4.8	Calcination.....	173
3.3.4.9	Finishing.....	174
3.3.4.10	Abatement systems for gaseous emissions – the sulphate process .....	175
3.3.4.10.1	Off-gas treatment from the digestion section.....	175
3.3.4.10.2	Gaseous effluent treatment from the calcination section .....	176
3.3.4.11	Abatement systems for aqueous emissions from the sulphate process .....	178
3.3.4.11.1	Waste acid recycling.....	180
3.3.4.11.2	Waste acid neutralisation .....	182
3.3.4.12	Co-products for sale or re-use.....	183
3.3.4.13	Energy usage.....	184
3.4	Comparison of the chloride and sulphate processes .....	186
3.4.1	Introduction .....	186
3.4.2	Direct comparison of the chloride and sulphate processes .....	186
3.4.2.1	Ore import.....	186
3.4.2.2	Feedstock processing – digestion and chlorination.....	187
3.4.2.3	Feedstock processing – impurity removal .....	187
3.4.2.4	Raw pigment production – calcination and oxidation.....	188
3.4.2.5	Raw pigment preparation for finishing.....	189
3.4.2.6	Finishing.....	189
3.4.2.7	Effluent treatment .....	189
3.4.2.8	Energy.....	189
3.4.2.9	Water .....	190
3.4.3	Direct comparison – abatement of a titanium dioxide plant .....	190
3.4.3.1	Sulphate process route .....	190
3.4.3.2	Chloride process route .....	190
3.4.4	Conclusions .....	190
3.4.5	Life Cycle Assessment in the titanium dioxide industry .....	191
3.5	Best Available Techniques for the production of titanium dioxide .....	197
3.5.1	The chloride process route.....	198
3.5.2	The sulphate process route .....	200
<b>4</b>	<b>CARBON BLACK .....</b>	<b>203</b>
4.1	General information.....	203
4.1.1	The carbon black industry .....	203
4.1.2	Applications of carbon black.....	205
4.2	Applied processes and techniques .....	206
4.2.1	Introduction .....	206
4.2.2	Raw materials .....	206
4.2.3	Production processes .....	208
4.2.3.1	Furnace black process.....	208

4.2.3.2	Channel black and gas black processes.....	212
4.2.3.3	Lamp black process.....	213
4.2.3.4	Thermal black process.....	214
4.2.3.5	Acetylene black process.....	214
4.2.3.6	Other manufacturing processes.....	215
4.2.4	Oxidative treatment of carbon black.....	215
4.2.5	Carbon black: physical and chemical properties.....	216
4.2.5.1	Physical properties.....	216
4.2.5.2	Chemical properties.....	216
4.3	Present consumption and emission levels – the furnace process.....	218
4.3.1	Introduction.....	218
4.3.2	Emissions to air.....	218
4.3.2.1	Possible emissions to air.....	218
4.3.2.2	Tail-gas venting.....	219
4.3.2.3	Emissions from dedicated tail-gas combustion devices.....	220
4.3.2.4	Emissions from the dryers of the wet pelletising unit.....	220
4.3.2.5	Filter system vents.....	220
4.3.2.6	Fugitive emissions.....	220
4.3.2.7	Summary of emissions to air.....	220
4.3.3	Emissions to water.....	221
4.3.3.1	Process related water streams.....	221
4.3.3.2	Non-process related water streams.....	221
4.3.3.3	Potential discharges.....	222
4.3.4	Solid Wastes.....	222
4.3.4.1	Hazardous wastes.....	222
4.3.4.2	Non-hazardous wastes.....	222
4.3.5	Energy consumption.....	223
4.4	Techniques to consider in the determination of BAT.....	225
4.4.1	Primary NO <sub>x</sub> reduction.....	226
4.4.2	Primary SO <sub>x</sub> reduction.....	230
4.4.3	Tail-gas combustion devices and energy recovery.....	234
4.4.4	Selective Non-Catalytic Reduction (SNCR).....	238
4.4.5	Selective Catalytic Reduction (SCR).....	243
4.4.6	Flue-gas desulphurisation (deSO <sub>x</sub> ).....	245
4.4.7	Dust removal/separation measures.....	247
4.5	Best Available Techniques for the production of carbon black.....	251
<b>5</b>	<b>SYNTHETIC AMORPHOUS SILICA.....</b>	<b>255</b>
5.1	General information.....	255
5.1.1	Introduction.....	255
5.1.2	Overview of the types of silica.....	255
5.1.3	Product identity.....	256
5.1.4	Physical and chemical properties.....	257
5.1.4.1	Physical properties.....	257
5.1.4.2	Chemical properties.....	258
5.1.5	Production amounts.....	258
5.1.6	Product applications.....	259
5.2	Applied processes and techniques.....	262
5.2.1	Synthetic amorphous pyrogenic silica.....	262
5.2.1.1	Basic principles of pyrogenic silica particle formation.....	262
5.2.1.2	Raw materials.....	262
5.2.1.3	Process description.....	263
5.2.2	Synthetic amorphous precipitated silica and silica gel.....	265
5.2.2.1	Raw materials.....	265
5.2.2.1.1	Water glass.....	265
5.2.2.1.2	Sulphuric acid.....	265
5.2.2.1.3	Raw material storage.....	265
5.2.2.2	Production process – precipitated silica.....	265
5.2.2.2.1	Precipitation process.....	266
5.2.2.2.2	Filtration process.....	267
5.2.2.2.3	Filter cake treatment.....	267
5.2.2.2.4	Drying process.....	267
5.2.2.2.5	Milling process.....	267

5.2.2.2.6	Granulation process .....	267
5.2.2.3	Production process – silica gel.....	267
5.2.2.3.1	Synthesis.....	268
5.2.2.3.2	Washing/ageing .....	269
5.2.2.3.3	Drying.....	269
5.2.2.3.4	Post-drying.....	269
5.2.2.3.5	Storage .....	269
5.2.2.4	Key process parameters – synthetic amorphous precipitated silica and silica gel.....	269
5.2.2.4.1	Wet stage process.....	269
5.2.2.4.2	Dry stage process .....	270
5.2.3	Handling and transportation of synthetic amorphous silica.....	272
5.2.4	Process and product trends .....	272
5.3	Present consumption and emission levels.....	273
5.3.1	Synthetic amorphous pyrogenic silica.....	273
5.3.1.1	Consumption of raw materials and energy .....	273
5.3.1.1.1	Raw materials .....	273
5.3.1.1.2	Consumption of energy.....	273
5.3.1.2	Emission levels.....	273
5.3.1.2.1	Emissions to air.....	273
5.3.1.2.2	Emissions to water.....	274
5.3.1.2.3	Solid Wastes .....	274
5.3.1.3	Environmental aspects .....	274
5.3.1.3.1	Recovery of waste and energy .....	274
5.3.2	Synthetic amorphous precipitated silica and silica gel .....	274
5.3.2.1	Consumption of raw materials and energy .....	274
5.3.2.1.1	Raw materials and water inputs .....	275
5.3.2.1.2	Consumption of energy.....	275
5.3.2.1.3	Solid wastes .....	275
5.3.2.1.4	Emissions to water.....	275
5.3.2.2	Emission levels.....	276
5.3.2.2.1	Emissions to air.....	276
5.3.2.2.2	Emissions to water.....	277
5.3.2.3	Environmental aspects .....	277
5.4	Techniques to consider in the determination of BAT.....	278
5.4.1	Synthetic amorphous pyrogenic silica.....	279
5.4.1.1	Chlorine reduction using hydrogen injection.....	280
5.4.1.2	Chlorine reduction using methane and hydrogen injection.....	281
5.4.1.3	Chlorine reduction using incineration.....	282
5.4.1.4	Hydrogen chloride removal from the off-gas .....	283
5.4.1.5	Scrubbing chlorine from the off-gas and sodium hypochlorite treatment.....	285
5.4.2	Synthetic amorphous precipitated silica and silica gel .....	286
5.4.2.1	Sodium sulphate removal from the waste water .....	287
5.4.2.2	Drying precipitated silica and silica gel.....	288
5.4.3	Dust removal/separation measures .....	290
5.5	Best Available Techniques for the production of synthetic amorphous silica .....	291
5.5.1	Synthetic amorphous pyrogenic silica.....	292
5.5.2	Synthetic amorphous precipitated silica and silica gel .....	293
<b>6</b>	<b>INORGANIC PHOSPHATES .....</b>	<b>295</b>
6.1	Introduction .....	295
6.2	Detergent phosphates.....	297
6.2.1	General information.....	297
6.2.1.1	Production of detergent phosphates (STPP).....	298
6.2.1.1.1	Production of STPP feedstock from non-purified green acid .....	299
6.2.1.1.2	Production of STPP feedstock from purified phosphoric acid.....	299
6.2.1.2	Comparison of the two process routes to produce STPP .....	299
6.2.2	Applied processes and techniques .....	300
6.2.2.1	General description of the STPP production process.....	300
6.2.2.2	Process route: from green acid to sodium orthophosphate solution.....	303
6.2.2.2.1	Pretreatment of the green acid .....	303
6.2.2.2.2	Neutralisation of the pretreated green acid .....	303
6.2.2.2.3	Concentration of the sodium orthophosphate solution.....	304
6.2.2.3	Process route: from purified acid to orthophosphate solution .....	304

6.2.2.3.1	Neutralisation of the purified acid.....	304
6.2.2.4	Process route: from orthophosphate solution to STPP .....	304
6.2.2.4.1	Calcination .....	304
6.2.2.4.2	Cooling and hydration .....	305
6.2.2.4.3	Milling and screening.....	306
6.2.3	Present consumption and emission levels .....	306
6.2.3.1	From green acid to orthophosphate solution .....	306
6.2.3.2	From purified acid to orthophosphate solution .....	307
6.2.3.3	From orthophosphate solution to STPP.....	307
6.2.3.4	Electricity consumption for the whole process – both routes.....	307
6.2.3.5	Consumptions and emissions: green acid to orthophosphate solution .....	308
6.2.3.6	Consumptions and emissions: purified acid to orthophosphate solution.....	308
6.2.3.7	Consumptions and emissions: orthophosphate solution to dry STPP .....	309
6.2.4	Techniques to consider in the determination of BAT .....	310
6.2.4.1	Green acid pretreatment, neutralisation and purification .....	311
6.2.4.2	Concentration of the sodium orthophosphate solution .....	312
6.2.4.3	Sodium tripolyphosphate calcination .....	314
6.2.4.4	Techniques available to control atmospheric emissions.....	315
6.3	Food phosphates.....	317
6.3.1	General information .....	317
6.3.2	Applied processes and techniques.....	318
6.3.3	Present consumption and emission levels .....	318
6.3.4	Techniques to consider in the determination of BAT .....	318
6.3.4.1	Raw material selection for the production of food phosphates .....	318
6.4	Feed phosphates .....	320
6.4.1	General information .....	320
6.4.1.1	Introduction.....	320
6.4.1.2	Phosphorus – a vital source of animal nutrition .....	320
6.4.1.3	Phosphate rock – the main downstream processes and products .....	321
6.4.2	Industrial processes.....	323
6.4.2.1	Phosphoric acid based processes.....	323
6.4.2.1.1	Dicalcium phosphate (DCP).....	323
6.4.2.1.2	Monocalcium phosphate (MCP).....	324
6.4.2.1.3	Monodicalcium phosphate (MDCP).....	325
6.4.2.1.4	Calcium-magnesium phosphate (CaMgP).....	325
6.4.2.1.5	Magnesium phosphate (MgP) .....	326
6.4.2.1.6	Sodium-calcium-magnesium phosphate (NaCaMgP) .....	327
6.4.2.1.7	Monosodium phosphate (MSP).....	327
6.4.2.1.8	Monoammonium phosphate (MAP).....	328
6.4.2.2	Hydrochloric acid based processes (dicalcium phosphate) .....	328
6.4.2.2.1	From phosphate rock.....	328
6.4.2.2.2	From bone phosphates (dicalcium phosphate) .....	329
6.4.3	Present consumption and emission values .....	330
6.4.3.1	Dicalcium phosphate – the phosphoric acid process route.....	330
6.4.3.2	Dicalcium phosphate – the hydrochloric acid process route .....	331
6.4.4	Techniques to consider in the determination of BAT .....	332
6.4.4.1	Dicalcium phosphate – the phosphoric acid process route.....	332
6.4.4.1.1	Recovery of spills from acid conditioning, reaction, and water re-use .....	332
6.4.4.1.2	Dedusting of air from drying operations .....	333
6.4.4.2	Dicalcium phosphate – the hydrochloric acid process route .....	333
6.4.4.2.1	Integrated production of dicalcium phosphate and potassium sulphate .....	333
6.4.4.2.2	Reduction of emissions to air – dust, odour and noise .....	334
6.4.4.2.3	Liquid effluent treatment.....	335
6.4.4.2.4	Separation of insoluble residue from phosphate rock.....	336
6.4.4.2.5	Solid effluents – sludge from waste water cleaning .....	337
6.5	Best Available Techniques for the production of inorganic phosphates .....	338
6.5.1	Detergent-grade STPP product, based on ‘green’ phosphoric acid.....	339
6.5.2	Food and detergent-grade STPP product, based on purified wet phosphoric acid.....	340
6.5.3	Feed phosphates – feed-grade DCP product .....	341
6.5.3.1	Feed phosphates manufactured by the phosphoric acid route .....	341
6.5.3.2	Feed phosphates manufactured by the hydrochloric acid route.....	341
<b>7</b>	<b>SELECTED ILLUSTRATIVE LVIC-S INDUSTRY PRODUCTS .....</b>	<b>343</b>



7.1	Aluminium fluoride .....	343
7.1.1	General information.....	343
7.1.2	Industrial processes applied.....	344
7.1.2.1	Dry fluorspar process.....	344
7.1.2.1.1	Generation of gaseous HF.....	344
7.1.2.1.2	AlF <sub>3</sub> reaction.....	344
7.1.2.1.3	Abatement techniques.....	345
7.1.2.2	Wet FSA process.....	345
7.1.2.2.1	Reaction step.....	346
7.1.2.2.2	Crystallisation.....	346
7.1.2.2.3	Drying.....	346
7.1.2.2.4	Calcination.....	346
7.1.3	Present consumption and emission levels.....	347
7.1.3.1	Dry fluorspar process.....	347
7.1.3.2	Wet FSA process.....	348
7.1.4	Techniques to consider in the determination of BAT.....	349
7.1.4.1	AlF <sub>3</sub> production by the dry fluorspar process.....	350
7.1.4.1.1	Usage of pure raw materials and the recovery of synthetic anhydrite.....	350
7.1.4.1.2	Energy recovery from the hot process gases.....	351
7.1.4.1.3	Abatement of effluent gases and dust from the production of AlF <sub>3</sub> .....	352
7.1.4.2	AlF <sub>3</sub> production by the wet fluosilicic acid process.....	352
7.1.5	Best Available Techniques for the manufacture of aluminium fluoride.....	353
7.2	Calcium carbide.....	356
7.2.1	General information.....	356
7.2.1.1	Introduction.....	356
7.2.1.2	Basic information on calcium carbide production.....	357
7.2.2	Industrial processes used.....	357
7.2.3	Present consumption and emission levels.....	359
7.2.3.1	Emissions to air.....	359
7.2.3.2	Emissions to water.....	360
7.2.3.3	Solid wastes.....	360
7.2.3.4	Raw materials and energy.....	360
7.2.4	Techniques to consider in the determination of BAT.....	361
7.2.4.1	Complete collection of furnace gas.....	361
7.2.4.2	Dry dedusting system for furnace gas cleaning.....	362
7.2.4.3	Wet dedusting system for furnace gas cleaning.....	362
7.2.4.4	Waste water treatment (for the wet dedusting process).....	363
7.2.4.5	Use of the furnace gas.....	364
7.2.4.6	Collection and treatment of tapping fumes.....	364
7.2.4.7	Waste gas treatment for other emission sources.....	365
7.2.5	Best Available Techniques for the manufacture of calcium carbide.....	365
7.3	Carbon disulphide.....	368
7.3.1	General information.....	368
7.3.1.1	Introduction.....	368
7.3.1.2	Characteristics of carbon disulphide.....	368
7.3.1.3	The scale of CS <sub>2</sub> production in Europe.....	369
7.3.2	Industrial processes used.....	370
7.3.3	Present consumption and emission levels.....	371
7.3.3.1	Emissions to air.....	371
7.3.3.2	Emissions to water.....	371
7.3.3.3	Solid wastes.....	371
7.3.4	Techniques to consider in the determination of BAT.....	372
7.3.4.1	Prevention measures applied to reduce emissions to air.....	372
7.3.4.2	Waste water treatment.....	373
7.3.4.3	Waste.....	374
7.3.5	Best Available Techniques for the manufacture of carbon disulphide.....	374
7.4	Ferrous chloride.....	376
7.4.1	General information.....	376
7.4.1.1	Introduction – ferrous chloride (FeCl <sub>2</sub> ).....	376
7.4.1.2	Background information on ferrous chloride (FeCl <sub>2</sub> ).....	376
7.4.2	Process description.....	377
7.4.3	Present consumption and emission levels.....	378
7.4.4	Techniques to consider in the determination of BAT.....	378

7.4.4.1	FeCl <sub>2</sub> production integrated with the production of TiO <sub>2</sub> .....	378
7.4.5	Best Available Techniques for the manufacture of ferrous chloride.....	379
7.5	Copperas and related products .....	380
7.5.1	Ferrous sulphate heptahydrate.....	380
7.5.1.1	Background information .....	380
7.5.1.2	Process description.....	381
7.5.1.3	Present consumption and emission levels .....	382
7.5.1.4	Techniques to consider in the determination of BAT.....	382
7.5.1.4.1	Copperas production integrated with the production of TiO <sub>2</sub> .....	382
7.5.1.5	Best Available Techniques for the manufacture of ferrous sulphate heptahydrate (FeSO <sub>4</sub> ·7H <sub>2</sub> O).....	383
7.5.2	Ferrous sulphate monohydrate .....	383
7.5.2.1	Background information .....	383
7.5.2.2	Process description.....	384
7.5.2.3	Present consumption and emission levels .....	385
7.5.2.4	Techniques to consider in the determination of BAT.....	385
7.5.2.4.1	FeSO <sub>4</sub> monohydrate manufacture integrated with the production of TiO <sub>2</sub> .....	385
7.5.2.5	Best Available Techniques for the manufacture of ferrous sulphate monohydrate (FeSO <sub>4</sub> ·H <sub>2</sub> O).....	386
7.5.3	Ferrous sulphate heptahydrate and monohydrate .....	386
7.5.3.1	Background information .....	386
7.5.3.2	Process description.....	387
7.5.3.3	Present consumption and emission levels .....	388
7.5.3.4	Techniques to consider in the determination of BAT.....	388
7.5.3.4.1	The use of bag filters for the dedusting of air used in copperas drying.....	388
7.5.3.5	Best Available Techniques for the manufacture of ferrous sulphate heptahydrate and monohydrate .....	389
7.5.4	Ferric sulphate.....	389
7.5.4.1	Background information .....	389
7.5.4.2	Process description.....	390
7.5.4.2.1	The reaction of ferrous sulphate with nitric and sulphuric acids.....	390
7.5.4.2.2	Direct oxidation of ferrous sulphate with oxygen and sulphuric acid .....	391
7.5.4.3	Present consumption and emission levels .....	393
7.5.4.3.1	Typical values for production using nitric and sulphuric acids.....	393
7.5.4.3.2	Typical values for production using pressure oxidation.....	393
7.5.4.3.3	Conversion of ferric sulphate solution to a solid ferric sulphate product.....	394
7.5.4.4	Techniques to consider in the determination of BAT.....	394
7.5.4.4.1	Production of ferric sulphate by the oxidation process with acids .....	394
7.5.4.4.2	Ferric sulphate production from copperas by the direct oxidation process ..	395
7.5.4.4.3	Production of dried ferric sulphate .....	396
7.5.4.5	Best Available Techniques for the manufacture of liquid and solid ferric sulphate Fe <sub>2</sub> (SO <sub>4</sub> ) <sub>3</sub> .....	397
7.5.5	Iron chlorosulphate .....	397
7.5.5.1	Background information .....	397
7.5.5.2	Process description.....	397
7.5.5.3	Present consumption and emission levels .....	398
7.5.5.4	Techniques to consider in the determination of BAT.....	398
7.5.5.4.1	Iron chlorosulphate produced from copperas by chlorination .....	398
7.5.5.5	Best Available Techniques for the manufacture of iron chlorosulphate (FeClSO <sub>4</sub> ) .....	399
7.5.6	Iron oxide pigment.....	399
7.5.6.1	Background information .....	399
7.5.6.2	Process description.....	400
7.5.6.3	Present consumption and emission levels .....	401
7.5.6.4	Techniques to consider in the determination of BAT.....	401
7.5.6.4.1	Iron oxide produced from copperas by dehydration and calcination.....	401
7.5.6.4.2	Sulphuric acid production from waste gas in the production of iron oxide..	402
7.5.6.5	Best Available Techniques for the manufacture of iron oxide pigment (Fe <sub>2</sub> O <sub>3</sub> )..	403
7.6	Lead oxide.....	404
7.6.1	General information .....	404
7.6.1.1	Introduction.....	404
7.6.1.2	Background information .....	404
7.6.1.3	Usage patterns and economic importance .....	405

7.6.1.3.1	Applications for litharge .....	405
7.6.1.3.2	Applications for red lead.....	406
7.6.1.4	Economic importance .....	406
7.6.2	Applied processes and techniques .....	407
7.6.2.1	Process boundaries.....	407
7.6.2.2	Lead oxide production process .....	408
7.6.2.2.1	Pre-oxidation (production of 'crude' oxide) .....	408
7.6.2.2.2	Secondary oxidation (final oxidation).....	409
7.6.2.2.3	Grinding/classification.....	411
7.6.2.2.4	Pelletisation.....	411
7.6.2.2.5	Packaging.....	412
7.6.2.3	Management system for reduction of diffuse emissions and exposure to lead ....	412
7.6.3	Present emission and consumption levels.....	413
7.6.3.1	Emissions from the manufacture of lead oxide.....	413
7.6.3.1.1	Emissions to air.....	414
7.6.3.1.2	Emissions to water.....	415
7.6.3.1.3	Solid wastes .....	415
7.6.3.2	Energy consumption and associated CO <sub>2</sub> emissions.....	416
7.6.4	Techniques to consider in the determination of BAT .....	416
7.6.4.1	Exhaust gas cleaning from the production of lead oxide .....	416
7.6.4.2	Waste water cleaning.....	417
7.6.4.3	Recycling residues with high Pb content in the lead smelter.....	418
7.6.4.4	Systems available for energy use in the production of lead oxide.....	419
7.6.5	Best Available Techniques for the manufacture of lead oxide .....	420
7.7	Magnesium compounds .....	421
7.7.1	General information.....	421
7.7.1.1	Introduction .....	421
7.7.1.2	Background information on magnesium compounds .....	422
7.7.2	Industrial processes used .....	425
7.7.2.1	Solution mining .....	426
7.7.2.2	Magnesium chloride production (solid).....	426
7.7.2.3	Production of DBM and other Mg compounds (wet sections) .....	426
7.7.2.3.1	Boron/sulphate reduction .....	426
7.7.2.3.2	Purification .....	426
7.7.2.3.3	Slaking of dolomite.....	427
7.7.2.3.4	Magnesium hydroxide precipitation .....	427
7.7.2.3.5	Washing and thickening.....	427
7.7.2.4	Dry sections applied in the production of magnesium compounds .....	427
7.7.2.4.1	Calcining.....	427
7.7.2.4.2	Briquetting.....	428
7.7.2.4.3	Sintering.....	428
7.7.3	Present consumption and emission levels.....	428
7.7.3.1	Use of raw material and energy consumption.....	428
7.7.3.2	Emissions to air .....	428
7.7.3.2.1	Dust.....	429
7.7.3.2.2	NO <sub>x</sub> , CO and CO <sub>2</sub> .....	429
7.7.3.2.3	SO <sub>2</sub> , Cl <sup>-</sup> and F <sup>-</sup> .....	429
7.7.3.2.4	Calcining and sintering .....	429
7.7.3.3	Emissions to water.....	430
7.7.3.4	Solid wastes .....	430
7.7.4	Techniques to consider in the determination of BAT .....	430
7.7.4.1	Abatement techniques for the emissions of dust.....	430
7.7.4.2	Abatement techniques for the emissions of SO <sub>2</sub> from sintering .....	431
7.7.4.3	Abatement techniques for the emissions of NO <sub>x</sub> and CO .....	432
7.7.5	Best Available Techniques for the manufacture of magnesium compounds .....	433
7.8	Sodium silicate .....	435
7.8.1	General Information .....	435
7.8.1.1	Introduction .....	435
7.8.1.2	Basic data on the glass manufacturing industry in the EU-15 .....	435
7.8.1.3	Sodium silicate uses and producers in Europe.....	436
7.8.2	Applied processes and techniques .....	437
7.8.2.1	Chemical reactions.....	437
7.8.2.2	Different qualities of sodium silicates .....	437

7.8.2.2.1	Non-aqueous sodium silicates with a molar ratio of $\text{SiO}_2/\text{Na}_2\text{O} \geq 2$ .....	437
7.8.2.2.2	Water glass solutions with a molar ratio of $\text{SiO}_2/\text{Na}_2\text{O} \geq 2$ .....	438
7.8.2.2.3	Sodium silicates with a molar ratio of $\text{SiO}_2/\text{Na}_2\text{O} \leq 1$ .....	438
7.8.2.3	Production procedures .....	439
7.8.2.3.1	General information .....	439
7.8.2.3.2	Production procedures of sodium silicate by the melting route .....	440
7.8.2.3.3	Manufacture of sodium silicate in a tank furnace .....	441
7.8.2.3.4	Manufacture of sodium silicate in a revolving hearth furnace .....	443
7.8.3	Present consumption and emission levels .....	444
7.8.3.1	Tank furnace process – energy consumption .....	444
7.8.3.2	Tank furnace process – emissions .....	445
7.8.3.2.1	Emissions to air .....	446
7.8.3.2.2	Emissions to water .....	446
7.8.3.2.3	Solid wastes .....	447
7.8.3.3	Revolving hearth furnace – energy consumption .....	447
7.8.3.3.1	Energy consumption in the production of solid water glass .....	447
7.8.3.3.2	Energy consumption in the production of liquid water glass .....	448
7.8.3.4	Revolving hearth furnace – emissions .....	448
7.8.3.4.1	Emissions to air .....	449
7.8.3.4.2	Emissions to water .....	449
7.8.3.4.3	Solid wastes .....	449
7.8.3.5	Inputs and outputs in the production of solid water glass .....	449
7.8.3.6	Inputs and outputs – sodium silicate by the hydrothermal route .....	450
7.8.4	Techniques to consider in the determination of BAT .....	451
7.8.4.1	Reduction of dust emissions using fabric filters or electrostatic precipitators .....	451
7.8.4.2	Reduction of $\text{SO}_2$ emissions using low sulphur fuel .....	452
7.8.4.3	Reduction of $\text{NO}_x$ emissions using primary measures .....	453
7.8.4.4	Reduction of HCl emissions using low chloride soda .....	454
7.8.4.5	Reduction of HF emissions using dry acid scrubbing .....	455
7.8.5	Best Available Techniques for the manufacture of sodium silicate .....	456
7.9	Silicon carbide .....	459
7.9.1	General information .....	459
7.9.1.1	Introduction .....	459
7.9.1.2	Physico-chemical properties .....	459
7.9.2	Applied processes and techniques .....	460
7.9.2.1	Furnace set-up – traditional design .....	461
7.9.2.2	Furnace set-up – freiland design .....	461
7.9.3	Present consumption and emission levels .....	461
7.9.3.1	Emissions to air .....	462
7.9.3.2	Emissions to water – emissions from water to air .....	464
7.9.3.3	Soil (groundwater) pollution .....	465
7.9.3.4	Solid wastes .....	465
7.9.3.5	Energy consumption .....	465
7.9.4	Techniques to consider in the determination of BAT .....	466
7.9.4.1	Use of low sulphur coke .....	466
7.9.4.2	Gas desulphurisation .....	467
7.9.4.3	Energy recovery .....	468
7.9.4.4	De $\text{NO}_x$ techniques .....	468
7.9.4.5	Dust prevention .....	469
7.9.4.6	Soil and groundwater protection .....	470
7.9.5	Best Available Techniques for the manufacture of silicon carbide .....	471
7.10	Zeolites .....	474
7.10.1	General information .....	474
7.10.1.1	Introduction .....	474
7.10.1.2	Product identity .....	475
7.10.1.3	Physical and chemical properties .....	475
7.10.1.3.1	Physical properties .....	475
7.10.1.3.2	Chemical properties .....	475
7.10.1.4	Production amounts .....	476
7.10.1.5	Product applications .....	476
7.10.1.5.1	Ion exchange .....	476
7.10.1.5.2	Adsorption .....	476
7.10.1.5.3	Catalysis .....	477

7.10.1.5.4	Other applications .....	477
7.10.2	Applied processes and techniques .....	477
7.10.2.1	Raw materials .....	477
7.10.2.1.1	Water glass .....	477
7.10.2.1.2	Sodium aluminate .....	477
7.10.2.1.3	Sodium hydroxide solution .....	477
7.10.2.1.4	Aluminium hydroxide .....	478
7.10.2.1.5	Raw materials storage .....	478
7.10.2.2	Production process – synthetic zeolites .....	478
7.10.2.2.1	Production of synthetic zeolite A .....	478
7.10.2.2.2	Production of synthetic zeolite Y .....	479
7.10.2.2.3	Production processes of other synthetic zeolite forms .....	480
7.10.3	Present consumption and emission levels .....	481
7.10.3.1	Consumption of raw materials and water .....	481
7.10.3.2	Consumption of energy .....	481
7.10.3.3	Emission levels .....	481
7.10.3.3.1	Emission to air .....	481
7.10.3.3.2	Emissions to water .....	482
7.10.3.3.3	Emission to water from the ion exchange process .....	482
7.10.3.3.4	Solid wastes .....	482
7.10.3.4	Other environmental aspects .....	482
7.10.4	Techniques to consider in the determination of BAT .....	483
7.10.4.1	Wet stage process in the production of synthetic zeolites .....	483
7.10.4.2	Dry stage process in the production of synthetic zeolites .....	484
7.10.5	Best Available Techniques for the manufacture of zeolites .....	485
7.11	Calcium chloride .....	487
7.11.1	General information .....	487
7.11.1.1	Introduction .....	487
7.11.1.2	CaCl <sub>2</sub> applications .....	487
7.11.1.3	World calcium chloride market and production potential .....	488
7.11.1.4	CaCl <sub>2</sub> product grades .....	488
7.11.2	Applied production processes .....	489
7.11.2.1	Co-product of soda ash manufacture .....	489
7.11.2.1.1	CaCl <sub>2</sub> liquor production from soda ash manufacture .....	489
7.11.2.1.2	Solid CaCl <sub>2</sub> product from soda ash co-production .....	489
7.11.2.1.3	Market limitation of CaCl <sub>2</sub> co-produced with soda ash production .....	490
7.11.2.2	Co-product of magnesium salts production .....	491
7.11.2.2.1	Calcium chloride liquor production .....	491
7.11.2.2.2	Calcium chloride solid production .....	492
7.11.2.3	Acid-limestone production .....	492
7.11.2.4	CaCl <sub>2</sub> production from natural brines .....	493
7.11.3	Environmental impacts and abatement technologies .....	493
7.11.3.1	Production via the soda ash or magnesium oxide routes .....	493
7.11.3.2	Production via the acid-limestone route .....	494
7.11.3.3	Present consumption and emission levels .....	494
7.11.4	Techniques to consider in the determination of BAT .....	495
7.11.4.1	Production processes for CaCl <sub>2</sub> based on the effluent from the soda ash plant .....	495
7.11.4.2	Production processes for CaCl <sub>2</sub> based on the MgO route .....	497
7.11.4.3	Production processes for CaCl <sub>2</sub> via the acid-limestone route .....	498
7.11.5	Best Available Techniques for the manufacture of calcium chloride .....	499
7.12	Precipitated calcium carbonate .....	501
7.12.1	General information .....	501
7.12.1.1	Product .....	501
7.12.1.2	Applications .....	501
7.12.1.3	Production process .....	501
7.12.1.4	Plant locations .....	502
7.12.1.5	Production capacity in the world and in Europe .....	502
7.12.1.5.1	PCC production capacity by main world regions .....	502
7.12.1.5.2	Production capacity of PCC in the European Union .....	503
7.12.2	Process description .....	504
7.12.3	Present consumption and emission levels .....	505
7.12.3.1	Emissions to air .....	506
7.12.3.1.1	CO <sub>2</sub> capture in the carbonation step .....	507

7.12.3.1.2	CO <sub>2</sub> emissions from the lime kiln .....	507
7.12.3.2	Emissions to water .....	507
7.12.3.3	Solid wastes.....	507
7.12.4	Techniques to consider in the determination of BAT .....	508
7.12.4.1	PCC plant design, configuration and operation.....	508
7.12.4.2	Solid waste reduction .....	509
7.12.4.3	Capture of CO <sub>2</sub> and reduction of CO <sub>2</sub> emissions .....	510
7.12.4.4	Emissions to water .....	511
7.12.5	Best Available Techniques for the manufacture of precipitated calcium carbonate .....	512
7.13	Sodium chlorate .....	513
7.13.1	General information .....	513
7.13.1.1	Introduction.....	513
7.13.1.2	Sodium chlorate uses.....	514
7.13.1.3	Production capacity.....	514
7.13.1.4	Economic factors.....	514
7.13.2	Applied processes and techniques.....	514
7.13.2.1	Brine production.....	515
7.13.2.2	Brine purification .....	516
7.13.2.3	Electrolysis.....	516
7.13.2.4	Crystallisation .....	516
7.13.2.5	Drying .....	516
7.13.2.6	Storage .....	517
7.13.3	Present consumption and emission levels .....	517
7.13.3.1	Overall consumption and emission levels .....	517
7.13.3.2	Inputs, raw material and energy consumption.....	518
7.13.3.2.1	Sodium chloride .....	518
7.13.3.2.2	Water .....	518
7.13.3.2.3	Energy .....	518
7.13.3.2.4	Auxiliary substances .....	519
7.13.3.3	Products and by-products.....	519
7.13.3.4	Emissions from the sodium chlorate process .....	519
7.13.3.4.1	Emissionsto air .....	519
7.13.3.4.2	Emissions to water .....	520
7.13.3.4.3	Solid wastes.....	520
7.13.4	Techniques to consider in the determination of BAT .....	520
7.13.4.1	Low energy consumption.....	521
7.13.4.2	High hydrogen utilisation.....	522
7.13.4.3	High secondary heat utilisation .....	523
7.13.4.4	High degree of recycling.....	523
7.13.4.5	Low emissions to air, surface water and groundwater .....	524
7.13.4.5.1	Low emissions to air .....	524
7.13.4.5.2	Low emissions to surface water and groundwater.....	525
7.13.4.6	Low amount of hazardous waste .....	526
7.13.5	Best Available Techniques for the manufacture of sodium chlorate.....	526
7.14	Sodium perborate .....	528
7.14.1	General information .....	528
7.14.1.1	Introduction.....	528
7.14.1.2	History of production .....	529
7.14.1.3	Production process .....	529
7.14.1.4	Uses in industrial sectors.....	529
7.14.1.5	Production capacity.....	529
7.14.1.6	Socio-economic aspects .....	530
7.14.2	Industrial processes used.....	530
7.14.2.1	Process chemistry.....	530
7.14.2.2	Production process .....	530
7.14.2.2.1	Manufacture of sodium perborate tetrahydrate .....	530
7.14.2.2.2	Manufacture of sodium perborate monohydrate .....	532
7.14.3	Present consumption and emission levels .....	533
7.14.3.1	Raw materials.....	533
7.14.3.2	Utilities.....	533
7.14.3.2.1	Steam.....	533
7.14.3.2.2	Cooling media .....	533
7.14.3.2.3	Electric energy.....	534

7.14.3.2.4	Natural gas .....	534
7.14.3.2.5	Total energy consumption.....	534
7.14.3.3	Emissions.....	535
7.14.3.3.1	Dust emissions .....	535
7.14.3.3.2	Water emissions .....	535
7.14.4	Techniques to consider in the determination of BAT .....	535
7.14.4.1	Pure raw materials used for the production of sodium perborate .....	536
7.14.4.2	Manufacture of the intermediate product (metaborate solution).....	537
7.14.4.3	Purifying the metaborate solution/waste aspect.....	537
7.14.4.4	Crystallisation of perborate tetrahydrate.....	538
7.14.4.5	Separation of the crystals from the mother liquor.....	539
7.14.4.6	Drying sodium perborate and the purification of the exhaust air.....	540
7.14.4.7	Optimum water balance in the process/minimum waste water.....	541
7.14.5	Best Available Techniques for the manufacture of sodium perborate .....	542
7.15	Sodium percarbonate .....	544
7.15.1	General information.....	544
7.15.1.1	Introduction .....	544
7.15.1.2	History of production.....	544
7.15.1.3	Production processes .....	545
7.15.1.4	Uses in industrial sectors .....	545
7.15.1.5	Production capacity .....	545
7.15.1.6	Socio-economic aspects.....	545
7.15.2	Industrial processes used .....	546
7.15.2.1	Process chemistry .....	546
7.15.2.2	Production processes .....	546
7.15.2.2.1	The crystallisation process .....	546
7.15.2.2.2	The spray-granulation process .....	548
7.15.2.2.3	The coating process .....	550
7.15.3	Present consumption and emission levels.....	550
7.15.3.1	Raw materials .....	550
7.15.3.2	Utilities .....	550
7.15.3.2.1	Thermal media (steam and natural gas) .....	550
7.15.3.2.2	Cooling media.....	551
7.15.3.2.3	Electric energy.....	551
7.15.3.2.4	Total energy consumption.....	551
7.15.3.3	Emissions.....	551
7.15.3.3.1	Dust emissions .....	551
7.15.3.3.2	Water emissions.....	552
7.15.4	Techniques to consider in the determination of BAT .....	552
7.15.4.1	Raw materials used for the production of sodium percarbonate.....	552
7.15.4.2	Energy consumption in the production of sodium percarbonate.....	553
7.15.4.3	Purification of the exhaust air .....	554
7.15.4.4	Minimisation of waste water discharged from the process.....	555
7.15.5	Best Available Techniques for the manufacture of sodium percarbonate .....	556
7.16	Sodium sulphite and related products .....	558
7.16.1	General Information .....	558
7.16.1.1	Introduction .....	558
7.16.1.2	Chemicals .....	558
7.16.1.3	Background information.....	558
7.16.1.3.1	European manufacturing locations.....	558
7.16.1.3.2	Sulphite markets .....	559
7.16.1.3.3	EU-15 trade.....	559
7.16.2	Industrial processes used .....	560
7.16.2.1	Introduction .....	560
7.16.2.2	Primary processes .....	560
7.16.2.2.1	Sulphur burning .....	560
7.16.2.2.2	Reaction of sulphur dioxide and alkalis .....	561
7.16.2.2.3	Centrifuging, drying and packaging.....	562
7.16.2.3	Associated processes .....	562
7.16.2.3.1	Raw materials storage and use.....	562
7.16.2.3.2	Process control techniques.....	563
7.16.2.3.3	Air abatement techniques.....	563
7.16.2.3.4	Other waste treatment.....	563

7.16.2.3.5	Emissions measurement and use of data .....	563
7.16.2.3.6	Energy and heat recovery .....	564
7.16.2.3.7	Odour.....	564
7.16.2.3.8	Decommissioning.....	564
7.16.2.3.9	Management, design and training.....	564
7.16.2.3.10	Process-integrated techniques .....	564
7.16.3	Present consumption and emission levels .....	565
7.16.3.1	Raw material and energy consumption .....	565
7.16.3.1.1	Raw materials .....	565
7.16.3.1.2	Water .....	565
7.16.3.1.3	Energy .....	566
7.16.3.2	Primary environmental releases .....	566
7.16.3.3	Key environmental issues.....	567
7.16.3.3.1	Emissions to air .....	567
7.16.3.3.2	Emissions to water .....	567
7.16.3.3.3	Solid wastes.....	567
7.16.4	Techniques to consider in the determination of BAT .....	567
7.16.4.1	Minimisation of the releases of sulphur compounds to the air .....	567
7.16.4.2	Abatement technologies to reduce the emissions of SO <sub>2</sub> and H <sub>2</sub> S .....	568
7.16.4.3	Dedusting systems used in the production of sodium sulphite.....	569
7.16.4.4	Techniques to minimise the releases to water .....	570
7.16.4.5	Low releases to land from the production of sodium sulphite.....	571
7.16.5	Best Available Techniques for the manufacture of sodium sulphite and related products .....	572
7.17	Zinc oxide .....	574
7.17.1	General information .....	574
7.17.1.1	Introduction.....	574
7.17.1.2	Basic data on zinc oxide production.....	574
7.17.2	Industrial processes used.....	575
7.17.2.1	Direct process.....	576
7.17.2.2	Indirect process .....	577
7.17.2.2.1	Electro-thermal.....	577
7.17.2.2.2	Muffle.....	578
7.17.2.2.3	Rectification .....	579
7.17.2.2.4	Retort.....	579
7.17.2.2.5	Rotary kiln.....	580
7.17.2.3	Wet chemical process.....	581
7.17.3	Present consumption and emission levels .....	581
7.17.4	Techniques to consider in the determination of BAT .....	583
7.17.4.1	Direct process for the production of zinc oxide .....	584
7.17.4.2	Indirect processes used for the production of zinc oxide .....	585
7.17.4.2.1	Electro-thermal process.....	585
7.17.4.2.2	Muffle process.....	586
7.17.4.2.3	Rectification process .....	586
7.17.4.2.4	Retort process.....	587
7.17.4.2.5	Rotary kiln process.....	588
7.17.4.3	Wet chemical process of the production of zinc oxide.....	589
7.17.5	Best Available Techniques for the manufacture of zinc oxide.....	590
<b>8</b>	<b>COMMON ABATEMENT MEASURES APPLIED IN THE LVIC-S INDUSTRY .....</b>	<b>593</b>
8.1	General remarks .....	593
8.2	Emissions to air applicable to the LVIC-S industry .....	594
8.2.1	Common air pollutants met in LVIC-S processes.....	594
8.2.2	The sources of emissions to air in the LVIC-S industry .....	595
8.2.3	Abatement of generic pollutants emitted to air .....	596
8.2.3.1	Chlorine.....	596
8.2.3.2	Hydrogen chloride.....	597
8.2.3.3	Sulphur dioxide .....	597
8.2.3.4	Nitrogen oxides .....	598
8.2.3.5	Ammonia.....	598
8.2.3.6	VOC .....	598
8.2.3.7	Dust.....	599
8.2.3.8	Carbon monoxide.....	600



8.2.3.9	Carbon dioxide .....	600
8.2.4	Measures to reduce or prevent releases into air .....	601
8.2.4.1	Techniques available for reducing emissions to air .....	602
8.3	Emissions to water applicable to the LVIC-S industry .....	605
8.3.1	Common water pollutants met in LVIC-S processes .....	605
8.3.2	The sources of emissions to water in the LVIC-S industry .....	605
8.3.3	Abatement of generic pollutants emitted to water .....	606
8.3.3.1	Chlorides .....	607
8.3.3.2	Sulphates .....	607
8.3.3.3	Phosphates .....	607
8.3.3.4	Ammonia .....	607
8.3.3.5	Fluorides .....	607
8.3.3.6	Metals and heavy metals .....	607
8.3.3.7	Inorganic substances .....	607
8.3.3.8	Suspended matters .....	608
8.3.4	Measures available to control water pollutants .....	608
8.3.4.1	Measures to reduce or prevent releases into water .....	608
8.3.4.2	Minimisation of waste water discharges .....	609
8.3.4.3	Water collection .....	609
8.3.4.3.1	Process waters .....	609
8.3.4.3.2	Site drainage waters .....	610
8.3.4.3.3	Cooling waters .....	610
8.3.4.4	Treatment systems .....	610
8.3.4.4.1	In plant treatment .....	610
8.3.4.4.2	Primary treatment .....	610
8.3.4.4.3	Secondary/tertiary systems .....	611
8.4	Solid wastes applicable to the LVIC-S industry .....	612
8.4.1	Soil pollutants .....	612
8.4.2	Measures to reduce or prevent releases of waste .....	612
8.4.3	Waste control in the LVIC-S industry .....	613
8.5	Other environmental issues of concern .....	613
8.5.1	Vibration .....	613
8.5.2	Noise emissions .....	614
8.5.3	Heat emissions .....	614
8.6	Start-up, shut-down and abnormal operating conditions .....	614
8.6.1	Start-up and shut-down .....	614
8.6.2	Abnormal operating conditions .....	614
8.7	Improvement of environmental performance .....	615
8.8	Measures for reducing the environmental impact of the LVIC-S industry .....	616
8.8.1	Management techniques to implement integrated environmental protection .....	616
8.8.1.1	Senior management commitment .....	617
8.8.1.2	Organisation and responsibility .....	617
8.8.1.3	Maintenance .....	618
8.8.1.4	Process control .....	618
8.8.1.5	Waste minimisation .....	618
8.8.1.6	Design .....	618
8.8.1.7	Training .....	618
8.8.1.8	Finance and accounting .....	618
8.8.2	Careful use of resources .....	619
8.8.2.1	Raw materials .....	619
8.8.2.2	Handling valuable products on integrated sites or in a single installation .....	619
8.8.2.3	Relation between costs and location .....	619
8.8.2.4	Process agents and auxiliary products .....	620
8.8.3	Energy and utilities .....	620
8.8.3.1	Pinch Technology .....	621
8.9	Environmental management tools .....	621
8.10	Best Available Techniques for environmental management .....	628
<b>9</b>	<b>EMERGING TECHNIQUES IN THE LVIC-S INDUSTRY .....</b>	<b>631</b>
9.1	Introduction .....	631
9.2	Soda ash .....	631
9.2.1	Integration of a soda ash plant with an ammonia plant .....	631
9.2.2	Innovations in the carbonation section of the soda ash plant .....	632

9.3	Titanium dioxide .....	633
9.3.1	Chloride process.....	633
9.3.2	Sulphate process.....	633
9.3.2.1	Continuous digestion.....	634
9.3.2.2	Fluid bed calcination.....	634
9.3.2.3	Osmosis of strong and weak acid filtrates from pre-leach and post-leach .....	634
9.3.2.4	Solvent extraction of sulphate metals from strong and weak acid filtrates .....	634
9.3.2.5	Solvent extraction of TiOSO <sub>4</sub> and TiCl <sub>4</sub> from aqueous solution.....	634
9.3.2.6	Hydrometallurgical process - hydrolysis of TiOSO <sub>4</sub> and TiCl <sub>4</sub> solutions .....	635
9.3.3	Finishing plants for the chloride and sulphate process.....	635
9.3.4	New products and co-products.....	635
9.3.4.1	The intermediate titanium oxyhydrate .....	635
9.3.4.2	Ferrous sulphate .....	635
9.4	Carbon black .....	636
9.4.1	General outlook – emerging techniques/future developments .....	636
9.4.2	Low NO <sub>x</sub> in dryers.....	637
9.5	Synthetic amorphous silica.....	637
9.6	Inorganic phosphates.....	637
9.7	Selected illustrative LVIC-S industry products.....	637
9.7.1	Silicon carbide .....	637
9.7.1.1	Emerging techniques .....	637
9.7.1.2	Potential new developments in operation.....	637
9.7.1.2.1	Traditional furnace .....	637
9.7.1.2.2	Freiland furnace.....	637
<b>10</b>	<b>CONCLUDING REMARKS .....</b>	<b>639</b>
10.1	Background information .....	639
10.2	Milestones .....	639
10.3	The final meeting on the LVIC-S industry.....	641
10.4	Degree of consensus reached at the final meeting.....	642
10.5	Recommendations for future work.....	642
	<b>REFERENCES.....</b>	<b>645</b>
	<b>GLOSSARY OF TERMS AND ABBREVIATIONS .....</b>	<b>649</b>
<b>11</b>	<b>ANNEXES .....</b>	<b>657</b>
11.1	Annex 1 – Basic classes of inorganic compounds.....	657
11.2	Annex 2 – Selected unit operations in the LVIC-S industry .....	658
11.2.1	Size reduction.....	658
11.2.2	Sedimentation .....	658
11.2.3	Filtration.....	658
11.2.4	Drying .....	659
11.3	Annex 3 – good environmental practice (GEP) for the use of technology, plant design, maintenance, operation, environmental protection and plant decommissioning in the LVIC-S industry.....	660
11.3.1	GEP for the use of technology in the LVIC-S industry.....	660
11.3.2	GEP for plant design in the LVIC-S industry .....	661
11.3.3	GEP for plant maintenance in the LVIC-S industry.....	662
11.3.4	GEP for plant operation in the LVIC-S industry.....	663
11.3.5	GEP for reducing environmental impact from the LVIC-S industry .....	665
11.3.6	GEP for plant decommissioning in the LVIC-S industry.....	666

---

## List of figures

Figure 1.1:	Geographic breakdown of world chemical sales .....	2
Figure 1.2:	The EU's share of global chemicals production is dropping .....	2
Figure 1.3:	Geographic breakdown of EU chemical industry sales .....	3
Figure 1.4:	Sectoral breakdown of EU chemical industry sales .....	3
Figure 1.5:	Growth of EU chemical production, total industry and GDP .....	5
Figure 1.6:	Production growth of the EU-15 chemical industry by sector .....	5
Figure 1.7:	EU chemical industry energy consumption by source .....	6
Figure 1.8:	Energy efficiency in the EU chemical industry .....	7
Figure 1.9:	EU's chemical industry R&D expenditure .....	7
Figure 1.10:	CO <sub>2</sub> emissions, energy consumption and production from the EU chemical industry .....	8
Figure 1.11:	Specific CO <sub>2</sub> emissions figures from EU chemical industry .....	8
Figure 1.12:	Greenhouse gas emissions from the EU chemical industry .....	9
Figure 1.13:	Emissions and performance from the EU chemical industry .....	9
Figure 1.14:	Inorganic chemical complex with a boundary between LVIC-S and SIC plants .....	11
Figure 1.15:	Integrated soda ash complex leading to soda family products .....	12
Figure 1.16:	Interlinkage of chemical process industries with basic needs .....	13
Figure 1.17:	Distribution of LVIC-S cornerstone plants across the EU-25 .....	19
Figure 2.1:	Distribution of soda ash plants within the EU-25 and outside (Solvay process, 2002) .....	38
Figure 2.2:	Process flow diagram for the manufacture of soda ash by the Solvay process .....	42
Figure 2.3:	Process flow diagram for the manufacture of refined sodium bicarbonate .....	66
Figure 2.4:	Interlinkages between raw materials, products and waste in soda ash production .....	89
Figure 2.5:	Separation of coarse solid fraction from the distillation waste waters .....	93
Figure 3.1:	Trend prices in titanium dioxide pigment commodity product .....	106
Figure 3.2:	Outline flow diagram – TiO <sub>2</sub> chloride process route .....	109
Figure 3.3:	Main raw materials inputs and production outputs for the Greatham site for 2002 .....	124
Figure 3.4:	Outline flow diagram – titanium dioxide production by the sulphate process .....	143
Figure 3.5:	Overall process-scheme of sulphuric acid recycling – TiO <sub>2</sub> sulphate route .....	149
Figure 3.6:	Main raw materials inputs and production outputs – the Grimsby site, 2002 .....	161
Figure 3.7:	CO <sub>2</sub> emissions related to TiO <sub>2</sub> production in the Grimsby Works, the sulphate process .....	162
Figure 3.8:	Liquid effluent sulphate load from TiO <sub>2</sub> production via the sulphate route in Grimsby Works .....	163
Figure 3.9:	Unit energy consumption from TiO <sub>2</sub> production via the sulphate route in Grimsby Works .....	163
Figure 3.10:	Integrated approach in the LCA study on TiO <sub>2</sub> manufacture .....	191
Figure 3.11:	Assumptions of the LCA inventory study on TiO <sub>2</sub> manufacture .....	192
Figure 3.12:	Gross primary energy demand for the manufacture of the TiO <sub>2</sub> pigment step by step .....	193
Figure 3.13:	Emissions of sulphur oxides to air analysed in the LCA study .....	194
Figure 3.14:	Releases of acids to water analysed in the LCA study .....	195
Figure 3.15:	Solid wastes generated in the whole chain of operations relating to the TiO <sub>2</sub> industry .....	196
Figure 4.1:	Furnace black process .....	209
Figure 4.2:	Pelleting machine used in the wet pelletisation process .....	211
Figure 4.3:	Example of possible configuration of the furnace black process .....	212
Figure 4.4:	The gas black process .....	213
Figure 4.5:	Thermal black process .....	214
Figure 4.6:	Equipment for the oxidative treatment of carbon black in a fluidised bed .....	216
Figure 4.7:	Relationship between the feedstock sulphur level and specific SO <sub>2</sub> emission .....	232
Figure 5.1:	Silica polymorphs .....	256
Figure 5.2:	Different forms of commercially important synthetic amorphous silicas .....	257
Figure 5.3:	West European consumption of synthetic amorphous pyrogenic silica .....	260
Figure 5.4:	West European consumption of synthetic amorphous precipitated silica .....	260
Figure 5.5:	West European consumption of synthetic amorphous silica gel .....	261
Figure 5.6:	Synthetic amorphous pyrogenic silica particle formation .....	262
Figure 5.7:	Routes to raw materials used in the production of pyrogenic silica .....	263
Figure 5.8:	Main units of a synthetic amorphous pyrogenic silica plant .....	263
Figure 5.9:	Process flow diagram of a synthetic amorphous pyrogenic silica at a sub-unit level .....	264
Figure 5.10:	Flow sheet for the production process of precipitated silica .....	266
Figure 5.11:	Flow sheet for the production process of silica gel .....	268
Figure 6.1:	Interrelationship between different sectors of the inorganic phosphates industry .....	296
Figure 6.2:	Process routes and process steps applied in STPP production .....	302
Figure 6.3:	The process scheme – green acid neutralisation and purification .....	303

Figure 6.4:	Phosphate rock – main downstream processes and applications .....	321
Figure 6.5:	Block diagram - dicalcium phosphate (DCP) process .....	323
Figure 6.6:	Block diagram - monocalcium phosphate (MCP) process.....	324
Figure 6.7:	Block diagram – calcium-magnesium phosphate (CaMgP) process.....	325
Figure 6.8:	Block diagram – magnesium phosphate (MgP) process.....	326
Figure 6.9:	Block diagram – sodium-calcium-magnesium phosphate (NaCaMgP) process .....	327
Figure 6.10:	Block diagram – dicalcium phosphate process route based on hydrochloric acid.....	329
Figure 7.1:	Flow sheet of aluminium fluoride production by the dry fluorspar process .....	345
Figure 7.2:	Flow sheet of a typical calcium carbide production process.....	358
Figure 7.3:	A flow chart of carbon disulphide production in a CS <sub>2</sub> plant in Cologne, Germany .....	370
Figure 7.4:	Process flow diagram for the manufacture of ferrous chloride.....	377
Figure 7.5:	Process flow diagram – copperas manufacture.....	381
Figure 7.6:	Process flow diagram – ferrous sulphate monohydrate manufacture .....	384
Figure 7.7:	Process flow diagram – dried FeSO <sub>4</sub> ·7H <sub>2</sub> O and FeSO <sub>4</sub> ·H <sub>2</sub> O from the drying of copperas.....	387
Figure 7.8:	Ferric sulphate produced by the reaction of ferrous sulphate with nitric and sulphuric acids .....	391
Figure 7.9:	Ferric sulphate produced by direct oxidation of ferrous sulphate.....	392
Figure 7.10:	Production of dried ferric sulphate .....	392
Figure 7.11:	Process flow diagram – ferric chloride sulphate manufacture .....	398
Figure 7.12:	Flow chart of iron oxide pigment production .....	400
Figure 7.13:	Process boundaries indicating different process steps in lead oxide production.....	407
Figure 7.14:	Pre-oxidation in a stirred reactor .....	408
Figure 7.15:	Pre-oxidation in a rotary furnace .....	409
Figure 7.16:	Secondary oxidation in a batch furnace .....	410
Figure 7.17:	Secondary oxidation in a tubular furnace .....	410
Figure 7.18:	Secondary oxidation in a rotary furnace .....	411
Figure 7.19:	Emissions from the production of lead oxide .....	413
Figure 7.20:	Example of a fabric filter system used in the lead oxide industry .....	414
Figure 7.21:	Principle of a cassette filter system.....	415
Figure 7.22:	Flow diagram of the production of magnesium oxide (DBM) in the Netherlands .....	425
Figure 7.23:	Schematic flow chart for the production of four different groups of sodium silicates.....	439
Figure 7.24:	Melting diagram of the system SiO <sub>2</sub> /Na <sub>2</sub> O .....	441
Figure 7.25:	Working principle of a tank furnace .....	441
Figure 7.26:	Flow diagram of the production of sodium silicate using a tank furnace .....	442
Figure 7.27:	Flow diagram of the production of sodium silicate using a revolving hearth furnace .....	443
Figure 7.28:	Working principle of a revolving hearth furnace.....	444
Figure 7.29:	Heat recovery by regenerators .....	445
Figure 7.30:	Emissions from the production of sodium silicate using a tank furnace.....	445
Figure 7.31:	The principle of heat recovery in a sodium silicate plant (revolving hearth furnace).....	447
Figure 7.32:	Emissions from the production of sodium silicate with a revolving hearth furnace .....	448
Figure 7.33:	Simplified diagram of silicon carbide production.....	460
Figure 7.34:	Flow diagram of the zeolite A production process .....	479
Figure 7.35:	Flow diagram of the zeolite Y production process .....	480
Figure 7.36:	Process flow diagram of the production of various CaCl <sub>2</sub> grades.....	490
Figure 7.37:	Process flow diagram for CaCl <sub>2</sub> production via the acid-lime neutralisation route .....	492
Figure 7.38:	Process flow diagram for the manufacture of PCC.....	505
Figure 7.39:	Sodium chlorate production – flow diagram .....	515
Figure 7.40:	Flow diagram showing sodium perborate tetrahydrate production.....	531
Figure 7.41:	Flow diagram showing sodium perborate monohydrate production.....	532
Figure 7.42:	Sodium percarbonate production by the crystallisation process .....	547
Figure 7.43:	Sodium percarbonate production by the spray-granulation process .....	549
Figure 7.44:	Market sector distribution for sulphite chemicals in Europe .....	559
Figure 7.45:	Flow diagram for sulphur burning to produce sulphur dioxide .....	561
Figure 7.46:	Main process routes for zinc oxide production.....	576
Figure 7.47:	Flow diagram showing the production of ZnO by the direct process .....	577
Figure 7.48:	Process flow diagram showing the electro-thermal production of ZnO .....	578
Figure 7.49:	Process flow diagram of the production of ZnO in muffle furnaces.....	578
Figure 7.50:	Process flow diagram showing the production of ZnO by the rectification process.....	579
Figure 7.51:	Process flow diagram showing the production of ZnO in retorts .....	580
Figure 7.52:	Process flow diagram showing the production ZnO in rotary kilns.....	580
Figure 7.53:	Process flow diagram showing the production of ZnO by the wet chemical process.....	581

---

## List of tables

Table 1.1:	List of the 15 largest EU-15 chemical companies, ranked in the worldwide scale	4
Table 1.2:	Criteria for the selection between the LVIC and SIC industries	14
Table 1.3:	Capacities of LVIC-S cornerstone products in the EU	18
Table 1.4:	Unit processes typical to the LVIC-S industry	25
Table 2.1:	A comparison of the main soda ash producing regions (approximate data)	32
Table 2.2:	Worldwide capacity of soda ash manufacture (reference year: 2002)	37
Table 2.3:	European soda ash capacity and producers (reference year: 2002)	37
Table 2.4:	Soda ash manufacturing costs	40
Table 2.5:	Plant areas/operations in the soda ash plant based on the Solvay process	43
Table 2.6:	Raw and purified brines (typical composition ranges)	47
Table 2.7:	Composition of some limestones used for the production of soda ash in the EU-25	48
Table 2.8:	Coke for lime kilns (typical composition ranges)	49
Table 2.9:	Main output streams from the soda ash process	50
Table 2.10:	Heavy metals in the raw materials entering soda ash plants in the EU-25	51
Table 2.11:	Soda ash process major input/output levels	53
Table 2.12:	Raw materials consumption and effluent discharge for a 500 kt/year soda ash plant	54
Table 2.13:	Waste water from distillation	59
Table 2.14:	Limitations of waste water discharges from the production of soda ash in Austria	61
Table 2.15:	Characteristics of waste waters from the Rheinberg soda ash plant, Germany	62
Table 2.16:	Effluent from brine purification (typical composition)	63
Table 2.17:	Solid wastes from soda ash process	63
Table 2.18:	Worldwide refined sodium bicarbonate annual capacities (reference year: 2002)	64
Table 2.19:	European refined sodium bicarbonate capacity and producers (reference year: 2002)	64
Table 2.20:	Consumption of refined sodium bicarbonate in the EU-15 (reference year: 2002)	65
Table 2.21:	Vent gas from bicarbonation columns blown with lime kiln gas	66
Table 2.22:	Ranges of energy consumption in soda ash production	68
Table 2.23:	Vent gas from lime kilns after cleaning	70
Table 2.24:	Typical gas composition from limestone calcination	70
Table 2.25:	Vent gas from the column section after washing	71
Table 2.26:	Filter gas after washing	72
Table 2.27:	Information breakdown for each technique described in this section	79
Table 2.28:	Separation of coarse solid fraction in distillation discharge	94
Table 3.1:	World consumption of TiO <sub>2</sub> pigments in 1996	103
Table 3.2:	Annual growth rates of TiO <sub>2</sub> use (1993 – 2000, %)	103
Table 3.3:	World production of TiO <sub>2</sub> pigment	103
Table 3.4:	World TiO <sub>2</sub> pigment production capacities in 1995 by region	104
Table 3.5:	EU-25 (plus Norway) TiO <sub>2</sub> pigment production capacities in 2002	104
Table 3.6:	TiO <sub>2</sub> industry site details including capital costs of environmental improvements	107
Table 3.7:	Components in the main mineral feedstocks for the titanium dioxide industry	110
Table 3.8:	The TiO <sub>2</sub> content of the main feedstocks	114
Table 3.9:	Chlorine usage	115
Table 3.10:	Coke usage	115
Table 3.11:	Lime and coal usage	115
Table 3.12:	Oil usage	116
Table 3.13:	Pure oxygen used to oxidise titanium tetrachloride	116
Table 3.14:	Abrasive solids usage	116
Table 3.15:	Caustic soda solution usage	116
Table 3.16:	Energy consumption in TiO <sub>2</sub> production based on the chloride process in 1999	117
Table 3.17:	Water consumption for the chloride process	118
Table 3.18:	Dust and NO <sub>x</sub> emissions – TiO <sub>2</sub> production, the chloride process	118
Table 3.19:	Emissions to air from chlorination – TiO <sub>2</sub> production, the chloride process	119
Table 3.20:	Data on hydrogen chloride emissions	119
Table 3.21:	Emissions to air from waste solid metal chlorides treatment	120
Table 3.22:	Emissions to air from oxidation	120
Table 3.23:	Dust and NO <sub>x</sub> emissions, finishing section – TiO <sub>2</sub> production, the chloride process	121
Table 3.24:	Emissions of metals to water – TiO <sub>2</sub> production by the chloride route	121
Table 3.25:	Emissions of hydrochloric acid and suspended solids to water	122
Table 3.26:	Emissions of suspended solids and chlorides to water – TiO <sub>2</sub> chloride process	122
Table 3.27:	Waste sent to landfill from the chlorination unit	123
Table 3.28:	Emission levels of solids from metal chlorides treatment by neutralisation or roasting	123

Table 3.29:	Emissions 1999 – 2002 in the Greatham Works TiO <sub>2</sub> plant, the chloride process .....	125
Table 3.30:	Information breakdown for each technique described in this section .....	126
Table 3.31:	Abatement systems for gases – TiO <sub>2</sub> production by the chloride process .....	134
Table 3.32:	Abatement systems – liquid and solid emissions from TiO <sub>2</sub> plants, using the chloride process .....	139
Table 3.33:	Energy usage in 1999 in TiO <sub>2</sub> plants operated by the chloride process route .....	140
Table 3.34:	Components in main mineral feedstock – TiO <sub>2</sub> production, the sulphate process .....	142
Table 3.35:	Usage of the main titaniferous raw materials in the sulphate process .....	151
Table 3.36:	Sulphuric acid usage in titanium dioxide production by the sulphate process .....	151
Table 3.37:	Scrap iron usage .....	152
Table 3.38:	Materials used – abatement systems aqueous emissions and the finishing section .....	152
Table 3.39:	Energy consumption in TiO <sub>2</sub> production – the sulphate process .....	153
Table 3.40:	Energy usage in the production of TiO <sub>2</sub> via the sulphate process .....	155
Table 3.41:	Water consumption in the production of TiO <sub>2</sub> via the sulphate process .....	155
Table 3.42:	Dust and NO <sub>x</sub> emissions – TiO <sub>2</sub> production, the sulphate process .....	156
Table 3.43:	Gaseous emissions in the digestion section – TiO <sub>2</sub> production, the sulphate process .....	156
Table 3.44:	Hydrogen emissions during the reduction step .....	157
Table 3.45:	Gaseous emissions from calcination – TiO <sub>2</sub> production, the sulphate process .....	157
Table 3.46:	Dust emissions from the finishing section – TiO <sub>2</sub> production, the sulphate process .....	158
Table 3.47:	Major aqueous emissions from the TiO <sub>2</sub> production based on the sulphate process .....	159
Table 3.48:	Waste to land from the digester residue (for TiO <sub>2</sub> production via the sulphate process) ...	160
Table 3.49:	Wastes to land from the neutralisation of aqueous emissions, the sulphate process .....	160
Table 3.50:	Detailed annual emissions 2002 in Grimsby Works, the sulphate process .....	164
Table 3.51:	Information breakdown for each technique described in this section .....	165
Table 3.52:	Gaseous emissions treatment performance/costs – digestion, the sulphate process .....	176
Table 3.53:	Gaseous emissions treatment performance/costs – calcination, the sulphate process .....	177
Table 3.54:	Methods used for liquid effluent treatment, the sulphate process .....	179
Table 3.55:	Strong and weak acid effluent treatment costs and performance .....	180
Table 3.56:	Comparison of the impurity removal sections of the two processes .....	188
Table 3.57:	Mineral feedstock options analysed in the LCA study .....	192
Table 3.58:	The sulphate process options considered in the LCA study .....	192
Table 3.59:	Other assumptions of the LCA study on TiO <sub>2</sub> manufacture .....	192
Table 3.60:	Feedstock process environment options discussed in the LCA study .....	193
Table 4.1:	Carbon black production capacity (1996) .....	203
Table 4.2:	Carbon black production: capacity, number of plants and location in Europe .....	204
Table 4.3:	Major world carbon black producers .....	204
Table 4.4:	Breakdown of total carbon black sales according to the fields of application .....	205
Table 4.5:	Permitted S-levels of north American and European carbon black plants .....	207
Table 4.6:	Manufacturing processes and feedstock used for the production of carbon black .....	208
Table 4.7:	Potential pollutants from the furnace black process and their origin .....	218
Table 4.8:	Typical ranges of carbon black tail-gas composition .....	219
Table 4.9:	Typical emission values of furnace black plants .....	221
Table 4.10:	Typical total electrical energy consumption for rubber black plants .....	223
Table 4.11:	Rough energy balance for a rubber black furnace plant .....	223
Table 4.12:	Information breakdown for each technique described in this section .....	225
Table 4.13:	Advantages and disadvantages of primary deNO <sub>x</sub> measures .....	228
Table 4.14:	Sulphur and nitrogen content of feedstock used in the carbon black industry .....	230
Table 4.15:	Actual annual average feedstock sulphur content of three carbon black plants .....	231
Table 4.16:	Tail-gas combustion control devices in Europe and the US .....	236
Table 4.17:	Summary of tail-gas combustion devices at carbon black plants in Europe .....	237
Table 4.18:	Summary of tail-gas combustion devices at carbon black plants in the US .....	237
Table 4.19:	Gross investment cost for flares, incinerators, boilers and CHP in the CB industry .....	238
Table 4.20:	Fabric filter characteristics .....	248
Table 4.21:	Advantages and disadvantages of dust-arresting techniques .....	249
Table 5.1:	Composition of typical synthetic amorphous pyrogenic silica .....	258
Table 5.2:	Composition of typical synthetic amorphous precipitated silica/silica gel .....	258
Table 5.3:	Production amounts of synthetic amorphous silica in the year 2000 .....	259
Table 5.4:	Locations of European producers of synthetic amorphous silica by product groups .....	259
Table 5.5:	Consumption of raw materials – synthetic amorphous pyrogenic silica .....	273
Table 5.6:	Energy consumption – synthetic amorphous pyrogenic silica .....	273
Table 5.7:	Emission concentrations and emission values – synthetic amorphous pyrogenic silica .....	273
Table 5.8:	Waste classification – synthetic amorphous pyrogenic silica .....	274
Table 5.9:	Packaging and energy recycling – synthetic amorphous pyrogenic silica .....	274

Table 5.10:	Raw materials demand – synthetic amorphous precipitated silica and silica gel .....	275
Table 5.11:	Energy consumption – synthetic amorphous precipitated silica and silica gel .....	275
Table 5.12:	Waste generation – synthetic amorphous precipitated silica and silica gel .....	275
Table 5.13:	Waste water generation – synthetic amorphous precipitated silica and silica gel .....	275
Table 5.14:	Dust emissions – synthetic amorphous precipitated silica and silica gel .....	276
Table 5.15:	Typical emission volumes – synthetic amorphous precipitated silica and silica gel .....	276
Table 5.16:	Emissions from firing units in the production of precipitated silica and silica gel .....	276
Table 5.17:	Information breakdown for each technique described in this section .....	278
Table 5.18:	Comparison of chlorine reduction options integrated within the process .....	279
Table 6.1:	Examples of technical products containing phosphorus .....	297
Table 6.2:	CEFIC data on West European STPP manufacturing capacities (2004) .....	298
Table 6.3:	Environmental aspects – STPP process: from green acid to orthophosphate solution .....	306
Table 6.4:	Environmental aspects – STPP process: from purified acid to orthophosphate solution .....	307
Table 6.5:	Environmental aspects – STPP process: from orthophosphate solution to dry STPP .....	307
Table 6.6:	Electricity consumption in the whole process based on the green acid route and the purified acid route (from the acid to dry STPP) .....	307
Table 6.7:	Consumption and emissions levels – green acid to orthophosphate solution .....	308
Table 6.8:	Consumption and emissions levels – purified acid to orthophosphate solution .....	308
Table 6.9:	Consumption and emissions levels – orthophosphate solution to dry STPP .....	309
Table 6.10:	Information breakdown for each technique described in this section .....	310
Table 6.11:	Techniques available for the orthophosphate solution concentration step .....	313
Table 6.12:	Characteristics of emission reduction techniques used in STPP plants .....	315
Table 6.13:	Estimated total European production capacities of feed phosphates .....	322
Table 6.14:	Consumption values – production of dicalcium phosphate from the phosphoric acid route .....	330
Table 6.15:	Emission values – production of dicalcium phosphate from the phosphoric acid route .....	330
Table 6.16:	Consumption values – production of dicalcium phosphate, hydrochloric acid route .....	331
Table 6.17:	Emission values – production of dicalcium phosphate, hydrochloric acid route .....	331
Table 7.1:	Aluminium fluoride capacities in 2003 by region .....	343
Table 7.2:	Consumption of raw materials and energy carriers .....	347
Table 7.3:	Emissions to air – dry fluorspar $\text{AlF}_3$ production process (2001) .....	347
Table 7.4:	Discharges to sea – dry fluorspar $\text{AlF}_3$ production process (2001) .....	347
Table 7.5:	Consumption of raw material and energy in the wet FSA process .....	348
Table 7.6:	Emissions to air from $\text{AlF}_3$ plant using the wet FSA process .....	348
Table 7.7:	Emissions to water from $\text{AlF}_3$ plant using the wet FSA process .....	349
Table 7.8:	Information breakdown for each technique described in this section .....	349
Table 7.9:	World calcium carbide production (kt per year) .....	356
Table 7.10:	Emission sources and typical dust emissions from the production of calcium carbide .....	359
Table 7.11:	Waste water emissions from the production of calcium carbide in Austria .....	360
Table 7.12:	1984 production of carbon disulphide worldwide .....	368
Table 7.13:	European carbon disulphide producers and production capacity .....	369
Table 7.14:	Major uses of ferrous chloride .....	376
Table 7.15:	Typical consumption and emission values in the manufacture of ferrous chloride .....	378
Table 7.16:	Major uses of ferrous sulphate heptahydrate (copperas) .....	380
Table 7.17:	Major European producers of ferrous sulphate heptahydrate .....	380
Table 7.18:	Typical consumption and emission values of for the manufacture of copperas .....	382
Table 7.19:	Major uses of ferrous sulphate monohydrate .....	384
Table 7.20:	Major European producers of ferrous sulphate monohydrate (excluding $\text{TiO}_2$ manufacture) .....	384
Table 7.21:	Consumption and emission values – ferrous sulphate monohydrate manufacture .....	385
Table 7.22:	Major uses of ferrous sulphate monohydrate .....	386
Table 7.23:	Major European producers of ferrous sulphate heptahydrate/ferrous sulphate monohydrate .....	387
Table 7.24:	Consumption and emission values – dried $\text{FeSO}_4 \cdot 7\text{H}_2\text{O}$ and $\text{FeSO}_4 \cdot \text{H}_2\text{O}$ .....	388
Table 7.25:	Major uses of ferric sulphate .....	389
Table 7.26:	Major European producers of ferric sulphate .....	389
Table 7.27:	Typical values for production of ferric sulphate using nitric and sulphuric acids .....	393
Table 7.28:	Typical values for the production of ferric sulphate using pressure oxidation .....	393
Table 7.29:	Typical values for the conversion of ferric sulphate solution to a solid $\text{Fe}_2(\text{SO}_4)_3$ product .....	394
Table 7.30:	Major European iron chlorosulphate producers .....	397
Table 7.31:	Typical consumption and emission values – production of iron chlorosulphate .....	398
Table 7.32:	Major use of iron oxide pigment .....	400
Table 7.33:	Major European iron oxide pigment producer .....	400

Table 7.34:	Consumption of energy and water for the overall iron oxide pigment plant .....	401
Table 7.35:	Typical emission values for the dehydration of copperas .....	401
Table 7.36:	Typical emission values for calcination .....	401
Table 7.37:	Consumption and emission values for the production of the iron oxide pigment .....	401
Table 7.38:	Common forms of lead oxide .....	404
Table 7.39:	Types of lead oxide commonly produced in the EU-15 .....	405
Table 7.40:	EU-15 consumption of lead for the manufacture of pigments and other compounds .....	406
Table 7.41:	Estimated EU-15 consumption of lead metal for 'free market' lead oxides .....	406
Table 7.42:	The main methods of solid waste treatment used in the lead oxide industry .....	415
Table 7.43:	Energy consumption per tonne lead of a typical lead oxide production plant .....	416
Table 7.44:	CO <sub>2</sub> emissions per tonne lead .....	416
Table 7.45:	European facilities for the production of different grades of magnesium oxide .....	423
Table 7.46:	Production of magnesia for the year 2000 in the rest of the world .....	424
Table 7.47:	Production capacity (kt/year) of the magnesia plant in the Netherlands in 2002 .....	424
Table 7.48:	Emissions to water – mean concentrations and mean yearly load (the Netherlands) .....	430
Table 7.49:	Locations of sodium silicate plants and capacities in Germany .....	436
Table 7.50:	Typical commercial sodium silicate solid glasses with a molar ratio of SiO <sub>2</sub> /Na <sub>2</sub> O ≥ 2 .....	437
Table 7.51:	Physical data of commercial sodium silicate solutions .....	438
Table 7.52:	Composition of the exhaust air – a site with a tank furnace and using natural gas .....	446
Table 7.53:	Emission concentrations in waste gas – a site with a tank furnace and using heavy oil .....	446
Table 7.54:	Emissions and concentrations of pollutants in exhaust air – revolving hearth furnace .....	449
Table 7.55:	Inputs and outputs in solid water glass production .....	450
Table 7.56:	Inputs and outputs in the production of Na-silicate by the hydrothermal route .....	450
Table 7.57:	Silicon carbide producers in Europe and assessed capacities of SiC plants .....	459
Table 7.58:	Specific emissions from the traditional furnace operation (Norwegian companies) .....	463
Table 7.59:	Specific emissions from the freiland furnace operation (Dutch company) .....	464
Table 7.60:	Sulphur content in the coke used at the three Norwegian plants (1993-2002) – showed in percentage .....	466
Table 7.61:	Physical and chemical properties of different types of zeolites .....	475
Table 7.62:	Zeolites production volumes in 2002 for European CEFIC members .....	476
Table 7.63:	Raw materials demand for the production of synthetic zeolites .....	481
Table 7.64:	Energy consumption in zeolites production .....	481
Table 7.65:	Releases of dust particulates during the production of zeolites .....	482
Table 7.66:	Waste water generation during the production of zeolites .....	482
Table 7.67:	World calcium chloride market – split by geographic location and production route .....	488
Table 7.68:	Calcium chloride European market by grades produced .....	488
Table 7.69:	Calcium chloride product grades .....	488
Table 7.70:	Raw material and energy inputs for calcium chloride liquor production .....	494
Table 7.71:	Energy use for calcium chloride solid production from concentrated liquor .....	494
Table 7.72:	Environmental impacts from the production of calcium chloride liquor .....	495
Table 7.73:	Environmental impacts from the production of solid calcium chloride .....	495
Table 7.74:	Consumption breakdown of PCC in Europe (reference year: 2002) .....	501
Table 7.75:	Production capacity of PCC by main world regions .....	502
Table 7.76:	EU-25 PCC capacity and producers (reference year: 2003) .....	503
Table 7.77:	Major input/output levels in the PCC production process .....	506
Table 7.78:	Western Europe sodium chlorate production sites (2002 data) .....	514
Table 7.79:	Overview of inputs and outputs in the sodium chlorate manufacturing processes .....	517
Table 7.80:	Electrical energy use in the electrolysis of sodium chlorate .....	518
Table 7.81:	Consumption and use of chemical auxiliaries in sodium chlorate plants .....	519
Table 7.82:	Sodium perborate uses in industrial sectors .....	529
Table 7.83:	Main raw materials used in the production of sodium perborate tetrahydrate .....	533
Table 7.84:	Sodium percarbonate usage for the year 2003 .....	545
Table 7.85:	Consumption of the main raw materials in the production of sodium percarbonate .....	550
Table 7.86:	The chemicals included in this section on sodium sulphite and related products .....	558
Table 7.87:	European manufacturing locations of sodium sulphite and related products .....	559
Table 7.88:	Raw materials usage in the production of sodium sulphite and related products .....	565
Table 7.89:	Energy balance by process – production of 'sulphites' .....	566
Table 7.90:	Summary of process emissions in 'sulphite' chemicals production .....	566
Table 7.91:	Production sites of zinc oxide in the EU-15 .....	575
Table 7.92:	Emissions to air per one tonne of ZnO produced by various process routes .....	582
Table 7.93:	Specific emissions to water per one tonne of ZnO produced by various process routes .....	582
Table 7.94:	Emissions of solid residues per one tonne of ZnO produced .....	583
Table 7.95:	Energy consumption per tonne of ZnO .....	583



---

Table 8.1:	The sources of emissions to air in the LVIC-S industry.....	595
Table 8.2:	Techniques for reducing emissions of inorganic chemical components to air .....	603
Table 8.3:	Techniques for reducing emissions to air in relation to waste gas flowrate .....	604
Table 8.4:	The sources of emissions to water in the LVIC-S industry .....	606

## SCOPE

### The scope of this document stems from Annex I to the Directive

The Large Volume Inorganic Chemicals – Solids and Others (LVIC-S) industry is a very close neighbour to the Chlor-alkali (CAK), Large Volume Inorganic Chemicals – Ammonia, Acids and Fertilisers (LVIC-AAF), and Specialty Inorganic Chemicals (SIC) industries.

A homogeneous and strictly defined industry Large Volume Inorganic Chemicals – Solids and Others (LVIC-S) does not really exist, and there is not a clear borderline between the above-mentioned four inorganic chemical industries. Therefore, it is to be expected that apart from obvious linkages, there will also be some duplication of material in the said four inorganic chemical industry BREFs (CAK, LVIC-AAF, LVIC-S, and SIC).

The scope of this document is broadly relevant to industrial activities covered in points 4.2.d and 4.2.e of Annex I to the IPPC Directive (96/61/EC):

4.2. Chemical installations for the production of basic inorganic chemicals, such as:

- (d) salts, such as ammonium chloride, potassium chlorate, potassium carbonate, sodium carbonate, perborate, silver nitrate
- (e) non-metals, metal oxides or other inorganic compounds such as calcium carbide, silicon, silicon carbide.

Annex I to the IPPC Directive does not give any threshold value of the capacity for chemical industry plants, neither does it define the concepts of ‘large volume’, ‘commodity’ and ‘cornerstone’ used in this document. However, the following criteria were adopted for the selection of the processes covered in this document:

- scale and economic importance of the production
- number of plants and their distribution in different Member States
- impact of a given industry on the environment
- accordance of the industrial activities with the structure of Annex I to the Directive
- representativeness for a wide range of technologies applied in the LVIC-S industry
- validated data and information on LVIC-S products sufficient to formulate ‘Techniques to consider in the determination of BAT’ and to draw BAT conclusions for the manufacture of these products.

### The list of products addressed in this document:

#### I. The five so-called cornerstone products:

- soda ash (sodium carbonate, including sodium bicarbonate)
- titanium dioxide (chloride and sulphate process routes)
- carbon black (rubber and speciality grades)
- synthetic amorphous silica (pyrogenic silica, precipitated silica, and silica gel)
- inorganic phosphates (detergent, food and feed phosphates).

A further 17 selected illustrative products (or groups of products) are addressed at a lesser level of detail.

### II. The 17 so-called selected illustrative products:

- aluminium fluoride
- calcium carbide
- carbon disulphide
- ferrous chloride
- copperas and related products
- lead oxide
- magnesium compounds
- sodium silicate
- silicon carbide
- zeolites
- calcium chloride
- precipitated calcium carbonate
- sodium chlorate
- sodium perborate
- sodium percarbonate
- sodium sulphite
- zinc oxide.

### **The structure of this document**

Because of the large number of products and processes involved, it is helpful to describe the structure of this document in the following manner:

Preliminary part: Executive Summary, Preface, Scope of the document
Generic part: Chapter 1 General description of LVIC-S industry, its potential, characteristics and interlinkages
Process part: Chapters 2, 3, 4, 5, and 6 Description of five cornerstone LVIC-S processes (Chapter 3, two TiO <sub>2</sub> process routes)
Process part: Chapter 7 Description of 17 selected illustrative LVIC-S groups of processes in one chapter
Generic part: Chapter 8 Common abatement measures applied in the LVIC-S industry
Emerging Techniques part: Chapter 9 Emerging Techniques in the LVIC-S industry
Final part: Chapter 10 Concluding Remarks
Supplementary part: References, Glossary, Annexes

The generic part of this document included in Chapter 1, illustrates the EU-15 (and where data available also the EU-25) chemical industry sector and from this perspective gives an insight into the potential, interlinkages and complexity of the European LVIC-S industry, based on examples which are illustrative for manufacturing processes of LVIC-S.

Detailed description in Chapters 2 through to 6 of the five LVIC-S cornerstone groups of processes is most important for the illustration of key characteristic features of the LVIC-S industry.

The description of selected illustrative LVIC-S processes, presented in Chapter 7, gives a further insight into the characteristics of the European LVIC-S industry.

Chapter 8 contains information on common abatement measures applied in the LVIC-S industry, considered illustrative for the sector, and the ways of reducing the impact of this industry on the environment. This chapter also contains Section 8.10 on BAT for environmental management.

Chapter 9 gives information on a few emerging techniques in the LVIC-S industry.

The Annexes provide additional relevant information to this sector, in particular Annex 3, which is closely related to Chapter 8 and describes good environmental practices in the LVIC-S industry (see Section 11.3).

It should be noted that, as compared to the original list, the number of selected illustrative products (groups of products) has been decreased from 33 to 17, mainly due to the fact that information on some of these was previously included in other sections of this document, or lacking. This is relevant to the LVIC-S products listed below:

- food and feed phosphates, addressed at the LVIC-S ‘cornerstone’ level in Chapter 6, as inorganic phosphates, jointly with detergent phosphates
- iron oxide and chorosulphate, addressed jointly in Section 7.5 on copperas and related products
- sodium hydrogen sulphite and sodium thiosulphate, addressed jointly in Section 7.16 on sodium sulphite and related products
- potassium chlorate – information not submitted, but the product ( $\text{KClO}_3$ ), KCl brine electrolysis process, and environmental impact have been referred to in Section 7.13 on sodium chlorate
- sodium sulphide – information not submitted.

The document ‘additional information submitted during the information exchange on LVIC-S industry’, accessible through the EIPPCB website, contains partial data and information at a different level of detail, closely related to this document. This information could not have been used to draw BAT conclusions for the LVIC-S industry, mainly due to the fact that the it was incomplete, lacking or submitted very late.

It was considered important not to lose this partial or incomplete information, as it may still be of some value for the LVIC-S Technical Working Group (TWG), the Member States, industry, operators and regulators in the EU, involved in the process of issuing integrated permits based on the IPPC Directive. It must be noted, however, that this document, will not be peer reviewed and information within it will neither be validated nor endorsed by the TWG on LVIC-S or the European Commission.

The list of the nine remaining ‘selected illustrative’ LVIC-S products addressed in this ‘Additional information...’ document include:

- |    |                     |   |
|----|---------------------|---|
| 1. | Aluminium chloride  | (not developed ‘techniques to consider...’)                               |
| 2. | Aluminium sulphate  | (not developed ‘techniques to consider...’)                               |
| 3. | Chromium compounds  | (partial information, far from being complete)                            |
| 4. | Ferric chloride (*) | (not developed ‘techniques to consider...’)                               |
| 5. | Potassium carbonate | (partial information, far from being complete)                            |
| 6. | Sodium sulphate     | (not developed ‘techniques to consider...’ for $\text{Na}_2\text{SO}_4$ ) |
| 7. | Zinc chloride       | (partial information, far from being complete)                            |
| 8. | Zinc sulphate       | (information submitted very late)   |
| 9. | Sodium bisulphate   | (information submitted very late).  |

(\*) Ferric chloride added later to the original list of 33 ‘selected illustrative’ LVIC-S products.

The ‘Additional information...’ document also includes a technique on purification of non-fertiliser grade wet phosphoric acid. This technique was excluded as it was not described in detail and it was not clear if it pertained to the LVIC-S or the LVIC-AAF sector. For example, phosphoric acid is typically purified at the site of acid production, but is not used for the production of fertilisers. In turn, purified phosphoric acid is used in the production of inorganic phosphates, but is not purified at the site.



# 1 GENERAL INFORMATION ON LARGE VOLUME INORGANIC CHEMICALS – SOLID AND OTHERS (LVIC-S) INDUSTRY

## 1.1 Overview of the European LVIC-S industry

In order to present an overview of the European LVIC-S industry, there is first a need to characterise the European chemical industry in general. This is done in Section 1.1.1 in which the European chemical industry in principle denotes the EU-15 chemical industry sector.

### 1.1.1 The European chemical industry sector

The EU chemical industry, taken as a whole, is a dynamic sector of the European economy, as on average it has a growth rate about 50 % higher than that of the EU economy as a whole. The EU chemical industry has also a growth rate about 75 % higher than the average for the total industry [9, CEFIC, 2004].

The dynamism of the chemical industry, however, derives not only from its capacity for growth but also from rapid technological change that is one of the industry's outstanding features.

The nature of chemical processes and the range of chemical products are subject to continuous change. Consequently, expenditure on RTD makes the chemical industry one of the most 'research-minded' of the industrial sectors.

The output of the chemical industry covers a wide range of chemical products and supplies virtually all sectors of the economy.

The extent to which chemical processes and products penetrate other sectors of the economy is in fact a measure of the significance of the chemical industry in economic development.

The well-developed EU chemical industry is both its own principal supplier and best customer. This is due to the processing chains that involve many intermediate steps in the transformation of chemicals.

A very large internal market and a high degree of export oriented production, favour development of the EU chemical industry.

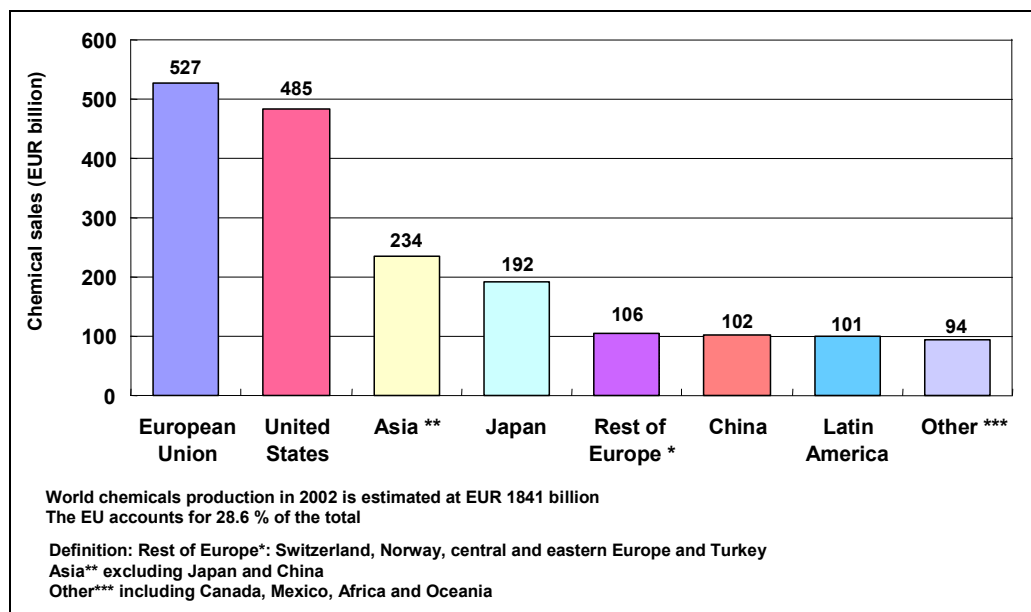
In particular, the manufacture of large volume chemicals in a highly competitive market is not only subject of the economy of scale (production of chemicals in large quantities at a low cost, owing to the scale of capacities applied), but is also much more efficient in highly integrated industrial complexes than in isolated plants.

The following sections illustrate the most characteristic features of the EU-15 chemical industry [9, CEFIC, 2004]. The information provided in Section 1.1.1.1 below is taken from the CEFIC web page. Since it changes from year to year, it is strongly recommended to visit the CEFIC web pages for updated information (<http://www.cefic.org/factsandfigures/>).

#### 1.1.1.1 Profile of the chemical industry

Geographic breakdown of world chemical sales illustrated below in Figure 1.1 indicates that the world production of chemicals in 2002 was estimated at EUR 1841000 million, and of that, the EU-15 with chemical sales of EUR 527000 million accounted for 28.6 % of the total.

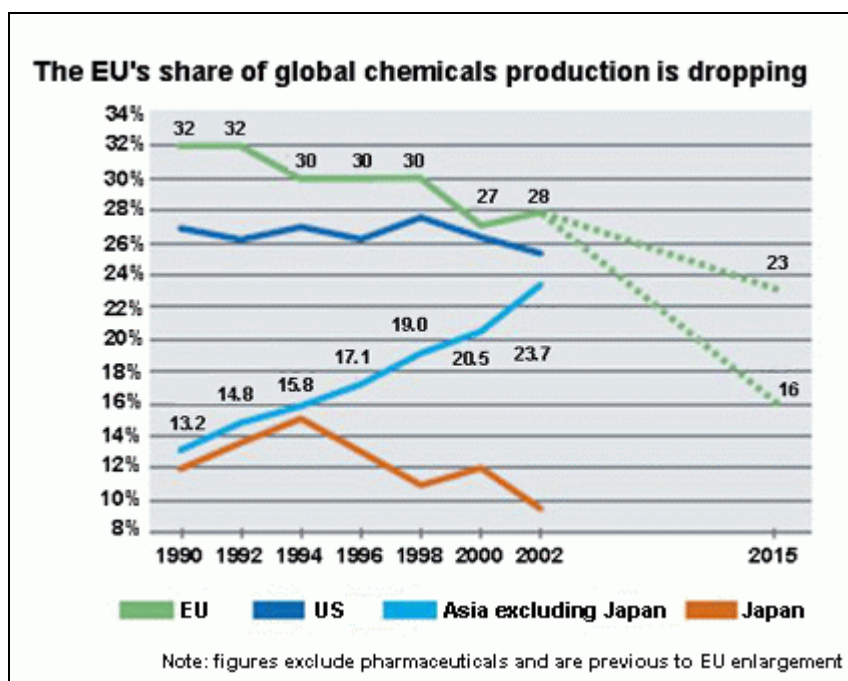
The rest of Europe (covering Switzerland, Norway, central and eastern Europe, and Turkey) with chemical sales of EUR 106000 million accounted for 5.7 % of the total.



**Figure 1.1: Geographic breakdown of world chemical sales**  
[9, CEFIC, 2004]

However, according to long term CEFIC scenarios, it is anticipated that by 2015 the European chemical industry will lose its global leadership [103, CEFIC, 2004], [104, CEFIC, 2004].

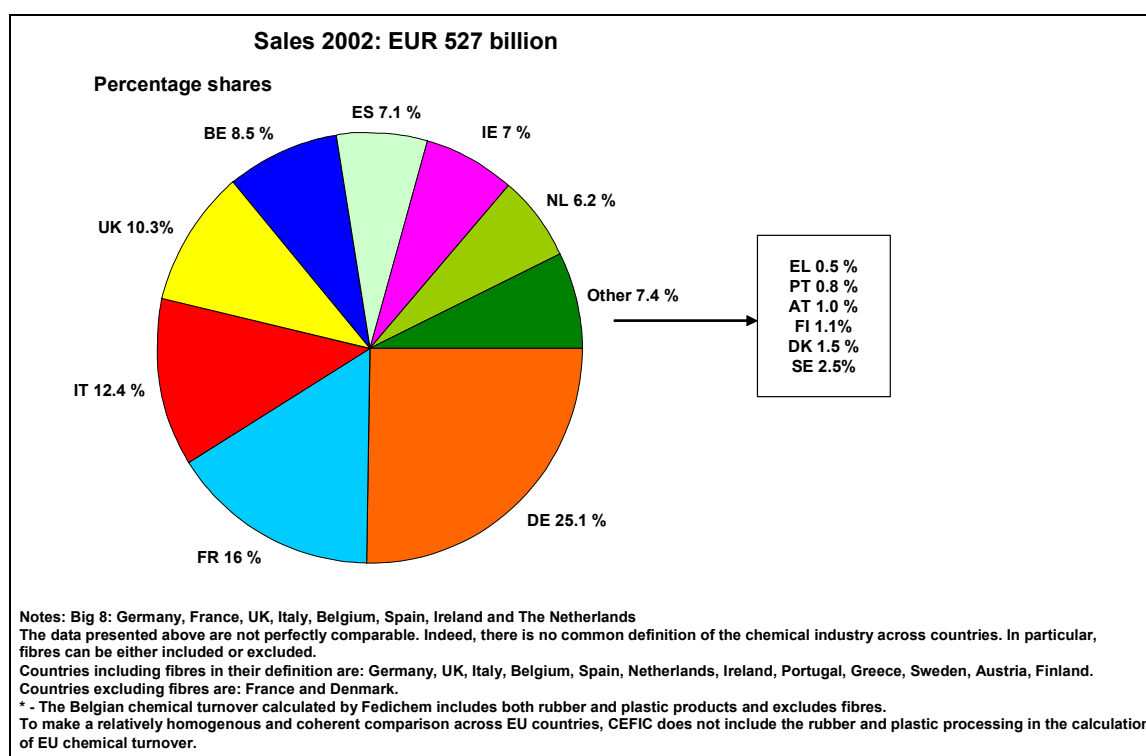
As illustrated in Figure 1.2, the EU's share of global chemicals production will be dropping dramatically from 32 % in 1992, through 28 % in 2002, to either 23 % (sunny scenario) or 16 % (stormy scenario) in 2015, largely reflecting the emergence of Asia as an economic power.



**Figure 1.2: The EU's share of global chemicals production is dropping**  
[103, CEFIC, 2004]

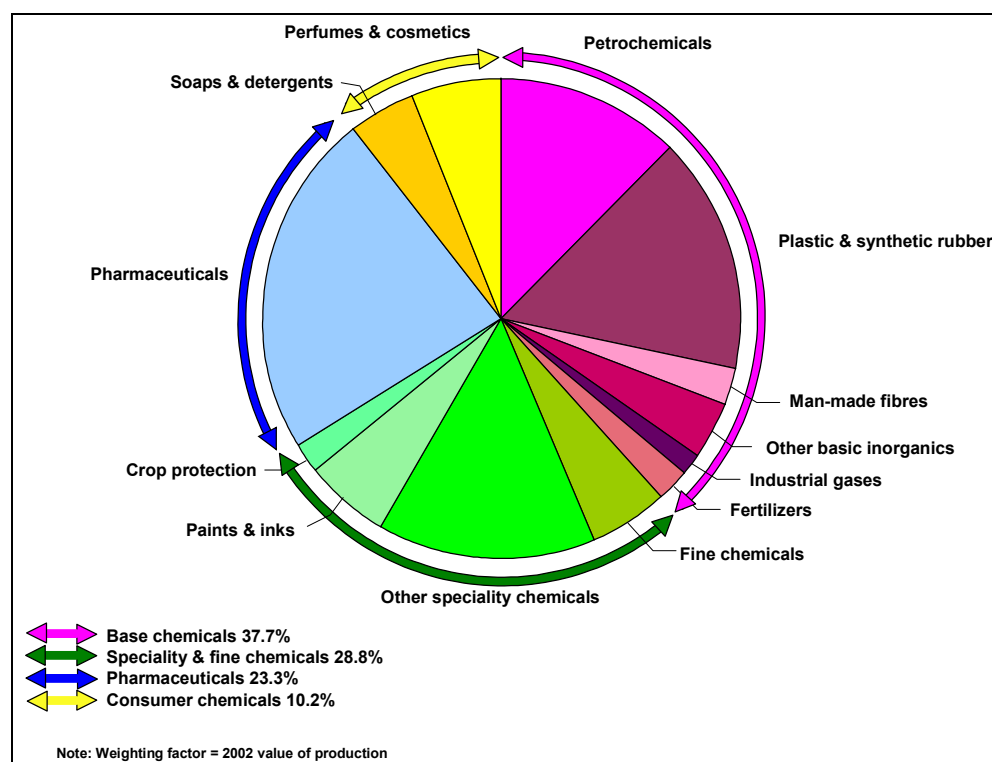
Whether the EU retains a significant share of the global chemical market by 2015 will largely depend on industry and European authorities acting together to take appropriate measures [103, CEFIC, 2004].

The geographic breakdown of EU chemical industry sales in 2002 (amounting to EUR 527000 million) is given in Figure 1.3.



**Figure 1.3: Geographic breakdown of EU chemical industry sales**  
 [9, CEFIC, 2004]

In turn, the breakdown of EU chemical industry sales by sector in 2002 is given in Figure 1.4, the shares of sales was: base chemicals – 37.7 %, speciality and fine chemicals - 28.8 %, pharmaceuticals – 23.3 %, and consumer chemicals – 10.2 %.



**Figure 1.4: Sectoral breakdown of EU chemical industry sales**  
 [9, CEFIC, 2004]



The analysis of the number of enterprises, value added, and employment in the EU indicates that even though the number of large enterprises (500 + employees) is limited, only 2 % of the total number of enterprises, added value and employment in large enterprises dominates in this group (approx. 55 % value added and 54 % employment).

When analysing the 30 top chemical companies in the world (in terms of 2002 sales), it can be seen that as many as 15 companies headquartered in the EU are present on the list (with the total sales of EUR 194000 million, and with the share of the total world chemical sales of 15 %). This reflects that larger chemical companies, operated in integrated industrial complexes, utilise the economy of scale in their plants.

As given in Table 1.1, out of the 30 top chemical companies in the world, the largest EU headquartered companies in terms of 2002 worldwide sales are:

EU-15 ranking list	Worldwide ranking list	EU-15 headquartered chemical company	2002 worldwide sales (in EUR million)
1	1	BASF	32216
2	2	Bayer	29624
3	6	Atofina	19672
4	8	Akzo Nobel	14002
5	9	BP	13236
6	10	Shell	12160
7	11	Degussa	11765
8	13	ICI	9740
9	17	Linde	8726
10	22	Solvay	7918
11	23	Air Liquide	7900
12	24	Merck KgaA	7473
13	28	DSM	6665
14	29	Rhodia	6617
15	30	Basell	6500

**Table 1.1: List of the 15 largest EU-15 chemical companies, ranked in the worldwide scale [9, CEFIC, 2004]**

The above list of the 15 largest EU-15 chemical companies, ranked in the worldwide scale, illustrates the very great industrial potential of the EU chemical industry sector. Indeed, the three largest top US based companies (Dow Chemical, Du Pont, and Exxon Mobil) are smaller than EU headquartered BASF and Bayer and larger only than Atofina (third largest company in the EU), ranked sixth on the list of the 30 top chemical companies in the world.

### 1.1.1.2 International trade

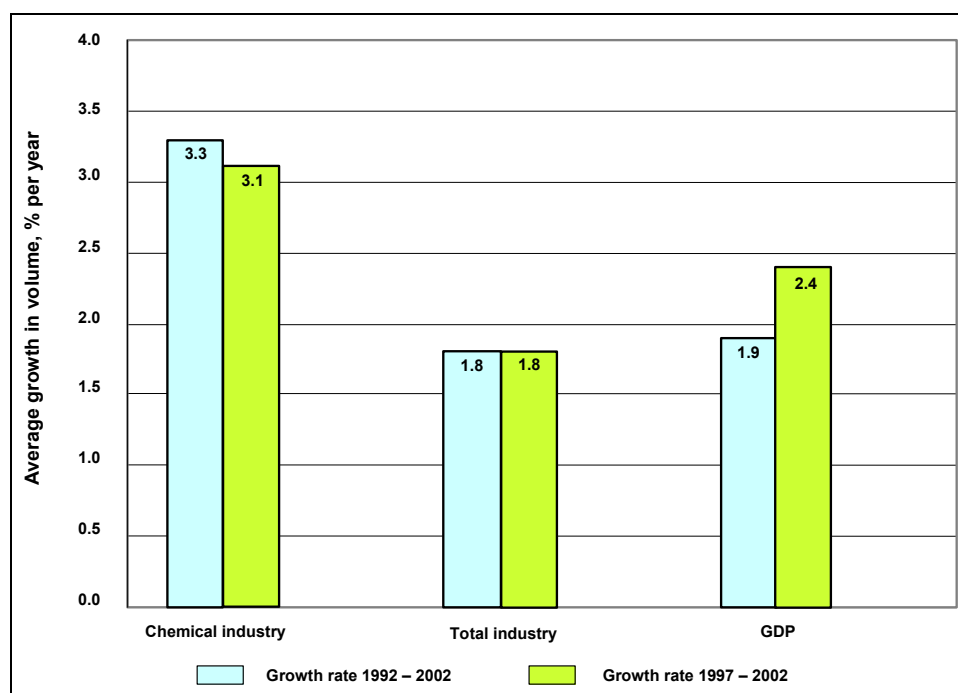
The estimated 2002 regional shares in world trade in chemicals illustrate the EU leadership in the world scale, the EU share in world exports amounting to 55.3 % and the share in imports 45.6 %. These shares are over three times larger than those for North America and six times larger than those for the rest of Europe.

The EU chemicals trade balance 2002 between extra-EU exports and extra-EU imports (intra-EU trade excluded) amounted to EUR 70000 million.

### 1.1.1.3 Growth of the chemical industry

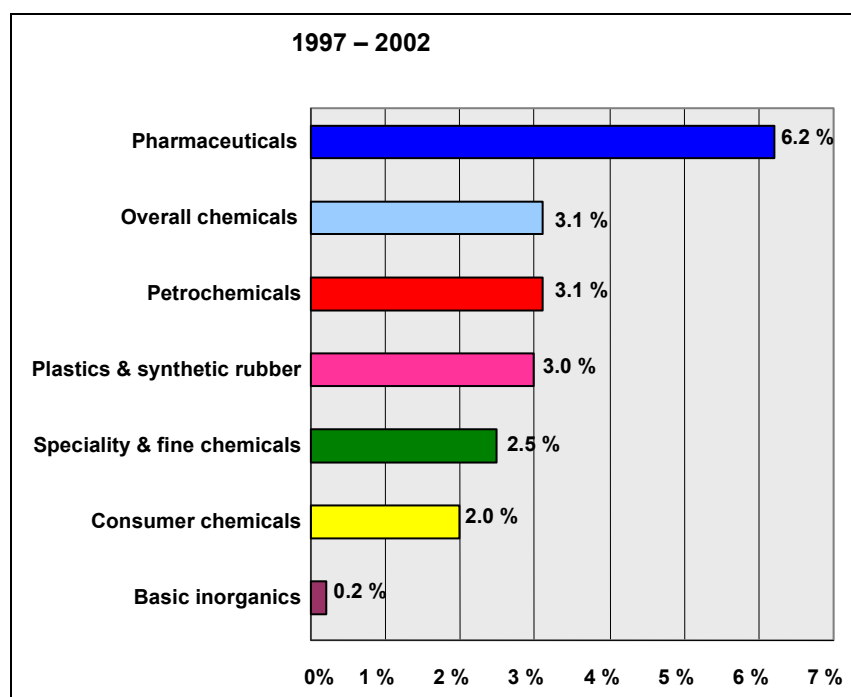
Average growth rates 1992 – 2002 (in terms of value, % per year), respectively of EU chemical production (4.7 %), exports (11.4 %) and imports (10.1 %), are the confirmation of the strength of the chemical industry sector in the European Union.

This is seen in Figure 1.5, when comparing average growth rates 1992 – 2002 in production volume of the chemical industry (3.3 %), with total industry (1.8 %) and GDP (1.9 %).



**Figure 1.5: Growth of EU chemical production, total industry and GDP**  
[9, CEFIC, 2004]

When production growth 1997 – 2002 of the EU chemical industry (3.1 %) is compared by sector, the pharmaceuticals sector is the leader (6.2 %), speciality and fine chemicals (2.5 %), consumer chemicals (2 %), while the production growth of the basic inorganics sector is the least dynamic (0.2 %). The sectoral breakdown of production growth 1997 – 2002 of the EU chemical industry is given in Figure 1.6 below.



**Figure 1.6: Production growth of the EU-15 chemical industry by sector**  
[9, CEFIC, 2004]

When the international growth rate 1997 – 2002 comparison of production is analysed against the growth rate of the total industry, the Netherlands, United Kingdom and Belgium are the leaders, as they are characterised by the highest gaps between these growth rates.

International comparison of production growth of the chemical industry between 1992 – 2002 gives the following values of average growth per year: EU (3.3 %), US (2 %), and Japan (1.4 %).

### 1.1.1.4 Costs and prices

The cost structure of the EU chemical industry is illustrated in detail in [9, CEFIC, 2004].

As compared to the growth of overall consumer prices for the EU in the period 1990 – 2002, which raised up to 140, chemicals producer prices raised only up to 111 (1990 = 100).

In turn, when comparing labour cost per employee and productivity in the EU chemical industry for the period 1990 – 2002 (1990 = 100), the labour cost index has grown to 164, and that of productivity up to 160, thus keeping the unit labour cost index at a level of 103.

### 1.1.1.5 Energy

The EU chemical industry energy consumption by source is illustrated in Figure 1.7.

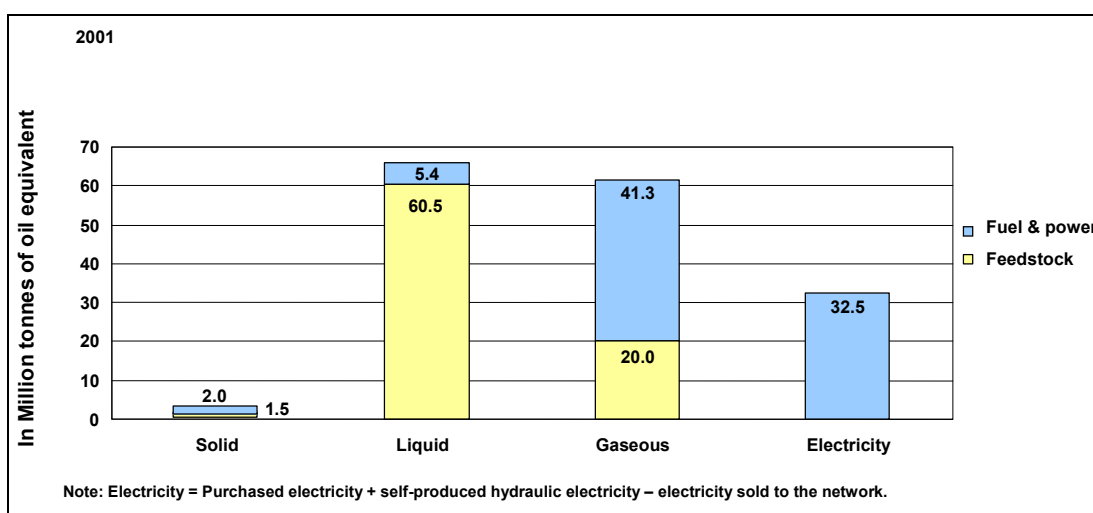


Figure 1.7: EU chemical industry energy consumption by source [9, CEFIC, 2004]

Liquid sources of energy (followed by gaseous sources) are mostly used as feedstock in the EU chemical industry sector, while gaseous sources of energy and electricity are major sources of fuel and power.

Energy efficiency in the EU chemical industry for the years 1975 – 2001 is given in Figure 1.8. The peak oil price in 1980 (index 1980 = 100) is taken as a basis for the comparison of energy efficiency (understood here as energy consumption per unit of production).

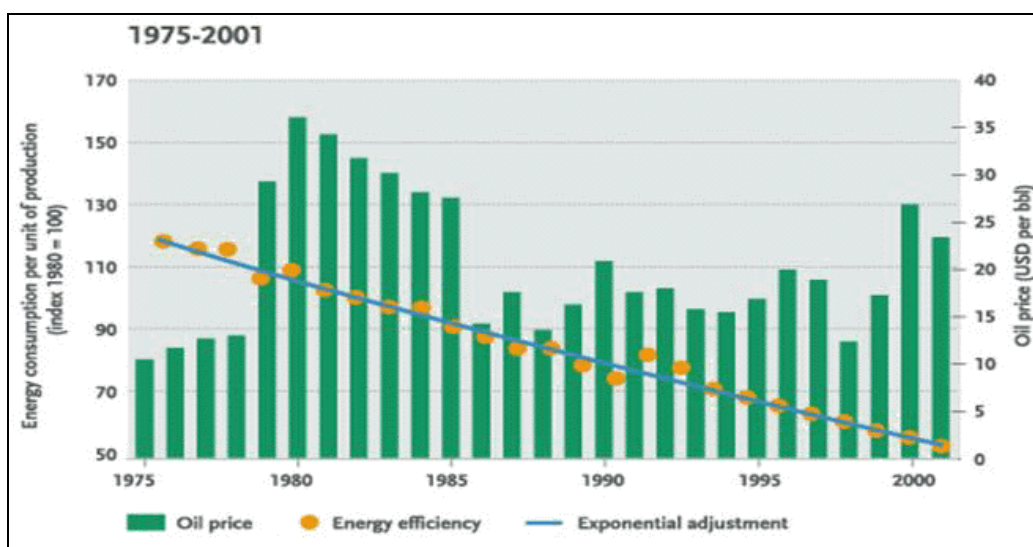


Figure 1.8: Energy efficiency in the EU chemical industry [9, CEFIC, 2004]

The progress made in the EU chemical industry in more efficient use of energy would not have been possible without making the necessary investments to achieve these results.

#### 1.1.1.6 Employment

When comparing the production and employment indexes of 1990 (index 1990 = 100), with those of 2002 (144 for production and 84 for employment), one can estimate the progress made in the EU chemical industry in the increase of productivity and rationalisation of employment.

This progress is also prompted by relatively high personnel costs in the EU chemical industry - on average much higher than those in other manufacturing sectors.

#### 1.1.1.7 Investment and R&D

In the period 1992 – 2002, the EU chemical industry spent on average approx. EUR 20000 - 25000 million of capital per year. Investment/sales ratio in 1992 reached 6.5 %, and in 2002 (with the investment of EUR 25000 million), was still as high as 5 %. In turn, chemical industry R&D expenditure in relation to sales is illustrated in Figure 1.9.

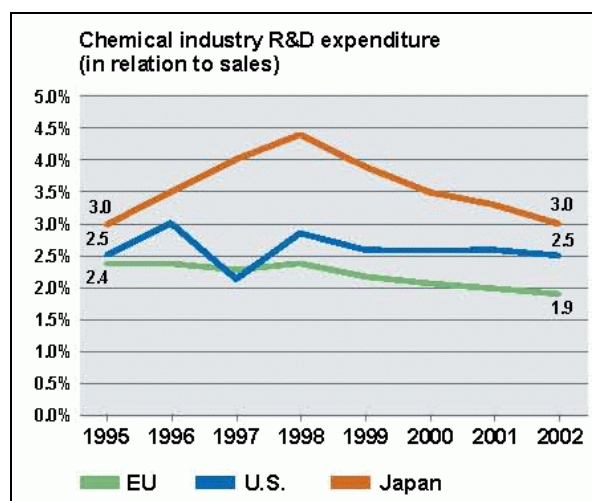


Figure 1.9: EU's chemical industry R&D expenditure [103, CEFIC, 2004]

Research and development spending by the chemical sector in the EU, amounting to 2.4 % in 1995 and 1.9 % in 2002, compares unfavourably with other regions in this period (Japan 3.0 % and the US 2.5 %). At the same time, the number of students graduating in chemical related disciplines in Europe was decreasing quickly [103, CEFIC, 2004].

### 1.1.1.8 Sustainable development

Four key indicators of sustainable development in the EU chemical industry sector are shown below:

1. CO<sub>2</sub> emissions, energy consumption and production, given in Figure 1.10.

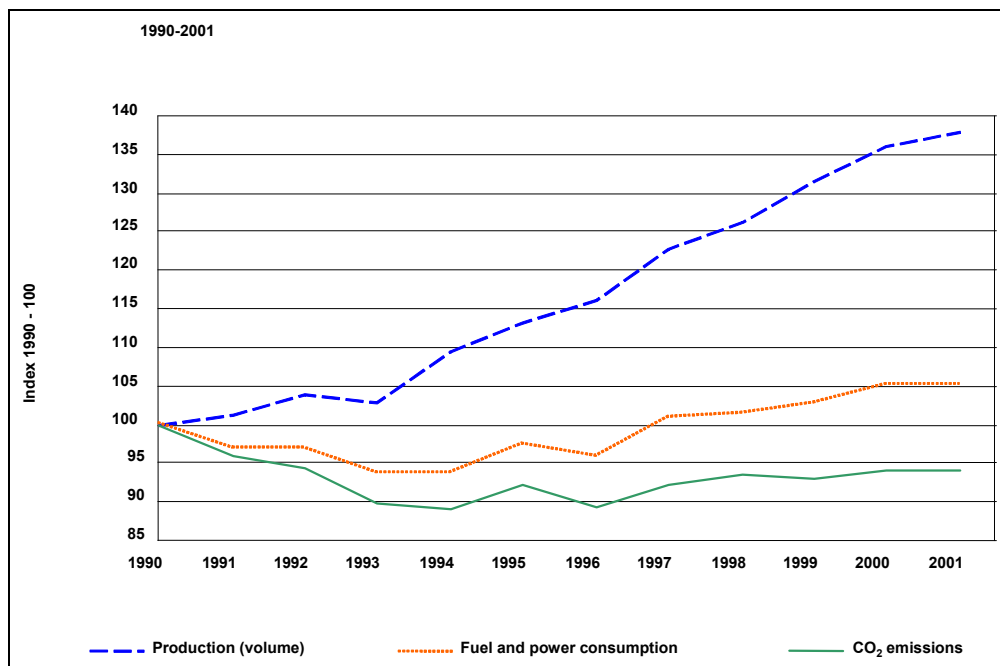


Figure 1.10: CO<sub>2</sub> emissions, energy consumption and production from the EU chemical industry [9, CEFIC, 2004]

2. CO<sub>2</sub> emissions per unit of energy consumption and per unit of production, given in Figure 1.11.

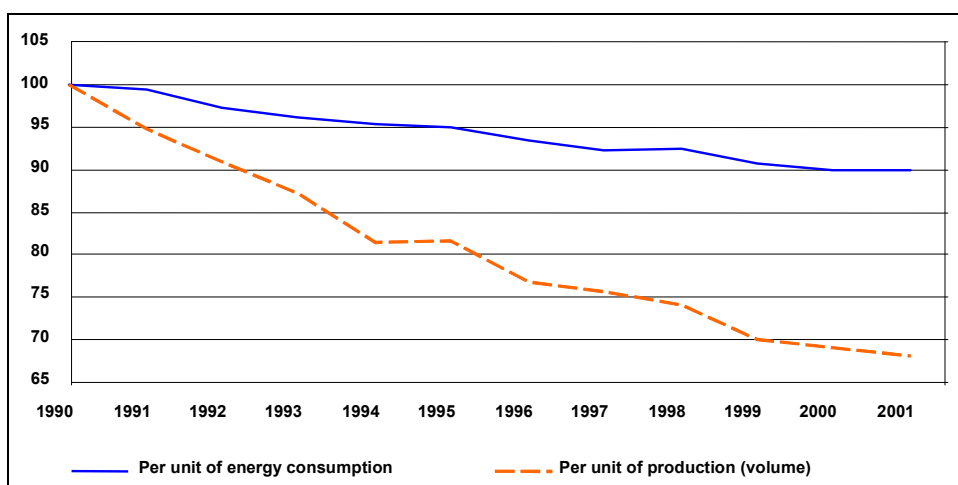


Figure 1.11: Specific CO<sub>2</sub> emissions figures from EU chemical industry [9, CEFIC, 2004]

3. Greenhouse gas emissions targets for 2010 are illustrated in Figure 1.12.

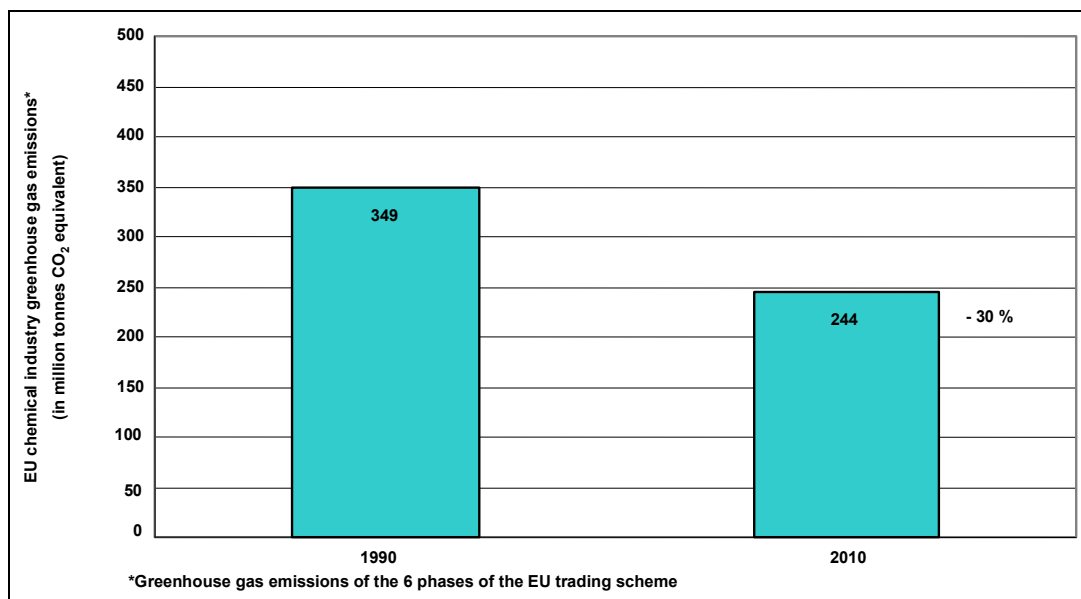


Figure 1.12: Greenhouse gas emissions from the EU chemical industry [9, CEFIC, 2004]

4. Emissions to water and air, and performance in 2001 are given in Figure 1.13.

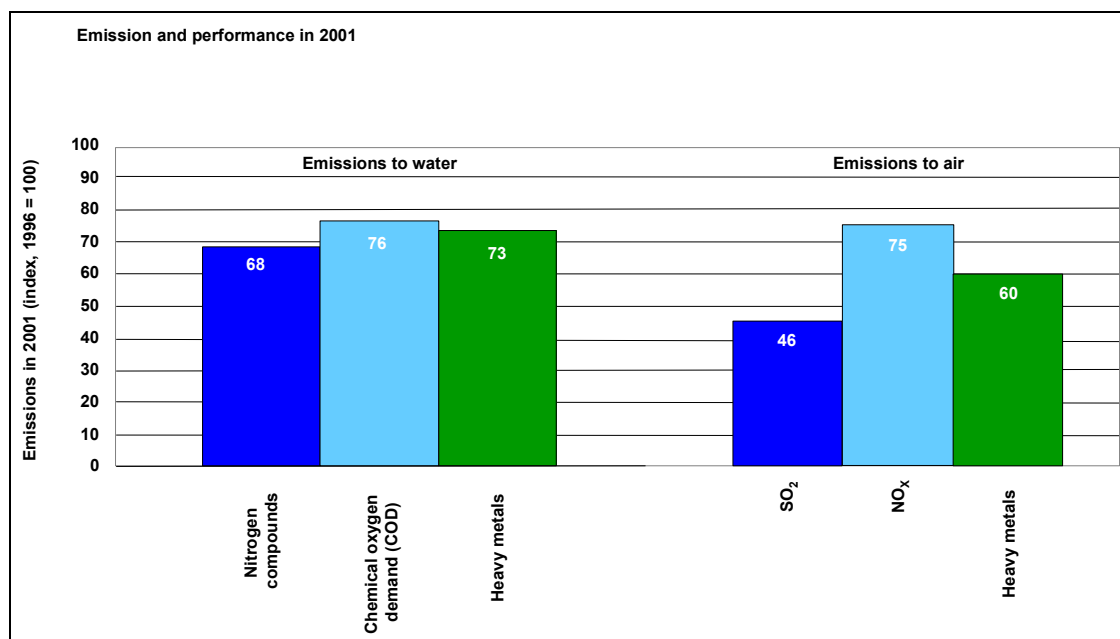


Figure 1.13: Emissions and performance from the EU chemical industry [9, CEFIC, 2004]

### 1.1.2 Inorganic compounds

The definition of 'inorganic' in most recognised dictionaries, formally describes 'inorganic' as relating to or denoting chemical compounds that do not contain carbon. However, this strict definition is not to be applied in this document, as there are many common inorganic chemical compounds containing carbon and several of them are included in this document, for example:

- carbon black (C)
- calcium carbide ( $\text{CaC}_2$ )
- calcium carbonate ( $\text{CaCO}_3$ )
- carbon disulphide ( $\text{CS}_2$ )
- silicon carbide ( $\text{SiC}$ )
- soda ash ( $\text{Na}_2\text{CO}_3$ )
- sodium bicarbonate ( $\text{NaHCO}_3$ )
- sodium percarbonate ( $\text{Na}_2\text{CO}_3 \cdot 1.5\text{H}_2\text{O}_2$ ).

A short description of inorganic compounds is given in Annex 1 – Basic classes of inorganic compounds [27, N.L. Glinka, 1981], focusing in particular on inorganic acids and salts derived from them, that are most characteristic for the LVIC-S industry (refer also to the Glossary of terms and abbreviations). The information included below completes this short description.

The field of industrial chemistry is broadly subdivided into inorganic and organic chemistry. Inorganic chemistry deals with all elements of the periodic table; organic chemistry is restricted to the element carbon in its association with a limited number of other elements.

It should be noted, that despite the limited number of elements involved in organic chemistry, there were about 16 million known organic compounds as opposed to only 1 – 2 million inorganic compounds at the end of 1996.

The natural sources for the industrial manufacture of inorganic products are numerous, ranging from air and water via sulphur, phosphates, mineral salts, metal oxides, and various inorganic ores. As opposed to the diversified inorganic raw materials base, the manufacturing of inorganic chemicals usually requires a few steps of operations, whereas productions of organic chemicals are often multi-step operations [71, CITEPA, 1997], [13, EIPPCB, 2000].

### 1.1.3 Characteristics of the LVIC-S industry

The following 11 points are the most typical characteristics of the LVIC-S industry:

1. Medium to large levels of installed capacities and substantial production outlets of commodity products from the plant, ranging from the capacities of approximately 5 kt up to 500 kt per year in one plant.

Example: the production of soda ash by the Solvay process route – typical capacity of some 500 kt per year, ranging from 160 kt up to 1200 kt per year.

2. In the majority of cases, with some exceptions, mature processes and older installations with a limited possibility for changes in well known processes, still however have some degree of freedom for changes in unit operations (e.g. crystallisation, filtration, drying) applied and used for environmental protection (e.g. dedusting).

Example: production processes of inorganic solid chemical compounds and salts.

- Capital intensity, highly subject to the economies of scale, both in terms of specific investment for a given inorganic product and for an LVIC-S production complex.

Example: the production of titanium dioxide by the sulphate and chloride routes.

- High energy requirements for certain products, and relatively high energy requirements at the site, involving a supply of energy from the associated power plant.

Example: production of calcium carbide.

- Substantial infrastructure involved in a typical inorganic chemical complex comprising: energy supply; raw materials supply; quality (physical properties and chemical purity) check and preparation; inorganic chemical synthesis processes; purification of products; storage and handling of products; as well as environmental protection and waste disposal units – see Figure 1.14.

Example: an inorganic chemical complex for the production of pure phosphoric acid, feed phosphates and sodium tripolyphosphate for detergent-grade phosphates.

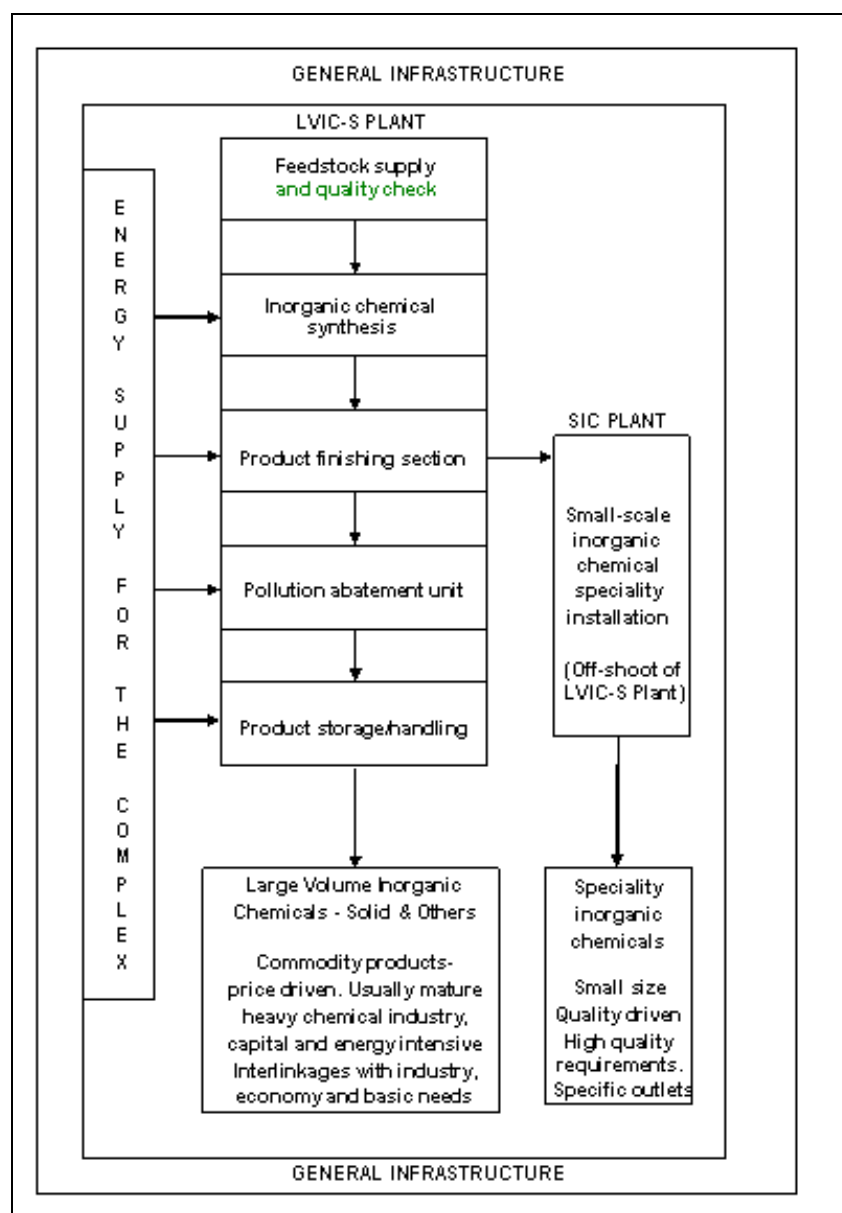


Figure 1.14: Inorganic chemical complex with a boundary between LVIC-S and SIC plants  
Based on [6, CEFIC, 2002]



6. Diversified chains of production processes used jointly in integrated inorganic chemical complexes, thus allowing an heterogeneity of products and viability of production which is highly dependent on an integrated approach and economic outlets for co- and by-products to be obtained.

Example: integrated soda ash complex leading to soda family products, as illustrated in Figure 1.15.

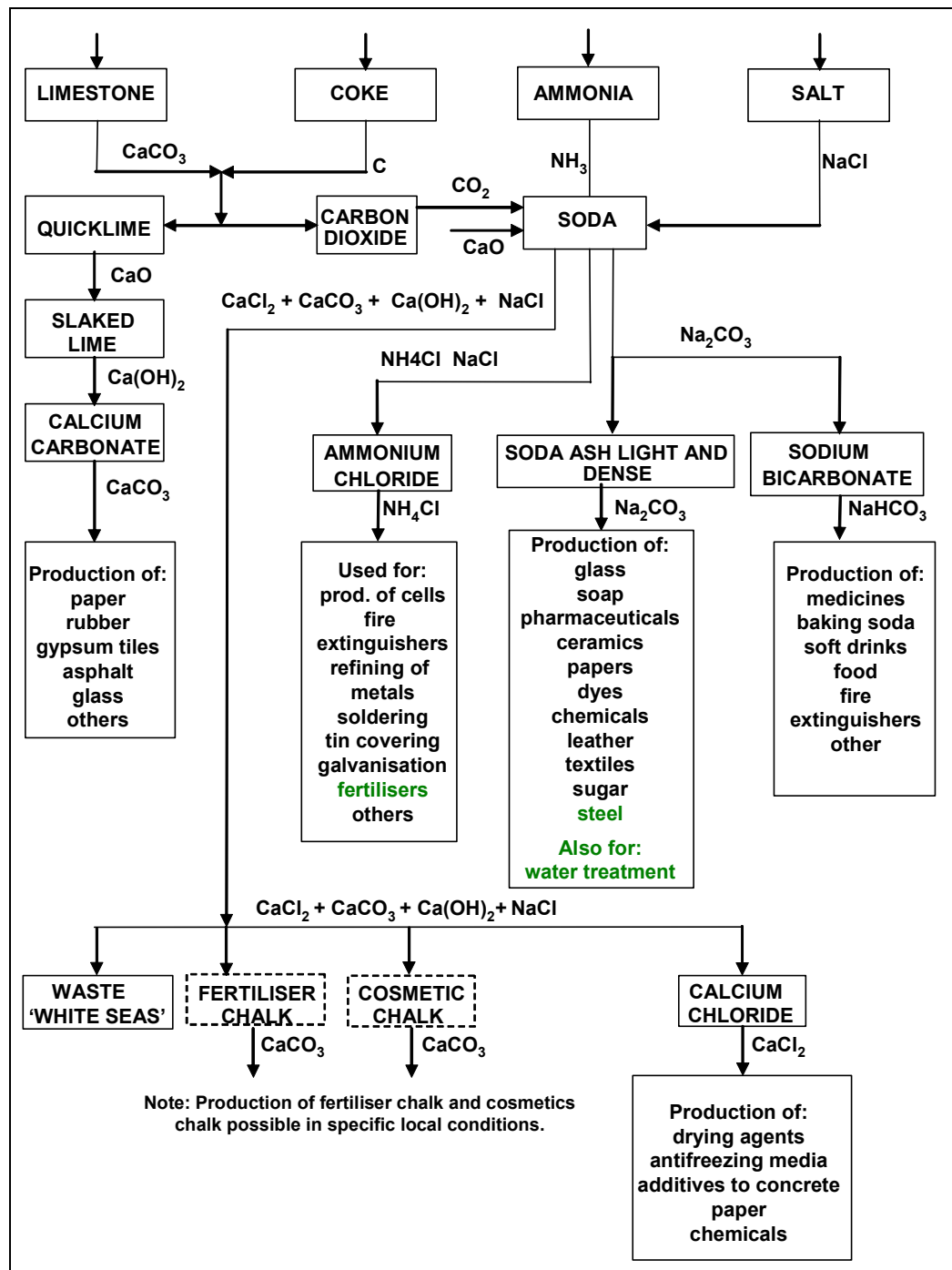


Figure 1.15: Integrated soda ash complex leading to soda family products  
Based on [82, UNIDO, 1988]

7. Close upstream linkages of large volume inorganic chemicals to inorganic ores and basic inorganic raw materials, and downstream interlinkages to chemical industries and other sectors of the economy – see Figure 1.16.

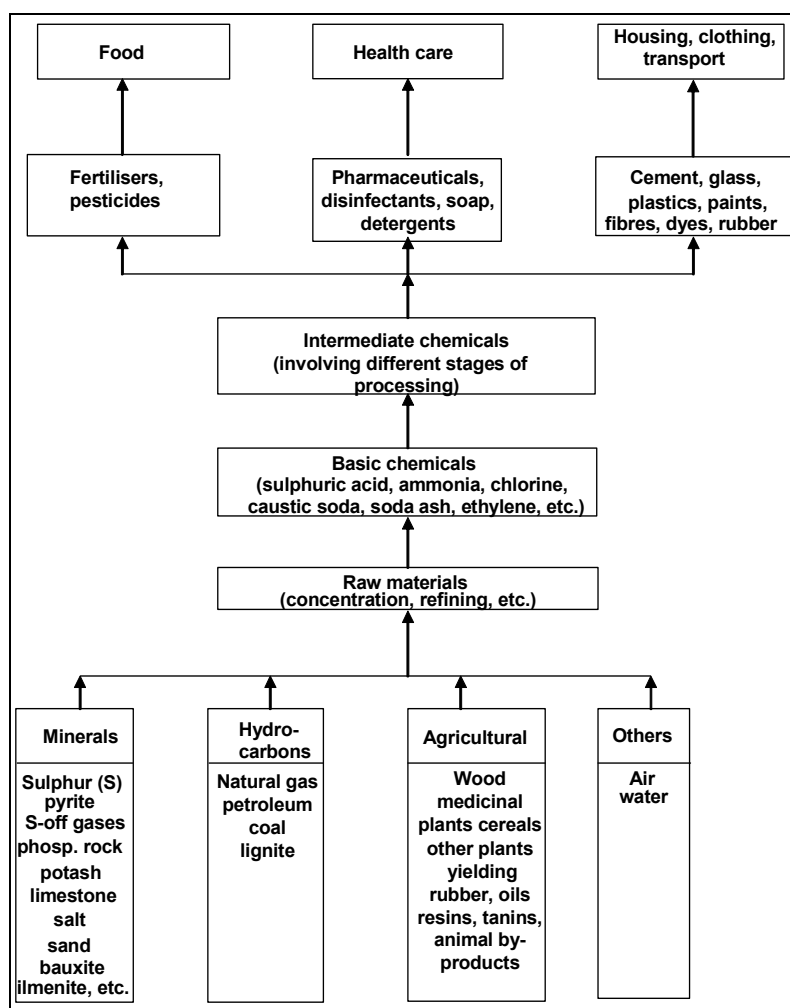


Figure 1.16: Interlinkage of chemical process industries with basic needs  
Based on [28, UNIDO, 1982]

8. It should be noted that some of the criteria characteristic to the chemical industry sector such as: alternative processes and alternative feedstock for the production of the same product (e.g. carbon black, aluminium fluoride), as well as complex technology involving multistage processing (e.g. titanium dioxide), in several cases also apply to the LVIC-S industry.
9. Other characteristics of the LVIC-S industry include, but are not limited to, the following features:
  - high purity of raw materials is of primary importance to attain the required purity of the final product and reduce possible emissions. This needs to be achieved by an integrated approach to the chain of steps involved in ore mining, beneficiation and pretreatment, before the raw materials are used in the LVIC-S industry
  - many reactions take place at high temperatures, in several cases above 800 °C and in a few cases more than 2000 °C (e.g. calcium carbide, silicon carbide) often with carbon (e.g. coal, coke, charcoal) being used as a reducing agent
  - many LVIC-S products are obtained by their crystallisation from an aqueous solution and with subsequent drying to remove the free and/or combined water (e.g. sodium bicarbonate, calcium chloride, precipitated calcium carbonate)
  - the LVIC-S plants are typically equipped with the storage and handling systems of solid substances. Although miscellaneous techniques are used, the potential for dust emissions is common.

10. One of the distinct characteristics of LVIC-S plants is their linkage to SIC installations. Small scale SIC installations are often offshoots of LVIC-S plants, the boundary being usually located in the product purification section of an LVIC-S installation, with the shares of final products typically well over 95 % for large volume inorganic commodity products and much below 5 % for speciality inorganic products – see Figure 1.14 above.

Additional criteria for the selection between the LVIC and SIC industries are given below in Table 1.2:

Criterion	LVIC	SIC
Volume*	Usually high	Usually low
Size of investment	Very high	Medium
Product description	Formula	Formula + effect, purity, formulation
Product differentiation from competition	Not usually	Yes – often the speciality is sold on performance
Applications	Often large number of applications or very high volume applications	Often only a few applications or highly specialised
Driver	Price	Quality
Raw material	Often a mineral	Often a chemical to be reprocessed and refined
R&D	To improve the economics of the process	To create new tailored applications
Integration	Vertical, possibly with the source of mineral	Often on an LVIC site as a complementary production
Which department of the customer makes the buying decision	The purchasing department	The technical/production staff

\* UBA: suggested 100 kt limit

**Table 1.2: Criteria for the selection between the LVIC and SIC industries [98, CEFIC, 2003]**

11. Finally, it should be stressed that the overall energy efficiency in the integrated inorganic chemical complex depends not only on the efficiency of chemical processes used, but also (and in several cases predominantly) on the energy efficiency in the associated power plant at the site.

Increased energy efficiency in the integrated inorganic chemical complex is particularly relevant to the cogeneration of heat and power in CHP systems, as stems from the Council Directive 2004/8/EC of 11 February 2004 on the promotion of cogeneration based on a useful heat demand in the internal energy market [86, The Council of the EU, 2004]. Refer also to Section 1.4.3 below.

#### **1.1.4 Cornerstone and selected illustrative products in the scope of this document**

As mentioned in the Scope section, the list of chemicals included in this document embraces five cornerstone and 17 selected illustrative products (groups of products) addressed at a lesser level of detail.

The scale of production in the LVIC-S industry, including the distribution of cornerstone plants across the EU, is illustrated in Section 1.1.5.

#### 1.1.4.1 Main affiliations between compounds within the LVIC-S industry

A few ores and natural substances are precursors of a large variety of LVIC-S compounds. For example:

Phosphate rock	Sodium phosphates (e.g. detergent phosphates) Food and feed phosphates
Sodium chloride	Sodium chlorate, Sodium sulphates
Sodium chloride Limestone	Sodium bicarbonate Soda ash Calcium chloride
Sand	Sodium silicate Silicon carbide

Aluminium oxide and hydroxide produced directly from bauxite are the precursors of most aluminium LVIC-S derivatives (e.g. aluminium fluoride, aluminium sulphate).

Conversely, some ores and natural substances are essentially used to manufacture only one LVIC-S product. For example:

Ilmenite	Titanium dioxide
Borax	Sodium perborate

#### 1.1.4.2 Main uses

A few products only find application in goods directly sold to the public. Typically, most of the LVIC-S compounds have industrial applications only, essentially as:

- primary raw materials for products of the same family (e.g. soda ash, feedstock for sodium silicate production)
- primary raw materials for producing other chemicals (e.g. zinc sulphate for producing the pigment called lithopone)
- primary raw materials for other industrial sectors (e.g. titanium dioxide for paper mills)
- primary raw materials to formulate consumer goods (zeolites for producing detergents).

#### 1.1.4.3 Economic aspects

Even though the LVIC-S industry is one of the pillars of several dynamically developing European chemical industry sectors, it is also characterised by the lowest production growth: 0.2 % for basic inorganic sector in 1997 – 2002, as compared to the production growth of the EU chemical industry sector totalling to 3.1 % [9, CEFIC, 2004].

A number of LVIC-S compounds, including nearly all LVIC-S cornerstones, are basic commodity products and intermediates, in most cases traded on a worldwide basis, and therefore being subject to international pricing and competition [6, CEFIC, 2002].

Their main raw materials are also large volume and traded worldwide. As a consequence, to utilise the economy of scale in the manufacturing processes, production units usually tend to be very large, and fully automated, with high investment cost and highly skilled operators.

Stemming from the above, the following major economic constraints and enhancements are reported for the LVIC-S industry [6, CEFIC, 2002]:

- like for other commodity organic or inorganic products, international prices are subject to wide variations (up to EUR 2 per kg in the case of TiO<sub>2</sub> products). However, a typical price level of an LVIC-S product is EUR 0.2 per kg and the variable costs (raw material, energy and other utilities) usually represent 60 to 80 % of the product's factory gate price. This makes investment into a new plant somewhat unattractive because of low potential return on investment (ROI) [6, CEFIC, 2002]
- investment in an inorganic chemical plant is, however, very high and the plants are usually designed for a long life and are not renewed in the short term. Investment costs are often in the EUR 200 to 800 million range for a standard world scale new grassroots LVIC-S plant. Since there are very few new plants and inorganic chemical complexes in Europe, the existing plants have to be revamped to keep pace with technical progress and environmental standards
- this, in turn, raises the initial investment by above 10 – 20 %, which some plants cannot afford. As a result, plant closures have taken place
- but, in turn, market niches also exist for some special grade LVIC-S products, since their technical and economic aspects differ greatly from those of commodities (more sophisticated production processes, tighter selection of feedstock, smaller production volumes, higher and less fluctuating market prices, etc.). Typical examples are sodium bicarbonate (refer to Chapter 2), speciality carbon blacks (refer to Chapter 4) or precipitated calcium carbonate (refer to Section 7.12), where special grades have been developed for specific applications [6, CEFIC, 2002].

### 1.1.5 Production scale in the European LVIC-S industry

For a majority of compounds within the LVIC-S industry, the current tendency is to reduce the number of production sites rather than increase global European capacity and invest into new production units. This tendency is broadly concurrent with the most characteristic features of the EU chemical industry illustrated above [9, CEFIC, 2004].

The illustration of the scale of production in the LVIC-S industry is mainly based on available information relevant to the cornerstone processes within the EU-15 area, included in Chapters 2 through to 6 of this document. When available, information concerning the LVIC-S industry in the new Member States has been included as well – see Figure 1.17.

#### 1.1.5.1 Soda ash

There are 14 plants in nine of the EU-25 Member States producing soda ash based on the Solvay process, with a total capacity of 7725 kt per year, which represents approximately 18 % of world ash capacities [33, CEFIC-ESAPA, 2004].

The range of capacities per plant vary from 160 to 1020 kt per year, i.e. approximately from 440 to 2800 tonnes per day (assumed onstream factor of 360 operational days per year).

#### 1.1.5.2 Titanium dioxide

The present EU-25 (plus Norway) TiO<sub>2</sub> production capacities, amounting to 1488 kt per year, are split approximately as 69 % for the sulphate process (1023 kt per year) and 31 % for the chloride process (465 kt per year), and represent roughly 37 % of the world's TiO<sub>2</sub> capacities [20, CEFIC-TDMA, 2004], [13, EIPPCB, 2000].

There are 11 EU-25 Member States (plus Norway) producing titanium dioxide in 20 plants located across the EU-25 (plus Norway), and from this plants five are based on the chloride and 15 plants on the sulphate titanium dioxide process route.

The range of capacities per plant in the chloride process route vary from 55 to 150 kt per year, i.e. approximately, from 180 to 500 tonnes per day (an on stream factor of 300 operational days per year has been assumed here for illustration). The range of capacities per plant in the sulphate process route vary from 30 to 130 kt per year, i.e. approx. from 100 to 430 tonnes per day.

#### **1.1.5.3 Carbon black**

There are 12 Member States producing carbon black in 22 plants located across the EU-25, with a total capacity of 1675 kt per year, which represents approximately 21 % of the world's carbon black capacities [47, InfoMil, 2002], [13, EIPPCB, 2000]. The range of capacities per plant vary from 10 to 122 kt per year and, approximately, from 35 to 400 tonnes per day.

#### **1.1.5.4 Synthetic amorphous silica**

There are eight Member States producing synthetic amorphous silica in 18 plants located across the EU-15. Data from 2002 report a combined capacity of 392 kt per year, which represented approximately 30 % of world synthetic amorphous silica capacities [49, CEFIC-ASASP, 2002]. Out of these 18 plants, there are six plants producing pyrogenic silica (in total 72 kt per year), 10 plants producing precipitated silica (286 kt per year) and two plants producing silica gel (34 kt per year).

However, data from 2006 report a combined capacity of 620 kt per year, which still represents approximately 30 % of the world synthetic amorphous silica capacities, and a range of capacities of 12 – 100 kt per year.

No information is currently available for the new Member States, and therefore no data relevant to the EU-25 area are given (refer to Chapter 5; see also Figure 1.17).

#### **1.1.5.5 Inorganic phosphates**

The world share for industrial inorganic phosphates (i.e. sodium, calcium, potassium and ammonium phosphates) in western Europe is 48 %.

##### **1.1.5.5.1 Detergent phosphates**

There is currently six plants producing sodium tripolyphosphate (STPP) operated in four Member States in the EU-15 with the total capacity estimated at 655 kt per year. The range of capacities per plant vary from 30 to 165 kt per year, i.e. from 100 to 550 tonnes per day.

No information on detergent phosphates is currently available for the new Member States (refer to Chapter 6; see also Figure 1.17).

#### **1.1.5.6 Production potential of the LVIC-S industry in the EU-25**

Even though the LVIC-S industry is one of the least dynamically developing segments of the EU chemical industry sector (refer to Section 1.1.1.3) [9, CEFIC, 2004], it is characterised by quite an important production potential, and is one of the important pillars of the chemical industry sector, allowing for more dynamic development of several other chemical industry sectors and other sectors of the EU economy.

In order to illustrate the production potential in the European LVIC-S industry in a synthetic way, in Table 1.3 below gives recent approximate combined production capacities in the EU-15 (plus Norway). Where possible, the capacities relating to the LVIC-S cornerstone products in the EU-25 are also given, as follows:

LVIC-S cornerstone products (million tonnes per year)	Soda ash – (Solvay Process)	Titanium dioxide (2 routes)	Carbon black	Synthetic amorphous silica	Detergent phosphates (STPP)
EU-15 capacity	6.6	1.4	1.5	0.4	0.7
New Member States <sup>(*)</sup>	1.1	0.1	0.2	???	???
EU-25 capacity	7.7	1.5	1.7	0.4?	0.7?

<sup>(\*)</sup>No data available at present on LVIC-S cornerstone synthetic amorphous silica and detergent phosphates plants in the new Member States of the EU-25.

**Table 1.3: Capacities of LVIC-S cornerstone products in the EU**  
 [33, CEFIC-ESAPA, 2004], [20, CEFIC-TDMA, 2004], [47, InfoMil, 2002], [49, CEFIC-ASASP, 2002], [92, EU DG Environment, 2002], and [85, EIPPCB, 2004-2005]

### 1.1.5.7 Distribution of the LVIC-S plants in the EU-25

Figure 1.17 below indicates the concentration of the LVIC-S industry in the EU addressed at the cornerstone level in this document. At least 80 LVIC-S cornerstone plants have been identified on the EU-25 scale (including Norway with one TiO<sub>2</sub> plant).

For the reasons of clarity, Figure 1.17 does not include the 20 feed phosphate plants which were formerly defined at the ‘selected illustrative’ LVIC-S plants level. They are included jointly with detergent phosphates, at the ‘cornerstone’ level – refer to Chapter 6..

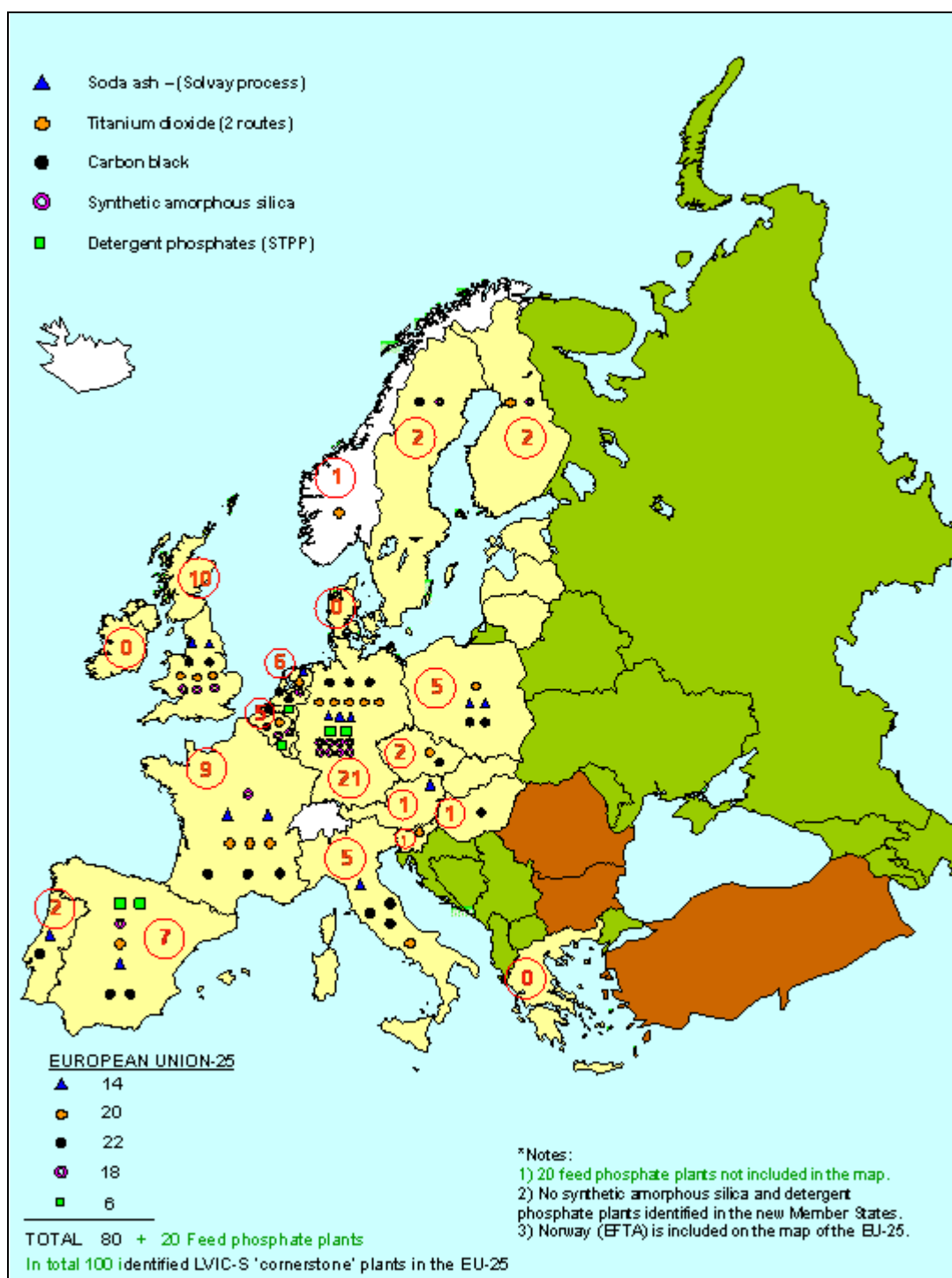
Out of the total of 80 LVIC-S cornerstone plants identified (but with feed phosphate plants included, there is a total of 100 cornerstone plants), 21 plants are located in Germany, ten plants in the United Kingdom, nine plants in France, seven plants in Spain, six plants in the Netherlands, and five cornerstone plants respectively in Belgium, Italy and Poland. Austria, the Czech Republic, Finland, Hungary, Norway, Portugal, Slovenia and Sweden each have less than five cornerstone plants. Denmark, Greece, Ireland, and Luxembourg are not represented at the LVIC-S industry cornerstone level.

The identified cornerstone plants are characterised by quite a broad range of capacities, from the smallest carbon black plant with a capacity of 10 kt per year to the largest soda ash plant with a capacity of 1000 kt per year.

In addition, over 300 installations are reported to exist in the EU-25 for the production of the selected illustrative LVIC-S products, of these the most numerous are precipitated calcium carbonate plants (refer to Section 7.12).

Even though plants relating to selected illustrative LVIC-S products have not been included in the map, Figure 1.17 is a clear indication of the potential of the LVIC-S industry in the EU-15, and broadly also on the EU-25 scale.

When adding over 300 plants manufacturing selected illustrative LVIC-S products to the above list of 80 LVIC-S cornerstone plants, it can be assumed that approximately as many as 400 installations, with a very broad range of capacities and using many varied production processes, can be associated with the LVIC-S industry in the EU-25.



**Figure 1.17: Distribution of LVIC-S cornerstone plants across the EU-25**  
 [33, CEFIC-ESAPA, 2004], [20, CEFIC-TDMA, 2004], [47, InfoMil, 2002], [49, CEFIC-ASASP, 2002], [92, EU DG Environment, 2002], [85, EIPPCB, 2004-2005]



## 1.2 Key LVIC-S production processes

Sections 1.2.1 to 1.2.5 describe the LVIC-S cornerstone processes applied across the EU. These processes are illustrated in detail in Chapters 2 through to 6 of this document.

### 1.2.1 Soda ash with refined sodium bicarbonate

The production of sodium carbonate in the EU-25 is based on the Solvay soda ash ammonia process [33, CEFIC-ESAPA, 2004] in which limestone, salt brine, ammonia and coke are the main raw materials (refer also to Figure 1.15).

Refined sodium bicarbonate is manufactured on the basis of a solution of sodium carbonate (or calcined soda) from the soda ash plant. The refined sodium bicarbonate plant is fully integrated with the soda ash plant operating by the Solvay process [33, CEFIC-ESAPA, 2004].

### 1.2.2 Titanium dioxide

Two processes, the older sulphate process (extraction with sulphuric acid), or the newer chloride process (extraction with chlorine), manufacture  $\text{TiO}_2$  [13, EIPPCB, 2000]. The starting materials for  $\text{TiO}_2$  production on a worldwide basis are ilmenite and titaniferous slag in the case of the sulphate process, and leucoxene, rutile, synthetic rutile, ilmenite, or titaniferous slag for the chloride process [13, EIPPCB, 2000].

#### 1.2.2.1 The sulphate process

The reaction of titaniferous mineral with sulphuric acid converts metal oxides into soluble sulphates, primarily of titanium and iron. After a proportion of the iron in solution is removed, a relatively clean titanium solution is sent for the hydrolysis. The product from this stage is a microcrystalline oxide of titanium, which is converted into the required crystalline state by calcination [13, EIPPCB, 2000].

#### 1.2.2.2 The chloride process

The chloride process goes according to the following steps: extraction of titanium by chlorine from a titaniferous ore, followed by oxidation of titanium tetrachloride, so shifted to titanium dioxide (pigmentary size) and chlorine (for recycling). A good quality base pigment is produced in the oxidation reactor. Here titanium tetrachloride is reacted with oxygen or oxygen enriched air in the presence of nucleation/growth additives [13, EIPPCB, 2000].

#### 1.2.2.3 Wet treatment (coating)

The titanium dioxide pigments are coated to enhance the pigmentary characteristics of the base pigment. Coating techniques have been developed over many years and to some extent, using wet route coatings, are common to sulphate and chloride base pigments [13, EIPPCB, 2000].

### 1.2.3 Carbon black

More than 95 % of carbon black is now manufactured using the furnace black process, which assures both the high carbon black yield and the range of qualities of carbon black produced. [13, EIPPCB, 2000], [48, W. Buchner et al, 1989].

The use of liquid hydrocarbon feedstocks increases the yield of carbon black and enables a much broader range of products to be manufactured, so this type of raw material (from refineries, coking plants, catalytic crackers, and steam crackers for the production of ethylene and from the catalytic synthesis of petrol) is now almost exclusively used by the carbon black industry.

#### **1.2.3.1 Post-treatment**

The chemical nature of the surface of carbon black is critical to its applications-related behaviour and is a function of the manufacturing process. In addition to physically adsorbed organic substances, chemically combined surface oxygen is present on the surface. In special cases, it is desirable to augment the content of volatile components. This is accomplished by oxidative post-treatment in which acidic surface groups are formed [13, EIPPCB, 2000].

### **1.2.4 Synthetic amorphous silica**

The basic raw material for the production of synthetic silicas is waterglass or silanes. There are two main routes to these products: thermal and wet. The thermal route leads to pyrogenic silica and the wet route to precipitated silica and silica gel [13, EIPPCB, 2000].

#### **1.2.4.1 Synthetic amorphous pyrogenic silica**

Thermal processes use high temperature reactions in which volatile silicon compounds such as the tetrachloride or the monoxide are prepared as intermediates, the latter being subsequently hydrolysed at elevated temperatures to give the highly dispersed end silica products. Pyrogenic amorphous silicas are produced by thermal flame hydrolysis [87, Ullmann's, 2001].

#### **1.2.4.2 Synthetic amorphous precipitated silica**

Silica produced by wet processes include: precipitated silica and silica gel [13, EIPPCB, 2000]. Raw materials for the production of precipitated silica are aqueous alkali metal silicate solutions and acids, generally sulphuric acid [87, Ullmann's, 2001]. The process consists of the following steps: precipitation, filtration, drying, grinding, and in some cases, compacting and granulation.

#### **1.2.4.3 Silica gel**

Silica gels are produced by the neutralisation of aqueous alkali metal silicates (water glass) with acids. On a commercial scale, the process comprises raw material dilution, synthesis (sol formation/gelation), washing/ageing and drying, followed by sieving, milling, or surface modification depending on the final product.

### **1.2.5 Inorganic detergent, food and feed phosphates**

#### **1.2.5.1 Detergent and food phosphates – sodium tripolyphosphate**

The main product in this family, sodium tripolyphosphate (STPP), is mainly used in detergents, but is also the main food phosphate produced in Europe [6, CEFIC, 2002].

The production process of STPP ( $\text{Na}_5\text{P}_3\text{O}_{10}$ ) has two steps. In the first step, thermal, purified or unpurified (green) phosphoric acid is mixed with either sodium hydroxide or sodium carbonate in the proper ratio.

In the second step, the resulting solution, in some cases after concentration, is directed to a spray or rotary dryer where solid sodium phosphate is obtained. Calcination can be carried out in the same drying equipment or in a separate kiln. After calcinations, the product is typically kept hot during some period of time, to increase the conversion of phosphate to polyphosphate [6, CEFIC, 2002], [85, EIPPCB, 2004-2005].

### 1.2.5.2 Feed phosphates – dicalcium phosphate

Inorganic feed phosphates include compounds containing phosphorus from phosphate rock  $\text{Ca}_5\text{F}(\text{PO}_4)_3$  or purified phosphoric acid. By the reaction of phosphate with mineral cations, a large variety of phosphates for different feeding purposes, are produced.

The phosphates most commonly used for animal feed are calcium phosphates, with dicalcium phosphate as a main representative in this group, as well as magnesium phosphates, sodium phosphates, ammonium phosphates, and combination phosphates [6, CEFIC, 2002].

## 1.3 Overview of environmental issues in the LVIC-S industry

### 1.3.1 Main raw materials

As far as LVIC-S raw materials are concerned, most substances can be classified in three categories [6, CEFIC, 2002]:

- LVIC-S produced from ores or natural abundant products. Examples:
  - sodium chloride brine and limestone, feedstock of soda ash
  - sodium chloride brine, feedstock of sodium chlorate
  - titanium ores, feedstock of titanium dioxide
  - phosphate rock, feedstock to phosphoric acid, directly to some phosphates, and to fluosilicic acid.

The content of impurities in these raw materials plays an important role on emissions, or they may contaminate the end-products. Pretreatment processes are sometimes applied at the mining step, and this, combined with the very nature of the ore, may significantly change the amount of waste material to be eliminated at the LVIC-S production step. Examples:

- borax vs. tincal as sodium perborate feedstock
- fluorspar vs. fluosilicic acid as aluminium fluoride feedstock

- LVIC-S produced, at least partly, from secondary or re-used products. Examples:
  - zinc chloride products from zinc scrap
  - aluminium fluoride produced from fluosilicic acid
  - sodium sulphate produced via the chromate route
- LVIC-S produced from more elaborate feedstock. Examples:
  - detergent, feed and food phosphates, produced from different grades of phosphoric acid
  - zeolites, produced from sodium silicate and sodium aluminate solutions
  - iron oxide pigment, produced from copperas obtained as a by-product in titanium dioxide production based on the sulphate route
  - pyrogenic synthetic amorphous silicas produced from silanes and alkylsilanes
  - precipitated synthetic amorphous silicas produced from waterglass
  - carbon black produced from various hydrocarbon-based feedstocks, such as refinery decant oil, ethylene cracker residue, and coal tar distillates
  - precipitated calcium carbonate produced from calcium oxide.

### 1.3.2 Secondary feedstock and energy

The term ‘secondary feedstock’ denotes substances, which allow the main raw materials to be transformed. Oxygen from the air is one of them, other substances often met in the production of LVIC-S are [6, CEFIC, 2002]:

- chlorine, used to produce, e.g. aluminium chloride or titanium dioxide by the chloride route
- sulphuric acid, used to produce, e.g. aluminium sulphate or zinc sulphate
- carbon (e.g. coke) used to produce, e.g. soda ash or calcium carbide
- hydrogen used to produce synthetic amorphous silicas
- natural gas or petrochemical oils used to produce carbon black.

Also some reactants (e.g. soda ash, sodium hydroxide, calcium hydroxide) are largely used to purify the feedstock or the finished products.

In some LVIC-S processes, the need for energy is very large. Examples of substantial energy inputs to LVIC-S processes include:

- electricity in the production of, e.g. sodium chlorate or calcium carbide
- electricity and thermal energy for producing soda ash from salt brine.

The energy balance at the process level and the energy integration at the site are very specific to each chemical complex and are very important criteria for the economic viability. Several examples of energy savings at a process level may be found in the LVIC-S cornerstone production plants, to mention here: soda ash [33, CEFIC-ESAPA, 2004], titanium dioxide [20, CEFIC-TDMA, 2004], and carbon black [47, InfoMil, 2002].

### 1.3.3 Use of water

Water plays an important role in the production of LVIC-S compounds, where it can be used as:

- a heat transfer agent for cooling or heating
- a feedstock for boiler plants
- a carrying agent for transport of insoluble materials
- a component of an LVIC-S substance (e.g. crystallisation water)
- a solvent
- a washing/cleaning agent
- an air contaminant abatement fluid, etc.

Energy and environmental management tools which are described in Annex IV to the Directive and analysed in Chapter 8 ‘Common Available Techniques in the LVIC-S industry’ are applied to allow the use of water to be reduced, compatible with process safety and operability conditions [11, The Council of the EU, 1996], [6, CEFIC, 2002].

### 1.3.4 Emissions to air

The first group of pollutants includes substances which are abated by water, acidic water or alkaline water, like SO<sub>2</sub>, HCl, HF, SiF<sub>4</sub>, NH<sub>3</sub>, Cl<sub>2</sub>, and H<sub>2</sub>S. Therefore, the effluent treatment can be based on absorption in aqueous solutions, achieved by one or more steps [6, CEFIC, 2002].

As strong acids, mists and aerosols are easily formed, in several instances absorption systems can be multistage, preferably supplemented with a demister. If not recirculated back to the process, the solutions resulting from the absorption system may have to be treated for the correction of pH and adjustment of other characteristics before disposal.

The second group of pollutants includes dust emissions from the process and from the handling of feedstock and end-products, where wet and dry abatement systems are typically used.

Emissions of NO<sub>x</sub> and VOC are to be considered in some cases only. Depending on the process and the material handling techniques selected (e.g. mechanical conveying vs. air conveying), the vent stream can largely vary in flowrate, in pollutant concentration, and in its nature (continuous vs. intermittent flow).

For information about the air emission problems likely to be met in the production of LVIC-S compounds, refer to Section 8.2.

### 1.3.5 Emissions to water

Besides the liquid purges from the production process, emissions to water also include the waste streams from the abatement systems of air emissions, the bleeds from the semi-closed cooling water network and steam generators, the cleaning water from maintenance equipment, as well as the contaminated rainwater [6, CEFIC, 2002].

The main contaminants are salts and inorganic substances (including halogen and phosphorus compounds), acidifying and alkalisng substances, metals and heavy metals, and suspended matters, although the presence of organics (TOC) in the LVIC-S industry is unusual. As no nitrates, and only to a limited extent ammonia, are dealt with in the LVIC-S industry, the eutrophication in some water bodies can be related to the release of phosphates into water.

The emission of dissolved salts (e.g. calcium chloride in the production of soda ash) could be an important environmental issue, if not correctly addressed [6, CEFIC, 2002], [33, CEFIC-ESAPA, 2004].

Information about the water emission problems likely to be met in the production of LVIC-S compounds is included in Section 8.3.

### 1.3.6 By-products and solid wastes

There are no strict commonalities between the LVIC-S processes but a few rules listed below should be kept in mind [6, CEFIC, 2002], [14, EIPPCB, 2003]:

- when ores are used, their impurities end up as an emission, as wastes or as part of the product. The amount of wastes may be large and depend on sources of appropriate raw materials
- the extraction of natural raw materials may generate wastes at the extraction and treatment stages, as well as wastes generated in the downstream processes. This is relevant to the process of life cycle assessment
- when analysing the problem of solid waste disposal and by-products utilisation, there is a need to illustrate this from both the viewpoint of wastes that are untreatable (directly related to the type and quality of the processed ore) and wastes that are treatable (wastes which can be upgraded, reprocessed and utilised in the form of by-products, which are again additional outputs of a plant). It should, therefore, be noted that the degree of waste utilisation is a justified performance expression for the LVIC-S industry but, in principle, it should be used for treatable wastes only
- in some processes, the operators cannot afford to invest in complex waste treatment units, as they may be too costly to run the LVIC-S process at a minimum level of economic efficiency, the operation of waste recovery may be highly energy consuming, and there may not be sufficient market demand for the recovered by-product. The problem of CaCl<sub>2</sub> utilisation in soda ash and other industries is an example here, refer to Chapter 2, and Sections 7.7, and 7.11 [33, CEFIC-ESAPA, 2004], [56, InfoMil, 2004], [95, CEFIC-Brunner Mond, 2004]

- calcium sulphate is often by-produced, when large amounts of sulphate ions dissolved in water are precipitated by lime – e.g. in the titanium dioxide sulphate process route. The recovery of calcium sulphate which cannot be dumped is often not feasible, unless a long term strategy towards the utilisation of gypsum is applied, as is the case in the production of titanium dioxide by the sulphate route with the associated co-production of ‘white’ and ‘red’ gypsum to cover local demand for these by-products [20, CEFIC-TDMA, 2004], refer to Chapter 3.

It should be noted that in all cases, a long term strategy for waste management needs to be developed, streamlined with the IPPC Directive, Annex IV, points 1 and 3, as this can then even lead to creating a market for by-products, such as gypsum referred to above, resulting from the production of TiO<sub>2</sub> by the sulphate process route [85, EIPPCB, 2004-2005].

## 1.4 Unit processes and infrastructure in the LVIC-S industry

### 1.4.1 Unit processes and unit operations in the LVIC-S industry

According to the terms used in the chemical process industries [31, R. N. Shreve, 1945], chemical engineering, applied in industrial projects to develop chemical plants and complexes, can be defined in the following way:

Chemical engineering (chemical industry project) ~ Unit processes (chemical changes) + Unit operations (physical changes)

The most characteristic examples of the unit processes relevant to the LVIC-S industry and associated activities are listed in Table 1.4.

Unit process	LVIC-S industry product (or associated activity)
Combustion	Coke burning – thermal decomposition of limestone in the soda ash Solvay process (fuel burning, steam and power generation – refer also to the BREF on LCP)
Oxidation	Titanium dioxide – chloride route, zinc oxide, lead oxide, sodium perborate/percarbonate, synthetic amorphous silica (thermal route). For phosphoric acid production from elemental phosphorus – refer to the BREF on LVIC-AAF.
Neutralisation	Sodium salts, sodium tripolyphosphate (waste water treatment in LVIC-S industry complexes)
Silicate formation	Sodium silicate, precipitated silica
Electrolysis	Sodium chlorate. For caustic Soda – refer to the BREF on Chlor-Alkali
Double decomposition	Soda ash; sodium, potassium and magnesium salts (water softening in LVIC-S industry complexes)
Calcination	Soda ash, titanium dioxide (sulphate process route), sodium tripolyphosphate
Reduction	Calcium carbide, silicon carbide, sodium salts, titanium dioxide – sulphate route, zinc oxide
Halogenation	Titanium dioxide – chloride route, aluminium chloride
Hydration and Hydrolysis	Magnesium oxide, slaked lime, titanium dioxide – sulphate route
Pyrolysis or Cracking	Carbon black

**Table 1.4: Unit processes typical to the LVIC-S industry**  
Based on [31, R. N. Shreve, 1945]

In turn, the list of major unit operations broadly applied in the LVIC-S industry covers [31, R. N. Shreve, 1945]:

Fluid flow	Heat transfer	Evaporation	Gas absorption
Adsorption	Distillation	Drying	Mixing
Classification	Sedimentation	Filtration	Screening
Crystallisation	Centrifugation	Size reduction	Materials handling.

The following four unit operations, i.e. size reduction, sedimentation, filtration, and drying, commonly applied in and characteristic to the LVIC-S industry, are illustrated in Annex 2 – Selected unit operations in the LVIC-S industry [13, EIPPCB, 2000].

### 1.4.2 Characteristics of a typical LVIC-S production plant

A typical LVIC-S plant for producing large volume inorganic chemicals – solid and others, usually consists of several sub-units, as already illustrated in Figure 1.14. Refer also to Section 1.4.3 below. These sub-units are typically:

- an energy supply unit, which produces steam and/or, optionally, electrical energy when technically feasible and economically viable (energy may partially be recovered from the synthesis step as heat)
- a unit for supply and preparation of raw materials and feedstock
- a section which comprises the process of synthesis starting with the feedstock and ending with the crude product
- the purification process of the crude product to the end-product, which has to fulfil required specification limits. In many LVIC-S processes, this step merely consists of filtering, washing and drying the crude product. It should be noted that at this stage usually an off-spring connection to the SIC installation is located
- the packaging, storage and loading of the end-product
- end-of-pipe – waste stream management – optional measures
- a comprehensive infrastructure which interconnects the several sub-units for:
  - energy, water, gas and feed supply
  - environmental protection and waste disposal
  - health and safety.

The complexity of chemical plants, where there is material and energy exchange between units and sub-units, demonstrates that there is no universal approach in selecting a process or a technique. The local conditions will be a key factor for selecting the process, which will be the best compromise between strategic, technical, economic, social, safety and environmental factors.

### 1.4.3 Infrastructure at a LVIC-S production site

As illustrated in Figure 1.14, almost every LVIC-S production site will have a comprehensive infrastructure that interconnects the production units. Although not directly involved with the production process, the infrastructure provides the essential services (utilities) to ensure that the process operates effectively, safely and without detriment to the environment. Sections 1.4.3.1 to 1.4.3.6 provide brief descriptions of this ancillary equipment [13, EIPPCB, 2000].

#### 1.4.3.1 Energy supply

Many of the LVIC-S industry processes have a significant requirement for energy. The energy source depends on the process requirements and the local availability. Many operators sub-contract energy supply to third parties or use the central facilities that exist on many sites.

The main sources are process furnaces, steam boilers, power generation in turbines, and heat exchange (against a hotter product, intermediary stream or raw material).

Process furnaces are the primary source of heat in many endothermic chemical processes. They are typically fired on gas or liquid fuel. The carbon black production process is an example here.

Steam is normally generated in steam boilers or in Combined Heat and Power (CHP) units. Energy from boilers is distributed around an installation using a heat transfer medium (usually steam) in closed recirculation loops.

A large chemical complex typically has steam available at several enthalpy levels (high, medium or low pressure). Heat is input to the process either directly (e.g. by steam injection) or indirectly by some form of heat exchanger equipment (typically shell and tube type). The condensate from steam use will have its own collection system for return to the boiler.

Electrical power is needed for equipment such as pumps, mixers, compressors, and lighting. Power can be generated on-site or purchased, but there is a trend in the chemical industry to combine power and steam generation in CHP units. CHP units fulfil the need for both steam and electricity and have a very high overall energy efficiency (>85 %). They also reduce the dependence on external power supplies, and can even supply excess power to the grid. CHP system is most successful where the heat to power ratio is at least 1:1 and power is needed for at least 6000 hours per year.

The LVIC-S industry, having onstream time of at least 7200 hours per year and up to 8500 hours per year (soda ash plants), is an appropriate area of CHP applications. The trend in the chemical industry to combine heat and power generation (CHP) is fully in line with the new EU Directive 2004/8/EC of 11 February 2004 on the promotion of cogeneration based on a useful heat demand in the internal energy market [86, The Council of the EU, 2004].

### 1.4.3.2 Cooling

As a general rule, cooling systems are only adopted as a last resort when raisings of waste heat have been minimised and all opportunities for heat re-use have been exhausted (e.g. cold feed streams can be heated against hot product streams). By applying such heat integration, significant energy can be saved and the associated emissions can be reduced – refer to Section 8.8.3.1 on Pinch technology.

The removal of heat from exothermic processes is very important for process control and safety reasons, and cooling may also be required to create the right conditions for certain process steps. Cooling systems typically involve some form of heat exchanger to remove heat from the process, a heat transfer medium and a mechanism for dissipating heat into the environment.

A wide variety of cooling systems are available and since these technologies are used in common ways across the chemical industry, they are covered in detail in a dedicated horizontal BREF on ‘Industrial Cooling Systems’.

The application of cooling systems is highly dependent on site-specific conditions and each case needs to be evaluated individually, among others using the principles in the Industrial Cooling Systems BREF in order to establish the cooling requirements. The main considerations are:

- resource consumption (water, air, energy, chemical substances)
- emissions to water (chemicals and heat) and air, noise, plumes and waste generation
- risk aspects and pollution arising from specific events (starts/stops) or incidents.



### 1.4.3.3 Refrigeration

Refrigeration is provided where processes require temperatures below those that can be obtained with cooling water and is usually provided by a central site facility. Chlorofluorocarbons (CFCs) or intermediate substances such as hydro chlorofluorocarbons (HCFCs) are not used in any new refrigeration systems and replacement plans exist where they are used.

The cold is distributed around the chemical complex using different coolants, either chilled water (for temperatures down to about 10 °C) or salt brines (down to -30 °C). Ammonia-based refrigeration systems are also frequently applied (for temperatures down to -33 °C). Measures are taken to minimise the loss of refrigerants from pumps, pipe joints, etc. Remote detection systems may be used for detecting fugitive losses (e.g. of gaseous ammonia).

### 1.4.3.4 Storage and handling

Emissions may arise from the storage of raw materials, intermediates, products and wastes during routine operation, during plant start-ups or shut-downs or during industrial accidents. The substances may be stored as gases, liquids or solids, and the storage may have various forms, for example drums, tanks, intermediate bulk containers, as well as open storages of solid inorganic chemical raw materials and products.

Several LVIC-S raw materials and ores, intermediate products and final products are stored in bags, big bags or usually in bulk under roof or in the open air. Emissions may also occur while materials are being conveyed to and from storage. Because of the nature of stored material, some plants – (such as, for instance, the chloride route titanium dioxide plants, in which very toxic chlorine is handled) – are also subject to the provisions of the SEVESO II Directive [23, The Council of the EU, 1996].

On the one hand, large chemical production sites may involve lower risks of spillage because they obviate the need for the loading of transfer vessels (rail or road tankers, or boats), and their transportation and unloading at destination points. But on the other hand, in large chemical complexes great volumes of materials are handled, and therefore the scale of production is a serious consideration here. Also, these sites often necessitate chemicals being pumped through long pipe networks and this introduces the risk of failure on remote pipe-runs.

With regard to bulk storage, which is most characteristic to the LVIC-S industry, many of the techniques for preventing emissions are used in common ways across the chemical industry. Rather than being described repeatedly in many different BREFs, they are covered in a dedicated horizontal BREF 'Emissions from storage of bulk or dangerous materials'. This horizontal BREF should, therefore, be read in conjunction with this document.

### 1.4.3.5 Vacuum

The vacuum duty depends on the quantity of gas being handled and the degree of cooling/condensation in the system. Vacuum can be provided in several ways, including: steam ejectors, liquid ring pumps and dry vacuum pumps.

### 1.4.3.6 Utility fluids

A variety of gases are used in installations to facilitate the operation of equipment or to carry out specific activities. Installations may have distribution systems for such gases as nitrogen, carbon dioxide and compressed air. These gases are usually inert and relatively benign in their own right, but may become contaminated with products or waste in performing their duties and then require treatment.

Air, carbon dioxide and nitrogen have important uses for purging vessels and equipment with toxic or flammable atmospheres. The equipment of a plant is typically purged with air prior to opening, and with nitrogen or carbon dioxide prior to start-up.

Compressed air is also used for cleaning purposes, for actuating the pneumatic controllers used in plant control, and for operating instruments.

The LVIC-S complexes and installations typically have a variety of reticulation systems for different qualities of water (e.g. drinking water, demineralised water for boiler feed, process make-up water, fire water).

Refer also to the BREFs on:

- Large Combustion Plants (LCP),
- Industrial Cooling Systems (CV),
- Emissions from Storage (ESB), and
- Common Waste Water and Waste Gas Treatment/Management Systems in the Chemical Sector (CWW).

## **1.5 Best Available Techniques for the LVIC-S industry**

In Chapters 2 through to 7, data and information on processes applied, present consumption and emission levels, techniques to consider in the determination of BAT and finally, conclusions on Best Available Techniques applicable to LVIC-S processes are given.

Only after LVIC-S processes have been thoroughly evaluated in Chapters 2 through to 7, at the ‘cornerstone’ and ‘selected illustrative’ level, Best Available Techniques for environmental management are listed in Section 8.10.

A list of good environmental practices (GEP) for the use of technology, plant design, maintenance, operation, environmental protection and decommissioning in the LVIC-S industry can be found in Annex 3 (see Section 11.3).

In all circumstances, priority should be given to BAT associated with specific LVIC-S processes. BAT included in the generic chapters or in other BREFs cannot overrule process-related BAT included in this document.



## 2 SODA ASH

### 2.1 General information

#### 2.1.1 Introduction

Soda ash is a fundamental raw material to the glass, detergent and chemical industries and, as such, is of strategic importance in the European and global manufacturing framework [8, CEFIC, 2004], refer also to Figure 1.15 and Figure 1.16.

Over many decades demand for soda ash has been increasing at an average rate of 2 % per year, [13, EIPPCB, 2000]. Soda ash (calcined soda) is manufactured in two grades: ‘light soda ash’ and ‘dense soda ash’. Dense soda ash is the preferred form of the product for use in the glass industry and for economic transportation over long distances [13, EIPPCB, 2000].

Soda ash is a commodity product, freely available in the highly competitive world markets at a price which reflects the cost of manufacture plus delivery. A very large scale of its manufacture in the order of 40 million tonnes per year worldwide, the local availability of raw materials, the price of energy, and the environmental impact of its production, are key drivers for improvements in the soda industry worldwide.

Since the 1940s, soda ash has been increasingly obtained from trona, especially in the United States, where the proportion of soda ash produced from trona has increased continuously from 15 % in 1960, to 100 % in 1986. At the present time, as much as 30 % of the worldwide soda ash capacity is based on trona or other sodium-based minerals, and of that nearly 12 million tonnes per year in North America [13, EIPPCB, 2000], [33, CEFIC-ESAPA, 2004].

Since the twenties, several deposits of minerals containing sodium carbonate or bicarbonate have been discovered. It is estimated that the largest trona deposit in the Green River Basin of Wyoming, the United States, could potentially produce as much as 47000 million tonnes of soda ash, i.e. to cover the current US soda ash demand for many decades to come [105, Mineral Information Institute, 2004]. Nevertheless, the ore purity and the location of these deposits, as well as the mining conditions of these minerals, has limited the effective number of plants put into operation [33, CEFIC-ESAPA, 2004].

As trona deposits are not available in Europe, soda ash in Europe is almost entirely manufactured according to the Solvay process (the so-called ammonia soda process), using the locally available natural raw materials of salt brine and limestone of the required purity.

The Solvay process, also called the ammonia soda process, was developed in the 19<sup>th</sup> century and the first soda ash plants in Europe were started at that time. The plants have been modernised and extended several times in order to implement technology upgrades and their capacities have been increased progressively to follow market demand [33, CEFIC-ESAPA, 2004], [76, Union of Inorganic Industry, 1977].

Virtually all European soda ash is made using the Solvay process, typically by large, highly integrated production units, with a plant capacity ranging from 160 to 1200 kt per year. The high capital cost of the equipment hinders the construction of new soda ash plants. Older plants are still being modernised and revamped to keep pace with a growing demand and technological progress [33, CEFIC-ESAPA, 2004].

The current European soda ash capacities amount to over 15 million tonnes per year, and of that in the EU-25 approximately 7.7 million tonnes per year [33, CEFIC-ESAPA, 2004].

Apart from Europe, the Solvay process also dominates in Asia, followed by other soda ash manufacturing processes tailored to regional conditions, for example the production of soda ash based on solid salt, where local salt brine deposits are not available, or the co-production of ammonium chloride with soda ash, this former product being extensively used in Asia as a fertiliser material [33, CEFIC-ESAPA, 2004], [91, Takuji Miyata, 1983].

Table 2.1 presents three major regions of soda ash production with the highest level of installed capacities, characterised by distinct features, and having a decisive impact on developments in the soda ash industry worldwide:

Region	Processes used	Approximate soda ash capacity	Main raw materials	Estimated energy requirements
Europe	Mainly Solvay process	Over 15 million tonnes per year (EU-25 nearly 8 million tonnes per year)	Salt brine and limestone	9.7 – 13.6 GJ/t (*)
North America	Na minerals process	Nearly 12 million tonnes per year	Trona and nahcolite	6.1 – 7.7 GJ/t (**)
Asia	Mainly Solvay process, followed by other processes, including the New Asahi process (NA mono-production and co-production process routes)	Nearly 14 million tonnes per year, of that 10 million tonnes per year based on the Solvay process, and 4 million tonnes per year based on other processes	Salt brine and limestone  Solid salt and limestone	Solvay process 12.6 GJ/t (**)  New Asahi process: NA mono-production process route 8.9 GJ/t (**) (***)
(*) Sum of the extreme values lime kilns + soda ash, as in [33, CEFIC-ESAPA, 2004].				
(**) Based on [91, Takuji Miyata, 1983].				
(***) Does not include energy requirements to get solid salt from brine (0.9 GJ/tonne).				

**Table 2.1: A comparison of the main soda ash producing regions (approximate data) Based on [33, CEFIC-ESAPA, 2004] and [91, Takuji Miyata, 1983]**

The production of soda ash in Europe by the Solvay process has been developing for over 140 years. Long term experience acquired by the European soda ash industry in investment planning, process design, plant construction, start-up, operation, optimisation, shut-down and decommissioning, has allowed for building-up these major steps of the plant's life cycle into an integrated system of actions, leading to the minimisation of the cost of soda ash manufacturing, with the focus put on operation reliability, efficiency of raw materials and energy use, and on lessening the impact of the soda ash industry on the environment [33, CEFIC-ESAPA, 2004], [53, EIPPCB, 2004], [41, Solvay S.A., 2003], [79, BIPROK WAS, 1985-1995], [39, S. Leszczynski et al, 1978].

A high onstream factor in the production of soda ash by the Solvay process, achievable and proven in industrial practice, is an outstanding and distinct feature of the soda ash plants. It illustrates the best long term, integrated strategy of the European soda ash producers in development, design and investment in the soda ash plants, and many years experience of the soda ash industry in plant operation, equipment cleaning, and planning maintenance cycles of both technological units and the associated energy supply unit [53, EIPPCB, 2004].

One of the most critical issues for this strategy to work is a high degree of integration of the soda ash plant with the associated boiler/power plant at the site, also with the aim of utilising the economy of scale in both the soda ash plant and associated power plant [53, EIPPCB, 2004].

Because of the large tonnage of production involved, the plants require large quantities of basic raw materials: limestone and sodium chloride brine. Significant amounts of energy, cooling water and a range of secondary raw materials, including ammonia are also required. A modern, large capacity soda ash plant is characterised by large volumes of liquid and gas flows, a high degree of integration, interdependence and recycling between the plant units [33, CEFIC-ESAPA, 2004], [53, EIPPCB, 2004].

The quality of the selected raw materials and geographical location of the production plants have a large influence on composition, volume and treatment of effluents.

The main environmental impacts of the ammonia soda process are the atmospheric and aqueous emissions associated with the calcination of limestone, carbonation of ammoniated brine and, predominantly, with the waste waters from the 'distillation' stage of the process [33, CEFIC-ESAPA, 2004], [41, Solvay S.A., 2003], [39, S. Leszczynski et al, 1978].

The limited material efficiency of the Solvay process is defined by the overall reaction, yielding soda ash and calcium chloride. The majority of calcium chloride by-produced in the process must be disposed of, as there is a limited market for this product in the world [95, CEFIC-Brunner Mond, 2004] – refer to Section 7.11.

With the current production of the EU-25 soda ash industry of over 7 million tonnes per year and the quantity of the waste water from distillation ~ 10 cubic metres per tonne of soda ash, a very large volume of waste water must be disposed of each year.

In some EU-25 locations, the disposal of the post-distillation liquid effluent is a significant environmental issue if not managed properly (for information on management techniques refer to Section 2.4.7), due to long term soda ash operations, the volume and composition of the post-distillation slurry (inorganic chlorides, carbonates, sulphates, alkali, ammonia and suspended solids, including heavy metals).

The post-distillation slurry is either directed to the aquatic environment for total dispersion (mostly the seaside located EU-25 soda ash plants) or – after liquid/solid separation in basins (settling ponds) or separators – the outgoing clear liquid is directed to the aquatic receptor. The separated solids deposited in settling ponds may be used for the construction and the build-up of the basins (mostly land-locked EU-25 soda ash plants). In exceptional circumstances where there are local acid soil characteristics, they may be improved by the addition of these solids and, if the market conditions permit, it may be possible to use the separated solids, after further treatment, as a lime fertiliser. Under some geological conditions, separated solids may be stored in solution mined salt cavities, by the controlled wet deposition of the solids using a carrier salt brine [33, CEFIC-ESAPA, 2004], [53, EIPPCB, 2004], [41, Solvay S.A., 2003], [45, UBA - Germany, 2001].

The discharge of waste waters into a local low flowrate watercourse is normally only possible after removal of suspended solids and possible pH adjustment, if required by the local conditions. The solids are then disposed of in settling ponds, a normal practice in the EU-25 soda ash industry, provided that the measures prescribed for liquid effluent discharge management are adopted and observed, to avoid the contamination of groundwaters by the leaking of chloride solutions drained from settling ponds [33, CEFIC-ESAPA, 2004], [40, CEFIC-ESAPA, 2003], [41, Solvay S.A., 2003], [39, S. Leszczynski et al, 1978], [45, UBA - Germany, 2001].

## 2.1.2 Overview about the type of production

### 2.1.2.1 Solvay process

The Solvay process uses salt (NaCl) and limestone ( $\text{CaCO}_3$ ) as raw materials. Ammonia, which is also used in the process, is almost totally regenerated and recycled. The main advantage of this process is the availability of the relatively pure (depending on local conditions) raw materials, which can be found almost everywhere in the world and, therefore, allows operating production units relatively close to the market.

The Solvay process produces 'light soda ash', with a pouring density of about  $500 \text{ kg/m}^3$ . It is used in that form mainly for the detergent market and certain chemical intermediates. 'Light soda ash' is transformed by recrystallisation firstly to sodium carbonate monohydrate, and finally to 'dense soda ash' after drying (dehydration). Dense soda ash has a pouring density of about  $1000 \text{ kg/m}^3$ . It is used mainly in the glass industry. Dense soda ash can also be produced by compaction.

Some producers have made several modifications to the original process. The main ones are:

- the ‘dual process’, which allows soda plants to co-produce ammonium chloride in nearly equal quantities, which is used as a fertiliser in rice cultivation. There are several plants in the world which use that process. Most are situated in China
- the ‘Akzo’ or ‘dry lime’ process, which uses dry lime instead of lime milk for ammonia recovery.

### 2.1.2.2 Trona and nahcolite based process

All processes are based on ore treatment from which impurities (i.e. organics and inorganics) have to be stored underground or in tailing ponds.

#### 2.1.2.2.1 Trona

Trona minerals can be found underground (Green River trona deposit in Wyoming – US, Inner Mongolia – China, Henan – China) or in dry lakes (Searles Lake trona brine deposit in California – US, Magadi Lake trona brine deposit in Kenya, Sua Pan trona brine deposit in Botswana) – refer also to [82, UNIDO, 1988].

Underground ‘dry’ trona processing consists of several steps:

- mechanical mining by the ‘room and pillar’ or ‘long wall’ method
- as trona is an impure sodium sesquicarbonate mineral ( $\text{Na}_2\text{CO}_3 \cdot \text{NaHCO}_3 \cdot 2\text{H}_2\text{O}$ ), it has firstly to be calcined to produce a soda ash still containing all the impurities from the ore
- next, the calcined trona is dissolved, and the solution is settled and filtered to remove impurities (inorganics and organics)
- the purified liquor is sent to evaporators where sodium carbonate monohydrate crystals precipitate
- the monohydrate slurry is concentrated in centrifuges before drying and transformation into dense soda ash.

Deposits from trona lakes and solution mined trona are processed as follows:

- dissolving trona in wells
- carbonation of the solution in order to precipitate sodium bicarbonate
- filtration of the slurry
- calcination of the bicarbonate to get ‘light soda ash’, recycling of the carbon dioxide to the carbonation
- ‘light soda ash’ transformation into ‘dense soda ash’ by the ‘monohydrate method’
- carbon dioxide make-up produced by burner off-gas enrichment.

#### 2.1.2.2.2 Nahcolite

A nahcolite deposit had been found in Piceance Creek in Colorado - US and an industrial soda ash plant was put into operation at the end of the year 2000. Little practical experience of this process is therefore available.

Nahcolite is processed as follows:

- by solution mining (wells, with injection of hot mother liquor returned from the surface facilities)
- as nahcolite is an impure sodium bicarbonate mineral ( $\text{NaHCO}_3$ ), it must be treated
- the hot solution is decarbonated by heating
- the solution is sent to settling and filtration
- next, the purified liquor is sent to evaporators where sodium monohydrate precipitates
- the slurry is concentrated by centrifugation and the monohydrate crystals are transformed to soda ash by drying
- the mother liquor is sent back to the solution mining.

### 2.1.2.3 Nepheline syenite process

There is still a process operated in Russia, mainly in a plant situated in Siberia, which uses mixed minerals and allows the co-production of alumina, cement and soda ash.

### 2.1.2.4 Carbonation of caustic soda

Small quantities of soda ash are made by the carbonation of caustic soda. This produces a soda liquor solution which is treated in similar ways to those described above. Alternatively, where this caustic soda is from diaphragm cells, it contains high levels of residual sodium chloride which can be used either in conjunction with a conventional Solvay ammonia soda process or in the brine purification process.

### 2.1.2.5 Soda ash as a by-product from the production of caprolactam

Soda ash is also manufactured as a by-product from the production of caprolactam. This process is only specific to one site in Europe (the BASF company in Ludwigshafen, Germany – refer to Table 2.3).

In a special plant, the effluents from the synthesis of caprolactam, loaded with organic sodium salts and carboxylic acids solutions from different processes, are converted to soda, which is obtained in partly molten and partly ash state, and then by dissolving, crystallisation and calcination is finally converted into marketable soda ash [45, UBA - Germany, 2001].

## 2.1.3 Uses in industrial sectors

Soda ash is a commodity chemical used in several branches of industry (refer to Figure 1.15). The main ones are quoted below.

### Glass industry

Soda ash is used in the manufacturing of flat and container glass. Acting as a network modifier or fluxing agent, it allows a lower melting temperature of sand and, therefore, reduces the energy consumption.

### Detergent industry

Soda ash is used in a large number of prepared domestic products: soaps, scouring powders, soaking and washing powders containing varying proportions of sodium carbonate, where the soda ash acts primarily as a builder or water softener.

### Steel industry

Soda ash is used as a flux, a desulphuriser, a dephosphoriser and a denitrider.



### **Non-ferrous metallurgy industry**

Soda ash is used for: treatment of uranium ores, oxidising calcination of chrome ore, lead recycling from discarded batteries, as well as for the recycling of zinc and aluminium.

### **Chemical industry**

Soda ash is used in a large number of chemical reactions to produce inorganic and organic compounds which have many applications. The main compounds are listed below.

Refined sodium bicarbonate, among others used in:

- animal feeds
- paper industry for paper sizing
- plastic foaming
- water treatment
- leather treatment
- flue-gas treatment, especially in incinerators
- detergent and cleaning products
- drilling mud to improve fluidity
- fire extinguisher powder
- human food products and domestic uses: baking soda, effervescent drinks, toothpaste, etc.
- pharmaceutical applications: effervescent tablets, haemodialysis.

Sodium sesquicarbonate, used in bath salts, and as a water softener.

Chemically pure sodium carbonate, used in the pharmaceuticals industry, cosmetics, food industry and fine chemicals.

Sodium percarbonate, used as a bleaching agent for various fabrics and as a constituent of domestic detergent powders, as well as in cosmetics.

Other inorganic chemicals, such as: sodium phosphates, sodium silicates, sodium sulphites, and sodium bichromate. Some of these belong to the LVIC-S industry and have many applications (refer to Chapter 7).

### **Other applications**

Apart from the uses in the industrial sectors mentioned above, soda ash also finds applications in: production of various synthetic fertilisers, production of artificial sodium bentonites or activated bentonites, organic and inorganic colouring industry, enamelling industry, petroleum industry, fats, glue and gelatin industry, etc.

## **2.1.4 Production capacity in the world and in Europe**

### **2.1.4.1 Worldwide**

The current worldwide soda ash nameplate capacity is estimated to be around 42 million t/year. The split between processes and geographical zones is given in Table 2.2.

Production capacity million t/year	EU-25	Rest of Europe*	North America	Latin America	Asia	Africa	Oceania	Total
Solvay process	7.7	6.6		0.5	9.7	0.1	0.4	25
Na minerals process			11.6		0.5	0.6		12.7
Others	0.1	0.8			3.7			4.6
<b>Total</b>	<b>7.8</b>	<b>7.4</b>	<b>11.6</b>	<b>0.5</b>	<b>13.9</b>	<b>0.7</b>	<b>0.4</b>	<b>42.3</b>

\*Rest of Europe – soda ash capacity in Russia, Ukraine, Turkey, Romania, Bulgaria and Bosnia

**Table 2.2: Worldwide capacity of soda ash manufacture (reference year: 2002)**  
[33, CEFIC-ESAPA, 2004]

#### 2.1.4.2 European Union

There are only five producers in the European Union (EU-25) applying the Solvay process: Producer A, Producer C, Producer D, Producer E, and Producer F, with a total capacity of 7725 kt/year. Producer K has two plants which co-produce sodium carbonate with a combined capacity of 65 kt/year.

Producer A has seven plants situated in six countries: France, Germany, Italy, Spain, Portugal and Austria with a total capacity of 4200 kt/year. Producer C has three plants in two countries: United Kingdom and Netherlands with a total capacity of 1375 kt/year. Producer D has one plant, in France, with a capacity of 600 kt/year. Producer E has one plant, in Germany, with a capacity of 450 kt/year. Producer F operates two plants in Poland with a combined capacity of 1100 kt/year.

European soda ash capacity and producers (reference year 2002) are given in Table 2.3.

Producers	Country - location	Capacity (kt/year)	Plant start-up (*)
<b>Producer A</b>	France – Dombasle	700	1874
	Germany – Rheinberg	600	1903
	Germany – Bernburg	540	1883
	Spain – Torrelavega	950	1908
	Italy – Rosignano	1020	1917
	Portugal – Povia	230	1934
	Austria – Ebensee	160	1885
<b>Producer B</b>	Bulgaria – Devnya	1200	1954
<b>Producer C</b>	United Kingdom – Northwich (Winnington/Lostock)	1000	1873
	The Netherlands – Delfzijl	375	1958
<b>Producer D</b>	France – La Madeleine	600	1884
<b>Producer E</b>	Germany – Stassfurt	450	1886
<b>Producer F</b>	Poland – Janikowo	550	1957
	Poland – Inowroclaw	550	1879
<b>Producer G</b>	Turkey – Mersin	800	1975
<b>Producer H</b>	Romania – Govora	400	1960
<b>Producer I</b>	Romania – Ocna Mures	310	1894
<b>Producer J</b>	Bosnia – Herzegovina	260	1893
<b>Producer K</b>	Germany – Ludwigshafen	65	-
<b>Total</b>	<b>EU-25 + 4 Countries</b>	<b>10760</b>	<b>1873 – 1975</b>

(\*) All these plants have been revamped several times in order to implement technology upgrade and plant capacity has been increased progressively to follow market demand.  
Note 1: EU-25 soda ash capacity 7790 kt per year.  
Note 2: In total EU-25 + (Bulgaria, Romania, Turkey and Bosnia–Herzegovina) soda ash capacity is estimated at 10760 kt per year.  
Note 3: Compared to Table 2.2, Table 2.3 does not include soda ash capacity in Russia and Ukraine.  
Note 4: Soda ash plant in Ludwigshafen is based on a special process related to the production of caprolactam

**Table 2.3: European soda ash capacity and producers (reference year: 2002)**  
[33, CEFIC-ESAPA, 2004]

Production sites in the European Union (EU-25), are shown on a map in Figure 2.1 (reference year 2002). Consistent with data included in Table 2.3, the map in Figure 2.1 also indicates the locations of five soda ash plants in four countries outside of the EU-25 (Bulgaria 1, Romania 2, Turkey 1, Bosnia – Herzegovina 1).

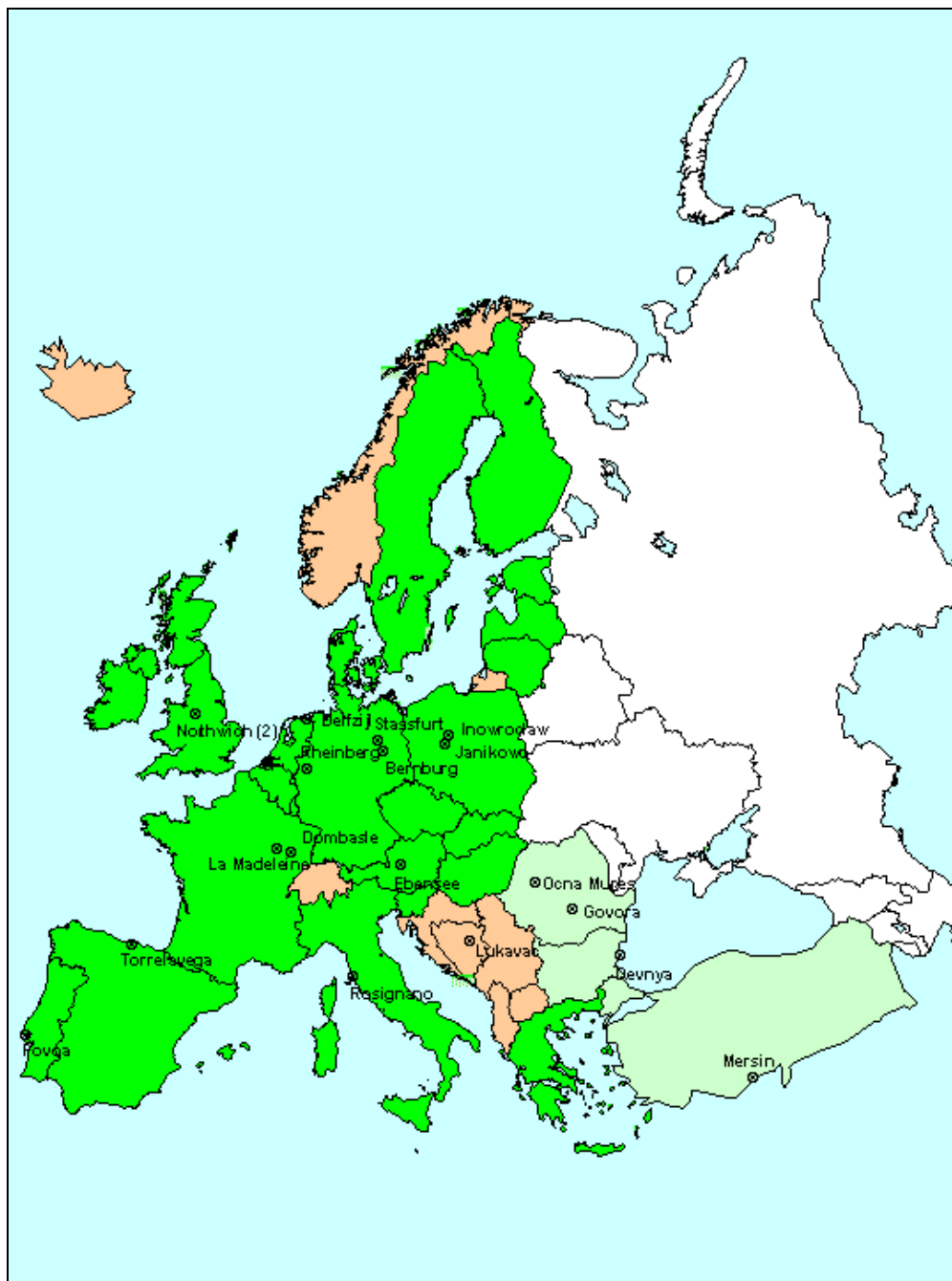


Figure 2.1: Distribution of soda ash plants within the EU-25 and outside (Solvay process, 2002) [33, CEFIC-ESAPA, 2004]

## **2.1.5 Socio-economic aspects**

### **2.1.5.1 Social integration – employment**

The total number of people employed directly by the European producers (EU-25) is estimated at 8500 persons (or about 900 t per person employed per year). These numbers depend upon the boundary of operation and vary from site to site. Furthermore, there are a certain number of subcontractors working in the plants on activities such as bagging, loading, transport, engineering, construction, and maintenance. These activities can be estimated as needing 14000 persons, and thus about 22500 people are employed, directly and indirectly, in the production of soda ash and derivatives in the EU.

### **2.1.5.2 Capital intensity in the EU soda ash industry**

The estimated invested capital necessary to build a new soda ash plant in the EU is very high: about EUR 600/t of annual capacity (excluding the cost of steam and power plant). The current economic situation in the EU does not justify the construction of new plants and for many years producers have been progressively revitalising and modernising existing plants (refer to Sections 1.1.4.3 and 2.1.1).

### **2.1.5.3 General economic standing**

Since the end of the 1980s, the progressive opening of the borders, the reduction of trade barriers and transportation costs have created very competitive conditions in the soda ash sector. Today, the soda ash market can be considered as a worldwide and predominant commodity.

The European Union soda ash industry has suffered severely from these changes. In the last ten years, six plants have been shut down: three in Germany, one in France, one in Belgium and one in Austria (closed in 2005).

Constant efforts have been made by the EU soda ash industry to improve its competitiveness in order to resist cheap Eastern Europe and US soda ash imports. The soda ash industry in these regions for many years has been, and in several instances still is, favoured by lower energy costs both for natural gas and electricity.

On top of this, one tonne of soda ash produced in the US from trona requires less energy than that based on the Solvay process [91, Takuji Miyata, 1983], [82, UNIDO, 1988]. This cost advantage is, however, reduced by a higher transportation cost of soda ash being exported from the US to Europe.

Also, total manpower costs in the EU are, in general, significantly higher than in the US and than in Eastern Europe [9, CEFIC, 2004].

### **2.1.5.4 Environmental taxes and levies**

The soda ash sector is especially sensitive to environmental taxes or levies when they are based on occupied surface, water consumption or energy inputs/outputs and emission. In some countries of the EU, the total amount of taxes and levies, including local taxes, energy, mining, housing, training, and properties (only some of them fully attributable to the environment), is as high as EUR 6.4/t soda ash.

### 2.1.5.5 Manufacturing and operating cost

Exact figures for production costs are confidential. A rough indication provided by consultants is given in Table 2.4.

Item	Cost (EUR/t soda ash)
Raw materials	25
Energy	40
Labour	35
Maintenance	20
<b>Total (cash costs)</b>	<b>120</b>

**Table 2.4: Soda ash manufacturing costs**  
[33, CEFIC-ESAPA, 2004]

These data need to be considered carefully since operating costs will vary depending on a number of factors, including plant location, ownership of raw materials, energy sources etc.

## 2.2 Applied processes and techniques

### 2.2.1 The Solvay process

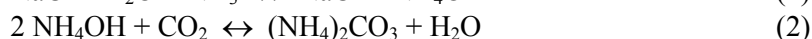
#### 2.2.1.1 Main chemical reactions

The Solvay process for the production of soda ash may be summarised by the theoretical global equation involving the two main components: sodium chloride and calcium carbonate.

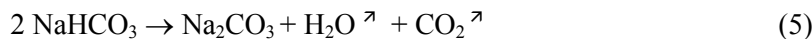


In practice this direct way is not possible and it needs the participation of other substances and many different process steps to get the final product: soda ash.

The first reactions occur in the salt solution (brine). First of all, ammonia is absorbed (1) and then, the ammoniated brine is reacted with carbon dioxide to form successive intermediate compounds: ammonium carbonate (2) then ammonium bicarbonate (3). By continuing carbon dioxide injection and cooling the solution, precipitation of sodium bicarbonate is achieved and ammonium chloride is formed (4). Chemical reactions relative to different steps of the process are given below:

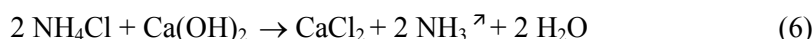


Sodium bicarbonate crystals are separated from the mother liquor by filtration, then sodium bicarbonate is decomposed thermally into sodium carbonate, water and carbon dioxide (5).



CO<sub>2</sub> is recovered in the carbonation step (see equations 2 and 3 above). The CO<sub>2</sub> recovery cycle is shown in Figure 2.2 below.

The mother liquor is treated to recover ammonia. The ammonium chloride filtrate (4) is reacted with alkali, generally milk of lime (6), followed by steam stripping to recover free gaseous ammonia:



NH<sub>3</sub> is recycled to the absorption step (equation 1 above). The ammonia recovery cycle is shown in Figure 2.2.

Carbon dioxide and calcium hydroxide originate from limestone calcination (7) followed by calcium oxide hydration (8).



Brine (NaCl) has to be treated before being input into the process to remove impurities: calcium and magnesium. If these are not removed, they would react with alkali and carbon dioxide to produce insoluble salts contributing to scale formation inside the equipment. Brine purification reactions are described in the following equations:



The sodium carbonate formed (equation 5) is called 'light soda ash' because its pouring density is approximately  $0.5 \text{ t/m}^3$ .

A subsequent operation called densification enables this value to be approximately doubled by either crystallisation to sodium monohydrate (equation 11) followed by dehydration (equation 12) or, occasionally, by the compaction of light soda ash. The final product is 'dense soda'.



### 2.2.1.2 Process steps

The Solvay process has been described in several references, such as: [33, CEFIC-ESAPA, 2004], [13, EIPPCB, 2000], [41, Solvay S.A., 2003], [39, S. Leszczynski et al, 1978]. Chemical reactions described in Section 2.2.1.1 are realised industrially in the different process steps (plant areas) as illustrated in Figure 2.2.

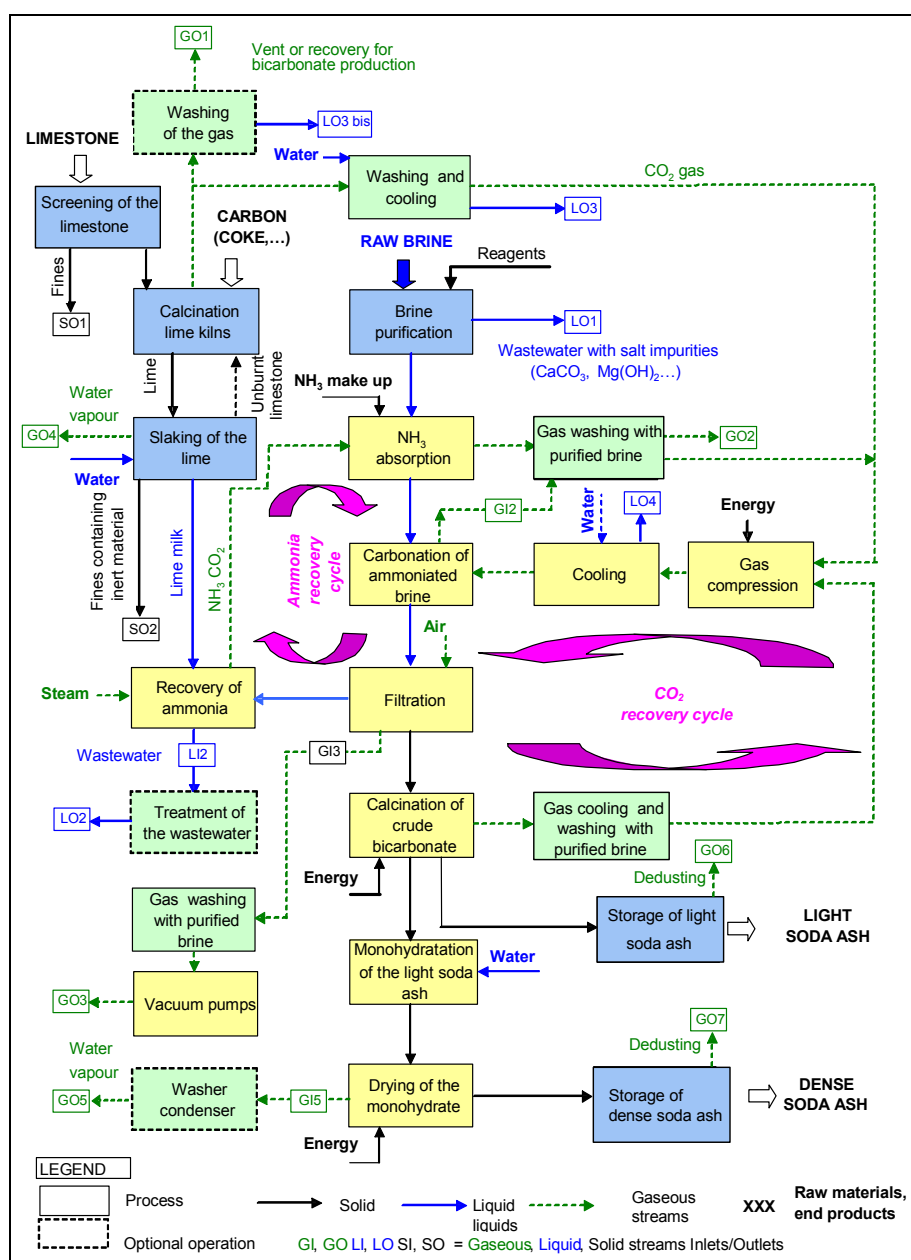


Figure 2.2: Process flow diagram for the manufacture of soda ash by the Solvay process [33, CEFIC-ESAPA, 2004]

The usual names of the plant area where the main process operations take place are given in Table 2.5.

Area	Operation
Brine purification	Brine preparation (9) (10) (*)
Lime kilns and slaker (dissolver)	Limestone calcination and milk of lime production (7) (8)
Absorption	Absorption of ammonia (1)
Columns (Carbonation Towers)	Precipitation of NaHCO <sub>3</sub> (2) (3) (4)
Filtration	Separation of NaHCO <sub>3</sub> crystals from mother liquor
Calcination	Decomposition of NaHCO <sub>3</sub> to Na <sub>2</sub> CO <sub>3</sub> (5)
Distillation	Recovery of ammonia (6)
Densification	Production of dense soda ash (11) (12)
(*) Figures in brackets refer to equations in Section 2.2.1.1	

**Table 2.5: Plant areas/operations in the soda ash plant based on the Solvay process [33, CEFIC-ESAPA, 2004]**

### 2.2.1.2.1 Brine purification

Impurities such as calcium and magnesium have to be removed from brine. This operation is achieved in the brine purification area. Magnesium ions, Mg<sup>2+</sup>, are precipitated as insoluble magnesium hydroxide Mg(OH)<sub>2</sub>, by the addition of an alkaline reagent. The most commonly used reagent is milk of lime as it is already produced in large quantities for ammonia recovery; another possibility is to use sodium hydroxide (NaOH). Calcium ions Ca<sup>2+</sup> are precipitated as insoluble calcium carbonate CaCO<sub>3</sub>, by reaction with sodium carbonate. Depending on the purification process used and the sulphate and magnesium contents, a certain amount of calcium can be precipitated as gypsum (CaSO<sub>4</sub>·2H<sub>2</sub>O).

Addition of these two reagents is regulated in such a way as to reach the necessary reagents' excess for adequate purification. A sufficient reaction time of the suspension, that contains suspended CaCO<sub>3</sub> and Mg(OH)<sub>2</sub>, ensures a correct crystallisation of the two components. Thereafter, the separation of Mg(OH)<sub>2</sub> and CaCO<sub>3</sub> from the purified brine is usually achieved in a decanter or brine settler. The decanter has to be purged frequently (stream LO1 in Figure 2.2). The purge can be treated in the same way as the distillation waste water (see Section 2.3.10) or sent back to salt wells or cavities after treatment (see Section 2.3.10.2.2).

### 2.2.1.2.2 Lime kilns and milk of lime production

Theoretically, in the soda ash process, the CO<sub>2</sub> balance is stoichiometrically neutral. However, a CO<sub>2</sub> excess is needed to compensate the incomplete absorption of CO<sub>2</sub> in the carbonation stage, in the different washers (streams GO2 and GO3), and its losses in the treatment of the mother liquid in the distillation area (LI2). This CO<sub>2</sub> excess is generated by combustion of (normally) coke, which provides energy used for limestone decomposition and is the additional source of CO<sub>2</sub>. Burning of the limestone (natural form of CaCO<sub>3</sub>) is carried out in a temperature range of 950 to 1100 °C.

The operating conditions of a lime kiln fitted to soda ash production are critically different from those used for lime production, because of the need to produce a gas with the maximum concentration of carbon dioxide for its subsequent use in the process. This is done to the detriment of the purity of produced lime, which will be less than that necessary in the lime industry (see the BREF on Cement and Lime Manufacturing Industry). To improve the particle size of limestone loaded into the lime kiln, screening is sometimes carried out prior to kiln charging (stream SO1 in Figure 2.2).

Taking into account the quantities of limestone to be burned and the necessary CO<sub>2</sub> concentration to be achieved in soda ash plants, the energy contribution is generally provided by means of solid high carbon fuels such as coke, coal or lignite.



The use of gaseous fuel would lead to too low a CO<sub>2</sub> concentration in the gas produced, making its subsequent use impossible without an additional reconcentration unit.

Raw burned lime produced by lime kilns associated with a soda ash plant contains approximately 75 to 90 % of CaO. Although in the 'Akzo' variant of the Solvay process – refer to Section 2.1.2.1 – 'dry lime' is used locally, with some benefits, direct use of raw burned lime in a solid form is uncommon because of the difficulty in controlling an adequate feed rate of a material in which the active constituent, CaO, is not constant. By hydrating the CaO to milk of lime, a better control of the alkali addition is achieved during the ammonia recovery step.

Hydration of the raw lime is carried out in slakers (dissolvers) where raw lime and water flows are regulated to ensure that the alkali content of milk of lime produced is as constant as possible.

This reaction is highly exothermic. Part of the heat generated causes some water to vaporise which is released from the slaker vent (GO4). During the hydration, fine inert materials contained in limestone (sulphates, silica, clay, silico-alumina compounds, unburned limestone and others) can mainly be found in milk of lime. Larger particles are separated by screening, then washed and recycled or released out of the process (stream SO2 in Figure 2.2). The unburned pieces of limestone are recycled.

### 2.2.1.2.3 Absorption of ammonia

Ammonia is recovered by recycling the outlet gas from the distillation plant to the absorption stage where it is absorbed in purified brine. This flow mainly contains recovered NH<sub>3</sub> and a quantity of CO<sub>2</sub>. This chemical operation is performed in equipment that allows close gas/liquid contact. As ammonia absorption is an exothermic reaction, cooling of the liquid is necessary during the operation to maintain efficiency. The outlet solution, with a controlled ammonia concentration, is called ammoniacal brine. Any gas that is not absorbed (stream GI2) is sent to the washer, where it is put into contact with purified brine to remove traces of ammonia before it is recycled or released to the atmosphere (stream GO2).

### 2.2.1.2.4 Precipitation of sodium bicarbonate

Ammoniacal brine is progressively CO<sub>2</sub>-enriched (carbonated) with recycled carbon dioxide from sodium bicarbonate calcination and carbon dioxide originating from lime kilns. To ensure adequate CO<sub>2</sub> absorption and sodium bicarbonate precipitation, the ammoniacal brine is cooled with water. The suspension of crystals exiting from columns or carbonators is sent to the filters. Outlet gas from the carbonation towers is sent to a final washer, where it is put into contact with purified brine to absorb NH<sub>3</sub> traces still present in the gas, before being released to the atmosphere (stream GO2). Optionally, separate or combined washers with waste gas from the absorber vacuum system may be used.

### 2.2.1.2.5 Separation of sodium bicarbonate from the mother liquor

Separation of sodium bicarbonate crystals from the mother liquor is achieved by means of centrifuges or vacuum filters. After washing the cake to eliminate the mother liquor, the cake is sent to the calcination step. The liquid phase 'mother liquor' is sent to the distillation area for ammonia recovery. Where filters are used, air is pulled through the cake by means of vacuum pumps. Thereafter, this gas carrying ammonia and some CO<sub>2</sub> (stream GI3) is cleaned in a washer fed with purified brine before being released to the atmosphere (stream GO3).

'Crude' sodium bicarbonate manufactured by the carbonation process is the primary 'output' of the Solvay ammonia soda process. The bicarbonate produced in this way is fed to the calcination stage (Section 2.2.1.2.6), where it is converted to the finished solid soda ash product.

In some cases a small part of this 'crude' bicarbonate which, although predominantly sodium bicarbonate, also contains a mixture of different salts (ammonium bicarbonate, sodium carbonate and sodium chloride), may be extracted from the Solvay process cycle to be dried as a 'crude' bicarbonate product made without purification, by a simple drying process. This crude product may find applications in some commercial outlets. However, since any drying gases produced by this simple process are handled in combination with gases from the Solvay ammonia soda ash process and common abatement technology is applied, this process is not described in more detail. 'Crude' bicarbonate must not be confused with refined sodium bicarbonate, which is a purified product manufactured according to the process described in Section 2.3.6.2.

#### 2.2.1.2.6 Sodium bicarbonate calcination

Sodium bicarbonate cake is heated (160 to 230 °C) to achieve calcination into a solid phase 'light soda ash' and a gaseous phase containing CO<sub>2</sub>, NH<sub>3</sub> and H<sub>2</sub>O.

This gas is cooled to allow water to condense from it. The condensate formed is sent to distillation for NH<sub>3</sub> recovery, either directly or via filter wash-water. After cleaning, the gas (high CO<sub>2</sub> concentration) is compressed and sent back to the carbonation columns (see CO<sub>2</sub> recovery cycle in Figure 2.2).

Normally, the energy needed for the calcination of sodium bicarbonate is provided by steam that condenses in a tubular heat exchanger which rotates through the bulk of sodium bicarbonate. The method, consisting of heating externally by gas or fuel oil combustion in a rotating drum containing sodium bicarbonate, is occasionally encountered in the soda ash industry.

#### 2.2.1.2.7 Ammonia recovery

One of the major achievements of the Solvay process is the high efficiency of the ammonia recycle loop illustrated in Figure 2.2. This loop circulates roughly 500 to 550 kg NH<sub>3</sub>/t soda ash from which the ammonia loss is less than 0.5 % of this flowrate. The purpose of this important process 'distillation' is to recover ammonia from the ammonium chloride containing mother liquors recovered from the bicarbonate filters/centrifuges.

After being preheated with outlet gas from the distiller, supported by the injection of steam at the bottom of the NH<sub>3</sub> stripping column, the mother liquor releases almost all its CO<sub>2</sub> content. Addition of alkali normally in the form of milk of lime decomposes NH<sub>4</sub>Cl into CaCl<sub>2</sub> and NH<sub>3</sub> which is stripped from the solution by injecting low pressure steam at the bottom of the distillation column. The outlet solution contains calcium chloride together with all the residual solid materials. The yield of ammonia recovery is controlled according to the required minimum of ammonia concentration in the released liquid. The lower the required value, the higher the quantity of stripping steam and, therefore, the higher global energy consumption (cross-media effects), and the higher the cost of the ammonia recovery. Based on local considerations, an optimum value can be found. This control can only be applied up to a theoretical minimum ammonia concentration level.

After cooling and condensation of steam, the gaseous phase containing recovered CO<sub>2</sub> and NH<sub>3</sub> is returned to the absorption area for re-use. The liquid phase coming out of the distillation unit contains: unreacted sodium chloride (reaction (4) given in Section 2.2.1.1 is not complete due to thermodynamic and kinetic limitations), calcium chloride resulting from a reaction with NH<sub>4</sub>Cl, solid matter that is derived primarily from the original limestone and, finally, a small quantity of lime maintained in an excess that can ensure a total decomposition of NH<sub>4</sub>Cl. This liquid, called 'DS-liquid' or 'Distiller Blow Off (DBO)' (stream LI2 in Figure 2.2), is treated in different ways depending on the particular site and processes used. Clear liquid derived from the 'DS-liquid' can be further used for the production of calcium chloride. Various grades are produced to suite the market requirements, including concentrated CaCl<sub>2</sub> solutions and hydrated or anhydrous solids.

### 2.2.1.3 Product storage and handling

Soda ash has to be stored in a dry place to avoid hydration, crusts formation or hardening. Precautions are taken to prevent contamination by other nearby stored products, and to prevent the release of soda ash dust during handling (refer to the BREF on Emissions from Storage).

Most of the time, sodium carbonate is stored in large capacity metallic or concrete silos. Because of high daily capacity of large production units (1000 t/day or more), the available total storage volume is normally for less than a week's production.

Bulk handling of dense soda ash is easily achieved, for example, by belt conveyor. Necessary precautions have to be taken to avoid and control dust release. Handling methods are selected to minimise any particle size reduction of the product.

### 2.2.2 Raw materials

Because the production of sodium carbonate is a large-tonnage, low cost operation, the plants have been historically situated close to some or all of the critical raw materials deposits (limestone, salt deposits, water) to reduce the transport cost.

It should be stressed that the selection of raw materials is a decision of strategic importance, as the quality of raw materials has a direct influence on the quantities of waste produced – refer in particular to Sections 2.2.2.1, 2.2.2.2, 2.2.2.3, 2.2.4.1, 2.3.4.1, 2.4.7, and 2.4.7.1 below.

One of the important issues, relating to the quality of raw materials used for the production of soda ash, is the load of heavy metals in suspended solids discharged with waste waters from the distillation unit – refer in particular to Section 2.2.4.1.1 below.

It should be noted, however, that the selection of raw materials is based on a number of critical factors, among which the heavy metals content is only one of the aspects that has to be considered. As heavy metals naturally occur, to a various degree, in the main raw materials used (limestone and salt brine), the producers have only limited influence on reducing the quantity of heavy metals entering soda ash plants.

#### 2.2.2.1 Brine

Sodium chloride (i.e. common salt) is extracted by solution mining from underground deposits formed during the geological periods (Mesozoic and Cenozoic eras) by the evaporation of seawater. In the Solvay process, the sodium chloride reacts in a liquid phase. This is known as brine which contains as much sodium chloride as possible (around 300 g NaCl/l) and is virtually saturated. This brine also contains impurities, mainly magnesium, calcium and sulphate (see Section 2.2.1.2.1). In several cases the mother liquor from the salt production process can also be used as raw material to partially replace brine when the liquor has a suitable composition for the soda ash process.

The basic criteria to select raw brine include [108, CEFIC-ESAPA, 2005]:

- maximum purity of salt, to avoid excessive purification costs
- appropriate thickness of the deposit, allowing technically viable extraction and economic exploitation.

The raw and purified brine can be stored in open tanks made of mild steel, polymers, or in open lined reservoirs.

### 2.2.2.1.1 Typical brine composition

A typical composition of raw and purified brine is given in Table 2.6.

Composition (g/l)	Raw brine	Purified brine
Na <sup>+</sup>	120 – 125	115 – 125
Cl <sup>-</sup>	186 – 192	180 – 190
SO <sub>4</sub> <sup>2-</sup>	2.4 – 10	2.6 – 8.5
Ca <sup>2+</sup>	0.8 – 1.7	0 – 0.2
Mg <sup>2+</sup>	0 – 1.5	0 – 0.1
CO <sub>3</sub> <sup>2-</sup>		0.4 – 0.9
OH <sup>-</sup>		0 – 0.3

**Table 2.6: Raw and purified brines (typical composition ranges)**  
[33, CEFIC-ESAPA, 2004]

It should be noted that raw brine also contains heavy metals, however the importance of heavy metals in raw brine is relatively low, at about 6 % of the total heavy metals entering the soda ash plant (see Section 2.2.4.1.1 below). Also, the heavy metals content in raw brine varies over time.

### 2.2.2.2 Limestone

Limestone deposits originate from calcareous shell and skeletons of biota as well as chemical and biochemical precipitation in the sea during the Mesozoic and Palaeozoic eras.

Basically, a high content of CaCO<sub>3</sub> in the limestone is an important parameter to avoid difficulties related to the limestone calcination and to improve production efficiency. The cost to transport the inert part of the limestone from the quarry to the soda ash plant is also minimised.

A limestone rich in CaCO<sub>3</sub> (see Section 2.2.4.1 for other relevant limestone properties) will not only allow a reduction of solid matters in the effluent of the distillation unit but, for those soda ash plants that have settling, it will also allow a reduction in the volume of solids to be treated.

Particle size distribution of the limestone from quarries is generally between 40 and 200 mm. The more homogeneous it is, the better the lime kiln will work but the greater the amount of limestone fine by-product produced at the quarry will be.

The following are basic criteria and a hierarchy to select a suitable limestone source [107, CEFIC-ESAPA, 2005], [108, CEFIC-ESAPA, 2005], [39, S. Leszczynski et al, 1978]:

- chemical quality, including:
  - limestone purity, in terms of CaCO<sub>3</sub> content (%)
  - impurities, mainly concerning MgCO<sub>3</sub> content (%)
- physical characteristics, including:
  - size of lumps of limestone fed to the lime kilns in a range as narrow as possible
  - appropriate hardness of limestone, to withstand handling operations between the limestone quarry and soda ash plant and resistance to compression in the vertical shaft lime kilns
  - low porosity (not to allow excessive retention of water in the limestone)
  - appropriate burning properties of limestone, suited for burning in a vertical shaft lime kiln, thus allowing a high yield to reactive lime to be obtained
- location of limestone deposit
- availability of economic transport
- heavy metals content in naturally occurring limestone deposits.

Therefore, in selecting a suitable limestone source, the appropriate set of parameters has to be established for any particular location. It should be stressed that limestone deposits are normally selected prior to the construction of a given soda ash plant, and limestone quarries are typically exploited through the life-time of a soda ash plant, with limited prospects for major sourcing changes.

In specific local conditions, limestone deposits can be shifted from one to another (depletion of a deposit, encountered limestone layers of much lower quality, requiring selective quarrying), but normally the selection of a limestone deposit is a decision of strategic importance for the design, construction and further exploitation of a soda ash plant – refer to Section 2.4.7.1.

Due to its particle size distribution and consequent low drift sensitivity, the storage of limestone requires no specific precaution other than that normally adopted, i.e. open ground storage.

### 2.2.2.2.1 Typical limestone composition

Limestone quality is a very important parameter in the production of soda ash, as it has a direct influence on the level of solids discharged with the waste waters from the distillation unit.

There is no typical composition of limestone used by the 14 soda ash plants across the EU-25, and CaCO<sub>3</sub> content in the limestone varies in the range of 84 – 99 % [33, CEFIC-ESAPA, 2004], [85, EIPPCB, 2004-2005]. However, the higher the CaCO<sub>3</sub> content in the limestone and the less impurities, especially heavy metals, the more suitable the limestone is for lessening the impact from the production of soda ash on the environment.

Based on recent analyses performed in European limestone quarries [107, CEFIC-ESAPA, 2005], [108, CEFIC-ESAPA, 2005], data on averages of the composition of some limestones used for the production of soda ash in the EU-25 are given in Table 2.7 (refer also to Section 2.4.7.1 on selection of appropriate quality limestone, salt brine and coke).

Quarries	unit	1	2	3	4	5	6	7	8	9
CaCO <sub>3</sub>	%	99.0	98.4	99.2	97.6	95.0	89.1	97.8	84.8	96.2
MgCO <sub>3</sub>	%	0.44	1.03	0.54	1.41	1.41	0.89	1.19	4.44	1.47
SiO <sub>2</sub>	%	0.15	0.35	0.54	0.56	0.97	0.12	0.11	4.68	0.56
SO <sub>3</sub>	%	0.04		0.01	0.15	0.14	0.18	0.15	0.45	0.01
Al <sub>2</sub> O <sub>3</sub> + Fe <sub>2</sub> O <sub>3</sub>	%	0.10	0.17	0.10	0.10	0.44	0.10	0.12	2.21	0.57
Heavy metals										
As	ppm	0.32	0.3	0.67	0.3	1.4	<1.3	0.48	<0.02	1
Cd	ppm	0.41	0.34	0.57	0.3	0.2	<0.15	0.12	<0.002	0.4
Cr	ppm	3.21	5.81	6.18	2.7	0.7	<3.8	1.4	<0.09	1.5
Cu	ppm	0.94	3.02	1.4	0.4	0.7	<0.6	1.25	<0.002	1.5
Hg	ppm	0.001	0.001	0.001	0.010	0.015	<0.025	0.220	<0.015	0.020
Ni	ppm	1.04	1.36	2.53	0.9	1.2	<3	0.89	<0.02	2.1
Pb	ppm	10.21	0.85	1.7	1.3	14.1	<3.1	45.1	<0.02	1.8
Zn	ppm	42.43	3.28	14.1	3.4	14.7	<1.4	9.2	<0.14	7.9

**Table 2.7: Composition of some limestones used for the production of soda ash in the EU-25 [107, CEFIC-ESAPA, 2005]**

In the illustrative example of Table 2.10 (see Section 2.2.4.1.1 below) it should be noted that limestone contains about 73 % of the total heavy metals entering the soda ash plant. The origin of heavy metals in limestone is from natural abundance of these elements in the bulk stone (when the limestone was geologically deposited and in the late phase of mineralisation along fault lines in limestone formation). Variations between different limestone sources for individual elements are noted.

### 2.2.2.3 Carbon for limestone burning in the lime kiln

Coke, and rarely coal, are used for limestone burning in lime kilns for soda ash production due to the necessity to obtain the highest CO<sub>2</sub> concentration possible. Other type of fuels, natural gas or fuel oil, would result in too low a CO<sub>2</sub> concentration in the kiln gas. This is very important as the kiln gas is further used in the process for its CO<sub>2</sub> contents. Higher CO<sub>2</sub> concentration in the kiln gas enables the reduction of the equipment size and prevents ammonia losses.

The particle size distribution of the solid fuel has to be appropriate in order to get an homogeneous distribution within the kiln. Basic criteria to select suitable quality coke used for limestone burning in the lime kiln include [108, CEFIC-ESAPA, 2005]: size, hardness, high carbon content, and reactivity.

Coke is stored in an open ground storage (refer to the BREF on Emissions from Storage).

#### 2.2.2.3.1 Typical coke composition

Typical compositions for coke to the lime kiln are given in Table 2.8.

Constituents	Coke
H <sub>2</sub> O (kg/t)	40 – 70
Volatiles (kg/t)	0 – 30
Fix carbon (kg/t)	800 – 890
Ashes (kg/t)	60 – 110
Net calorific value (GJ/t)	26.6 – 29.6

**Table 2.8: Coke for lime kilns (typical composition ranges)**  
[33, CEFIC-ESAPA, 2004]

In the illustrative example of Table 2.10 (see Section 2.2.4.1.1 below) it should be noted that coke contains about 21 % of the total heavy metals entering the soda ash plant, however, the heavy metals content in the coke is the highest, on average approx. 95 mg/kg dry coke – see Section 2.2.4.1.1 below [108, CEFIC-ESAPA, 2005].

### 2.2.2.4 Ammonia

#### 2.2.2.4.1 Ammonia characteristics

The Solvay soda ash process requires an input of ammonia to compensate for the inherent losses from the process. The input is generally carried out either as aqueous ammonia solution (10 to 35 %), or direct injection of anhydrous gaseous ammonia into the purified brine, or by the use of an aqueous solution of ammonium bisulphide. The addition of ammonia to the soda ash process may also be achieved by the use of ammoniacal liquor from coal gas plants.

#### 2.2.2.4.2 Ammonia storage

The aqueous ammonia solution is stored in steel tanks. Specific precautions are taken during maintenance of the equipment, because mixtures of air and NH<sub>3</sub> are explosive when in contact with a heat source or flame (16 – 26 % NH<sub>3</sub> in air).

When liquified NH<sub>3</sub> is stored, additional specific preventive measures are required for safety.

### 2.2.2.5 Miscellaneous additives

In addition to the major raw materials, there are a number of miscellaneous raw materials which may be added to the process for their various physical attributes, such as: compounds to aid gas absorption, compounds to avoid scaling, corrosion inhibitors, and settling aids.

### 2.2.3 Main output streams

The main streams leaving the process under solid, liquid or gaseous form are summarised in Table 2.9, closely related to the flow sheet presented in Figure 2.2. Details about composition and treatment options of these streams are covered in Section 2.3.

Stream	Description
LO1	Waste water from brine purification
LI2 (LO2)	Waste water from distillation (after optional treatment)
LO3 and LO3bis	Waste water from washing/cooling of lime kiln gas
LO4	Water from compressed gas cooling
GO1	Vent gas from lime kiln, not used to carbonation
GO2	Vent gas from columns washing, not recycled to carbonation
GO3	Air from bicarbonate filtration, after washing
GO4	Waste gas from lime slaking
GO5	Water vapour from densification (monohydrate drying)
GO6	Air from light soda ash dedusting
GO7	Air from dense soda ash dedusting
SO1	Solids from screening of limestone upstream of kiln
SO2	Solids from screening milk of lime

Table 2.9: Main output streams from the soda ash process [33, CEFIC-ESAPA, 2004]

### 2.2.4 Options for process optimisation and improvement

The possibilities to improve the process are mainly connected with yield increase, the reduction of raw materials and energy consumption, and with the reduction of environmental impact.

#### 2.2.4.1 Purity of raw materials

The purity of raw materials has a direct influence on the specific consumptions of the process and the quantities of waste (residues) produced. Limestone with a high  $\text{CaCO}_3$  content will produce a milk of lime with a relatively low inert content, resulting in less solids from distillation units and less subsequent treatment.  $\text{CaCO}_3$  content in the limestone is in the range 84 – 99 %. This variation induces a ratio of 1 to 16 in the non convertible content of the limestone.

Similarly, a crumbly limestone produces a lot of fines that need to be removed before it is put into the kilns. The more robust the stone is, the less fines that are produced. The quantity of fines ranges from 2.5 to 25 % of the limestone fed to the kiln. These properties are inherent to the limestone available in the region (restricted choice) and cannot, therefore, be modified. Salt used in the form of brine contains more or less impurities following the composition of the salt deposit. So, the quantity of precipitated impurities will be directly dependent on its source.

The soda ash plant is normally located near salt and limestone deposits to reduce transportation costs. Using salt or limestone from other deposits will normally not be economically viable, unless in specific local conditions a deposit located nearby with a higher level of raw material purity can be chosen.

### 2.2.4.1.1 Heavy metals in raw materials used for the production of soda ash

Based on analytical and research work [107, CEFIC-ESAPA, 2005], [108, CEFIC-ESAPA, 2005], an approximate illustration of the load of heavy metals contained in the raw materials used by the EU-25 soda ash plants is given below in Table 2.10.

HEAVY METALS (HM): INLET IN A SODA ASH PLANT										
Typical values <sup>(3)</sup>										
	Units	As	Cd	Cr	Cu	Hg	Ni	Pb	Zn	Sum
<b>Limestone</b>										
HM content	mg/kg dry	0.49	0.31	2.93	1.50	0.02	1.71	6.58	10.08	23.63
Limestone consumption	t/t soda ash	1.33 <sup>(4)</sup>								
Heavy metals	g/t soda ash	<b>0.65</b>	<b>0.41</b>	<b>3.88</b>	<b>1.99</b>	<b>0.03</b>	<b>2.27</b>	<b>8.72</b>	<b>13.35</b>	<b>31.31</b>
	% of total									73
<b>Fuel</b>										
HM content	mg/kg dry	2.29	0.30	19.99	18.78	0.17	19.76	10.35	23.65	95.29
Fuel consumption	kg/t soda ash	94.4								
Heavy metals	g/t soda ash	<b>0.22</b>	<b>0.03</b>	<b>1.89</b>	<b>1.77</b>	<b>0.02</b>	<b>1.86</b>	<b>0.98</b>	<b>2.23</b>	<b>8.99</b>
	% of total									21
<b>Raw brine</b>										
HM content	mg/l	0.044	0.009	0.032	0.017	0.000	0.023	0.133	0.254	0.51
Brine consumption	m <sup>3</sup> /t soda ash	5								
Heavy metals	g/t soda ash	<b>0.22</b>	<b>0.04</b>	<b>0.16</b>	<b>0.08</b>	<b>0.00</b>	<b>0.12</b>	<b>0.66</b>	<b>1.27</b>	<b>2.56</b>
	% of total									6
<b>Total inlet HM</b>										
	g/t soda ash (or ppm)	<b>1.1</b>	<b>0.5</b>	<b>5.9</b>	<b>3.8</b>	<b>0.1</b>	<b>4.3</b>	<b>10.4</b>	<b>16.9</b>	<b>42.9</b>
	% of total									100
If the total quantity of HM leaves the soda ash plant in the liquid effluents of NH <sub>3</sub> recovery, the load will be:										
	Units	As	Cd	Cr	Cu	Hg	Ni	Pb	Zn	Sum
HM concentration <sup>(1)</sup>	mg/l	0.11	0.05	0.59	0.38	0.01	0.43	1.04	1.69	4.29
	mg/kg	0.10	0.04	0.54	0.35	0.00	0.39	0.94	1.53	3.90
HM loads, one plant <sup>(2)</sup>	kg/year	544	239	2964	1921	25	2125	5182	8429	21429
(1) For a specific volume blow-off of NH <sub>3</sub> recovery: 10 m <sup>3</sup> /t soda ash (2) For a capacity of a medium sized soda ash plant: 500 kt soda ash/year (3) The figures presented are the result of momentaneous data collection and therefore should not be used as representative of all the yearly average data for all plants (4) Limestone consumption – limestone entering the lime kiln after fines have been sieved off (see Figure 2.2, SO1).										

**Table 2.10: Heavy metals in the raw materials entering soda ash plants in the EU-25 [107, CEFIC-ESAPA, 2005], [108, CEFIC-ESAPA, 2005]**

The following list gives characteristic features of heavy metals distribution in the raw materials used for the manufacture of soda ash:

- of the total amount of heavy metals entering a soda ash plant, approximately:
  - 73 % are derived from the limestone
  - 21 % from the fuel used for burning the limestone
  - 6 % from the salt brine
- each raw material has its own heavy metals distribution
- the main contributors of heavy metals are limestones, followed by fuel for the burning of limestone (in which the concentration of heavy metals is highest), the contribution of the raw brine being relatively low
- the total load of the analysed heavy metals entering the EU soda ash plants represents a quantity of approximately 43 grams per tonne of soda ash (or ppm).

It should be stressed that these data are based on several averages derived from more detailed data on the concentrations of heavy metals in limestone, salt brine and coke, and although these are characteristic for the EU soda ash industry, they do not represent any specific plant situation.



As can be assumed from the above data, the quantity of heavy metals entering the plant and, consequently, the load of heavy metals in the waste water outlet distillation of a typical medium sized soda ash plant with a capacity of 500 kt/year, is at the level of approximately 21.5 tonnes per year, while the overall load of heavy metals discharged from the EU soda ash plants (14 plants are located within the EU-25 – refer to Figure 2.1 above) is at the level of approximately 330 tonnes per year.

### **2.2.4.2 Raw materials consumption**

Limestone, salt and coke consumption can be reduced by an in depth knowledge of the process and, therefore, of the equipment design. In addition, the use of advanced process control technology will ensure a closer approach to a theoretical equilibrium of chemical reactions and consequently minimise the excess of reagents – refer to Section 2.3.1 below.

### **2.2.4.3 Energy**

Several possibilities to reduce the consumption of energy are available as far as the technology and economics allow. These should primarily be implemented in the initial design stages to incorporate combined heat and power generation, the efficient use of energy and appropriate heat exchange systems for energy recovery. Within the plant itself, the reduction of energy losses is ensured by favouring energy transfer between process streams at different thermal levels, by the installation of both heat exchangers and flash vessels for hot fluids. A good knowledge of the process, with the assistance of advanced control technology will lead to a reduction in energy consumption.

## 2.3 Present consumption and emission levels

Table 2.11 provides indicative ranges for the major input and output levels of the Solvay soda ash process. They are further described in Sections 2.3.1 to 2.3.11. Information concerning the major possible co-products of the soda ash process are given in Section 2.3.6.

<b>INPUT<sup>(5)</sup></b>	
<b>Main raw material</b>	<b>kg/t soda ash</b>
Limestone	1050 – 1600 (inlet lime kiln) 1090 – 1820 (inlet plant)
Raw brine	NaCl (1530 – 1800) + water (4500 – 5200)
NH <sub>3</sub> make up	0.8 – 2.1 <sup>(8)</sup>
<b>Water</b>	<b>m<sup>3</sup>/t soda ash (dense)</b>
Process <sup>(1)</sup>	2.5 – 3.6
Cooling	50 – 100
<b>Energy</b>	<b>GJ/t soda ash (dense)</b>
Fuels (lime kiln)	2.2 – 2.8
Fuels (soda ash) <sup>(2)</sup> , including electricity	7.5 – 10.8, 0.18 – 0.47 (50 – 130 kWh/t soda ash)
<b>OUTPUT<sup>(5)</sup></b>	
<b>Gaseous emissions</b>	<b>kg/t soda ash</b>
CO <sub>2</sub>	200 – 400
CO	4 – 20
NH <sub>3</sub> <sup>(6)</sup>	<1.5 <sup>(8)</sup>
Dust <sup>(7)</sup>	<0.2
<b>Liquid emissions (outlet distillation) <sup>(3)</sup></b>	<b>kg/t soda ash</b>
Cl <sup>-</sup>	850 – 1100
Ca <sup>2+</sup>	340 – 400
Na <sup>+</sup>	160 – 220
SO <sub>4</sub> <sup>2-</sup>	1 – 11
NH <sub>4</sub> <sup>+</sup>	0.3 – 2 <sup>(8)</sup>
Suspended solids	90 – 700
<b>Solids emissions <sup>(4)</sup></b>	<b>kg/t soda ash</b>
Fines of limestone	30 – 300
Non recycled grits at slaker	10 – 120
(1) see Section 2.3.2.2 (3) see Section 2.3.4.1 (4) see Section 2.3.5 (6) see Section 2.3.3.5 (7) see Section 2.3.3.1 (2) includes electric energy and primary fuels (gas, coal, fuel oil) for the process needs (mechanical and thermal power) without fuels for lime kilns, of that the energy required for densification to convert soda ash light into soda ash dense amounts approximately to 0.9 GJ/t soda ash [39, S. Leszczynski et al, 1978] (8) indicative upper value of input NH <sub>3</sub> make-up can be lower than the sum of upper limit outputs of gaseous and liquid NH <sub>3</sub> emissions, as the extreme emission values do not normally sum up (5) figures in this table are indicative ranges of annual averages based on various measurement or estimation techniques	

**Table 2.11: Soda ash process major input/output levels [33, CEFIC-ESAPA, 2004]**

The data in Table 2.11 is taken from plants that operate with both a number of process-integrated and end-of-pipe techniques to reduce emissions. Information regarding these techniques and their effect to minimise emissions is given in Section 2.4. Liquid emissions relate to the outlet of the distillation stage, prior to any further treatment. The different treatment schemes, relevant to specific locations, are described in Section 2.3.10.

It should be noted that consumption and emission levels relevant to brine and limestone extraction and transportation, as well as power generation and cooling systems are not included in Table 2.11 and are outside the scope of this document (refer to the BREFs on: the Cement and Lime Manufacturing Industries, Management of Tailings and Waste-Rock in Mining Activities, Large Combustion Plants, and Industrial Cooling Systems).

### 2.3.1 Raw materials

Major inputs to the process and the quality of raw materials are covered in Section 2.2.2, while Table 2.11 gives specific raw materials usage.

In order to better assess the scale of consumption of raw materials and the volume of liquid effluents discharged from the production of soda ash, the following illustrative figures relating to a medium sized 500 kt/year soda ash plant are given in Table 2.12:

Description	Unit	Production, consumption, and effluent discharge factors (*)	Annual production consumption and effluent discharge	Daily production, consumption and effluent discharge
Illustrative plant capacity (medium sized plant)	t	1.00	500000 t/year	1400 t/day
Limestone usage (at the plant inlet) (**)	t/t soda ash	1.40	700000 t/year	2000 t/day
Salt usage (NaCl in crude brine)	t/t soda ash	1.66	830000 t/year	2300 t/day
Liquid effluent volume (approximate, average)	m <sup>3</sup> /t soda ash	10	5000000 m <sup>3</sup> /year	14000 m <sup>3</sup> /day
Suspended solids (inert/unreacted solids)	kg/m <sup>3</sup> effluent	24	120000 t/year	340 t/day
(*) The factors presented are illustrative and should not be used as representative of the yearly average data of all plants.				
(**) Illustrative limestone usage prior to screening of the limestone, fines included – see Figure 2.2, stream SO1.				

**Table 2.12: Raw materials consumption and effluent discharge for a 500 kt/year soda ash plant [108, CEFIC-ESAPA, 2005]**

As can be seen from Table 2.12, soda ash plants require large quantities of the basic raw materials and this scale of production can lead to apparently significant total emissions even from a single installation, when just considered in kilograms per year [108, CEFIC-ESAPA, 2005]. These high volumes of raw materials used and emission loads are typical of the large volume chemical industry.

### 2.3.2 Utilities

#### 2.3.2.1 Steam

Steam is an important energy input into the manufacture of soda ash by the Solvay process both because of its mechanical capability (to drive a range of machinery including turbo-generators, gas compressors, vacuum machines, etc.) and as a thermal energy carrier for decomposition, distillation and drying.

A range of steam pressures and temperatures are, therefore, required to meet the process needs and maximise the energy efficiency of the process. Steam is typically generated at superpressure (SP: 100 – 150 bar) or high pressure at 60 – 80 bar. Mechanical energy is removed from the steam reducing its pressure to 10 – 40 bar (IP: intermediate pressure steam) and then to low pressure steam (LP <5 bar). IP steam is normally used for thermal decomposition and drying duties associated with the conversion of sodium bicarbonate to light soda ash, as well as the decomposition of sodium carbonate monohydrate and drying to produce dense ash. LP steam is primarily used for ammonia distillation.

The consumption of steam lies in the range of:

- for recovery of ammonia (depending on the process applied): 1300 to 2400 kg/t soda ash
- for decomposition of sodium bicarbonate: 1100 to 1300 kg/t soda ash
- for drying of monohydrate (to obtain dense soda ash): 350 to 450 kg/t soda ash.

### 2.3.2.2 Process water

Basically, the main consumer of water (apart from brine) is the slaker, where the lime coming from the lime kilns reacts with water to produce milk of lime. The quantity of process water is in the range of 1.9 to 2.4 m<sup>3</sup>/t soda ash. The quality requirement for this water is not high. It is normally taken from the outlet of the cooling water system (warm water).

Other water needs, in the range of 0.6 to 1.2 m<sup>3</sup>/t soda ash, require higher purity (i.e. absence of Ca and Mg salts) for different uses as additional wash-water to wash the sodium bicarbonate cake at the filter outlet. The above quoted process water requirements exclude the water entering into the process in the form of brine, typically 4500 – 5200 kg/t soda ash, as well as steam condensate from the distillation tower (roughly 650 kg/t soda ash).

### 2.3.2.3 Cooling waters

Several unit operations of the soda ash process are exothermic. The cooling agent is normally cooling water either in an open or closed loop. The closed loop requires a cooling tower with special water treatment. The open loop is the once-through system using, for example, river water. In the latter case, the total flow of cooling water required for:

- lime kiln gas treatment
- carbonation towers
- CO<sub>2</sub> compression
- distillation
- absorption
- calcinations.

all amount to 50 to 100 m<sup>3</sup>/t soda ash respectively depending upon the cooling water temperature. Cooling water consumption is minimised by managing different cross-flow heat exchangers.

### 2.3.2.4 Electricity

The CO<sub>2</sub> gas compressors can be driven either by electrical motors or steam turbines, with the consumption of electricity in a range of between 50 and 130 kWh/t soda ash. The consumption of energy required for CO<sub>2</sub> gas compression is directly linked to gas concentration.

### 2.3.3 Emissions to air

#### 2.3.3.1 Particulate dust

Dust is emitted from soda ash production in limited quantities, arising from the following steps:

- handling of mineral raw materials (coke, limestone) as diffuse sources
- limestone burning in kilns, but in limited quantities or during abnormal operation only, since all the process kiln gas is collected prior to a washing-cooling step and thereafter is used in the carbonation stage, whilst the excess kiln gas (which can optionally pass through a gas washing step), is either vented to the atmosphere or partially used in the production of sodium bicarbonate
- handling of soda ash and densification of light soda ash (hydration and dehydration) to produce dense soda ash
- during the handling of these products.

It is common to use bag filters or wet scrubbers which significantly reduce the levels of dust emitted to the atmosphere.

The dust emitted is around 0.10 – 0.15 kg of dust/t soda ash, and for a plant with the annual capacity of 500 kt per year, this represents a typical quantity of 50 – 75 t/year.

The composition of dust relates to the material handled, namely:

- C from coke
- $\text{CaCO}_3$ ,  $\text{Al}_2\text{O}_3$  and  $\text{SiO}_2$  from limestone (and sand and clays present in limestone)
- CaO from burned lime
- $\text{Na}_2\text{CO}_3$  and  $\text{NaHCO}_3$  from the production and transport of soda ash and sodium bicarbonate.

The high volume of gas flows that require treatment often require very large pieces of specific equipment. A number of abatement techniques are used depending on the characteristics of streams to be treated – refer to the BREF on CWW.

For dry gas streams, such as those encountered in product handling (conveying) and the storage section of a soda ash plant, dust abatement techniques normally achieve figures below  $50 \text{ mg/Nm}^3$ , and with modern equipment (e.g. bag filters) below  $20 \text{ mg/Nm}^3$ , in accordance with national environmental regulations in some Member States of the EU (e.g. TA Luft 2002).

For wet streams, dust abatement techniques normally achieve figures below  $200 \text{ mg/Nm}^3$  and with modern equipment (e.g. wet scrubber) may be expected to achieve figures below  $50 \text{ mg/Nm}^3$ .

Specific emissions of 0.014 kg dust from all sources per tonne of soda ash are quoted by a German plant in Rheinberg, whilst the range of dust emissions from different sources is reported between  $1.2 - 25 \text{ mg/Nm}^3$  [45, UBA - Germany, 2001].

The Dutch plant in Delfzijl reaches values:  $<10 \text{ mg/Nm}^3$  for dust of soda ash and limestone, and  $<5 \text{ mg/Nm}^3$  for CaO dust. Only two sources, scrubbers of the light and dense soda dedusting, comply with a higher limit value of  $<25 \text{ mg/Nm}^3$  [85, EIPPCB, 2004-2005].

To minimise dust emissions, raw materials and products should be optimally handled, e.g. by encapsulating storage and transport facilities, equipping vents with bag filters, etc.

### 2.3.3.2 Carbon dioxide and monoxide

During  $\text{CaCO}_3$  burning to  $\text{CaO}$  in the lime kilns,  $\text{CO}$  and  $\text{CO}_2$  are produced from the combustion of coke and decomposition of limestone. The Solvay process needs an excess of  $\text{CO}_2$  above that stoichiometrically required. Some of the excess is required to compensate for non-ideal absorption of  $\text{CO}_2$  in the carbonation towers.

Carbonating towers also have an outlet for the discharge of gases that have not reacted in the process. This gas is cleaned with brine in a washer to recover  $\text{NH}_3$  and possibly  $\text{H}_2\text{S}$ , if present, and to recycle these components back into the process, while  $\text{CO}_2$ ,  $\text{CO}$  and other inert gases pass out into the atmosphere (stream GO2 in Figure 2.2).

Further excess  $\text{CO}_2$  may be beneficially used in the production of sodium bicarbonate. Any surplus  $\text{CO}_2$  is vented as kiln gas to the atmosphere (GO1).

The amount of  $\text{CO}_2$  vented to the atmosphere from a standalone soda ash process is in the range of 200 to 300  $\text{kgCO}_2/\text{t}$  soda ash. The split of losses to the atmosphere depends on the detailed plant configuration.

$\text{CO}$  gas is virtually inert throughout the process. All  $\text{CO}$  produced must therefore be vented to the atmosphere either at the kilns or through the carbonation tower at the outlet of gas scrubbers.  $\text{CO}$  generation is in the range of 4 to 20  $\text{kg CO}/\text{t}$  soda ash, depending on the conversion of  $\text{CO}$  to  $\text{CO}_2$  during the limestone calcination step.

When released into the atmosphere, the  $\text{CO}$  is converted by natural processes into  $\text{CO}_2$ . Furthermore, provided the dispersion of  $\text{CO}$  and  $\text{CO}_2$  is adequate and the stack responds to the normal dispersion rules, no local impacts on the environment or on health are expected or experienced.

### 2.3.3.3 Nitrogen oxides

$\text{NO}_x$  are produced inside the kiln by the oxidation of nitrogen contained in the air used in the combustion process. Since the temperature inside the kiln is moderate (up to 1100 °C), the formation of  $\text{NO}_x$  is rather limited.

Specific emission value of 0.193  $\text{kg NO}_2/\text{t}$  soda ash was reported for the soda ash plant in Rheinberg, Germany [45, UBA - Germany, 2001].

Measurements in some plants indicate concentration after gas washing of less than 500  $\text{mg NO}_x/\text{Nm}^3$  of the outlet gas. Concentrations in the range of 240 – 290  $\text{mg NO}_2/\text{m}^3$  at the outlet of gas scrubbing section, and below 300  $\text{mg NO}_2/\text{m}^3$  of the outlet gas from the lime kiln, were reported for the soda ash plant in Rheinberg, Germany [45, UBA - Germany, 2001].

The  $\text{NO}_x$  emission limit values of  $<200 \text{ mg}/\text{Nm}^3$  are achieved by the soda ash plant in Delfzijl, the Netherlands.

### 2.3.3.4 Sulphur oxides

$\text{SO}_x$  are produced by the oxidation of compounds containing sulphur in the limestone and coke. The formation of  $\text{SO}_x$  is limited both due to the low sulphur content in fuels used in limestone burning and some autopurification reactions in the lime kilns (see Section 2.3.8.1). Furthermore,  $\text{SO}_x$  in the kiln gas sent to the process are absorbed.

A specific emission value of 0.0003 kg SO<sub>2</sub>/t soda ash and the concentration of 2.5 mg SO<sub>2</sub>/m<sup>3</sup> of the outlet gas were reported for the soda ash plant in Rheinberg, Germany [45, UBA - Germany, 2001].

It should be noted, however, that such emission values are not achievable by any plant on a regular basis, because it depends on the raw materials and equipment used, the location of the sampling, and other factors [85, EIPPCB, 2004-2005].

### 2.3.3.5 Ammonia

The main atmospheric emissions containing ammonia originate from the bicarbonate precipitation and the filtration stages of the process:

- from the precipitation of bicarbonate in carbonation towers after cleaning in tower washers
- from the filtration of bicarbonate, after cleaning in filter washers
- in addition, there are a number of diffuse losses of ammonia from filters, bicarbonate conveyors and from the handling and processing of the distillation effluent.

The emissions fluctuate and can be explained by:

- performance of the stripping columns and operating parameters control (height, steam injection, temperature control, monitoring of outlet concentrations)
- disturbances in the mother liquor feed (flowrate, composition).

Because of the above-mentioned fluctuations, the spread of reported emitted gaseous loads can be very large. The total emitted gaseous load is in a typical range of 0.6 to 1.5 kg NH<sub>3</sub>/t soda ash from the production unit, representing a release into the environment of 300 to 750 t/year for a 500 kt/year soda ash unit.

Emissions as low as 0.06 kg NH<sub>3</sub>/t soda ash have been reported for individual source emissions by one plant in Germany in 1996 [45, UBA - Germany, 2001].

The typical concentration is around 30 – 40 mg/Nm<sup>3</sup>, but much higher values can be encountered (>100 mg/Nm<sup>3</sup>) [33, CEFIC-ESAPA, 2004].

For point source emissions only, one plant reported five measurements of between 19 and 40 mg/Nm<sup>3</sup> in 1996 [45, UBA - Germany, 2001], this being largely in compliance with an ELV of 50 mg/Nm<sup>3</sup> set in TA Luft 2002 for ammonia emissions of existing soda ash plants in Germany (the ELV for ammonia in the German TA Luft is 30 mg/Nm<sup>3</sup>) [85, EIPPCB, 2004-2005].

This wide range of ammonia concentration results from a number of international variations in regulatory requirements and equipment availability. Considering the high turnover in the process (550 kg NH<sub>3</sub>/t soda ash), the loss rate of ammonia in the process is, therefore, very low (generally much less than 0.5 %).

### 2.3.3.6 Hydrogen sulphide

In some plants H<sub>2</sub>S may be added as a corrosion inhibitor, in the form of sodium hydrogen sulphide. Emission sources are from the tower gas washers and H<sub>2</sub>S is typically controlled at maximum emission levels of 5 to 15 mg/Nm<sup>3</sup> of the outlet gas.

### 2.3.4 Emissions to water

The main sources of liquid effluent from the soda ash process are typically:

- waste water from the distillation (after treatment)
- waste water from the brine purification.

Cooling waters from lime kiln gas washers, cooling in the CO<sub>2</sub> compression loop, cooling of the absorption and distillation towers, and calcination (once through or closed circuits) may be carriers of traces of pollutants, and although their volumes may be very large, they normally only have very minor environmental impact. A proportion of these waters may be re-introduced as process water, allowing for the recovery of their thermal energy.

#### 2.3.4.1 Waste water from distillation

Flowrates and concentrations of the major components present in the liquid outlet distillation (stream LI2 in Figure 2.2) are given in Table 2.13. These indicative ranges represent distiller effluent prior to any form of treatment and should not necessarily be considered as levels or concentrations emitted to the environment.

Component	Quantity <sup>(4)</sup> (kg/t soda ash)	Concentration <sup>(4)</sup> (kg/m <sup>3</sup> post-distillation liquid)
<b>Clear liquid</b>	9300 – 11800 8.5 – 10.7 (m <sup>3</sup> /t soda ash)	
Cl <sup>-</sup>	850 – 1100	99 – 115
OH <sup>-</sup>	9 – 30	1 – 2.7
SO <sub>4</sub> <sup>2-</sup>	1 – 11	0.1 – 1.2
Ca <sup>2+</sup>	340 – 400	39 – 45
Na <sup>+</sup>	160 – 220	18 – 25
NH <sub>4</sub> <sup>+</sup>	0.3 – 2.0	0.03 – 0.24
<b>Suspended solids</b>	90 – 700	11 – 70
<b>'alkalinity expressed as CaO' <sup>(2)</sup></b>	7 – <u>20</u> – 80 <sup>(1)</sup>	0.7 – 9.0
CaCO <sub>3</sub>	30 – <u>70</u> – 110	3.8 – 11
SO <sub>4</sub> as CaSO <sub>4</sub>	15 – <u>35</u> – 90	1.7 – 7.1
<b>Rest (clays, sands...)</b>	By difference	By difference
<b>Heavy metals <sup>(5, 6)</sup></b>		

(1) underlined values are typical averages  
(2) determined as total Ca minus Ca in CaSO<sub>4</sub>, CaCO<sub>3</sub> and CaCl<sub>2</sub>  
(3) figures in this table are indicative ranges of annual averages based on various measurement or estimation techniques  
(4) typical annual loads and concentrations of heavy metals in the waste water of a soda ash plant have been given in Table 2.10  
(5) for data on heavy metals load and concentration relating to two EU soda ash plants (Ebensee, Austria and Rheinberg, Germany) refer to Table 2.14 and Table 2.15 below

**Table 2.13: Waste water from distillation**  
[33, CEFIC-ESAPA, 2004]

The particle size distribution of suspended solids is typically characterised by an average of between 5 and 10 µm, 85 % of particles being smaller than 50 µm and 100 % being smaller than 1.25 mm. Large variations in quantity and composition of suspended solids depend on the composition and type of the available limestone.

Some additional low quantities of calcium sulphate (CaSO<sub>4</sub>), calcium hydroxide Ca(OH)<sub>2</sub> and trace elements are also present. Heavy metals originating naturally from raw materials are related to limestone, coke and salt composition; the process in itself does not add heavy metals. Given the alkaline nature of waste water emissions, metals are mainly insoluble and are included as part of the suspended solids. According to their composition, the suspended solids are classified as non-hazardous.



While the solid materials from the purification of brine (Section 2.3.4.2) are mainly composed of precipitation products, the suspended solids in the liquid effluent from the distillation unit essentially originate from impurities in the used raw materials (mainly limestone and coke). The suspended solids are extremely fine and generally settle down very slowly [45, UBA - Germany, 2001].

It is also noted [85, EIPPCB, 2004-2005] that once discharged to water, heavy metals can remobilise in the watercourse (river or sea).

### 2.3.4.1.1 Suspended solids and heavy metals discharged with waste waters

As mentioned in Sections 2.1.1, 2.3, and 2.3.4.1, both the composition and load of waste waters from the distillation unit released to the aquatic environment either directly for dispersion to the open sea or to an estuary of a river, or via settling ponds to a river or a lake, or directly to a local watercourse (no settling ponds), is an important environmental issue (refer also to Sections 2.2.2, 2.2.4.1, 2.3.4.1.2, 2.3.9.2, 2.3.10, 2.4.6, and 2.4.7).

Of major concern is, in particular, the load of suspended solids discharged with waste waters (annual average 90 – 700 kg/t soda ash – see Table 2.11 and Table 2.13), with an average value estimated at 240 kg/t soda ash – refer to Table 2.12. The presence of solids in the distillation waste water is an intractable fact associated with the process [108, CEFIC-ESAPA, 2005].

The environmental impact depends on the purity of raw materials selected for the production of soda ash (see Sections 2.2.2 and 2.2.4.1.1) and on the absorption capacity of the aquatic environment to which liquid effluents from the distillation unit are released, this being of importance in particular in those locations where there is no solid/liquid separation.

One of the major issues, subsidiary to suspended solids, is the discharge of heavy metals from the production of soda ash to the environment. Heavy metals are neither deliberately introduced or used in the soda ash process. Heavy metals naturally occur in the main raw materials (limestone, coke and brine), they are not retained in the soda ash, but pass through the process, to be finally released mainly with suspended solids in waste waters from distillation – refer to Section 2.2.4.1.1 above and Section 2.4.7 and Figure 2.4 below [108, CEFIC-ESAPA, 2005].

The typical annual loads and concentrations of heavy metals in the waste water of a soda ash plant have been given in Table 2.10 above, which illustrates the input-output balance of heavy metals for a medium sized 500 kt/year soda ash plant. Refer also to data on heavy metals included in Table 2.14 (Austrian case) and Table 2.15 (German case) below.

Environmental impact studies have not shown direct effects of the emitted levels of heavy metals [108, CEFIC-ESAPA, 2005]. However, it has been reported that in recent years one specific plant of a larger capacity in Germany discharged about one tonne of arsenic and eight tonnes of lead per year to water [85, EIPPCB, 2004-2005].

Other plant in Austria, with a lower capacity, using limestone with a CaCO<sub>3</sub> content of 98 - 99 %, discharged: 151 kg As, 95 kg Cd, 1258 kg Cr, 663 kg Cu, 20 kg Hg, 1427 kg Pb, 598 kg Ni and almost 18 tonnes Zn in 2003 [85, EIPPCB, 2004-2005].

The selection of a high quality limestone deposit, with a high CaCO<sub>3</sub> content and a low content of heavy metals, is one of the potential ways to decrease the discharges of suspended solids and heavy metals to water (see Section 2.4.7.1).

It has been reported that in this way discharges of heavy metals to water from a soda ash plant with a capacity of around 600 kt/year can be reduced by over 10 tonnes per year, while, at the same time, other benefits are expected to be achieved, as combined discharges of aluminium, iron, manganese, barium and phosphorus can be reduced by over 600 tonnes per year [85, EIPPCB, 2004-2005].

The installation of settling ponds to allow highly efficient sedimentation of settleable matter is another way to reduce the impact of the discharge of waste waters on the environment (refer to Section 2.4.7.4). It was reported [45, UBA - Germany, 2001] that settling ponds in Germany are characterised by very high efficiency of sedimentation of over 99.5 % (inflow of settleable matter of about 400 – 500 kg/t soda ash, and outflow of no more than 2 kg/t soda ash).

### 2.3.4.1.2 Waste water emissions from example plants

Austrian and German cases – presented below, based only on partial data and information available – illustrate to a certain degree the emission levels of soda ash plants. These cases are characteristic to soda ash plants having no settling ponds and discharging liquid effluents directly to a watercourse of a limited absorption capacity (refer to Section 2.3.4.1 above).

#### Austrian case

A land-locked soda ash plant in Ebensee, Austria – with the capacity of 160 kt/year, the smallest one on the EU scale – is situated near a lake in the mountainous area in a small valley, in which there is no space for the location of settling ponds and, therefore, waste waters from the soda ash plant are directly released into the deep lake.

Even though there are techniques available for the removal of at least coarse solids (see Section 2.4.7.3 below), the limited economic feasibility of such potential projects and the future life of the plant itself keeps the company from implementing such improvements. In fact, the plant was shut down in 2005 [85, EIPPCB, 2004-2005].

Extracted from Annex A of the Austrian Ministerial order (Section A2 concerning inorganic parameters), the emission limit values given in Table 2.14 below refer to one tonne of production of the Austrian soda ash plant and are minimum requirements for discharge to water. These emission limit values have to be complied with along with several specific requirements relevant to self-monitoring and external control [85, EIPPCB, 2004-2005].

Compared to emission limit values, the data on heavy metals content given in Table 2.14 below are actual minimum and maximum values expressed both in g/tonne of soda ash produced and g/m<sup>3</sup> of waste waters at the outlet of the soda ash plant.

Number	Parameter	Emission limit values (per tonne of soda ash)	Heavy metals content (per tonne of soda ash)	Heavy metals content (per m <sup>3</sup> of waste water)
<b>A.2</b>	<b>Inorganic parameter</b>			
5.	Lead as Pb	12 g/t	1.14 – 7.25 g/t	0.11 – 0.70 g/m <sup>3</sup>
6.	Cadmium as Cd	0.8 g/t	0.1 – 0.81 g/t	0.01 – 0.08 g/m <sup>3</sup>
7.	Chromium-total as Cr	12 g/t	1.05 – 8.04 g/t	0.10 – 0.77 g/m <sup>3</sup>
8.	Chromium-VI as Cr	6 g/t		
9.	Copper as Cu	10 g/t	1.76 – 8.91 g/t	0.17 – 0.86 g/m <sup>3</sup>
10.	Nickel as Ni	10 g/t	1.39 – 9.80 g/t	0.13 – 0.94 g/m <sup>3</sup>
11.	Mercury as Hg	0.1 g/t	0.002 – 0.07 g/t	0.0002 – 0.01 g/m <sup>3</sup>
12.	Ammonium as N	0.8 kg/t		
13.	Chloride as Cl	1100 kg/t		
14.	Phosphorus total as P	0.2 kg/t		
1. In Section A1 – General parameters – the emission limit value for suspended solids is set at 270 kg/t soda ash. 2. In Section A2 – Inorganic parameters – the emission limit values for arsenic and zinc are not established, however, arsenic and zinc contents in waste waters are as follows: As 1.12 – 4.01 g/tonne soda ash (0.11 – 0.39 g/m <sup>3</sup> waste waters); Zn 7.71 – 29.09 g/tonne soda ash (0.74 – 2.80 g/m <sup>3</sup> waste waters). 3. In turn, the following emission limits for As and Zn are set in the Austrian Ministerial order on general waste water discharge: As – 0.1 g/m <sup>3</sup> , and Zn – 2.0 g/m <sup>3</sup> [85, EIPPCB, 2004-2005]. 4. Figures quoted in this table are characteristic of waste water discharged from the production of soda ash in Austria and emission limit values of the Austrian Ministerial order on soda ash production.				

**Table 2.14: Limitations of waste water discharges from the production of soda ash in Austria [85, EIPPCB, 2004-2005]**

**German case**

A land-locked soda ash plant in Rheinberg, Germany with a capacity of 600 kt/year is the only plant in Germany having no settling ponds and, therefore, waste waters from the soda ash plant with a flow of approx. 2300 m<sup>3</sup>/s are directly released to the River Rhine, one of the biggest watercourses in Europe (see Section 2.3.4.1 above, and Section 2.4.7.3 below).

When compared to the other two soda ash plants in Germany (Bernburg and Stassfurt), which use limestones with a lower CaCO<sub>3</sub> content of about 85 %, the soda ash plant in Rheinberg uses limestone with a much higher CaCO<sub>3</sub> content of about 95 % [45, UBA - Germany, 2001].

However, in contrast to soda ash plants in Bernburg and Stassfurt, which have settling ponds to retain settleable matter with the efficiency of above 99.5 %, the soda ash plant in Rheinberg discharges waste waters directly to the river Rhine but after a treatment intended to remove a part of the coarse fraction of solids to respect the official permitted value. Because of the load of suspended solids and some heavy metals, the company is currently examining the viability of using another limestone deposit of an even higher quality [85, EIPPCB, 2004-2005].

Although the cost of transporting limestone from a more distant source would be higher, the change of limestone deposit, even without constructing settling ponds, may prove to be very beneficial for the aquatic environment (refer to Section 2.4.7.1), provided that a newly selected limestone deposit would be of a very high quality with a lower content of heavy metals [85, EIPPCB, 2004-2005].

Available 1999 data on the composition and load of waste waters from the soda ash plant in Rheinberg [45, UBA - Germany, 2001] are given below in Table 2.15. Although the main stream of liquid effluent comes from the distillation unit, these waste waters actually originate from three sources (the second source being the brine purification unit) and are jointly discharged into the recipient.

<b>Concentration and load of waste waters, the Rheinberg soda ash plant, 1999 measurement values</b>				
	Control values		Values 1999 (minimum and maximum)	
	Average volume of waste waters: approx. 8.7 m <sup>3</sup> /tonne soda ash			
	Concentration (mg/l)	Load (g/t soda ash)	Concentration (mg/l)	Load (g/t soda ash)
pH			9.5 – 11.3	
COD	70	700	<15 – 70	120 – 510
N-NH <sub>4</sub>	(70)	900	4.3 – 73	40 – 600
N-NO <sub>2</sub>			0.11 – 0.62	
P	10		5.8 – 8.5	
Ca			37 – 51.4 (g/l)	
Cd	0.03	0.3	<0.011 – 0.034	0 – 0.31
Cl		1.2x10 <sup>6</sup>	86 – 115 (g/l)	(0.7 – 1)x10 <sup>6</sup>
Cr	0.5	5	0.09 – 0.18	0.8 – 1.8
Cu	0.6	6	0.11 – 0.32	0.9 – 2.4
Hg	2x10 <sup>-3</sup>	0.02	(<0.2 – 0.72)x10 <sup>-3</sup>	0.002 – 0.005
Ni	0.5	5	0.07 – 0.22	0.6 – 1.8
Pb	1.5	15	0.34 – 1.13	2.9 – 9.6
G <sub>D</sub>			um 32	
G <sub>F</sub>	8*		<32 – 48	
G <sub>L</sub>			4 – 8	
residues		130	6 – 14 (g/l)	54 – 126 (kg/t)

G<sub>D</sub> – the daphnia toxicity; G<sub>F</sub> – the fish toxicity; G<sub>L</sub> – the luminescent bacteria toxicity are German terms, equivalent to the EU genotoxicity LID<sub>D,F,L</sub> dilution factors from bioassays, usually the dilution, where 50 % of the organisms show immobilisation or death.  
 \* G<sub>F</sub> – the fish toxicity value of 8 mg/l has been corrected from the original value of 32 mg/l because of an additional fish toxicity effect caused by the salinity of waste water.

**Table 2.15: Characteristics of waste waters from the Rheinberg soda ash plant, Germany [45, UBA - Germany, 2001]**

### 2.3.4.2 Waste water from brine purification

Waste water from brine purification is basically brine with suspended precipitated  $\text{CaCO}_3$  and  $\text{Mg}(\text{OH})_2$  in variable proportions according to the nature of the salt deposits (calcium and magnesium ions coming naturally from the original seawater). These solids (10 – 70 kg/t soda ash) can be treated separately or can be disposed of together with liquid effluent from the distillation unit for solid removal and treatment – see Figure 2.4.

Typical concentrations are given in Table 2.16.

Component	Concentration <sup>(1)</sup> (% w/w)
$\text{CaSO}_4 \cdot 2\text{H}_2\text{O}$	0 – 8
$\text{Mg}(\text{OH})_2$	1 – 6
$\text{CaCO}_3$	5 – 15
Brine	By difference
(1) figures in this table are indicative ranges of annual averages based on various measurements or estimation techniques	

**Table 2.16: Effluent from brine purification (typical composition)**  
[33, CEFIC-ESAPA, 2004]

### 2.3.5 Solid wastes

Typical solid wastes produced by the soda ash process are given in Table 2.17.

Effluent	Quantity <sup>(1)</sup> (kg/t soda ash)
Fines of raw limestone from screening	30 – 300
Grits from slaker containing inert material	10 – 120
(1) figures in this table are indicative ranges of annual averages based on various measurement or estimation techniques	
Note: the quantities of solid wastes given above do not include suspended solids contained in waste waters discharged from the soda ash plant. These are covered in Section 2.3.4 above.	

**Table 2.17: Solid wastes from soda ash process**  
[33, CEFIC-ESAPA, 2004]

#### 2.3.5.1 Fines of limestone

After crushing, the limestone is passed through a sieve in order to remove the ‘fine gravel’ fraction (0 – 40 mm) which could be a cause of plugging and bad distribution of combustion air in the lime kiln. This may be done at the quarry or, in some cases, at the soda ash plant if the limestone is too crumbly. The fines composition is 85 to 97 %  $\text{CaCO}_3$  with impurities of sand and clays (as  $\text{SiO}_2$ ,  $\text{Al}_2\text{O}_3$ ) depending on the limestone composition in the deposit.

#### 2.3.5.2 Non-recycled stone grits at the slaker

Some unburned stone, due to imperfect conversion reaction inside the kiln, is drawn with the lime to the slaker. The coarser unburned stone can be separated at the slaker and sent back to the kiln. Typically, the smaller sizes of unburned stone are rejected and the very fine material is suspended in the milk of lime and simply passes through the distiller and out with the distiller waste liquid – refer to Figure 2.4. The unburned stone contains most of the impurities and pieces of silica present in the limestone feeding the kiln.

## 2.3.6 Co-products

The manufacturing of soda ash by the Solvay process enables two main co-products (calcium chloride and refined sodium bicarbonate) to be produced.

Calcium chloride can be produced either within an integrated soda ash complex or via other process routes, starting from different raw materials. In turn, the refined sodium bicarbonate process is almost always fully integrated within the soda ash complex and, therefore, it is described below in Section 2.3.6.2.

### 2.3.6.1 Calcium chloride

Outlet liquor from the distillation unit contains primarily  $\text{CaCl}_2$  in solution in quantities corresponding to production of sodium carbonate. By treating this liquid to remove suspended solids and dissolved sodium chloride, a pure solution of calcium chloride can be obtained. By successive concentration steps, the solution is concentrated up to around 78 %  $\text{CaCl}_2$ , to produce a white solid hydrated flake or prill (see Section 7.11).

### 2.3.6.2 Refined sodium bicarbonate

#### 2.3.6.2.1 Background information

Refined sodium bicarbonate is produced in all major regions of the world and the current worldwide capacity is estimated to be around 2.4 million t/year (2002) – see Table 2.18. The predicted growth of the market for the coming years is 3 – 5 % per year.

Production capacity	EU-25	US	Central and Eastern Europe	Africa and Middle East	Japan	Others	Total
kt/year	650	800	210	100	105	500	2365
%	28	34	9	4	4	21	100 %

Table 2.18: Worldwide refined sodium bicarbonate annual capacities (reference year: 2002) [33, CEFIC-ESAPA, 2004]

The capacities and location of production sites in Europe are given in Table 2.19.

Producers	Country - location	Capacity (kt/year)
<b>Producer A</b>	France – Dombasle	120
	Germany – Rheinberg	50
	Spain – Torrelavega	120
	Italy – Rosignano	125
	Portugal – Pova	10
	Austria – Ebensee	15
<b>Producer B</b>	Bulgaria – Devnya	10
<b>Producer C</b>	United Kingdom – Northwich	90
<b>Producer D</b>	France – La Madeleine	20
<b>Producer E</b>	Germany – Stassfurt	45
<b>Producer F</b>	Poland – Inowroclaw	50
<b>Producer G</b>	Turkey – Mersin	70
<b>Producer I</b>	Romania – Ocna Mures	24
<b>Producer L</b> <sup>(1)</sup>	Czech Rep. – Usti nad Labem	5
<b>Producer J</b>	Bosnia – Tuzla	15

(1) production not coupled with a soda ash plant

Table 2.19: European refined sodium bicarbonate capacity and producers (reference year: 2002) [33, CEFIC-ESAPA, 2004]

Refined sodium bicarbonate has a wide range of uses (see Section 2.1.3). The consumption breakdown in the EU-15 is presented in Table 2.20.

Application	Per cent (%)	Application	Per cent (%)
Animal feed	43	Detergents/Cleaning Agents	7
Personal care/pharmaceuticals	18	Fire Extinguishers	2
Flue-gas treatment	11	Textiles/leather	1
Baking/foodstuffs	10	Others	8
Total			100 %

**Table 2.20: Consumption of refined sodium bicarbonate in the EU-15 (reference year: 2002) [33, CEFIC-ESAPA, 2004]**

### 2.3.6.2.2 Process description

The refined sodium bicarbonate is mostly produced from a solution of sodium carbonate that may also contain small amounts of dissolved sodium bicarbonate. This solution can be prepared following two ways. The first consists of dissolving soda ash in water. In the second, the solution is the result of the thermal decomposition of crude sodium bicarbonate from the filtration step of the soda ash process, after being suspended in a soda ash solution (Figure 2.3). In the latter case, the thermal decomposition reaction is as follows:



The  $\text{CO}_2$  produced by this reaction is totally recovered in the soda ash process by mixing it with the outlet gas from the calcination of the crude sodium bicarbonate (Figure 2.2). The prepared in the sodium carbonate solution is sent to a bicarbonation tower where  $\text{CO}_2$  is blown until precipitation of sodium bicarbonate occurs. Soda ash dissolution followed by the crystallisation (precipitation) of sodium bicarbonate ensures the purity of the refined  $\text{NaHCO}_3$  product:

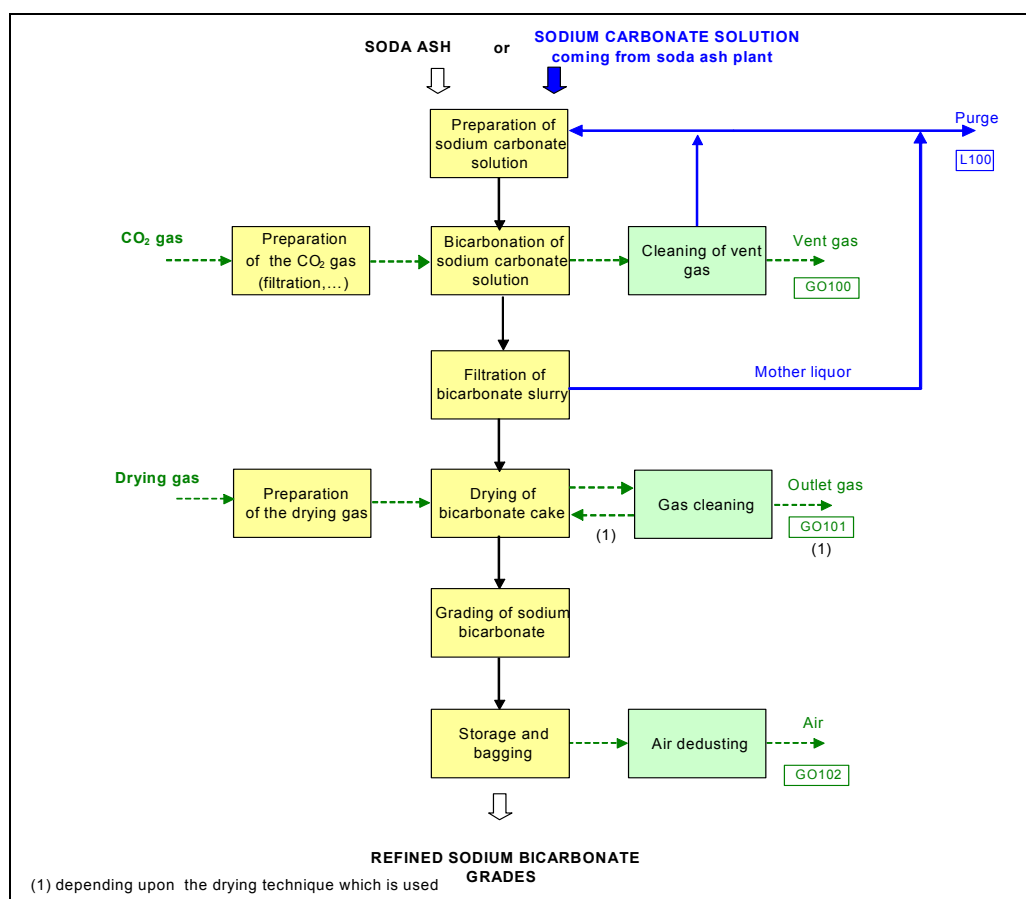


If the refined sodium bicarbonate unit is linked to a soda ash plant, the  $\text{CO}_2$  gas is sourced from the lime kiln gas excess.

The bicarbonate is separated from the mother liquor by filtration/centrifugation. The mother liquor is recycled upstream for the preparation of the sodium carbonate solution. The purge from the recycle loop may be used as a carbonate source (e.g. it may be sent to the brine purification area in a soda ash plant – see Figure 2.2).

The bicarbonate cake from the separation unit (filtration/centrifugation) is dried (e.g. by hot gas), sieved, graded, stored and sold as a bagged or bulk product.

The process diagram for the manufacture of refined sodium bicarbonate is given in Figure 2.3.



**Figure 2.3: Process flow diagram for the manufacture of refined sodium bicarbonate [33, CEFIC-ESAPA, 2004]**

### 2.3.6.2.3 Major environmental impact

#### Gaseous effluents

The gaseous effluent from the bicarbonation columns (GO100) contains some unconverted CO<sub>2</sub> due to the equilibrium limit of the reaction. When kiln gas is used to feed the carbonation columns, the CO already present in the gas stream (essentially inert, as in the soda ash process), flows through the bicarbonation step and is dispersed with the vent gas into the atmosphere, where it is converted to CO<sub>2</sub> (see Section 2.3.3.2). Typical quantities of CO<sub>2</sub> and CO in the gas released after bicarbonation are given in Table 2.21.

Component	Quantity <sup>(1)</sup> (kg/t sodium bicarbonate)
CO <sub>2</sub>	130 – 290
CO	3 – 25

(1) figures in this Table are indicative ranges of annual averages based on various measurement or estimation techniques

**Table 2.21: Vent gas from bicarbonation columns blown with lime kiln gas [33, CEFIC-ESAPA, 2004]**

The gas from the dryers is cleaned before being released (GO101) or recycled, depending upon the drying technique used.

#### Liquid effluents

If the bicarbonate plant is located near a soda ash plant, any purge from the recycle loop (LO100) is recovered, for instance in the brine purification area, such that the bicarbonate process has no liquid waste water process stream.

### **Integration with the soda ash plant**

Refined sodium bicarbonate plants are typically integrated with the soda ash plants (refer to Figure 1.15 and Figure 2.3). The degree of integration in the EU-25 is quite high, with 10 sites currently producing refined sodium bicarbonate out of the total of 14 soda ash producing sites.

However, the size of the refined sodium bicarbonate plants in relation to the soda ash capacity is variable from the smallest representing just 3 to 4 % of the total plant output compared with the largest accounting for 17 %.

Approximately 0.7 tonne of raw soda ash and up to 1.1 tonnes of 40 % CO<sub>2</sub> gas, depending on the CO<sub>2</sub> gas concentration, CO<sub>2</sub> conversion rate due to the equilibrium of the reaction and plant configuration [33, CEFIC-ESAPA, 2004], are used for the production of 1 tonne of refined sodium bicarbonate. It is assumed that, on average, some 550 kg 100 % CO<sub>2</sub> is used for the production of one tonne of NaHCO<sub>3</sub>, of that 260 kg CO<sub>2</sub> is captured by the product and 290 kg CO<sub>2</sub> is released to the atmosphere.

## **2.3.7 Energy management in the production of soda ash**

The significant aspect of soda ash manufacture is its energy need in different forms: electrical, thermal and mechanical. Much attention has been paid, during the development of the process, to reduce energy consumption and to improve the transformation efficiency of the primary fuels involved. Those improvements have had a positive impact on the environment through the reduction of consumption of primary fuels and of the emissions resulting from their combustion [33, CEFIC-ESAPA, 2004].

It should be noted that, during the initial stages of the design, there is a need to verify, on the side of primary energy use, the applicability of a combined heat and power (CHP) system to improve the overall efficiency of steam and electricity generation, bearing in mind that the soda ash plant acts as a final stage condenser [33, CEFIC-ESAPA, 2004], [86, The Council of the EU, 2004].

Within the plant itself, the minimisation of energy losses is favoured by energy transfer between flows at different thermal levels via heat exchangers and flash vessels for hot fluids.

### **2.3.7.1 Energy conversion of primary fuels**

The Solvay process requires large amounts of steam, a vast amount of which is used as low pressure steam (<5 bar abs), injected directly into the process liquids for the recovery of ammonia (steam stripping). It is, therefore, logical to include (within the energy conversion process, from primary fuel combustion to its final use at a low energy level) a system of electricity generation by reducing steam pressure in a set of turbogenerators within a soda ash plant. Thus, electricity is produced with a 'cogeneration' of steam, at a very high efficiency level (about 90 %), since all the steam leaving the turbines is used in the process.

The concern for reducing energy consumption has led to some operators giving up the direct use of fuels in other parts of the process where only thermal inputs are needed, such as sodium bicarbonate decomposition or sodium monohydrate drying to obtain dense soda ash. Thermal inputs in the form of steam have been preferred instead.

With the improvement of the efficiency of primary energy use, cogeneration units, preferably with gas turbines, have been installed in soda ash complexes. CHP systems generate large quantities of electricity which normally exceed the needs of the soda ash plant and, therefore, feed the national electricity network [33, CEFIC-ESAPA, 2004].



The possibility of using large quantities of steam produced, especially with a low energy content, makes the soda ash industry an ideal sector for installing the CHP systems. This, in turn, allows an increase in the overall energy efficiency of soda ash production.

### 2.3.7.2 Energy saving in the process

Energy saving in the soda ash process is achieved at two levels: heat recovery and minimisation of energy consumption [33, CEFIC-ESAPA, 2004], [41, Solvay S.A., 2003], [91, Takuji Miyata, 1983], [13, EIPPCB, 2000], [39, S. Leszczynski et al, 1978], [73, G.V. Ellis, 1979].

#### 2.3.7.2.1 Heat recovery

The recovery of heat has been gradually improved throughout the history of the process by optimising the use of energy contained in gas and liquid streams flowing through the process at different thermal levels. Low grade heat is used to preheat different streams such as:

- raw brine entering the brine purification step to improve purification efficiency
- raw water used for milk of lime production
- boiler feed-water
- mother liquor from the filtration to the recovery of ammonia by distillation.

Vacuum flashing of the distillation liquor may be used for producing low pressure steam available for distillation and any evaporation units, like salt production.

#### 2.3.7.2.2 Energy minimisation

The following measures may be considered with regard to the minimisation of energy use:

- careful control of limestone burning and a proper choice of raw materials allow for the reduction of primary energy use in this operation
- improvement of process control by the installation of distributed control systems
- reduction of water content in the crude bicarbonate by centrifugation before calcination to minimise the energy need for its decomposition
- back-pressure evaporation (e.g. calcium chloride liquors)
- energy management of standby machinery
- equipment lagging, steam trap control and elimination of energy losses.

The energy consumption achieved by a soda ash plant applying the above guidelines is given in Table 2.22. Refer also to Section 2.3 and in particular to Table 2.11).

Energy	GJ/t soda ash (dense) <sup>(3)</sup>
Fuels (lime kiln) <sup>(2)</sup>	2.2 – 2.8
Fuels (soda ash) <sup>(1)</sup> , including electricity	7.5 – 10.8 0.18 – 0.47 (50 – 130 kWh/t soda ash)
(1) includes electrical energy and primary fuels (gas, coal, fuel oil) for the process needs (mechanical and thermal power) without fuels for lime kilns, of that the energy required for densification to convert soda ash light into soda ash dense amounts to approximately 0.9 GJ/t soda ash [39, S. Leszczynski et al, 1978]	
(2) fuel consumption relates to a kiln of the vertical shaft type, satisfying the constraints relating to the calcination of limestone	
(3) figures in this table are indicative ranges of annual averages based on various measurement or estimation techniques	

**Table 2.22: Ranges of energy consumption in soda ash production**  
[33, CEFIC-ESAPA, 2004]

The applicability of each of the above-mentioned measures depends on the economics of its application (refer also to Section 2.4.5).

## 2.3.8 Management of air emissions

The main air emissions discharged from point sources to the atmosphere have four origins: the excess gas from lime kilns, the production of sodium carbonate itself, the production of dense soda ash, and the handling and storage of light and dense soda ash [33, CEFIC-ESAPA, 2004], [41, Solvay S.A., 2003], [39, S. Leszczynski et al, 1978].

Gaseous effluents are generated in the following main steps of the process (names in brackets are reference to the name of the corresponding streams in Figure 2.2):

- calcination of limestone (GO1)
- precipitation of crude bicarbonate (GO2)
- filtration of bicarbonate (GO3)
- production of dense soda ash (GO5)
- storage of light soda (GO6) and dense soda (GO7).

Gaseous emissions from lime slaking (GO4) are of minor importance.

### 2.3.8.1 Calcination of limestone

The CO<sub>2</sub> necessary for the formation of the sodium carbonate molecule originates from the CaCO<sub>3</sub> contained in the limestone. Theoretically, in the Solvay process, the CO<sub>2</sub> balance is stoichiometrically neutral. A certain excess is necessary and it is provided by CO<sub>2</sub> originating from the combustion gases of the fuel delivering the energy necessary to decompose the CaCO<sub>3</sub>.

The calcination of limestone produces both CaO and CO<sub>2</sub> and is designed to maximise the CO<sub>2</sub> content by minimising the presence of oxygen in the process gas. A conventional ammonia soda process produces about 30 to 80 % more CO<sub>2</sub> than is theoretically needed and it is necessary to purge some of the CO<sub>2</sub> produced to the atmosphere (stream GO1 in Figure 2.2).

Before discharge to the atmosphere, kiln gas may be cleaned and generally cooled at the same time in washing towers.

In the operation of the lime kilns, two factors are to be considered in relation to the generated CO<sub>2</sub> gas: the quantity of gas produced and its composition.

#### 2.3.8.1.1 Quantity of lime kiln gas produced

Under normal conditions, the operation of the kiln is driven by the amount of lime needed to recover ammonia in the distillation stage. As more CO<sub>2</sub> is generated than is normally required for the production of soda ash, then any excess lime kiln gas may, before its discharge to the air, be de-dusted. As its composition remains unchanged, the excess CO<sub>2</sub> gas may be used in the production of refined sodium bicarbonate, and thus gas wasting can be substantially reduced.

Alternatively, gas cleaning systems (bag filters) can also be used to collect the dust as dry material. If dry cleaning is used, residual material is made of fine particulates containing limestone, lime, and carbon (coke). This can be collected separately and may be disposed of without further treatment. However, this type of gas cleaning is difficult to operate because the lime kiln gas may be too hot for the filtering media (risk of fire).

Typical quantities of CO<sub>2</sub>, CO and dust in the gas effluent from lime kilns after cleaning (stream GO1 in Figure 2.2) are given in Table 2.23. This excludes inert components, mainly nitrogen contained in the air used for limestone burning.

Component	Quantity <sup>(2)</sup> (kg/t soda ash)
CO <sub>2</sub>	200 <sup>(1)</sup> – 300
CO	0 – 8
Dust	0.1 – 0.2

(1) values are significantly lower when a refined sodium bicarbonate plant is operating  
(2) figures in this table are indicative ranges of annual averages based on various measurement or estimation techniques

**Table 2.23: Vent gas from lime kilns after cleaning**  
[33, CEFIC-ESAPA, 2004]

### 2.3.8.1.2 Composition of lime kiln gas

Various fuels can be used, but in the case of a soda ash plant using the gas as a reagent in the process, the CO<sub>2</sub> concentration must be as high as possible. This is maximised by the use of solid rather than gaseous fuels. A range of typical gas composition resulting from limestone calcination is given in Table 2.24.

Component	Volume fraction <sup>(1)</sup> (%)
N <sub>2</sub>	Approx. 60
CO <sub>2</sub>	36 – 40 <sup>(2)</sup>
CO	0.5 – 2
O <sub>2</sub>	0.5 – 2

(1) figures in this table are indicative ranges of annual averages based on various measurement or estimation techniques  
(2) achievable CO<sub>2</sub> concentration in the lime kiln gas is within the range of 36 – 42 %, the target being 40 – 42 % (refer to Section 2.4.4).

**Table 2.24: Typical gas composition from limestone calcination**  
[33, CEFIC-ESAPA, 2004]

Operating parameters in the lime kiln not only require a reduction of the amount of excess air that would normally be associated with combustion processes in order to increase the CO<sub>2</sub> content, but also the adjustment of the fuel flowrate, so as to minimise the production of CO. This helps to maximise the thermal efficiency of the lime kiln and to avoid excessive operating costs. The CO content of the kiln gas is not directly manageable and depends on the kiln load, the quality of fuel, and the composition of limestone. The retention time for lime in the vertical shaft kiln is in the range of 24 to 48 hours.

NO<sub>x</sub> and SO<sub>x</sub> which are the components of kiln gas, are not directly controllable by the process. The NO<sub>x</sub> concentration is limited by the kiln operating temperatures, while the SO<sub>x</sub> concentration is controlled by the autopurification reaction with lime. These gaseous components are essentially inert through the process and leave the soda ash plant with the nitrogen content of the gas (refer to Sections 2.3.3.3 and 2.3.3.4 above).

Atmospheric emissions of SO<sub>2</sub> from the lime kilns depend on the concentration of sulphur in both the fuel (coke) and limestone. The small amount of SO<sub>2</sub> produced is fixed by CaO and CaCO<sub>3</sub> in the form of CaSO<sub>4</sub> (autopurification).

**Note:**

As straightforward reference to the Cement and Lime Manufacturing Industries BREF cannot be made here, because captive lime kilns used in the soda ash industry have not been included in the CL BREF. Moreover, there are several distinct differences in the production of lime in the CL industry and the production of CO<sub>2</sub> and lime within the soda ash industry, for example: the captive usage of both CO<sub>2</sub> and lime downstream in the soda ash process (in market lime production, this is not the case), different fuels used in the lime industry and coke typically used in the soda ash industry, different temperature profiles in the kiln (typically a lower and much narrower temperature range in the soda ash kiln), a high difference in excess air used (in principle, there is no excess air in the soda ash kiln), a much higher CO<sub>2</sub> concentration from the soda ash kiln, and a much higher energy intensity and thermal inputs per kiln in the lime industry.

### 2.3.8.2 Precipitation of crude sodium bicarbonate

Efficient carbonation of ammoniated brine requires an excess of carbon dioxide. Unreacted CO<sub>2</sub> passes through the columns along with inert nitrogen and CO derived from the kiln gas used in the process. However, the flow of inert and unreacted gases through the ammoniated brine leads to pick up of ammonia and, therefore, the final washing stage is designed primarily to remove the ammonia and return it to the process in order to avoid it being lost to the atmosphere.

Outlet gas from the carbonation columns (stream GO2) is subjected to a cleaning process with brine in a packed or plate washer to recover NH<sub>3</sub>, and possibly H<sub>2</sub>S, and recycle them into the process via the feed brine. Washers may have an optional final water washing section to minimise emissions. This type of equipment has been designed to meet the specific needs of the process and to allow efficient recycling of valuable raw materials.

Details of individual washers vary between different plants and locations. The majority of washers achieve high ammonia removal efficiencies with ammonia concentrations in the vent at or below 50 mg NH<sub>3</sub>/Nm<sup>3</sup> (annual average), representing an efficiency of absorption of almost 100 % [33, CEFIC-ESAPA, 2004] – refer also to Section 2.3.3.5. However, it is necessary to minimise the pressure drop across these units in order not to increase the pressure at the outlet of the CO<sub>2</sub> blowers (gas compressors) and at the inlet to the carbonation columns, thus minimising the total energy consumption. CO emissions are effectively uncontrollable as this is virtually inert throughout the process.

Typical quantities of CO<sub>2</sub>, CO, and NH<sub>3</sub> in the gas from carbonation columns after cleaning, achieved by the developed abatement techniques, are given in Table 2.25.

Component	Quantity <sup>(1)</sup> (kg/t soda ash)
CO <sub>2</sub>	40 – 100
CO	4 – 12
NH <sub>3</sub>	0.01 – 0.6
(1) figures in this table are indicative ranges of annual averages based on various measurement or estimation techniques	

**Table 2.25: Vent gas from the column section after washing**  
[33, CEFIC-ESAPA, 2004]

Regarding the potential of CO<sub>2</sub> emission reduction discussed above, one has to consider the overall balance of the soda ash process, because the kilns are run to provide a sufficient amount of lime for the decomposition of ammonium chloride in the distillation phase with an associated excess of CO<sub>2</sub>. Therefore, any reduction of CO<sub>2</sub> from the carbonation towers would have to be off-set by an increased wasting of CO<sub>2</sub> in the lime kilns area.

### 2.3.8.3 Filtration of the bicarbonate

Air containing ammonia (stream GO3 in Figure 2.2) from the vacuum filtration of crude sodium bicarbonate undergoes a cleaning process with brine in a washing tower to recover  $\text{NH}_3$  and then recycle ammonia to the process – refer also to Section 2.3.3.5. The design is very similar to that used for scrubbing the gases from carbonation columns.

Typical quantities of  $\text{CO}_2$  and  $\text{NH}_3$  in the filter air after cleaning are given in Table 2.26.

Component	Quantity <sup>(1)</sup> (kg/t soda ash)
$\text{CO}_2$	2 – 4
$\text{NH}_3$	0.005 – 0.3
(1) figures in this table are indicative ranges of annual averages based on various measurement or estimation techniques	

**Table 2.26: Filter gas after washing**  
[33, CEFIC-ESAPA, 2004]

### 2.3.8.4 Production of dense soda ash

Outlet water vapour (stream GI5 in Figure 2.2) from dense soda dryers is cleaned with water by means of a packed or spray washer to eliminate soda ash particles in the vapour and recover this soda water for use in the production process. The cleaned vapour stream (GO5) is a mixture of air and water vapour. Additional gas cleaning may be required in cases where calcination is carried out in fluid beds rather than steam heated rotary calciners.

As mentioned above, additional energy required for densification to convert light soda ash into dense soda ash amounts to approximately 0.9 GJ/t soda ash [39, S. Leszczynski et al, 1978].

### 2.3.8.5 Conveying and storage of light and dense soda ash

Light and dense soda ash is stored in large silos equipped with dedusting systems, which keep the products dry and prevent dust emissions to the atmosphere.

The emissions of dust are generated mainly during the handling of raw materials and final products (via conveyors, elevators, air lock valves, etc.) and the storage of the soda ash, when fine material is entrained in forced airflow through the various pieces of equipment. The high volumes of gas flows that need de-dusting, often require very large pieces of equipment. The soda ash process typically uses a range of high efficiency bag filters to separate dust from vent gas streams, but a number of abatement techniques can be used which may be expected to achieve dust emission figures much below 50 mg/Nm<sup>3</sup> [33, CEFIC-ESAPA, 2004]. Dust emissions reported by Austria and the Netherlands are in the range of between 5 – 20 mg/Nm<sup>3</sup> depending on the product (refer also to Section 2.3.3.1) and the available technology.

## 2.3.9 Measures applied for the reduction of emissions to water

The measures applied for the reduction of emissions to water commonly used in the heavy inorganic chemical industry sector are typically also applicable to the soda ash industry [6, CEFIC, 2002], [13, EIPPCB, 2000], [31, R. N. Shreve, 1945], [48, W. Buchner et al, 1989], [78, World Bank, 1991].

It should be stressed, however, that some of the measures and techniques used for the reduction of emissions to water in the soda ash industry, which are described below, are specifically tailored to the Solvay process, raw materials used in large capacity soda ash plants, and locally available infrastructure to cope with the major environmental problems in the soda ash industry [33, CEFIC-ESAPA, 2004], [41, Solvay S.A., 2003], [39, S. Leszczynski et al, 1978], [45, UBA - Germany, 2001].

### 2.3.9.1 Ammonia

Distillation is the primary abatement technique for ammonia recovery and recirculation within the process. The recovery of ammonia in the distillation section is performed in the two following steps:

- initially, a chemical reaction between the mother liquor (ammonium chloride solution) leaving filtration and a strong alkali (milk-of-lime), followed by
- steam stripping of the released ammonia.

The strong alkali used is a suspension of  $\text{Ca(OH)}_2$ , which also contains all the inerts of the calcined limestone as well as fine fractions of the non decomposed limestone and traces of ash from the carbon source (usually coke), used in the  $\text{CO}_2$  production process in the kilns.

During the chemical reaction phase of the distillation, the crystallisation of calcium sulphate is observed in a number of different complex forms, due to the presence of sulphate ions in the mother liquor. Calcium sulphate may appear as suspended crystals or a deposited scale depending upon reaction conditions, retention time, etc.

This reaction needs a sufficient residence time to ensure good crystallisation *in situ*, not to allow for further scaling in the downstream equipment. Only after the chemical reaction holding time can the released ammonia be effectively stripped by steam and recycled back into the process. The set of successive unit operations involves treatment of hot chloride, high alkalinity and scaling liquids, loaded with suspended solids. Over the years, the techniques used have been fine tuned to enable a good contact between the reaction components, to achieve an optimal stripping of the ammonia, despite the solids loading, while treating liquids at very high flowrates (e.g. about  $570 \text{ m}^3/\text{h}$  for a 500 kt/year capacity soda ash plant).

The efficiency of ammonia recovery cannot be increased ‘ad infinitum’, as it is governed by physico-chemical equilibrium laws. Any increase in the efficiency of ammonia recovery would require a huge additional quantity of steam that, technically and economically, would not be sustainable. Distillation uses low pressure steam to strip ammonia from the solution. The amount of ammonia remaining in the distiller effluent is related to the amount of steam consumed. The higher the quantity steam used, the lower the ammonia concentration in the liquid leaving the distiller. Because of the theoretical limitations related to the physico-chemical equilibria, heat and mass transfer constraints and hydrodynamic conditions, the relationship between steam consumption and ammonia concentration is asymptotic. Therefore, increasing the amount of steam has to be balanced with the target of energy conservation and minimisation, all the more so that increasing the amount of energy used, increases the amount of  $\text{CO}_2$  emitted during its generation.

In spite of the difficult conditions described above, it may be concluded that, with modern and adequate equipment and with the objective to remain economically sustainable, it is possible to keep the annual average ammonia losses as low as  $0.9 \text{ kg N-NH}_3/\text{t}$  soda ash (approx.  $1.1 \text{ kg NH}_3$  per tonne of soda ash produced) [33, CEFIC-ESAPA, 2004].

It should be stressed, that older equipment may not be able to achieve these conditions and yet it may not be economically feasible to replace them [33, CEFIC-ESAPA, 2004]. On the other hand, lower ammonia losses, i.e.  $0.5 \text{ kg N-NH}_3/\text{t}$  soda ash, are reported by Germany [85, EIPPCB, 2004-2005], and the minimum achievable level being estimated at  $0.23 \text{ kg N-NH}_3/\text{t}$  soda ash [33, CEFIC-ESAPA, 2004].

Therefore, in each case a feasibility analysis needs to be carried out to appraise the techno-economic viability of a project aimed at modernising a distillation unit and/or upgrading process control, to reduce the losses of ammonia to the lowest level possible.

From the energy requirements point of view, stripping with low pressure steam (1 to 3 bar abs) positively contributes to the rational and optimal use of primary energy. This is the basic concept of high efficiency embedded in combined heat and power (CHP) systems.

The configuration with CHP system enables the distillation to optimally operate as a final stage condenser to use various streams of steam, depending on the particular location of a soda ash plant and its equipment arrangement.

High ammonia recovery rates necessitate an advanced automatic control of the process, as well as consistent checking of the quality of the raw materials used.

### 2.3.9.2 Suspended solids

The liquid leaving the distiller, following the stripping of ammonia, contains solids which are a combination of those derived from the burned limestone (usually via milk of lime), a quantity of  $\text{CaCO}_3$  formed by the reaction between the milk of lime and residual  $\text{CO}_2$  not desorbed from the liquid containing  $\text{NH}_4\text{Cl}$  (in spite of a recovery rate higher than 95 %), and precipitated calcium sulphate from sulphate ions in the incoming brine.

The total quantity and composition of this solids matter depends on the composition of the raw materials, i.e. limestone and brine. These are mainly  $\text{CaCO}_3$ ,  $\text{CaSO}_4$ ,  $\text{Mg}(\text{OH})_2$ , silica and alumina components, and a small quantity of lime corresponding to the reactive excess needed to achieve effective decomposition of  $\text{NH}_4\text{Cl}$ . The solid component in the waste water from distillation is in the range of 90 to 700 kg/t soda ash produced (for the annual average, refer to Section 2.3.4.1, Table 2.13).

The type of effluent treatment for the suspended solids depends on the local conditions. There are no abatement techniques as such to eliminate the solids generated in the soda ash process and, therefore, the environmental impact requires an analysis of the cross-media effects. Two basic techniques are used:

- total dispersion (possibly with the previous separation of coarse suspended solids)
- separation and storage of the solids and dispersion of the liquid.

Throughout the history of the development of the Solvay process, the solid materials have been the subject of research and tests to find alternative uses. Various sectors have been investigated including use in construction (for block and cement manufacture), as fillers and potential road building materials, as well as in agricultural applications, as soil conditioners and acidity regulators. Attempts have failed to provide a long term viable alternative, the major restrictions being the chloride content of the material and its physical properties. Moreover, the variability of its composition does not guarantee constant quality of a material, which limits its use in low value applications for which other more readily processed materials already exist in abundance.

### 2.3.10 Management of emissions to water

Waste water discharge treatment is the environmental operation in which significant differences arise from one production plant to another [33, CEFIC-ESAPA, 2004], [41, Solvay S.A., 2003], [45, UBA - Germany, 2001], [53, EIPPCB, 2004], [39, S. Leszczynski et al, 1978].

Apart from cooling water, waste waters from the soda ash production plants are characterised by a high concentration of suspended solids and dissolved salts, as well as a high temperature and a high alkalinity. These solids and salts are unreacted limestones and salts of natural origin as well as the ashes of the coke – refer to Section 2.4.7 and Figure 2.4 below.

Suspended solids and dissolved salts originate from three different steps of the process (names in brackets make reference to the name of the corresponding streams in Figure 2.2):

- brine purification (L01)
- ammonia recovery (L02)
- cleaning of CO<sub>2</sub> gas originating from the calcination of limestone (L03), which is a minor contribution in the balance of suspended solids.

In most production plants, the effluent from brine purification is discharged jointly with the effluent originating from the distillation unit. The possibilities of using products from brine purification are mentioned in Section 2.3.10.4.3. The typical composition varies according to the quality of the raw materials. Different treatment schemes have been developed according to the geographical location of the production plants and the requirements of the local regulatory authorities.

The following options are available for the treatment of liquid effluents:

- direct discharge of raw effluent, with or without partial removal of some fraction of the solids, and with or without preliminary pH adjustment
- indirect discharge of waste water after removal of suspended solids (for possible re-use of this material see Section 2.3.10.4.2), and with or without preliminary pH adjustment
- further treatment to produce by-products, such as CaCl<sub>2</sub>, etc. (see Section 2.3.10.4.1).

Depending on the location of a soda ash plant and raw materials deposits, two basic lines are established for the treatment of suspended solids: total dispersion, and/or deposition/dispersion (separation of the suspended solids and liquid dispersion).

### **2.3.10.1 Total dispersion**

Total dispersion, with or without the previous separation of coarse suspended solids [85, EIPPCB, 2004-2005], is employed when a production plant is close to the sea or high flow rivers [41, Solvay S.A., 2003], [53, EIPPCB, 2004].

This technique ensures that the solid material is assimilated with the natural sediments of similar composition. Chlorides and other soluble salts present in the liquid fraction are dispersed in a medium which, in the sea case, already contains them in large quantities.

#### **2.3.10.1.1 Marine outfalls**

Waste waters from the production of soda ash containing suspended solids, in some cases is discharged directly to the sea or into an estuary under tidal influence by means of an open channel or underwater outfalls, designed with the necessary environmental and technical studies. For more detailed information on this technique, refer to Section 2.4.7.2.

#### **2.3.10.1.2 Lake and river discharge**

The direct discharge of waste water to fresh water environment is practised in one case without any treatment and in one case with some preliminary removal of coarse solids. For more detailed information on this technique, refer to Section 2.4.7.3.

In other cases across the EU, waste waters discharged to fresh water, are subjected to solids removal treatment prior to discharge of the soluble fraction – see Sections 2.3.10.2, 2.3.10.2.1, and 2.3.10.2.2 below.



### 2.3.10.2 Deposition/dispersion

Deposition/dispersion has generally been used where there is no suitable environmental medium to allow for total dispersion. This method involves the physical separation of liquid and solid phases. The liquid phase is then discharged to a local watercourse with or without pH adjustment as appropriate, and solids are used to build up the settling basin itself.

The underground deposition of the solids is carried out when salt deposits are found near production plants and when deposit characteristics and the salt extraction system enables it.

Where market conditions permit, it is also possible to use the separated solids after further treatment as a lime fertiliser.

#### 2.3.10.2.1 Settling ponds

The clarification by decanting large quantities of suspended solids from aqueous effluents is usually achieved in settling ponds. The location and operating area of settling ponds depend on several factors. For a more detailed description of this technique, including: purpose and principles of liquid/solid separation, operation, monitoring, hydraulic confinement, coverage and final closure of settling ponds, refer to Section 2.4.7.4 below.

#### 2.3.10.2.2 Underground disposal

Methods for the underground disposal of the distillation solids in salt cavities have been developed. Firstly, the suspended insoluble material is separated from the clear liquor phase and is re-suspended in saturated crude brine. The resulting slurry is then pumped to dedicated 'disused' salt cavities where the solids settle out within the large volume of the cavity. Displaced brine from the cavity is recycled for the repeated transport of the solids. As with basin settling, the clear liquor phase is discharged to the local watercourse. For a more detailed description of this technique, refer to Section 2.4.7.5 below.

### 2.3.10.3 Liquid effluent discharge options

The impact of direct discharge of the liquid phase containing soluble salts into rivers is linked to the flowrate of the receiving rivers, flowrate fluctuations and the inherent qualities of the water, including its natural salinity.

#### 2.3.10.3.1 Equalisation in modulation basins

In some cases of small or medium size receiving waters or low seasonal flows, a buffer equalisation storage basin may be used to store the settled liquid effluent prior to discharge. The holding capacity of such a buffer basin is determined by the average and peak load to be discharged and the available diluting flowrate of the receiving water. The basin may be as large as the equivalent of 6 to 9 months of production (typically of 3 million m<sup>3</sup> capacity).

The optimal use of equalisation basins allows to minimise the impact of chloride on the receiving water and to avoid high peak concentrations during low river flow conditions.

In determining appropriate control levels, it is critical that the local conditions and the quality of the receiving waters are taken into account.

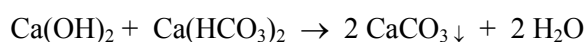
Flow equalisation storage basins can be built as aboveground basins with earth or stone walls or in excavated areas. The walls and the bottom of such basins need to be impervious (usually made in concrete or polyethylene liners) or need to have a recovery pumping of the leakage flow.

The management of buffer equalisation basins can be optimised by continuous monitoring of the flowrate and chloride concentration in the receiving water, after complete mixing, thus controlling the daily discharge which is allowed.

### 2.3.10.3.2 Adjustment of pH

The typical pH value of the raw effluent is higher than 11.5 due to the alkalinity of OH<sup>-</sup> ions contained in Ca(OH)<sub>2</sub>. Theoretically, the pH adjustment of such an effluent can be achieved either by mixing, in open channels or basins, with natural or raw waters containing dissolved calcium bicarbonate, by reacting with gas containing CO<sub>2</sub> (for example, flue-gas from power units), in pH adjustment columns or by other pH adjustment mechanisms, if acid solutions or acids waste waters are available.

In practice, the pH adjustment of soda ash waste water is usually achieved by mixing it with natural water according to the following mechanism:



Waste water is mixed with available natural water (either cooling waters after use or surface waters: river, channel, lake, sea or undergroundwater, etc.) in a typical ratio natural water/waste water at 5:1 to 10:1. The CaCO<sub>3</sub> particles formed are discharged or settled in ponds, in natural or artificial lakes or in a dedicated channel of the waterway or estuary.

Appropriate hydraulic retention time for settling in quiescent waters is usually 6 to 8 hours. Periodic removal of settled particles is achieved by dredging where the speed of the existing stream is not sufficient to keep the particles in suspension up to settling zones (e.g. the sea). This method offers numerous advantages: the pH adjustment mechanism is efficient and reliable, no consumption of supplementary reactants is needed, the settled particles are inert, and finally neither complex mixing and decanting equipment nor instrumentation and monitoring are needed.

### 2.3.10.4 By-products recovery and re-use

#### 2.3.10.4.1 Dissolved CaCl<sub>2</sub> in distillation waste water

The recovery of CaCl<sub>2</sub> dissolved in waste water from distillation requires a large amount of energy mainly in the form of steam to concentrate the diluted solution to solid CaCl<sub>2</sub> (see Section 2.3.6.1). Moreover, the market for CaCl<sub>2</sub> is limited. For these reasons, the number of CaCl<sub>2</sub> recovery units operating in soda ash plants has progressively decreased (refer also to Section 7.11).

#### 2.3.10.4.2 Suspended solids in distillation waste water

Numerous studies have been carried out in order to find ways to recover and re-use the suspended material coming out of the distillation unit.

The major difficulty to overcome is the removal of the salt content of the material by several washing steps. These operations can consume very large quantities of water, depending on the required chlorides content, which is to be further discharged as a salt solution.

The second difficulty is to dry the material to an acceptable level of residual humidity for transportation and re-use. This can be achieved by gravity settling and dehydration, but this takes a long time, or by drying in a rotary kiln, which requires a large amount of energy.

The costs associated with the complete removal and treatment (decanting, washing and dehydration) for the re-use of suspended solids in the waste water effluent of a soda ash factory are high. In most cases, they are now prohibitive for full scale implementation.

Attempts have been made to recover the coarse solid fraction suspended in the distillation waste water. The efficiency of clarifying in hydrocyclones is limited due to operational constraints (scaling, plugging, erosion) and require frequent maintenance interventions and cleaning.

Due to the higher grain size, the dewaterability of the fraction obtained is easier but, because the remaining chloride content is around 15 %, a preliminary washing is necessary in order to enable the re-use or recovery.

Other obstacles to overcome are to find a commercial or useful application for the residual material. In general, it exhibits unfavorable properties for civil engineering works or construction material, due to the presence of residual chlorides, the low size of particles, the thixotropic characteristics of the material and variability of its composition.

Some practical experience has been gained with certain industrial recovery options, such as soil amendment, cement manufacture, gypsum raw material, concrete filler, but none – apart from soil modifiers – have been implemented to a full industrial scale. In this last case, final dewatering is achieved using press filters, and the product can be used without further drying.

### **2.3.10.4.3 Product from brine purification**

Several attempts have been made to recover the  $\text{CaCO}_3$  fraction from the brine purification effluent, but they inevitably faced the problem of the chloride content in the effluent needing to be treated and of the impurities remaining after the treatment. The final product could never compete with purer products available on the market.

Some experience of agricultural applications for acidic soils with a high clay content is available, but the use of the recovered  $\text{CaCO}_3$  is restricted to the soils exhibiting the corresponding characteristics.

It should be noted that heavy metals originating from the brine are passed to the solids removed from the brine during its purification. Therefore, where there are no viable end applications for the solids from brine purification, they are normally handled with the other solids arising from the process or, where geological conditions are favourable, are separately re-injected into the salt strata from which the salt was originally extracted.

## **2.3.11 Solid materials management**

### **2.3.11.1 Limestone fines**

Since the composition of the limestone fines is the same as, or close to, raw limestone, this material can be used without any restriction for civil engineering works and as filler material for roads, highway, dams, banks and for cement manufacturing.

In some existing soda ash factories, it is mainly used for internal purposes (walls of the dykes, roads in quarry operation).

### **2.3.11.2 Large lumps of unburnt limestone**

Unburnt limestone (backstone) may be recycled to the lime kilns for reprocessing, while the smaller fraction is either milled and incorporated into the milk of lime or is separated and used as a soil conditioner for pH correction, as a filler in concrete, as a raw material for cement manufacture or filler material for the landscape recovery of quarries. Unburnt limestone may also be used as an engineering material for the construction of dykes for the settling ponds.

A milling step is required to adjust the particle size distribution, as fine as possible for soil conditioning or as regular as possible for concrete incorporation.

## 2.4 Techniques to consider in the determination of BAT

This section sets out techniques considered generally to have potential for achieving a high level of environmental protection in the industries within the scope of this document. Management systems, process-integrated techniques and end-of-pipe measures are included, but a certain amount of overlap exists between these three when seeking the optimum results.

Prevention, control, minimisation and recycling procedures are considered as well as the re-use of materials and energy.

Techniques may be presented singly or as combinations to achieve the objectives of IPPC. Annex IV to the Directive lists a number of general considerations to be taken into account when determining BAT and techniques within this section will address one or more of these considerations. As far as possible a standard structure is used to outline each technique, to enable comparison of techniques and an objective assessment against the definition of BAT given in the Directive.

The content of this section is not an exhaustive list of techniques and others may exist or be developed which may be equally valid within the framework of BAT.

Generally a standard structure is used to outline each technique, as shown in Table 2.27:

Type of information considered	Type of information included
Description	Technical description of the technique
Achieved environmental benefits	Main environmental impact(s) to be addressed by the technique (process or abatement), including emission values achieved and efficiency performance. Environmental benefits of the technique in comparison with others
Cross-media effects	Any side-effects and disadvantages caused by implementation of the technique. Details on the environmental problems of the technique in comparison with others
Operational data	Performance data on emissions/wastes and consumption (raw materials, water and energy). Any other useful information on how to operate, maintain and control the technique, including safety aspects, operability constraints of the technique, output quality, etc.
Applicability	Consideration of the factors involved in applying and retrofitting the technique (e.g. space availability, process specific)
Economics	Information on costs (investment and operation) and any possible savings (e.g. reduced raw material consumption, waste charges) also as related to the capacity of the technique
Driving force for implementation	Reasons for implementation of the technique (e.g. other legislation, improvement in production quality)
Example plants	Reference to a plant where the technique is reported to be used
Reference literature	Literature for more detailed information on the technique

**Table 2.27: Information breakdown for each technique described in this section**

Reference is also made here to Section 8.9, providing key information on the Environmental Management System (EMS) which is a tool for IPPC installations that operators can use to address the design, construction, maintenance, operation and decommissioning issues in a systematic demonstrable way.

Techniques broadly applicable in the chemical industry, described in the BREF on Common Waste Water and Waste gas Treatment/Management Systems in the Chemical Sector, are not included in this section (refer to the BREF on CWW).

## 2.4.1 Integrated design and operation of soda ash plants

### Description

An integrated design of a soda ash plant based on the Solvay process, with a required degree of reserve and standby equipment within the plant and the associated boiler/power plant at the site (refer also to Section 2.4.2), allows for a longterm continuous operation of the soda ash plants, this being an outstanding and distinct feature of the European soda ash industry.

Unlike some inorganic chemical plants – (characterised by similar media, like inorganic solutions and salts, and therefore subject to common problems resulting from the scaling of equipment and crystallisation of process media in the installation) – which are shut down once or more times per year, soda ash plants maintain continuous steady operation for a number of years before being shut down for planned maintenance.

Due to the complexity and inertia of a soda ash plant based on the Solvay process, careful design is essential to assure the required operational flexibility of the plant, which allows individual units to be taken out of operation while maintaining long term continuous operation of the plant, thus reducing the losses and emissions arising during the periods of unstable operation (following start-up until steady state operation is achieved again). If the required operational flexibility of the plant is not at a sufficient level, then standby equipment is needed.

Examples of reserve units for a soda ash plant in various sections of the process include: lime kilns, CO<sub>2</sub> gas compressors, carbonation columns, bicarbonate filters and calciners, as well as boilers to continuously provide steam at parameters required by the soda ash process.

### Achieved environmental benefits

Higher raw materials and energy efficiency, and a reduced impact of soda ash production on the environment – refer to Section 2.3, and Table 2.11. For example, long term overall gaseous emissions of ammonia at a level below 1.5 kg NH<sub>3</sub>/tonne soda ash can only be achieved with such extended periods of steady state operation. However, other data available from the soda ash industry indicate that registered point source gaseous emissions of 0.06 kg NH<sub>3</sub>/tonne soda ash are also possible.

### Cross-media effects

No negative cross-media effects. Generally positive effects on waste production and energy utilisation.

### Operational data

Typical performance of the production of soda ash is as indicated in Section 2.3, and Table 2.11. At least one plant reports many years of continuous operation before a planned shut down.

### Applicability

Applicable, in principle, to all larger size soda ash plants based on the Solvay process, where the economy of scale is in the production of soda ash.

### Economics

No data available but industrial experience have been proven over many years' implying that the investment in reserve equipment is offset by increased production, less waste and better energy utilisation.

### Driving force for implementation

Improvements in the usage of raw materials and energy, and in lessening the impact of the soda ash industry on the environment.

### Example plants

Torrelavega soda ash plant in Spain.

### Reference literature

[33, CEFIC-ESAPA, 2004], [53, EIPPCB, 2004], [41, Solvay S.A., 2003], [45, UBA - Germany, 2001], [39, S. Leszczynski et al, 1978], [76, Union of Inorganic Industry, 1977].

## 2.4.2 Energy conversion of primary fuels

### Description

The Solvay process requires large amounts of steam – a vast amount of which is used at low pressure. It is, therefore, possible to include, within a soda ash plant, a system of electricity generation by reducing steam pressure in a set of turbogenerators. Thus, electricity is produced with a ‘cogeneration’ of steam in combined heat and power (CHP) units, at a very high efficiency level, since all the steam leaving the turbines is used in the process (refer also to Section 2.3.7.1). The possibility of using large quantities of steam produced, especially with a low energy content, makes the soda ash industry an ideal sector for installing CHP systems. The CHP units, preferably with gas turbines, have been installed in some soda ash complexes. This, in turn, allows an increase in the overall energy efficiency of soda ash production.

The following three main features are particularly relevant to the soda ash industry:

- demand for different forms of energy in the Solvay process, including demand for steam at various pressure levels, with a very high requirement for steam condensation, fully in line with the strategic CHP concept
- large scale production of soda ash, also allowing the utilisation of the economy of scale in the associated CHP systems
- high onstream factor of soda ash plants, which favours the applications of the most modern, reliable CHP systems and justifies the investment for such systems.

The above-mentioned features justify the applications of CHP units in the soda ash industry, regardless of the primary energy source (e.g. coal vs. natural gas) used for the cogeneration of steam and electricity.

### Achieved environmental benefits

Higher energy efficiency in the conversion of primary fuels used in the CHP units associated with soda ash plants, this benefiting to the reduction of CO<sub>2</sub> and SO<sub>x</sub> emissions at the site. The high reliability of the steam and power supply from the CHP unit at the site allows for a steady state operation of a soda plant which, in turn, leads to lower emissions from the soda ash process.

### Cross-media effects

No negative cross-media effects. Positive effects on the overall energy efficiency at the site, in particular when the CHP unit is based on natural gas and uses efficient gas turbogenerator(s).

### Operational data

Efficiency levels of about 90 % are achieved, since almost all the steam leaving the turbines is used in the process.

### Applicability

Applicable to all larger soda ash plants based on the Solvay process having an easy access to the natural gas network and, in particular, where the integration of the soda ash plant with the associated CHP system utilises the economy of scale – refer also to Section 2.4.1 above. However, as shown in the example from Austria, there are also soda ash plants operating a coal fired CHP system. The cogeneration of energy in the EU also results from the Council Directive 2004/8/EC of 11 February 2004 on the promotion of cogeneration based on a useful heat demand in the internal energy market, with the soda ash industry being one of the best areas in the chemical industry sector to combine heat and power generation (CHP).

### Economics

A rough comparison of the primary energy needed for a soda ash plant using a cogeneration unit, with that required for the separate production of steam and electricity (by a classical coal-based power station for electricity and boilers for steam), indicates that it is possible to achieve up to 30 % savings with gas-based heat and power cogeneration. Moreover, globally the emissions of CO<sub>2</sub>, SO<sub>x</sub> and NO<sub>x</sub> are substantially reduced [33, CEFIC-ESAPA, 2004].

### Driving force for implementation

- reduction of the manufacturing cost of soda ash production
- improvements in energy efficiency at a soda ash complex
- reduced impact of the soda ash industry on the environment.

### Example plants

Torrelavega soda ash plant in Spain.

The integration of the soda ash plants with CHP units is reported to be applied in several soda ash plants across the EU-25.

### Reference literature

[33, CEFIC-ESAPA, 2004], [41, Solvay S.A., 2003], [53, EIPPCB, 2004], [86, The Council of the EU, 2004]. Refer also to the BREF on Large Combustion Plants (LCP).

## **2.4.3 Optimisation of the soda ash process to avoid excessive CO<sub>2</sub> emissions**

### Description

All industrial activities that irreversibly use, by burning, natural resources containing a carbonate ion (CO<sub>3</sub><sup>2-</sup>), such as limestone, during which carbon dioxide evolves, contribute to the build-up of CO<sub>2</sub> concentration in the atmosphere and to climate change.

The manufacture of soda ash by the Solvay process (which also needs to burn limestone to produce the lime necessary for the production of soda ash), also belongs to this group of industrial activities.

It should be noted, however, that the emissions of CO<sub>2</sub> from the soda ash manufacturing process itself are relatively moderate, as:

- the CO<sub>2</sub> gas from limestone burning is, for the main part, used in the soda ash manufacturing process. Each tonne of soda ash contains approximately 415 kg of CO<sub>2</sub>, so this represents over 3 million tonnes of CO<sub>2</sub> per year for the production of soda ash in the EU-25
- part of the CO<sub>2</sub> (that otherwise would have been vented to the atmosphere) may be used again in the production of refined sodium bicarbonate, typically associated with the soda ash industry. About 170 kt of CO<sub>2</sub> per year is captured at the present time by the production of sodium bicarbonate at the regional level in the EU-25, the current combined NaHCO<sub>3</sub> capacities being about 650 kt per year (refer to Section 2.3.6.2)
- only excess CO<sub>2</sub>, in total within the maximum range of 200 – 400 kg/t of soda ash (refer to Table 2.11), is vented to the atmosphere.

On the other hand, it is clear that soda ash cannot be considered a final CO<sub>2</sub> sink, as the main part of the CO<sub>2</sub> is emitted again in the downstream sectors (e.g. the glass industry) in which soda ash is used to yield new value added products. And even though these downstream CO<sub>2</sub> emissions cannot be attributed to the manufacture of sodium carbonate – an industrial activity directly referred to in IPPC Annex I, 4.2.(d) – in order to analyse the protection of the environment as a whole in global terms, there is a need to focus on the optimisation of the soda ash process in order to avoid excessive CO<sub>2</sub> emissions from the soda ash plant itself.

### Achieved environmental benefits

Despite the overall net emissions of CO<sub>2</sub> generated in the soda ash process, in total within a maximum range of 200 – 400 kg/t of soda ash, substantial CO<sub>2</sub> emissions can be avoided in global terms by the optimisation of the soda ash process (and, in local/regional terms only, by the integration of the production of soda ash with the production of refined sodium bicarbonate).

Each tonne of avoided excessive CO<sub>2</sub> emission to the atmosphere, contributes positively to slowing down the process of depleting natural resources (limestone) and to the mitigation of global climate change.

#### Cross-media effects

No negative cross-media effects have been reported.

#### Operational data

For the illustration of CO<sub>2</sub> recovery cycle (CO<sub>2</sub> from both the lime kiln section and from the calcination section) refer to Figure 2.2.

One of the key concepts of the Solvay process is the captive usage of both CO<sub>2</sub> and lime downstream in the process, in order to keep material efficiency in the process at a high level and to avoid excessive CO<sub>2</sub> emissions from the soda ash plant. To this end, both a stable and a highly balanced flow of concentrated CO<sub>2</sub> gas is required within the so-called 'CO<sub>2</sub> recovery cycle' – a dominating loop in the process.

Apart from maintaining the required stable flow of CO<sub>2</sub> gas and high operational flexibility between, on the one hand, the lime kiln section (typically several kilns are in operation) and, on the other hand, the calcination of the crude bicarbonate section (typically several calciners are in operation) and then, via the CO<sub>2</sub> gas compression section (typically several turbo-compressors are fed with washed and cooled CO<sub>2</sub> gas), to the carbonation section (again several carbonation columns are in operation), direct process optimisation is possible in several plant sections, with regard to decreasing the amount of CO<sub>2</sub> released to the atmosphere.

This pertains in particular to the limestone burning and operational parameters maintained in this process step, including as narrow as possible temperature profile in the kiln and as little as possible excess air used to reach a high concentration of CO<sub>2</sub> gas (see Sections 2.2.1.2.2, 2.3.8.1 and 2.4.4), the selection of optimum quality limestone (see Section 2.2.2.2 and 2.4.7.1) and fuel – typically coke (see Section 2.2.2.3), as well as for maintaining optimum process parameters in during the carbonation of ammoniated brine (see Sections 2.2.1.2.4, 2.3.8.2, and 9.2.2) and the calcination of crude bicarbonate (see Section 2.2.1.2.6).

On top of the above, if the market conditions permit, an increased degree of the integration of soda ash plants with refined sodium bicarbonate plants (see Section 2.3.6.2), may also positively benefit the optimisation of the operation of both plants, in order to avoid excessive emissions of CO<sub>2</sub> from the soda ash process.

#### Applicability

The optimisation of the process to reduce CO<sub>2</sub> emissions is, to a varying degree, applicable for all soda ash plants in the EU-25. This technique is broadly applied in the EU-25 industry.

#### Economics

According to current trends on CO<sub>2</sub> prices at the emission trading market in Europe, each tonne of avoided CO<sub>2</sub> emission to the atmosphere can be valued within a range of approx. EUR 20 - 33/tonne (data as of September 2005). For a typical 500 kt soda ash plant, avoided emission of 100 kg CO<sub>2</sub>/tonne soda ash, and the assumed lower price of CO<sub>2</sub> emissions permit of EUR 20/tonne, the gross benefits would be at the level of ~ EUR 1 million per year.

#### Driving force for implementation

Apart from the mitigation of climate change, with regard to reduced CO<sub>2</sub> emissions, the optimisation of the soda ash process directly results in decreasing the manufacturing cost of the production of soda ash.



### Example plants

For the optimisation of the soda ash process within the soda ash plant, and the integration of the soda ash plant with the refined sodium bicarbonate plant:

Torrelavega soda ash plant in Spain.

Dombasle soda ash plant in France.

Rosignano soda ash plant in Italy.

Winnington soda ash plant in the UK.

### Reference literature

[33, CEFIC-ESAPA, 2004], [41, Solvay S.A., 2003], [53, EIPPCB, 2004], [39, S. Leszczynski et al, 1978], [79, BIPROK WAS, 1985-1995], [76, Union of Inorganic Industry, 1977], [85, EIPPCB, 2004-2005].

## **2.4.4 Vertical shaft kiln for the production of concentrated CO<sub>2</sub> gas and reactive lime**

### Description

The decomposition of limestone for soda ash manufacturing places a number of constraints on the type and design of lime burning kilns that can be used. These constraints include:

- CO<sub>2</sub> concentration in the resulting gas as high as possible (>40 %)
- sufficient supply of CO<sub>2</sub> providing an excess over the stoichiometric quantity for the carbonate production reaction, this excess being derived from the energy source
- high yield to reactive lime, one of the major parameters in the lime burning operation, being of key importance for the overall high performance of the Solvay process
- maximum thermal efficiency of the limestone burning process
- an ability to accept a wide particle size distribution of limestone to minimise the avoidable limestone processing and losses at the quarrying step
- high unit capacity considering tonnages of limestone to be treated.

When analysing the standard available types of kiln such as vertical shaft, rotary, annular and Maerz kilns, fuelled either with coke, fuel oil or natural gas, it can be concluded that the vertical shaft kiln, fed with coke, represents the best compromise for the soda ash industry, satisfying the constraints mentioned above (see also the BREF on Cement and Lime industry).

A vertical shaft kiln allows for:

- achieving the concentration of gas between 36 and 42 % CO<sub>2</sub>. The other kilns can only deliver a gas ranging between 25 and 32 % CO<sub>2</sub>
- producing an additional amount of CO<sub>2</sub> (apart from that derived by decomposition of limestone) by combustion of coke, sufficient to feed a soda ash plant and, possibly, also an associated refined sodium bicarbonate plant, if included in the integrated soda ash complex (refer to Figure 1.15, Section 2.5 and Figure 2.3)
- achieving a high yield to reactive lime, one of key factors to reduce the amount of dead-burnt lime in the downstream slaking of the lime process step which, in turn, will help to decrease the amount of suspended solids in the waste water from the distillation unit (refer to Figure 2.2 and Section 2.4.7.1)
- achieving the maximum thermal efficiency compatible with the requirements above. The other solutions have an energy demand of up to 52 % greater than a vertical shaft kiln
- using a larger spectrum of limestone lumps. The other types of kilns require limestone with a narrower particle size distribution and higher graded limestone, this leads to larger quantities of rejected fines and a less efficient use of natural resources
- the design and operation of the vertical shaft kiln gives the additional advantage of providing a reserve gas capacity of several hours without loss of kiln control, this being very important for the continuous and flexible operation of downstream soda ash units without the need to install a large capacity buffer storage for the CO<sub>2</sub> gas.

### Achieved environmental benefits

A higher concentration of CO<sub>2</sub> in the lime kiln gas, this being of key importance for keeping material and energy efficiency in the soda ash process at a high level. As the productivity of the process increases, the environmental impact of the production of soda ash decreases. High energy efficiency, greater CO<sub>2</sub> output, and broader flexibility of the soda ash plant can be achieved.

### Cross-media effects

No side-effects or disadvantages are associated with applying this technique.

### Operational data

Vertical shaft kilns of various capacity levels are operational in the soda ash plants across the EU-25. They are characterised by different life-times, are of different technical specifications originally guaranteed by the suppliers and, therefore, require different maintenance procedures.

On average, some 590 – 900 kg of burned lime is produced per one tonne of soda ash. Energy intensity in the lime kiln section of a typical soda ash plant amounts to approximately 2.2 - 2.8 GJ/tonne of soda ash (refer to Table 2.11 and Table 2.22), equivalent to approximately 2.4 – 3.1 GJ/tonne of raw burned lime.

The high concentration of the gas, at the level of 40 – 42 % CO<sub>2</sub>, and the high yield to reactive lime are the targets.

The emission levels from the lime kiln section are at the level of 200 – 300 kg CO<sub>2</sub>/t soda ash produced (see Section 2.3.8.1.1).

### Applicability

Applicable to all soda ash plants operating across the EU-25 (as well as to all soda ash plants worldwide using the Solvay soda ash process).

### Economics

No data available.

### Driving force for implementation

Improvement of the soda ash plant productivity, flexibility, and material and energy efficiency and, therefore, lessening the impact of the soda ash process on the environment (gaseous and liquid emissions, and solid wastes).

### Example plants

Vertical shaft kilns are normally used by all the EU-25 soda ash producers.

### Reference literature

[33, CEFIC-ESAPA, 2004], [41, Solvay S.A., 2003], [53, EIPPCB, 2004], [39, S. Leszczynski et al, 1978]. Refer also to the BREF on Cement and Lime (shaft kilns used in other industries).

## **2.4.5 Centrifugation of crude sodium bicarbonate – energy saving**

### Description

The technique available for energy saving in the process (refer to Section 2.3.7.2), is that of decreasing water content in the crude sodium bicarbonate by its centrifugation before the calcination section, in order to minimise the energy requirements for its decomposition.

Crude sodium bicarbonate, precipitated in the carbonation section, is fed to the filtration section in order to separate bicarbonate crystals. Because of the different characteristics (size, shape) of the bicarbonate crystals and the high production volumes encountered in the operation of the soda ash process, rotary or belt vacuum bicarbonate filters are preferably used in the European soda ash industry. After filtration, the content of water in crude sodium bicarbonate typically oscillates in the range between 15 – 19 % of H<sub>2</sub>O, the lower value being an obvious target.

The higher the water content in the filter cake, the lower the overall process efficiency and the higher the energy requirements in the following sodium bicarbonate calcination section, where the wet sodium bicarbonate is converted to dry calcined soda ash.

Quite a substantial reduction of water content in the separated crude bicarbonate can be attained when using centrifugation, after which it is much dryer, i.e. with 12 – 14 % H<sub>2</sub>O content, or possibly less, depending on the application of a system for the sedimentation of the bicarbonate crystals prior to centrifugation. The reduction of water content in the crude bicarbonate by centrifugation would result in the reduction of energy required for its decomposition in the downstream calcination section.

The centrifugation of the crude bicarbonate saves energy by reduction of the cake moisture (by 5 to 6 percentage points). But this possibility must take into account the following points:

- the bicarbonate crystals quality has a higher importance for centrifuges than for belt or drum filters to ensure good filterability (and the quality of bicarbonate suspension may vary with time)
- the crystal quality is of a lesser importance if the centrifugation is a second filtration step (after drum or belt filtration)
- capital and operating costs of centrifuges are relatively high.

### Achieved environmental benefits

Energy savings, directly resulting in reduced steam requirements in the sodium bicarbonate calcination section, reduced usage of fuel and decreased emissions of CO<sub>2</sub>, SO<sub>x</sub> and NO<sub>x</sub> in the associated boiler/power plant.

### Cross-media effects

Certain disadvantages may result from the necessity to apply the strict continuous control of process parameters in the upstream carbonation section, so as to assure that the characteristics of sodium bicarbonate crystals are appropriate for centrifugation. Additional energy is required to centrifuge the crude bicarbonate suspension.

### Operational data

Centrifugation is a very well known unit operation, applied across the chemical industry on a full industrial scale. In the EU-25, two Polish producers use this technique, mainly to increase calcination capacity. As claimed by the Japanese soda ash producers, sodium bicarbonate crystals obtained in the upstream modified carbonators (refer to Section 9.2) are suitable for continuous centrifugation and the water content of the crystals is reduced by about 30 per cent compared to those in the conventional system.

### Applicability

In principle, applicable to all soda ash plants, subject to plant configuration, equipment layout and the availability of space.

The effectiveness of centrifugation in reducing the water content prior to calcination is dependent upon the form and size of crystals formed in the upstream carbonation step. Therefore, optimally, this technique needs to be analysed jointly with the improvements applicable to the carbonation step (see Section 9.2), especially where the centrifuges would be the first filtration step.

### Economics

It was reported, that the energy consumption in the subsequent sodium bicarbonate calcination section, one of the major energy requirements in the production of soda ash, had been reduced by about 10 per cent.

Installation of centrifuges should in any case be the result of a cost-benefit analysis, as conclusions could be very dependent on both the local situation and the type of a soda ash plant in question (a new plant or an existing one).

Driving force for implementation

Improvement of the overall energy efficiency in the soda ash process and decreasing the manufacturing cost of the production of soda ash.

Example plants

Soda ash plants at Inowroclaw and Janikowo, Poland.

Reference literature

[91, Takuji Miyata, 1983], [39, S. Leszczynski et al, 1978], [53, EIPPCB, 2004], [33, CEFIC-ESAPA, 2004], [85, EIPPCB, 2004-2005].

**2.4.6 Ammonia recovery in the distillation section**Description

In the Solvay ammonia soda ash process, ammonia is, in principle, a reaction aid circulating within the process (see Figure 2.2). As much as about 0.5 tonne of ammonia per one tonne of soda ash circulates in the ammonia recovery process loop, while the external ammonia input is approximately 0.8 – 2.1 kg NH<sub>3</sub> per tonne of soda ash produced (see Table 2.11).

The efficiency of ammonia recovery is over 99.5 % for a recycle loop of ammonia (refer to Section 2.2.1.2.7 above). This is due to the efficient recovery of ammonia in the distillation section, the performance of which is of utmost importance for lessening the impact of the production of soda ash on the environment.

As described in Section 2.3.9.1, distillation is the primary abatement technique for ammonia recovery and recirculation within the process. The stripping of gaseous ammonia from the solution using low pressure steam, positively contributes to the rational use of energy and favours the application of the CHP concept in the soda ash plants (refer to Sections 2.3.9 and 2.4.2).

When the distillation section is operated appropriately, the losses of ammonia in the waste water at the outlet of distillation are in the range of 0.23 – 1.55 kg N-NH<sub>3</sub>/t soda ash, equivalent to approximately 0.3 – 1.9 kg NH<sub>3</sub> per tonne of soda ash (see Table 2.11, Table 2.13, and Sections 2.3.8.2, 2.3.8.3 and 2.3.9.1). At the same time, the quantity of waste water from the distillation unit should not exceed the operational range of 8.5 - 10.7 m<sup>3</sup> per tonne of soda ash (see Table 2.13).

Apart from the quantity of steam used and the losses of ammonia in the liquid effluent, which are the main indicators of the distillation unit operating properly, the quantity of waste water as above needs to be maintained in accordance with the mass and heat balances assumed for the Solvay process.

The measures to reduce the impact of waste waters on the environment, in particular relating to suspended solids and heavy metals discharged with liquid effluents, are dealt with separately in Section 2.4.7 below.

Achieved environmental benefits

High efficiency of ammonia recovery in the distillation unit with the recycling of gaseous ammonia to the upstream ammonia absorption unit (where it is absorbed into the salt brine).

The efficient operation of the distillation unit is critical to maximising the recovery of ammonia within the soda ash process and to minimising the impact of liquid effluents from the production of soda ash on the environment (waste waters).

In particular, the composition (including suspended solids) and the quantity of waste waters leaving the distillation unit (see Table 2.13), are of key importance for the follow up treatment (solid-liquid separation) of the waste water leaving the distillation unit and for the impact of the production of soda ash on the environment (refer to Sections 2.3.4, 2.3.9, 2.3.10 above, and to Section 2.4.7 below).

### Cross-media effects

The higher the quantity of steam used, the lower the ammonia concentration in the liquid leaving the distiller, but the increased amount of energy used for the generation of steam increases the amount of CO<sub>2</sub> emitted to the atmosphere during steam generation. It is, therefore, important that the technical, economic, and environmental optimum is looked into in each case, also taking into account local conditions in which a given soda ash plant operates.

### Operational data

Refer to Table 2.13, to Sections 2.3.4, 2.3.9 and 2.3.10 above, and to Section 2.4.7 below.

### Applicability

Applicable to all soda ash plants operating across the EU-25 (as well as to all soda ash plants worldwide using the Solvay ammonia soda ash process).

### Economics

The costs of ammonia recovery are related to the costs of steam and lime, as well as to the capital cost involved in the construction of a given distillation unit.

As mentioned above, when the distillation section is operated appropriately, it is possible to keep the annual average ammonia losses as low as approx. 0.23 – 1.55 kg N-NH<sub>3</sub>/t soda ash. With modern and adequate equipment it is currently possible to achieve losses of ammonia in waste water from the distillation unit of less than 0.9 kg N-NH<sub>3</sub>/t soda ash. It should be noted, however, that older equipment may not be able to achieve these conditions.

Therefore, it is important to analyse each case in detail, also taking into consideration the impact of the production of soda ash on the environment outside the site of a soda ash plant in question, if it is feasible to replace the equipment in the distillation unit.

### Driving force for implementation

Reducing the impact of the production of soda ash on the environment.

Refer to Table 2.11, Table 2.13, Sections 2.3.4, 2.3.9, 2.3.10, 2.4.2, and to Section 2.4.7.

### Example plants

Torrelavega soda ash plant, Spain.

Bernburg soda ash plant, Germany.

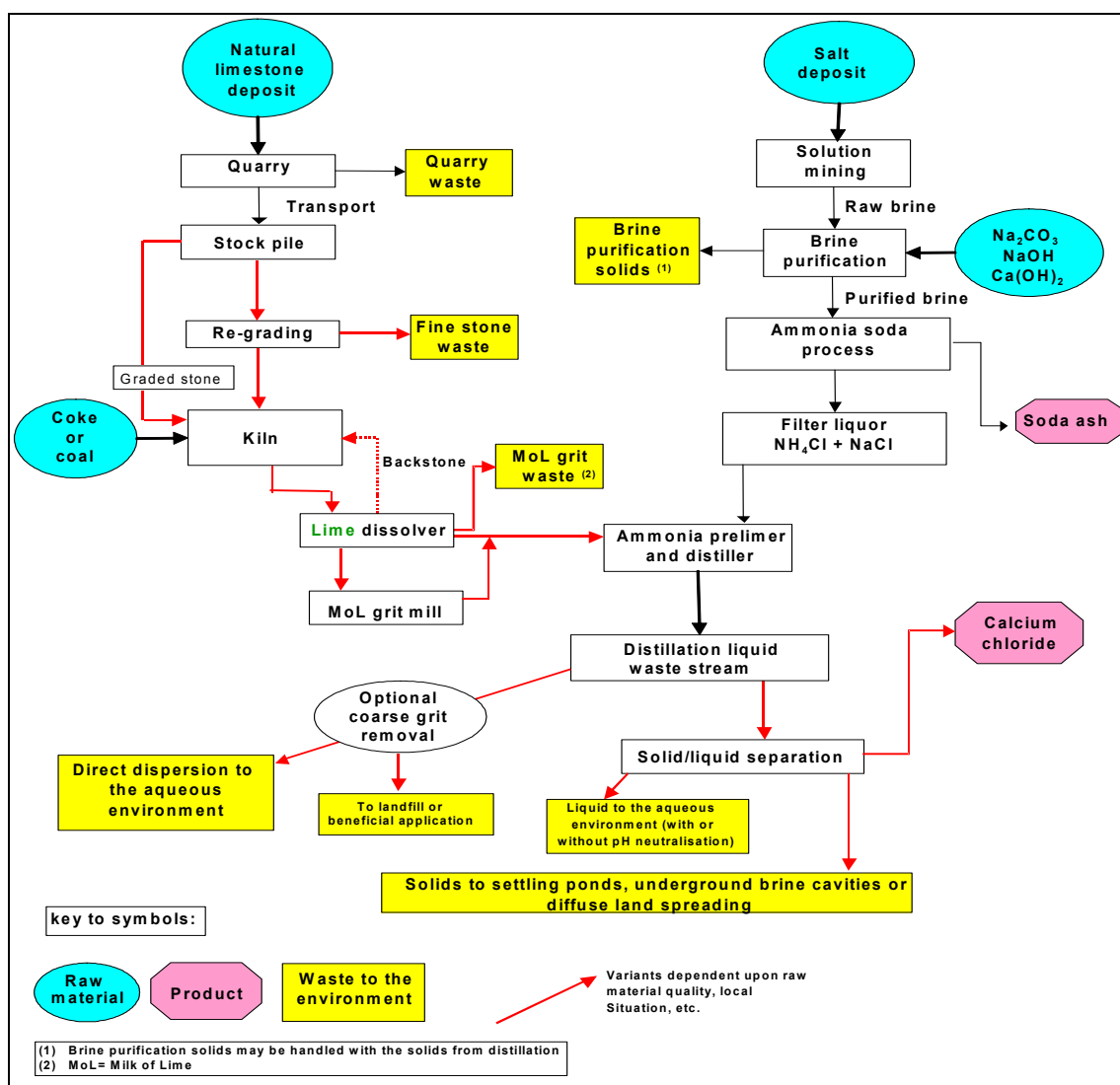
### Reference literature

[33, CEFIC-ESAPA, 2004], [40, CEFIC-ESAPA, 2003], [45, UBA - Germany, 2001], [41, Solvay S.A., 2003], [53, EIPPCB, 2004], [39, S. Leszczynski et al, 1978], [86, The Council of the EU, 2004], [106, Sodawerk Stassfurt GmbH &Co. KG, 2002], [85, EIPPCB, 2004-2005].

Refer also to the BREFs on CWW, MON, WT, and MTWR.

## **2.4.7 Management of waste waters from the production of soda ash**

As stems from the information included in Sections 2.2.2, 2.3.4, 2.3.9 and 2.3.10, and also Figure 2.4 below, there are different routes possible for the reduction of the impact of waste waters from the production of soda ash on the environment, in which the stress is put on the high quality of raw materials (predominantly limestone, but also brine and coke) and on the treatment and disposal of waste waters from the production of soda ash.



**Figure 2.4: Interlinkages between raw materials, products and waste in soda ash production [108, CEFIC-ESAPA, 2005]**

As indicated in Section 2.3.10, waste waters from the production of soda ash in the EU-25 are:

- discharged directly to the aquatic environment – see Section 2.3.10.1.1 on total dispersion – marine outfalls; and Section 2.3.10.1.2 on total dispersion – lake and river discharge
- passed via settling ponds (sedimentation of solids) and possibly, via modulation basins, and then discharged to the aquatic environment – see Section 2.3.10.2 on deposition/dispersion, in particular Section 2.3.10.2.1 on settling ponds and Section 2.3.10.3.1 on the concept of equalisation in modulation basins
- discharged after solids are removed and passed into underground brine cavities – see Section 2.3.10.2.2 on deposition/dispersion – underground disposal.

The mass balance of the Solvay process dictates that the content of suspended solids in the waste waters is fundamentally related to the  $\text{CaCO}_3$  content of the limestone. Furthermore, any heavy metals contained in the raw materials will be carried through the production process into the waste waters discharged from the distillation unit.

There is, therefore, a number of techniques which can be used to mitigate the impact of the waste water discharged to the aquatic environment.

### 2.4.7.1 Selection of appropriate quality limestone, salt brine and coke

#### Description

The quality of basic raw materials (limestone, salt brine and coke) plays an important role in the production of soda ash and its impact on the environment. Of particular importance here is the quality of limestone available for the production of soda ash, both in terms of the  $\text{CaCO}_3$  content and the purity of limestone, especially with regard to the traces of heavy metals. The appropriate burning properties of limestone are also of a very high importance as a precondition to obtain a high yield to reactive lime, used downstream in the process (refer to Sections 2.2.2.2 and 2.4.4 above).

Suspended solids in the waste waters originate from lime (obtained in the process from limestone), sulphates from salt brine, and calcium carbonate formed in the process. The load of suspended solids in waste waters from distillation varies in the range of 90 kg/tonne (best case) to 700 kg/tonne of soda ash produced (worst case), which relates both to the range of limestone quality reported and the process parameters maintained in the limestone burning and lime slaking units (refer to Sections 2.2.2.2, 2.4.4 above and 'Operational data' below).

Heavy metals mainly originate from impurities present in limestones used in the Solvay process for the production of  $\text{CO}_2$  and lime, and although there is no correlation between the  $\text{CaCO}_3$  content and the content of heavy metals in limestones, it is known that whatever mass load of heavy metals is present in the limestone, it will be present in the waste waters discharged from distillation.

#### Achieved environmental benefits

The purer and more reactive the raw materials, the lower the overall impact of the production of soda ash on the environment, in particular with regard to waste waters from distillation and to the load of suspended solids and heavy metals contained in the waste waters.

It should be noted that the  $\text{CaCO}_3$  content in the limestone is in the range 84 – 99 %. This variation induces a ratio of 1 to 16 in the non-convertible content of the limestone and, therefore, along with appropriate reactivity of the limestone, is of high importance for reducing environmental impact and achieved environmental benefits, both within the plant and outside of the soda ash plant.

#### Cross-media effects

Apart from additional costs of transporting raw materials from more distant sources (additional energy use and connected environmental impacts) in cases where raw materials of an appropriate quality are not available locally, no side-effects or disadvantages are associated with applying this technique.

The purer and more reactive the raw materials upstream of a given soda ash plant, the less feedstock is necessary to obtain the same amount of soda ash, and the lower the quantities of waste produced.

#### Operational data

For detailed information refer to Sections 2.2.2, 2.2.4, 2.3.4, 2.3.5, 2.3.9, 2.3.10, 2.3.11 and 2.4.4 above.

Based on recent analyses carried out in over 20 European limestone quarries, data on the average composition and heavy metals content in nine limestones among those used for the production of soda ash in the EU-25 are given in Table 2.7 above.

Also, other data on the quality of salt brine and coke used for the production of soda ash, which do not need to be repeated here, are included in Section 2.2.2 above.

It should be noted, however, that the purer and more reactive the limestone, the higher the overall material and energy efficiency of the soda ash process, the lower the amount of dead-burnt lime, and the lower the load of suspended solids in waste waters discharged from the distillation unit will be (refer to Section 2.4.4 above).

#### Applicability

Applicable for all soda ash plants in the EU-25. Two cases are reported where existing soda ash plants in the EU have either changed to other limestones or have considered a change to higher quality limestones. Another plant changed their limestone deposit only because of the depletion of the previous limestone quarry.

#### Economics

Apart from general data relevant to one soda ash plant, which are still not accessible to public, no detailed data are available. Also, it is difficult to valorise all the recovered solid materials.

The purer and more reactive the limestone, the lower amounts of waste solids for disposal, hence this should result in reduced disposal costs. Increased costs of transporting raw materials (mostly limestone delivered from more distant sources) will have a negative effect here. On the other hand, the purer the limestone, the less material will be transported, reducing some of the additional transportation costs.

It should be also noted that the majority of soda ash plants having their own land and raw material extraction facilities cannot discard them without compromising their economic viability. Therefore, in each case a detailed feasibility study with a complex cost-benefit analysis would be required prior to any strategic decision on changing a raw material base for the production of soda ash – refer also to Section 2.2.2.2 above.

#### Driving force for implementation

Substantial reduction of the environmental impact from the production of soda ash and overall improvement of the efficiency of the Solvay process.

#### Example plants

Rheinberg soda ash plant, Germany.  
Delfzijl soda ash plant, The Netherlands.

#### Reference literature

[33, CEFIC-ESAPA, 2004], [45, UBA - Germany, 2001], [39, S. Leszczynski et al, 1978], [41, Solvay S.A., 2003], [53, EIPPCB, 2004], [85, EIPPCB, 2004-2005], [107, CEFIC-ESAPA, 2005], [108, CEFIC-ESAPA, 2005].

### **2.4.7.2 Total dispersion of waste waters – via an extended marine outfall**

#### Description

Total dispersion of waste waters with an extended marine outfall can be employed when a production plant is located close to the sea. The discharge point is located as such to ensure that natural currents disperse the waste waters into deep water and they are not carried back to the shore by tidal or storm action. In addition to the hydraulic calculations, the marine outfall diffuser design requires a detailed study of the receptor medium to set the co-ordinates of the discharge point to ensure an adequate dispersion and a minimum environmental impact. Refer also to Sections 2.3.10.1 and 2.3.10.1.1.



### Achieved environmental benefits

This technique ensures that the solid material is dispersed into the aquatic environment, assimilated with the natural sediments of similar composition, and not carried back onto the shoreline. Chlorides and other soluble salts present in the liquid fraction are dispersed in the sea, which already contains them in large quantities.

Apart from some data relating to the soda ash plant in Spain (indicating that the concentrations of heavy metals in benthic organisms are far lower than the permitted limits), no data on the concentration of heavy metals in the sea are available for other EU soda ash plants located by the sea, although the load of heavy metals will be influenced by the quality of raw materials.

### Cross-media effects

No side-effects or disadvantages associated with applying this technique have been reported.

### Operational data

Some general data are available from the Torrelavega soda ash plant in Spain.

The study on the environmental impact of the production of soda ash in Torrelavega for the aquatic environment of coastline area of the Cantabrian Sea was elaborated in 1995, prior to the reconstruction and extension of the new marine outfall to the sea, commissioned in July 2002.

The study indicated for the excessive concentrations of inorganic salts (mainly  $\text{CaCl}_2$ ,  $\text{NaCl}$  and  $\text{CaCO}_3$  from distillation) in the seawaters close to the shore line and for substantially reduced concentrations of these salts in seawaters in the distance greater than 600 m from the shore.

This led to the project of the new marine outfall in Torrelavega with the outfall extended from the shore to the distance of 660 m from the shore and 14 m deep into the sea, close to the line of deep seawaters, thus allowing for good distribution of the above-mentioned salts in seawaters.

Approximately 1000 m<sup>3</sup> of liquid effluents, containing suspended solids, can be discharged each hour from the Torrelavega soda ash plant via new marine outfall into the Cantabrian Sea.

A new environmental study aims to analyse the improvements in marine and coastal environment in detail a couple of years after commissioning the new marine emissary and to re-examine the impact of soda ash production on the aquatic environment of the Cantabrian Sea in the Torrelavega coastline area.

### Applicability

Depending on local conditions, including the characteristics of the aquatic environment, this technique can be applicable to soda ash plants in the EU located by the sea and within a cost-effective distance of a suitable deep water discharge point.

### Economics

No data available, apart from the information that the new marine outfall in Torrelavega was designed by a specialist engineering company and built at a cost of EUR 5 million.

### Driving force for implementation

Reduced environmental impact of the liquid effluents from the production of soda ash on the marine environment in the proximity to a given soda ash plant.

### Example plants

Torrelavega soda ash plant, Spain.

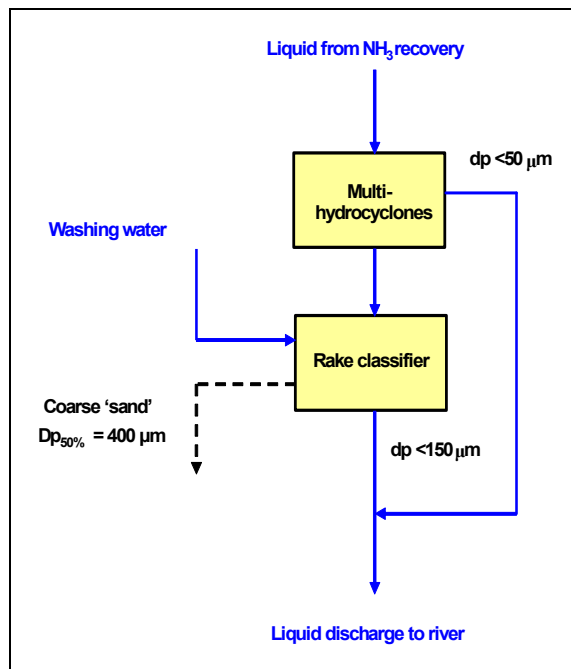
### Reference literature

[33, CEFIC-ESAPA, 2004], [41, Solvay S.A., 2003], [53, EIPPCB, 2004], [85, EIPPCB, 2004-2005].

### 2.4.7.3 Removal of coarse solids from waste waters – particularly for lake and river discharge

#### Description

The separation technique consists of a combination of classification operations, to extract the coarse fraction of the suspended solids, followed by washing, to remove the remaining chloride from the recovered materials, see the process flow sheet in Figure 2.5 below.



**Figure 2.5: Separation of coarse solid fraction from the distillation waste waters [33, CEFIC-ESAPA, 2004], [85, EIPPCB, 2004-2005]**

The waste waters from the distillation unit are pumped to a battery of hydrocyclones operating in parallel (multi-hydrocyclones). The overflow from hydrocyclones contains the finest fraction of solids (typically less than 50  $\mu\text{m}$ ), while the underflow contains a concentrated slurry of coarser material.

The underflow stream is then sent to a rake classifier, where the undersized fines (<150  $\mu\text{m}$ ) are kept in suspension by the rake motion until they flow over a weir. The coarse fraction settles rapidly and is transported up the inclined bottom of the classifier by the motion of the rake blades. Decarbonised water is sprayed to wash the drained grits and remove the remaining chloride. Due to the large grain size, the dewatering of this fraction is achieved by drainage.

#### Achieved environmental benefits

This technique aims at reducing the amount of suspended solids discharged into the inland waters (lake or river), prior to the dispersion of solid material to the aquatic environment, while not creating additional cross-media effects (solid waste).

The discharge of waste waters from distillation without preliminary treatment, may have a substantial impact on the inland waters and, therefore, the application of this technique aims at reducing the impact of soda ash production on the aquatic environment.

#### Cross-media effects

Apart from the consumption of energy and washing water, a significant cross-media effect may arise if all the removed solids may not be used as a product. Reduction of solids discharged to water gives a solid output stream as waste or product. Pre-used water may be employed for chloride washing to avoid net additional water consumption.

### Operational data

The operational data on the separation of the coarse fraction of the suspended solids from the waste waters (separation efficiency, energy and water consumption), are summarised in Table 2.28 below.

<b>Separation of coarse solid fraction in distillation discharge – Operational data <sup>(1)</sup></b>	
Separated solids (dp <sub>50%</sub> 400µm)	
kg/t soda ash	20 – 40
% weight inlet solids	15 – 25
Humidity (%)	<30
Chloride content (%)	<1.2
Particle size distribution	
Range (µm)	60 – 2000
Average (µm)	400
Washing water (m <sup>3</sup> /t soda ash)	0.4 – 0.7
Energy (kWh/t soda ash)	2.6
<sup>(1)</sup> based on the operating data of the Rheinberg soda ash plant	

**Table 2.28: Separation of coarse solid fraction in distillation discharge [85, EIPPCB, 2004-2005]**

It should be noted that the efficiency of separating the coarse fraction of suspended solids from the waste waters using multi-hydrocyclones and a clarifier is quite limited, due to operational constraints (scaling, plugging, erosion, corrosion) and the system requires frequent maintenance interventions and cleaning.

Refer also to Section 2.3.4.1 on waste water from distillation, Section 2.3.9.2 on suspended solids, and Section 2.3.10.1.2 on lake and river discharge.

### Applicability

This technique is applicable to all soda ash plants in the EU, however, it is applicable in particular to those landlocked soda ash plants, which do not have settling ponds and cannot discharge liquid effluents with non-separated solids directly to a lake or river of limited absorption capacity. A necessary condition of applicability, however, is to find a practical use for all the recovered solids (see Cross-media effects).

### Economics

The order of magnitude of the capital cost: EUR 3 million. The maintenance and operation costs are substantial due to the abrasive characteristic of the slurry.

The product competes as a soil conditioner with other industrial by-products containing calcium and can be sold on the local market at prices that do not cover the outgoing expenses.

### Driving force for implementation

Reduces the amount of solids discharged to the aquatic environment (lake or river). In the case of the Rheinberg plant, the driving force was to achieve the specific quantity of separated solids per tonne of soda ash produced similar to that already achieved by another soda plant also discharging waste water to the Neckar river in Germany (see Example plant paragraph below).

### Example plants

Rheinberg soda ash plant, Germany.

Note: This technique was previously used also in the Heilbronn soda ash plant in Germany which had a lower production capacity (plant is shut down at present), and had great difficulties in selling the recovered solids.

### Reference literature

[33, CEFIC-ESAPA, 2004], [45, UBA - Germany, 2001], [85, EIPPCB, 2004-2005]

#### 2.4.7.4 Deposition/dispersion – settling ponds

##### Description

##### **Purpose and principles of liquid/solid separation**

The clarification by decanting large quantities of suspended solids from aqueous effluents is usually achieved in settling ponds (also called settling ‘basins’ or ‘lagoons’). Fines of limestones or solid particles settled in the basin can be used, in some cases, to build up the walls as the deposit in the basin accumulates. The height of the deposit can reach 25 – 40 m above ground. The aqueous outfall is collected at several points through separators and drainage pipes to a peripheral channel collecting all drainage outfalls.

For a 500 kt/year soda ash plant, the necessary surface area for the pond in the settling phase is at least 15 – 30 ha, but can be much larger (depending on the quantity and characteristics of the settled material) in order to limit the number of alternate settling/drying phases (2 - 4 times/year). The pond in the drying phase may represent an additional area, equivalent to one to two times the operating area, giving a total occupied area of 60 – 120 ha for a soda ash plant of the above-mentioned capacity. The dedicated area may be larger (according to the characteristics of the settled material: local conditions), several times the minimum area quoted above.

The location of settling ponds depends on several factors including: area available for permanent long term land occupation, distance between factory and final discharge point, underground geological and hydrogeological characteristics and landscape impact. Settling ponds occupy a large land area, which otherwise could be used either for agricultural production or other purposes, depending on the plans for developing local infrastructure. Also, such a big deposit changes the landscape and, therefore, it is possible that the local authority may refuse to grant a permit to build up such a deposit.

In the case of available alluvial deposits with economic value (gravels or sands), the area can be excavated beforehand, thereby increasing the volume available for deposition, the excavated material being used as a civil engineering product.

##### **Hydraulic confinement**

Usually the base of the basins is not constructed to achieve complete impermeability, because of the size of the area occupied and because of the necessity to ensure sufficient drainage of the deposit through the walls and through the bottom of it. This is essential for the structural stability of the walls and the basin itself.

In order to control the drainage and the release of salts (mainly NaCl and CaCl<sub>2</sub>) from the deposit, it is a common practice to install the deposit above an impervious ground mass with no shallow aquifer or to manage a hydraulic confinement in order to direct the water that has been in contact with salt to surface waters (river, lake).

##### Achieved environmental benefits

Settling ponds are characterised by a very high sedimentation efficiency of solid matter suspended in waste waters from distillation, refer to Sections 2.3.4.1, 2.3.9.2 and 2.3.10.2.1.

In Germany, the achieved efficiency of sedimentation was reported to be over 99.5 % (inflow of settleable matter of about 400 – 500 kg/t soda ash, and outflow of no more than 2 kg/t soda ash).

Given the separation from waste waters of the majority of suspended solids, including heavy metals, cleaner waste waters are discharged to the local watercourse, thus reducing the impact of the production of soda ash on the aquatic environment.

##### Cross-media effects

If not properly managed, settling ponds may cause uncontrolled emission of liquid effluents to the local surface and groundwaters (refer to the ‘Operational data’, in particular ‘Monitoring during operation’ paragraph below). There is also some diffuse emissions to air together with the evaporated water, although no detailed data are available.

### Operational data

#### **Operation of settling basins**

Usually, two to four basins are built and used alternately – one basin is in operation for settling, and one or more basins for drying the deposits and leaving the water draining.

The peripheral wall of a basin is increased using either limestone fines (size 0/30 or 0/40 mm), unburnt limestone in larger lumps and smaller fractions, possibly mixed with boiler ashes, or the settled material itself. This practice of leaving beds to dry out is known as ‘resting’ or ‘consolidating’. In the case of very large ponds, the operation of several separate basins is not needed.

#### **Monitoring during operation**

During normal operation, several parameters are measured and monitored in order to secure the operation and achieve a good settling efficiency: piezometric water level, flowrates at the inlet and the outlet of the basin, remaining suspended solids (<250 mg suspended solid/litre). Regular visual inspections are done in order to detect any failure. Bed wall stability is monitored by regular piezometric monitoring along with other geophysical measurements.

#### **Coverage and final closure**

The basin is closed down when its final height has been reached. The final closure may include covering the last layer with earth (typically 0.5 – 1.5m), with an appropriate slope and drainage of rainwater out of the basin.

The landscape can be enhanced with natural greening or the planting of trees and providing natural habitats for wildlife (including small ponds) or for other recreational purposes (including sport activities). Considering the inert characteristics of the material, no special provision is required for prohibiting access to the sites. The natural drainage of the deposit will progressively remove the soluble salts.

### Applicability

Applicable for all soda ash plants in the EU, if the required area is available.

### Economics

Settling ponds (2 x 20 ha) have been recently built in La Madeleine, France at a cost of EUR 7 million. This figure is illustrative, since the cost is very dependent on local conditions.

### Driving force for implementation

The protection of the aquatic environment.

### Example plants

Stassfurt soda ash plant, Germany  
Bernburg soda ash plant, Germany  
La Madeleine soda ash plant, France.

### Reference literature

[33, CEFIC-ESAPA, 2004], [45, UBA - Germany, 2001], [85, EIPPCB, 2004-2005], [41, Solvay S.A., 2003], [106, Sodawerk Stassfurt GmbH &Co. KG, 2002]

### 2.4.7.5 Deposition/dispersion – underground disposal

#### Description

Brine for soda ash manufacture is normally produced by the *in situ* dissolution of salt from salt bearing strata at depths of 200 to 1500 m below ground level. Fully developed cavities are typically in the range of 500000 to 2000000 m<sup>3</sup>. The actual volume left by dissolution depends on the brine field layout, the depth and thickness of the salt deposit, and the possibilities for future use (e.g. gas storage). In favourable conditions, each cavity is essentially a self contained unit with no cross connection to other cavities and is hydraulically sealed, in order to avoid any contact between the saturated brine in the cavity and any underlying or overlying aquifers or groundwater flows.

Methods for the underground disposal of the distillation solids in salt cavities have been developed. Firstly, the suspended insoluble material is separated from the clear liquor phase in the thickeners and is then re-suspended in saturated crude brine. The resulting slurry is then pumped to dedicated ‘disused’ salt cavities where the solids settle out within the large volume of the cavity. Displaced brine from the cavity is recycled for the repeated transport of the solids.

The most critical aspects of this activity are:

- to avoid dilution of the saturated brine with water which can lead to further salt dissolution with eventual destabilisation of the cavity
- the control of calcium sulphate concentration of the brine phase to avoid scaling in the pipeline
- the control of temperature.

As with basin settling, the clear liquor phase is discharged to the local watercourse and may require pH adjustment (see Section 2.3.10.3.2) using one of a range of techniques.

If excess CO<sub>2</sub> is used to reduce the alkalinity of the liquor, further solid separation is required before liquor discharge to the local watercourse. Where settling solids in ponds continues to be used in combination with cavity disposal, lagoon capacity is maintained by regular dredging of solid material, suspension in saturated brine and disposal to the brine cavity.

#### Achieved environmental benefits

Underground disposal assures a high sedimentation efficiency of solid matter suspended in waste waters from distillation, refer to Section 2.3.4.1. Given the separation of the majority of solids from distillation waste waters, cleaner waste waters leaving underground salt brine cavities are discharged to the local watercourse, and thus the impact on the aquatic environment is substantially reduced.

#### Cross-media effects

No side-effects or disadvantages associated with applying this technique have been reported.

#### Operational data

Apart from the information included in the ‘Description’ above, no other data are available.

#### Applicability

Applicable for all soda ash plants in the EU-25, in those locations where salt brine cavities are not being used for storing natural gas, and where the cavities meet all the technical parameters required for underground disposal of solids from the production of soda ash.

#### Economics

No data available.

#### Driving force for implementation

The reduction of the impact of the production of soda ash on the aquatic environment.

## Chapter 2

---

### Example plants

Winnington soda ash plant, UK

### Reference literature

[33, CEFIC-ESAPA, 2004], [85, EIPPCB, 2004-2005].

## 2.5 Best Available Techniques for the production of soda ash by the Solvay process

In understanding this section and its contents, the attention of the reader is drawn back to the preface of this document and in particular the fifth section of the preface: 'How to understand and use this document'. The techniques and associated emission and/or consumption levels, or ranges of levels, presented in this section have been assessed through an iterative process involving the following steps:

- identification of the key environmental issues for the sector, including:
  - limited material efficiency of the Solvay process, due to intractable chemical equilibrium limitations, with the conversion of a  $\text{Na}^+$  cation at the level of  $\sim 70\%$  and  $\text{CO}_3^{2-}$  anion at the level of  $\sim 80\%$ , this having a direct impact of the production of soda ash on the environment [85, EIPPCB, 2004-2005]
  - the influence of the quality and purity of the raw materials used (including the heavy metals content), in particular limestone, for the overall impact of the production of soda ash on the environment
  - the relatively high volume of the waste waters discharged from the process to the aquatic environment
  - the load of suspended solids in the waste waters, including heavy metals derived from the raw materials, and the limited possibilities to separate them from the waste waters in all soda ash producing sites. The best management option depends on local conditions, however, in several locations total dispersion is used without any separation of suspended solids
- examination of the techniques most relevant to address these key issues
- identification of the best environmental performance levels, on the basis of the available data in the European Union and worldwide
- examination of the conditions under which these performance levels were achieved; such as costs, cross-media effects, and the main driving forces involved in implementation of the techniques
- selection of the best available techniques (BAT) and the associated emission and/or consumption levels for this sector in a general sense, all according to Article 2(11) and Annex IV of the Directive.

Expert judgement by the European IPPC Bureau and the relevant Technical Working Group (TWG) has played a key role in each of these steps and in the way in which the information is presented here.

On the basis of this assessment, techniques, and as far as possible consumption and emission levels associated with the use of BAT, are presented in this section that are considered to be appropriate to the sector as a whole and in many cases reflect the current performance of some installations within the sector. Where emission or consumption levels 'associated with best available techniques' are presented, this is to be understood as meaning that those levels represent the environmental performance that could be anticipated as a result of the application, in this sector, of the techniques described, bearing in mind the balance of costs and advantages inherent within the definition of BAT. However, they are neither emission nor consumption limit values and should not be understood as such. In some cases it may be technically possible to achieve better emission or consumption levels but due to the costs involved or cross-media considerations, they are not considered to be appropriate as BAT for the sector as a whole. However, such levels may be considered to be justified in more specific cases where there are special driving forces.

The consumption and emission levels associated with the use of BAT have to be seen together with any specified reference conditions (e.g. averaging periods).



The concept of ‘levels associated with BAT’ described above is to be distinguished from the term ‘achievable level’ used elsewhere in this document. Where a level is described as ‘achievable’ using a particular technique or combination of techniques, this should be understood to mean that the level may be expected to be achieved over a substantial period of time in a well maintained and operated installation or process using those techniques.

Where available, data concerning costs have been given together with the description of the techniques presented in the previous section. These give a rough indication about the magnitude of the costs involved. However, the actual cost of applying a technique will depend strongly on the specific situation regarding, for example, taxes, fees, and the technical characteristics of the installation concerned. It is not possible to evaluate such site-specific factors fully in this document. In the absence of data concerning costs, conclusions on economic viability of techniques are drawn from observations on existing installations.

It is intended that the general BAT in this section are a reference point against which to judge the current performance of an existing installation or to judge a proposal for a new installation. In this way they will assist in the determination of appropriate ‘BAT-based’ conditions for the installation or in the establishment of general binding rules under Article 9(8). It is foreseen that new installations can be designed to perform at or even better than the general BAT levels presented here. It is also considered that existing installations could move towards the general BAT levels or do better, subject to the technical and economic applicability of the techniques in each case.

While the BAT reference documents do not set legally binding standards, they are meant to give information for the guidance of industry, Member States and the public on achievable consumption and emission levels when using specified techniques. The appropriate limit values for any specific case will need to be determined taking into account the objectives of the IPPC Directive and the local considerations.

All BAT figures hereafter relate to yearly average. They have been derived from information based on various measurements or estimation techniques [85, EIPPCB, 2004-2005].

### **For soda ash plants in the EU-25 based on the Solvay process, the following are BAT:**

1. Total consumption of salt in the raw brine in the range of 1.5 – 1.7 tonne NaCl per tonne of soda ash, although the consumption of up to 1.8 tonne NaCl per tonne of soda ash produced may be justifiable in some circumstances, e.g. raw brine quality and local cooling water temperature – see Sections 2.3, 2.3.1 and 2.4.1.
2. Total consumption of limestone at the plant inlet in the range of 1.1 – 1.5 tonne per tonne of soda ash, although the consumption of up to 1.8 tonne limestone per tonne of soda ash produced may be justifiable for plants where good quality limestone is not available (i.e. limestone with a lower carbonate content, poor burning characteristics and stone friability) – see Sections 2.3, 2.3.1 and 2.4.1.
3. Selection of appropriate quality limestone (see Sections 2.2.2.2, 2.2.4.1 and 2.4.7.1), including:
  - high CaCO<sub>3</sub> content, preferably in the range between 95 – 99 % (low MgCO<sub>3</sub>, SiO<sub>2</sub>, SO<sub>3</sub>, and Al<sub>2</sub>O<sub>3</sub>+Fe<sub>2</sub>O<sub>3</sub> content)
  - appropriate physical limestone characteristics required in the process (particle size, hardness, porosity, burning properties), and
  - limited content of heavy metals (As, Cd, Cr, Cu, Hg, Ni, Pb and Zn) in either the purchased limestone or limestone from the currently exploited own deposit.

In cases where a limestone deposit of lower grade, with a content of 85 to 95 %  $\text{CaCO}_3$ , is used, and where other limestone of better quality are not readily available, low  $\text{MgCO}_3$ ,  $\text{SiO}_2$ ,  $\text{SO}_3$ , and  $\text{Al}_2\text{O}_3+\text{Fe}_2\text{O}_3$  content is not achievable.

4. Total energy consumption in the production of soda ash in the range of 9.7 – 13.6 GJ per tonne of dense soda ash produced (or 8.8 – 12.8 GJ per tonne of light soda ash produced) of which 2.2 – 2.8 GJ/t is in the lime kiln unit – see Sections 2.3, 2.3.7, 2.4.1 and 2.4.2.
5. Optimised operation of the soda ash plant, to maintain the emissions of  $\text{CO}_2$  from the process in the range of 0.2 – 0.4 tonne of 100 %  $\text{CO}_2$  per tonne of soda ash produced (integrated production of soda ash with refined sodium bicarbonate at the site can lead to much lower emission levels) – see Sections 2.3, 2.3.3.2, 2.4.1 and, in particular, to Section 2.4.3.
6. High concentration of the  $\text{CO}_2$  gas in the range of 36 – 42 % at the outlet of the vertical shaft lime kiln, thus allowing high process efficiency and low impact of the production of soda ash on the environment. For modern lime kilns and new soda ash plants, the concentration is expected to be at the higher end of the range – see Sections 2.3.8.1, 2.3.8.1.2 and, in particular, Section 2.4.4.
7. High recovery of ammonia in the process, with the total losses of ammonia in waste waters from the distillation unit of less than 0.9 kg N- $\text{NH}_3$  per tonne of soda ash produced. It should be noted, however, that older equipment may not be able to achieve such levels, as significant additional quantities of steam which has both the cross-media effects of emissions associated with the steam generated, as well as a significant increase in cost, are required. – see Sections 2.3, 2.3.3.5, 2.4.1 and, in particular, to Section 2.4.6.
8. The quantity of waste waters, discharged from the distillation unit to a local watercourse, in the range of 8.5 – 10.7  $\text{m}^3$  per tonne of soda ash produced – see Sections 2.3.1, 2.3.4.1, 2.3.4.1.2 and 2.4.7.
9. The quantity of suspended solids in the waste waters discharged from the distillation unit, within the range of 0.09 – 0.24 tonne solids per tonne of soda ash produced – see Sections 2.3, 2.3.1, 2.3.4.1, 2.3.4.1.1, 2.3.9.2 and 2.4.7.1.

In cases where a limestone deposit of lower grade, with the content of 85 to 95 %  $\text{CaCO}_3$ , is used, and where other limestones of better quality are not readily available, these levels will not be achievable.

This is a process related BAT, whilst, e.g. BAT 10 in this section, addresses downstream waste water treatment options outside of the process plant itself.

10. With regard to the impact of waste waters (containing suspended solids and associated heavy metals) discharged from the production of soda ash to the aquatic environment:
  - A. Where the final discharge is made to the marine environment (to the sea or into an estuary of a river under tidal influence, depending on local considerations), to ensure dispersion of the solids avoiding localised build-up of deposited solids and in any case to minimise the discharge of heavy metals using feedstock selection – see Sections 2.3.10.1.1, 2.4.7.2, 2.4.7.1 and 2.4.7.3.

B. Where the final discharge is made to a fresh water body, to:

minimise the emission of heavy metals by the application of at least one of the following techniques:

- selection of appropriate feedstocks (see Section 2.4.7.1)
- removal of coarse solids from waste waters (see Section 2.4.7.3)
- deposition/dispersion – settling ponds (see Section 2.4.7.4)
- deposition/dispersion – underground disposal (see Section 2.4.7.5)

minimise the emission of suspended solids by the application of at least one of the following techniques, depending on the characteristics of the receiving water body:

- selection of appropriate feedstocks (see Section 2.4.7.1)
- removal of coarse solids from waste waters (see Section 2.4.7.3)
- deposition/dispersion – settling ponds (see Section 2.4.7.4)
- deposition/dispersion – underground disposal (see Section 2.4.7.5).

11. Where no use exists for the waste solids originating from the purification of salt brine (carbonates, sulphates, Ca, Mg and heavy metal ions), dispose of them either in the brine cavities or, if this is not possible, in a similar manner as with the liquid effluent from the distillation unit – see Sections 2.3.4.2, 2.3.10.4.3, 2.4.7 and 2.4.7.5.
12. Discharge of fines of limestone and non-recycled grits from the slaker in the range of 50 - 350 kg per tonne of soda ash produced – see Sections 2.3, 2.3.5 and 2.4.7.
13. Reduce dust emissions by using a combination of modern dust abatement techniques and optimum handling of raw materials and products (e.g. encapsulation of storage and transport facilities) – see Section 2.3.3.1.

A. For dry gas streams, apply bag filters to achieve a total dust emission level to air of  $<5 - 20 \text{ mg/Nm}^3$ .

B. For wet gas streams, apply wet scrubbers to achieve a total dust emission level to air of  $<25 - 50 \text{ mg/Nm}^3$ . Recent experience shows that these levels can be difficult to achieve, e.g. in gas streams with pressure drop limitations.

### 3 TITANIUM DIOXIDE

#### 3.1 General information

##### 3.1.1 Introduction

Titanium dioxide (TiO<sub>2</sub>) white inorganic pigments are used primarily in the production of paints, printing inks, paper and plastic products. TiO<sub>2</sub> is also used in many white or coloured products including foods, cosmetics, UV skin protection products, ceramics, fibres, rubber products and more. Titanium dioxide is of outstanding importance as a white pigment because of its scattering properties, its chemical stability, and lack of toxicity [13, EIPPCB, 2000]. Titanium dioxide pigments are made from one of two chemical processes: the chloride route, which leads to TiO<sub>2</sub> products by reacting titanium ores with chlorine gas; and the sulphate route, which leads to TiO<sub>2</sub> products by reacting titanium ores with sulphuric acid. Chloride and sulphate pigments are both used in a wide range of applications. There are some preferred end uses for pigments from each process.

As illustrated in Table 3.1, in 1996 world TiO<sub>2</sub> consumption reached nearly 3.4 million tonnes; approximately 59 % go into paints, 20 % into plastics, and 13 % into paper.

Use	Consumption, kt	Percentage (%)
Coatings	1988	59
Paper	424	13
Plastics	686	20
Others	286	8
<b>Total</b>	<b>3384</b>	<b>100</b>

**Table 3.1: World consumption of TiO<sub>2</sub> pigments in 1996**  
[87, Ullmann's, 2001]

Estimated 1993 – 2000 growth rates of TiO<sub>2</sub> consumption by region, given in Table 3.2, illustrate that the titanium dioxide industry is one of the most dynamically developing segments of the global chemical industry sector.

End use	US	Middle & Eastern Europe, Africa	Asia and Pacific	World total
Coatings	3.4	2.0	5.0	2.5
Paper	2.0	4.0	4.0	3.0
Plastics	4.5	5.0	10.0	5.5
Total	3.0	2.5	6.5	3.3

**Table 3.2: Annual growth rates of TiO<sub>2</sub> use (1993 – 2000, %)**  
[87, Ullmann's, 2001]

Titanium dioxide is the most important inorganic pigment in terms of quantity. The world production in 2000, amounting to nearly 4 million tonnes per year, is given below in Table 3.3:

Year	Sulphate process <sup>(2)</sup>		Chloride process		Total
	kt per year	%	kt per year	%	kt per year
1965	1254	90.3	135	9.7	1389
1970	1499	77.4	437	22.6	1936
1977	1873	72.3	716	27.7	2589
1988	1781	60.2	1178	39.8	2959
1995	1481	46.0	1739	54.0	3220
2000 <sup>(1)</sup>	1540	40.0	2310	60.0	3850

(1) Estimated; (2) A number of plants based on the sulphate process have recently been commissioned in China.

**Table 3.3: World production of TiO<sub>2</sub> pigment**  
[87, Ullmann's, 2001], [85, EIPPCB, 2004-2005]

World TiO<sub>2</sub> pigment production capacities in 1995 by region are given in Table 3.4.

Country	Capacity, kt per year		
	Chloride	Sulphate	Total
Total America	1381	211	1592
Total W. Europe	364	930	1294
Total E. Europe	0	216	216
Total Africa	0	38	38
Total Australia	143	35	178
Total Japan	55	289	344
Total Far East	137	109	246
<b>Total world</b>	<b>2080</b>	<b>1828</b>	<b>3908</b>

**Table 3.4: World TiO<sub>2</sub> pigment production capacities in 1995 by region**  
Based on [87, Ullmann's, 2001]

World TiO<sub>2</sub> production capacities in 1995 were split approximately to 47 % for the sulphate process and 53 % for the chloride process.

Present capacities of the EU-25 (plus Norway) titanium dioxide industry and TiO<sub>2</sub> producers, illustrated by country, company, location and the capacity in either the chloride or sulphate process route, are given in Table 3.5.

Country	Location	Capacity, kt per year		
		Chloride	Sulphate	Total
Germany	Leverkusen	100	30	130
	Nordenham		62	62
	Krefeld-Uerdingen		130	130
	Duisburg-Homberg		100	100
UK	Grimsby		80	80
	Greatham	100		100
	Stallingborough	150		150
France	Le Havre		95	95
	Thann		30	30
	Calais		100	100
Finland	Pori		120	120
Italy	Scarlino		80	80
Belgium	Langebrugge	60		60
Spain	Huelva		80	80
Netherlands	Rotterdam	55		55
Norway	Fredrikstad		30	30
Czech Republic	Prerov		41	41
Poland	Police		40	40
Slovenia	Celje		44	44
<b>Total EU-25 + Norway</b>		<b>465</b>	<b>1062</b>	<b>1527</b>

Note: Czech Republic, Poland and Slovenia – updated TiO<sub>2</sub> capacities.

**Table 3.5: EU-25 (plus Norway) TiO<sub>2</sub> pigment production capacities in 2002**  
Based on [20, CEFIC-TDMA, 2004], [85, EIPPCB, 2004-2005]

### 3.1.2 General description of the European titanium dioxide industry

The titanium dioxide industry has developed dynamically over the past few decades. From its first commercialisation in the 1920s, the titanium dioxide (TiO<sub>2</sub>) product has ever increasingly been used to enhance the opacity, whiteness and brightness of many everyday articles. It is a global industry in which about 1.5 million tonnes of titanium dioxide per year is produced at the 19 European sites. Approximately 30 % of this is produced at five sites by the chloride process. The remainder is made by the sulphate process.

Almost all titanium dioxide is sold as a pigmentary powder to industrial manufacturers of paints, plastics, paper, fibres, printing inks, ceramics and similar products where its purpose is to provide a white or pastel colour.

Over the past 20 years, the European TiO<sub>2</sub> industry has invested as much as EUR 1400 million in environmental improvement [20, CEFIC-TDMA, 2004]. This expenditure was initiated in the 1970s and boosted as a result of the three specific TiO<sub>2</sub> Harmonisation Directives: 78/176/EEC; 82/883/EEC and 92/112/EEC [21, The Council of the EU, 1992], which prescribe minimum environmental performance standards for the titanium dioxide industry, to which the TiO<sub>2</sub> industry is required to comply. Most of this investment has been put into the sulphate process and it is believed that environmentally there is little difference between a modern sulphate process and a modern chloride process [20, CEFIC-TDMA, 2004]. This is discussed further in the subsequent sections. Company environmental cultures have also evolved over the same period, which has resulted in a proactive approach to environmental issues. This has resulted in each company applying environmental techniques most applicable to the process used at their specific sites.

### 3.1.3 History of markets

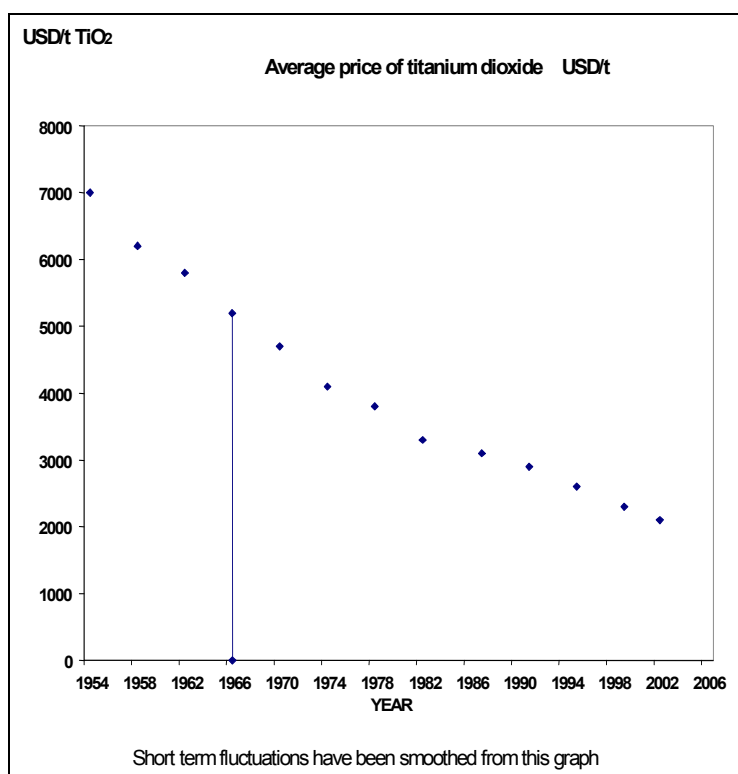
Titanium dioxide pigments have been produced since the end of the First World War, but it was not until the late 1920s that production of high purity anatase pigments by the sulphate process reached commercial levels. These pigments rapidly began to replace the existing pigments such as 'lead white', which itself is toxic. Rutile pigments began to be marketed in the 1940s. Anatase and rutile are different crystal forms of TiO<sub>2</sub>; rutile makes a generally superior pigment but is not suitable for all applications.

Commercial chloride pigment production was introduced in the late 1950s. World sales of TiO<sub>2</sub> pigments grew to 1 million tonnes per year by 1963, achieved over 2 million tonnes by 1977 and reached over 3.9 million tonnes by the end of the 1990s. Once it was established, the overall TiO<sub>2</sub> market grew broadly in line with world Gross Domestic Product (GDP).

The long term growth rate for the titanium dioxide industry is just under 3 % per year. For most of the 1990s, the titanium dioxide industry in Asia had been growing significantly faster than the worldwide long term rate and today represents 20 % of the world market, with north America at 38 % and Europe at 30 %. The global production capacity is approximately 55 % chloride and 45 % sulphate compared with 30 % chloride and 70 % sulphate in Europe. No new plants have been built in Europe for more than a decade. Some markets require pigment specifically from either the chloride process or the sulphate process, but for around 80 % of end-use, pigments from either process can be produced to meet the customer's needs equally well.

The whiteness and brightness of the TiO<sub>2</sub> pigment requires that the base material is made to a high degree of purity and its suitability for different uses is dictated by its particle size and final treatment (coating).

As illustrated in Figure 3.1, there has been a downward trend in prices in real terms over the past three decades in all regions, and it is clearly visible when average TiO<sub>2</sub> prices are analysed over that period. This has resulted in considerable efforts to improve plant efficiencies and increase the scale of operations in order to reduce costs.



**Figure 3.1: Trend prices in titanium dioxide pigment commodity product [20, CEFIC-TDMA, 2004]**

There is a significant fluctuation in the long term trend price in all regions, depending on changes in the supply and demand balance within each region. The variable and cyclic nature of demand means that it is very difficult to plan plant capacity increases in time correctly, and historically it has been seen that new capacity is often just coming on stream as the market begins to turn down. It should be noted that the cycles in the titanium dioxide industry are not expected to always be in phase with the overall chemicals industry cycle.

### 3.1.4 Producer companies

Five companies account for about 80 % of the global market. Throughout much of the 1990s there has been an excess capacity in the industry and intense competition amongst producers.

These market conditions have tended to favour the larger and more cost competitive producers. In addition, prices have not been at levels sufficient to justify major new investments in production capacity. All these factors have led to some consolidation in the industry recently [20, CEFIC-TDMA, 2004], [8, CEFIC, 2004].

European plants covered by this document are situated in the UK, Germany, France, Italy, the Netherlands, Belgium, Spain, Finland, Czech Republic, Poland, Slovenia, and Norway – see Table 3.5 and Table 3.6. However, apart from the Czech Republic, less information is available for the other new Member States.

The majority of the plants were built during the period 1948 to 1980, but they have all undergone major overhauls during the last 12 years and some have been shut down and replaced with a new plant on the same site.

Table 3.6 illustrates a very high cost burden for the European TiO<sub>2</sub> industry, in particular in older plants based on the sulphate route, to cope with more and more stringent emissions levels. Because of the economic situation in the industry, new grass root plants are unlikely to be built but the trend is to debottleneck or build new streams on existing locations. On average, environmental improvement has increased running costs by 10 to 15 %.

Company	Location	Process route	Environmental Capex EUR million	Capex period	Factory start-up year
Company A	Fredrikstad, Norway	Sulphate	20	1988 to 1999	1916
	Langerbrugge, Belgium	Chloride <sup>(1)</sup>	75	1987 to 1999	1957 (SP) 1989(CP)
	Nordenham, Germany	Sulphate	70	1986 to 1999	1969
	Leverkusen, Germany	Chloride and Sulphate	125	1982 to 1999	1972 1927
Company B	Grimsby, UK	Sulphate	59	1990 to 1999	1948
	Greatham, UK	Chloride	19	1990 to 1999	1971
	Huelva, Spain	Sulphate	67	1990 to 1999	1973
	Calais, France	Sulphate	146	1990 to 1999	1967
	Scarlino, Italy	Sulphate	40	1985 to 1999	1974
Company C	Pori, Finland	Sulphate	96	1980 to 1999	1961
Company D <sup>(2)</sup>	Rotterdam, the Netherlands	Chloride	160	1989 to 1999	1961 <sup>(3)</sup>
	Uerdingen, Germany	Sulphate	34 200	1992 to 2000 up to 1991	1957
Company E	Stallingborough, UK	Chloride	61 <sup>(4)</sup>	1987 to 2000	1968
	Le Havre, France	Sulphate			
	Thann, France	Sulphate	33	1989 to 2001	1922
Company F	Prerov, Czech Republic	Sulphate	15	1990 to 1999	1968
Company G	Duisburg, Germany	Sulphate	125	1987 to 1994	1962
Company H	Police, Poland <sup>(5)</sup>	Sulphate	11	1995 to 2003	1977
Company I	Celje, Slovenia <sup>(6)</sup>	Sulphate	?	?	?

(1) The Langerbrugge sulphate plant in Belgium was closed in 1989 and a chloride plant started up in 1989 on the same site.  
(2) The Antwerp plant in Belgium was shut down in 2001 due to being too small a unit to run economically.  
(3) The Rotterdam sulphate plant in the Netherlands was closed and a chloride plant started up in 1990.  
(4) Including EUR 4.8 million on Stallingborough sulphate plant which was closed in 1996.  
(5) Data on the Polish plant are based on new information submitted.  
(6) The data which also need to be included in the EU-25 scale are those on the TiO<sub>2</sub> plant in Celje, Slovenia.

**Table 3.6: TiO<sub>2</sub> industry site details including capital costs of environmental improvements [20, CEFIC-TDMA, 2004], [85, EIPPCB, 2004-2005]**

It should be said that over the last decade or so there have been very positive changes in environmental culture of the EU-25 companies producing TiO<sub>2</sub>. The attitudes have changed from defensive to proactive. This is demonstrated by the following:

- in the EU-15 all companies listed in this document are signatories to 'Responsible Care'
- six of the 19 sites have achieved ISO 14001 or EMAS and are, therefore, committed to a programme of continual environmental improvement
- seven are actively working to achieve these management standards
- 12 plants issue publicly available annual environmental reports.

These factors have led to the companies progressively upgrading the equipment and improving management of their plants.

There are in total 19 production sites and 20 TiO<sub>2</sub> plants in the EU-25, as given in Table 3.5. The size of the plants varies from 30 kt up to 150 kt per year (refer to Section 1.1.5.2). About 7000 persons are employed directly in the manufacturing of TiO<sub>2</sub> across Europe [20, CEFIC-TDMA, 2004], [8, CEFIC, 2004].



## 3.2 Titanium dioxide – the chloride process

### 3.2.1 Introduction

Titanium dioxide can be made by one of two basic routes: The chloride process covered in Section 3.2, and the sulphate process covered in Section 3.3. In both processes pure titanium dioxide powder is extracted from its mineral feedstock after which it is milled and treated to produce a range of products designed to be suitable for efficient incorporation into different substrates as described above. Although current versions of the two processes have been demonstrated to be environmentally equivalent by the use of life cycle assessment techniques [20, CEFIC-TDMA, 2004] (see Section 3.4.5), the two processes are fundamentally different in most aspects. Therefore, in this document the processes and their emission abatement techniques are treated separately. A comparison of the two processes is included in Section 3.4.

### 3.2.2 Applied processes and techniques – the chloride process

As illustrated in Figure 3.2, chlorine gas is used as an intermediary in the process and is recovered for re-use. The chloride process can treat a wide range of ores including natural rutile (95 % TiO<sub>2</sub>), titanium rich slag and synthetic rutile (90 – 93 % TiO<sub>2</sub>). Higher concentration ores are preferred to minimise chlorine losses, because impurities, such as iron in the ore feed result in a net loss of chlorine. Significant quantities of make-up chlorine gas are required for low TiO<sub>2</sub> content feedstocks.

#### 3.2.2.1 Raw material import and preparation

Ore containing titanium dioxide is sourced from outside Europe. In the past, it was normally high grade mineral rutile, however in recent years this has become increasingly scarce and costly and has been replaced by a material whose TiO<sub>2</sub> content has been artificially upgraded. This can be a slag from a blast furnace process in which the iron is extracted for use in its own right or a synthetic rutile in which metals (mainly iron) are leached out with dilute acid. This is typically done at the quarrying site of the primary ore. The environmental impact of these beneficiation processes is taken into account when making a comprehensive environmental comparison of the chloride process with the alternative sulphate process.

In a life cycle assessment used to compare the two processes (see Section 3.4.5), both the energy use and associated emissions resulting from the TiO<sub>2</sub> beneficiation process are taken into account, to analyse the overall environmental burden for modern TiO<sub>2</sub> manufacturing processes.

Suppliers of ore upgraded by wet methods should be encouraged to use environmentally acceptable methods of leaching the original feedstock and disposing of the wastes. There is potential here for developing co-products from the waste streams. It is a core principle of ISO14001 to require suppliers and customers to commit to environmental improvements and this is a clear example.

Similarly, slag producers should be encouraged to have an active environmental policy and procedures for producing the slag.

The wet mineral feedstock may be stored in stockpiles without problems but before feeding it to the titanium dioxide plant the ore has to be dry. Usually feedstock drying is not necessary, but in the event of the moisture specification being exceeded, drying is usually done in flue-gas dryers heated directly at about 120 °C. Currently feedstock drying is not carried out in any of the European sites, except for one site where ore and coke material from chlorinator blow-over is recovered in a wet state and must be dried before re-use. The dry dust is separated from the flue-gas by cyclones and filters and fed to the chlorinators.

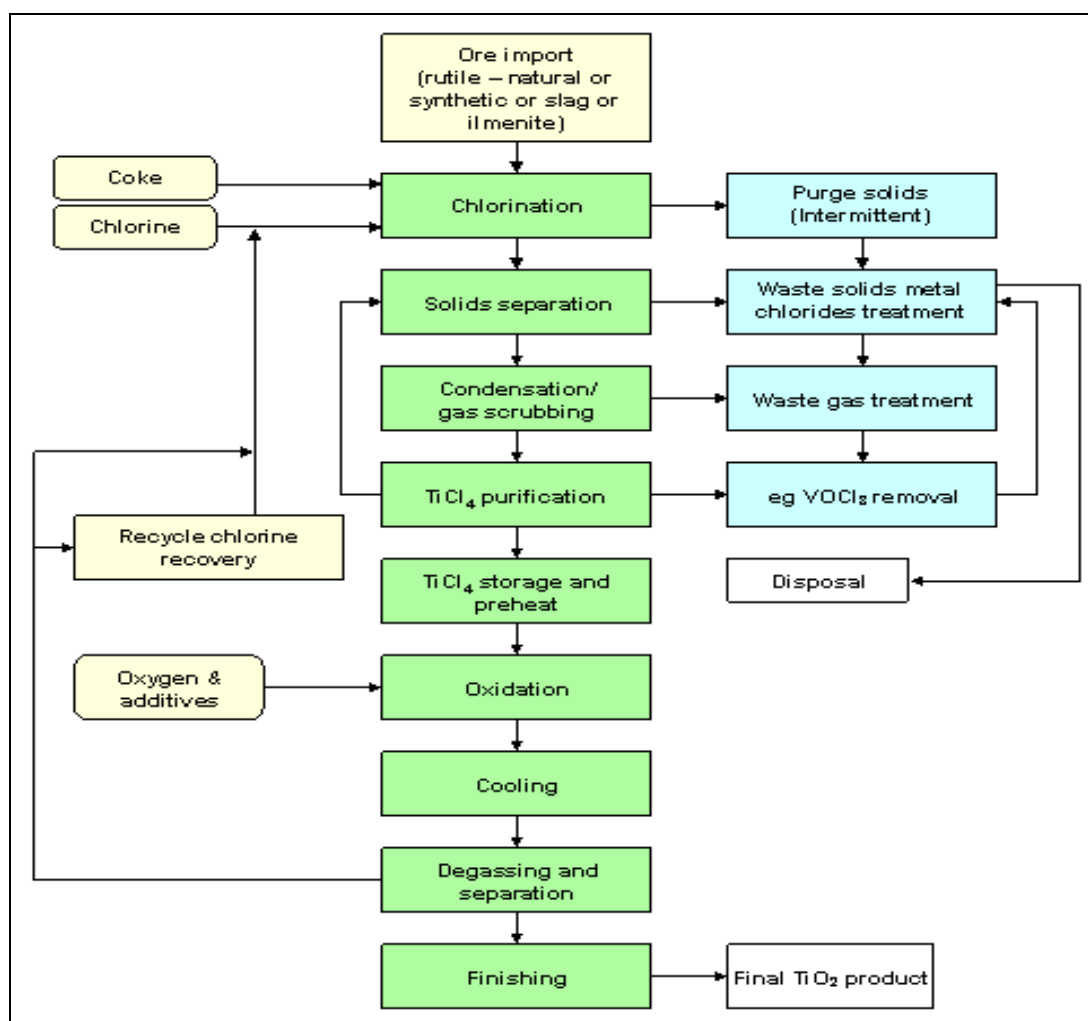


Figure 3.2: Outline flow diagram – TiO<sub>2</sub> chloride process route [20, CEFIC-TDMA, 2004]

Feedstock purchasing decisions are multidimensional (economic, plant operability, product quality, cost of abatement, waste disposal, etc.) and can change over time. The feedstock of the required purity is purchased according to a set of specifications, set as part of the feedstock purchasing strategy. One of the critical factors is the question of impurities and, therefore, the purity check of titanium ore plays an important role in the production process.

There are two main issues here. Some heavy metal impurities are not acceptable since trace levels in the final product can influence the whiteness and brightness. The other issue is trace levels of Naturally Occurring Radioactive Materials (NORM) which are present in some ores. This means that with these feedstocks the processing is subject to the Euratom Directive, 96/29 [22, Euratom, 1996], which may mean that the ore handling and disposal of some wastes is subject to exposure assessment.

The companies take all necessary precautions to protect personnel and the environment as required by Euratom.

The other main solid raw material is coke, which is required in a granular form suitable for fluidisation in the chlorination process.

If drying is required, it results in normal furnace gaseous emissions (NO<sub>x</sub>, SO<sub>x</sub>, etc.), however the main issue in feedstock preparation on site is dust emissions during the movement of materials. Normally this is controlled by handling the ore in closed systems kept under reduced pressure with the dust being collected in cyclones and filters for re-use.

Table 3.7 illustrates components in the main mineral feedstocks for the titanium dioxide industry based on the chloride process route.

Type of feedstock	Component	Portion (mass content in %)
Mineral rutile	TiO <sub>2</sub>	95 – 96
Slag	TiO <sub>2</sub>	86 – 87
Synthetic rutile	TiO <sub>2</sub>	90 – 93

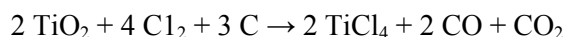
**Table 3.7: Components in the main mineral feedstocks for the titanium dioxide industry [20, CEFIC-TDMA, 2004]**

Another main raw material involved at this stage is chlorine, which is invariably recycled within the process, with any ‘make up’ chlorine usually being imported by tanker as a liquid. The hazardous nature of chlorine is the main property, which influences the basic design of the chloride process. This means that the initial primary stages of the process (the ‘black end’) are totally enclosed and of high integrity. In Europe, all processes are controlled by the Seveso II EU Directive regulations [23, The Council of the EU, 1996] and by the Titanium Dioxide Harmonisation Directive [21, The Council of the EU, 1992], which require detailed hazard assessments to be carried out and minimal emissions of chlorine into the environment respectively. Chlorine is delivered by pipeline rail and road depending on the site location.

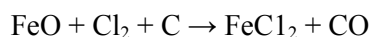
Pure gaseous oxygen is essential to ensure full oxidation of the titanium tetrachloride. This is normally obtained off-site by pipeline, however, it can be cost effective to have the liquefaction plant close to the TiO<sub>2</sub> site. Increasingly, nitrogen gas (which is obtained from the same source) is used as a gland purge gas to minimise moisture ingress.

### 3.2.2.2 Chlorination

Ore containing titanium dioxide and coke are fed to a fluidised-bed reactor where an exothermic reaction with chlorine gas takes place at 1000 °C. The primary reaction is:



Impurities such as iron oxide will react in a similar manner:



Impurities such as silica and zirconium do not chlorinate and may accumulate in the reactor. There is, however, a natural attrition and carryover of fines along with the off-gases, and this may be sufficient to prevent their build-up. Otherwise the solids will require periodic removal. The reactors may require total bed replacement about once a year.

In one location, coke and unreacted bed material is separated and re used as raw material feed.

### 3.2.2.3 Solids separation

The resulting vapours of titanium tetrachloride plus other volatile metallic chloride impurities are cooled with recycled cold TiCl<sub>4</sub>, which allows the removal of some impurities.

#### 3.2.2.4 Waste solid metal chlorides treatment

Solid metal chlorides are usually neutralised with lime which renders the residual metals insoluble before disposal as a solid waste to landfill. Historically, many attempts have been made to treat the metal chlorides to recover the chlorine. This has usually been done with the objective of using feedstocks with a lower TiO<sub>2</sub> content such as ilmenite. This development has never been commercially successful. At one site, ore and coke are separated from the metal chloride stream prior to this stage and filtered and stockpiled for re-use as a feedstock. At another site, separated coke is sold commercially, and the same site markets ferrous chloride (FeCl<sub>2</sub>).

#### 3.2.2.5 Condensation

The majority of the titanium tetrachloride is condensed from the gas stream and pumped to a dedicated storage facility. More impurities and tetrachloride are removed from the gas stream by jet scrubbing with cold tetrachloride, which is also pumped to storage. The gas stream is then passed for waste gas treatment.

#### 3.2.2.6 Waste gas treatment

See Section 3.2.2.14 below – Abatement systems for gases.

#### 3.2.2.7 Distillation

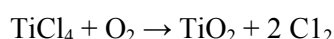
Further purification of TiCl<sub>4</sub> by distillation is carried out and the distillate product is stored for further downstream uses or export.

#### 3.2.2.8 Vanadium oxychloride removal

Vanadium oxychloride has similar thermal properties to titanium tetrachloride and is not separated upstream of distillation and, furthermore, would not be separated by conventional fractional distillation. Separation is achieved by the addition of an appropriate quantity of mineral or organic oil to the liquid being distilled. Vanadium oxychloride complexes with this oil and it is separated as a sludge, which is recycled back to solids separation, where it is removed from the process stream.

#### 3.2.2.9 Oxidation

From storage, the liquid titanium tetrachloride and oxygen are preheated before mixing. Oxidation of the TiCl<sub>4</sub> to titanium dioxide and chlorine is carried out at between 900 – 1000 °C and 1500 – 2000 °C (overall range between 900 – 2000 °C), in either a plasma arc furnace or in a toluene fired furnace, using oxygen injection [20, CEFIC-TDMA, 2004], [42, UBA-Germany, 2001]. The reaction involved is:



The oxidation phase is used to control the final quality of the TiO<sub>2</sub> crystal size to enable the product to be used as a pigment. Light metal chlorides (usually of aluminium and alkali metals) are used to aid this process. The reaction products are cooled and the titanium dioxide powder is collected in bag filters and the chlorine is recycled.

Oxygen supply and storage also need to be described. Of the five chloride plants covered in this document, four are supplied by pipeline with the production and storage of liquid oxygen on remote sites. One site has a local supplier with production and storage facilities on an adjacent site. The arrangement is supply on demand with only limited quantities of liquid storage to cover maintenance and unplanned downtime. The energy consumption and associated emissions are included in the LCA study – refer to Section 3.4.5.

### **3.2.2.10 Cooling and separation**

The oxidation product stream is a mixture of chlorine, oxygen and titanium dioxide powder. After exiting the reactor, these are cooled by indirect water-cooling. The titanium dioxide is slurried with water and transferred to the finishing stage (see Section 3.3.2.9). Finishing treatment is similar to that of the sulphate process, including conditioning with additives.

Chlorine is separated in one of two ways. In the first (the older process), chlorine is absorbed/desorbed in liquid titanium tetrachloride before being returned to chlorination. In the second process, the chlorine from oxidation is directly recycled to chlorination [26, EIPPCB, 2003]. The basic processing stages are similar.

### **3.2.2.11 Absorption/desorption process**

In the oxidation stage of the older process, the oxide is separated from the carrier gas, which is predominantly chlorine. The titanium dioxide is slurried in water and sent for finishing. The chlorine gas is drawn from the filters and then absorbed in liquid titanium tetrachloride in an absorption column. This liquid is stored, whilst the tail-gases pass to a scrubber train, to remove residual chlorine, with inerts passing to the main process stack.

Chlorine is recovered by desorption from the liquid titanium tetrachloride. The recycled chlorine is liquefied and stored or directly used in the chlorination section.

### **3.2.2.12 Direct chlorine recycling process**

This process involves the direct recycling of chlorine from oxidation to chlorination, by operation of the oxidation reactors at a higher pressure than the chlorinators. It requires both the oxidation and chlorine process systems to be precisely synchronised. In both the new and old chlorine recovery processes, the gas solid separation systems are similar.

### **3.2.2.13 Finishing**

This is common to both the chloride and sulphate process – refer to Section 3.3.2.9.

### **3.2.2.14 Abatement systems for gases**

Off-gases from chlorination that include carbon monoxide (not present if a thermal oxidiser is in the process line – see below), carbon dioxide, with some hydrogen chloride and titanium tetrachloride, pass through the scrubbing train. Aqueous scrubbers absorb the HCl and then caustic scrubbing removes any chlorine that may ‘slip’ from the reaction stage.

This is achieved either by using a dedicated caustic scrubber with a backup caustic solution injection available or by direct injection of caustic into an aqueous scrubber in the event that chlorine is detected. When sodium hypochlorite is produced, it can either be sold or converted catalytically to salt water and oxygen before discharge.

It is practicable to produce sale grade hydrochloric acid in the first stage of scrubbing using demineralised water. This is done by a number of the European factories.

In the last few years, thermal converters have been installed to convert carbon monoxide and carbonyl sulphide (COS) in the tail-gas to carbon dioxide and sulphur dioxide, which reduces the toxicity of the discharge gases. There are specific variations at different sites:

- gases are scrubbed via 14 % and 28 % acid in scrubbers, then fed to a thermal converter, and then to a final scrubber or are directly sent to a final caustic scrubber. 28 % hydrochloric acid is sold as a co-product. No hypochlorite is sold. Waste caustic is neutralised with other effluents generated at the site
- the acid scrubber is followed by a thermal converter. No hydrochloric acid is sold. Hypochlorite is produced
- the acid scrubber is followed by a caustic scrubber or a thermal converter depending on the location. Hydrochloric acid is sold as a co-product. Sulphur is removed from the thermal converter stream for sale. No hypochlorite is produced.

Other venting and pressure reliefs from the process and storage areas (particularly chlorine) are usually scrubbed with caustic soda solution.

Refer also to the BREF on CWW, and to Section 8.2.4.1.

#### **3.2.2.15 Abatement systems for solids**

Waste solids from the chlorination stage, which consist of metal chlorides, coke and some ores, are neutralised in a chalk or lime slurry. The metals are precipitated and stabilised, and the filter cake is landfilled, while the aqueous filtrate is discharged to the appropriate aqueous environment.

Alternatively, the waste solids can also be treated by a special process to convert them into by-product hydrochloric acid and oxides. The conversion process involves roasting the chlorides in air to form HCl and leaving the oxides and unreacted coke as a solid residue. Steam may be raised with a waste heat boiler. The process has the potential for producing a relatively inert oxide and its possible use as an inert filler. It also allows for the chlorine content of the wastes to be utilised as hydrochloric acid. In the situation where the acid is sold, excess acid is usually neutralised.

Sand, salt (or granular TiO<sub>2</sub>) may be used to scour titanium dioxide from the oxidation cooler. It is separated through lock hoppers or sand screens and sent to landfill, or re-used.

#### **3.2.2.16 Abatement systems for liquids**

Liquid emissions from the process are treated in a variety of ways. They can be an integral part of the gas and solids treatment systems, which normally has the effect of neutralising residual acidity and precipitating soluble metal chlorides. A significant proportion of the effluent can originate from the finishing section of the plant. This liquid consists of slightly alkaline solutions of alkali metal sulphates and chlorides together with suspended solids (TiO<sub>2</sub>), which result from the coating process. These variations mean that the final effluent can be acidic or alkaline. In all cases, the consent limits of the effluent composition are influenced by the nature of the receiving media.

Refer also to the BREF on CWW, and to Section 8.3.4.

**3.2.2.17 Co-products for sale or re-use**

As described above, various emission treatment systems produce different co-products. They are sodium hypochlorite, hydrochloric acid, coke, iron chloride, metal oxide beads,  $\text{TiOCl}_2$  solution, and sulphur cake (refer also to Section 7.4).

**3.2.2.18 Purified titanium tetrachloride for sale**

At least in one European  $\text{TiO}_2$  plant based on the chloride process route, a minor part of the purified  $\text{TiCl}_4$  is sold outside of the plant. To this end, a storage facility exists which is also subject to the provisions of the Seveso II Directive [23, The Council of the EU, 1996].

The co-production of the purified  $\text{TiCl}_4$  is determined by several reasons, including market demand (also for the  $\text{TiCl}_4$  used in the nucleation system in the titanium dioxide sulphate process), the possibility to lighten the process load in the back end of the plant (oxidation, cooling, separation), and to optimally adjust the energy balance in the plant.

**3.2.3 Present consumption and emission levels – the chloride process****3.2.3.1 Current environmental performance**

All data originate from the five European chloride sites and are for the year 1999 [20, CEFIC-TDMA, 2004]. Also, to bridge the gap between 1999 and the present time two case studies summaries of the environmental performance of two sites in 2002, one chloride and one sulphate, are given in Sections 3.2.3.7 and 3.3.3.6. Emissions to air and water, and waste to land, are given for the main stages of the process. Energy usage and water consumptions are given similarly but the process units are less detailed.

Unless stated otherwise, emissions and usages are given in kg per tonne of titanium dioxide pigment and, where appropriate, volume based emissions are included.

**3.2.3.2 Raw materials consumption****3.2.3.2.1 Chlorination****Ore usage**

The  $\text{TiO}_2$  content of the main feedstocks range from 85 to 95 % and most sites use a selection of these materials in any one year. This makes direct comparison of the usages not very meaningful [20, CEFIC-TDMA, 2004]. A more useful comparison can be made by looking at the  $\text{TiO}_2$  throughput. It is seen that the average consumption is 1075 kg  $\text{TiO}_2$  (in feedstock) per tonne of  $\text{TiO}_2$  pigment with a range of less than 5 %. Even here it is not valid to read too much into the maxima and minima data because they are made up of two or more different usages (including blends), which sometimes means that the usage is over or under estimated [20, CEFIC-TDMA, 2004].

Material	Mean kg/t $\text{TiO}_2$	Max kg/t $\text{TiO}_2$	Min kg/t $\text{TiO}_2$
Feed	1075	1145	975

**Table 3.8: The  $\text{TiO}_2$  content of the main feedstocks [20, CEFIC-TDMA, 2004]**

The minimum figure in this box may cause some confusion, as it appears to indicate a reaction efficiency of over 100 %. However, as shown in Table 3.8, the results are reported as kg per tonne of TiO<sub>2</sub> pigment [20, CEFIC-TDMA, 2004]. For the record, the range of ore consumption is 1060 – 1189 kg/tonne pigment [20, CEFIC-TDMA, 2004]. The figures reflect a high physico-chemical efficiency of the chlorination process.

### Chlorine usage

As illustrated in Table 3.9 below, chlorine gas is used as an intermediary in the process, the majority of which is recovered for re-use. However, some is used for chlorinating the impurities in the feedstock.

Material	Mean kg/t TiO <sub>2</sub>	Max kg/t TiO <sub>2</sub>	Min kg/t TiO <sub>2</sub>
Chlorine	201	300	114

**Table 3.9: Chlorine usage**

The variation in usage is a direct function of the level of impurity in the feedstock that will undergo chlorination at the same time as the TiO<sub>2</sub>.

### Coke usage

The chlorination reaction requires carbon. It is supplied by high grade coke, which is continually added to the fluid bed.

Material	Mean kg/t TiO <sub>2</sub>	Max kg/t TiO <sub>2</sub>	Min kg/t TiO <sub>2</sub>
Coke	366	429	285

**Table 3.10: Coke usage**

As illustrated in Table 3.10 above, coke usage can be a function of chlorinator design, in particular allowable fluidisation velocities. In recent years there has been a trend to run at higher velocities, which increases elutriation of unchlorinated particles (both ore and coke) and this reduces the need to shut down and purge these ‘inerts’. The penalty for this is an increase in coke usage, which in turn offers the potential for recovery and re-use or sale of the recovered coke.

### 3.2.3.2.2 Solids separation and waste solid metal chlorides treatment

Material	Mean kg/t TiO <sub>2</sub>	Max kg/t TiO <sub>2</sub>	Min kg/t TiO <sub>2</sub>
Lime	137	220	91
Coal	90		

**Table 3.11: Lime and coal usage**

Various novel methods are used to reduce waste solids and convert them into useful co-products. One site uses coal in a fluid bed reactor to break down the metal chlorides into metal oxide beads and nominally 18 % hydrochloric acid.

This process is, however, technically very problematic and is currently under close examination as to whether, in its present form, it is both environmentally and economically effective [20, CEFIC-TDMA, 2004]. Iron chloride is extracted by another process (refer to Section 7.4). As given in Table 3.11 above, lime is used to neutralise the excess acid and to stabilise waste metal chlorides.



**3.2.3.2.3 TiCl<sub>4</sub> purification**

As given in Table 3.12 below, mineral or vegetable oil is used to complex the vanadium.

Material	Mean kg/t TiO <sub>2</sub>	Max kg/t TiO <sub>2</sub>	Min kg/t TiO <sub>2</sub>
Oil	5	10	2

Table 3.12: Oil usage

**3.2.3.2.4 Oxidation**

As given in Table 3.13 below, pure oxygen is required to oxidise titanium tetrachloride. Some sites burn toluene [42, UBA-Germany, 2001] to achieve the heat input that others achieve by an electric arc (plasma) [20, CEFIC-TDMA, 2004]. In most cases, the oxygen supply gas is by pipeline with the liquefaction and storage plant sited remotely.

Material	Mean kg/t TiO <sub>2</sub>	Max kg/t TiO <sub>2</sub>	Min kg/t TiO <sub>2</sub>
Oxygen	467	573*	395
Toluene	(Included in energy balance)		

\* One site high figure for 1999 because of problems on chlorination that was solved by excess oxygen.

Table 3.13: Pure oxygen used to oxidise titanium tetrachloride

**3.2.3.2.5 Cooling and separation**

Abrasive solids are used to scour the primary coolers, as shown in Table 3.14.

Material	Mean kg/t TiO <sub>2</sub>	Max kg/t TiO <sub>2</sub>	Min kg/t TiO <sub>2</sub>
Silica sand	49	73	26
Rock salt	16	29	7

Table 3.14: Abrasive solids usage

**3.2.3.2.6 Finishing**

Although finishing uses some raw materials, they are either not significant in this context or are covered in other sections (e.g. for caustic soda see box below).

**3.2.3.2.7 Abatement systems for gases**

Gases emitted from the above process are either scrubbed with HCl and the excess HCl is re-used or they are scrubbed with caustic soda solution and converted to sodium hypochlorite for resale or decomposition. The caustic soda solution usage is shown in Table 3.15. There are a number of different configurations of these systems.

Material	Mean kg/t TiO <sub>2</sub>	Max kg/t TiO <sub>2</sub>	Min kg/t TiO <sub>2</sub>
NaOH	104	178	7

Table 3.15: Caustic soda solution usage

### 3.2.3.2.8 Abatement systems for liquids

No significant materials usage occurs here except the lime, which was included in Section 3.2.3.2.2 above.

### 3.2.3.3 Utilities consumption – energy and water

#### 3.2.3.3.1 Energy

As given in Table 3.16 below, based on data compiled in 1999, the overall energy consumption for the production of a titanium dioxide pigment by the chloride process route was in the range of 17 to 29 GJ/t, with an average of approximately 25 GJ/t.

These data were also based on the application of a technique in which extra energy was used for chlorine absorption and desorption (at least 4 GJ/t pigment). This technique, however, is no longer in use in the EU titanium dioxide industry.

Even though a new set of data detailing energy usage in 2005 was not made available by the EU TiO<sub>2</sub> industry, given the progress made in energy efficiency, it has been reported that the upper level of overall energy usage for the chloride process is currently in the range of 21 to 23 GJ/t, and on average 17 to 22 GJ/t pigment [85, EIPPCB, 2004-2005] (refer to Table 3.29 below, which illustrates a clear downward trend of energy consumption between 1999 and 2002 in Greatham, UK).

Refer also to [42, UBA-Germany, 2001], where the energy demand in 2001 (average figures) for the chloride process route, illustrative for one plant in Leverkusen, Germany, was estimated at the level of 18.8 GJ/t and from this for TiO<sub>2</sub> manufacture 6.1 GJ/t and for follow-up treatment 12.7 GJ/t pigment.

Table 3.16 illustrates energy consumption in 1999 of the main production areas [20, CEFIC-TDMA, 2004]. These were site usages of energy, which did not include the energy used in the production of raw materials (ore, oxygen, etc.). These had been taken into account in the LCA study – see Section 3.4.5 [20, CEFIC-TDMA, 2004].

Site/process	Chloride (averages)	Chloride (maximum)	Chloride (minimum)
Date/year	1999	1999	1999
<b>Energy TiO<sub>2</sub> usage ore preparation to oxidation (*)</b>			
Electricity GJ/t	2.3	3.3	1.5
Steam GJ/t	2.4	7.6	1.3
Gas GJ/t	3.2	6.6	1.3
<b>Energy: TiO<sub>2</sub> usage finishing</b>			
Electricity GJ/t	2.6	5.7	0.8
Steam GJ/t	6.9	10.4	7.1
Gas GJ/t	5.7	13.2	2.8
<b>Energy: effluent treatment</b>			
Electricity GJ/t	1.7	2.9	0.5
Steam GJ/t	0.0	0.0	0.0
Gas GJ/t	0.0	0.0	0.0
Heavy fuel oil GJ/t	0.0	0.0	0.0
<b>Overall total energy per site</b>	<b>24.8</b>	<b>28.7</b>	<b>17.4</b>
(*) Average and maximum energy consumption figures 1999 up to oxidation include the operation of indirect, more energy intensive chlorine recycling at some of the sites. This technique is no longer in use in the EU TiO <sub>2</sub> industry.			

**Table 3.16: Energy consumption in TiO<sub>2</sub> production based on the chloride process in 1999 [20, CEFIC-TDMA, 2004]**

It should also be noted [20, CEFIC-TDMA, 2004] that different sites use different sources of energy to perform the same function, hence the above 1999 data rows are the average, maxima and minima for all the sites which helps to explain the variations [20, CEFIC-TDMA, 2004].

As with the sulphate process the energy usage analysis has been simplified [20, CEFIC-TDMA, 2004]. As explained earlier, there is relatively little energy required for effluent treatment since this is effectively carried out at the feedstock production site during the increase in TiO<sub>2</sub> content of the feedstock [20, CEFIC-TDMA, 2004].

### 3.2.3.3.2 Water

As seen in Table 3.17, there is a wide disparity in water usage that is not easily explained. It is probable that local availability of water has some influence [20, CEFIC-TDMA, 2004]. Water usage is quite a complex issue and direct intersite comparison is difficult, however, it may help to set the targets for the reduction of annual water usage, including water re-use.

Site/process	Chloride averages (m <sup>3</sup> /tonne)	Max. chloride (m <sup>3</sup> /tonne)	Min. chloride (m <sup>3</sup> /tonne)
Date/year	1999	1999	1999
Treated	21.49	43.14	10.95
Non treated	11.0	17.0	0.0
Treated water for steam generation	1.82	3.65	0.76
<b>Total water per site</b>	<b>34.5</b>	<b>48.0</b>	<b>22.6</b>

Table 3.17: Water consumption for the chloride process

The above data are the average, maxima and minima for all the sites, which helps to explain the variations, and means that the totals quoted are not necessarily the sums of the columns [20, CEFIC-TDMA, 2004].

### 3.2.3.4 Emissions to air

Because of the nature of the main process, most of the gaseous effluents pass through a common scrubbing system and exit into the atmosphere via a single stack. For the purposes of assessing the effectiveness and efficiency of the primary processing units, the main gaseous emissions have been allocated to their most probable source.

#### 3.2.3.4.1 Raw material import and preparation

Dust is the major issue here and the preparation stage is an intermittent source of dust emissions. There is a wide disparity in the frequency of measurements on different sites due to their particular regimes. For example, one site does not do routine measurements but personnel monitors are used. This makes the combination of the data difficult. Dust and NO<sub>x</sub> emissions are given in Table 3.18.

Emissions to air		
Emitted substance	Dust	NO <sub>x</sub>
Treatment method	Bag filters	
<b>kg/t TiO<sub>2</sub> (average)</b>	<b>0.002</b>	<b>0.008</b>
kg/t TiO <sub>2</sub> (max)	0.005	0.016
kg/t TiO <sub>2</sub> (min)	0.000	0.000
Collection period	1999	1999
Number of data (average)	91750	4000
Typical volume based value	Dust	NO <sub>x</sub>
<b>mg/Nm<sup>3</sup> (average)</b>	<b>18</b>	<b>54</b>

Table 3.18: Dust and NO<sub>x</sub> emissions – TiO<sub>2</sub> production, the chloride process [20, CEFIC-TDMA, 2004]

NO<sub>x</sub> is emitted in the exhaust gas of the heater when there is a need to dry the feedstock. One site dries the recovered ore and coke.

### 3.2.3.4.2 Chlorination

Emissions to air from the chlorination stage are given in Table 3.19 below.

Emissions to air							
Emitted substance	Cl <sub>2</sub>	CO	COS	CO <sub>2</sub>	SO <sub>2</sub>	NO <sub>x</sub>	HCl
Treatment method	Oxidiser followed by water, acid or lime scrubbing						
<b>kg/t TiO<sub>2</sub> (average)</b>	<b>0.003</b>	<b>159</b>	<b>2.39</b>	<b>923</b>	<b>1.14</b>	<b>0.10</b>	<b>0.10</b>
kg/t TiO <sub>2</sub> (max)	0.008	297	3.99	1790	4.00	0.12	0.16
kg/t TiO <sub>2</sub> (min)	0.000	0	0.00	56	0.01	0.07	0.05
Collection period	1999	1999	1999	1999	1999	1999	1999
No of data (average)	18	15	8	11	11	11	192
Typical volume based value	Cl <sub>2</sub>	CO	COS	CO <sub>2</sub>	SO <sub>2</sub>	NO <sub>x</sub>	HCl
<b>mg/Nm<sup>3</sup> (average)</b>	<b>1</b>	<b>1570</b>	<b>21</b>	<b>49344</b>	<b>286</b>	<b>51</b>	<b>35</b>

**Table 3.19: Emissions to air from chlorination – TiO<sub>2</sub> production, the chloride process [20, CEFIC-TDMA, 2004]**

Chlorine emissions are rare and are controlled by water or caustic scrubbing, usually in packed spray towers, for maximum efficiency. Small quantities of HCl remain in the off-gas. All sites now have thermal oxidisers for burning CO and COS.

Heat generated at the oxidiser stage is recovered to raise steam. The data also reflect the commissioning and start up of some units in the year of measurement (1999). Natural gas is used for burning COS and CO, which results in emissions of NO<sub>x</sub>, CO<sub>2</sub> and SO<sub>2</sub> [20, CEFIC-TDMA, 2004].

It should also be noted, in particular as far as SO<sub>2</sub> emissions are concerned, that the 1999 data given above in Table 3.19 were representative for a sulphur content of 0.8 – 1.0 % in the input pet coke used in the process [20, CEFIC-TDMA, 2004]. In turn, it is reported that in 2005 it is possible only to buy coke with a sulphur content of 1.0 to 1.8 %, which results in higher SO<sub>2</sub> emissions from the process [85, EIPPCB, 2004-2005].

### 3.2.3.4.3 Solids separation

Emitted substance	HCl
Treatment method	Acid scrubbing
<b>kg/t TiO<sub>2</sub> (average)</b>	<b>0.0037</b>
kg/t TiO <sub>2</sub> (max.)	0.0070
kg/t TiO <sub>2</sub> (min.)	0.0003
Collection period	1999
No of data (average)	2

**Table 3.20: Data on hydrogen chloride emissions**

Data on hydrogen chloride emissions given in Table 3.20 are from one site – no volume based data available.

## 3.2.3.4.4 Waste solid metal chlorides treatment

Emissions to air			
Emitted substance	NO <sub>x</sub>	HCl	Dust
Treated method	Combustion	scrubber	None
<b>kg/t TiO<sub>2</sub> (average)</b>	<b>1.40</b>	<b>0.6</b>	<b>0.5</b>
Collection period	1999	1999	1999
No of data (average)	4	Continuous	4

Table 3.21: Emissions to air from waste solid metal chlorides treatment

As seen in Table 3.21, the emissions are all from the site that treats its metal chlorides in a coal fired fluid bed, where the exit gases are quenched and scrubbed. No volume based values are available.

## 3.2.3.4.5 Condensation

No gaseous emissions are allocated to condensation but it is likely that some residual HCl originates from here.

## 3.2.3.4.6 Waste gas treatment

See Section 3.2.3.4.9 below – Abatement systems for gases.

## 3.2.3.4.7 Oxidation

All sites use either gas or steam to preheat the tetrachloride feed to oxidation. The emission data from one site are given in Table 3.22.

Emissions to air	
Emitted substance	SO <sub>2</sub>
Treatment method	None
<b>kg/t TiO<sub>2</sub> (average)</b>	<b>0.14</b>
Collection period	1999
No of data (average)	6
Typical volume based value	SO <sub>2</sub>
<b>mg/Nm<sup>3</sup> (average)</b>	<b>2</b>

Table 3.22: Emissions to air from oxidation

## 3.2.3.4.8 Finishing

Dust is the main emission of concern and invariably strict control measures are in place to keep them to a minimum. This is as much an occupational hygiene issue as an environmental one. Dust and NO<sub>x</sub> emissions from the finishing section are given in Table 3.23.

Emissions to air		
Emitted substance	Dust	NO <sub>x</sub>
Treatment method	Bag filters	
<b>kg/t TiO<sub>2</sub> (average)</b>	<b>0.158</b>	<b>0.020</b>
kg/t TiO <sub>2</sub> (max.)	0.400	0.020
kg/t TiO <sub>2</sub> (min.)	0.002	0.020
Collection period	1999	1999
No of data (average)	7	4
No of data (max.)	18	4
No of data (min.)	1	4
Typical volume based value	Dust	NO <sub>x</sub>
<b>mg/Nm<sup>3</sup> (average)</b>	<b>21</b>	

**Table 3.23: Dust and NO<sub>x</sub> emissions, finishing section – TiO<sub>2</sub> production, the chloride process [20, CEFIC-TDMA, 2004]**

### 3.2.3.4.9 Abatement systems for gases

In principle, there are two abatement systems used. Both use scrubbing trains, the difference is the liquid medium one uses caustic soda and produces hypochlorite as a co-product. The other uses water and produces hydrochloric acid for sale or re-use. The choice of which system is preferred, depends on the local market for co-products.

### 3.2.3.5 Emissions to water

#### 3.2.3.5.1 Waste solid metal chlorides treatment

Emissions of metals to water are presented in Table 3.24.

Emissions to water				
Treatment method	Neutralisation as required			
Emitted substance	Fe	Hg	Cd	Other metals*
Collection period	1999	1999	1999	1999
No. of data (average)	75	130	156	209
No. of data (max)	183	365	365	365
No. of data (min)	12	52	52	52
<b>kg/t TiO<sub>2</sub> (average)</b>	<b>2.3</b>	<b>8.56 E<sup>-06</sup></b>	<b>5.76 E<sup>-05</sup></b>	<b>1.334</b>
kg/t TiO <sub>2</sub> max	8.8	2.00 E <sup>-05</sup>	1.80 E <sup>-04</sup>	2.000
kg/t TiO <sub>2</sub> min	0.0001	1.60 E <sup>-08</sup>	8.00 E <sup>-08</sup>	0.003
Typical volume based concentrations	Fe	Hg	Cd	Other metals*
<b>mg/litre</b>	<b>0.56</b>	<b>0.0002</b>	<b>0.0012</b>	<b>32.6</b>
Note: Data from the German TiO <sub>2</sub> plant, based on the chloride process, are broadly consistent with the above-mentioned data, as the emission of waste solid metal chlorides after neutralisation are reported to be as follows: Fe – 0.011 kg/t TiO <sub>2</sub> ; Hg – 2.2 E <sup>-07</sup> kg/t TiO <sub>2</sub> ; Cd – 2.2 E <sup>-07</sup> kg/t TiO <sub>2</sub> ; Other metals – 0.0025 kg/t TiO <sub>2</sub> .				
* Other metals: Manganese (Mn), Vanadium (V), Titanium (Ti), Zinc (Zn), Chromium (Cr), Lead (Pb), Nickel (Ni), Copper (Cu), Arsenic (As). It should be noted that in the group of other metals, Ti and Mn are much less harmful for the environment than the remaining metals listed above. The emission level of the remaining metals (V, Zn, Cr, Pb, Ni, Cu, As) is estimated at <0.1 kg/t TiO <sub>2</sub> pigment [85, EIPPCB, 2004-2005].				

**Table 3.24: Emissions of metals to water – TiO<sub>2</sub> production by the chloride route [20, CEFIC-TDMA, 2004], [42, UBA-Germany, 2001]**

### 3.2.3.5.2 Condensation and gas scrubbing

Emissions of hydrochloric acid and suspended solids to water is given in Table 3.25.

Emissions to water		
Treatment method	Lagoon	
Emitted substance	HCl	Suspended solids
Collection period	1999	1999
No of data (average)	365	365
<b>kg/t TiO<sub>2</sub> (average)</b>	<b>16</b>	<b>0.36</b>

**Table 3.25: Emissions of hydrochloric acid and suspended solids to water**

This is information from one site only and it should be noted that the HCl figure is relatively high and modifications are already in hand to reduce it. No volume-based concentrations are available.

### 3.2.3.5.3 Finishing

Emissions of suspended solids and chlorides to water are given in Table 3.26.

Suspended solids (which basically are inert titanium dioxide particles and, on some sites, solids from imported river or seawater) are the only significant aqueous emission attributed to this section, however for editing convenience, chloride ion values for the liquid effluent are also included here. It can be noted that a certain quantity of soluble sulphate ions are released from the finishing section which come from the coating process in the form of sodium sulphate.

Emissions to water		
Treatment method	Filtration, settling	
Emitted substance	Suspended solids	Chlorides
Collection period	1999	
No. of data (average)	98	
No. of data (max)	183	
No. of data (min)	12	
<b>kg/t TiO<sub>2</sub> (average)</b>	<b>4.64</b>	<b>164</b>
kg/t TiO <sub>2</sub> max	11.10	330
kg/t TiO <sub>2</sub> min	0.57	38
<b>Typical volume based concentration</b>	<b>Suspended solids</b>	<b>Chlorides</b>
<b>mg/litre</b>	<b>5.23</b>	<b>185</b>

**Table 3.26: Emissions of suspended solids and chlorides to water – TiO<sub>2</sub> chloride process [20, CEFIC-TDMA, 2004]**

It should be also noted that, as compared to the range of emissions of chlorides to water, i.e. 38 to 330 kg/t TiO<sub>2</sub> pigment characteristic for the chloride process route as given in Table 3.13 above, the TiO<sub>2</sub> Harmonisation Directive 92/112/EEC limits emissions of chlorides to water depending on the titanium feedstock used, namely:

- 130 kg chlorides/t TiO<sub>2</sub> pigment for natural rutile as raw material
- 228 kg chlorides/t TiO<sub>2</sub> pigment for synthetic rutile
- 450 kg chlorides/t TiO<sub>2</sub> pigment for slag used as raw material in the production process.

### 3.2.3.5.4 Abatement systems for gases

There are no direct emissions from this section, however, it should be noted that aqueous emissions from gas scrubbers at the sites form part of liquid effluent stream.

### 3.2.3.5.5 Abatement systems for liquids

The liquids concerned are hydrochloric acid or caustic soda solution. It can be seen from the above that most processes are designed so that the emission of these substances to the aqueous environment is minimised.

### 3.2.3.6 Solid wastes

#### 3.2.3.6.1 Chlorination

Waste to land	
Emitted substance	Inerts (solids)
kg/t TiO <sub>2</sub> (average)	224

Table 3.27: Waste sent to landfill from the chlorination unit

Table 3.27 reflects one site where the blow-over from the chlorination section is sent to landfill. Some recovery of waste is expected for 2000.

#### 3.2.3.6.2 Waste solid metal chlorides treatment

Waste to land	
Treatment method	Neutralisation or roasting
Emitted substance	Solids
kg/t TiO <sub>2</sub> (average)	397
kg/t TiO <sub>2</sub> max	660
kg/t TiO <sub>2</sub> min	99

Table 3.28: Emission levels of solids from metal chlorides treatment by neutralisation or roasting

Table 3.28 gives the emission levels of solids from metal chlorides treatment by neutralisation or roasting. Lime is usually used to render the heavy metals insoluble so the material is suitable for disposal to land. Some sites separate unreacted coke for sale or re-use, others extract the iron component as ferrous chloride for sale.

#### 3.2.3.6.3 Distillation and vanadium oxychloride removal

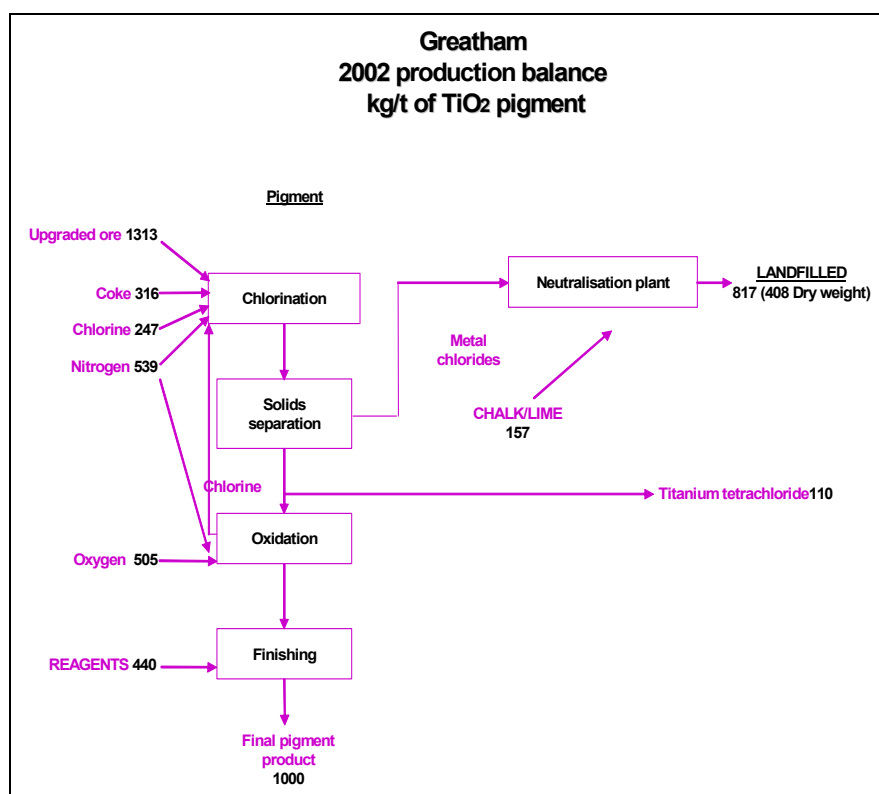
Although this section technically produces solids for disposal, the material is internally transferred and it is combined with waste from solid metal chloride treatment – see Section 3.2.3.6.2.

### 3.2.3.7 Environmental performance – Greatham Works 2002

The purpose of this case study is to help bridge the gap after 1999 when the original performance data was collected. Year 2002 saw the closure of the older Black End plant in August and the start-up of the new ICON 2 (ICON = Integrated Chlorination and Oxidation) titanium dioxide plant in October. Since the closure of the Black End plant, considerable progress has been made on the inventory of hazardous chemicals and work has commenced on demolition.

Figure 3.3 gives the overall production balance for 2002 in Greatham, illustrating major inputs and outputs from the titanium dioxide production process based on the chloride process route.





**Figure 3.3: Main raw materials inputs and production outputs for the Greatham site for 2002 [20, CEFIC-TDMA, 2004]**

Most emissions to air and water showed a reduction compared to 2001. This is partially explained by a small reduction in production from the site due to the change-over from the Black End to ICON 2.

Hazardous waste disposal shows a significant increase, however, most of this is material removed from the (shut-down) Greatham Black End as part of the decontamination/demolition programme.

Improvements achieved in 2002:

- total neutralisation plant – all acidic liquid effluent from the site is now treated before discharge, to neutralise residual acid
- ozone depleting substances – the black End refrigeration plant was decommissioned and the refrigerant was removed.

Detailed annual emissions 1999 – 2002 in kg per tonne of TiO<sub>2</sub>, recorded in the Greatham Works titanium dioxide plant based on the chloride process are given in Table 3.29.

	kg/tonne 1999	kg/tonne 2000	kg/tonne 2001	kg/tonne 2002
<b>Discharges to water</b>				
Hydrochloric acid	16	13	13	12
Titanium (Ti)	0.8	0.6	0.5	0.6
Suspended solids	0.6	0.5	0.4	0.5
Manganese (Mn)	0.6	0.6	0.4	0.5
Iron (Fe)	0.28	0.55	0.67	0.61
Vanadium (V)	0.03	0.03	0.03	0.02
Chromium (Cr)	0.003	0.004	0.004	0.002
Zinc (Zn)	0.006	0.007	0.009	0.005
Nickel (Ni)	0.019	0.015	0.004	0.001
Lead (Pb)	0.011	0.009	0.002	0.000
Copper (Cu)	0.003	0.003	0.006	0.001
Arsenic (As)	0.0001	0.0001	0.0001	0.0000
Cadmium (Cd)	0.00018	0.00013	0.00012	0.00001
Mercury (Hg)	0.00007	0.00001	0.00000	0.00000
Chlorinated organic compounds	0.00041	0.00027	0.00025	0.00025
<b>Emissions to air</b>				
Carbon monoxide	181	116	65	83
Carbonyl sulphide	3.2	1.9	1.3	0.4
Nitrogen oxides (as NO <sub>2</sub> )	1.2	1.3	1.2	1.2
Particulates	0.4	0.1	0.1	0.1
Sulphur dioxide	0.3	0.2	0.1	0.1
Hydrogen chloride	0.2	0.0	0.0	0.0
Chlorine	0.00041	0.00054	0.00050	0.00012
Hydrogen sulphide	0.1	0.1	0.0	0.0
Carbon dioxide (ex process)	437	487	729	576
Carbon dioxide (ex combustion)	1304	1090	1110	989
Carbon dioxide (from bought in energy)	609	588	561	540
<b>Wastes to land</b>				
Non-hazardous waste	729	785	881	962
Hazardous waste to land/incineration	0.5	1.8	0.9	1.8
<b>Resource consumption</b>				
Water usage m <sup>3</sup>	38	32	31	32
Energy usage GJ	29	26	26	23

**Table 3.29: Emissions 1999 – 2002 in the Greatham Works TiO<sub>2</sub> plant, the chloride process [20, CEFIC-TDMA, 2004]**

### 3.2.4 Techniques to consider in the determination of BAT – the chloride process

This section sets out techniques considered generally to have potential for achieving a high level of environmental protection in the industries within the scope of this document. Management systems, process-integrated techniques and end-of-pipe measures are included, but a certain amount of overlap exists between these three when seeking the optimum results.

Prevention, control, minimisation and recycling procedures are considered as well as the re-use of materials and energy.

Techniques may be presented singly or as combinations to achieve the objectives of IPPC. Annex IV to the Directive lists a number of general considerations to be taken into account when determining BAT and techniques within this section will address one or more of these considerations. As far as possible a standard structure is used to outline each technique, to enable comparison of techniques and an objective assessment against the definition of BAT given in the Directive.

The content of this section is not an exhaustive list of techniques and others may exist or be developed which may be equally valid within the framework of BAT. Generally a standard structure is used to outline each technique, as shown in Table 3.30:

Type of information considered	Type of information included
Description	Technical description of the technique
Achieved environmental benefits	Main environmental impact(s) to be addressed by the technique (process or abatement), including emission values achieved and efficiency performance. Environmental benefits of the technique in comparison with others
Cross-media effects	Any side-effects and disadvantages caused by implementation of the technique. Details on the environmental problems of the technique in comparison with others
Operational data	Performance data on emissions/wastes and consumption (raw materials, water and energy). Any other useful information on how to operate, maintain and control the technique, including safety aspects, operability constraints of the technique, output quality, etc.
Applicability	Consideration of the factors involved in applying and retrofitting the technique (e.g. space availability, process specific)
Economics	Information on costs (investment and operation) and any possible savings (e.g. reduced raw material consumption, waste charges) also as related to the capacity of the technique
Driving force for implementation	Reasons for implementation of the technique (e.g. other legislation, improvement in production quality)
Example plants	Reference to a plant where the technique is reported to be used
Reference literature	Literature for more detailed information on the technique

**Table 3.30: Information breakdown for each technique described in this section**

Reference is also made here to Section 8.9, providing key information on the Environmental Management System (EMS) which is a tool for IPPC installations that operators can use to address the design, construction, maintenance, operation and decommissioning issues in a systematic demonstrable way.

Techniques broadly applicable in the chemical industry, described in the BREF on Common Waste Water and Waste gas Treatment/Management Systems in the Chemical Sector, are not included in this section (refer to the BREF on CWW).

### 3.2.4.1 Raw material import and preparation

#### 3.2.4.1.1 Dry titanium dioxide ore

##### Description

The ore needs to be in a dry state and with a low moisture content prior to processing. Ensuring that the ore is delivered to the site in a dry state may require collaboration with upstream suppliers and those who transport and handle the ore. Covered storage prevents wetting of the ore by rain. Drying of the ore (typically synthetic rutile) is not normally required in the European titanium dioxide plants based on the chloride process route, but, if required, would entail the use of energy with associated emissions of combustion products. Low moisture content in the ore reduces chlorine losses in the downstream chlorination section due to the undesirable formation of the HCl and results in a higher yield of titanium ore to titanium tetrachloride.

##### Achieved environmental benefits

The higher the yield of the TiO<sub>2</sub> ore to TiCl<sub>4</sub>, the lower the overall impact of titanium dioxide production on the environment.

##### Cross-media effects

Increased amounts of dust may be expected when the titaniferous ore is handled in a dry state, however, this is restricted by enclosed handling and storage – refer also to Section 3.2.4.1.2.

##### Operational data

No information submitted on the acceptable levels of moisture content in the titaniferous ores used for the production of TiO<sub>2</sub> based on the chloride process. Although there is no clear equivalence between the chloride and sulphate processes, and there are quite different reasons for keeping the titanium ore dry prior to its further processing, reference is made here to the information source on the sulphate process [42, UBA-Germany, 2001], quoting that the required moisture content in the ore prior to processing is below 0.1 %.

##### Applicability

Applicable to all plants using the chloride process route.

##### Economics

No data submitted.

##### Driving force for implementation

Higher performance of the whole process due to the avoided chlorine losses in the chlorination section and, hence, the higher yield of titanium ore in the process. Additionally, reduced or eliminated emissions from drying the ore.

##### Example plants

Titanium dioxide plant in Greatham, UK.

##### Reference literature

[20, CEFIC-TDMA, 2004], [42, UBA-Germany, 2001], [26, EIPPCB, 2003].

#### 3.2.4.1.2 TiO<sub>2</sub> ore dedusting systems

##### Description

The main issue in feedstock preparation on the site of a titanium dioxide plant is dust emission during the movement of dry bulky materials. Normally this is controlled by handling the ore in closed systems kept under reduced pressure with the dust being collected in cyclones for re-use. Cyclones are more robust depending on their proper design. The cyclones may be followed by reverse pulse bag micro-filters, which are likely to minimise dust emissions, provided they are supported by an efficient monitoring and maintenance regime. High quality maintenance routines are necessary to minimise dust emissions from worn or badly fitted filter socks. Continuous dust measurement systems are an obvious aid to minimising feedstock losses.

### Achieved environmental benefits

Minimisation of TiO<sub>2</sub> ore dust emissions in the raw materials preparation section.

### Cross-media effects

No side effects or disadvantages caused by implementation of this technique are reported.

### Operational data

As presented in Section 3.2.3.4.1 and, in particular, in Table 3.18. Average specific emissions of dust to air are at the level of 0.002 kg/t TiO<sub>2</sub>, the maximum emission of dust to air being reported at the level of 0.005 kg/t TiO<sub>2</sub> produced.

### Applicability

Applicable to all plants using the chloride process route.

### Economics

No data submitted.

### Driving force for implementation

Standard requirements of dust emissions to air.

### Example plants

Titanium dioxide plant in Greatham, UK.

### Reference literature

[20, CEFIC-TDMA, 2004], [42, UBA-Germany, 2001], [26, EIPPCB, 2003].

### **3.2.4.1.3 Low sulphur content in feedstock granular coke**

#### Description

Low sulphur coke is required in a granular form suitable for fluidisation in the chlorination process. The sulphur content of the coke influences the COS concentration and subsequently the SO<sub>2</sub> concentration in the off-gas from the thermal oxidisers. However, the availability of low sulphur coke is limited, as the average sulphur content in the coke was reported to have increased from 0.8 – 1.2 % in 1999 to 1.0 – 1.8 % in 2005.

#### Achieved environmental benefits

Reduced emissions of SO<sub>2</sub> from the TiO<sub>2</sub> plant.

#### Cross-media effects

No side effects or disadvantages caused by implementation of this technique are expected to be encountered in the titanium dioxide industry.

#### Operational data

Refer to data included in Sections 3.2.2.14 and 3.2.3.4.2. Specific emissions of SO<sub>2</sub> to air are in the range of 0.01 to 4.00 kg/t TiO<sub>2</sub>.

#### Applicability

Technique applicable to all plants using the chloride process route.

#### Economics

No information submitted.

#### Driving force for implementation

Standard requirements of COS and SO<sub>2</sub> emissions to air.

#### Example plants

Titanium dioxide plant in Greatham, UK.

Reference literature

[20, CEFIC-TDMA, 2004], [42, UBA-Germany, 2001], [26, EIPPCB, 2003], [85, EIPPCB, 2004-2005].

**3.2.4.1.4 Low chlorine inventory**Description

Chlorine is recycled within the process, with any 'make up' chlorine usually being imported by tanker as a liquid. Afterwards, chlorine is delivered to the chlorine storage in the TiO<sub>2</sub> plant either by a rail pipeline or by road, depending on the site location. For the storage and the handling of chlorine, refer to the BREF on the Chlor-Alkali Manufacturing Industry.

The hazardous nature of chlorine is the main property, which influences the basic design of the titanium dioxide chloride process. This means that the initial primary stages of the process (the 'black end') are totally enclosed and of high integrity. In Europe, all TiO<sub>2</sub> plants based on the chloride process route are controlled by both the Seveso II Directive [23, The Council of the EU, 1996] and by the Titanium Dioxide Harmonisation Directive [21, The Council of the EU, 1992], which require detailed hazard assessments to be carried out and minimal emissions of chlorine into the environment.

Good production and maintenance planning, together with a proper relationship with the chlorine suppliers, is required to maintain a low chlorine inventory. A minimum chlorine inventory is an obvious goal in order to minimise potential harm in the event of a major chlorine release.

Achieved environmental benefits

In the case of any accidental release of chlorine from storage, a lower inventory will result in a lower impact on the environment as a result of the release.

Cross-media effects

A minimum chlorine inventory involves more frequent handling operations of liquid chlorine transport from the chlorine supplier and liquid chlorine loading into chlorine storage in the TiO<sub>2</sub> plant, which may potentially result in uncontrolled local emissions of chlorine gas (leaking valves, flanges, gaskets, etc.).

Excellent co-operation between the liquid chlorine supplier and the TiO<sub>2</sub> producer is required to maintain a minimum stock on site.

Operational data

No information submitted.

Applicability

Applicable to all plants using the chloride process route.

Economics

No data provided.

Driving force for implementation

The maximum degree of safety both of the operator's staff and of the human beings living in the proximity of the TiO<sub>2</sub> plant based on the chloride process route.

Example plants

Titanium dioxide plant in Greatham, UK.

Titanium dioxide plant in Stallingborough, UK.

Titanium dioxide plant in Langebrugge, Belgium.

Titanium dioxide plant in Leverkusen, Germany (the chloride process route).

Titanium dioxide plant in Rotterdam, the Netherlands.

### Reference literature

[20, CEFIC-TDMA, 2004], [6, CEFIC, 2002], [26, EIPPCB, 2003], [70, Environment Agency, 1999], [12, European Environment Agency, 2004], [75, J. A. Lee, 1985], [21, The Council of the EU, 1992], [23, The Council of the EU, 1996], [11, The Council of the EU, 1996], [42, UBA-Germany, 2001], [78, World Bank, 1991].

Refer also to the BREFs on:

- CAK (Chlor-Alkali Manufacturing Industry)
- MON (General Principles of Monitoring)
- ESB (Emissions from Storage)
- CV (Industrial Cooling Systems)
- CWW (Common Waste Water and Waste gas Treatment/Management Systems in the Chemical Sector).

### **3.2.4.2 Chlorination**

#### Description

Steady state operation of a fluidised-bed reactor to sustain a good temperature and composition control to avoid chlorine slip and downtime from sintered beds is the best measure to minimise environmental impacts from chlorination. In modern titanium dioxide plants based on the chloride process, this section uses a pressurised chlorinator fed directly with recycled chlorine at an optimum fluidisation velocity. Modern plants have been redesigned with rapid maintenance in mind to minimise unplanned downtime. This, combined with modern low volume systems, helps to minimise losses. Chlorinators should be designed for ease of maintenance to maximise overall process efficiency.

#### Achieved environmental benefits

Steady state operation of the chlorination section allows for:

- maximising chlorine utilisation in the chlorine recovery loop and a higher chlorine yield to titanium tetrachloride in one reaction pass, thus increasing overall plant efficiency and reducing the impact on the environment
- keeping a fluidised-bed reactor in operation for an extended time, thus minimising the number of stoppages required to replace the reactor bed, and reducing the impact on the environment.

#### Cross-media effects

Intermittent purge of solids from the reactor (mainly unchlorinated particles of the ore and coke). Normally, the re-use of unchlorinated particles is problematic because of the fine particle size and impurity contamination.

#### Operational data

All raw materials, including coke, should be dry and free from volatile substances, in order to avoid chlorine losses by the formation of HCl. The chlorine conversion rate is approx. 98 - 100 %, while the TiO<sub>2</sub> content in the raw material is converted to a rate of approx. 90 - 100 %. The chlorination temperature is approximately 1000 °C, in which most of the generated metal chlorides are gaseous, with the exception of Mg and Ca chlorides. Therefore, the raw materials should not exceed certain limit values of Mg and Ca, in order to avoid their sticking in the fluidised bed. The chlorination reactors may require total bed replacement about once a year. The gases leaving the chlorinator contain Cl<sub>2</sub>, CO, COS, and HCl. The train for waste gas treatment contains multistage washing, combustion and, sometimes, desulphurisation [42, UBA-Germany, 2001], refer to Section 3.2.4.5.

All sites have thermal oxidisers for burning CO and COS, sometimes with the heat recovered to raise steam. Heat recovery as steam has an obvious environmental advantage but periodic descaling of the boiler tubes causes the abatement unit to be out of action for 10 – 15 % of the plant operational time.

Natural gas is used for burning COS and CO, which results in the emissions of CO<sub>2</sub>, SO<sub>2</sub>, and NO<sub>x</sub>. For more detailed information on the chlorination process, as well as on emissions to air and wastes to land from the chlorination stage, refer to Sections 3.2.2.2, 3.2.3.2.1, 3.2.3.4.2, and 3.2.3.6.1.

#### Applicability

Steady state operation of the chlorination section, equipped with modern fluidised-bed reactors, are applicable to all plants using the chloride process route.

#### Economics

No information submitted.

#### Driving force for implementation

The overall process efficiency increases, leading to the reduction of TiO<sub>2</sub> manufacturing costs, and lessening the impact of TiO<sub>2</sub> production on the environment.

#### Example plants

Titanium dioxide plant in Greatham, UK.  
Titanium dioxide plant in Stallingborough, UK.  
Titanium dioxide plant in Langebrugge, Belgium.  
Titanium dioxide plant in Leverkusen, Germany (the chloride process route).  
Titanium dioxide plant in Rotterdam, the Netherlands.

#### Reference literature

[20, CEFIC-TDMA, 2004], [42, UBA-Germany, 2001], [26, EIPPCB, 2003], [48, W. Buchner et al, 1989].

### **3.2.4.3 Solids separation – coke and ferrous chloride recovery**

#### Description

Fine solids of residual TiO<sub>2</sub>, SiO<sub>2</sub>, and coke as well as gaseous metal chlorides are discharged from the reactor together with the TiCl<sub>4</sub> and the residual reaction gases. These are cooled by the addition of cold TiCl<sub>4</sub>, upon which the main part of other metal chlorides condenses and can be separated together with the solids present in the main gas stream of the reactor. Recovery of unreacted ore and coke may be a potential option for systems with a high carryover of these materials in the gas stream.

Deeper analysis of the environmental impact and a cost-benefit assessment would be necessary to ensure, on balance, that the recovery of unreacted ore and coke is justified. Typically, at this stage of the process, coke and ferrous chloride solution are separated, which can then be sold as a by-product, provided a local market can be developed (refer also to Section 7.4).

#### Achieved environmental benefits

Separation of residual coke and ferrous chloride that would otherwise be the waste solid materials directed to a landfill and for waste water treatment.

#### Cross-media effects

Additional energy requirements and the consumption of hydrochloric acid (refer to Section 7.4).

#### Operational data

As described in Section 7.4, the recovery of 942 kg of 20 % FeCl<sub>2</sub> solution per tonne of TiO<sub>2</sub> produced has been reported. No data on the degree of coke recovery was submitted.



### Applicability

In principle, this technique is applicable to all plants using the chloride process route.

### Economics

No information submitted.

### Driving force for implementation

Reduction of waste materials directed to a landfill and for the waste water treatment.

### Example plants

Titanium dioxide plant in Leverkusen, Germany.

### Reference literature

[20, CEFIC-TDMA, 2004], [42, UBA-Germany, 2001], [90, CEFIC-INCOPIA, 2004].

## **3.2.4.4 Waste solid metal chlorides neutralisation with chalk or lime**

### Description

After the optional treatment of solids and metal chlorides to recover both coke and  $\text{FeCl}_2$  from the waste stream, solid metal chlorides are usually neutralised in a chalk or lime slurry which renders the residual metals insoluble. The metals are precipitated and stabilised, and the filter cake is landfilled, while the filtrate is discharged to the appropriate aqueous environment.

Where the neutralised metal chlorides are disposed of to landfill, tight pH control of neutralisation and leachate checks from the landfill site are necessary to guarantee the waste metal ions are stabilised and do not contaminate the water table.

The off-gas from the treatment of solid metal chlorides is cleaned in a scrubber before being discharged to the atmosphere (refer to Section 3.2.3.4.3). The acid wash-water from the scrubber is recycled to the main section for the treatment of solid metal chlorides.

### Achieved environmental benefits

The neutralisation of solid metal chlorides with chalk or lime renders the residual metals insoluble, before their disposal as a solid waste to landfill. It should be noted, that it is necessary to use high purity chalk or lime.

### Cross-media effects

Additional lime usage in the range of 91 to 220 kg/t  $\text{TiO}_2$ .

### Operational data

In Sections 3.2.3.5.1 and 3.2.3.6.2, as well as in Table 3.29, specific emission figures from one site in Germany (Leverkusen) are reported.

It should be noted, that solid emissions also depend on the abatement system for liquids used in the titanium dioxide plants based on the chloride process route. Relevant data on waste to land are also included in Section 3.2.4.10.3.

### Applicability

Applicable to all plants using the chloride process route.

### Economics

No data submitted.

### Driving force for implementation

The metal ions are stabilised and when landfilled they do not contaminate the water table.

### Example plants

Titanium dioxide plant in Greatham, UK.

Titanium dioxide plant in Leverkusen, Germany.

Reference literature

[20, CEFIC-TDMA, 2004], [42, UBA-Germany, 2001], [26, EIPPCB, 2003].

**3.2.4.5 TiCl<sub>4</sub> condensation and waste gas treatment**Description

In this step the majority of the titanium tetrachloride is separated from the gas stream by multistage cooling/condensation to temperatures below 0 °C. Carefully designed high efficiency condensers are used at this stage. Depending on the process conditions, the CFC-free cooling system usually uses ammonia or brine.

The gas stream – containing traces of TiCl<sub>4</sub>, CO, CO<sub>2</sub>, COS, HCl, and Cl<sub>2</sub> – is then passed to the multistage waste gas treatment unit, in which several consecutive operations are performed to remove (Cl<sub>2</sub>) and utilise chlorine compounds (HCl, NaClO), to desulphurise off-gas (COS) to possibly extract sulphur, and finally, to thermally convert CO (and COS) contained in the off-gas to CO<sub>2</sub>, before the off-gas is released to the atmosphere.

In principle, there are two abatement systems used. Both use scrubbing trains, the difference is the liquid medium one uses caustic soda and produces sodium hypochlorite as a co-product. The other uses water and produces hydrochloric acid for sale or re-use.

Specific configurations of the multistage waste gas treatment unit used in the titanium dioxide industry based on the chloride process route are:

- absorption of chlorine compounds, yielding 28 % HCl, which is sold, followed by a thermal combustion of CO and COS in the off-gas, and then a final scrubbing of the off-gas with the solution of caustic soda
- the acid scrubber is followed by a thermal converter. No hydrochloric acid is sold. Sodium hypochlorite is produced at the site
- the acid scrubber is followed by a caustic scrubber or thermal converter depending on the location. Hydrochloric acid is sold as a co-product. Sulphur is removed from the thermal converter stream for sale. No sodium hypochlorite is produced.

Thermal converters or oxidisers are used to render the carbon monoxide and carbonyl sulphide (COS) in the tail-gas harmless. There are two similar systems. In one, the gases are converted to carbon dioxide and sulphur dioxide (the latter is scrubbed with an alkali). In the other, the end-products are carbon dioxide and sulphur. Thermal oxidisers need careful design and operation because it is critical to avoid acid corrosion (particularly triggered by the over-cooling of the off-gas, and therefore, its condensation and subsequent hydrochloric acid formation).

There are a number of different scrubbing systems, which can be taken into consideration. Their efficacy is dependent on local circumstances, the availability of markets and the internal usage of co-products.

Achieved environmental benefits

The main chemically active constituents contained in the off-gas (TiCl<sub>4</sub>, Cl<sub>2</sub>, CO, and COS) are either absorbed (to form HCl or NaOCl, which are utilised locally or neutralised) or converted to other compounds, such as sulphur (which can be sold) and CO<sub>2</sub> (which is then released to the atmosphere in the main stream of off-gas).

Cross-media effects

Fuel is consumed to keep the oxidiser online during production.

Operational data

The information from one site, relating to emissions of hydrochloric acid and suspended solids to water from the condensation and waste gas scrubbing unit, is given in Section 3.2.3.5.2.

In turn, data relating to varied abatement systems for gases used in the chloride process are given in Table 3.31.

Emissions kg/t	CO incinerator No alkali scrubber	CO incinerator + alkali scrubber	CO incinerator + sulphur recovery
HCl	0.2	0.1	0.05
Cl <sub>2</sub>	0.003	0.003	0.003
COS*	0.2	0.2	<<0.003
CO	0.2	0.2	<<1
SO <sub>2</sub>	4	0.5	1.8
<b>Costs: EUR/t</b>			
Capital +/-30 %	50	150	140
Treatment	5	20	16
* Based on continuous operation of the plant			
<b>Sites</b>	Rotterdam (NL)	Stalingborough Greatham (UK)	Langebrugge Leverkusen (DE)

**Table 3.31: Abatement systems for gases – TiO<sub>2</sub> production by the chloride process [20, CEFIC-TDMA, 2004]**

A thermal oxidiser is maintained online whenever production units are operational. Techniques used in scrubbing systems will be dependent upon the local design. Markets for co-products should be established as firmly as possible to ensure their manufacture is worthwhile.

Specific emission figures from one site in Germany (Leverkusen) have been reported [42, UBA-Germany, 2001].

#### Applicability

Applicable to all plants producing TiO<sub>2</sub> by the chloride process route.

#### Economics

Refer to Table 3.31 above.

#### Driving force for implementation

Minimisation of gaseous emissions from TiO<sub>2</sub> production based on the chloride process.

#### Example plants

The three European plants of TiO<sub>2</sub> production by the chloride process route mentioned in Table 3.31 above.

#### Reference literature

[20, CEFIC-TDMA, 2004], [42, UBA-Germany, 2001], [70, Environment Agency, 1999], [26, EIPPCB, 2003], [21, The Council of the EU, 1992].

### **3.2.4.6 Purification of raw TiCl<sub>4</sub> and vanadium oxychloride removal**

#### Description

The liquid raw titanium tetrachloride, separated by condensation, is fed into a distillation unit, where it is put into contact with a reducing agent (oil), in order to convert impurities, such as vanadium oxychloride, to lower valency state compounds, remove them by precipitation and, subsequently, treat them with other waste solid metal chlorides.

In particular, vanadium must be almost completely removed, as even small traces of it in the intermediate purified TiCl<sub>4</sub> would finally lead to a yellow colouring of the TiO<sub>2</sub> pigments.

Complexing vanadium oxychloride with oil within the distillation column appears to be the only available option known [20, CEFIC-TDMA, 2004]. Careful selection of the oil is necessary to prevent choking and to minimise the formation of chlorinated hydrocarbons.

A high efficiency specifically designed distillation column is required.

#### Achieved environmental benefits

Indirect environmental benefits result from the application of this technique, as it is one of key unit operations used in the TiO<sub>2</sub> chloride process, determining the process performance upstream and downstream (as well as the TiO<sub>2</sub> product quality).

Without steady operation of this unit operation, efficient operation of the whole plant would not be achieved.

#### Cross-media effects

Removed vanadium oxychloride adds to the balance of other waste solid metal chlorides.

#### Operational data

The usage of the oil to complex the vanadium is given in Section 3.2.3.2.3. No other data submitted.

#### Applicability

Applicable to all plants producing TiO<sub>2</sub> by the chloride process route.

#### Economics

No data submitted.

#### Driving force for implementation

The performance of the chloride process and the quality of the final TiO<sub>2</sub> products.

#### Example plants

Titanium dioxide plant in Greatham, UK (and the other four European TiO<sub>2</sub> plants based on the chloride process route).

#### Reference literature

[20, CEFIC-TDMA, 2004], [42, UBA-Germany, 2001], [48, W. Buchner et al, 1989], [26, EIPPCB, 2003], [85, EIPPCB, 2004-2005].

### **3.2.4.7 Oxidation**

#### Description

Oxidation is one of the key unit processes applied in the production of TiO<sub>2</sub> by the chloride process route.

There are two environmentally equivalent systems:

- a toluene fired furnace, using injection oxygen and titanium tetrachloride which is also preheated with toluene
- a plasma furnace, with the reactants preheated by gas firing.

This is very specialised equipment requiring tailor made designs, which have not always specifically targeted environmental efficiency. However, a key design criterion is maximising the conversion to TiO<sub>2</sub> with minimum energy input, which is clearly an environmental benefit.

Further advances in the design of this equipment have improved online times and allowed for direct chlorine recycling. As a consequence, both have reduced the environmental burden of the operation. The key factor in reactor design is to develop the units to minimise blockage and thereby enable the replacement of the units to be carried out under a planned maintenance regime. Steady state operation is the best option to minimise losses during subsequent shutdowns.

It should be noted, that hot chlorine-rich gases (containing the suspended TiO<sub>2</sub> particles) leaving the oxidation reactor are passed through a long chain of sections included in the gas recycling loop (gas cooling, the TiO<sub>2</sub> product separation, ore chlorination, solids separation, TiCl<sub>4</sub> condensation), the tail off-gases to be finally cleaned in the waste gas treatment section (refer to Section 3.2.4.5), and only then released to the atmosphere.

### Achieved environmental benefits

High conversion of the TiCl<sub>4</sub> into TiO<sub>2</sub>, leading to higher energy efficiency in the process and to reducing the impact of the production of TiO<sub>2</sub> on the environment.

### Cross-media effects

Prior to the oxidation, the TiCl<sub>4</sub> needs to be preheated. Natural gas or steam are used for this purpose. Relevant SO<sub>2</sub> emission data from one site are given in Section 3.2.3.4.7.

### Operational data

For the usage of pure oxygen to oxidise titanium tetrachloride refer to Section 3.2.3.2.4. The usage of toluene is included in the balance of energy (refer to Section 3.2.3.3.1).

### Applicability

Applicable to all plants producing TiO<sub>2</sub> by the chloride process route.

### Economics

No data submitted.

### Driving force for implementation

A very modern and compact plant section, requiring less investment and maintenance cost. A highly material and energy efficient oxidation process, e.g. one based on plasma oxidation technology. A high process efficiency translates to reducing the impact of the plant on the environment.

### Example plants

Titanium dioxide plant in Greatham, UK (a plasma reactor).

Titanium dioxide plant in Leverkusen, Germany (a toluene fired furnace).

Titanium dioxide plant in Rotterdam, the Netherlands (a toluene fired furnace).

### Reference literature

[20, CEFIC-TDMA, 2004], [42, UBA-Germany, 2001], [48, W. Buchner et al, 1989], [26, EIPPCB, 2003], [85, EIPPCB, 2004-2005].

## **3.2.4.8 Cooling and separation**

### Description

Simple corrosion-resistant coolers are designed to minimise internal scouring abrasion with TiO<sub>2</sub> dust, as well as rock salt or sand used for cleaning to prevent deposits of TiO<sub>2</sub>. Gas/solid separation is carried out with reverse pulse bag filters, which minimise undesirable dust carryover to the chlorination reactor. Both the coolers and the filters are supported by an efficient monitoring and maintenance regime. Cooler design has improved over time with modern coolers offering easy access for monitoring and maintenance.

Achieved environmental benefits

Reverse pulse bag filters used for the separation of the TiO<sub>2</sub> minimise dust carry-over, and prevent dust transfer into the chlorination systems, thus minimising downtime.

Cross-media effects

The usage of abrasive solids to scour the primary coolers.

Operational data

No data submitted.

Applicability

Applicable to all plants producing TiO<sub>2</sub> by the chloride process route.

Economics

No data submitted.

Driving force for implementation

The operability of the whole plant and, therefore, the manufacturing cost of TiO<sub>2</sub> production depends on both a high onstream factor of the cooling section and an efficient maintenance regime applied in this section. High efficiency reverse pulse bag filters minimise carryover of the dust to the chlorination reactor.

Example plants

Titanium dioxide plant in Greatham, UK (and the other four European TiO<sub>2</sub> plants based on the chloride process route).

Reference literature

[20, CEFIC-TDMA, 2004], [42, UBA-Germany, 2001], [26, EIPPCB, 2003].

**3.2.4.9 Direct chlorine recycling process**Description

Direct chlorine recycling is currently used as an alternative to the absorption/desorption system, because it allows for an efficient operation, which in turn saves resources. Also, the need for a large tetrachloride inventory (TiCl<sub>4</sub> saturated with gaseous chlorine) is avoided. Steady state operation of chlorination and oxidation in tandem is essential to minimise the environmental impact of a titanium dioxide plant. This requires careful design of the systems with experience used to identify and phase out the weak links in the system to minimise downtime.

Achieved environmental benefits

Phasing out the older chlorine absorption/desorption system in favour of the direct chlorine recycling process, results in the simplification and higher operability of the plant, as well as in lessening the impact of the production on the environment (no tail chlorine gas scrubbing with NaOH solution necessary).

Cross-media effects

No data submitted.

Operational data

No data submitted.

Applicability

Applicable to all plants producing TiO<sub>2</sub> by the chloride process route.

Economics

No data submitted.

Driving force for implementation

Lower inventory of TiCl<sub>4</sub> saturated with chlorine.

### Example plants

Titanium dioxide plant in Greatham, UK (and the other four European TiO<sub>2</sub> plants based on the chloride process route).

### Reference literature

[20, CEFIC-TDMA, 2004], [23, The Council of the EU, 1996], [42, UBA-Germany, 2001], [26, EIPPCB, 2003].

### **3.2.4.10 Abatement systems for gases, solids and liquids**

#### **3.2.4.10.1 Abatement systems for gases**

Abatement systems for gases in the production of titanium dioxide by the chloride process are described in Sections 3.2.4.1.2, 3.2.4.1.3, 3.2.4.4, 3.2.4.5, and Sections 3.3.3.3.6 and 3.3.4.9 which relate to the finishing operations in the production of titanium dioxide, as these operations are, in principle, the same in both the chloride and sulphate process routes. Refer also to Section 3.2.3.7 (Environmental performance – Greatham Works 2002).

#### **3.2.4.10.2 Abatement systems for solids**

Abatement systems for solids in the production of titanium dioxide by the chloride process route are described in Sections 3.2.4.3 and 3.2.4.4. Refer also to Section 3.2.4.10.3 below, and to Section 3.2.3.7.

#### **3.2.4.10.3 Abatement systems for liquids**

### Description

As a titanium dioxide plant is operated to maximise internal co-neutralisation, one general principle that is applied in the design of a new plant is to arrange for the recycling and co-mixing of acid and alkali streams to minimise the usage of materials. It is an overall requirement to stabilise heavy metal impurities to prevent them contaminating the aqueous environment in particular. All residual acids should be neutralised, the pH being, to a certain extent, dependent on local conditions.

### Achieved environmental benefits

Lessening the impact of the production of TiO<sub>2</sub> by the chloride process on the environment.

### Cross-media effects

No data submitted.

### Operational data

Abatement systems for the main liquid and solid emissions applied in titanium dioxide plants operated by the chloride process route are presented in Table 3.32.

Sites	Rotterdam (NL)	Stallingborough (UK) Langebrugge (DE) Leverkusen (BE)
<b>Treatment pH</b>	4	8
<b>Liquid emissions</b>		
Chloride kg/t TiO <sub>2</sub>	30 – 300	3 – 300
Fe kg/t TiO <sub>2</sub>	8	0 – 1
<b>Solid emissions</b>		
Waste to land (as wet solids) kg/t TiO <sub>2</sub>	100	200 – 1000
Notes: FeCl <sub>2</sub> export significantly reduces waste. Neutralisation to pH 4 was allowed and required when the plant was set up due to a restriction on landfill space, but the pH 8 limit will be invoked in 2007. Refer also to data included in Section 3.2.3.7 (Greatham site).		

**Table 3.32: Abatement systems – liquid and solid emissions from TiO<sub>2</sub> plants, using the chloride process [20, CEFIC-TDMA, 2004]**

#### Applicability

Applicable to all plants producing TiO<sub>2</sub> by the chloride process route.

#### Economics

No data submitted.

#### Driving force for implementation

Reducing the impact on the environment, among others resulting from the requirements of the TiO<sub>2</sub> Harmonisation Directive [21, The Council of the EU, 1992].

#### Example plants

All five European plants of TiO<sub>2</sub> production by the chloride process route.

#### Reference literature

[20, CEFIC-TDMA, 2004], [42, UBA-Germany, 2001], [26, EIPPCB, 2003].

### **3.2.4.11 Co-products for sale or re-use**

#### Description

Ferrous chloride (see Section 7.4), sulphur, sodium hypochlorite and possibly, hydrochloric acid are potential co-products. Their production depends mainly on local markets. The principle to maximise co-product production and minimise resource consumption is an obvious solution and there are good examples of this in the European TiO<sub>2</sub> industry.

The goal to maximise the conversion of wastes into co-products to suit local demand, typically associated with the selection and development of a new location to enable the maximum use of co-products, is a proven long term strategy applied across the European TiO<sub>2</sub> industry.

#### Achieved environmental benefits

Minimisation of wastes otherwise released to the environment (refer also to data included in Section 3.2.3.7).

#### Cross-media effects

Often there are local restrictions on markets but, on the other hand, it is counterproductive to transport low cost co-products long distances.

#### Operational data

No other data submitted apart from these included in the preceding sections. For information on ferrous chloride refer to Section 7.4.



### Applicability

In principle, applicable to all plants producing TiO<sub>2</sub> by the chloride process route.

### Economics

No data submitted.

### Driving force for implementation

Reducing the impact on the environment, among others resulting from the requirements of the TiO<sub>2</sub> Harmonisation Directive [21, The Council of the EU, 1992].

### Example plants

Titanium dioxide plant in Greatham, UK.

### Reference literature

[20, CEFIC-TDMA, 2004], [42, UBA-Germany, 2001], [26, EIPPCB, 2003], [90, CEFIC-INCOPA, 2004].

## 3.2.4.12 Energy usage

### Description

For the description of energy usage in the chloride process by site, refer to Section 3.2.3.3.1. Plant design is such as to minimise energy usage. Energy saving in an existing plant is also a matter of management and control. Generally a combination of plant design, operation and management is taken into consideration when determining techniques to minimise energy usage. In particular, for new plants it would also include the supply of its power by a high efficiency combined heat and power (CHP) system [86, The Council of the EU, 2004].

The range of energy usage in 1999 in TiO<sub>2</sub> plants operated by the chloride process route is given in Table 3.33.

Energy	Energy use GJ/tonne TiO <sub>2</sub>
Black end	6 – 10 (*)
Finishing	12 – 18
Effluent treatment	1 – 3
Total	17 – 29 (*)
(*) Including an older chlorine recycling system applied in 1999, but not used at the present time.	

**Table 3.33: Energy usage in 1999 in TiO<sub>2</sub> plants operated by the chloride process route [20, CEFIC-TDMA, 2004]**

These data were also based on the application of a technique in which extra energy was used for chlorine absorption and desorption (at least 4 GJ/t pigment). This technique, however, is no longer in use in the EU titanium dioxide industry.

### Achieved environmental benefits

Energy efficiency in the process is also an indirect measure of the impact of TiO<sub>2</sub> production on the environment. The less energy used for TiO<sub>2</sub> production, the less energy used in primary fuels and, consequently, the less emissions of CO<sub>2</sub>, SO<sub>x</sub>, and NO<sub>x</sub> to the atmosphere related to the generation of energy used in the process.

### Cross-media effects

No side effects or disadvantages caused by the implementation of this technique are reported.

Operational data

Refer to Table 3.16 and Table 3.33. Refer also to the information on energy usage at the Titanium dioxide plant in Leverkusen [42, UBA-Germany, 2001].

Even though a new set of data detailing energy usage in 2005 was not made available by the EU TiO<sub>2</sub> industry, given the progress made in energy efficiency, it has been reported that the upper level of overall energy usage for the chloride process is currently in the range of 21 to 23 GJ/t, and on average 17 to 22 GJ/t pigment [85, EIPPCB, 2004-2005] (refer to Table 3.29 below, which illustrates a clear downward trend of energy consumption between 1999 and 2002 in Greatham, UK).

Refer also to [42, UBA-Germany, 2001], where the energy demand in 2001 (average figures) for the chloride process route, illustrative for one plant in Leverkusen, Germany, was estimated at the level of 18.8 GJ/t and from this for TiO<sub>2</sub> manufacture 6.1 GJ/t and for follow-up treatment 12.7 GJ/t pigment.

Applicability

Applicable to all plants producing TiO<sub>2</sub> by the chloride process route.

Economics

No data submitted.

Driving force for implementation

Reduced impact on the environment and decreased manufacturing cost of TiO<sub>2</sub> production.

Example plants

Titanium dioxide plant in Greatham, UK (and the other four European TiO<sub>2</sub> plants based on the chloride process route).

Reference literature

[20, CEFIC-TDMA, 2004], [42, UBA-Germany, 2001], [26, EIPPCB, 2003], [85, EIPPCB, 2004-2005], [86, The Council of the EU, 2004], [25, D.G. Heath, 1996], [24, Tioxide Group Ltd, 1995], [73, G.V. Ellis, 1979].

### 3.3 Titanium dioxide – the sulphate process

#### 3.3.1 Introduction

Titanium dioxide can be made by one of two basic routes: the chloride process (Section 3.2 above) and the sulphate process (as in this Section 3.3). In both processes, pure titanium dioxide powder is extracted from its mineral feedstock after which it is milled and treated to produce a range of products designed to be suitable for the efficient incorporation into different substrates.

Although applied life cycle assessment techniques (see findings of the LCA study in Section 3.4.5) demonstrated that the current versions of the two processes were environmentally equivalent, the two processes are fundamentally different in most aspects. Therefore, in this document the processes and their emission abatement techniques are treated separately. A comparison of the two processes is included in Section 3.4.

#### 3.3.2 Applied processes and techniques – the sulphate process

The sulphate process, described in this section, uses concentrated sulphuric acid to digest the prepared titanium dioxide ore.

The sulphate route uses low concentration ores such as ilmenite as well as higher concentration synthetic slags – see Table 3.34. The greater presence of iron in ilmenite leads to the cogeneration of a greater amount of iron sulphate from the process. A minimum quantity of iron is required to ensure a high conversion efficiency, thus 80 % TiO<sub>2</sub> is the highest concentration that can be used without unacceptable losses. Only the sulphate process can readily form both crystalline forms (anatase and rutile) of TiO<sub>2</sub>.

Type of feedstock	Component	Portion (mass content in %)
Ilmenite	TiO <sub>2</sub>	44 – 61
Slag	TiO <sub>2</sub>	75 – 80

**Table 3.34: Components in main mineral feedstock – TiO<sub>2</sub> production, the sulphate process [20, CEFIC-TDMA, 2004]**

As illustrated in Figure 3.4 below, the sulphate process generally consists of the following sequential stages.

##### 3.3.2.1 Raw material import and preparation

Ore containing titanium dioxide is usually sourced from outside Europe, however, there is a source of rock ilmenite in Norway, which is used by some companies.

Feedstock purchasing decisions are multidimensional (economic, plant operability, product quality, cost of abatement, waste disposal, etc.) and can change over time. The feedstock of the required purity is purchased according to a set of specifications, set as part of the feedstock purchasing strategy. One of the critical factors is the question of impurities and, therefore, the purity check of titanium ore plays an important role in the production process.

There are two main issues here. Some heavy metal impurities are not acceptable since trace levels in the final product can influence the whiteness and brightness. The other is trace levels of Naturally Occurring Radioactive Materials (NORM) which are present in some ores. This means that with these feedstocks, the processing is subject to the Directive, 96/29 [22, Euratom, 1996], which may mean that the ore handling and disposal of some wastes is subject to exposure assessment. The companies take all the necessary precautions to protect personnel and the environment as required by Euratom.

The raw ore is usually stored in covered storage silos. Although covered storage is, in principle, not necessary for the sulphate process, it does have advantages. If the ore becomes wet in transit then it must be dried before further processing. It is then ground using large ball mills to produce optimum size particles (typically 40–60 µm) for efficient dissolution with concentrated sulphuric acid. The main environmental issue at this stage is dust emissions, which are normally controlled by operating the milling and conveying equipment under mild suction and discharging the gas through bag filters. The content of combustion gas is monitored when drying is required. The collected ore dust is conveyed to a storage bin for the milled ore.

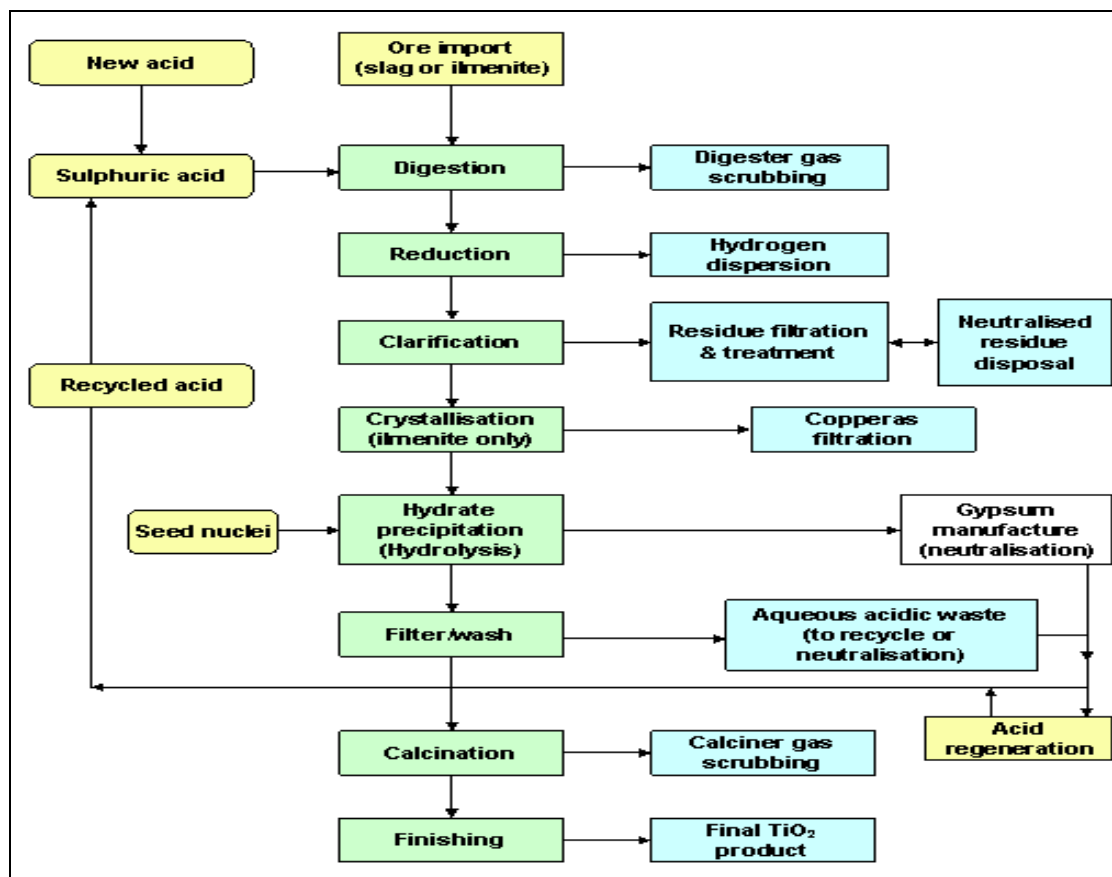


Figure 3.4: Outline flow diagram – titanium dioxide production by the sulphate process [20, CEFIC-TDMA, 2004]

### 3.3.2.2 Digestion

Digestion of the ore can be operated either batch wise or continuously. The more usual process is batch. It is noted that batch processing is preferred by the EU producers. The continuous process has been tried in the past, however with some feedstock types, this process works with lower efficiency (see Section 9.3.2.1). Since the EU producers have an extensive experience and the necessary know-how to run the batch process optimally, all European sites use the batch process. The ilmenite or slag (or a carefully controlled blend of both) is mixed with highly concentrated sulphuric acid (80–95%) and this is necessary to digest the feedstock containing TiO<sub>2</sub>. A highly exothermic reaction is initiated by the addition of a measured quantity of steam, water or diluted acid and takes place at around 140 °C.

The equation for the digestion reaction may be summarised as:



During the batch process, the exothermic reaction raises the temperature of the reactor from 180 to 210 °C and water evaporates. Agitation/mixing of the reactor is achieved by air blowing. In the case of ilmenite as a feedstock, the off-gases contain small quantities of dust, sulphur dioxide and acid fumes, which are removed by scrubbing. Using slag, the off-gases contain dust, sulphur dioxide, sulphur trioxide and traces of hydrogen sulphide, which are normally removed by a multistage scrubbing system.

Two sites use a blend of slag and ilmenite and treat off-gases by normal scrubbing, although using a multistage scrubbing system is a possible option.

In most cases, the scrubbing systems have been updated in the recent past as a result of the Titanium Dioxide Harmonisation Directive [21, The Council of the EU, 1992]. The systems are usually custom built to suit local conditions. The cyclic nature of the batch process requires that the scrubbers have to be capable of handling large volumes of gases during the short reaction period (minutes) followed by relatively low volumes during the subsequent long 'bake' period (hours).

The resulting solid cake is dissolved in water and acid recycled from a subsequent washing step. Any insoluble material is removed by flocculation and filtration. Afterwards, the titanyl sulphate ( $\text{TiOSO}_4$ ) in the clarified liquor is hydrolysed which results in a precipitation of the hydrated  $\text{TiO}_2$ , while other sulphates, e.g. iron-sulphate ( $\text{FeSO}_4$ ), remain in the solution.

Because of the exothermic reaction, the quality and reactivity of the ore has to be checked carefully. Normally the amounts of all components, i.e. ore, concentrated acid and in the case of slag, oleum are carefully metered before they are added to the reactor in order to prevent unintentional pressure release.

The primary intermediate from the reaction is titanyl sulphate ( $\text{TiOSO}_4$ ) and both ferrous and ferric sulphates are produced as by-products, all of which are held in solution in a supersaturated state and care must be taken to avoid instability of the liquor to prevent uncontrolled precipitation of the  $\text{TiO}_2$  crystallites.

Off-gases are treated by a variety of methods most of which are dependent on local conditions (refer to Section 3.3.4.10.1).

### 3.3.2.3 Reduction

When the primary ore is ilmenite (or a blend of slag with ilmenite) the digester liquor is contacted with scrap iron to convert ferric ions ( $\text{Fe}^{3+}$ ) to ferrous ions ( $\text{Fe}^{2+}$ ), otherwise the iron would remain with the  $\text{TiO}_2$  throughout all subsequent processing stages. The quality of the scrap iron has to be controlled in order to prevent the contamination of the solution with heavy metals like chromium or nickel. This process generates a small amount of hydrogen, which is normally rendered harmless by dispersion in air.

The explosion risk is extremely low particularly when the area is designated free from ignition sources. It should be noted that the sulphate process is not subject to the Seveso II regulations [23, The Council of the EU, 1996].

One site blends liquor from slag digestion with unreduced liquor of ilmenite digestion and thus uses no scrap iron.

### 3.3.2.4 Clarification and crystallisation

Any suspended material is removed from the solution by flocculation and filtration. It is washed with dilute waste acid to recover the titanium sulphate. The acidic filtrate liquors are recycled back to the process. The solid residue is neutralised with lime or limestone before going to landfill. This material can sometimes be used as an inert filler or in other applications after further treatment but this is usually not possible due to the limited markets and the presence of impurities, which originate from some ores.

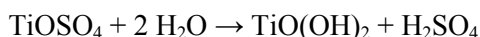
At one site, a small part (<3 %) of the residues is neutralised with caustic soda, washed, dried and added in the digestion step to enhance the yield of TiO<sub>2</sub>.

When ilmenite (or a blend of slag with ilmenite) is the main feedstock, the clarified solution is usually pumped to batch cooler/crystallisers to remove the bulk of the iron sulphate as the solid heptahydrate ('copperas'). This solid and its associated products are widely used for example in water treatment, pharmaceutical and pigment industries. Reference is made here to Section 7.5 on 'Copperas and related products'. The iron-depleted product liquor is polished using filters to remove fine particles and is finally concentrated in evaporators.

### 3.3.2.5 Hydrolysis (hydrate precipitation)

Hydrated titanium dioxide is produced by hydrolysing the liquor with steam in rubber and brick-lined mild steel vessels.

The hydrolysis reaction is:



Precipitation of the hydrated TiO<sub>2</sub> is achieved by boiling the liquor for some hours followed by cooling to 60 °C. The addition of the correct TiO<sub>2</sub> nuclei to the batch determines the final crystal size and form of the titanium dioxide (anatase or rutile crystals). It is noted that there are many local variations of this stage of the process.

The hydrated TiO<sub>2</sub> is filtered off from the suspension and the filter cake is washed to remove any absorbed metal ions. At this stage of the process, the spent acid with a concentration of 20 - 25 % H<sub>2</sub>SO<sub>4</sub> and 10 - 15 % of soluble salts (mainly iron, aluminum and magnesium sulphates) arises and is either recycled or neutralised with lime/limestone to produce gypsum which is preferentially sold at local markets as a commercial product (e.g. white gypsum) or, if there is no possibility to sell it, it is landfilled.

It should be noted that because the main process liquor is a supersaturated solution of hydrated titanium ions, it has to be treated carefully to prevent uncontrolled hydrolysis ('instability'). To reflect this, the process requires steady state operations both in production rate and temperature control. Liquor, especially that made from ilmenite, is often preconcentrated to aid stability and to help control hydrolysis.

Working with so-called low 'F/T' (iron/titanium) ratios is an example of the expertise that has been built up in the industry over the years. All systems, as long as they allow good control during precipitation, appear to be equivalent from the operational point of view. The unique variable is the size of the flocculates of crystallites. This is carefully controlled to allow for as narrow as possible, consistent particle size distribution of calciner discharge downstream in the process.

### 3.3.2.6 Filtration and washing

The precipitated hydrated  $\text{TiO}_2$  is separated on vacuum filters from the mother liquor (i.e. 'strong' acid, approx. 20 – 25 %  $\text{H}_2\text{SO}_4$ ). This acidic filtrate can either be reconcentrated and recycled back to the digestion step or may be neutralised with lime/limestone and the product gypsum sold for wallboard manufacture, etc. After the separation of the mother liquor, the filter cake is washed with water or a weak acid. The resultant solid is slurried with dilute sulphuric acid and aluminium or a solution of trivalent titanium is usually added as a reducing agent to maintain the iron in the ferrous state.

The slurry is 'leached' (sometimes called 'bleaching') at 50 °C to remove final traces of iron. Thus the residual solid metals (Fe, Cr, Mn, and V) are eliminated from the hydrate by the addition of a reducer additive (e.g. trivalent titanium or aluminium) and acid (leaching agent). The use of zinc is not recommended due to its potential effect in the food chain.

The slurry then undergoes final washing and dewatering. The pulp still contains adsorbed sulphuric acid, which is impossible to remove by washing. Conditioning agents and rutile nuclei can be added at this stage to the resulting pulp to enhance crystallite growth and to determine the final crystal form during calcination.

One site in the EU-25 reports the usage of concentrated sulphuric acid for bleaching, but there are no details of this technique available [85, EIPPCB, 2004-2005].

### 3.3.2.7 Calcination

The rotary kilns are directly fired with oil or gas. The pulp moves under gravity countercurrently to the combustion gases. Water and oxides of sulphur are driven off the pulp. Temperature control (particularly where there is direct contact with the gas flame) is important in the production of the correct crystalline type and particle size of the pigment.

As with digester gas, scrubbing calciner gas treatment has been upgraded in the past in order to reduce  $\text{SO}_2$  emissions to below the limit prescribed in the Titanium Dioxide Harmonisation Directive [21, The Council of the EU, 1992].  $\text{TiO}_2$  dust is removed by scrubbing and recycled.  $\text{SO}_3$  is removed by electrostatic precipitators. The  $\text{SO}_2$  component of the gas is either scrubbed out or catalytically oxidised to  $\text{SO}_3$  and absorbed to form sulphuric acid, which in turn is recycled. In one site, the off-gases are partly used for the preconcentration of waste acid.

### 3.3.2.8 Effluent treatment

It is common practice in the titanium industry to use the terms 'strong' and 'weak' acid. They are defined in the  $\text{TiO}_2$  Harmonisation Directive [21, The Council of the EU, 1992]. In simple terms, strong acid is sulphuric acid at the strength it occurs immediately after hydrolysis of the digestion cake (see Section 3.3.2.2 above). Weak acid is the sulphuric acid that results from the dilution of the strong acid particularly when washing the precipitated  $\text{TiO}_2$  pulp that results from the digestion cake hydrolysis. There are two options for the treatment of the strong waste acid: reconcentration followed by recycling, or neutralisation – see Section 3.3.2.6 and Figure 3.5. Weak waste acid is directly recycled (there is only a limited capacity for this within the process) or neutralised. It is not cost effective or environmentally sensible to reconcentrate weak acid.

### 3.3.2.9 Finishing section

The finishing section is common to the chloride and the sulphate processes. The resulting solid is cooled, milled, coated, washed, dried, micronised and packed. Before coating, two stages of milling are used:

- dry milling to break down aggregated particles from the calcining process (up to 20 mm) to 75 - 100  $\mu\text{m}$ ; and
- wet milling to achieve fine particles of the correct size for optimum pigment properties (0.2 - 0.4  $\mu\text{m}$ ).

#### 3.3.2.9.1 Coating

The main purpose of coating is to improve durability and to lessen the yellowing which occurs in certain types of paints, and also to improve the dispersibility of the pigments within their particular substrates.

Coating involves the deposition of a small percentage of other materials on to the pigment surface. Hydroxides of silica, titanium, zirconium and aluminium are commonly used. The coating agents are normally added to the milled slurry as soluble sulphates or chlorides, while it is continuously stirred.

By adjusting the solution pH, hydrated oxide is precipitated on to the surface of the pigment particles. Coatings of two or more hydrated oxides may be applied to a pigment, either separately by successive operations or simultaneously in one operation.

#### 3.3.2.9.2 Final processing

After coating, the pigment is washed and dried before being ground by entrainment in high velocity steam in a microniser or fluid energy mill to separate the aggregated particles. This stage is essential in order to produce the high quality required for all modern pigment applications.

Particulate matter generated during micronising is removed to low levels by bag filters prior to the condensation of steam from fluid energy milling, either in conventional heat exchangers or in a barometric leg. In case steam condensation is not used, particulate matter is removed prior to steam venting to the atmosphere.

Many  $\text{TiO}_2$  pigments are also given a light organic surface treatment to improve their dispersibility in a variety of media. This is usually carried out during the final milling stage. A variety of organic compounds are used as additives. The most common types are polyols, amines and silicone derivatives.

The final product is packed in paper sacks (either manually or automatically); packed in 'semi-bulk' containers; or exported in road tankers.

#### 3.3.2.10 Abatement systems for aqueous emissions from the sulphate process

If there were no effluent treatment operations then the sulphate process would produce large quantities of strong waste sulphuric acid and aqueous acidic effluents, which contain metal sulphates and waters from the post-treatment section.



The two main systems used to treat this strong waste acid are acid recycling or neutralisation. However, it must be understood that in modern titanium dioxide manufacturing processes there is often a whole co-product strategy including the production and marketing of copperas, which influences the particular combination of treatments that is chosen for any particular site – refer to Section 7.5.

### 3.3.2.10.1 Acid recycling

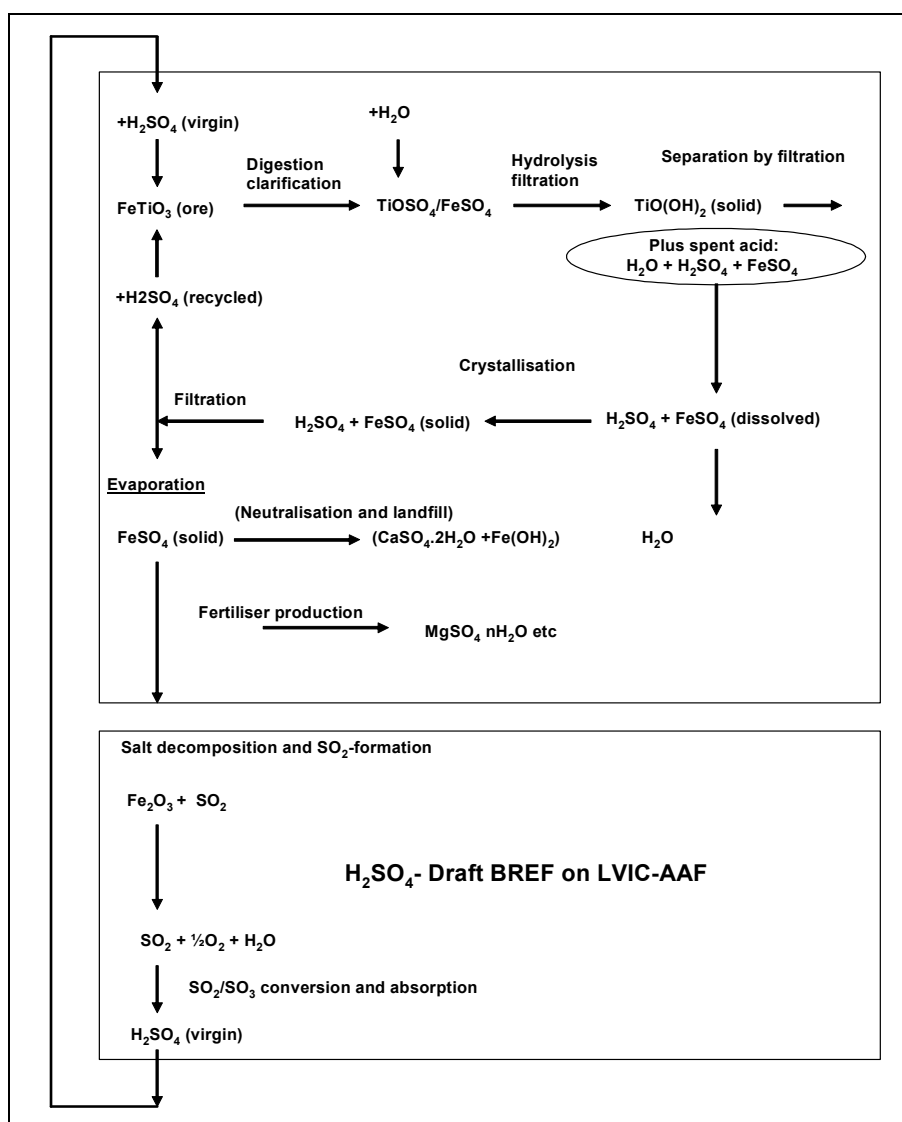
The strong waste acid is concentrated by evaporation in a complex multistage process to approximately 70 %  $\text{H}_2\text{SO}_4$ . During the concentration process, the soluble salts are precipitated and are filtered off after the cooling of the 70 % acid. This acid can be used again in the digestion step or can be further concentrated up to approximately 80 %  $\text{H}_2\text{SO}_4$ , and then used in the digestion of the ore containing  $\text{TiO}_2$ .

One site reports that the waste acid, after being concentrated to an appropriate level, is used for the production of phosphoric acid, the latter being used for the production of fertilisers.

The separated filter-salts (mainly iron sulphate in the monohydrate form) can be thermally decomposed to iron oxide and sulphur dioxide, which is converted to fresh sulphuric acid, which is used in the digestion step, too. So there are essentially two recycling loops: one dealing with the acid that remains an acid in the  $\text{TiO}_2$  process, and one dealing with the acid which is transformed into a metal sulphate and needs to be decomposed to recover the sulphur values. Alternatively the filter salts can be neutralised for use in the fertiliser industry or for landfill.

The production of sulphuric acid from the  $\text{SO}_2$  of filter salts roasting is the point at which the operation is covered by the sulphuric acid process – see BREF on LVIC-AAF.

The overall scheme is shown in Figure 3.5 below.



**Figure 3.5:** Overall process-scheme of sulphuric acid recycling – TiO<sub>2</sub> sulphate route [20, CEFIC-TDMA, 2004]

### 3.3.2.10.2 Neutralisation

Neutralisation is used for both strong and weak acid. The process normally adopted for strong acid is a two-stage neutralisation:

- stage 1: Neutralisation with chalk or limestone in which pure white gypsum is produced
- stage 2: Neutralisation to pH 8 – 9 with lime to produce ‘red gypsum’, which is a mixture of stabilised metal hydroxides and gypsum.

The purpose of this staged process is that it is designed to produce marketable co-products for use in many industrial and agricultural applications. If white gypsum is required for plasterboard then extra process steps are required to ensure the gypsum’s properties are compatible with the plasterboard manufacturing requirements. The long term strategy of the TiO<sub>2</sub> sulphate process industry is aimed at the optimum balancing of inputs and outputs, the best example here being probably white gypsum, which – because of its good quality – finds its applications in the production of gypsum plasterboards, even though there are abundant supplies of cheap, subsidised flue-gas desulphurisation (FGD) gypsum across Europe.

Weak acid is usually also neutralised by a two-step process using limestone and lime producing single product (‘red’) gypsum.

### 3.3.2.10.3 Waste water from post treatment

Waste water contains mainly pigment and sodium sulphate, which results from using caustic and caustic based additions in the final coating process. Depending on the quality, it can either be sent to the rivers after removing of the suspended solids, or treated and then combined with the acidic waste water from the sulphate plant.

### 3.3.2.10.4 Cooling waters

Any water that is used specifically for cooling can be considered using the horizontal 'Industrial Cooling Systems' BREF.

### 3.3.2.10.5 Co-products

The principle co-products and their uses are listed below:

- ferrous sulphate is used in municipal waste water treatments (phosphorus removal), as raw material for iron oxide pigments and as an additive for concrete (Cr anti allergen), fodder and fertilisers
- ferrous sulphate is converted to ferric form, which is used in water treatment
- white gypsum (for wallboards and the cement industry) and red gypsum (agricultural use). Red-gypsum can also be used as a solidifying agent for loose clay soils to make them stable (for highways, etc). Red gypsum, blended with organic fertiliser, is also used for capping and landscaping activities of quarries, landfills and contaminated sites. Finally, this co-product can be used in the cement industry
- ilmenite residue (ilmenite sand) can be used as a silicate product in the cement industry and as a filler in land improvements
- iron oxide from filter salt roasting is used in the cement industry
- concentrated acid can be used in the fertiliser industry
- a high quality CO<sub>2</sub> may be produced during gypsum manufacture. This may be bottled and sold for carbonated drinks.

### 3.3.3 Present consumption and emission levels – the sulphate process

All data originate from the European sites designated in Table 3.5 (apart from Police, Poland and Celje, Slovenia) and are for the year 1999 [20, CEFIC-TDMA, 2004] and, unless stated otherwise, all consumption and emission units are in kg per tonne of TiO<sub>2</sub> pigment. For current environmental performance of the TiO<sub>2</sub> production using sulphate process – see Figure 3.4 and refer to the environmental performance case study in Section 3.3.3.6.

#### 3.3.3.1 Raw materials consumption

##### 3.3.3.1.1 Digestion

###### Ore usage

The TiO<sub>2</sub> content of the main feedstock range from 44 to 80 % and most sites have their unique range of feedstock which best suit their supply and processing conditions. Usually in any one period, a site will use either slag or ilmenite, but blends of slag and ilmenite can also be used and two sites use them to good effect.

It is noted that the impact of different ores is a complex process, for example, the use of slag increases the overall energy consumption but reduces the solid emissions, however, with an active co-product sales policy this effect can be balanced. This is covered in detail in the life cycle assessment in Section 3.4.5.

Main materials into section	Ilmenite	Slag	TiO <sub>2</sub> throughput
kg/t TiO <sub>2</sub> (average)	1662	956	1131
kg/t TiO <sub>2</sub> (maxima of averages)	2540	1405	1222
kg/t TiO <sub>2</sub> (minima of averages)	220 <sup>(1), (2)</sup>	0	1057
Notes:			
1. This figure is much below theoretical consumption, but it is incorrect to imply that the site using the minimum amount of ilmenite also used the minimum amount of slag;			
2. In this case, one site blended a small amount of ilmenite with the main slag feed in 1999.			

**Table 3.35: Usage of the main titaniferous raw materials in the sulphate process**

The usage of the main titaniferous raw materials in the sulphate process is given in Table 3.35. As with the chloride process, this makes direct comparison of usages not very meaningful. Looking at the TiO<sub>2</sub> throughput can provide a more useful comparison. It is seen that the average consumption is 1131 kg TiO<sub>2</sub> in the feedstock per tonne of TiO<sub>2</sub> pigment with a range of +/- 8 %. It is considered that a variation across this range is not very significant, particularly in the light of the variation in the feedstock blends.

###### Sulphuric acid usage

The consumption of sulphuric acid is primarily dependent upon the impurity content of the feedstock, however, it is also influenced by the choice of effluent treatment, which controls how much recycled acid can be used. This is a complex environmental issue and it contributes to the life cycle assessment balance because there is an interplay of different environmental effects depending on the acid and ore combination that is used. Sulphuric acid usage in titanium dioxide production by the sulphate process is given in Table 3.36.

Main materials into section	Sulphuric acid new (as 100 %)	Sulphuric acid recycled (as 100 %)	Sulphuric acid total (as 100 %)
kg per t TiO <sub>2</sub> (average)	2362	1067	3250
kg per t TiO <sub>2</sub> (maxima of averages)	3740	1634	4394
kg per t TiO <sub>2</sub> (minima of averages)	956	80	2430

**Table 3.36: Sulphuric acid usage in titanium dioxide production by the sulphate process**

**3.3.3.1.2 Reduction**

Scrap iron is required if ilmenite or a blend of slag and ilmenite is the feedstock. The usage is primarily dependent on the amount of ferric iron in the system. Scrap iron usage is given in Table 3.37.

Main materials into section	Scrap iron
kg per t TiO <sub>2</sub> average	150
kg per t TiO <sub>2</sub> max	250
kg per t TiO <sub>2</sub> min	127

**Table 3.37: Scrap iron usage**

**3.3.3.1.3 Clarification and crystallisation**

Small amounts of filter aid are used to assist the removal of unreacted fine particles of impurity from the liquor. No other materials are consumed at this stage of the process. However, the residue is neutralised to stabilise metal ion impurities and remove any retained acid before subsequent use or disposal. Lime or limestone is normally used for this purpose. These data are included in the table of general materials usage (Table 3.38) given below.

**3.3.3.1.4 Hydrolysis, filtration and washing**

No significant materials are consumed during these stages of the process, however it is here that the strong waste acid is produced which requires treatment. This is done by reconcentration, etc. or by neutralisation as described above in Section 3.3.2.10 and illustrated in Figure 3.5.

**3.3.3.1.5 Calcination**

Small proportions of mineral salts, such as KCl, are added to assist crystal growth.

**3.3.3.1.6 Effluent treatment**

See Sections 3.3.3.1.8 and 3.3.3.1.9 below.

**3.3.3.1.7 Finishing**

Inorganic metal sulphates and caustic soda are consumed at this stage and their usage is included in the summary Table 3.38 below.

**3.3.3.1.8 Abatement systems for aqueous emissions from the sulphate process**

Significant quantities of lime and limestone are used if neutralisation is the chosen abatement system – see Table 3.38, covering also the usage of materials in the finishing section.

Main materials into section	Al <sub>2</sub> (SO <sub>4</sub> ) <sub>2</sub> (100 %)	H <sub>2</sub> O <sub>2</sub> (50 %)	Ca(OH) <sub>2</sub> (100 %)	CaCl <sub>2</sub> (100 %)	CaCO <sub>3</sub> (100 %)	NaOH (100 %)	Al(OH) <sub>3</sub> (100 %)
kg per t TiO <sub>2</sub> (average)	21	12	363	15	1380	90	30
kg per t TiO <sub>2</sub> (max. average)	21	12	800	15	2954	168	53
kg per t TiO <sub>2</sub> (min. average)	21	12	30	15	36	46	15

**Table 3.38: Materials used – abatement systems aqueous emissions and the finishing section [20, CEFIC-TDMA, 2004]**

### 3.3.3.1.9 Abatement systems for gaseous emissions from the sulphate process

Small amounts of caustic and peroxide may be used. These are included in Table 3.38 above.

The main point to note when summing up the major materials used in the whole process (not included in the boxes and tables above) is the wide range of neutralising materials that are used depending whether or not neutralisation is the main method of effluent treatment. Some of the data are specific for one or two sites. It should be pointed out that the more internal recycling that is done, the less neutralising raw materials are used.

### 3.3.3.2 Utilities consumption – energy and water

The original concept was to give energy and water consumptions for each process stage as is done above, however this was found to be excessively complicated due to limitations on the measurement systems that the sites have in place and in the case of water, the many recycling arrangements that exist. Instead, a simplified set of data for the sites as a whole is given.

#### 3.3.3.2.1 Energy

The overall energy consumption for the production of a titanium dioxide pigment based on the sulphate process is in the range of 24 to 45 GJ/t, with an average of approximately 36 GJ/t.

Energy units are GJ per tonne of TiO<sub>2</sub> pigment. Consumptions of electricity, steam, gas and heavy fuel oil, given in Table 3.39, are for the following three major sections of the process [20, CEFIC-TDMA, 2004]:

1. Ore preparation to calcination – Sections 3.3.2.1 to 3.3.2.7.
2. Finishing – Section 3.3.2.9.
3. Effluent treatment – Section 3.3.2.8.

Process section	Sulphate average	Maximum sulphate	Minimum sulphate
Date	1999	1999	1999
<b>Energy TiO<sub>2</sub> usage ore preparation to calcination/oxidation</b>			
Electricity GJ/t	1.9	3.1	1.0
Steam GJ/t	5.5	9.0	1.4
Gas GJ/t	9.7	12.5	7.3
<b>Energy: TiO<sub>2</sub> usage finishing</b>			
Electricity GJ/t	1.3	3.4	0.6
Steam GJ/t	8.5	12.8	1.2
Gas GJ/t	2.4	4.2	0.0
<b>Energy effluent treatment</b>			
Electricity GJ/t	1.0	2.5	0.1
Steam GJ/t	3.3	11.4	0.0
Gas GJ/t	0.4	3.0	0.0
Heavy fuel oil, coal, coke GJ/t	2.4	8.7	0.0
<b>Overall total energy per site</b>	<b>36.4</b>	<b>45.3</b>	<b>23.7</b>

**Table 3.39: Energy consumption in TiO<sub>2</sub> production – the sulphate process [20, CEFIC-TDMA, 2004]**

It should be noted that these data rows are the average, maxima and minima of all the data for the individual sections of the individual sites [20, CEFIC-TDMA, 2004]. As with the chloride process, the energy usage analysis has been simplified [20, CEFIC-TDMA, 2004].

It should be also noted that these are site usages of energy and do not include energy used in the production of raw materials (ore, oxygen, etc). These are taken into account in the LCA study - refer to Section 3.4.5. Also the LCA has a recognised and auditable method of using realistic heat/power energy conversion efficiencies [20, CEFIC-TDMA, 2004].

### Ore preparation to calcination – comments

A number of sites have a significantly lower energy consumption in this section of the process than all the others for no simple reason. There is a variation about the mean of approximately +/-30 %. Typical explanations are given below:

- electricity usage largely depends on the number and size of streams
- drying feedstock uses up to 0.5 GJ/t of titanium dioxide pigment
- slag will require more energy for milling, i.e. about 0.2 GJ/t
- steam: slag plants need not use concentrators worth ~ 0.5 – 1.3 GJ/t
- use of ammonia for crystallisation cooling can reduce energy consumption
- steam usage at concentration can vary widely with the use or not of liquor preheaters and multi-effect concentrators
- gas is mainly used for calcination and its usage depends on the type of dewatering (feed solids), type of feed and the use of hot gas recycling. Pressure filters on calciner feed can save 2 – 3 GJ/t TiO<sub>2</sub>, while the recycling of hot gases during calcinations saves ~ 0.5 GJ/t TiO<sub>2</sub>.

Typical values are:

- rotary vacuum screw no hot gas recycling (38 % solids): 12.5 GJ/t
- pressure filter screw + hot gas recycling (45 % solids): 7 – 8 GJ/t
- it is common to have any combination in between.

Acid recycling with roasting all the salts adds approximately an extra 11.5 GJ/tonne to the total compared with neutralisation – see box in ‘Effluent treatment – comments’ section below:

### Finishing – comments

Variations here are easier to account for since the dominant energy (steam) consumer is the final fluid energy milling (‘micronising’). The higher quality pigment grades often require two passes of milling, i.e. using almost twice the energy as single milled grades. Each company will have its own range of the double milled grades, which is dependent on its customer base. One site does not micronise at all. Other variations are:

- electricity usage varies with the techniques for dry and wet milling (Raymond mills, sand mills, beads), as well as with the production of uncoated grades. Wet milling can add ~ 1 GJ/t TiO<sub>2</sub> pigment produced
- gas is normally only used for drying. The differences can be explained by technology (a spray dryer only uses gas, a band dryer uses different combinations of gas and steam)
- steam is used for milling and drying. Milling usage, depending on the type of grades, can vary from 5 to 10 GJ/t, and average about 7 GJ/t. Double micronising can add up to ~ 5GJ/t TiO<sub>2</sub> pigment.

**Effluent treatment – comments**

Neutralisation requires significantly less primary energy than acid recycling. This is because for recycling both reconcentration of the ‘strong acid’ and roasting of the filter salts are usually required to bring the acid to the required strength. In Europe, many different permutations are adopted which means that the contribution to the overall energy usage varies significantly from plant to plant (see Section 3.3.3.2.1 above) as detailed below:

- one site recycles and neutralises, and some of the salts are exported for roasting
- another site exports its strong acid to another site for reconcentration and subsequently reimports an equivalent quantity of the reconcentrated acid
- another site recycles and neutralises its filter salts
- some sites neutralise only
- one site exports its filter salts to another for roasting and reimports an equivalent quantity of acid
- three sites recycle acid and roast salts. The energy usage needed for roasting all salts adds to ~ 5 GJ/t TiO<sub>2</sub>.

As seen in Table 3.40, in broad terms, neutralisation uses 2 – 3 GJ/t of site energy whereas acid recycling (with roasting all the salts) adds approximately 14 GJ/t, the difference being as high as up to 12 GJ per tonne of TiO<sub>2</sub> pigment produced:

<b>Average energy usage for neutralisation GJ/t</b>	<b>2.3</b>
Maximum energy usage for neutralisation GJ/t	6.5
Minimum energy usage for neutralisation GJ/t	0.2
<b>Average energy usage for acid recycling GJ/t</b>	<b>13.8</b>
Maximum energy usage for acid recycling GJ/t	18.0
Minimum energy usage for acid recycling GJ/t	10.2

**Table 3.40: Energy usage in the production of TiO<sub>2</sub> via the sulphate process**

**3.3.3.2.2 Water consumption**

Because of different technological options used, water consumption is specific to each site. Water saving in an existing plant is often a matter of management and control. This is particularly the case on the older sites when, in former times, water was freely available and not seen as a commodity that was worth saving. Awareness of the main users is an essential feature. Modern sulphate plants are generally fitted with equipment that is designed to be water efficient, and there are many ways that water can be re-used in the sulphate process.

Site/process type	Averages sulphate	Maximum sulphate	Minimum sulphate
Date	1999	1999	1999
Total water per site m <sup>3</sup> /t	189	770	60
Industrial total m <sup>3</sup> /t *	77	210	35
Sea or river water m <sup>3</sup> /t	246	720	79
* ‘Industrial total’ is water imported into site for TiO <sub>2</sub> processing and effluent treatment, except for cooling water for once through open systems, denoted here as sea or river water.			

**Table 3.41: Water consumption in the production of TiO<sub>2</sub> via the sulphate process**



### 3.3.3.3 Emissions to air

In contrast to the chloride process, plant sections are not usually integrated as far as gaseous emissions are concerned, so it is easier to attribute specific emissions to particular sections of the plant.

#### 3.3.3.3.1 Raw material import and preparation

The major concern here is dust. Some sites monitor their emissions from their feedstock dryers; often these are not regarded as significant. Dust and NO<sub>x</sub> emissions are given in Table 3.42.

Emitted substance	Dust	NO <sub>x</sub>
Typical treatment method	Bag filters	
<b>kg per t TiO<sub>2</sub> (average)</b>	<b>0.04</b>	<b>0.03</b>
kg per t TiO <sub>2</sub> (max)	0.08	0.04
kg per t TiO <sub>2</sub> (min)	0.0002	0.002
Collection period	1999	1999
No of data (average)	11	3
<b>Typical volume based value</b>	<b>Dust</b>	<b>NO<sub>x</sub></b>
<b>mg/Nm<sup>3</sup> (average)</b>	<b>39<sup>(*)</sup></b>	<b>23</b>
* If one site is excluded, the average would be 18 mg/Nm <sup>3</sup> .		

**Table 3.42: Dust and NO<sub>x</sub> emissions – TiO<sub>2</sub> production, the sulphate process [20, CEFIC-TDMA, 2004], [85, EIPPCB, 2004-2005]**

#### 3.3.3.3.2 Digestion

SO<sub>2</sub> and H<sub>2</sub>S emissions from the digestion section for treatment are given in Table 3.43.

Gaseous emissions for treatment		
Emitted substance	SO <sub>2</sub>	H <sub>2</sub> S
Typical treatment method	Scrubbing	Scrubbing
<b>kg per tonne TiO<sub>2</sub> (average)</b>	<b>0.47</b>	<b>0.003</b>
kg per t TiO <sub>2</sub> (max)	1.91	0.010
kg per t TiO <sub>2</sub> (min)	0.00	0.000
Collection period	1999	1999
No of data (average)	3	3
No of data (max.)	10	4
No of data (min)	1	1
<b>Typical volume based value</b>	<b>SO<sub>2</sub></b>	<b>H<sub>2</sub>S</b>
<b>mg/Nm<sup>3</sup> (average)</b>	<b>87</b>	<b>4</b>

**Table 3.43: Gaseous emissions in the digestion section – TiO<sub>2</sub> production, the sulphate process [20, CEFIC-TDMA, 2004]**

Sulphur dioxide emissions are usually the main concern here. It is noted that if the feedstock is rock ilmenite then the SO<sub>2</sub> emission is likely to be zero and, in this case, simple water scrubbing can be used to remove any acid mist and SO<sub>3</sub>. If slag is the feedstock, then small amounts of H<sub>2</sub>S are emitted. Water and caustic scrubbing can be used.

### 3.3.3.3 Reduction

Some hydrogen is emitted in the reduction step – see Table 3.44.

Emitted substance	Hydrogen
Typical treatment method	None
kg per t TiO <sub>2</sub> (average)	1
kg per t TiO <sub>2</sub> (max)	2
kg per t TiO <sub>2</sub> (min)	0
Collection period	1999
Data estimated at one site only, no volume based data available	

**Table 3.44: Hydrogen emissions during the reduction step**

### 3.3.3.4 Hydrolysis, filtration and washing

There are no atmospheric emissions from these sections, however reference can be made to Section 7.5 on ‘Copperas and related products’, since some atmospheric emissions occur depending on how the copperas is subsequently treated to convert it into saleable co-products.

### 3.3.3.5 Calcination

As can be seen from Table 3.45, sulphur dioxide emission is the major concern for all countries of the European Union. The Czech plant did not have its sulphuric acid plant operational until the 4th quarter of 1999, hence the average for the year is high. Most plants have proprietary equipment in which there is the catalytic conversion of SO<sub>2</sub> to SO<sub>3</sub> and subsequent absorption to sulphuric acid, which is recycled. The performance of these units is dependent on many factors such as age of catalyst, degree of dust contamination, size and number of units, etc. (refer to the BREF on LVIC-AAF).

The explanation of the large range of data numbers is that some sites have ‘continuous’ measurement. One plant has a unique arrangement where the calciner gases are fed directly to their sulphuric acid plant. Another has a direct water scrubbing system that is ‘waste-free’ since all the scrubbing water is re-used in the process.

Emitted substance	Acid mist	Dust	SO <sub>2</sub>	NO <sub>2</sub>
Typical treatment method	Electrostatic mist precipitators		Catalytic oxidation	None
<b>kg per t TiO<sub>2</sub> (average)</b>	<b>0.65</b>	<b>0.24</b>	<b>3.5</b>	<b>0.6</b>
kg per t TiO <sub>2</sub> (max)	1.57	0.65	12.10	1.20
kg per t TiO <sub>2</sub> (min)	0.00	0.00	0.01	0.04
Collection period	1999	1999(*)	1999	1999
No of data (average)	4	4	70082	2
No of data (max)	4	10	175200	4
No of data (min)	4	1	4	1
<b>Typical volume based value</b>	<b>Acid mist</b>	<b>Dust</b>	<b>SO<sub>2</sub></b>	<b>NO<sub>2</sub></b>
<b>mg/Nm<sup>3</sup> (average)</b>	<b>33</b>	<b>23</b>	<b>713</b>	<b>98</b>
(*) Four sites – estimated data				

**Table 3.45: Gaseous emissions from calcination – TiO<sub>2</sub> production, the sulphate process [20, CEFIC-TDMA, 2004]**

## 3.3.3.3.6 Finishing

Dust emissions from the finishing section are given in Table 3.46.

Emitted substance	Dust from milling	Dust from micronising
Typical treatment method	Cyclones/bag filters	Bag filters
<b>kg per t TiO<sub>2</sub> (average)</b>	<b>0.01</b>	<b>0.156</b>
kg per t TiO <sub>2</sub> (max)	0.02	0.370
kg per t TiO <sub>2</sub> (min)	0.00	0.002
Collection period	1999	1999
No of data (average)	7	18
No of data (max)	12	40
No of data (min)	2	2
<b>Typical volume based value</b>	<b>Dust from milling</b>	<b>Dust from micronising</b>
<b>mg/Nm<sup>3</sup> (average)</b>	<b>12</b>	<b>27<sup>(*)</sup></b>
<sup>(*)</sup> When data from 2001 are taken into account, a typical volume based value for dust from micronising is 20 mg/Nm <sup>3</sup> , mainly due to improvement at one site.		

**Table 3.46: Dust emissions from the finishing section – TiO<sub>2</sub> production, the sulphate process [20, CEFIC-TDMA, 2004], [85, EIPPCB, 2004-2005]**

Dust emissions during jet milling are subject to careful control. Since all plants use similar equipment, it is presumed that the variation in the data is due to operational reasons.

## 3.3.3.3.7 Abatement systems atmospheric emissions – the sulphate process

It should be noted, as shown in Figure 3.5, that the SO<sub>2</sub> from a filter salts roasting plant is considered to be treated according to the information given in the BREF on LVIC-AAF.

## 3.3.3.4 Emissions to water

## 3.3.3.4.1 Hydrolysis, filtration and washing

The major aqueous emissions are allocated to the filtration and washing section, specifically washing since the ‘strong acid’, which is the product of the filtration section (originating from the primary titanyl sulphate hydrolysis) and is forbidden by the TiO<sub>2</sub> Harmonisation Directive [21, The Council of the EU, 1992] to be discharged into the aqueous environment.

It should be noted that the concentration of sulphate and most of the metal ions in the final plant effluent is dependent both on the amount of copperas and copperas related products that are extracted (refer to Section 7.5) and the level of effluent treatment. There is no difference in the type of emission whether neutralisation or acid recycling has been used, however, it is possible to achieve a lower level of contaminants with neutralisation. As illustrated in Table 3.47, there are no other significant emissions to water from the process, except for suspended solids and sodium sulphates from the finishing section, which are given below. Sodium sulphate originates from caustic and caustic based agents, which are used to deposit the surface coating on the pigment. Sulphate and metals are the ions of concern and these are monitored closely in all countries.

Treatment method	Acid recycling or neutralisation					
	Sulphate	Iron	Cd	Hg	Other metals *	Susp. solids
Collection period	1999	1999	1999	1999	1999	1999
<b>kg per t TiO<sub>2</sub> (average)</b>	<b>274</b>	<b>18</b>	<b>0.000799</b>	<b>0.000310</b>	<b>3</b>	<b>12</b>
kg per t TiO <sub>2</sub> (max)	730	158	0.003200	0.002200	17	41
kg per t TiO <sub>2</sub> (min)	30	0	0.000001	0.000000	0.001	0.09
No of data (average)	296	335	65	65	155	4579
No of data (max)	1095	1095	365	365	730	35040
No of data (min)	12	12	4	4	1	12
<b>Typical volume based values</b>	<b>Sulphate</b>	<b>Iron</b>	<b>Cd</b>	<b>Hg</b>	<b>Other metals</b>	<b>Suspended solids</b>
<b>mg/litre</b>	<b>5151</b>	<b>259</b>	<b>0.022</b>	<b>0.0089</b>	<b>58</b>	<b>213</b>
* Other metals are: Manganese (Mn) Vanadium (V) Titanium (Ti) Zinc (Zn) Chromium (Cr) Lead (Pb) Nickel (Ni) Copper (Cu) Arsenic (As)						
Note: As stems from the figures provided by UBA-Germany, German plants performed better as, apart from Cadmium (Cd), all the other maximum load figures (sulphate, iron, mercury, and suspended solids) were lower, the maximum load of 'other metals' being 1 kg/t TiO <sub>2</sub> , with a load of 0.05 kg Cr/t TiO <sub>2</sub> pigment.						

**Table 3.47: Major aqueous emissions from the TiO<sub>2</sub> production based on the sulphate process [20, CEFIC-TDMA, 2004], [42, UBA-Germany, 2001], [85, EIPPCB, 2004-2005]**

The following are comments on particular emitted ions:

**Sulphate:** This is a key prescribed variable in the TiO<sub>2</sub> Harmonisation Directive [21, The Council of the EU, 1992] where the maximum allowable emission level is 800 kg/t TiO<sub>2</sub>. The lower the level, the more effluent treatment that is carried out. There is a baseline sulphate concentration of ~100 kg/t which results from sodium sulphate from the coating process mentioned above.

It is known that the plants with the highest sulphate emission have projects in hand to reduce the current level by a further significant amount. Plants discharging into the Mediterranean Sea have, for many years, been special cases where the State regulatory authorities require total treatment. The same is now true for the Baltic Sea. This accounts for the lower end of the range. Similarly plants that discharge into the Rhine have special limits but in this case the controlling variable is the chromium content (see 'other metals' below).

**Iron:** This has been singled out of the metals since it is the major metal next to titanium in the original ilmenite ore (the formula of pure ilmenite is FeO·TiO<sub>2</sub>).

**Mercury and Cadmium:** Data are given on these metals because they are the so-called 'black list' metals because they are the most ecotoxic. Fortunately the emissions are very low and are approaching the limits of detection of normal analytical methods. It is likely that the primary source of these metals is sulphuric acid rather than titaniferous ore.

It is believed that they are not affected by normal effluent treatment. To give these values a perspective, on average there is less than one gram emitted for every tonne of TiO<sub>2</sub> produced.

**Other Metals (Mn, V, Ti, Zn, Cr, Pb, Ni, Cu, As):** These are included to ensure that there is a perspective on all potentially harmful emissions. In general, the concentration of these ions (like iron and sulphate) is dependent on the source of the ore and the extent of the effluent treatment.

### 3.3.3.4.2 Finishing

Suspended solids (insoluble TiO<sub>2</sub>) are the only significant emission to water, which are included in the last column of the Table 3.47 above.

### 3.3.3.5 Solid wastes

#### 3.3.3.5.1 Clarification and crystallisation

The unit quantity of neutralised digester residue is primarily a function of the unsulphateable impurity content of the feedstock. This is usually mainly a function of the silica content. Data on waste to land relating to neutralised digester residue are given in Table 3.48.

Waste to land	
Treatment method	Neutralisation with lime
Emitted substance	Neutralised residue
kg per t TiO <sub>2</sub> (average)	307
kg per t TiO <sub>2</sub> (max)	420
kg per t TiO <sub>2</sub> (min)	180

**Table 3.48: Waste to land from the digester residue (for TiO<sub>2</sub> production via the sulphate process) [20, CEFIC-TDMA, 2004]**

#### 3.3.3.5.2 Abatement systems for aqueous emissions from the sulphate process

Wastes to land mainly from the neutralisation of aqueous emissions from the sulphate process are given in Table 3.49.

Wastes to land					
Treatment		Neutralisation limestone/lime	Neutralisation limestone	Roaster	Neutralisation limestone
Emitted	Neutralised residue	Red gypsum	White gypsum	Roasted filter salts	Neutralised filter salts
kg/t TiO <sub>2</sub> (average)	117	3849	0	196	1327
kg/t TiO <sub>2</sub> (max)		6918	0		
kg/t TiO <sub>2</sub> (min)		1113	0		

**Table 3.49: Wastes to land from the neutralisation of aqueous emissions, the sulphate process [20, CEFIC-TDMA, 2004]**

This is a complex situation since, in the short to medium term, the amount of waste disposed to land is a function of a number of different factors:

- the effluent treatment process
- the success of the co-product marketing strategy, and in some cases
- commitments to landfill contracts.

Looking at the data for each substance:

**Red gypsum:** The range of tonnage here is dependent on a number of factors connected with the feedstock type and its mode of processing as indicated above in the section on acid usage. However, it is also dependent on the success that any site has on marketing it as a co-product. In some geographical areas, where there are old quarries that need to be filled with inert material, there may be a strong demand for red gypsum and the tonnage disposed to landfill could be substantially reduced or even eliminated.

**White gypsum:** It can be seen that the quantities disposed of to land are zero. This is because it is all used as a commercial co-product for the production of plasterboard.

**Roasted filter salts:** Data from one site.

**Neutralised filter salts:** Data from one site.

### 3.3.3.6 Environmental performance – Grimsby Works 2002

The purpose of this case study is to help bridge the gap after 1999 when the original performance data was collected.

The year 2002 was the first full one of operation on the new Combined Heat and Power (CHP) plant [86, The Council of the EU, 2004] and the new sulphuric acid import facility. This major restructuring of the energy supply to the site and the source of a critical raw material achieved all of its key objectives, primarily in making a massive reduction in emissions from the site, and also in simplifying the operation and improving business performance at the site.

Figure 3.6 gives the overall production balance for 2002 in Grimsby, illustrating major inputs and outputs from the titanium dioxide production process based on the sulphate process route.

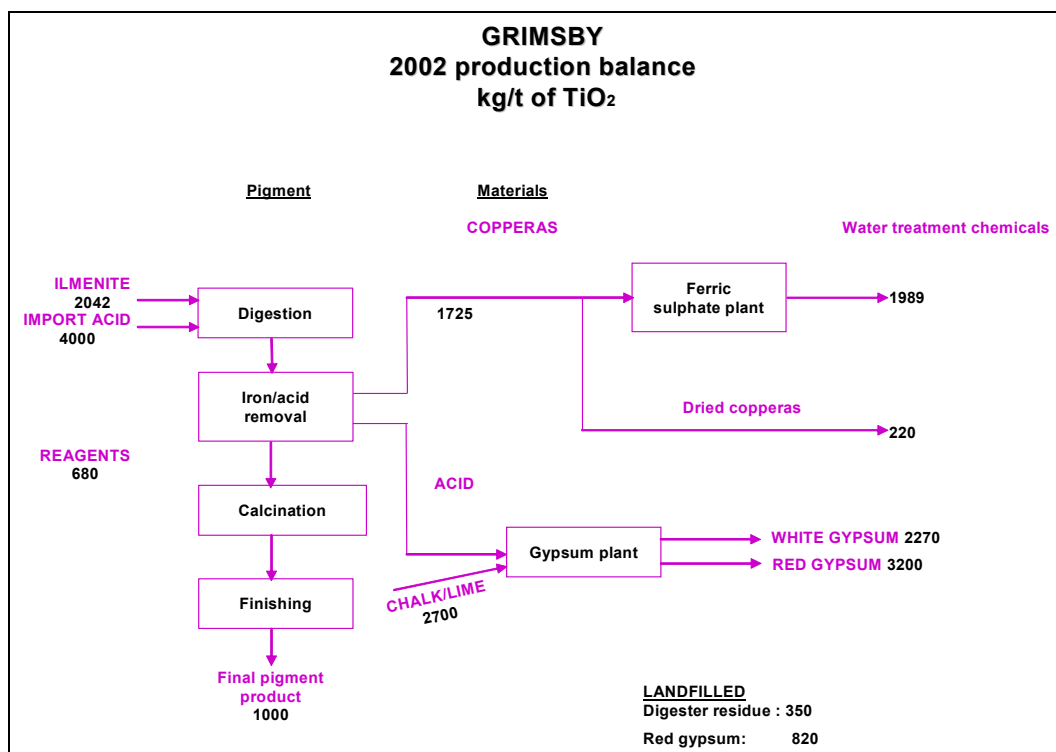


Figure 3.6: Main raw materials inputs and production outputs – the Grimsby site, 2002 [20, CEFIC-TDMA, 2004]

#### Emissions inventory

In the 2001 site report, major reductions in the emissions of SO<sub>x</sub>, NO<sub>x</sub> and particulates were predicted as a result of the combined heat and power and the sulphuric acid import projects. These allowed the closure and decommissioning of the on-site boiler plant and acid production plants – the major sources of these emissions. The first year of full operation of these two projects has fully demonstrated these reductions, as follows:

#### Sulphur oxides

The overall site emission of sulphur oxides, SO<sub>x</sub>, decreased by 84 % during 2002. These improvements are only the latest in a series of Grimsby Works initiatives to reduce SO<sub>x</sub> emissions since the early 1990s. Pigment calcination now accounts for over 99 % of all SO<sub>x</sub> released from the site.

#### Nitrogen oxides

The overall site emission of nitrogen oxides (NO<sub>x</sub>) decreased by 89 % during 2002. This was due to the closure of the boiler plant and the decommissioning of the original gas turbines at the gypsum plant. Again, pigment calcination is now the largest source of NO<sub>x</sub> emissions – 77 % of the total.

### Hydrogen chloride (HCl)

The two site sources of HCl are the dilution of titanium tetrachloride and the preparation of TiO<sub>2</sub> nuclei (by reacting sodium hydroxide with dilute titanium tetrachloride). Both areas now have new scrubbing systems. The upgraded scrubber at titanium tetrachloride dilution was commissioned in 2002 and the total site HCl emissions have now been reduced from 2 tonnes in 2001 to 8 kilograms in 2002.

### Carbon dioxide (CO<sub>2</sub>)

The on-site emissions of carbon dioxide (CO<sub>2</sub>), the main contributor to global warming, showed a decrease of 44 % in 2002. This CO<sub>2</sub> originates from fuel use and as a by-product from the neutralisation of acidic waste streams to form gypsum.

Carbon dioxide emissions associated with the TiO<sub>2</sub> production in the Grimsby Works in the period between 1997 – 2002 are illustrated in Figure 3.7.

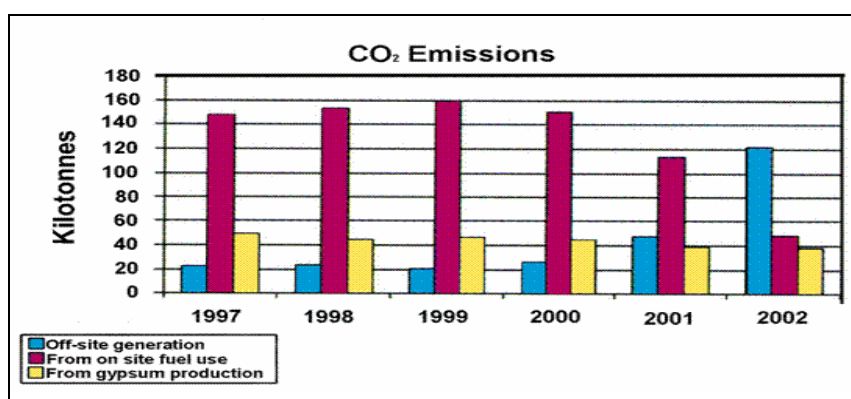


Figure 3.7: CO<sub>2</sub> emissions related to TiO<sub>2</sub> production in the Grimsby Works, the sulphate process [20, CEFIC-TDMA, 2004]

### Carbon monoxide (CO)

Carbon monoxide (CO) emissions have fallen by 91 %. The only significant source on-site is now the white gypsum dryer.

### Particulates (dust/droplets)

There was a reduction of 67 % from 2001 in the amount of particulates released. There are many emission points that contribute to this total such as ilmenite milling, pigment drying and pigment milling. The largest source had been incomplete combustion of heavy fuel oil in the site boiler plant. With the boiler plant decommissioned, the particulate emissions have dropped significantly. During 2002, several projects to reduce droplet emissions were completed.

### Liquid effluent emissions

The reduction in these emissions was achieved by increased treatment (neutralisation) of plant effluent streams. The site has set a target for 2003 to consolidate the sulphate discharge at this figure and has set daily/weekly limits on the concentrations of a number of species in liquid effluent mainly acid, solids and metals.

Liquid effluent sulphate concentration in the Grimsby Works in the period of 1995 – 2002 is illustrated in Figure 3.8.

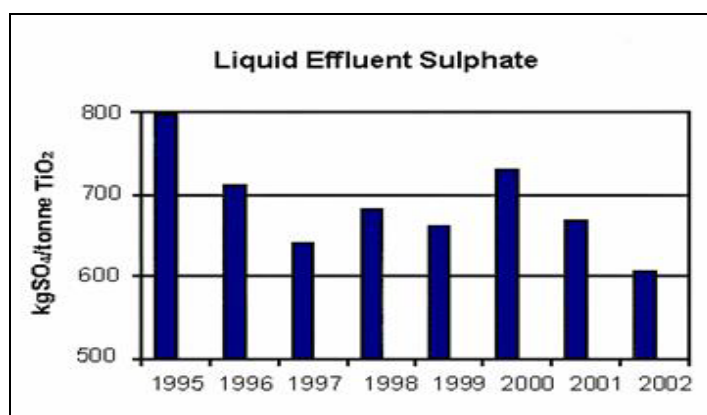


Figure 3.8: Liquid effluent sulphate load from TiO<sub>2</sub> production via the sulphate route in Grimsby Works [20, CEFIC-TDMA, 2004]

### Non-renewable resources

This area continues to be the focus of much attention. During 2002, the enormous benefits to the site in reduced unit energy consumption due to CHP plant operation have been realised. The site has also been able to set a new water consumption baseline for the new plant set up.

The site achieved a reduction of 18.7 % (over the 2000 baseline) in unit energy consumption. This puts the site in a very strong position to meet its objective of a 25 % reduction in unit energy consumption by the end of 2005. Unit energy consumption for 2000 – 2002 for the TiO<sub>2</sub> production at the Grimsby Works is illustrated in Figure 3.9.

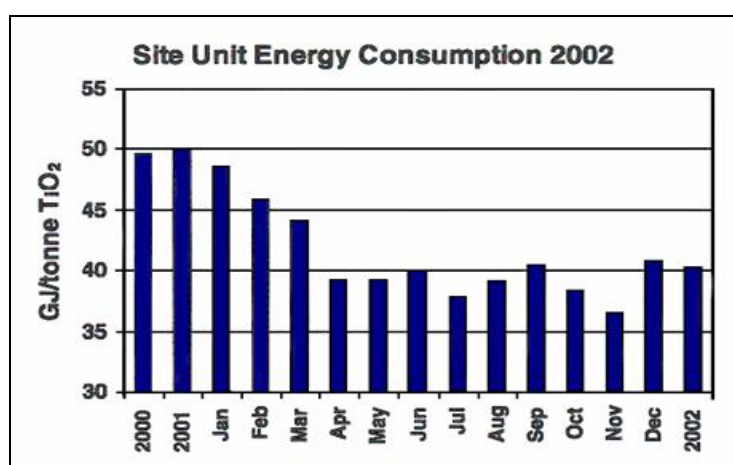


Figure 3.9: Unit energy consumption from TiO<sub>2</sub> production via the sulphate route in Grimsby Works [20, CEFIC-TDMA, 2004]

### Water usage

The total site water consumption was 6.13 million m<sup>3</sup> per year. This is a very small (2 %) overall increase from 2001. However, the unit water usage fell by 13 % from 115.9 m<sup>3</sup>/tonne TiO<sub>2</sub> to 100.4 m<sup>3</sup>/tonne TiO<sub>2</sub>.

### Increased level of acid recycling

The acid recycling figure for 2002 was 8.0 % which achieved the target. The target in 2003 was based on an acid/ilmenite ceiling in order to control sulphate input to site.

Detailed annual emissions 2002 in the Grimsby Works (in kg/tonne TiO<sub>2</sub> pigment) are given in Table 3.50.



	1999 kg/t TiO <sub>2</sub>	2000 kg/t TiO <sub>2</sub>	2001 kg/t TiO <sub>2</sub>	2002 kg/t TiO <sub>2</sub>
<b>Discharges to water</b>				
SO <sub>4</sub> total	630	689	619	591
H <sub>2</sub> SO <sub>4</sub>	152	169	149	170
Fe	159	174	143	136
Solids	41	36	30	59
Ti	6	6	5	6
Mn	7	8	7	7
V	0.23	0.30	0.26	0.20
Zn	0.17	0.25	0.17	0.18
Cr	0.08	0.11	0.11	0.08
Pb <sup>(b)</sup>	0.009	0.009	0.010	0.009
Cu	0.020	0.022	0.022	0.020
Ni	0.023	0.028	0.011	0.013
As	0.003	0.001	0.001	0.001
Cd	0.0003	0.0004	0.0002	0.0004
Hg <sup>(c)</sup>	0.00002	0.00001	0.00001	0.00003
<b>Emissions to air</b>				
SO <sub>x</sub> total	37.9	38.1	33.4	0.0
SO <sub>x</sub> TiO <sub>2</sub>	7.7			4.7
Particulates	1.9	2.5	2.2	0.7
NO <sub>x</sub>	6.0	5.8	5.2	0.5
HCl	0.0	0.0	0.0	0.0
CO	0.8	0.8	0.6	0.0
CO <sub>2</sub> (from off-site generation) <sup>(d)</sup>	306	401	872	1979
CO <sub>2</sub> (from fuel) <sup>(d)</sup>	2328	2363	2083	778
CO <sub>2</sub> (from the gypsum plant)	673	699	713	616
<b>Wastes to land</b>				
Gypsum	1329	1512	1586	819
Neutralised digester residue	303	352	360	348
Misc. industrial wastes	52	155	70	55
Misc. hazardous wastes <sup>(a)</sup>	4	9	9	7
Recycled waste	15	41	21	28
<b>Energy usage</b>				
GJ	41	43	42	40

1GJ=1 x 10<sup>9</sup> Joules or approximately 278 kWh. Energy use was calculated by converting total site energy consumption in kWh (for electricity and fuel) to GJ by conversion factors (at 34 % conversion efficiency). Data for 1992 to 1997 are available in the 1998 Grimsby site report.

(a) Special waste including acid plant catalyst, solvents, oils and greases.

(b) The concentration of lead in the effluent has been reported as less than the analytical instrument level of detection. Since 1994, the mass emissions have been recalculated using a standard detection limit figure for each year. There has been no change in detectable lead concentrations.

(c) Mercury emissions calculated from external Environment Agency analyses that have lower limits of detection than Huntsman Tioxide methods.

(d) Calculated using new factors proposed by the Chemical Industries Association for current Climate Change Levy reporting.

**Table 3.50: Detailed annual emissions 2002 in Grimsby Works, the sulphate process [20, CEFIC-TDMA, 2004]**

### 3.3.4 Techniques to consider in the determination of BAT – the sulphate process

This section sets out techniques considered generally to have potential for achieving a high level of environmental protection in the industries within the scope of the document. Management systems, process-integrated techniques and end-of-pipe measures are included, but a certain amount of overlap exists between these three when seeking the optimum results.

Prevention, control, minimisation and recycling procedures are considered as well as the re-use of materials and energy.

Techniques may be presented singly or as combinations to achieve the objectives of IPPC. Annex IV to the Directive lists a number of general considerations to be taken into account when determining BAT and techniques within this section will address one or more of these considerations. As far as possible a standard structure is used to outline each technique, to enable comparison of techniques and an objective assessment against the definition of BAT given in the Directive.

The content of this section is not an exhaustive list of techniques and others may exist or be developed which may be equally valid within the framework of BAT. Generally a standard structure is used to outline each technique, as shown in Table 3.51:

Type of information considered	Type of information included
Description	Technical description of the technique
Achieved environmental benefits	Main environmental impact(s) to be addressed by the technique (process or abatement), including emission values achieved and efficiency performance. Environmental benefits of the technique in comparison with others
Cross-media effects	Any side-effects and disadvantages caused by implementation of the technique. Details on the environmental problems of the technique in comparison with others
Operational data	Performance data on emissions/wastes and consumption (raw materials, water and energy). Any other useful information on how to operate, maintain and control the technique, including safety aspects, operability constraints of the technique, output quality, etc.
Applicability	Consideration of the factors involved in applying and retrofitting the technique (e.g. space availability, process specific)
Economics	Information on costs (investment and operation) and any possible savings (e.g. reduced raw material consumption, waste charges) also as related to the capacity of the technique
Driving force for implementation	Reasons for implementation of the technique (e.g. other legislation, improvement in production quality)
Example plants	Reference to a plant where the technique is reported to be used
Reference literature	Literature for more detailed information on the technique

**Table 3.51: Information breakdown for each technique described in this section**

Reference is to be made here also to Section 8.9, providing key information on the Environmental Management System (EMS) which is a tool for IPPC installations that operators can use to address the design, construction, maintenance, operation and decommissioning issues in a systematic demonstrable way.

Techniques broadly applicable in the chemical industry, described in the BREF on Common Waste Water and Waste gas Treatment/Management Systems in the Chemical Sector, are not included in this section (refer to the BREF on CWW).

### 3.3.4.1 Raw material choice from import

#### Description

The general principle of choosing ores with as low as practical impurities is advisable. The choice of slag or ilmenite at one level is an LCA question (refer to Section 3.4.5), however, once this basic choice is made, and it is optimally made before starting the investment in a new plant, as it usually fixes the long term co-product marketing strategy. Typically there is limited chance to switch from ilmenite to slag or vice versa, because of capacity reasons, co-product management or availability of acid feed of different concentrations. However it is possible to use a blend of ilmenite and slag (refer to Section 3.3.3.1.1), or to digest ilmenite and slag separately combining the resulting liquor, but only within narrow limits.

### Achieved environmental benefits

The choice of titaniferous ores with a low content of impurities results in the minimisation of wastes released from TiO<sub>2</sub> production on the environment. At the TiO<sub>2</sub> production site, the use of slag gives rise to less waste from TiO<sub>2</sub> production. However, some TiO<sub>2</sub> producers are able to find uses for these 'waste' streams. In order to assess the impact on the environment as a whole, cross-media effects need to be taken into consideration.

### Cross-media effects

From the point of view of environmental impact at the TiO<sub>2</sub> production site alone, the choice of titanium slag may appear to be a better long term strategy than the choice of ilmenite. However, the more pure the feedstocks for the production of TiO<sub>2</sub> (e.g. titanium slag), the more energy needed for the beneficiation of titaniferous raw materials and the more wastes generated at the supplier's site (refer to the life cycle assessment in Section 3.4.5).

### Operational data

No detailed data submitted, in particular with regard to processing blends of slag and ilmenite, but since the cost of titanium slag is much higher than that of ilmenite, a thorough analysis of the material and energy efficiency of the process, including an overall assessment of the impact on the environment, and a detailed calculation of the manufacturing cost need to be carried out prior to any long term strategic decisions, e.g. revamping of the plant or a new TiO<sub>2</sub> plant built at the site.

### Applicability

The choice of feedstock is applicable to all producers of TiO<sub>2</sub> pigments (in total in the EU-25, nine producers, 19 sites and 20 plants – see Table 3.5). It should be stressed that this technique is applicable, however, to some extent (as natural rutile is currently a very scarce raw material and the operators of the plants based on the chloride process use mostly synthetic rutile), to both the sulphate and chloride process routes.

### Economics

No detailed data submitted apart from the LCA study included in Section 3.4.5.

### Driving force for implementation

Decreased usage of energy and reduced impact on the environment at the TiO<sub>2</sub> producing site, counterbalanced by the higher prices of the upgraded titaniferous raw materials. This is a complex issue, and many factors should be considered, as indicated by the LCA.

### Example plants

Fifteen European TiO<sub>2</sub> plants based on the sulphate process route, using either ilmenite or titanium slag or the blend of both (see Table 3.5).

### Reference literature

[20, CEFIC-TDMA, 2004], [25, D.G. Heath, 1996], [26, EIPPCB, 2003], [70, Environment Agency, 1999], [21, The Council of the EU, 1992], [24, Tiioxide Group Ltd, 1995], [42, UBA-Germany, 2001], [48, W. Buchner et al, 1989], [85, EIPPCB, 2004-2005].

### 3.3.4.2 Raw material preparation

#### Description

The ore needs to be in a dry state and with a low moisture content prior to processing. Ensuring that the ore is delivered to the site in a dry state may require collaboration with upstream suppliers and those who transport and handle the ore. Covered storage prevents wetting of the ore by rain. The ore is ground before further processing and, therefore, it cannot be wet, as the performance of the grinding section would then drop substantially, bottlenecking the TiO<sub>2</sub> production process. Also, the excessive content of moisture in the ore (ilmenite, titanium slag) may cause a warming-up and a premature reaction during the mixing of the ore with sulphuric acid in the digestion section (refer to Section 3.3.4.3). Therefore, if the ore becomes wet in transit, it must be dried before further processing, and this entails the use of energy with associated emissions of combustion products. Milling ilmenite to an optimum size maximises the efficiency of sulphation and, therefore, saves resources. In ore preparation, dust emissions are best controlled using high integrity bag filters with appropriate filter cloth material and a maintenance routine to minimise dust emissions.

#### Achieved environmental benefits

Less energy required for drying (and grinding) the titanium ore delivered with a low moisture content and, therefore, less CO<sub>2</sub>, SO<sub>x</sub> and NO<sub>x</sub> emissions, that would otherwise result from the generation of an additional amount of energy required for drying more humid ore.

#### Cross-media effects

Increased amounts of dust may be expected when the titaniferous ore is handled in a dry state.

#### Operational data

The ore (ilmenite, titanium slag) is dried to a humidity content of <0.1 % [42, UBA-Germany, 2001]. Dust and NO<sub>x</sub> emission levels are as presented in Section 3.3.3.1. Specific emissions of dust to air are in the range of 0.0002 to 0.08 kg/t TiO<sub>2</sub> [20, CEFIC-TDMA, 2004], the maximum emissions of dust to air being reported at the level of 4 kg/t TiO<sub>2</sub> [42, UBA-Germany, 2001]. Specific emissions of NO<sub>x</sub> to air are in the range of 0.002 to 0.04 kg/t TiO<sub>2</sub> [20, CEFIC-TDMA, 2004].

#### Applicability

This technique is applicable to all TiO<sub>2</sub> plants using the sulphate process route.

#### Economics

No data submitted.

#### Driving force for implementation

Reduced emissions from drying. Better performance of the grinding section. Controlled reaction in the digestion section.

#### Example plants

Titanium dioxide plant in Grimsby, UK.

Titanium dioxide plants in Leverkusen (sulphate process route), Nordenham, Uerdingen, and Duisburg, which are all in Germany.

#### Reference literature

[20, CEFIC-TDMA, 2004], [42, UBA-Germany, 2001], [26, EIPPCB, 2003].

### 3.3.4.3 Digestion of the ore

#### Description

In the batch digestion process, the ground titaniferous material reacts with sulphuric acid, normally to 80 – 95 %. However, different streams of sulphuric acid are used, with concentrations from 70 %, through 80 %, to 96 %. The concentration of the added acid varies between 92 and 106 % [20, CEFIC-TDMA, 2004], [42, UBA-Germany, 2001].

After achieving the required temperature, the cake has to ripen for 1 – 12 hours, depending on the raw material used, in order to reach the highest possible yield. During the digestion of titaniferous ore, off-gases are generated. These off-gases contain  $\text{SO}_2$  and  $\text{H}_2\text{S}$ . The batch system is connected to a high efficiency scrubbing system, in which off-gases are treated before being released to the atmosphere. The cake obtained by digestion of the ore in sulphuric acid is then dissolved in cold water or diluted acid in temperatures below  $85^\circ\text{C}$ , in order to avoid a premature hydrolysis. The  $\text{TiO}_2$  concentration in the obtained solution lies between 8 – 12 % (ilmenite digestion) and 13 – 18 % (titanium slag decomposition).

It should be noted that there is a large amount of expertise within the industry in optimising the batch process for maximum efficiency where several interdependent processing variables have to be set for every new ore import (e.g. ore fineness, acid concentration and batch time, linked with balances between concentrated, recycled and fresh sulphuric acid). Maximising the proportion of recycled sulphuric acid used is generally a good principle. If the recycled acid is too dilute, the chemical efficiency of digestion is lost. Digestion is a virtually unique process and the operators need to keep all the conditions for any particular ore or ore blend stable to ensure maximum chemical reaction efficiency. Also, it is necessary to obtain a cake texture that is capable of easy solubility. High efficiency digestion is almost a unique process because it involves heating a concentrated slurry (to initiate an exothermic reaction) that changes to a solid state, and then the last vital stages of conversion of the titanium atoms into a soluble matrix occur in the solid state. Experiential skill in the batch digestion of the ore has been developed over many years of operation. Failed digester batches pose a very high burden on the plant's disposal and effluent treatment systems.

### Achieved environmental benefits

The batch process of decomposing ilmenite (or titanium slag) is of key importance for achieving a high yield of the titanium content in the ore to titanyl sulphate ( $\text{TiOSO}_4$ ), and then to  $\text{TiO}_2$  in the solution, which determines a high overall efficiency of the process, and contributes to reducing the impact of  $\text{TiO}_2$  production on the environment. Also, diluted sulphuric acid can be reconcentrated in the process and recycled to the digestion section, thus reducing the usage of concentrated sulphuric acid (92 – 96 %  $\text{H}_2\text{SO}_4$ , used for the digestion of ilmenite) or oleum (104 - 106 %  $\text{H}_2\text{SO}_4$ , used for the digestion of titanium slag).

### Cross-media effects

No information submitted.

### Operational data

For information on off-gas treatment from digestion refer to Section 3.3.4.10.1. Data on waste to land relating to neutralised digester residue are given in Table 3.48 (the range of waste to land being reported between 180 – 420 kg/t  $\text{TiO}_2$ , with the average figure of 307 kg/t  $\text{TiO}_2$ ). Data on waste to land relating to neutralised digester residue in Grimsby Works in the period between 1999 and 2002 are given in Table 3.50. In turn, specific volumes of digester residues reported are in the range between 340 – 670 kg/t  $\text{TiO}_2$  produced.

Although seemingly there appears to be no significant environmental differences between batch and continuous digestion (which is only applicable with ilmenite as a feedstock), continuous digestion has been tried, but it is unlikely that it can achieve the chemical efficiency of the batch process and, therefore, the batch digestion system is considered a key technique applied in the sulphate process (refer also to Section 9.3.2.1).

### Applicability

Applicable to all  $\text{TiO}_2$  plants using the sulphate process route.

### Economics

No data submitted.

### Driving force for implementation

High overall efficiency of the sulphate process.

#### Example plants

Titanium dioxide plant in Grimsby, UK.

Titanium dioxide plants in Leverkusen (sulphate process route), Nordenham, Uerdingen, and Duisburg, which are all in Germany.

#### Reference literature

[20, CEFIC-TDMA, 2004], [42, UBA-Germany, 2001], [26, EIPPCB, 2003], [85, EIPPCB, 2004-2005].

### **3.3.4.4 Reduction**

#### Description

When the primary ore is ilmenite (or a blend of slag with ilmenite) the digester liquor is contacted with scrap iron chips or a  $Ti^{3+}$  solution in order to convert ferric ions ( $Fe^{3+}$ ) to ferrous ions ( $Fe^{2+}$ ), otherwise the iron would remain with the  $TiO_2$  throughout all subsequent processing stages. The technique, applied particularly to prevent the precipitation of the  $Fe^{3+}$  ions during the hydrolysis, involves setting the reduction level (as  $Ti^{3+}$ ) so that a small excess of this component is maintained through the filtration and washing stages. A custom built system that allows efficient contact between the liquor and the iron and easy removal of any non-iron materials is typically used in the reduction section. Waste iron products can be used with obvious environmental advantages. As mentioned in Section 3.3.2.3, appropriate and clean scrap iron only can be used. The scrap must be free of contaminants.

#### Achieved environmental benefits

Usage of waste scrap iron, which is later crystallised out and recovered in the form of iron sulphate heptahydrate (copperas, used for waste water treatment or iron oxide, used as a pigment – see Section 7.5).

#### Cross-media effects

The process generates small amounts of gaseous hydrogen, which should be dealt with properly to prevent the risk of explosion.

#### Operational data

Reported emissions of hydrogen are in the range between 0 – 2 kg per tonne of  $TiO_2$  produced. Usage of scrap iron is in the range between 127 to 250 kg/t  $TiO_2$ .

Even though the quantities involved limit the risk well within the boundary of the plant area (hydrogen is instantly dispersed in air and, therefore, the explosion risk is extremely low), the equipment should be designed to work in a flammable atmosphere and proper venting of the building is required.

#### Applicability

Applicable to all plants based on the sulphate process route which use ilmenite, as well as to plants using a blend of slag with ilmenite, which also use scrap iron dosage.

It is noted that one plant blends liquor from slag digestion with the unreduced liquor of ilmenite digestion and thus uses no scrap iron.

#### Economics

No data submitted.

#### Driving force for implementation

Performance of the sulphate process, when ilmenite is a raw material.

#### Example plants

Titanium dioxide plant in Grimsby, UK.

### Reference literature

[20, CEFIC-TDMA, 2004], [42, UBA-Germany, 2001], [26, EIPPCB, 2003], [85, EIPPCB, 2004-2005].

### **3.3.4.5 Clarification and crystallisation**

#### Description

After the reduction of ferric ions ( $\text{Fe}^{3+}$ ) to ferrous ions ( $\text{Fe}^{2+}$ ) in the solution of titanyl sulphate, two operations need to be performed: the removal of suspended materials from the solution by flocculation and filtration (clarification of the titanyl sulphate solution), followed by the crystallisation and removal of iron sulphate heptahydrate.

The disposal route for the solids must be looked at carefully since the options available are usually dictated by the impurity content and type. In the clarification section, all insoluble solids are separated from the solution by flocculation and filtration. The solid residue is neutralised with lime or limestone and, in most cases, is sent to landfill, as there is only a very limited market for this residue as a co-product. Normal practice is to have a system that allows efficient separation of the flocculated solids and it is necessary to optimise the system for particular ore feedstocks. It should be noted that stable liquor is a prerequisite for an efficient operation. The use of pressure filters for the dewatering of digester residue is considered.

After the removal of all insoluble solids, the solution contains 5 – 6 %  $\text{FeSO}_4$  in the case of processing titanium slag and 15 – 20 %  $\text{FeSO}_4$  in the case of processing ilmenite and ilmenite enriched with slag, and in the latter case, iron sulphate heptahydrate ( $\text{FeSO}_4 \cdot 7\text{H}_2\text{O}$ ), i.e. copperas, is crystallised by vacuum cooling in the crystallisation section.

The separation of copperas is the most environmentally efficient way of removing iron, especially as there is an internationally established market for copperas, particularly for the manufacture of water treatment chemicals (refer to Section 7.5). For ilmenite liquors, various crystallisation arrangements are possible. Normally the objective is to maximise the removal of copperas. There are no significant environmental differences reported between batch and continuous centrifuges (crystallisers), however, the latter can be very difficult to commission and optimise to give maximum separation efficiency.

#### Achieved environmental benefits

The major environmental benefit in this section is the removal of iron from the process in the form of copperas (iron sulphate heptahydrate), which can be subsequently used for waste water treatment or, after salt roasting, converted into iron oxide ( $\text{Fe}_2\text{O}_3$ ), which then finds applications as an iron oxide pigment. Copperas production is an environmentally benign process since every tonne that is produced and used relieves the need for subsequent treatment of the main  $\text{TiO}_2$  plant effluent.

#### Cross-media effects

As there is a very limited market for the insoluble solids originating from the clarification section, the neutralised solids are typically landfilled. Waste to land varies in the range between 180 - 420 kg per tonne of  $\text{TiO}_2$  produced. In the case of copperas roasting to  $\text{Fe}_2\text{O}_3$  in a downstream unit, the emission of gaseous  $\text{SO}_2$  has an additional negative effect, however, the  $\text{SO}_2$  gas can be used for the production of sulphuric acid at the same site.

#### Operational data

No detailed data submitted. Refer to Section 7.5 on 'Copperas and related products'. The major EU-15 producers of ferrous sulphate heptahydrate are listed in Table 7.17. The combined EU-15 production capacity of the ferrous sulphate heptahydrate amounts to over 1.1 million tonnes per year.

#### Applicability

Applicable particularly to the plants based on the sulphate process route which use ilmenite.

Economics

No data submitted.

Driving force for implementation

The separation of copperas (by crystallisation), allows for increasing the concentration of  $\text{TiO}_2$  in the solution, and hence for a higher efficiency of  $\text{TiO}_2$  production by the sulphate process route. The higher the process efficiency, the lesser the impact on the environment. In turn, the use of copperas, not only directly reduces the impact of  $\text{TiO}_2$  production on the environment, but also allows for the manufacture of valuable by-products (value added).

Example plants

Titanium dioxide plant in Grimsby, UK.

Titanium dioxide plant in Prerov, Czech Republic.

Reference literature

[20, CEFIC-TDMA, 2004], [42, UBA-Germany, 2001], [26, EIPPCB, 2003], [59, CEFIC-TDMA, 2004], [48, W. Buchner et al, 1989], [85, EIPPCB, 2004-2005].

**3.3.4.6 Hydrolysis (hydrate precipitation)**Description

After the crystallisation and removal of iron sulphate heptahydrate, the titanyl sulphate is hydrolysed by heating the clarified solution with steam at 95 to 110 °C. In order to achieve  $\text{TiO}_2$  yields of up to 93 – 96 % and to obtain a hydrolysis product which yields the optimum particle size upon subsequent firing, special nuclei accelerating the precipitation of titanium hydrate are added at the beginning of the hydrolysis.

There are two nucleation systems used. In one, nuclei are created by controlled hydrolysis of titanium tetrachloride. In the other, the seed is produced by reacting  $\text{TiO}_2$  slurry with NaOH and HCl. Changing from one system to another is problematic, because each system has unique characteristics with regard to the control of crystal size distribution. Controlled hydrolysis is one of the key variables in determining final product quality, hence there is considerable risk in incorporating changes which are designed, for example, to reduce energy consumption. Low concentration hydrolysis is one of these options, and the concentration used is usually dependent on the specific final quality requirements and the consistency of the ore feedstock.

Achieved environmental benefits

Apart from the possibility of achieving high  $\text{TiO}_2$  yields of up to 93 – 96 %, which have a direct influence on the overall performance of the plant, no direct impact of this operation on the environment has been reported.

Cross-media effects

No information submitted.

Operational data

No data submitted.

Applicability

Applicable to all  $\text{TiO}_2$  plants using the sulphate process route.

Economics

No detailed data submitted.

Driving force for implementation

High  $\text{TiO}_2$  yields in the process and controlled size and form of the titanium dioxide crystals (anatase or rutile). Only the sulphate process can readily form both crystalline forms of  $\text{TiO}_2$  (anatase and rutile crystals).



### Example plants

Titanium dioxide plant in Grimsby, UK.

Titanium dioxide plants in Leverkusen (sulphate process route), Nordenham, Uerdingen, and Duisburg, which are all in Germany.

### Reference literature

[20, CEFIC-TDMA, 2004], [42, UBA-Germany, 2001], [26, EIPPCB, 2003], [48, W. Buchner et al, 1989], [85, EIPPCB, 2004-2005].

### **3.3.4.7 Filtration and washing**

#### Description

After the hydrolysis, the solution contains 20 – 28 %  $\text{H}_2\text{SO}_4$  and different quantities of dissolved sulphates, depending on the raw material used. The titanium oxide hydrate is separated from the spent sulphuric acid by filtration. There are three possibilities for the utilisation of the spent post-hydrolytic sulphuric acid (refer also to Section 3.3.4.11):

- concentration of the spent acid to approx. 70 – 80 %  $\text{H}_2\text{SO}_4$  and its re-use for the digestion of the titanium ore
- neutralisation of the spent acid with lime, which generates gypsum
- utilisation of the reconcentrated spent acid for the production of fertilisers.

After the separation of the spent acid, the titanium oxide hydrate is washed with water or a weak acid. After washing, the titanium oxide hydrate still contains 5 – 10 %  $\text{H}_2\text{SO}_4$ . In order to obtain required pigment qualities, alkali-metal compounds and other mineralisators are added to the hydrate, which is then normally filtered consecutively in a vacuum filter and press filter, after which the cake with a content between 45 – 50 %  $\text{TiO}_2$  is led into the revolving hearth furnace in the calcination section.

The filtered diluted sulphuric acids are collected in a storage, from where they can be recycled into the process or discharged as waste waters (refer to Section 3.3.4.11). The maximum amount of undiluted strong acid must be separated from the filter cake during washing. This section offers many opportunities to efficiently use different grades of water during the wash cycle. The system requires the sharpest separation of strong and weak acid. Fortunately tried and tested conventional leaf filters allow almost 'plug flow' of the strong acid during the first stage of washing hence achieving this objective. Many other filtration systems have been tried and found wanting. Often it is the sheer size and throughput requirements, which govern the choice of filtration system.

#### Achieved environmental benefits

Proper design and operation of the filtration and washing section has a direct influence on the separation of strong and weak sulphuric acid and, therefore, on the degree of acid recirculation in the process and the amount of waste waters generated in and discharged from the plant to the aquatic environment.

The impact on the environment varies, depending on the option applied for the utilisation of the spent post-hydrolytic sulphuric acid, however, for all options, the spent acid is utilised to a high degree (production of  $\text{TiO}_2$ , production of gypsum plasterboards, and production of fertilisers), thus allowing to significantly reduce the amount of the sulphuric acid discharged to the environment.

#### Cross-media effects

No data submitted.

#### Operational data

For information on the utilisation of the spent sulphuric acid, refer to Section 3.3.4.11.

Applicability

Applicable to all TiO<sub>2</sub> plants using the sulphate process route.

Economics

No detailed data submitted (refer to Section 3.3.4.11).

Driving force for implementation

High degree of separation (and then utilisation) of the spent post-hydrolytic sulphuric acid.

Example plants

Fifteen European TiO<sub>2</sub> plants based on the sulphate process route, using either ilmenite or titanium slag or the blend of both (see Table 3.5).

Reference literature

[20, CEFIC-TDMA, 2004], [42, UBA-Germany, 2001], [26, EIPPCB, 2003], [48, W. Buchner et al, 1989], [85, EIPPCB, 2004-2005].

**3.3.4.8 Calcination**Description

After filtration and washing, the hydrate is calcined in a revolving hearth furnace (calciner). Approximately 2/3 of the entire retention time of 7 – 20 hours is required for the drying process in the calcination section. At a temperature of approx. 500 °C in the revolving hearth furnace, SO<sub>3</sub> gas (originating from the H<sub>2</sub>SO<sub>4</sub> remaining in the cake) is separated, which is partially decomposed into SO<sub>2</sub> and O<sub>2</sub>. The product reaches maximum temperatures of 800 – 1100 °C. Due to the combustion of oil or natural gas in the furnace, the main combustion related gaseous emissions from the calcination section are SO<sub>2</sub> and NO<sub>2</sub>, as well as dust. The temperature of the exhaust gas must be kept above 300 °C, in order to avoid the condensation of the H<sub>2</sub>SO<sub>4</sub> in the gas outlet system, prior to its transfer for treatment either in the off-gas scrubber or catalytic oxidation system, or recycling into the furnace for saving energy. Maximum hot gas recycling is used when technically possible at the site. Systems that minimise energy usage without compromising quality are recommended. These include pressure filters on the feed (in order to increase the TiO<sub>2</sub> content in the cake) and hot gas recycling in the kilns (in order to save energy). For information on the off-gas treatment unit, refer to Section 3.3.4.10.2.

It should be noted that calcination is a unit operation characteristic only to the sulphate process route, and the calcination section does not exist in the chloride process (here, similar functions are performed in the oxidation section).

Achieved environmental benefits

Hot gas recycling used at the site to save energy is the only environmental benefit attributable to the calcination section. This section is, however, fully integrated with the off-gas treatment unit.

Cross-media effects

No data submitted.

Operational data

Refer to Sections 3.3.3.3.5 and 3.3.3.6.

Applicability

Applicable to all TiO<sub>2</sub> plants using the sulphate process route.

Economics

No data submitted on economics in the calcination section. For data on economics of the off-gas treatment, refer to Section 3.3.4.10.2.

Driving force for implementation

The quality of the titanium dioxide pigments (anatase or rutile).

### Example plants

Fifteen European TiO<sub>2</sub> plants based on the sulphate process route, using either ilmenite or titanium slag or the blend of both (see Table 3.5).

### Reference literature

[20, CEFIC-TDMA, 2004], [42, UBA-Germany, 2001], [26, EIPPCB, 2003], [48, W. Buchner et al, 1989], [85, EIPPCB, 2004-2005].

### **3.3.4.9 Finishing**

#### Description

Finishing operations are, in principle, the same in both the sulphate and chloride process routes. The TiO<sub>2</sub> clinker obtained in the calcination section is cooled by air and is then ground. Off-gas containing fine particle TiO<sub>2</sub> dust is filtered in cloth filters, and then discharged into the atmosphere. As follow-up treatment (finishing) additives and water are added, this results in some emissions of sulphates and suspended solids to water.

In the finishing section, the operational technique is to maintain the plant to minimise leakage of TiO<sub>2</sub> to both air and water. It is well known that because of the intrinsic properties of the TiO<sub>2</sub> pigment, this area can be easily covered in brilliant white material. It is expected that in this context the plant is managed to prevent this happening. Spillage control and minimisation of dust emissions are essential. As this is a key area in both energy and water usage, the appropriate discipline and usage objectives must be sustained. Steam milling is essential to ensure the maximum efficiency of pigment usage in downstream applications. Minimising dust and emissions of TiO<sub>2</sub> particles in the liquid effluent is a necessary objective, but since all the equipment is similar regarding these, it is the management and maintenance regimes that are critical here.

Coating is required to maximise the efficiency and lifetime of downstream TiO<sub>2</sub> pigment uses. The use of pressure filters before drying under some circumstances can be considered, however, modern plants have usually opted for spray dryers as these give an excellent textured feed for micronising. Pressure filters can be followed by fluid bed dryers. It is worth noting, that bulk or semi-bulk packaging is best for minimising the use of packaging materials. It is, in principle, recommended, however only customers from large companies have the facilities to handle these containers.

#### Achieved environmental benefits

All major finishing operations, in which dry material is handled, are subject to dedusting, with the TiO<sub>2</sub> dust recycled back into the process.

#### Cross-media effects

No data submitted.

#### Operational data

Specific emissions of dust to air are in the range of 0.002 to 0.390 kg/t TiO<sub>2</sub>. Dust emissions in Germany are reported to be at the levels of 0.002 to 0.12 kg/t TiO<sub>2</sub>. Waste waters containing suspended solids in the range of 0.09 to 41 kg/t TiO<sub>2</sub> are reported. Germany reports the levels of sulphates in the waste waters in the range of 80 to 110 kg/t TiO<sub>2</sub>.

#### Applicability

Applicable to all TiO<sub>2</sub> plants using either the sulphate or chloride process routes.

#### Economics

No data submitted.

#### Driving force for implementation

The quality of various grades of TiO<sub>2</sub> pigments, as required by the final users.

#### Example plants

Twenty European TiO<sub>2</sub> plants, including five plants using the chloride process route and fifteen European TiO<sub>2</sub> plants based on the sulphate process route (see Table 3.5).

#### Reference literature

[20, CEFIC-TDMA, 2004], [42, UBA-Germany, 2001], [26, EIPPCB, 2003], [48, W. Buchner et al, 1989].

### **3.3.4.10 Abatement systems for gaseous emissions – the sulphate process**

This section covers abatement systems for gaseous emissions encountered in two main sections of the sulphate process route, namely the digestion section (see Section 3.3.4.10.1 below) and the calcination section (see Section 3.3.4.10.2 below). Dust emissions from the raw material preparation section and from the finishing section are covered in Sections 3.3.4.2 and 3.3.4.9 respectively.

#### **3.3.4.10.1 Off-gas treatment from the digestion section**

##### Description

Because of the specific nature of these systems, management must be focused on sustaining maximum efficiency. This can be problematic since the scrubbing system must cope with a very wide range of flows. The industry has installed custom built scrubbers designed to operate at the necessary very wide turn down. The modern systems are designed with energy and water saving in mind. There appears to be no significant differences between the following systems (depending on the local situation), as in some sites the off-gas treatment system from the ore digestion section is interconnected with that from the calcination section – see Section 3.3.4.10.2.

First, off-gases are scrubbed with recycled waste water (this system is only applicable if the feedstock is solely ilmenite). The outcoming wash-water has to be treated in an appropriate way.

Secondly, off-gases are quenched and then scrubbed with caustic soda solution. The resulting solution contains Na<sub>2</sub>SO<sub>4</sub>, NaHSO<sub>3</sub>, Na<sub>2</sub>S, and is decomposed with sulphuric acid to produce SO<sub>2</sub> and S going as a feed to the acid plant; the resulting small amounts of Na<sub>2</sub>SO<sub>4</sub> solution is discharged. This system is only applicable if there is the possibility to use the SO<sub>2</sub> and S as a feedstock for other processes on the site.

Thirdly, off-gases are quenched and then scrubbed with caustic soda solution. Scrubbed caustic soda solution, after oxidation of NaHSO<sub>3</sub>, is released to the sewerage system, and then it is sent to the waste water treatment plant located at the site.

Finally, off-gases are quenched, then passed through an electrostatic precipitator (removing SO<sub>3</sub> aerosols), followed by the removal of SO<sub>2</sub> via oxidation with aqueous H<sub>2</sub>O<sub>2</sub> to produce sulphuric acid which is re-used, and finally removing H<sub>2</sub>S by absorption in an aqueous suspension of ZnO, which is used as a feedstock for the production of Zn containing pigments at the same site. This is a patented waste free system but is only viable if there is a zinc based chemical business adjacent to the TiO<sub>2</sub> plant.

##### Achieved environmental benefits

Reduction of SO<sub>2</sub> and H<sub>2</sub>S emissions from the sulphate process.

Cross-media effects

No data submitted. Possible integration with the adjacent sulphuric acid plant.

Operational data

Specific emissions of SO<sub>2</sub> to air are in the range of 0.00 (ilmenite) to 1.91 kg/t TiO<sub>2</sub> (titanium slag) [20, CEFIC-TDMA, 2004], the maximum emission of SO<sub>2</sub> in Germany being reported at the level of 0.119 kg/t TiO<sub>2</sub> [42, UBA-Germany, 2001]. Specific emissions of H<sub>2</sub>S to air are in the range of 0.000 to 0.010 kg/t TiO<sub>2</sub> [20, CEFIC-TDMA, 2004].

Gaseous emissions treatment performance and costs for digestion are given in Table 3.52 below.

Digestion	Slag	Ilmenite	Digestion	Slag	Ilmenite
kg/t			Site	Calais Scarline Le Havre	Grimsby Huelva Pori Leverkusen Nordenham Fredrikstad Thann Prerov
SO <sub>2</sub>	1	0.2			
H <sub>2</sub> S	0.01	0			
Costs: EUR/t					
Capital +/- 30 %	85	75			
Treatment	10	5			
Note: No data available for the sites using blends of slag and ilmenite.					

**Table 3.52: Gaseous emissions treatment performance/costs – digestion, the sulphate process [20, CEFIC-TDMA, 2004]**

Applicability

Applicable to all TiO<sub>2</sub> plants using the sulphate process route.

Economics

As in Table 3.52 above.

Driving force for implementation

Minimisation of the impact of the production of TiO<sub>2</sub> on the environment.

Example plants

Titanium dioxide plant in Grimsby, UK.

Reference literature

[20, CEFIC-TDMA, 2004], [42, UBA-Germany, 2001], [26, EIPPCB, 2003], [85, EIPPCB, 2004-2005].

**3.3.4.10.2 Gaseous effluent treatment from the calcination section**

Description

The following techniques used for gas treatment are generally considered now to be standard throughout the industry:

- dust is removed by scrubbing and then it is recycled
- SO<sub>3</sub> is removed by electrostatic precipitators
- the SO<sub>2</sub> component of the gas is catalytically oxidised to SO<sub>3</sub> and absorbed to form sulphuric acid, which in turn is recycled.

There is an issue of economic impact here. The standard equipment for the catalytic oxidation of SO<sub>2</sub> is module based and provided there is the physical space, the number of units fitted is, on one hand, a question of economics and available resources, and on the other, it needs to be sufficient to achieve the statutory SO<sub>2</sub> concentration. In this context, the operational procedure involves keeping the catalyst as uncontaminated as possible by protecting it from dust ingress. Also, a monitoring and maintenance schedule is adopted in which the catalyst is renewed as required. Those sites that have alternative systems for treating the off-gas are organised such to treat it at all times.

There are other options but they are particular to local circumstances. For example, direct absorption of SO<sub>2</sub> in a sulphuric plant can be adopted, but this is only possible if there is a very short distance between the TiO<sub>2</sub> and sulphuric acid plants. A water-based system for the removal of SO<sub>2</sub> is used by one company, which is reported to have similar performance characteristics to the catalytic system. A system for the treatment of off-gas from the calciners is applied in Germany, in which fixed bed active carbon reactors-adsorbers are used, with the aim of keeping the emissions below the German limit value of <0.5 g SO<sub>2</sub>/m<sup>3</sup> [42, UBA-Germany, 2001].

#### Achieved environmental benefits

Reduced emissions of acid mist, dust, SO<sub>2</sub> and NO<sub>2</sub> from the sulphate process.

#### Cross-media effects

No data submitted.

#### Operational data

Gaseous emissions treatment performance and costs for calcination are given in Table 3.53.

Calcination	Catalyst standard	Catalyst high	Scrubbing	Calcination	Catalyst standard	Catalyst high	Scrubbing
Catalyst load*				Site	Calais Scarlino Grimsby Huelva Prerov Pori	Duisburg	Leverkusen Nordenham Fredrikstad
m <sup>3</sup> /t per hour of TiO <sub>2</sub> feed	30 – 50	70 – 90					
kg/t							
SO <sub>2</sub>	8	2	1				
Acid mist	0.8	0.2	0.2				
Dust	0.4	0.004	0.001				
Costs(EUR/t)**							
Capital +/- 30 %	70	140	170				
Treatment	5	10	9				
<p><b>*Definition of catalyst load</b>            Volume of catalyst (V)            TiO<sub>2</sub> feed: t/h (T)            m<sup>3</sup>/t per hour of TiO<sub>2</sub> feed (V/T)</p> <p><b>**Definition of costs</b>            Capital for a new unit (C)            Annual production (P)            Capital (C/P)</p>							

**Table 3.53: Gaseous emissions treatment performance/costs – calcination, the sulphate process [20, CEFIC-TDMA, 2004]**

Acid mist, dust, SO<sub>2</sub> and NO<sub>2</sub> emission levels from calcination are as presented in Section 3.3.3.3.5. Specific emissions of dust to air are in the range of 0.00 to 0.65 kg/t TiO<sub>2</sub> [20, CEFIC-TDMA, 2004]. Specific emissions of SO<sub>2</sub> to air are in the range of 0.01 to as much as 12.10 kg/t TiO<sub>2</sub> (due to high emission levels in one plant in 1999), the average being 3.5 kg/t TiO<sub>2</sub> [20, CEFIC-TDMA, 2004], while the emissions of SO<sub>2</sub> in Germany being reported at the level of 1 kg/t TiO<sub>2</sub> [42, UBA-Germany, 2001]. In turn, the 2002 emissions of SO<sub>2</sub> reported by Grimsby Works are at the level of 4.7 kg/t TiO<sub>2</sub> (see Table 3.50). Specific emissions of NO<sub>2</sub> to air are in the range of 0.04 to 1.20 kg/t TiO<sub>2</sub> [20, CEFIC-TDMA, 2004].

### Applicability

Applicable to all TiO<sub>2</sub> plants using the sulphate process route.

### Economics

Refer to Table 3.53 above.

### Driving force for implementation

Minimisation of the impact of the production of TiO<sub>2</sub> on the environment.

### Example plants

Titanium dioxide plant in Grimsby, UK.

### Reference literature

[20, CEFIC-TDMA, 2004], [46, CEFIC-TDMA, 2001], [42, UBA-Germany, 2001], [26, EIPPCB, 2003], [85, EIPPCB, 2004-2005].

### **3.3.4.11 Abatement systems for aqueous emissions from the sulphate process**

The sulphate process requires 2.4 – 3.5 tonnes of concentrated H<sub>2</sub>SO<sub>4</sub> per one tonne of TiO<sub>2</sub> produced, depending on the raw material used. Sulphuric acid is discharged from the process in the form of sulphates, especially as ferrous sulphate (refer to Sections 3.3.4.5 and 7.5), or as a free sulphuric acid in the form of the spent post-hydrolytic acid. The total volume of the spent acid amounts to approximately 6 – 9 tonnes per one tonne of TiO<sub>2</sub> produced. Therefore, the treatment of the spent acid is one of the most important issues with regard to the impact of the production of TiO<sub>2</sub> by the sulphate process route on the environment [21, The Council of the EU, 1992].

It should be noted, that the load of sulphate (SO<sub>4</sub>) to water is a key prescribed variable in the TiO<sub>2</sub> Harmonisation Directive [21, The Council of the EU, 1992], where the maximum allowable emission level is 800 kg of total sulphate per tonne of TiO<sub>2</sub> produced (corresponding to the SO<sub>4</sub> ions contained in the free sulphuric acid and in the metallic sulphates).

As mentioned in Section 3.3.4.7, there are three possibilities of the utilisation of the spent post-hydrolytic sulphuric acid:

- concentration of the spent acid to approx. 70 – 80 % H<sub>2</sub>SO<sub>4</sub> and its re-use for the digestion of the titanium ore
- neutralisation of the spent acid with lime, which generates gypsum
- utilisation of the reconcentrated spent acid for the production of fertilisers.

Although in options 1 and 3 above, there are different final uses of the recovered sulphuric acid (production of TiO<sub>2</sub> vs. production of fertilisers), in both these options the abatement system for aqueous emissions is based on the concentration of the spent post-hydrolytic sulphuric acid and, therefore, only the following two main options are discussed below:

- acid recycling
- acid neutralisation.

These options are also illustrated in Figure 3.4, Figure 3.5, and Figure 3.6 respectively.

The separation of the sulphates from the spent post-hydrolytic acid, and follow-up thermal decomposition of the sulphates to Fe<sub>2</sub>O<sub>3</sub>, and to SO<sub>2</sub> which is used for the production of H<sub>2</sub>SO<sub>4</sub>, is described in Sections 3.3.4.5 and 7.5.

The operational technique for acid recycling involves, in principle, operating the plant in such a manner that at least all the strong acid produced is treated to achieve the statutory requirements. The quality and rate of the acid produced need to be suitable for maintaining TiO<sub>2</sub> plant production. If filter salts are roasted, then similar constraints apply both in feed rates and SO<sub>2</sub> production that needs to be fed to the sulphuric acid plant. Also, the quality of the cinder produced needs to be satisfactory for its downstream use whether this is for co-products or disposal. In the same way, neutralisation needs to be set up to achieve similar objectives, as both plant throughput and co-product quality are key variables.

The issue of co-product quality often has a profound effect on the operability of the plant since obtaining and sustaining this quality needs the plant design and operation to be optimised to guarantee this quality. With gypsum, particularly where the co-product is used in plasterboard manufacture, it was necessary to carry out a large amount of development work to optimise the properties of gypsum (mainly crystal shape) to enable efficient production of plasterboard. This itself often reflects back on the operation of the mother titanium dioxide plant. It is essential to avoid the situation where these constraints on the two plants are in conflict.

Although landfill is considered to be undesirable as a generalisation it should be said that titanogypsum is an almost ideal landfill material and sometimes local circumstances need quarries, etc. to be reclaimed with an 'inert' material, such as titanogypsum which does not have the disadvantages of most other types of waste products [20, CEFIC-TDMA, 2004].

Both acid recycling and neutralisation, are the methods to be considered for use in the titanium dioxide industry for liquid effluent treatment, provided they are set up to take into account the factors listed in Table 3.54, as the decision of which method to choose is dependent on them:

Treatment method	Acid recycling	Neutralisation
Capital cost	High	Lower
Running costs	+15 %	+15 %
Extra energy consumption	+13.8 GJ/tonne TiO <sub>2</sub>	+2.3 GJ/tonne TiO <sub>2</sub>
Opportunity for an effective local co-products strategy to be developed	Helpful but not essential	Essential
Ore supply		Stable and consistent to maintain co-product quality
Waste disposal	Local facilities helpful	Local facilities essential
Neutralising materials		Local supply required to keep costs down

**Table 3.54: Methods used for liquid effluent treatment, the sulphate process [20, CEFIC-TDMA, 2004]**

Table 3.54 indicates that the choice of treatment is a long term strategic one in which local conditions (commercial, legal, industrial infrastructure, raw materials availability, etc.) will be strongly influential.

It should be added that in various EU countries (e.g. UK and Italy), the usage of red gypsum in agriculture has been accepted by the authorities. In other countries (e.g. Germany), this is not possible. Therefore, different techniques develop, also because of different national legislation applied across the EU-25 [85, EIPPCB, 2004-2005]. Refer also to Section 3.3.4.11.2 below.

The choice between waste acid recycling and waste acid neutralisation, and the decision upon which of the methods is to be applied, will depend on local conditions, including the availability of secondary feedstock (chalk, lime) and market conditions for co-products.

The data on the methods used for acid treatment, illustrating strong and weak effluent treatment costs and performance, are given in Table 3.55.



	Strong + weak acid			
	Acid recycling + roasting	Acid recycling + neutralisation	Neutralisation at pH 7****	Neutralisation at pH9
<b>Water emissions kg/tonne</b>				
Total sulphate as SO <sub>4</sub>	500 <sup>◇</sup>	400	400	300
Fe	8 <sup>◇</sup>	3	3	0.1
<b>Waste to land kg/tonne</b>				
Cinders	0 – 500*			
Neutralised filter salts		0 – 1300		
Red gypsum		0 – 1200*	2000 – 6000**	3000 – 7000**
<b>Cost: EUR/t</b>				
<b>Capital replacement</b>				
Cost +/- 30 %	1800	1200	700	800
Treatment	150	150***	150***	170***
<b>Site</b>	Calais Duisburg Nordenham Leverkusen Uerdingen	Huelva Pori	Grimsby Le Havre	Scarlino Prerov Fredrikstad Thann
* The quantity varies with the local ability to re-use as co-product				
** The quantity of red gypsum produced varies with the white gypsum production, which is sold as a co-product, and on the ability to use red gypsum for land reclaiming				
*** These costs are largely affected by the amount of red gypsum to be landfilled and transport costs from production to land disposal area				
**** Final reactor pH				
◇ In order to achieve lower values of iron and sulphate than is shown here, quite a large amount of energy would have to be involved in evaporating the weak acid, and a neutralisation unit may be needed.				

**Table 3.55: Strong and weak acid effluent treatment costs and performance [20, CEFIC-TDMA, 2004]**

The two main techniques used in the European titanium dioxide industry, which are presented below in Section 3.3.4.11.1 (waste acid recycling) and in Section 3.3.4.11.2 (waste acid neutralisation), apply to all fifteen EU-25 TiO<sub>2</sub> plants based on the sulphate process route. However, no information is available, which shows the method of the spent acid treatment applied in the titanium dioxide plant in Celje, Slovenia.

### 3.3.4.11.1 Waste acid recycling

#### Description

Refer to the general description in Section 3.3.4.11 above.

A method available for strong waste acid is to optimise the re-use of the concentrated waste acid in the digestion step and/or to sell surplus amounts as a co-product. A method available for weak acid is to optimise its re-use in the process or to neutralise it.

In this area it is appropriate to make the following point on the risks involved in transferring techniques between different sites: TiO<sub>2</sub> pigments are highly quality focused and every plant was built and developed to meet the quality requirements and to compete with the quality of pigments produced at other sites with different technologies. Every improvement in most environmental aspects has an influence on pigment quality (e.g. using concentrated recycled waste acid means a higher input of trace elements into the digestion step, and this has to be equalised by the improvement of washing steps) and needs quite a large capital investment.

So nearly every improvement on the environmental side should be tailor made for only one site in close contact with the supplier of a new technique, as the transfer to another site without further fitting does not guarantee any success.

Achieved environmental benefits

The total volume of the spent acid amounts to approximately 6 – 9 tonnes per one tonne of TiO<sub>2</sub> produced. Therefore acid regeneration, concentration and recycling has a direct positive impact on the environment. When the acid is recycled back to the digestion section, also the usage of fresh input sulphuric acid for the production of TiO<sub>2</sub> pigments is reduced. At the same time, the operation of acid neutralisation with lime is avoided, which – in certain unfavourable conditions – may lead to the generation of large amounts of waste red gypsum.

Cross-media effects

A large amount of energy is required (see Table 3.54 above) for the concentration of the spent sulphuric acid (from approx. 20 % to approx. 70 – 80 %). The more additional energy used, the larger the emissions of CO<sub>2</sub>, SO<sub>2</sub>, NO<sub>x</sub> and dust resulting from its generation.

Operational data

Data concerning aqueous emissions, covering both acid recycling or neutralisation, are given in Table 3.47. Refer also to Sections 3.3.4.5 and 3.3.4.7, and see Table 3.54 and Table 3.55 above.

However, the most characteristic for this technique are the data from German TiO<sub>2</sub> producers, as all of them are using the method of waste acid recycling. According to data from Germany, the following are specific loads, on the annual average level, for the process waste water from the filtration and washing section:

• SO <sub>4</sub>	30 – 300 kg/t	average	122 kg/t
• Fe	0.25 – 5 kg/t	average	2 kg/t
• Cd	0.001 – 3 g/t	average	0.001023 g/t
• Hg	0.00032 – 1 g/t	average	0.000339 g/t
• other metals	0 – 1 kg/t	average	1 kg/t (maximum value)
• suspended solids	1 – 5 kg/t	average	3 kg/t.

In particular, based on actual data from the German plants, the specific loads of some heavy metals in the group of ‘other metals’ can be split as follows: Cr: <50 g/t; Pb: <30 g/t; Cu: <20 g/t; and Ni: <15 g/t of TiO<sub>2</sub> pigment produced.

The official monitoring of one German plant shows the following 2004 (annual average) data on the specific loads of heavy metals: Cr 36 g/t, Pb 3 g/t, Cu <8 g/t, Ni <2 g/t, Cd <0.7 g/t, Hg <0.07 g/t TiO<sub>2</sub> pigment produced.

At the same time the sulphate load in the process waste water from the finishing section amounts to:

• SO <sub>4</sub>	80 – 110 kg/t	average	95 kg/t.
-------------------	---------------	---------	----------

Applicability

In principle, applicable to all TiO<sub>2</sub> plants using the sulphate process route (refer to the explanations included in Section 3.3.4.11).

Waste acid recycling is, in principle, an option mutually excluding with the option of waste acid neutralisation (see Section 3.3.4.11.2).

Economics

As in Table 3.54 and Table 3.55 above.

Driving force for implementation

The protection of the environment.

Example plants

Titanium dioxide plants in Leverkusen (sulphate process route), Nordenham, Uerdingen, and Duisburg, which are all in Germany.

### Reference literature

[20, CEFIC-TDMA, 2004], [42, UBA-Germany, 2001], [26, EIPPCB, 2003], [48, W. Buchner et al, 1989], [21, The Council of the EU, 1992], [85, EIPPCB, 2004-2005].

### **3.3.4.11.2 Waste acid neutralisation**

#### Description

Refer to the general description in Section 3.3.4.11 above.

A method applied for strong waste acid is to use lime and/or limestone as a neutralisation agent and to sell white and red gypsum as a co-product or to landfill red gypsum. In order to reduce the landfill volume, alternative routes for red gypsum, are used in the cement industry and for capping and landscaping activities. Only one site uses ammonia as a neutralising agent. Precipitated metal hydroxides are used for landfill or sold as a co-product. Ammonium sulphate is sold as a co-product. A method applied for weak acid is to optimise its re-use in the process or to neutralise it using common and available neutralising agents.

#### Achieved environmental benefits

The total volume of the spent acid amounts to approximately 6 – 9 tonnes per one tonne of TiO<sub>2</sub> produced. Therefore acid neutralisation has a direct positive impact on the environment.

At the same time, the neutralisation of acid with lime, which leads to the generation of large amounts of solid gypsum, may become an environment friendly option, if only adopted as the long term strategy focused on the maximum utilisation of gypsum to final marketable products, such as white gypsum plasterboards and red gypsum soil conditioners. In case of the neutralisation of spent acid with ammonia, ammonium sulphate fertiliser is then a final marketable product.

#### Cross-media effects

Substantial amounts of neutralising materials (chalk, lime) to produce white and red gypsum are required. In particular, substantial amounts of the red gypsum may need to be landfilled if its utilisation as a conditioner of local soils exceeds the local demand.

Also, a certain amount of energy is required (see Table 3.54) for the production and handling of white and red gypsum, much less, however, than that required for the concentration and recycling of acid. In the case of the neutralisation of the spent acid with ammonia to produce ammonium sulphate, a long term market demand needs to be confirmed for this nitrogen-sulphate fertiliser.

Another cross-media effect, but only in the case where chalk is used for neutralisation, is the release of CO<sub>2</sub> to the atmosphere.

#### Operational data

See Table 3.54 and Table 3.55. Refer also to Sections 3.3.4.5 and 3.3.4.7.

In particular, data concerning aqueous emissions, however, covering both acid recycling or neutralisation, are given in Table 3.47. The following are specific loads in the process waste water from the filtration and washing section:

• SO <sub>4</sub>	30 – 730 kg/t	average	274 kg/t
• Fe	0 – 158 kg/t	average	18 kg/t
• Cd	0.001 – 3.2 g/t	average	0.799 g/t
• Hg	0.000 – 2.2 g/t	average	0.31 g/t
• other metals	0.001 – 17 kg/t	average	3 kg/t
• suspended solids	0.09 – 41 kg/t	average	12 kg/t.

More characteristic data for this technique, covering only acid neutralisation, are given in Section 3.3.3.6 (Environmental performance – Grimsby Works 2002). In particular, the level of total sulphates in 2002 is reported at 591 kg/t TiO<sub>2</sub> produced.

Waste acid neutralisation is inseparably connected with solid waste generation. This pertains particularly to the amounts of waste to land in the form of white gypsum and red gypsum. However, with a well thought out long term strategy focusing on the utilisation of white gypsum as a co-product for the production of plasterboard, which is then put into operation, the quantities disposed of to land are zero (see Table 3.49).

As can be seen from Table 3.49, the tonnage of red gypsum disposed to landfill in 1999 varied in the range between 1113 – 6918 kg/t TiO<sub>2</sub> produced. In turn, data included in Section 3.3.3.6 (Environmental performance – Grimsby Works 2002), indicate for a possibility to make great progress in the utilisation of red gypsum. Therefore, in some locations where there is strong demand for red gypsum (soil conditioner in blends with organic fertilisers, inert material used for capping and landscaping activities of old quarries, landfills and contaminated sites, and co-product used in the cement industry), the tonnage of red gypsum disposed of to landfill can be substantially reduced or even eliminated. Refer also to Section 3.3.4.11 above.

#### Applicability

In principle, applicable to all TiO<sub>2</sub> plants using the sulphate process route (refer to the explanations included in Section 3.3.4.11). Waste acid neutralisation is, in principle, an option mutually excluding waste acid recycling (see Section 3.3.4.11.1).

#### Economics

Refer to data included in Table 3.54 and Table 3.55.

#### Driving force for implementation

The protection of the environment.

#### Example plants

Titanium dioxide plant in Grimsby, UK.

#### Reference literature

[20, CEFIC-TDMA, 2004], [42, UBA-Germany, 2001], [26, EIPPCB, 2003], [48, W. Buchner et al, 1989], [21, The Council of the EU, 1992], [85, EIPPCB, 2004-2005].

### **3.3.4.12 Co-products for sale or re-use**

#### Description

Ferrous sulphate, ferric sulphate, iron oxide, and other copperas related products (refer to Section 7.5), as well as white gypsum, red gypsum, and reconcentrated sulphuric acid, are all potential co-products in the manufacturing of titanium dioxide by the sulphate process route. Their production depends mainly on local markets.

The goal to maximise the conversion of potential wastes into co-products to suit local demand, typically associated with the selection and development of a new location to enable the maximum use of these co-products, is a proven long term strategy applied across the European titanium dioxide industry. Whatever the recovery system used, the following hierarchy applies:

- avoidance of waste generation with preservation of resources
- reduction of waste generation
- re-use of waste (preferably inside the process or, if this is not possible, then outside of the process)
- waste disposal.

### Achieved environmental benefits

Minimisation of wastes, otherwise released to the environment (refer to data included in Table 3.49 and Table 3.50).

### Cross-media effects

Often there are local restrictions on markets and it can be counterproductive to transport low cost co-products long distances.

### Operational data

No other data submitted apart from these included in the preceding sections. Refer in particular to data included in Section 7.5 on 'Copperas and related products', and to information relevant to white gypsum included in Sections 3.3.3.5.2, 3.3.3.6, 3.3.4.11.2 and Figure 3.6.

### Applicability

In principle, applicable to all plants producing TiO<sub>2</sub> by the sulphate process route.

### Economics

No detailed data submitted.

### Driving force for implementation

Reducing the impact on the environment, among others resulting from the requirements of the TiO<sub>2</sub> Harmonisation Directive [21, The Council of the EU, 1992].

### Example plants

The strategy to manufacture co-products for sale or re-use is, to a various degree, characteristic to all fifteen EU-25 titanium dioxide plants based on the sulphate process route (see Table 3.5).

### Reference literature

[20, CEFIC-TDMA, 2004], [42, UBA-Germany, 2001], [26, EIPPCB, 2003], [59, CEFIC-TDMA, 2004].

## **3.3.4.13 Energy usage**

### Description

Generally a combination of plant design, operation and management is taken into consideration when determining techniques to minimise energy usage. In particular, for new plants it would also include the supply of its power by a high efficiency combined heat and power (CHP) system [86, The Council of the EU, 2004].

In broad terms, acid recycling uses 11.5 GJ/tonne TiO<sub>2</sub> more energy than neutralisation. However, this is only one component in the matrix of factors that must be considered when selecting the mode of effluent treatment.

A technique to consider with regard to energy efficiency is to use pressure filters for the kiln feed. Partly recycling off-gases in the calcination section is used for energy saving in the TiO<sub>2</sub> industry. In order to make use of the off-gas energy, dust removal is essential requiring the use of suitable systems such as electrostatic precipitators at high temperatures.

The use of slag or slag ilmenite mixtures avoids the use of concentration of the liquor prior to precipitation. For product quality reasons, this often is not practical with pure ilmenite feedstock since the hydrolysis conditions are too aggressive to maintain an even floc size distribution in the precipitate. Waste heat from steam condensation is utilised in the process.

As mentioned above, acid recycling increases the total energy consumed at the site by approximately 30 %.

Achieved environmental benefits

Energy efficiency in the process is also an indirect measure of the impact of TiO<sub>2</sub> production on the environment. The less energy used for TiO<sub>2</sub> production, the less energy used in primary fuels and, consequently, the less emissions of CO<sub>2</sub>, SO<sub>x</sub>, and NO<sub>x</sub> to the atmosphere related to the generation of energy used in the process.

Cross-media effects

No data submitted.

Operational data

The range of energy usage in TiO<sub>2</sub> plants operated by the sulphate process route (understood as the overall total energy consumption per site) varies between 23.7 – 45.3 GJ/t TiO<sub>2</sub> produced – refer to Table 3.39 [20, CEFIC-TDMA, 2004]. In turn, the minimum and maximum values of all German production locations are quoted in the range between 32.7 – 40.9 GJ/t TiO<sub>2</sub> produced [42, UBA-Germany, 2001].

It should be also noted that energy usage for acid recycling is reported in the range of 10.2 - 18.0 GJ/t TiO<sub>2</sub>, while this, for acid neutralisation is in the range of 0.2 – 6.5 GJ/t TiO<sub>2</sub>, the difference between the average figures of energy usage being 13.8 – 2.3 = 11.5 GJ/t TiO<sub>2</sub> produced (refer to Section 3.3.3.2.1).

Applicability

Applicable to all plants producing TiO<sub>2</sub> by the sulphate process route.

Economics

No detailed data submitted. Refer to the LCA study in Section 3.4.5.

Driving force for implementation

Reduced impact on the environment and decreased manufacturing costs of TiO<sub>2</sub> production.

Example plants

Titanium dioxide plant in Grimsby, UK (and the other fourteen European TiO<sub>2</sub> plants based on the sulphate process route).

Reference literature

[20, CEFIC-TDMA, 2004], [42, UBA-Germany, 2001], [26, EIPPCB, 2003], [85, EIPPCB, 2004-2005], [86, The Council of the EU, 2004], [25, D.G. Heath, 1996], [24, Tioxide Group Ltd, 1995], [73, G.V. Ellis, 1979].

## 3.4 Comparison of the chloride and sulphate processes

### 3.4.1 Introduction

Ever since the chloride process became a viable production method for the manufacture of titanium dioxide, comparisons have been made from an environmental point of view and from other standpoints. Since the beginning, both processes, and particularly the sulphate process, have undergone radical changes and improvements. These changes were initiated by the enactment of the Titanium Dioxide Harmonisation Directive [21, The Council of the EU, 1992]. More importantly, the change and improvement process has continued ever since, and this has been due to several factors, the most important of them being:

- availability of feedstocks
- introduction of certified environmental management systems such as: ISO 14001 and EMAS, which embrace the commitment to continual environmental improvement.

It is the intention in this section to qualitatively compare and contrast the two processes as they are developed now. Additional comparisons can be made by consulting the performance data in Sections 3.2.3 and 3.3.3 above, and in the process flow sheets (Figure 3.2 and Figure 3.4 above).

It is not intended to carry out a full life cycle assessment of the two processes but reference will be made to such studies where appropriate (see Section 3.4.5 below).

### 3.4.2 Direct comparison of the chloride and sulphate processes

#### 3.4.2.1 Ore import

This is a key area, which has changed since the introduction of the chloride process. Both the chloride and sulphate processes can use the same natural feedstock ilmenite (43 – 60 %  $\text{TiO}_2$ ).

However, the use of ilmenite in the chloride process requires specific know-how of how to avoid a large build-up of metal chlorides in the solids separation section and, more importantly in this context, produces large amounts of ferrous chloride, which are difficult to dispose of. There is also a large consumption of chlorine, which can increase the manufacturing cost of  $\text{TiO}_2$  pigment production. Currently, only some plants in the US are processing ilmenite and deep wells are used to dispose of the waste chlorides.

In Europe, because of the problems mentioned above, the original feedstock for the chloride process was natural rutile (95 – 96 %  $\text{TiO}_2$ ). However over the last 10 years, rutile has become very scarce worldwide to the extent that it is only used infrequently at present (by one site in Europe). The current replacements are:

- ‘synthetic rutile’ which is made by leaching ilmenite with dilute HCl. This leaching is carried out at the source site
- titanium slag (85 – 90 %  $\text{TiO}_2$ ) which is made by extraction of the iron from ilmenite ores in a blast furnace, followed, if necessary, by an acidic leaching of impurities like magnesia.

A crude comparison between a chloride site using slag and a sulphate site using ilmenite may conclude that the chloride process potentially generates less waste. However, because of the reasons described above, there is no difference in the amount of potential waste coming from each process using the same ore. The difference is that for the chloride process not all the waste is generated at the  $\text{TiO}_2$  manufacturing sites (see Section 3.4.5 below).

For the sulphate process, the choice remains with the selection of the ore: ilmenite against upgraded ores. The life cycle issue here is that the extracted iron is not a waste but neither is the iron sulphate co-product ('copperas') which most modern ilmenite-based plants produce and sell for water treatment, etc. Also, it is noted that slag manufacture is energy intensive, whereas copperas manufacture is not.

The main inference here is that simplistic conclusions cannot be drawn in this area.

Other aspects of feedstock preparation are similar for both processes. In one case, the milling and drying takes place on the source site and in the other it is carried out before feedstock use.

#### 3.4.2.2 Feedstock processing – digestion and chlorination

The basic purpose of this part of the process is similar. It is to liberate the titanium from the strong chemical bonds in which it is held in the feedstock. The sulphate process uses concentrated sulphuric acid at 100 to 200 °C usually reacting over a number of hours in a batch process to maximise yield. The chloride process uses chlorine passed through a fluidised bed of coke and feedstock at ~ 1000 °C.

The main gaseous emissions are CO, COS and CO<sub>2</sub> and occasionally Cl<sub>2</sub> for the chloride process and SO<sub>x</sub> and traces of H<sub>2</sub>S (if slag is the feedstock) for the sulphate process.

In modern processes, CO and COS are rendered less harmful in thermal oxidisers by conversion to CO<sub>2</sub> and SO<sub>2</sub>. Cl<sub>2</sub> is removed by scrubbing. Similarly SO<sub>x</sub> and H<sub>2</sub>S are substantially reduced by multistage scrubbing.

Both processes are of very high chemical efficiency and overall are exothermic. No solid waste is generated at these stages of the processes.

Both chlorine and concentrated sulphuric acid are hazardous materials, however, chlorine is recognised to require extra special care in its transport, storage and usage. This is acknowledged internationally and the chloride process is subject to the Seveso II Directive [23, The Council of the EU, 1996] for dangerous substances (chlorine and titanium tetrachloride) that require a detailed 'Safety Report' to be prepared for each site as a prerequisite for a licence to operate.

#### 3.4.2.3 Feedstock processing – impurity removal

This section covers:

- solids separation, condensation and gas scrubbing and TiCl<sub>4</sub> purification for the chloride process
- reduction, clarification and crystallisation, hydrolysis filter and wash for the sulphate process.

It should be noted, that because of the radically different nature of the two processes, simple comparisons of the impurity removal in the chloride and sulphate processes are not possible. However, because the primary purpose of the analysed sections is impurity removal, they are considered under this heading.

Table 3.56 exemplifies a comparison of the impurity removal sections of the two processes.



SULPHATE	CHLORIDE
<p><b>REDUCTION</b> This is unique to the sulphate process using ilmenite feedstock and its purpose is to convert all the iron to the soluble ferrous form. A small amount of hydrogen is generated. Treated scrap iron is normally used and if this contains any insoluble matter it must be neutralised and removed as a waste.</p>	There is no equivalent step in the chloride process.
<p><b>CLARIFICATION AND SOLIDS SEPARATION</b> Most of the insoluble impurities are removed and treated at this stage together with unreacted feedstock. The product is neutralised with lime to remove residual sulphuric acid and either disposed of to land as an inert material or, if the opportunity is available, used after further treatment for land restoration in civil engineering projects. No significant atmospheric emissions result from this stage. Solid waste is generated from the impurities in the feedstocks.</p>	<p><b>SOLIDS SEPARATION</b> As with the sulphate process, most of the impurities (including iron) together with unreacted feedstock, are removed at this stage. The main difference, as compared to the sulphate process, is that it is a vapour phase desublimation rather than an aqueous process. The solids are repulped in water, neutralised with lime and landfilled or, in some cases, converted to saleable products. No significant atmospheric emissions result from this stage.</p>
<p><b>CRYSTALLISATION (ILMENITE ONLY)</b> The majority of the iron is removed here to be used as a co-product as described above. This requires some energy but there are no significant air emissions.</p>	<p><b>CONDENSATION/GAS SCRUBBING</b> Tetrachloride vapour is condensed and further purified. The gas stream is passed through a thermal oxidiser and then treated in a variety of ways to produce various co-products. Heat from the thermal oxidiser may be recovered or used to maintain buoyancy in the exit gas stream to improve atmospheric dispersion.</p>
<p><b>HYDROLYSIS</b> The purified titanil sulphate solution is hydrolysed under controlled conditions by seeding and boiling to produce hydrated titanium oxide ('pulp'). Some energy is used as steam.</p>	There is no equivalent step in the chloride process
<p><b>FILTER AND WASH</b> The pulp is first filtered washed and then leached to remove residual impurities. The waste acid solution is sent forward to the effluent treatment plant.</p>	<p><b>TiCl<sub>4</sub> PURIFICATION</b> The final purification of the tetrachloride is carried out by complexing vanadium with oil in the distillation column. The solid waste is returned to the main solid waste stream and the pure product is sent to storage. Steam energy is used for the distillation.</p>

**Table 3.56: Comparison of the impurity removal sections of the two processes**

#### 3.4.2.4 Raw pigment production – calcination and oxidation

Calcination produces aggregated pigment sized crystals from hydrolysed pulp and can also change the crystal habit from anatase to rutile. Oxidation is the burning of pure tetrachloride in oxygen to produce similar pigmentary sized particles, however only rutile can be produced.

Both processes are energy intensive and produce a gas stream as detailed below:

- in the sulphate process, SO<sub>x</sub>, dust and water vapour are produced from calcination. In almost all sulphate sites in Europe, the SO<sub>x</sub> is catalytically oxidised and converted to sulphuric acid, which, as with the dust, is recycled back into the process
- in the chloride process, chlorine is produced from oxidation, which is then recycled directly or indirectly back to chlorination.

Calcination is an open system operating at atmospheric pressure whereas oxidation must operate in a totally closed system, which, for direct recycling systems, operates above ambient pressure. High integrity, fully operationally reliable systems and procedures are required to prevent any significant chlorine emissions.

### 3.4.2.5 Raw pigment preparation for finishing

From here on the techniques used in the sulphate and chloride processes are similar, if not the same.

In the sulphate process, calciner discharge is cooled in a conventional open rotary cooler, which allows re-use of the heat, whereas in the chloride process, oxidation reactor discharge requires a closed purpose built cooler to ensure no loss of chlorine. In the chloride process, the reactor discharge is separated from the chlorine by high integrity bag filters.

In the sulphate process, calciner discharge normally needs dry and wet milling to break down large aggregates. This is not required in the chloride process for reactor discharge, but degassing and removal of residual chlorine is necessary. Both products are usually wet milled as well.

### 3.4.2.6 Finishing

The finishing stage is identical for both processes as described in Section 3.3.2.9 above.

### 3.4.2.7 Effluent treatment

As is described earlier, the sulphate process liquid effluent is treated in a number of different ways to reduce the environmental impact of that effluent.

For the sulphate process iron salts are extracted for commercial use (reference can be made to Section 7.5 on 'Copperas and related products'), sulphuric acid is reconcentrated for re-use, filter salts are roasted to recover the sulphur values and, where possible, the cinder is used commercially. Alternatively, the effluent is neutralised in a stepwise process producing firstly 'white gypsum' for use in plasterboard manufacture, or in the cement industry, etc. followed by 'red gypsum' (an iron hydroxide calcium sulphate mix), which is used in clay soil treatment and land recovery.

Liquid effluent in the chloride process requires a similar treatment (however on a smaller scale than that of the sulphate process). On the other hand, the liquid effluent, resulting from the upstream production of synthetic rutile from ilmenite, is treated similarly to the sulphate process effluent. Red gypsum is one of the by-products.

In the chloride process route, the main recycling operation is that used for recycling the chlorine gas. Sophisticated high integrity systems are required for safe containment of the chlorine and  $\text{TiCl}_4$ , CO, COS. These usually include the ability to liquefy, store and evaporate both chlorine and tetrachloride. Such systems use energy and sub-zero cooling. Carbon monoxide and carbonyl sulphide are invisible toxic gases that require special precautions for safety reasons.

### 3.4.2.8 Energy

Using the LCA approach (Section 3.4.5) takes account of the environmental effects from the beneficiation process used for the production of feedstock for the chloride process.

The key issue relating to energy usage in  $\text{TiO}_2$  production is the emission of greenhouse gases, mainly carbon dioxide. If the coke consumption in chlorination used as a reducing agent is included, the contribution to the emissions of greenhouse gases for both processes are similar.

### 3.4.2.9 Water

The sulphate process consumes significantly more water than the chloride process primarily because washing is the only means of removing residual impurities from the hydrolysed TiO<sub>2</sub> pulp.

### 3.4.3 Direct comparison – abatement of a titanium dioxide plant

#### 3.4.3.1 Sulphate process route

The sulphate process produces large quantities of waste material including metallic sulphates. The conversion of these materials into useful saleable by-products, leads to the minimisation of the releases to the environment. Therefore, techniques available for the sulphate process route include:

- conversion of ferrous sulphate (raw copperas) to the family of ferrum products used for many applications, including water treatment (see Section 7.5)
- conversion of spent sulphuric acid to white gypsum (for wall boarding) or red gypsum (for agricultural land improvement)
- recycling of dilute acid produced by removal of SO<sub>2</sub> from calciner off-gases.

The sulphate process also produces weak acid, SO<sub>x</sub>, NO<sub>x</sub> and particulates. In this respect, techniques available for the sulphate route include:

- abatement for SO<sub>x</sub>, NO<sub>x</sub> and particulates, arising from fuel firing and calcining, as well as removal of particulates from waste gases
- subsequent recovery of the SO<sub>2</sub> generated by the roasting of metal sulphates to make sulphuric acid via the contact process
- recycling the metal oxides produced by roasting to the steel industry
- concentration or regeneration of the spent sulphuric acid for recycling or sale.

#### 3.4.3.2 Chloride process route

Tail-gases from the chlorination stage of the process contain carbon monoxide, carbon dioxide with some hydrogen chloride and chlorine ‘slip’ from the reaction. Conventional two-stage scrubbing techniques, first with demineralised water to remove the hydrogen chloride and then caustic solution to remove chlorine, are techniques available for the chloride process route. All other vents are typically scrubbed with a solution of caustic soda to remove chlorine and make sodium hypochlorite.

The carbon monoxide generated by oxidation of the coke bed of the chlorinator, requires the thermal conversion of the CO in the tail-gas to CO<sub>2</sub>.

It is also practicable to convert metallic chlorides in the waste material to the more inert oxide form, which will have a reduced environmental impact and may have values as a co-product.

### 3.4.4 Conclusions

This comparison indicates there is a great deal of environmental equivalence between modern chloride and sulphate processes that currently operate in Europe. There are obviously detailed differences, which are hard to directly compare. Refer also to BAT Section 3.5 below.

These conclusions are supported by a Life Cycle Assessment study that was carried out by Tioxide in the mid 1990s [24, Tioxide Group Ltd, 1995]. In the LCA study [25, D.G. Heath, 1996] thirteen titanium dioxide production processes and feedstock options were looked at in detail and four of them, two chloride and two sulphate processes, had very similar overall environmental impacts (refer to Section 3.4.5 below).

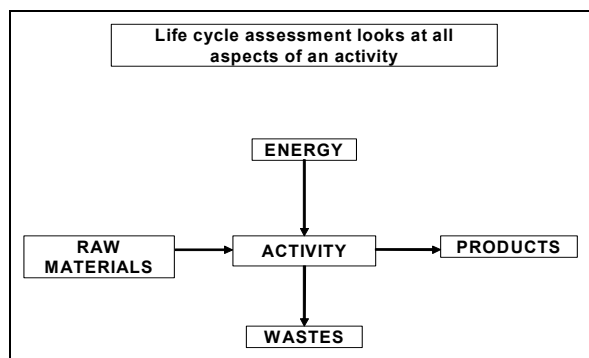
### 3.4.5 Life Cycle Assessment in the titanium dioxide industry

For many years now, the issue of true environmental comparability of the chloride and sulphate processes has been an important topic in the  $\text{TiO}_2$  industry, especially when considering feedstocks, overall energy consumption and their associated emissions. It was, therefore, reasonable to include the relevant sections of the LCA study, carried out in 1995 in this document [20, CEFIC-TDMA, 2004].

The purpose of the Life Cycle Assessment (LCA) study was to compare six realistic process options for making titanium dioxide. These are listed in Table 3.60.

Tioxide Group Ltd (now Huntsman Tioxide) has developed LCA since 1990. The study modelled the whole production chain: ore – product – waste. For the  $\text{TiO}_2$  pigment, the study boundary was the factory gate. The LCA study focused on comparing typical process options and was modelled as far as comparing emissions, with limitations, however, as actual environmental impacts were not modelled. The study was based on well defined system boundaries and functional units, as well as on reliable and available data, with data gathering and an inventory linked to the real world. A commercial programme, which was peer reviewed, was used in the study.

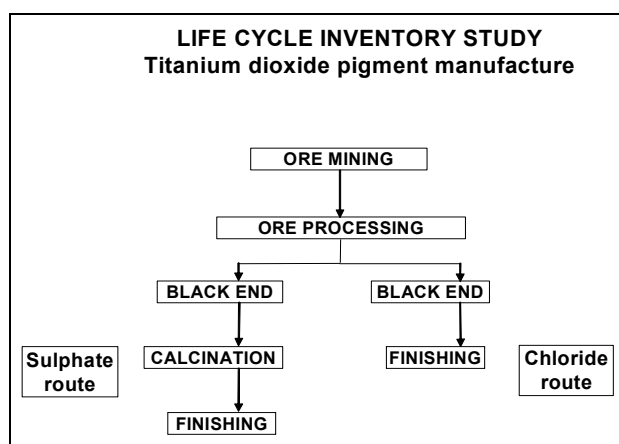
An integrated approach, adopted in the LCA study to the manufacture of  $\text{TiO}_2$ , is illustrated in Figure 3.10.



**Figure 3.10: Integrated approach in the LCA study on  $\text{TiO}_2$  manufacture** [20, CEFIC-TDMA, 2004]

The LCA study examined all key inputs and outputs in  $\text{TiO}_2$  manufacture, including raw materials, products, utilities and wastes, covering the whole chain of mass/energy balance.

Major assumptions of the LCA inventory study are illustrated in Figure 3.11. Even though the operations of the mining and upgrading of titanium ores were outside the control of Tioxide Group Ltd, emissions relating to these operations and to the transport of ores to the  $\text{TiO}_2$  pigment production sites were included in the study. The  $\text{TiO}_2$  pigment calcination step was excluded from the chloride route options (as it is not necessary in the chloride process). Finishing operations were assumed to be the same for all examined options, as they are similar in both process routes.



**Figure 3.11: Assumptions of the LCA inventory study on TiO<sub>2</sub> manufacture [20, CEFIC-TDMA, 2004]**

Mineral feedstock options analysed in the LCA study are presented in Table 3.57.

<b>MINERAL FEEDSTOCK OPTIONS</b>	
<u>Ilmenite and rutile</u> <ul style="list-style-type: none"> <li>• beach deposits, mined in Australia, India, etc.</li> <li>• physical separation to concentrate required minerals</li> </ul>	<u>Slag and synthetic rutile</u> <ul style="list-style-type: none"> <li>• slag               <ul style="list-style-type: none"> <li>– canadian massive ilmenite</li> <li>– smelted to remove Fe, which is sold</li> </ul> </li> <li>• synthetic Rutile               <ul style="list-style-type: none"> <li>– Australian ilmenite</li> <li>– roasted and leached to remove Fe, which is neutralised and disposed of to land</li> </ul> </li> </ul>

**Table 3.57: Mineral feedstock options analysed in the LCA study [20, CEFIC-TDMA, 2004]**

The analysed sulphate route process options given in Table 3.58 were based on real situations within the Huntsman Tioxide Group.

	<b>Calais</b>	<b>Huelva</b>	<b>Grimsby</b>	<b>Scarlino</b>	<b>Umbogintwini</b>	<b>Teluk Kalung</b>
Ilmenite		X	X			X
Slag	X			X	X	
Make acid on site	X		X			
Purchase acid		X		X	X	X
Reconcentrate waste acid	X	X				
Neutralise waste acid			X	X	X	X

**Table 3.58: The sulphate process options considered in the LCA study [20, CEFIC-TDMA, 2004]**

Other assumptions of the LCA study are given in Table 3.59.

<b>OTHER ASSUMPTIONS</b>	
<u>Location</u> <ul style="list-style-type: none"> <li>• hypothetical plant in north east of UK</li> <li>• eliminates transport variables when comparing process options.</li> </ul>	<u>Electricity generation</u> <ul style="list-style-type: none"> <li>• based on UK generation mix of coal/oil/gas/nuclear</li> <li>• implications for SOX emissions.</li> </ul> <u>Finishing plant</u> <ul style="list-style-type: none"> <li>• common model for all scenarios.</li> </ul>

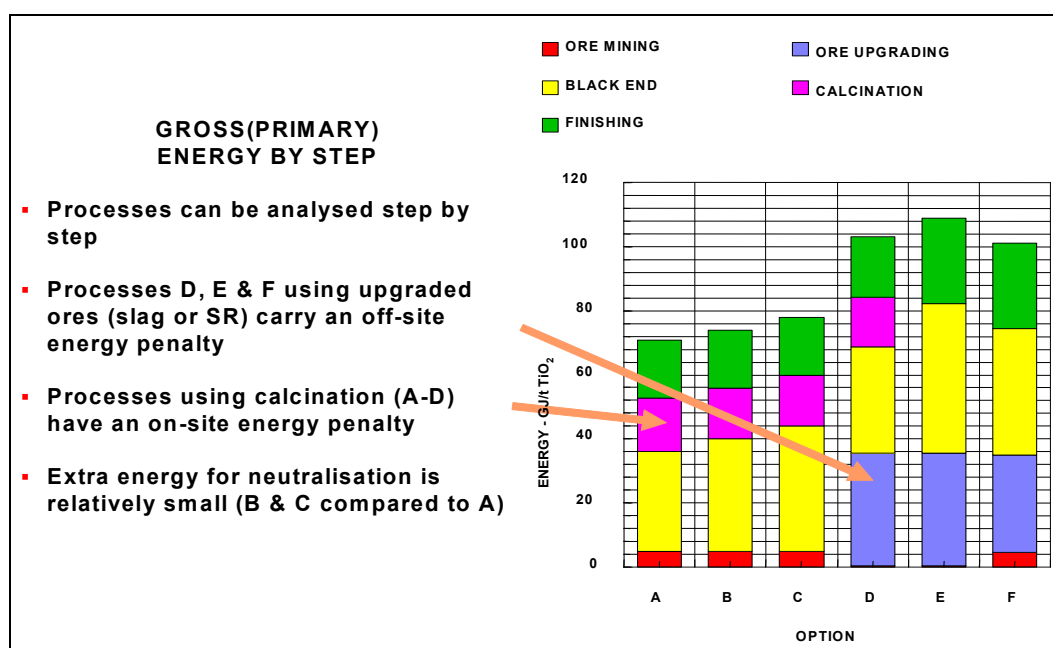
**Table 3.59: Other assumptions of the LCA study on TiO<sub>2</sub> manufacture [20, CEFIC-TDMA, 2004]**

Thirteen titanium dioxide production options and different feedstocks were considered in the LCA study, however, the six most typical ones discussed here are listed in Table 3.60. Options A, B, C, and D relate to the sulphate route, while E and F to the chloride route. In the case of sulphate plants, sulphuric acid was assumed to be made locally which gives a steam benefit (this is now not the case). Option A is where sulphate plants were in the mid 1980s – and was treated as a baseline. Option B, D, E and F all meet the minimum environmental performance standards of The TiO<sub>2</sub> Harmonisation Directive 92/112/EEC [21, The Council of the EU, 1992]. Option C is where sulphate plants can be when driven by tighter local regulations that have already been achieved in Italy, Spain and Malaysia.

Key	Feedstock	Process	Waste treatment
A	Ilmenite	Sulphate	None
B	Ilmenite	Sulphate	EU standard neutralisation (800 kg SO <sub>4</sub> /t TiO <sub>2</sub> )
C	Ilmenite	Sulphate	Full neutralisation (300 kgSO <sub>4</sub> /t TiO <sub>2</sub> )
D	Slag	Sulphate	EU std. acid reconcentration (800 kg SO <sub>4</sub> /t TiO <sub>2</sub> )
E	Slag	Chloride	EU standard neutralisation (450 kgCl/t TiO <sub>2</sub> )
F	Synthetic rutile	Chloride	EU standard neutralisation (228 kgCl/t TiO <sub>2</sub> )

**Table 3.60: Feedstock process environment options discussed in the LCA study [20, CEFIC-TDMA, 2004]**

Gross primary energy demand for the manufacture of the TiO<sub>2</sub> pigment step by step in six examined options is illustrated in Figure 3.12.



**Figure 3.12: Gross primary energy demand for the manufacture of the TiO<sub>2</sub> pigment step by step [20, CEFIC-TDMA, 2004]**

Figure 3.12 shows that the overall energy usages for the chloride process (options E and F) have the highest overall energy usage, and even though sulphate plants using the calcination stage pay an energy penalty, the ore upgrading energy penalty is even higher.

More pigment finishing energy for the chloride process (options E and F) was required in the past as there was no sulphuric acid plant, and therefore, more energy was needed for steam generation (this is now not the case).

Energy consumptions in the preparation of raw materials are included in the totals. Where the preparation involves the production of more than one useful material (as is the case with slag), the environmental burden is shared between the materials in proportion to their perceived commercial value and the unit quantities produced. As far as CO<sub>2</sub> emissions are concerned, they follow the total primary energy usage (with a slight increase for current sulphate plants where sulphuric acid production has ceased).

It should be noted, however, that there have also been changes in the patterns of energy usage in the UK since 1995, which are connected with:

- a switch from LPG and fuel oil to natural gas
- a change to integrated gas fired CHP plants.

As illustrated in Figure 3.13 below, emissions of sulphur oxides (SO<sub>x</sub>) examined in five options (from B through to F) as against baseline option A (no SO<sub>x</sub> treatment), are lower in the sulphate route options than those in the chloride route options, because of a strong influence of the overall energy demand on SO<sub>x</sub> emissions. Also, as assumed in the LCA study, the energy generation scenario typical for the UK – the use of coal and oil, implies higher SO<sub>x</sub> emissions in the chloride process route options. In fact, when energy generation is excluded, SO<sub>x</sub> emissions both from the chloride and sulphate process routes alone are very low.

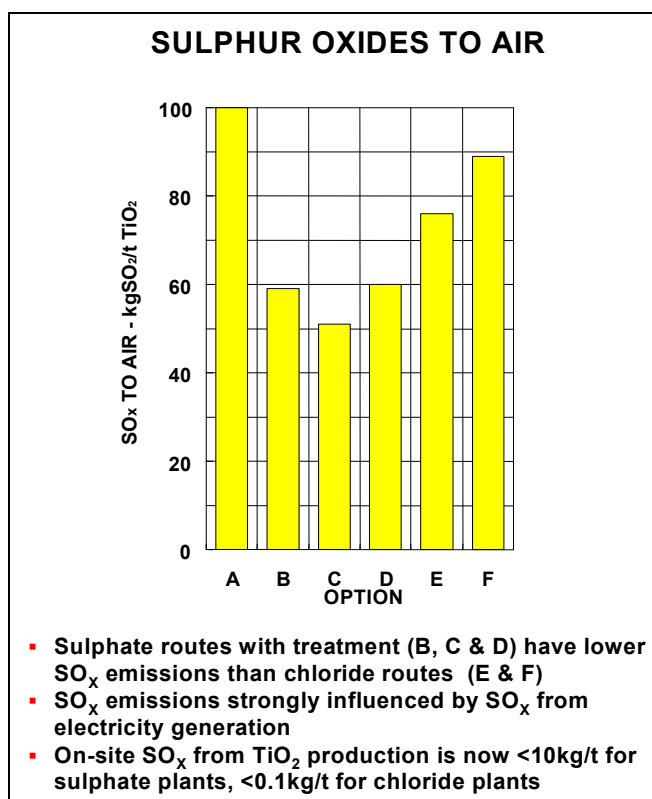
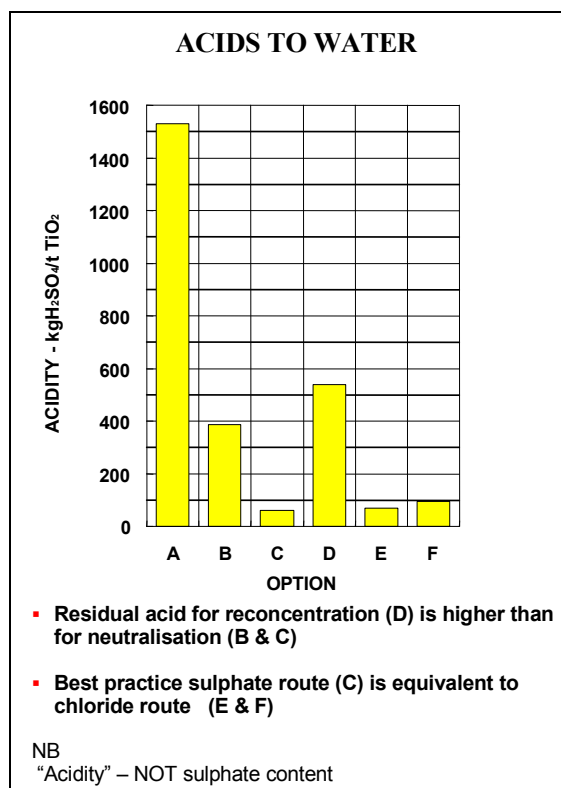


Figure 3.13: Emissions of sulphur oxides to air analysed in the LCA study [20, CEFIC-TDMA, 2004]

In particular, emissions of sulphur oxides have dropped since 1995 in the sulphate process plants because of improved scrubbing of the calcination and digestion gases, and the closure of old sulphuric acid plants (in favour of purchasing high specification smelter acid), and in general, because of the switch of energy source from fuel oil to natural gas.

As illustrated in Figure 3.14, the acidity of the waste liquid streams also fell substantially. Dramatic reduction in acid released to water can be noted in option C (comparable to the chloride process options E and F), when full neutralisation is applied. The acidity level in option D (reconcentration of weak post-hydrolytic sulphuric acid) is higher than that in option B, due to a relative mix of acid and metals in the waste streams.



**Figure 3.14: Releases of acids to water analysed in the LCA study [20, CEFIC-TDMA, 2004]**

In terms of acids released to water from the titanium dioxide plants, the major changes applied since 1995 include:

- full neutralisation of chloride plant acids
- improved neutralisation of sulphate plant wastes.

The amounts of industrial solid wastes generated in the whole chain of operations applicable to the manufacture of titanium dioxide pigments analysed in the LCA study, are illustrated in Figure 3.15.

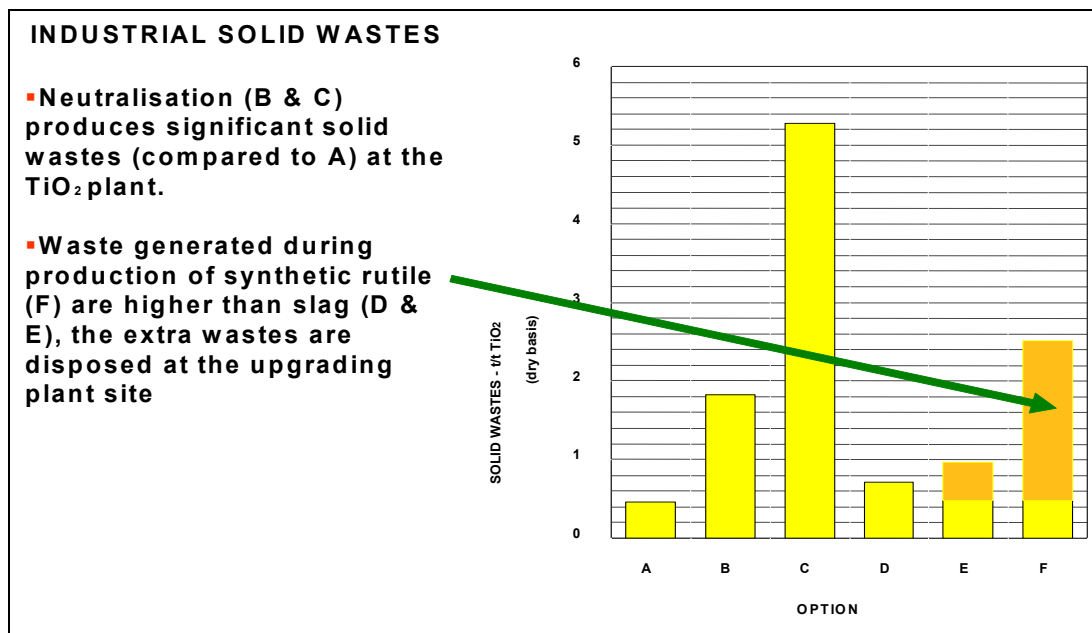
As compared to the baseline option A (plant not equipped with a neutralisation facility), option D (sulphate process based on slag processing and reconcentration of sulphuric acid) performs best, followed by option E (chloride process based on slag processing). This is obvious, as the treatment of acid yields additional solid residues (in particular, inert gypsum). Option C (sulphate process, ilmenite, full neutralisation) is, therefore, characterised by the highest amount of solid wastes per tonne of TiO<sub>2</sub> pigment produced.

The long term strategy of the utilisation of both co-produced gypsum and copperas-related products (see Section 7.5) is therefore of great importance for reducing the amount of industrial solid wastes generated in the manufacture of titanium dioxide pigments. In option F, solids are generated, in principle, in the beneficiation process.



The changes in the generation of solid wastes since 1995 are attributable in particular to:

- increased sales of white gypsum (gypsum plaster industry)
- use of red gypsum as a secondary raw material (improvement of soil conditions)
- higher degree of utilisation of copperas and increased sales of iron chemicals, which means that less iron ends up as a constituent of solid wastes.



**Figure 3.15: Solid wastes generated in the whole chain of operations relating to the  $\text{TiO}_2$  industry [20, CEFIC-TDMA, 2004]**

The LCA study helped Huntsman Titanium to clarify environmental concerns in the titanium dioxide industry, and in particular it:

- indicated the potential impacts of process options
- suggested that there is no single ‘best’ option – in particular the long term availability of a local market for low value co-products is an important factor
- highlighted continuous improvement in performance achieved as part of an overall management system.

The LCA study allowed for ongoing evaluation of environmental concerns in the titanium dioxide industry, including new processes, raw materials, and products, as well as investments in long term co-product development.

The LCA study indicated a potential environmental impact of  $\text{TiO}_2$  manufacture, while the EIA programmes quantified the actual impact of the titanium dioxide industry on the environment.

### 3.5 Best Available Techniques for the production of titanium dioxide

In understanding this section and its contents, the attention of the reader is drawn back to the preface of this document and in particular the fifth section of the preface: ‘How to understand and use this document’. The techniques and associated emission and/or consumption levels, or ranges of levels, presented in this section have been assessed through an iterative process involving the following steps:

- identification of the key environmental issues for the sector, including:
  - environmental requirements and minimum environmental performance standards in the EU stemming from the implementation of the TiO<sub>2</sub> Harmonisation Directive, to which the titanium dioxide industry is required to comply
  - the environmental impact outside of the EU due to upgrading titanium ores prior to the production of titanium dioxide
  - precautions regarding chlorine inventory in the chloride process route, and measures adopted to utilise spent post-hydrolytic sulphuric acid in the sulphate process route
  - substantial energy use involved in both routes, in particular in the sulphate process
- examination of the techniques most relevant to address these key issues
- identification of the best environmental performance levels, on the basis of the available data in the European Union and worldwide
- examination of the conditions under which these performance levels were achieved; such as costs, cross-media effects, and the main driving forces involved in implementation of the techniques
- selection of the best available techniques (BAT) and the associated emission and/or consumption levels for this sector in a general sense, all according to Article 2(11) and Annex IV of the Directive.

Expert judgement by the European IPPC Bureau and the relevant Technical Working Group (TWG) has played a key role in each of these steps and in the way in which the information is presented here.

On the basis of this assessment, techniques, and as far as possible consumption and emission levels associated with the use of BAT, are presented in this section that are considered to be appropriate to the sector as a whole and in many cases reflect the current performance of some installations within the sector. Where emission or consumption levels ‘associated with best available techniques’ are presented, this is to be understood as meaning that those levels represent the environmental performance that could be anticipated as a result of the application, in this sector, of the techniques described, bearing in mind the balance of costs and advantages inherent within the definition of BAT. However, they are neither emission nor consumption limit values and should not be understood as such. In some cases it may be technically possible to achieve better emission or consumption levels but due to the costs involved or cross-media considerations, they are not considered to be appropriate as BAT for the sector as a whole. However, such levels may be considered to be justified in more specific cases where there are special driving forces.

The consumption and emission levels associated with the use of BAT have to be seen together with any specified reference conditions (e.g. averaging periods).

The concept of ‘levels associated with BAT’ described above is to be distinguished from the term ‘achievable level’ used elsewhere in this document. Where a level is described as ‘achievable’ using a particular technique or combination of techniques, this should be understood to mean that the level may be expected to be achieved over a substantial period of time in a well maintained and operated installation or process using those techniques.

Where available, data concerning costs have been given together with the description of the techniques presented in the previous section. These give a rough indication about the magnitude of the costs involved. However, the actual cost of applying a technique will depend strongly on the specific situation regarding, for example, taxes, fees, and the technical characteristics of the installation concerned. It is not possible to evaluate such site-specific factors fully in this document. In the absence of data concerning costs, conclusions on economic viability of techniques are drawn from observations on existing installations.

It is intended that the general BAT in this section are a reference point against which to judge the current performance of an existing installation or to judge a proposal for a new installation. In this way they will assist in the determination of appropriate 'BAT-based' conditions for the installation or in the establishment of general binding rules under Article 9(8). It is foreseen that new installations can be designed to perform at or even better than the general BAT levels presented here. It is also considered that existing installations could move towards the general BAT levels or do better, subject to the technical and economic applicability of the techniques in each case.

While the BAT reference documents do not set legally binding standards, they are meant to give information for the guidance of industry, Member States and the public on achievable consumption and emission levels when using specified techniques. The appropriate limit values for any specific case will need to be determined taking into account the objectives of the IPPC Directive and the local considerations.

As discussed earlier in this document, titanium dioxide is currently produced using two distinct process routes: chloride and sulphate. New TiO<sub>2</sub> plants in the EU are likely to adopt the chloride process route, as it offers better raw material and energy efficiency, along with a more compact plant layout which typically benefits in reduced scope of plant maintenance.

Subject to maintaining low chlorine inventory and measures to reduce the environmental risks associated with chlorine and titanium tetrachloride handling, commensurate with the application of the SEVESO II Directive, the chloride process is preferable from the point of view of overall environmental impact in the EU.

However, given the findings of the Life Cycle Analysis, neither process route is de facto selected as BAT and conclusions for both process routes are presented here in parallel.

### **For titanium dioxide plants in the EU-25, the following are BAT:**

#### **3.5.1 The chloride process route**

1. After the basic choice of feedstock has been determined, based on, e.g. life cycle assessment considerations, select and use natural TiO<sub>2</sub> ores or synthetic TiO<sub>2</sub> feedstocks with a TiO<sub>2</sub> content and impurities (including magnesium, calcium, silica, and heavy metals) levels that are cost-effective and that will cause low environmental impacts and efficient use of energy and other non-renewable resources at the TiO<sub>2</sub> plant site – see Sections 3.2.2.1, 3.2.3.2, and 3.2.3.4.1.

The application of this BAT is connected with environmental impacts upstream of the TiO<sub>2</sub> plant site (ore mining and upgrading), therefore, an integrated approach and good industrial practice should be applied in each case of TiO<sub>2</sub> feedstock selection, in order to achieve a high general level of protection of the environment as a whole – refer to Section 3.4.5.

2. Manage supplies, transport, receipt and storage of the TiO<sub>2</sub> ore to maintain a moisture content below 0.3 %, so as to reduce the need for drying of the ore prior to processing – see Section 3.2.4.1.1.

3. Select and use coke with a low sulphur content, as a primary measure to ensure that SO<sub>2</sub> emissions during the normal operation of a plant using an effective off-gas scrubbing system are below 1.7 kg/t TiO<sub>2</sub> pigment – see Sections 3.2.3.4.2, 3.2.3.4.7, 3.2.4.1.3, and 3.2.4.5.
4. Maintain a low chlorine inventory commensurate with application of the SEVESO II Directive – see Section 3.2.4.1.4.
5. Ensure steady state operation of the chlorinator(s) at optimum fluidisation velocity, in order to maintain a high conversion rate of the TiO<sub>2</sub> content in the ore, avoid chlorine slip, carryover of unreacted ore and coke, and build-up of solids in the reactor(s) – see Section 3.2.4.2.
6. Design and operate the chlorination unit allowing for easy and rapid maintenance to minimise unplanned downtime and to avoid uncontrolled emissions – see Section 3.2.4.2.

Possible measures include: the system of water film cooling of the outer surface of the chlorinator shell with the associated temperature monitoring system of chlorinator(s), standby chlorination reactor as an reserve to operating chlorination reactor(s), and the maintenance system allowing for rapid interchangeability between the operational chlorinator being turned off and a standby chlorinator.

7. Ensure that metal chlorides, originating from impurities contained in the ore, are appropriately treated to recover ferrous chloride (FeCl<sub>2</sub>) solution from the process, consistent with local market availability, expected ferrous chloride quality and quantity available – see Sections 3.2.4.3 and 7.4.
8. Recover for re-use, the hydrochloric acid, sodium hypochlorite and sulphur from the process off-gas, consistent with local market availability, expected product quality and plant economics – see Sections 3.2.4.5 and 3.2.4.11.
9. For efficient oxidation of TiCl<sub>4</sub> into TiO<sub>2</sub>, use a toluene fired furnace or a plasma arc furnace, taking into consideration energy input and the reliability of plant operation, as well as the costs and advantages of each oxidation technique – see Section 3.2.4.7.
10. Design and operate the oxidation and chlorination units in tandem with direct chlorine recycling in the process loop, to achieve low inventory of TiCl<sub>4</sub>, minimum chlorine consumption, and low energy usage – see Section 3.2.4.9.
11. Minimise the carryover of the TiO<sub>2</sub> dust from the oxidation system to the chlorine recycling loop, using bag filters or similar, in order to minimise the risk of malfunction in the chlorinator due to solids build-up – see Section 3.2.4.8.
12. Minimise the emission of TiO<sub>2</sub> dust and the discharge of TiO<sub>2</sub> particles in liquid effluents originating from the finishing operations – see Sections 3.2.3.4.8 and 3.2.3.7. Refer also to BAT 14 (1) and 15 (2) below.
13. Improve the overall energy efficiency in the chloride process in the range of 17 – 25 GJ/t TiO<sub>2</sub> pigment (for plants operated at full capacity level), noting that the finishing section consumes majority of the total energy (in the range of 10 – 15 GJ/t TiO<sub>2</sub> pigment), the energy use being highly dependent on the characteristics of the final product. An increase of energy required in the wet treatment and finishing operations is foreseen if customer specifications call for a finer particle size in the final pigment product – see Sections 3.2.3.3.1, 3.2.3.7, 3.2.4.12, 3.3.2.9 and 3.3.3.2.1.

14. Total emission levels to air associated with the application of BAT, are:

- |                            |  |
|----------------------------|--|
| 1) Dust/particulate matter | 0.1 – 0.2 kg/t TiO <sub>2</sub> pigment  |
| 2) SO <sub>2</sub>         | 1.3 – 1.7 kg/t TiO <sub>2</sub> pigment  |
| 3) HCl                     | 0.03 – 0.1 kg/t TiO <sub>2</sub> pigment |

15. Total emission levels to water associated with the application of BAT, are:

- |                      |  |
|----------------------|--|
| 1) Hydrochloric acid | 10 – 14 kg/t TiO <sub>2</sub> pigment    |
| 2) Chlorides         | 38 – 330 kg/t TiO <sub>2</sub> pigment*  |
| 3) Suspended solids  | 0.5 – 2.5 kg/t TiO <sub>2</sub> pigment  |
| 4) Iron compounds    | 0.01 – 0.6 kg/t TiO <sub>2</sub> pigment |

(\*). For chlorides, the absorption capacity of the receiving water and the raw materials used should be taken into consideration at the local level.

Due to insufficient data reported, no particular techniques associated with the reduction of the emissions of Hg, Cd, V, Zn, Cr, Pb, Ni, Cu, As, Ti and Mn, were identified.

### 3.5.2 The sulphate process route

1. After the basic choice of feedstock has been determined, based on, e.g. LCA considerations and plant capabilities, select and use TiO<sub>2</sub> feedstocks with as low as practical level of harmful impurities, in order to reduce consumption of raw materials and energy, and reduce waste generation. Both titanium slag and ilmenite can be chosen and used either separately or in blends, on condition that they are cost-effective and that they will cause low environmental impacts and efficient use of energy and other non-renewable resources at the TiO<sub>2</sub> plant site – see Sections 3.3.2.1, 3.3.3.1.1 and 3.3.4.1.

The application of this BAT is connected with environmental impacts upstream of the TiO<sub>2</sub> plant site (ore mining and upgrading), therefore, an integrated approach and good industrial practice should be applied in each case of TiO<sub>2</sub> feedstock selection, in order to achieve a high general level of protection of the environment as a whole – refer to Section 3.4.5.

2. Manage supplies, transport, receipt and storage of the TiO<sub>2</sub> feedstock to maintain a low moisture content so as to prevent the need for drying the feedstock prior to milling and processing – see Section 3.3.4.2.
3. Minimise dust emissions from the handling, drying and milling of the ore, using high integrity bag filters with appropriate filter cloth material and a maintenance routine to control dust losses – see Sections 3.3.3.3.1 and 3.3.4.2. Refer also to BAT 18 (1) below.
4. Mill the ore to an optimum size to maximise the efficiency of digestion – see Section 3.3.4.2.
5. Both batch and continuous digestion of the ore can be used, bearing in mind that continuous digestion is more applicable with ilmenite as a feedstock, and that there is a large amount of expertise within the industry in optimising batch process for maximum efficiency – see Section 3.3.4.3.

6. Treat digester off-gases in order to reduce emissions of sulphur and produce usable sulphur compounds as by-products downstream of the plant site – see Sections 3.3.3.3.2 and 3.3.4.10.1. Refer also to BAT 18 (2) below.
7. For the reduction of ferric ions to ferrous ions in the digester liquor use iron scrap of an appropriate quality to prevent the contamination of the solution with heavy metals like chromium or nickel. The surface of the scrap must be free of dirt, oil, grease, and other contaminants – see Sections 3.3.2.3 and 3.3.4.4.
8. For the processing of ilmenite based feedstocks, apply a batch or continuous system for crystallisation and separation of copperas (iron sulphate heptahydrate) to optimise its removal from the process for downstream uses – see Section 3.3.4.5.
9. For hydrolysis of titanyl sulphate and  $\text{TiO}_2$  hydrate precipitation, apply a nuclei producing system, to allow consistent particle size distribution of the calciner discharge – see Section 3.3.4.6.
10. For filtration of the titanium dioxide hydrate from the mother liquor ('strong acid'), use a system which allows the most efficient separation of strong and weak acid, so as to separate the maximum amount of undiluted strong acid from the filter cake prior to its washing – see Section 3.3.4.7.
11. When using acid neutralisation for the utilisation of spent post-hydrolytic ('strong') sulphuric acid, minimise the amount of material sent for disposal by optimising the production of useable gypsum products – see Sections 3.3.3.2.1, 3.3.4.11, 3.3.4.11.2 and 3.3.4.12.
12. Where spent acid is reconcentrated and re-used at the  $\text{TiO}_2$  plant site or off site, either for the digestion of titanium ore or the manufacture of other co-products (such as wet phosphoric acid, fertilisers, cement additives), minimise energy consumption for the concentration of sulphuric acid and salt roasting, while reducing the content of the metal sulphates in the concentrated acid to the minimum level, in order not to allow for their build up in the acid recycling loop – see Sections 3.3.3.2.1, 3.3.4.11, 3.3.4.11.1, 3.3.4.12 and 3.3.4.13.
13. Use calcination systems that minimise energy usage without compromising the quality of the  $\text{TiO}_2$  pigments, such as pressure filters prior to calcining and hot off-gases recycling on the kilns to save energy – see Sections 3.3.4.7 and 3.3.4.8.
14. For the calciner off-gas treatment, apply the system in which typically dust and  $\text{SO}_3$  aerosol are removed by electrostatic precipitators, while the  $\text{SO}_2$  component of the gas is catalytically oxidised to  $\text{SO}_3$  and absorbed to form sulphuric acid, which is then recycled – see Sections 3.3.3.3.5, 3.3.4.8 and 3.3.4.10.2. Refer also to BAT 18 (2) below.
15. Promote the recovery and production of ferrous sulphate, ferric sulphate, iron oxide, and other copperas related products, as well as reconcentrated sulphuric acid and gypsum, which are all potential co-products in the manufacturing of  $\text{TiO}_2$  by the sulphate process – see Section 3.3.4.12.
16. Minimise the emission of  $\text{TiO}_2$  dust and the discharge of  $\text{TiO}_2$  particles in liquid effluents originating from the finishing operations – see Sections 3.3.3.3.6, 3.3.3.4 and 3.3.4.9. Refer also to BAT 18 (1) and 19 (2) below.

17. Improve the overall energy efficiency in the sulphate process (for plants operated at full capacity level) in the range of 23 – 41 GJ/t TiO<sub>2</sub> pigment (see Sections 3.3.3.2.1, 3.3.4.11 and 3.3.4.13) and from this:

- 1) 23 – 29 GJ/t TiO<sub>2</sub> pigment in the process with sulphuric acid neutralisation
- 2) 33 – 41 GJ/t TiO<sub>2</sub> pigment in the process with sulphuric acid reconcentration.

Given different combinations of systems used across the EU TiO<sub>2</sub> industry for acid neutralisation and/or acid reconcentration, the extreme ranges as in 1) and 2) above, apply only as indicative levels for the estimation of the overall energy efficiency in the TiO<sub>2</sub> plant in question.

Note also that the finishing section consumes a large share of the total energy (in the range of 10 – 15 GJ/t TiO<sub>2</sub> pigment), and this energy use is highly dependent on the characteristics of the final product. An increase of energy required in the finishing operations is foreseen if customer specifications call for finer particle size in the final pigment product.

Increased sulphate removal from liquid effluent streams requires higher energy usage.

18. Total emission levels to air associated with the application of BAT (for all the possible configurations of the titanium dioxide plant based on sulphate process), are:

- |                            |  |
|----------------------------|--|
| 1) Dust/particulate matter | 0.004 – 0.45 kg/t TiO <sub>2</sub> pigment<br><5 – 20 mg/Nm <sup>3</sup> |
| 2) SO <sub>2</sub>         | 1.0 – 6.0 kg/t TiO <sub>2</sub> pigment                                  |
| 3) NO <sub>2</sub>         | monitor NO <sub>x</sub> emissions from the calciner*                     |
| 4) H <sub>2</sub> S        | 0.003 – 0.05 kg/t TiO <sub>2</sub> pigment                               |

(\* ) There is no evidence that any primary measures are used in this industry. NO<sub>x</sub> monitoring can help find the basis for future actions.

19. Total emission levels to water associated with the application of BAT (for all the possible configurations of the titanium dioxide plant based on sulphate process), are:

- |                          |  |
|--------------------------|--|
| 1) SO <sub>4</sub> total | 100 – 550 kg/t TiO <sub>2</sub> pigment    |
| 2) Suspended solids      | 1.0 – 40 kg/t TiO <sub>2</sub> pigment     |
| 3) Iron compounds (Fe)   | 0.3 – 125 kg/t TiO <sub>2</sub> pigment    |
| 4) Mercury (Hg)          | 0.32 mg – 1.5 g/t TiO <sub>2</sub> pigment |
| 5) Cadmium (Cd)          | 1.0 mg – 2.0 g/t TiO <sub>2</sub> pigment  |

Due to insufficient data reported, no BAT AELs were identified for V, Zn, Cr, Pb, Ni, Cu, As, Ti and Mn.

## 4 CARBON BLACK

### 4.1 General information

#### 4.1.1 The carbon black industry

About 65 % of the world's consumption of carbon black is used in the production of tyres and tyre products for automobiles and other vehicles. Roughly 30 % goes into other rubber products such as hose, belting, mechanical and moulded goods, footwear and other uses, with the remainder being used in plastics, printing ink, paint, paper and miscellaneous applications [13, EIPPCB, 2000].

Long term growth in carbon black consumption is expected to closely parallel that of the rubber industry at about 1 – 2 % per year [13, EIPPCB, 2000], [47, InfoMil, 2002].

This relatively low percentage – when compared to the production records of the automotive industry – is due to the fact that the service life of tyres has been continuously improving. Therefore, the growth rate of other products using carbon black is more pronounced [47, InfoMil, 2002]. Variations around this growth line will depend on the cost of energy and on environmental issues, including partial replacement of carbon black by silica to produce the 'green' tyre [13, EIPPCB, 2000].

Today, the global installed capacity is approximately eight million tonnes per year, with a worldwide demand for carbon blacks currently in the order of six million tonnes per year. This quantity is produced by more than 150 carbon black plants situated in 35 countries [47, InfoMil, 2002]. The most important regions are north America, western and eastern Europe, and Asia, while south America, Africa, and Australia are at the lower end of the scale.

As a member of the carbon family, carbon black differs from other carbon-based materials in many respects, with an important difference being that of bulk density. This property has prompted carbon black production facilities to be located as close as possible to consumers since, when compared with carbon black feedstock, the transportation costs for carbon black are considerably higher. Consequently, carbon black plants are concentrated in those parts of the world where major portions of the industry requiring this material are located.

The production capacity of carbon black (1996) by geographical regions is given in Table 4.1.

Country or region	Capacity, kt per year
North America	1815
Western Europe	1310
Eastern Europe	1545
Asia	2630
South America	480
Africa, Australia	185
Total	7965

**Table 4.1: Carbon black production capacity (1996)**  
[47, InfoMil, 2002]

Since carbon black is predominantly used in rubber products – mainly in tyres – most carbon black production facilities are located in countries that have large tyre and automotive industries.

Table 4.2 shows the carbon black capacity and number of plants in western Europe.



Country	Capacity, kt per year	Number of plants	Location
Germany	365	3	Dortmund, Hannover, Hürth-Kalscheuren
France	305	3	Berre L'etang, Lillebonne, Ambes
Italy	245	3	Ravenna, Ravenna, S. Martino di Trecate
United Kingdom	210	2	Stanlow/Ellesmere Avonmouth
Netherlands	155	2	Rozenburg Botlek – Rotterdam
Spain	120	2	Puerto de Zierbenna Santander
Sweden	40	1	Malmö
Belgium	10	1	Willebroek
Portugal	35	1	Sines
Czech Republic	75	1	Valasske-Mezirici
Hungary	70	1	Tiszaujvaros
Poland	45	2	Jaslo, Gliwice
<b>Total EU-25</b>	<b>1675</b>	<b>22</b>	
Romania	30	1	Pitesti
Croatia	40	1	Kutina
<b>Total Europe</b>	<b>1745</b>	<b>24</b>	

**Table 4.2: Carbon black production: capacity, number of plants and location in Europe [47, InfoMil, 2002]**

Following the rationalisation and concentration of the automotive and tyre industries, a consolidation of the carbon black industry occurred. The result was that of five major US based producers having worldwide activities in 1980, only two companies (company 1 and 3 in the list given in Table 4.3) survived – with the German-based company 2 shown in Table 4.3 becoming a third major producer. These three global companies, together with local producers having capacities in excess of 200 kt per year, are listed in Table 4.3.

Company name/Country*	Number of plants	Estimated capacity, kt per year	Capacity share, %
1. Company 1/US	26	1725	22
2. Company 2/Germany	15	1163	15
3. Company 3/US	12	1100	14
4. Company 4/US	3	270	4
5. Company 5/US	3	245	3
6. Company 6/Japan	3	230	3
7. Company 7/US	3	200	3
<b>Total 'Big Seven'</b>	<b>65</b>	<b>4933</b>	<b>64</b>
<b>Total 'Others'</b>	<b>88</b>	<b>3060</b>	<b>36</b>
<b>World total</b>	<b>153</b>	<b>~8000</b>	<b>100</b>

\* Plants and their capacities are included if at least 50 % of the shares are controlled by the company

**Table 4.3: Major world carbon black producers [47, InfoMil, 2002]**

Table 4.3 shows that the seven major producers listed account for 64 % of the total world capacity with the three top global producers sharing 51 % between them. The three leading companies are not only the leading manufacturers of rubber grades, but also of pigment and speciality blacks on a worldwide basis.

### 4.1.2 Applications of carbon black

While carbon black was exclusively used as a pigment until the beginning of this century, its use as an active filler in rubber was the starting point for a new rapidly expanding application. In automobile tyre production, it was found that treads filled with carbon black had a markedly higher abrasion resistance than those filled with zinc oxide. This discovery, together with increasing use of motor vehicles, was the basis for the present importance of carbon black as a filler in rubber. Today, at least 35 different grades of carbon black are used as fillers in rubber, and about 80 grades are used in pigments or special applications [47, InfoMil, 2002]. Table 4.4 shows the fields of application of carbon black.

<b>Rubber industry</b>	<b>%</b>	<b>Non-rubber industry</b>	<b>%</b>
<b>Total rubber</b>	<b>90</b>	<b>Total non-rubber</b>	<b>10</b>
Tyres	72	Printing inks	30
Mechanical rubber goods	28	Plastics	36
		Coatings/Paints	9
<b>Total</b>	<b>100</b>	Paper	4
		Others	21
		<b>Total</b>	<b>100</b>

**Table 4.4: Breakdown of total carbon black sales according to the fields of application [47, InfoMil, 2002]**

Approximately 90 % of all carbon black sales are to the rubber industry [47, InfoMil, 2002]. However, while the major portion of carbon black is sold to the tyre industry, carbon black is also used by the automotive and the rubber industries in general as a major component in the production of mechanical rubber goods. Carbon black production is, therefore, largely dependent on developments in the automotive industry.

The remaining 10 % of carbon black sales are to the non-rubber industry. Carbon black is used by the printing industry (for pigment blacks in printing inks) and by the plastic industry. These sectors consume roughly one-third each of the total pigment black sales. A further important application, especially for the higher priced, fine particle size carbon blacks, is in the production of black coatings/paints, which accounts for approximately 9 % of production. This is followed by the paper industry, accounting for approximately 4 %. Other non-rubber areas are, for example, the manufacture of electrodes and the reduction of metal oxides. Together, these applications have a share of about 21 % of total non-rubber carbon black sales.

About 90 % of the carbon black produced is used by the rubber industry as a reinforcing filler in tyres, tubes, conveyor belts, cables, rubber profiles, and other rubber goods. Furnace blacks are predominantly used in rubber processing. Fine particle size carbon blacks (reinforcing blacks) are used for the production of rubber mixtures with high abrasion resistance (e.g. tyre treads). Coarser carbon blacks (semi-reinforcing blacks) are used in rubber mixtures requiring low heat build-up and resistance to permanent deformation during dynamic stress (e.g. carcase compounds, equipment mountings, and seals). Extremely coarse carbon blacks (non-reinforcing blacks) are incorporated into mixtures with high elasticity and good extrusion properties.

Quantitatively, the pigment blacks are substantially less important than the rubber blacks. They are used for the manufacture of printing inks, colouring plastics, fibres, lacquers, coatings, and paper. Oxidised carbon blacks are frequently used in the printing ink and coating industry. While high-colour gas blacks are still predominant in lacquers and coatings, furnace blacks are becoming more and more important in plastics, coatings, and printing inks. Besides their two main uses as reinforcing fillers and pigments, small amounts of carbon blacks are used by the electrical industry to manufacture dry cells, electrodes, and carbon brushes. Special blacks are used to give plastics antistatic or electrical conduction properties. Another application is the UV stabilisation of polyolefins.

## 4.2 Applied processes and techniques

### 4.2.1 Introduction

The term 'carbon black' is used for a group of well-defined, industrially manufactured products, which are produced under carefully controlled conditions. The physico-chemical properties of each grade of carbon black are kept within narrow specifications. Carbon black is a form of highly dispersed elemental carbon with extremely small particles. Depending on the raw materials and production processes, carbon black also contains chemically bound hydrogen, oxygen, nitrogen, and sulphur.

Due to its excellent pigmentation properties, especially its light stability and universal insolubility, carbon black has been used as a black pigment since early times. It was produced for this purpose by burning oils, fats, or resinous materials (see Section 4.2.2). The flame was either quenched on a cool surface 'impingement black', or cooled in special stacks 'lamp black' where the carbon black was deposited. Today, both methods are still used in the various production processes of carbon black (see Section 4.2.3).

The 'channel black process', a process for making impingement blacks using natural gas as a raw material, has been used in the United States since the end of the 19th century. This process has now been abandoned because of economic and environmental considerations. A similar process for the production of impingement blacks, the 'gas black process', is still used today (see Section 4.2.3.2).

The increasing demand for carbon black led to new production processes. The most important process today is the 'furnace black process' (see Section 4.2.3.1). Developed in the United States in the 1930s and substantially improved in the 1950s, it is a continuous process, which allows the production of a variety of carbon black grades under carefully controlled conditions. Nearly all rubber grades and a significant part of pigment-grade carbon blacks are now manufactured by the furnace black process. Nevertheless, other processes, such as 'gas black', 'lamp black', 'thermal black', and 'acetylene black' processes, are still used for the production of specialities. These processes are further elaborated in Sections 4.2.3.2 to 4.2.3.5.

The following sections detail the sequence of carbon black production, beginning with the commonly used raw materials (Section 4.2.2); the various production processes (Section 4.2.3); and the oxidative after-treatment process (Section 4.2.4), which is common to all production processes.

### 4.2.2 Raw materials

Mixtures of gaseous or liquid hydrocarbons, which can be vaporised, represent the raw materials preferable for the industrial production of carbon black. Since aliphatic hydrocarbons give lower yields than aromatic hydrocarbons, the latter are primarily used. Unsubstituted polynuclear compounds with 3 – 4 rings give the best yield [47, InfoMil, 2002].

The materials rich in these compounds are certain fractions of coal tar oils and petrochemical oils from petroleum refining or the production of ethylene from naphtha (aromatic concentrates and pyrolysis oils). These aromatic oils, which are mixtures of a variety of substances, are the most important feedstock today. Oil on a petrochemical basis is predominant. The aromatic portion of a typical petrochemical oil consists of 10 – 15 % monocyclic, 50 – 60 % bicyclic, 25 – 35 % tricyclic, and 5 – 10 % tetracyclic aromatics [47, InfoMil, 2002].

Important characteristics determining the quality of a feedstock are the C/H ratio as determined by elemental analysis and the Bureau of Mines Correlation Index (BMCI), which is calculated from the density and the mid-boiling point or from the density and the viscosity.

Both the C/H ratio and BMCI values give some information on the aromaticity and, therefore, the expected yield. Further characteristics are viscosity, pour point, temperature of solidification, alkali metal content (due to its influence on the carbon black structure), and sulphur content.

Natural gas, which was previously the predominant feedstock for the production of channel blacks, has lost its importance for economic reasons. However, natural gas is still the most important secondary feedstock in the furnace black process, although other gases and oils are used in some cases. The term ‘secondary feedstock’ is used for easier distinction between the primary feedstock as the main carbon source for the carbon black. In the rest of this chapter, a practical distinction will be made between primary feedstock and secondary feedstock. The term ‘fuel’ will be then reserved for non-reactor related combustion processes. In several patents, recycled tail-gas, in combination with oxygen or oxygen-enriched air, has also been proposed as a secondary feedstock, but has not gained any commercial importance. Moreover, acetylene, due to its high price, is used only as a feedstock for the production of highly specialised conductivity blacks (e.g. used in dry cell batteries).

Sulphur content in the feedstock used in the production of carbon black is of key importance for the assessment of the environmental impact of the European carbon black plants [47, InfoMil, 2002]. The permitted annual average S-levels of the feedstock used in carbon black plants in Europe and the US are presented in Table 4.5.

Region	Plant(s)	S content	Commodity	Speciality
North America	1	up to 4.5 %	x	
North America	2	up to 4.5 %	x	
North America	3, 5, 7	4.00 %	x	
North America	4, 6, 9	4.00 %	x	x
North America <sup>(*)</sup>	8	4.00 %	x	
North America	10	3.70 %	x	
North America	11	3.60 %	x	
North America	12	3.50 %	x	
North America	13, 14, 15, 16, 17	3.00 %	x	
North America	18	3.00 %	x	x
North America	19	2.50 %	x	x
North America	20	2.50 %	x	
North America	21	1.80 %	x	x
Europe	a, b	3.00 %	x	
Europe	c	2.80 %	x	
Europe	d	2.50 %	x	x
Europe	e	2.50 %	x	
Europe	f	2.20 %	x	x
Europe	g, j	2.00 %	x	
Europe	h, i	2.00 %	x	x
Europe	k	1.80 %	x	
Europe	l, m	1.70 %	x	
Europe	n	1.50 %	x	
Europe	o	1.50 %	x	x
Europe	p	1.00 %	x	
Europe	q	1.00 %	x	x
Europe	r	0.80 %	x	x
Europe	s	0.70 %	x	
Europe	t	0.60 %	x	

(\*) 6 % at 75 % utilisation

**Table 4.5: Permitted S-levels of north American and European carbon black plants [47, InfoMil, 2002]**

### 4.2.3 Production processes

A summary of the most important production processes is given in Table 4.6. In general, the processes are divided into two groups: those employing incomplete or partial combustion and those based on thermal cracking (pyrolysis) [47, InfoMil, 2002]. This nomenclature is somewhat misleading insofar as the carbon black resulting from the partial combustion process is also formed by pyrolysis. The two types of processes differ in that, in the partial combustion processes, air is used to burn part of the feedstock, thus producing the energy required to carry out the pyrolysis, whereas in the thermal cracking process, heat is generated externally and introduced into the process.

Chemical process	Manufacturing process	Percentage of global production	Feedstock
Partial combustion	Furnace black process	>95 %	Petrochemical oils, coal tar oils and natural gas
	Gas black process	<5 %	Coal tar oils
	Channel black process		Natural gas
	Lamp black process		Petrochemical/coal tar oils
Thermal cracking	Thermal black process		Natural gas, oil
	Acetylene black process		Acetylene

**Table 4.6: Manufacturing processes and feedstock used for the production of carbon black [47, InfoMil, 2002]**

The furnace black process is currently the most important production process. It accounts for more than 95 % of the total worldwide production [47, InfoMil, 2002]. The advantages of the furnace black process are its great flexibility, which allows the manufacture of various grades of carbon black, and its better economy compared to other processes. The following comparison makes this apparent: for similar grades of carbon black, the production rate of one flame is approximately 0.002 kg/h for channel black, approximately 0.2 kg/h for gas black, and approximately 2000 kg/h for a modern furnace black reactor. Some furnace black reactors have production rates of up to 5000 kg/h.

However, in spite of the more advantageous furnace black process, the production processes listed in Table 4.6 (except for the channel black process that is no longer operated) are still in use for the production of special carbon blacks which cannot be obtained via the furnace black process.

#### 4.2.3.1 Furnace black process

In the last few decades, the rapidly expanding automobile industry required increasing numbers of tyres with various characteristics. This led not only to the development of new rubber grades, but also to the development of new carbon blacks required by the increasingly refined application processes and to the development of a new and better manufacturing process, the furnace black process. Unlike the old channel black process, this process allows the production of virtually all grades of carbon black required by the rubber industry.

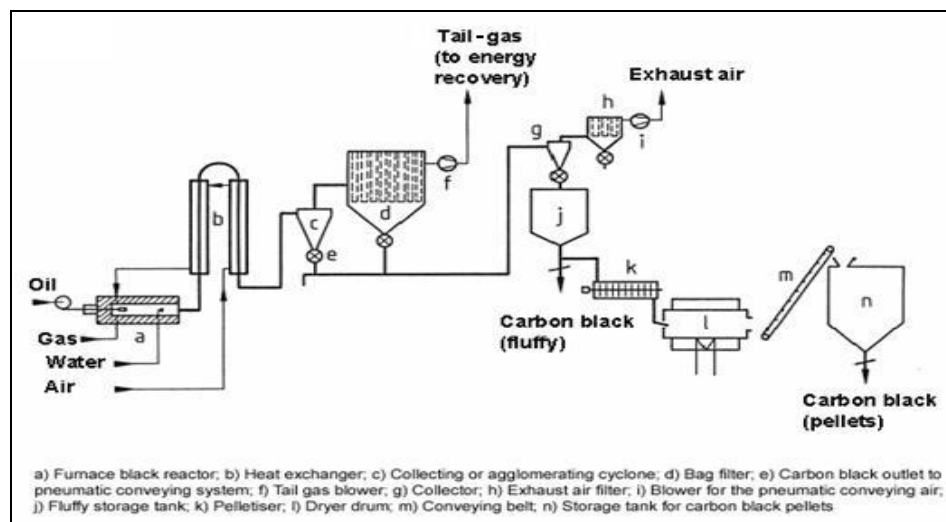
The furnace black process was developed in the United States in the 1920s and since then, it has been greatly refined. In the late 1930s it was developed as a truly continuous process, carried out in closed reactors, so that all inputs can be carefully controlled.

The heart of a furnace black plant is the furnace in which the carbon black is formed. The primary feedstock is injected, usually as an atomised spray, into a high temperature zone of high energy density, which is achieved by burning a secondary feedstock (natural gas or oil) with air.

The oxygen, which is in excess with respect to the secondary feedstock, is not sufficient for complete combustion of the primary feedstock, the majority of which is, therefore, pyrolysed to form carbon black at 1200 – 1900 °C.

The reaction mixture is then quenched with water and further cooled in heat exchangers, and the carbon black is collected from the tail-gas by a filter system.

Figure 4.1 shows a schematic drawing of a furnace black production plant.



**Figure 4.1: Furnace black process**  
[47, InfoMil, 2002]

The primary feedstock, preferably petrochemical or carbo-chemical heavy aromatic oils, some of which begin to crystallise near ambient temperature, is stored in open to air, vented and heated tanks equipped with circulation pumps to maintain a homogeneous mixture. The primary feedstock is pumped to the reactor via heated and/or insulated pipes to a heat exchanger, where it is heated to 150 - 250 °C to obtain a viscosity appropriate for atomisation. Various types of spraying devices are used to introduce the primary feedstock into the reaction zone.

As the carbon black structure can be influenced by the presence of alkali metal ions in the reaction zone, alkali metal salts, preferably aqueous solutions of potassium salts (e.g. potassium carbonate, hydroxide or chloride), are often added to the oil in the oil injector. Alternatively, the additives may be sprayed separately into the combustion chamber. In special cases, other additives, e.g. alkaline-earth metal compounds, which increase the specific surface area, are introduced in a similar manner.

The energy to break C-H bonds is supplied by feedstock, which provides the reaction temperature required for the specific grades. Natural gas, petrochemical oils and other gases, e.g. coke oven gas or vaporised liquid petroleum gas may be used as secondary feedstock. Depending on the type of secondary feedstock, special burners are also used to obtain fast and complete combustion. The required air is preheated in heat exchangers by the hot carbon black containing gases leaving the reactor. This saves energy and thus improves the carbon black yield. Preheated air temperatures of 500 – 700 °C are common.

The state-of-the-art carbon black plants install several production lines (or units) from the single high performance reactor to the silo for the final product, with throughputs as high as 20000 tonnes per year per line or higher. Present design optimises the quality, the yield and the operation of each plant.

The reactors of modern furnace black plants vary considerably in internal geometry, flow characteristics, and the manner in which fuel and feedstock are introduced. Nevertheless, they all have the same basic process steps in common: producing hot combustion gases in a combustion chamber, injecting the feedstock and rapidly mixing it with the combustion gases, vaporising the oil, pyrolysing it in the reaction zone, and rapidly cooling the reaction mixture in the quenching zone to temperatures of 500 – 800 °C.

All reactors have a gas-tight metal jacket. The reaction zone is coated with a ceramic inner liner, generally on an alumina base, which is stable to temperatures of approx. 1800 °C. Several quenching positions allow the effective reaction volume of the reactor to be adjusted. This allows variation of the mean residence time of the carbon black at the high reaction temperature. Typical residence times for reinforcing blacks are 10 – 100 ms.

Most furnace black reactors are arranged horizontally. Some vertical reactors are used especially for the manufacture of certain semi-reinforcing blacks.

The properties of carbon blacks depend on the ratios of primary feedstock, secondary feedstock and air, which therefore must be carefully controlled. The particle size of the carbon black generally decreases with increasing amounts of excess air relative to the amount needed for the complete combustion of the secondary feedstock. Since the excess air reacts with the primary feedstock, a greater amount of air leads to higher oil combustion rates, resulting in rising temperatures in the reaction zone. As a consequence, the nucleation velocity and the number of particles formed increase, but the mass of each particle and the total yield decrease.

The yields, which depend on the carbon black type and the type of primary feedstock, range between 40 and 65 % for some types of carbon black [47, InfoMil, 2002]. High surface area pigment blacks with markedly smaller particle size than rubber blacks give lower yields (10 - 30 %). Other parameters influencing carbon black quality are the manner in which the oil is injected, atomised, and mixed with the combustion gases, the type and amount of additives, the preheating temperature of the air and the quench position.

As long as the carbon black is in contact with the surrounding gases at the high reaction temperature, several reactions on the carbon surface occur (e.g. Boudouard reaction, water gas reaction), so that the chemical nature of the carbon black surface is modified with increasing residence time. When quenched to temperatures below 900 °C, these reactions are stopped and a certain state of surface activity is frozen. Varying the pelletising and drying conditions (see below) can also further modify carbon black surface properties.

The total mass put through a reactor can vary between 2 and 25 t/h. Although this is done at high streaming velocities (up to 800 m/s) and high temperatures (up to 1800 °C), modern high performance refractory lining can have lifetimes of two years and more. The metal reactor jackets last much longer. Because of the reducing atmosphere and the high temperatures in the reactor, the tail-gas, which consists of 30 – 50 vol-% water vapour, 30 – 50 vol-% nitrogen, and 1 - 5 vol-% carbon dioxide, also contains a certain amount of combustible gases, such as carbon monoxide and hydrogen.

Furthermore, traces of sulphur compounds (H<sub>2</sub>S, CS<sub>2</sub> and COS) and nitrogen compounds (HCN, NO<sub>x</sub>, NH<sub>3</sub>) are present in these gases. The amount of these compounds depends on the composition of the feedstock and the processing conditions. The combustible gases normally include 6 – 12 vol-% carbon monoxide, 6.5 – 14 vol-% hydrogen, small amounts of methane and other hydrocarbons. The lower heating value lies between 1.7 and 3.8 MJ/m<sup>3</sup>. The gas is normally burned for environmental reasons, and a portion of its energy is used, e.g. for heating dryer drums and for the production of steam and/or electricity. At many plants, the remaining portion of the tail-gas is combusted using a flare.

Table 4.17 and Table 4.18 give an overview of the main use of the tail-gas in the different European and North American carbon black plants.

The mixture of gas and carbon black leaving the reactor is cooled to 250–350 °C in heat exchangers by counter-flowing combustion air and then conducted into the collecting system. Formerly, a combination of electro-flocculators and cyclones or cyclones and filters were used. Currently, simpler units are preferred. Generally, the collecting system consists of only one high performance bag filter with several chambers, which are periodically purged by counter-flowing filtered gas or by pulse-jets. Occasionally, an agglomeration cyclone is installed between the heat exchanger and the filter.

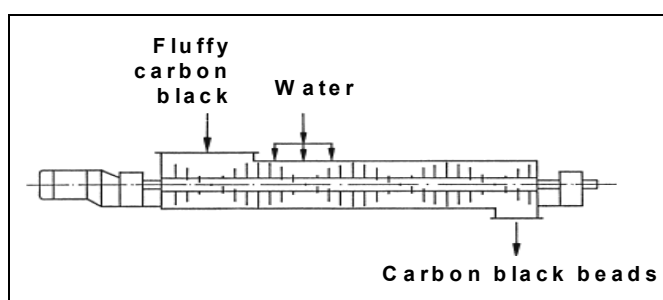
Depending on the capacity of the production unit, the filter may contain several hundred bags with a total filter area of several thousand square metres. Usual filter loads are in the order of 0.2–0.4 m<sup>3</sup>.m<sup>-2</sup>.min<sup>-1</sup>.

Since the filtered gas contains approx. 30–50 vol-% water vapour, most filters operate at temperatures above 200 °C to avoid condensation. The residual carbon black content in the filtered tail-gas is less than 100 mg/m<sup>3</sup> in western countries. The fluffy carbon black coming out of the filter is pneumatically conveyed into a first storage tank. Small amounts of solid impurities ('grit,' e.g. iron, rust, or coke particles) are either removed by magnets and classifiers or milled to an appropriate consistency.

Fluffy carbon black has an extremely low bulk density of 20–60 g/l. To facilitate handling and further processing by the customer, it must be compacted. Densification by 'outgassing' – a process by which the carbon black is passed over porous, evacuated drums – is the weakest form of compacting and allows the carbon black to retain its powdery state. This form of compacting is used for certain pigment blacks, which must retain easy dispersibility. Other pigment blacks and rubber blacks are compacted by pelletisation. Two processes are used: dry and wet pelletisation.

Dry pelletisation is a simple and energy saving method, but it does not work with all types of carbon black. It is mainly used for pigment black. Dry pelletisation is carried out in rotating drums, where the powdery carbon black rolls to form small spheres.

The wet pelletisation process is used for the majority of rubber blacks. Carbon black, water, and small amounts of additives (e.g. molasses, ligninosulphonates) are mixed in special pelletisers. They usually consist of a horizontal cylinder approx. 3 m long and 0.7–1 m in diameter, in the axis of which a pin shaft rotates at 300–750 rpm. The pelleting machine used in the wet pelletisation process is presented in Figure 4.2.



**Figure 4.2:** Pelleting machine used in the wet pelletisation process [47, InfoMil, 2002]

During the wet pelletisation process, the water containing the pelletising agents dissolved in it, is injected via spray nozzles. The density of the pelletised material is approx. 10 times that of the original carbon black. The pellet crush strength and some application properties in rubber can be influenced by the type and amount of the pelletising agent. The size of the pellets is approx. 1–2 mm. The carbon black leaving the pelletising machine contains approximately 50 wt-% water. It is dried in dryer drums by a variety of means.



The most common method is indirect heating by combusting tail-gas. Drying temperatures, generally between 150 and 250 °C, allow further modification of the carbon black properties. The dried carbon black is transported via conveyor belts and elevators to the storage tank or packing station. Bulk densities of wet-pelletised carbon blacks are between 250 and 550 g/l.

A flow diagram illustrating the complete furnace black process is shown in Figure 4.3.

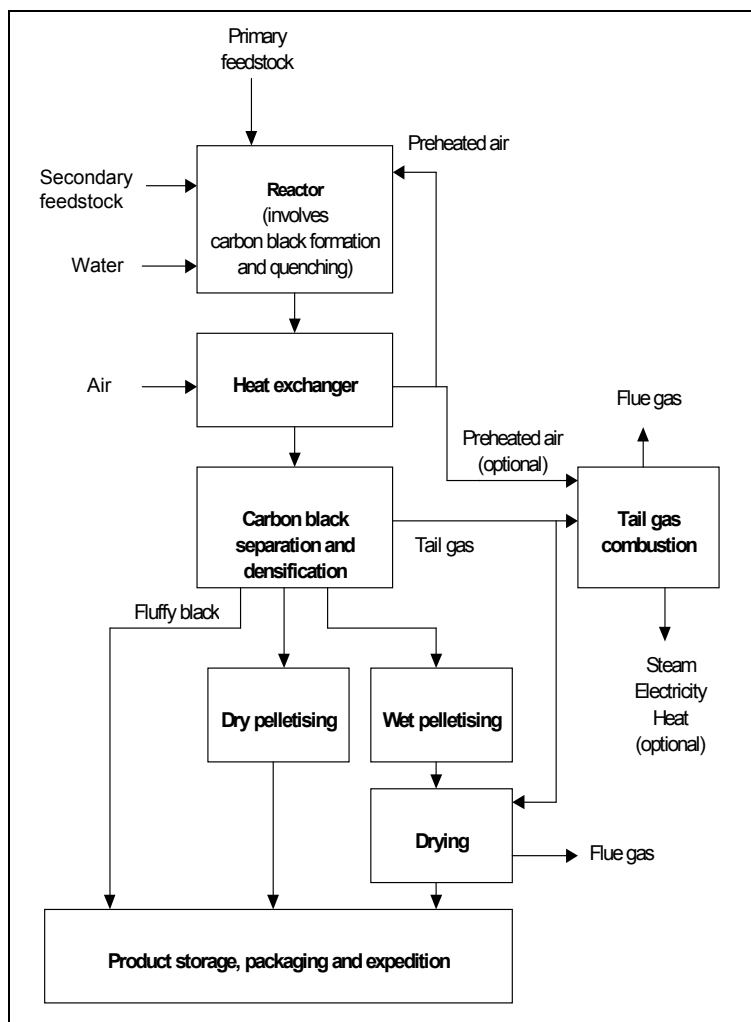
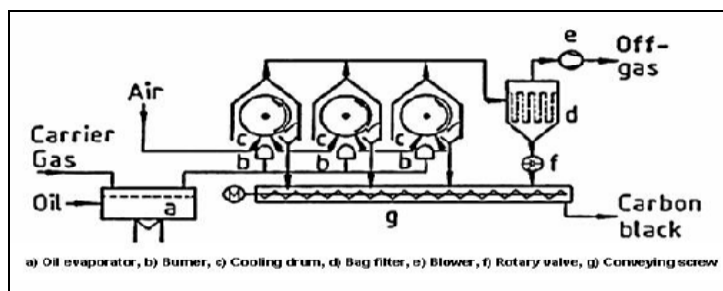


Figure 4.3: Example of possible configuration of the furnace black process [47, InfoMil, 2002]

#### 4.2.3.2 Channel black and gas black processes

The channel black process, which had been used in the United States since the late 1800s, was the oldest process for producing small particle size carbon blacks on an industrial scale. Originally, this process also produced the first reinforcing blacks. In 1961, world production of channel black was about 120 kt. Due to low profitability and environmental difficulties, the last production plant in the United States was closed in 1976. Natural gas was used as the feedstock. The carbon black yield was only 3 – 6 %.

The gas black process was developed in the 1930s, in Germany, where natural gas was not available in sufficient amounts. It is similar to the channel black process, but uses coal tar oils instead of natural gas. Yields and production rates are much higher with oil-based feedstock; this process is still used to manufacture high quality pigment blacks with properties comparable to those of channel blacks. The gas black process has been used on an industrial scale since 1935. In the gas black process, illustrated in Figure 4.4, the feedstock is partially vaporised.



**Figure 4.4: The gas black process**  
[47, InfoMil, 2002]

The residual oil is continuously withdrawn. The oil vapour is transported to the production apparatus by a combustible carrier gas (e.g. hydrogen, coke oven gas, or methane). Air may be added to the oil-gas mixture for the manufacture of very small particle size carbon black. Although this process is not as flexible as the furnace black process, various grades of gas black can be made by varying the relative amounts of carrier gas, oil and air. The type of burners used also influences the carbon black properties.

A gas black apparatus consists of a burner pipe approximately 5 m long, which carries 30 - 50 diffusion burners. The flames burn in contact with a water-cooled drum, where about half of the carbon black formed is deposited. This black is continuously scraped off and transported by a screw to a pneumatic conveying system. The gas black apparatus is surrounded by a steel housing open at the bottom. At the top, fans extract the off-gas into filters, which collect the carbon black suspended in the gas. Valves in the exhaust pipes can regulate the amount of air entering the apparatus. Several gas black apparatus are combined to form one production unit. One oil vaporiser feeds the whole unit. The production rate and the yield of an apparatus depend on the grade of carbon black produced. For a typical reinforcing black, the production rate is 7 - 9 kg/h and the yield is 60 %. The yield for high quality pigment blacks is considerably lower (10 - 30 %).

To remove possible impurities, the gas black is classified and then densified, pelletised, or submitted to an oxidative treatment (see Section 4.2.4). Such an increased surface oxidation improves the properties of the carbon black [47, InfoMil, 2002].

#### 4.2.3.3 Lamp black process

The lamp black process is the oldest industrial scale production process. Currently, only a few plants still produce rather coarse blacks (with a mean particle diameter of approx. 100 nm) with special properties. They are used as non-reinforcing or semi-reinforcing blacks in rubber goods and as tinting black with a low pigment separation tendency.

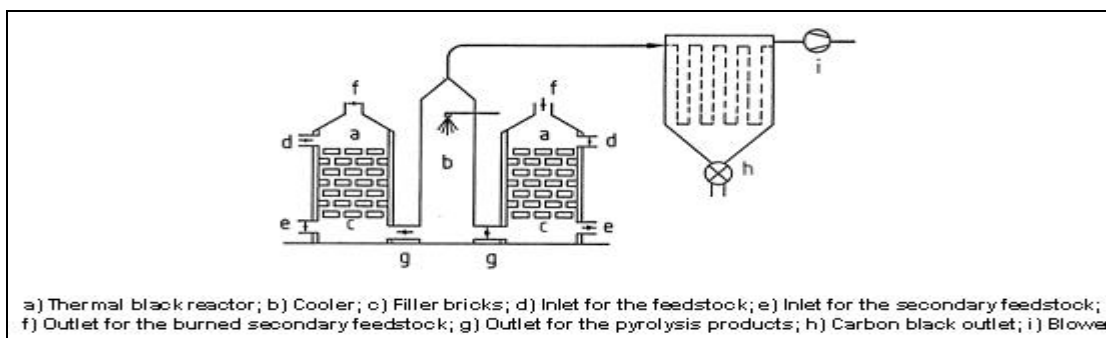
The lamp black process is only partially continuous. The feedstock – oil with a high aromatic hydrocarbon content – is burned in flat steel vessels up to 1.5 m in diameter.

The oil is continuously introduced into the vessel to keep a constant feedstock level. The off-gas containing carbon black is sucked into a conical exhaust pipe, which is coated with a ceramic inner liner and leads to the cooling and collecting system. The properties of carbon black can be influenced to some extent by variation of the distance between the vessel and the exhaust and the amount of air sucked into the apparatus. One lamp black apparatus can produce 100 kg/h carbon black. The production process must be interrupted at certain time intervals to remove residues containing coke from the vessels.

#### 4.2.3.4 Thermal black process

Some special processes for producing carbon black are based on the thermal decomposition of lower gaseous hydrocarbons or atomised petroleum oils in the absence of air. The thermal black process, which was developed in the 1930s, is still used for the production of coarse carbon blacks (non-reinforcing carbon blacks) for special applications in the rubber industry. Contrary to the processes described above, energy generation and the pyrolysis reaction are not carried out simultaneously.

A thermal black plant consists of two furnaces, which are used in alternate heating and production periods of approx. 5 min duration – see Figure 4.5 below.



**Figure 4.5: Thermal black process**  
[47, InfoMil, 2002]

Each of the cylindrical furnaces (4 m in diameter and 6 m high) contains a network of heat-resistant bricks. They are heated with natural gas or oil and air. At a temperature of approx. 1400 °C, the air is switched off and only feedstock is introduced for pyrolysis. Since this reaction is endothermic, the temperature falls. At about 900 °C, a new heating period is necessary.

The output from the furnace, carbon black and nearly pure hydrogen, are cooled by injecting water into an ascending channel. The carbon black is separated in the collecting system. Diluting the natural gas with recycled hydrogen can produce carbon blacks of lower particle size. Fine thermal blacks (FT blacks) with mean primary particle sizes of 120 – 200 nm were manufactured in this way in the past, but their production has now been discontinued. Medium thermal blacks (MT blacks) with mean particle sizes of 300 – 500 nm are still produced and are obtained by using undiluted feedstock. The yield of MT blacks is approximately 40 % with respect to the total amount of feedstock used.

Thermal blacks are used in mechanical rubber goods often based on synthetic polymers. e.g. fluoro elastomers, which are designed for specialised application. At present, thermal blacks donate specific physical properties to the end-product, e.g. resistance to compression or permanent deformation, at levels which cannot be attained using standard furnace grade.

#### 4.2.3.5 Acetylene black process

Acetylene and mixtures of acetylene with light hydrocarbons are the raw materials for a process that has been used since the early 1900s. Unlike other hydrocarbons, the decomposition of acetylene is highly exothermic.

The discontinuous explosion process, which was mainly used for the production of colour blacks, is the oldest technical process. Continuous processes were later developed with production rates of up to 500 kg/h. Acetylene or gases containing acetylene are fed into a preheated, cylindrical reactor with a ceramic inner liner. Once ignited, the decomposition heat that is evolved maintains the reaction.

The carbon black is collected in settling chambers and cyclones. Approximately 95 – 99 % of the theoretical yield is obtained.

The primary particles of acetylene black have different shapes than those of other carbon blacks. Because of their relatively high price, the application of acetylene blacks is limited to special uses, e.g. in dry cells. Total worldwide production is approx. 40 kt per year.

#### 4.2.3.6 Other manufacturing processes

In a plasma, hydrocarbon vapours may be almost quantitatively decomposed into carbon and hydrogen. Many producers of carbon black have carried out research in this field. According to numerous patent specifications, this method can be used to make small particle carbon blacks with new properties. The electric arc process was the only large scale process using plasma reactions in which large quantities of carbon black were produced as a by-product of the production of acetylene. The particles of the arc carbon black resemble those of acetylene black. The mean primary particle size is approx. 35 nm. Today, this kind of carbon black is no longer used as a pigment. For information on the plasma process, refer to Section 9.4.

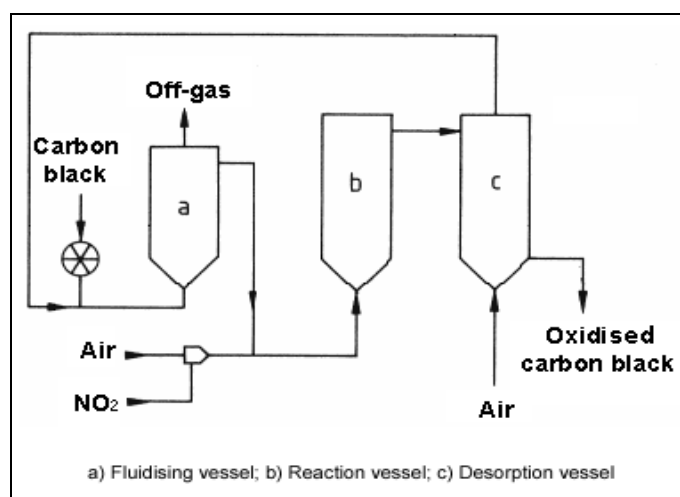
Since the price of feedstock, and thus, the profitability of the carbon black production processes, is highly dependent on the petrochemical industry, several attempts have been made to find new raw materials. Processes for obtaining carbon black directly from coal or for isolating carbon black from used tyres, for example, have been studied. None of them, however, has been of any commercial importance up until now. On the other hand, clay, milled coal, and coke have found limited use as substitutes for very coarse carbon blacks, primarily thermal blacks and some semi-reinforced blacks. The increasing use of precipitated silica in tyres and mechanical rubber goods, mostly in combination with organosilane coupling agents, which originally was indicative of an increasing search for new non-oil-based fillers, has led to new rubber properties.

#### 4.2.4 Oxidative treatment of carbon black

Oxygen containing functional groups on the surface of carbon blacks strongly influence their application properties. High contents of volatile components, i.e. high concentrations of surface oxides, decrease the vulcanisation rate and improve the flow characteristics of inks. The gloss of lacquers and coatings is increased, the colour tone is shifted from brownish to bluish, and jetness (degree of blackness) often increases. Due to the production conditions, only gas blacks (and channel blacks) are covered to a certain extent with acidic surface oxides. Furnace blacks contain only small amounts of oxygen in the form of basic surface oxides. To amend their colour properties, some pigment blacks are post-treated by oxidation on a commercial scale. Depending on the oxidising agent and the reaction conditions selected, different types of surface oxides are formed in varying quantities. The simplest method of oxidising the carbon black surface is by post-treating it with air at 350 – 700 °C (see Figure 4.6).

However, the degree of oxidation is limited. Higher contents of surface oxides and better process control are achieved with nitric acid, mixtures of NO<sub>2</sub> and air, or ozone. Also aqueous solutions such as sodium hypochlorite solutions may be used as oxidising agents. As a rule, all strongly oxidising agents may be used, either as a gas or in solution. Most surface oxidation processes of carbon black are carried out at elevated temperatures. Oxidised carbon blacks may contain up to 15 wt-% oxygen. They are strongly hydrophilic, and some of them form colloidal solutions spontaneously in water. In polar printing ink systems, and in lacquers and coatings, a better wettability and dispersibility is achieved through surface oxidation, thus reducing binder consumption.

Surface oxidation of carbon black with nitric oxide and air can be carried out industrially in a fluidised bed reactor. A suitable post-treatment unit consists of a preheating vessel, in which the carbon black is fluidised and heated, a reaction vessel to carry out the surface oxidation, and a desorption vessel, in which adsorbed nitric oxide is removed.



**Figure 4.6:** Equipment for the oxidative treatment of carbon black in a fluidised bed [47, InfoMil, 2002]

Typical reaction temperatures lie between 200 and 300 °C. Depending on the degree of oxidation, the residence time can amount to several hours. The nitric oxide acts primarily as a catalyst, the oxygen in the air being the genuine oxidising agent. Oxidation of powdery black with ozone is also carried out on a commercial scale. Another common method of surface oxidation was carried out during pelletisation. Instead of water, nitric acid was used as the pelletising agent. The surface was oxidised while the wet beads were dried at an elevated temperature.

## 4.2.5 Carbon black: physical and chemical properties

### 4.2.5.1 Physical properties

#### Morphology

The particle size according to DIN 53206 distinguishes three levels: (1) primary particles (recognisable as individual particles with physical analysis methods), (2) aggregates (assemblages of primary particles, grown or fused together in the form of chains or clusters; aggregates cannot be broken into primary particles by any dispersion process) and (3) agglomerates (loose assemblages of aggregates, held together by van der Waal forces).

### 4.2.5.2 Chemical properties

#### Chemical composition

Depending on the manufacturing process, raw material, and possible chemical post-treatment, the global chemical composition according to elemental analysis is within the limits given in the box below [47, InfoMil, 2002]:

Carbon	80.0 – 99.5 wt- %
Hydrogen	0.3 – 1.3 wt- %
Oxygen	0.5 – 15.0 wt- %
Nitrogen	0.1 – 0.7 wt- %
Sulphur	0.1 – 2 wt- %

The ash content of most furnace blacks is <1 wt-%. The ash components can result from the raw material, the salts that are injected to control the structure, and salts in the process water. The ash content of gas blacks is less than 0.02 %.

**Oxidation behaviour**

Industrial carbon blacks do not spontaneously ignite when stored in air at 140 °C. When ignited in air, carbon black glows slowly. In contrast to coal, dust explosions are not observed under normal test conditions. However, carbon black in combination with high energy ( $>1$  kJ) and an appropriate distribution of a carbon black dust/air mixture (lower explosion limit is  $50 \text{ g/m}^3$ ) can be made to explode.

## 4.3 Present consumption and emission levels – the furnace process

### 4.3.1 Introduction

For environmental aspects of the carbon black production, distinction can be made between the different carbon black processes, such as the furnace black, thermal black, channel black and the lamp black processes. However, as more than 95 % of the worldwide plants operate the furnace black process, this section only deals with the environmental aspects of the furnace black process. Section 4.3.2 describes the emissions of the furnace black process to air. Sections 4.3.3 and 4.3.4 respectively give a description of the discharges to water and production of wastes from the furnace black process. Section 4.3.5 deals with energy consumption.

### 4.3.2 Emissions to air

#### 4.3.2.1 Possible emissions to air

In the furnace black process, distinction can be made between the venting of non-combusted tail-gas, the emissions from tail-gas combustion devices (flares, boilers, incinerators), emissions from the tail-gas fired product dryers and the filter system vents. The different potential pollutants and their origin are addressed in Table 4.7.

Emission	Origin
Carbon monoxide (CO)	<ul style="list-style-type: none"> <li>• product of incomplete combustion in the reactor</li> <li>• product of incomplete combustion in dryers, boilers, flares, etc.</li> </ul>
Carbon dioxide (CO <sub>2</sub> )	<ul style="list-style-type: none"> <li>• product of complete combustion in the reactor</li> <li>• product of complete combustion in dryers, boilers, flares, etc.</li> </ul>
Oxides of sulphur (SO <sub>x</sub> )	<ul style="list-style-type: none"> <li>• oxidation of feedstock sulphur compounds in the reactor</li> <li>• oxidation of sulphur compounds present in the tail-gas</li> </ul>
Reduced sulphur compounds (hydrogen sulphide (H <sub>2</sub> S), carbon disulphide (CS <sub>2</sub> ), carbonyl sulphide (COS))	<ul style="list-style-type: none"> <li>• decomposition and partial oxidation of feedstock sulphur compounds in the reactor</li> </ul>
Oxides of nitrogen (NO <sub>x</sub> )	<ul style="list-style-type: none"> <li>• oxidation of feedstock nitrogen compounds in the reactor</li> <li>• thermal NO<sub>x</sub> from the reactor</li> <li>• fuel NO<sub>x</sub> from dryers, boilers, flares, etc.</li> <li>• thermal NO<sub>x</sub> from dryers, boilers, flares, etc.</li> <li>• oxidative post-treatment of carbon black with NO<sub>2</sub> or HNO<sub>3</sub></li> </ul>
Other nitrogen compounds (hydrogen cyanide (HCN), ammonia (NH <sub>3</sub> ))	<ul style="list-style-type: none"> <li>• decomposition of feedstock nitrogen compounds in the reactor</li> </ul>
Volatile organic compounds (VOC) (e.g. methane, acetylene, ethylene)	<ul style="list-style-type: none"> <li>• incomplete decomposition of feedstock in the reactor</li> </ul>
Polycyclic aromatic hydrocarbons (PAH)	<ul style="list-style-type: none"> <li>• incomplete decomposition of feedstock</li> </ul>
Particulate matter (e.g. carbon black dust)	<ul style="list-style-type: none"> <li>• slip through filter system behind reactor</li> <li>• slip through dedusting filter systems, e.g. behind dryer</li> <li>• slip through thermal combustor (e.g. boiler, flare)</li> <li>• fugitive emissions due to storage, transportation and packaging</li> </ul>
Heavy metals (HM)	<ul style="list-style-type: none"> <li>• present as trace impurities in some feedstock.</li> </ul>

**Table 4.7: Potential pollutants from the furnace black process and their origin [47, InfoMil, 2002]**

### 4.3.2.2 Tail-gas venting

An important potential source of emission to air is the ‘tail-gas’. Tail-gas comes from the reactor after product separation and is a low calorific gas with a high moisture content due to the quench water vapour. It contains hydrogen (H<sub>2</sub>), carbon oxides (CO and CO<sub>2</sub>), reduced sulphur compounds (H<sub>2</sub>S, CS<sub>2</sub> and COS), sulphur dioxide (SO<sub>2</sub>), nitrogen compounds (N<sub>2</sub>, NO<sub>x</sub>, HCN and NH<sub>3</sub>) and volatile organic compounds, such as ethane and acetylene.

The tail-gas composition may vary considerably according to the grade of carbon black being produced and the feedstock used. An overview of tail-gas composition is given in Table 4.8 below. Organic species tend to be lower and carbon monoxide emissions tend to be higher for small particle production, corresponding with higher temperatures and the lower yields obtained. As mentioned in Section 4.2.3.1, carbon black yields can vary between 10 and 65 %, depending on the grade produced and the raw materials used. The presence of sulphur compounds in the tail-gas (sulphur oxides, hydrogen sulphide and volatile organic sulphur compounds) depend on the feedstock sulphur content.

Currently, the standard requirement for tail-gas treatment in many countries is flaring, in order to destroy the toxic and odorous components. Also, methods for recovering the energy content of the tail-gases are employed where applicable – refer to Table 4.16. For instance, tail-gas combustion is common practice in Germany [85, EIPPCB, 2004-2005]. The combustion of tail-gas generates flue-gas with different environmental characteristics. The potential emissions from tail-gas combustion are listed in Section 4.3.2.3.

Venting of uncombusted tail-gas may be allowed during emergencies, start-up and shut-down periods and during periods of grade change. Some plants are allowed to emit the tail-gases as a continuous process vent. Typical ranges of CB tail-gas composition are given in Table 4.8. These values do not reflect, however, the full range of tail-gas compositions encountered in all the carbon black facilities. Significant variations occur due to different feedstocks used and carbon black grades produced.

Compound	Minimum (vol-%, wet)	Maximum (vol-%, wet)
Moisture (H <sub>2</sub> O)	29.6	50
Nitrogen (N <sub>2</sub> )	32.7	46.2
Hydrogen (H <sub>2</sub> )	6.6	14
Carbon monoxide (CO)	6.1	11.7
Carbon dioxide (CO <sub>2</sub> )	1.5	3.9
Oxygen (O <sub>2</sub> )	0	1.85
Methane (CH <sub>4</sub> )	0.07	0.78
Acetylene (C <sub>2</sub> H <sub>2</sub> )	0.03	0.7
	Minimum (ppmv, wet)	Maximum (ppmv, wet)
Sulphur oxides (as SO <sub>2</sub> )	5	260
Hydrogen sulphide (H <sub>2</sub> S)	63	2500
Carbonyl sulphide (COS)	3	300
Carbon disulphide (CS <sub>2</sub> )	11	800
Mercaptans (R-SH)	Traces	180
Nitrogen oxides (as NO <sub>2</sub> )	5	310
Ammonia (NH <sub>3</sub> )	42	60
Hydrogen cyanide (HCN)	130	564
Ethane/ethene (C <sub>2</sub> H <sub>6</sub> /C <sub>2</sub> H <sub>4</sub> )	50	3612
Propane/other C <sub>3</sub> s		
Butane/other C <sub>4</sub> s		
Pentane/other C <sub>5</sub> s		
Hexane/other C <sub>6</sub> s		

**Table 4.8: Typical ranges of carbon black tail-gas composition [47, InfoMil, 2002]**



#### 4.3.2.3 Emissions from dedicated tail-gas combustion devices

Gaseous toxic and odorous emissions from the tail-gas, such as H<sub>2</sub>S, volatile organic sulphur compounds (CS<sub>2</sub>, COS), and CO, are controlled with thermal combustion, such as flares, boilers or incinerators. Thermal combustors can achieve essentially complete oxidation of organic compounds and can oxidise sulphur compounds in the process flue-gas. Combustion efficiencies of 99.6 per cent for hydrogen sulphide and 99.8 per cent for carbon monoxide have been measured for a flare of a carbon black plant [47, InfoMil, 2002]. Particulate emissions may also be reduced by the combustion of some of the carbon black particles. However, emissions of sulphur dioxide are increased due to the oxidation of the hydrogen sulphide and the volatile organic sulphur compounds. Additionally, it is important to realise that the combustion will also increase the emissions of nitrogen oxides. In western Europe, the recovery of energy from the tail-gas in the form of heat, steam and/or electricity is common. The combustors usually treat some 70 % of the generated tail-gas. The remaining 30 % is normally used as a fuel in the dryers of the wet pelletising unit.

#### 4.3.2.4 Emissions from the dryers of the wet pelletising unit

The wet pelletised carbon black is transported to a dryer (usually a rotary drum), in which the wet pellets are dried directly or indirectly, depending on the chosen system. The indirect system is most common. Tail-gas is generally used as a heat source, as it is beneficial to reduce the fossil fuel consumption. The flue-gases from an indirectly heated dryer can be combined with the evaporated water from inside the dryer into one common stack or can be sent to the atmosphere via separate stacks. Besides carbon black coming from the dryer filter system, other contaminants can be present in the stacks. These contaminants include sulphur oxides, nitrogen oxides, and the unburned portion of each of the species present in the main process vent gas (tail-gas). When carbon black is dried directly, the above-mentioned emissions are contained in the same gas stream.

#### 4.3.2.5 Filter system vents

Carbon black is separated from the tail-gas in the product separation filter, consisting of a special type of bag filter. Carbon black that is not captured in this filter is entrained in the tail-gas. Normally, levels of carbon black in the tail-gas after the filter are <100 mg/m<sup>3</sup>. As the slip of carbon black in this filter represents a loss of product, there is a drive for the operator to keep the level as low as possible. The collected (fluffy) carbon black is pneumatically transported by air to another bag filter system, where the carbon black is separated from the transport air and subsequently fed to the pelletiser. The emissions from this filter are released into the atmosphere. Emission levels from this filter are generally <50 mg/Nm<sup>3</sup>.

#### 4.3.2.6 Fugitive emissions

The petro and carbo-chemical feedstocks used in the carbon black industry have a low vapour pressure and the feedstock storage tanks are only a minor source of fugitive organic emissions. Fugitive emissions of carbon black (particulate matter) originate from cleaning, spills and leaks in the storage, transportation and packaging. When the operator adheres to good housekeeping practice, fugitive emissions can be insignificant.

#### 4.3.2.7 Summary of emissions to air

Due to the large variety of plant configurations, feedstock compositions and product types, it is difficult to present an overview of emissions from carbon black plants that fits all plants.

Some plants operate with separate stacks for the tail-gas combustion units and for the product dryers, whereas others combine the flue-gases from these sources. An attempt to present the emissions per potential source (e.g. tail-gas combustion, dryers, filter system) was abandoned for this reason.

However, the German VDI has presented an overview in its VDI 2580 document from 1992 [47, InfoMil, 2002], which is considered to give a good indicative overview of the emissions that can be expected from furnace black plants – see Table 4.9 below. This table is based on the assumption that all of the generated tail-gas is combusted [47, InfoMil, 2002].

Emission component	Specific emission (kg/tonne carbon black)	Emission concentration* (mg/Nm <sup>3</sup> at 10 % O <sub>2</sub> )
Particulate matter	0.2 – 0.4	10 – 30
Sulphur dioxide (as SO <sub>2</sub> )	6.5 – 22.0**	400 – 1400
Nitrogen oxides (as NO <sub>2</sub> )	6.0 – 15.0	400 – 900
Carbon monoxide	2.0 – 3.0	120 – 200
Volatile organic compounds (as total C)	up to 0.7	up to 50

\*Emission concentrations at 273.15 K, 101.3 kPa under dry conditions, standardised to 10 % O<sub>2</sub>. This oxygen percentage would be representative for a situation where all off-gases are emitted through a central stack.  
 \*\*Range corresponds to a sulphur content in the feedstock of 0.3 – 1.0 wt-%. Actual permitted sulphur feedstock levels are higher than 1 % S for most European plants and significantly higher for all north American plants (see Section 4.4.2 below).  
 Note: Benzene could also be included as an emission component [85, EIPPCB, 2004-2005]. For benzene, TA Luft specifies emission concentration of <5 mg/Nm<sup>3</sup>.

**Table 4.9: Typical emission values of furnace black plants**  
[47, InfoMil, 2002]

### 4.3.3 Emissions to water

Water is used in relation to the production process or used for non-process related utilities. The following two sections show the process related and the non-process related discharges to water.

#### 4.3.3.1 Process related water streams

In the production process, the following water streams are distinguished:

- quench water (reactor tail-gas)
- wash-water for process installations (and floors)
- scrubber water during start-up/warming up of the reactor
- water used for pelletisation
- cooling water for the reactor lining
- boiler feed-water (if present)
- cooling water for the power plant or thermal combustor.

Normally, drinking water is used for the above-mentioned process applications [47, InfoMil, 2002]. It should be noted that apart from cooling water, only the scrubbing water and the wash-water potentially lead to a water discharge. The quench water and the water used for wet pelletisation are totally evaporated in the process.

#### 4.3.3.2 Non-process related water streams

The following non-process related water streams are distinguished:

- water used in laboratories
- water used for sanitary purposes
- surface water run-off and rainwater.

These are not specific to the carbon black industry and are not dealt with in this document.

### 4.3.3.3 Potential discharges

Some water streams can be re-used as process water for quenching the reactors gas/carbon black mixtures if it not affects product quality. Prior to being re-used for quenching, the effluent water streams are filtered. The filter residue (carbon black) could be sold as a colorant. It has been proven that – cooling water excluded – a zero discharge to water is possible for some types of carbon black plants. However, the production of some rubber black and nearly all speciality black grades require clean quench water. Pollutants, such as minerals or salts substantially and adversely, influence the product's specific properties, and therefore, hinder the re-use of waste water [47, InfoMil, 2002]. Potential pollutants in the process water are suspended solids (mainly carbon black), chemical oxygen demand (COD), and oil. The chemical oxygen demand may be partially introduced through the water intake and is generally below 100 mg/l. Suspended solids (mainly carbon black) are normally filtered before discharge (or re-use) to levels <20 mg/l. Oil and associated compounds are only expected in significant quantities when oil spillage or leakage occurs. In some plants, part or all of the generated process streams are (after filtration) used in the process. The main pollutants in the cooling water are heat (up to 30 GJ/tonne carbon black) and cooling system conditioners. It can be concluded that the emissions to water are of minor importance for the carbon black industry.

### 4.3.4 Solid Wastes

According to European legislation, waste can be divided into hazardous and non-hazardous waste and these are described in the following two sections.

#### 4.3.4.1 Hazardous wastes

The following hazardous wastes can be distinguished [47, InfoMil, 2002]:

- spent or used oil
- oil sludge (e.g. due to the cleaning of storage tanks or leakage)
- hazardous wastes generated in the workshops, laboratories and offices.

Carbon black processes generate very little direct hazardous waste. This is mainly due to the re-use of spent oil and – if possible – oil sludge as feedstock [47, InfoMil, 2002]. Therefore, it can be concluded that in carbon black plants nearly all hazardous wastes are generated only in the workshops, laboratories or offices that support the production process. The amounts are relatively small in relation to the amounts of carbon black produced.

#### 4.3.4.2 Non-hazardous wastes

The following non-hazardous wastes can be distinguished [47, InfoMil, 2002]:

- substandard carbon black
- 'carbon black cake'
- refractory waste
- used bag filters (carbon black filter systems)
- plastic (packaging material)
- paper and cardboard (packaging material)
- wood waste (pallets)
- metals (ferrous/non-ferrous)
- demolition waste (not regularly emitted debris)
- municipal waste (canteen).

Carbon black processes generate non-hazardous waste resulting from the production of substandard carbon black. This material may be reprocessed, sold as a colorant for construction materials, sold to power plants or disposed of through combustion or landfill [47, InfoMil, 2002]. The amounts of non-hazardous wastes are relatively small in relation to the amounts of carbon black produced. Compared to carbon black production, the amount of refractory waste is about 0.02 to 0.1 % [47, InfoMil, 2002]. Nowadays, this refractory waste is pure alumina, which can be considered as non-hazardous waste. This refractory material is landfilled. From the above, it can be concluded that hazardous and non-hazardous wastes are of minor importance to the carbon black industry.

### 4.3.5 Energy consumption

It is difficult to make an accurate energy balance for the furnace black process in general, due to the following reasons:

- it is unknown exactly which part of the feedstock is converted into product carbon black
- energy recovery for internal and external use takes place in different forms (e.g. electricity and steam). Sometimes, the tail-gas is even sold as such. Nearly all carbon black plants reuse a substantial part (15 to 30 %) of the tail-gas in their dryers. However, for combustion of the rest of the tail-gas, numerous configurations of controlled thermal combustors, boilers, combined heat and power (CHP) installations [86, The Council of the EU, 2004] and/or flares are used [47, InfoMil, 2002]
- feedstock and operating conditions are changed frequently, in order to produce different carbon black grades. Therefore, the energy content of the feedstock and the flow and calorific value of the tail-gas varies. In addition, energy losses occur during start-ups and shut-downs.

Table 4.10 shows the typical total electrical energy consumption for rubber black plants (assumed yield 50 % for rubber black).

Nameplate capacity	tonnes carbon black/year	<50000	50000 - 75000	>75000
Electricity	kWh/tonne carbon black	550	480	430
	GJ/tonne carbon black	2	1.73	1.55

**Table 4.10: Typical total electrical energy consumption for rubber black plants [47, InfoMil, 2002]**

A rough energy balance for a rubber black furnace black plant is shown below in Table 4.11.

IN		OUT	
Flow	GJ/tonne CB	Flow	GJ/tonne CB
Primary feedstock (*)	57.35 – 66.6	Product (#)	33
Secondary feedstock (**)	11.1 – 14.8	Tail-gas (##)	17 – 38
Electricity	1.55 – 2.0	Other	12 – 27
(*) Based on a calorific value of 37 MJ/kg and a feedstock consumption of 1.55 – 1.80 tonne/tonne CB.			
(**) Based on a calorific value of 37 MJ/Nm <sup>3</sup> natural gas and a consumption of 300 – 400 Nm <sup>3</sup> /tonne CB.			
(#) Based on a calorific value of 33 MJ/kg CB.			
(##) Based on a calorific value of 1.7 – 3.8 MJ/Nm <sup>3</sup> tail-gas and a tail-gas production of approximately 10000 Nm <sup>3</sup> /tonne CB.			

**Table 4.11: Rough energy balance for a rubber black furnace plant [47, InfoMil, 2002]**

As can be seen in Table 4.11 above, the main incoming energy carriers in the furnace are: (1) the primary feedstock, (2) the secondary feedstock and (3) the electricity. The main outgoing energy flows can be categorised into: (4) product, (5) tail-gas and (6) other (e.g. heat loss through flue-gases, cooling water, radiation, etc.).

Most plants use part of the generated tail-gas for heating the dryers of the wet pelletising process. The amount of this tail-gas varies between 15 and 35 % of tail-gas production, depending on the fuel requirements of the dryer. Many plants in Western Europe exploit the remaining tail-gas for the generation of steam and (in some locations) electricity. The potential recovery from the remaining tail-gas for a combined heat and power plant (CHP) at 80 % overall efficiency is between 9 and 26 GJ/tonne CB. Part of the produced steam (and electricity) can be used at several places in the process, but in general, plants that recover the total heat content of the tail-gas are net producers of energy and would benefit from an outside consumer [47, InfoMil, 2002].

## 4.4 Techniques to consider in the determination of BAT

This section sets out techniques considered generally to have potential for achieving a high level of environmental protection in the industries within the scope of the document. Management systems, process-integrated techniques and end-of-pipe measures are included, but a certain amount of overlap exists between these three when seeking the optimum results.

Prevention, control, minimisation and recycling procedures are considered as well as the re-use of materials and energy.

Techniques may be presented singly or as combinations to achieve the objectives of IPPC. Annex IV to the Directive lists a number of general considerations to be taken into account when determining BAT and techniques within this section will address one or more of these considerations. As far as possible a standard structure is used to outline each technique, to enable comparison of techniques and an objective assessment against the definition of BAT given in the Directive.

The content of this section is not an exhaustive list of techniques and others may exist or be developed which may be equally valid within the framework of BAT.

Generally a standard structure is used to outline each technique, as shown in Table 4.12:

Type of information considered	Type of information included
Description	Technical description of the technique
Achieved environmental benefits	Main environmental impact(s) to be addressed by the technique (process or abatement), including emission values achieved and efficiency performance. Environmental benefits of the technique in comparison with others
Cross-media effects	Any side-effects and disadvantages caused by implementation of the technique. Details on the environmental problems of the technique in comparison with others
Operational data	Performance data on emissions/wastes and consumption (raw materials, water and energy). Any other useful information on how to operate, maintain and control the technique, including safety aspects, operability constraints of the technique, output quality, etc.
Applicability	Consideration of the factors involved in applying and retrofitting the technique (e.g. space availability, process specific)
Economics	Information on costs (investment and operation) and any possible savings (e.g. reduced raw material consumption, waste charges) also as related to the capacity of the technique
Driving force for implementation	Reasons for implementation of the technique (e.g. other legislation, improvement in production quality)
Example plants	Reference to a plant where the technique is reported to be used
Reference literature	Literature for more detailed information on the technique

**Table 4.12: Information breakdown for each technique described in this section**

Reference is to be made here also to Section 8.9, providing key information on the Environmental Management System (EMS) which is a tool for IPPC installations that operators can use to address the design, construction, maintenance, operation and decommissioning issues in a systematic demonstrable way.

Techniques broadly applicable in the chemical industry, described in the BREF on Common Waste Water and Waste gas Treatment/Management Systems in the Chemical Sector, are not included in this section (refer to the BREF on CWW).

### 4.4.1 Primary NO<sub>x</sub> reduction

#### Description

NO<sub>x</sub> emissions from the carbon black industry are mainly related to combustion of the tail-gas in dedicated combustors. This section focuses on the reduction of NO<sub>x</sub> emissions during the combustion process and reduction of the input of fuel related nitrogen. This is also called 'primary NO<sub>x</sub> reduction'.

There are a number of options, which may potentially be used to reduce NO<sub>x</sub> formation at combustion, depending upon the combustion device:

- decreasing the combustion temperature in all reaction areas to below 1300 °C
- decreasing the residence time in all high temperature zones
- lowering the availability of oxygen in reaction zones
- choosing a fuel with a lower nitrogen content.

Taking into account the above-mentioned options, the following eight potential operational measures are at the disposal of the operators of carbon black plants:

1. Low Excess of Air (LEA)
2. Staged Air Combustion (SAC)
3. Low NO<sub>x</sub> Burners (LNB)
4. Reduced Air Preheat (RAP)
5. Low Nitrogen Fuels (LNF)
6. Staged Fuel Combustion (SFC)
7. Flue-Gas Recirculation (FGR)
8. Water/Steam Injection (WSI).

It should be noted that all of the above-mentioned measures are considered only for the use in enclosed thermal combustors. These options are not used in the operation of flares as thermal combustors, which are configured and operated for low NO<sub>x</sub> formation and emissions.

The use of primary deNO<sub>x</sub> in the carbon black reactor is not possible due to interference with the production process and are not useful due to the relatively low amount of NO<sub>x</sub> that is formed in the reactor. The majority of the NO<sub>x</sub> is formed in the thermal combustion of the tail-gas.

Of the eight aforementioned primary NO<sub>x</sub> reduction measures, the latter three measures are also considered impossible for thermal combustors in the carbon black industry, due to the expected reduced flame stability. For this reason SFC, FGR and WSI will not be further discussed.

Low Excess of Air (LEA) is the simplest form of reducing oxygen availability in the flame. Changing the air/fuel ratio is an easy operational modification and will reduce thermal NO<sub>x</sub> formation as well as fuel NO<sub>x</sub> formation [47, InfoMil, 2002]. However, impacts that have to be considered are higher carbon monoxide and hydrocarbons emissions, altering flame length and flame stability. Flame stability issues are further compounded by the relatively low calorific value of the tail-gas.

In Staged Air Combustion (SAC), the principle is primarily to reduce the level of available oxygen in zones, where it is critical for NO<sub>x</sub> formation; the amount of fuel burned at peak temperature is also reduced. Generally 10 – 20 % of the total combustion air is used for staging, but staging levels of 20 - 40 % are under investigation.

Theoretically, the air can be staged either in the (dryer or boiler) furnace or in the burner itself. However, due to the low calorific value of the tail-gas and the high moisture content, air staging in the (dryer or boiler) furnace is not executable.

Air staging in a furnace is often called a two-stage combustion (TSC) process, in which air to the combustion zone is reduced and additional air is introduced after the combustion zone to complete combustion.

The first Low NO<sub>x</sub> Burners were constructed in the 1970s operating as so-called ‘dual register burners’. Most boiler and burner manufacturers for retrofit and new installations developed LNB. Design details differ from manufacturer to manufacturer. Generally they are designed to achieve delayed combustion by the method of air and fuel introduction. The level of available oxygen is decreased in zones that are critical for NO<sub>x</sub> formation and the amount of fuel burned at the peak temperature is also decreased. LNB produce relatively long diffusion flames by encouraging two-stage combustion or low temperature gas recirculation.

Reduced Air Preheat (RAP) is another viable technique especially for reducing thermal NO<sub>x</sub> formation. Herewith, the preheating of combustion air is decreased causing a lower temperature in the primary combustion zone. As there is a thermal efficiency penalty in boilers of 1 % for each 20 – 25 °C reduction in air preheat, this method is commonly used to (temporarily) lower boiler efficiency in situations of excess energy production. This technique should be appropriate for boilers in the carbon black industry, because in general they also cope with an excess of energy.

In Low Nitrogen Feedstock/Fuels (LNF), the nitrogen content in carbon black feedstock varies between 0.1 and 1.5 wt-% and is believed to relate mainly to aromatic structures. Part of the nitrogen in the fuels is converted in the carbon black reactor to hydrogen cyanide (HCN), ammonia (NH<sub>3</sub>) and nitrogen oxides (NO<sub>x</sub>), whereas another part is converted to nitrogen (N<sub>2</sub>) or remains in the product. Although the fuel related NO<sub>x</sub> formation is also dependent on the temperature and the oxygen availability, the choice of low nitrogen feedstock and/or fuel will reduce the amount of nitrogen compounds in the tail-gas and thus reduce the amount of NO<sub>x</sub> formation in tail-gas combustion units. However, LNF sometimes possesses higher sulphur contents, while feedstock with low sulphur content (e.g. coal tar) can sometimes contain much higher nitrogen levels. For more details on feedstock properties and nitrogen levels in feedstock, refer to Table 4.14 below.

#### Achieved environmental benefits

All the five above-mentioned techniques are process-integrated measures aimed at primary NO<sub>x</sub> reduction, either by decreasing NO<sub>x</sub> formation during the combustion process or by reducing the input of fuel related nitrogen, and, therefore, for achieving low levels of NO<sub>x</sub> emission to the atmosphere, namely:

- low Excess of Air (LEA) reduces thermal NO<sub>x</sub> formation as well as fuel NO<sub>x</sub> formation
- Staged Air Combustion (SAC) reduces the level of available oxygen in zones, where it is critical for NO<sub>x</sub> formation
- Low NO<sub>x</sub> Burners (LNB) decrease the level of available oxygen in zones that are critical for NO<sub>x</sub> formation and the amount of fuel burned at the peak temperature
- Reduced Air Preheat (RAP) allows for reducing especially thermal NO<sub>x</sub> formation
- Low Nitrogen Feedstock/Fuels (LNF) reduces the amount of nitrogen compounds in the tail-gas and thus reduces the amount of NO<sub>x</sub> formation in tail-gas combustion units.

#### Cross-media effects

As mentioned in the ‘Description’ above, with regard to the following three operational measures:

- Low Excess of Air (LEA)
- Reduced Air Preheat (RAP), and
- Low Nitrogen Feedstock/Fuels (LNF).



Operational data

The advantages and disadvantages of the aforementioned deNO<sub>x</sub> measures are presented below in Table 4.13.

DeNO <sub>x</sub> measure	Advantages	Disadvantages
Low Excess of Air (LEA)	<ul style="list-style-type: none"> <li>• easy operational modification</li> <li>• 10 – 30 % reduction in non-carbon black applications</li> </ul>	<ul style="list-style-type: none"> <li>• increased CO and C<sub>x</sub>H<sub>y</sub> emissions</li> <li>• reduced flame stability</li> <li>• not for flares</li> </ul>
Staged Air Combustion (SAC)	<ul style="list-style-type: none"> <li>• applicable on all types of fuels</li> <li>• low operating costs</li> <li>• 30 – 60 % reduction in non-carbon black applications</li> </ul>	<ul style="list-style-type: none"> <li>• more complicated retrofit in existing plants</li> <li>• not for flares</li> </ul>
Low NO <sub>x</sub> Burners (LNB)	<ul style="list-style-type: none"> <li>• easy modification</li> <li>• 30 – 50 % reduction in non-carbon black applications</li> </ul>	<ul style="list-style-type: none"> <li>• may be less effective in existing plants</li> <li>• not for flares</li> </ul>
Reduced Air Preheat (RAP)	<ul style="list-style-type: none"> <li>• solution for excess energy</li> <li>• 25 – 65 % reduction in non-carbon black applications</li> </ul>	<ul style="list-style-type: none"> <li>• thermal efficiency loss</li> <li>• not for flares</li> </ul>
Low NO <sub>x</sub> Feedstock (LNF)	<ul style="list-style-type: none"> <li>• no combustion modifications necessary</li> </ul>	<ul style="list-style-type: none"> <li>• price penalty</li> <li>• limited market availability</li> <li>• may offset the S-level in the feedstock</li> </ul>

**Table 4.13: Advantages and disadvantages of primary deNO<sub>x</sub> measures [47, InfoMil, 2002]**

Low NO<sub>x</sub> combustion modifications outside the carbon black industry have been proven in the range of up to 65 %. However, it is unlikely that the application of the described techniques in the carbon black industry will yield such reductions, for three reasons:

- the nitrogen content of the tail-gas. As shown in Table 4.8, the tail-gas from carbon black plants generally contains significant quantities of ammonia (NH<sub>3</sub>) and hydrocyanic acid (HCN). These components are partly converted to NO<sub>x</sub> in the thermal combustor, boiler or flare
- the low calorific value of the tail-gas. In principle, gases with a low calorific value will yield lower (thermal) NO<sub>x</sub> emissions compared to (for example) natural gas, due to the reduced flame peak temperatures. However, the low calorific value also hampers the possibility of adjusting the combustion conditions due to the danger of reduced flame stability
- there may be significant variations in the flow and the calorific value of the tail-gas to be combusted. This is due to the grade changes and due to the fact that, in most plants, the combustion device is supplied with tail-gas from several reactors at a time. The variation complicates combustion control.

Recent experiences with low NO<sub>x</sub> technology on a tail-gas fired boiler have shown values in the range of 350 – 540 mg/Nm<sup>3</sup> at 3 % O<sub>2</sub>, but these values are still considered preliminary. For a tail-gas incinerator equipped with low NO<sub>x</sub> technology, values in the range of 310 - 450 mg/Nm<sup>3</sup> at 3 % O<sub>2</sub> were found in a demonstration test (see 'Example plants' below).

The above-mentioned results, while good, were reported for only one configuration of a carbon black plant operating at consistent production rates during a single stack testing event. Therefore, these results are not illustrative for the full range of NO<sub>x</sub> emission concentrations encountered in the subject carbon black facility. Significant variation in NO<sub>x</sub> emissions occur due to variation of feedstocks and product grades.

There is very limited experience within the carbon black industry with the application of primary NO<sub>x</sub> measures [47, InfoMil, 2002], however, the following show data from two example plants:

- a carbon black plant in Louisiana, US, is equipped with an incinerator to destroy the toxic compounds in the tail-gas. The incinerator was installed in 1997 and equipped with staged combustion technology (air staging). The authorities demanded that the NO<sub>x</sub> emission was limited to a level that did not exceed the total NO<sub>x</sub> precursors in the tail-gas (sum of HCN, NH<sub>3</sub> and NO). Performance tests in 1997 showed emission levels of between 310 and 450 mg/Nm<sup>3</sup> at 3 % O<sub>2</sub>. At a NO<sub>x</sub> precursor level of 450 ppmv in the tail-gas, this resulted in an average precursor to NO<sub>x</sub> ratio of 0.53, which is well below the 1:1 ratio demanded by the authorities. The incinerator operates at relatively low temperatures and the data indicated that for this unit, the NO<sub>x</sub> emissions have a higher affinity for NO<sub>x</sub> precursors than for variation in fuel to oxygen ratios. This indicates that at relatively low combustion temperatures, fuel NO<sub>x</sub> formation dominates the total NO<sub>x</sub> emissions
- a speciality carbon black plant in the Netherlands installed a new tail-gas fired boiler equipped with low NO<sub>x</sub> burners (LNB) in 1997. In 1999, emission levels of 700 - 800 mg/Nm<sup>3</sup> were measured at this boiler. This was less than the emissions expected from a standard tail-gas fired boiler, but higher than expected for a boiler equipped with low NO<sub>x</sub> burners. Since then the company has intensified its efforts to optimise boiler performance. As a first spin-off, the most recent measurements in June 2000 showed NO<sub>x</sub> levels of 350 – 540 mg/Nm<sup>3</sup> at 3 % O<sub>2</sub>. The ratio between tail-gas NO<sub>x</sub> precursors (NH<sub>3</sub> and HCN) and flue-gas NO<sub>x</sub> was between 0.3 and 0.6, which is better than the guaranteed 0.72. From the data, it seems that the lowest NO<sub>x</sub> emission values were associated with partial load of the boiler and showed less affinity for precursor levels. This might be explained from the assumption that thermal NO<sub>x</sub> becomes more important when the boiler is operated closer to its maximum capacity. The company has noted that these recent values are indicative and that investigation with respect to the consistency of the achievable values, the relationship between precursors and NO<sub>x</sub> emissions, and further emission reductions, is ongoing.

#### Applicability

As mentioned in the ‘Description’ above, the five described primary NO<sub>x</sub> measures are only applicable to the thermal combustion of tail-gases. For each of the above-mentioned techniques, a brief consideration for different applications will be given here.

The implementation of low NO<sub>x</sub> combustion techniques is quite different for an existing boiler compared to a new boiler. Low NO<sub>x</sub> measures on existing boilers can affect the combustion. There can also be difficulties in retrofitting, due to limitations such as available area and volume such as detailed below:

- Low Excess of Air (LEA). LEA may be applicable for the combustion devices, such as the dryer, the boiler or the combined heat and power (CHP) plant. However, flame stability and increasing CO emissions provide significant limitations
- Staged Air Combustion (SAC). SAC is only applicable in closed combustion devices, such as the dryer, the boiler and CHP
- Low NO<sub>x</sub> Burners (LNB). LNB are applicable in closed combustion devices. However, it is noticed here that the NO<sub>x</sub> reduction effect of LNB on existing boilers can be quite different compared to the implementation in a new boiler. There may also be different effects as a result of the low calorific value of the tail-gas
- Reduced Air Preheat (RAP). RAP can be successfully implemented on boilers, albeit with an energy penalty
- Low Nitrogen Feedstock/Fuel (LNF). Apart from the inconvenience that the supplier would generally not specify the nitrogen content, the selection of low nitrogen feedstock or fuels might not be entirely free. There may be price penalties and lack of availability on the market. Furthermore, LNF may be associated with higher sulphur levels. Nevertheless, LNF is applicable for NO<sub>x</sub> reduction in the carbon black industry, as the reduced nitrogen compounds, such as HCN and NH<sub>3</sub> in the tail-gas form a substantial part of the NO<sub>x</sub> emissions in the subsequent thermal combustors. For more details on feedstock and nitrogen levels, see Table 4.14 in Section 4.4.2 on primary SO<sub>x</sub> reduction.

### Economics

It is usually more cost effective to reduce NO<sub>x</sub> as far as possible through process-integrated measures. Both the investment and operational costs are normally lower compared to end-of-pipe deNO<sub>x</sub> measures. Even if end-of-pipe deNO<sub>x</sub> techniques are applied, in some cases the additional application of process-integrated measures may substantially reduce the capital and operational costs of the end-of-pipe NO<sub>x</sub> abatement equipment. There are no reliable data available on costs of primary measures in the carbon black industry [47, InfoMil, 2002].

### Driving force for implementation

The protection of the environment by reducing the emissions of NO<sub>x</sub> to the atmosphere.

### Example plants

A carbon black plant in Louisiana, US.

A speciality carbon black plant in the Netherlands.

It should be stressed, however, that the carbon black industry does not consider the results of primary NO<sub>x</sub> reduction achieved in the example plants in Louisiana, US and the Netherlands indicative of all operational scenarios in which different feedstocks may be used and various grades of carbon black produced and, therefore, is of the opinion that these carbon black plants are not representative to suggest optimal or consistent benchmark NO<sub>x</sub> emission concentrations available with the use of SAC technique (Louisiana, US) and LNB technique (the Netherlands). See 'Operational data' above.

### Reference literature

[47, InfoMil, 2002], [54, EIPPCB, 2004], [85, EIPPCB, 2004-2005].

## 4.4.2 Primary SO<sub>x</sub> reduction

### Description

A large part of the sulphur that is present in the feedstock will be converted to gaseous sulphur compounds that leave the reactor as tail-gas constituents. These gaseous sulphur compounds will be oxidised to SO<sub>x</sub> in the tail-gas combustion devices (see Section 4.4.3) and subsequently emitted to the atmosphere. There are two main process-integrated 'mechanisms' which reduce the emissions of SO<sub>x</sub> from carbon black plants. These are:

- the use of low sulphur feedstock
- increasing the sulphur retention in the product.

The use of low sulphur feedstock is the most straightforward way to reduce total SO<sub>x</sub> emissions from carbon black plants. Unfortunately, the common aromatic feedstock for the carbon black process has often a relatively high sulphur content. This is particularly true for Fluid Catalytic Cracker Residue (FCCR) from refineries. FCCR is by far the most widely available feedstock.

Table 4.14 gives the ranges of sulphur and nitrogen content of the predominant feedstocks used in the carbon black industry.

Feedstock	Synonym	S-content (%)*	N-content (%)**
Fluid catalytic cracker residue (FCCR)	Decant oil	<1 – 6	0.1 – 0.3
Ethylene cracker residue (ECR)	Naphtha cracker oil or ethylene tar	<0.5	0.1 – 0.4
Coal tar distillates (CTD)	Creosote oil	<1	0.7 – 1.5
Natural gas		0.005	Not available
* see Table 4.5 above			
** based on limited data			

**Table 4.14: Sulphur and nitrogen content of feedstock used in the carbon black industry [47, InfoMil, 2002]**

In the US, the average sulphur content in feedstock used to produce rubber blacks is 3.4 % [47, InfoMil, 2002]. In Europe, the average sulphur content is lower (in the order of 2 %). In Table 4.5, the permitted S-levels of the North American and European plants were given. These data confirm the observation that feedstock S-levels are higher in the US than in Europe. ICBA has stated that most plants operate close to their permitted feedstock S-level.

In turn, in Table 4.15 examples are given of three European plants that have been committed to using a low sulphur feedstock. It should be noted that these actual values are well below the permitted feedstock S-levels of these plants, because the facilities produce speciality carbon black products that require the use of a low sulphur feedstock or the facilities were able to obtain a low sulphur feedstock at a competitive price.

Plant	Main product	1997	1998	1999
Sweden	Commodity blacks	0.32	Not available	0.37
The Netherlands (plant A)	Speciality blacks	Not available	0.35	0.63
The Netherlands (plant B)	Commodity blacks	0.70	0.65	0.42

**Table 4.15: Actual annual average feedstock sulphur content of three carbon black plants [47, InfoMil, 2002]**

The retention of sulphur in the carbon black product is another mechanism that influences the overall SO<sub>x</sub> emissions. As more sulphur is retained in the product, sulphur levels in the tail-gas will decrease, resulting in lower SO<sub>x</sub> emissions to air.

However, there are limits on the amount of sulphur in the carbon black that users can tolerate; this varies from application to application. More importantly, very little is known about how to affect the fraction of sulphur retained in a particular grade of carbon black. It is known that an increase or a decrease of the sulphur content in the carbon black coincides with the sulphur content of the feedstock. However, this is not necessarily proportional to the retention percentage, as the carbon black grade and the conditions in the carbon black reactor also play an important role. Thus, for a given sulphur content in the feedstock, the retention of sulphur in the product is not a variable control in the carbon black process and not a 'process-integrated' mechanism. Due to the aforementioned factors, the sulphur retention in the product normally varies between 35 to 50 % of the sulphur content of the feedstock. For the reasons mentioned above, the use of low sulphur feedstock is considered the major way of reducing total SO<sub>x</sub> emissions from carbon black plants and, therefore, it is discussed in more detail in the next paragraphs.

#### Achieved environmental benefits

The main process-integrated 'mechanism': the use of low sulphur feedstock, is aimed at primary SO<sub>x</sub> reduction, in order to decrease the emissions of SO<sub>x</sub> from carbon black plants to the atmosphere.

#### Cross-media effects

As far as the use of low sulphur feedstock is concerned, deeper desulphurisation of the carbon black feedstock, in particular of the Fluid Catalytic Cracker Residue (FCCR) from refineries, would call for additional investment and increased energy usage in upstream refineries. On the other hand, reducing SO<sub>x</sub> with a low sulphur feedstock (e.g. using Coal Tar Distillates – CTD) that contains higher levels of NO<sub>x</sub> precursors than Fluid Catalytic Cracker Residues (FCCR), may result in increased NO<sub>x</sub> emissions. In turn, with regard to increasing the sulphur retention in the product there are limits on the amount of sulphur in the carbon black that users can tolerate.

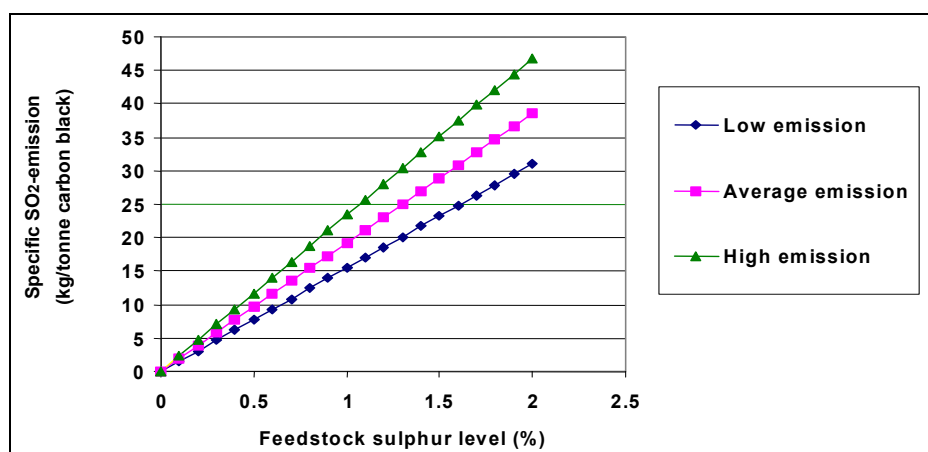
Operational data

## Advantages:

The emissions of SO<sub>x</sub> can be reduced to very low levels when a low S feedstock is used. The specific emission of SO<sub>2</sub> to air (in kg/tonne carbon black) can be calculated if the following parameters are known: (1) Feedstock sulphur level, (2) Amount of feedstock used per tonne of carbon black produced, and (3) Sulphur retention in the product. Figure 4.7 shows the relationship between feedstock sulphur levels and specific SO<sub>2</sub> emissions for different assumptions. Most rubber black plants have operational parameters between the high and the low emission scenario.

If also the amount of flue-gas from the tail-gas combustion is known (in dry Nm<sup>3</sup>/tonne carbon black), the SO<sub>2</sub> concentration in the flue-gas can be calculated. The amount of flue-gas depends on the amount and the calorific value of the tail-gas. A flue-gas emission of 10000 Nm<sup>3</sup> (dry)/tonne carbon black seems to fit quite reasonably in practice. Based on this assumption, when a feedstock with 1 % of sulphur is used, an SO<sub>2</sub> emission concentration of between 1550 and 2340 mg/Nm<sup>3</sup> at 3 % O<sub>2</sub> in the flue-gas must be expected. This corresponds well with the figure of 1400 mg/Nm<sup>3</sup> at 10 % O<sub>2</sub> given in VDI 2580, which equals a value of 2300 mg/Nm<sup>3</sup> at 3 % O<sub>2</sub>.

Figure 4.7 gives the relationship between the feedstock sulphur level and the specific SO<sub>2</sub> emission for three different scenarios. Low emission: S-retention is 50 % and the feedstock to product ratio is 1.55; high emission: S-retention is 35 % and the feedstock to product ratio is 1.80. The average emission represents intermediate values. Note that the levels reported in Figure 4.7 are achieved assuming that the secondary feedstock is natural gas. In the production of specialty grade carbon black (high surface pigment blacks), higher emission levels are expected.



**Figure 4.7: Relationship between the feedstock sulphur level and specific SO<sub>2</sub> emission [47, InfoMil, 2002]**

## Disadvantages:

- it is likely that the application of a low sulphur feedstock leads to increased feedstock transport distances, with the associated pollution from the transportation vehicles. From an LCA study [47, InfoMil, 2002], it became clear that the environmental benefit of applying low S feedstock is larger than the environmental burden of increased feedstock transport, even over long transportation distances (intercontinental). This would justify long range feedstock transportation from an environmental point of view. It should be noted, however, that transportation hazard risks were not part of this LCA
- some low sulphur feedstocks (e.g. Coal Tar Distillates – CTD) contain higher levels of NO<sub>x</sub> precursors than Fluid Catalytic Cracker Residues (FCCR). Thus, reducing SO<sub>x</sub> with a low sulphur feedstock may result in increased NO<sub>x</sub> emissions. On the other hand, if Ethylene Cracker Residues (ECR) are used instead of FCCR or CTD, this disadvantage is not present.

For economic disadvantages, see 'Economics' below.

#### Applicability

The use of a low sulphur feedstock can be applied in all carbon black plants. However, in general there is a price penalty for low S feedstock (see 'Economics' below). For some small numbers of high quality carbon black grades, the sulphur level in the product should be very low. In such cases, very low sulphur feedstock is selected. The resulting higher price of these products can normally be transferred to the consumer, which in such cases chooses high quality rather than price.

#### Economics

The main items related to the economics of the use of low S feedstocks are summarised below [47, InfoMil, 2002]:

- in terms of absolute quantities, there seems to be enough low S feedstock in Europe to theoretically supply the carbon black industry. The bottleneck is probably the amount of low S feedstock that is available at a competitive price
- there are competitors outside the carbon black industry for low S feedstock, mainly for use as a low S liquid fuel. They put additional pressure on the price of low S feedstock
- in general, low sulphur feedstock has a higher market value than higher sulphur feedstock. An analysis completed in 1994 indicated that the cost differential between 4 and 2 % sulphur feedstocks was approx. 30 %. In 2000, the average price differential between 3 and 1 % S per barrel US Gulf Coast FCC was 27 %. In the first quarter of 2001 this was 34 %. Similar price differentials exist today
- feedstock cost accounts for approximately 50 – 60 % of the total carbon black production cost and thus feedstock purchase plays an important role. However, the relevant question is not the absolute height of the feedstock price, but the ability to pass on the increased production cost to the customer. Most applications of commodity blacks are indifferent to reduced sulphur levels in the blacks, which leads to little or no added value. This makes it difficult to pass on increased production prices to the customer. For some speciality products, sulphur levels in the product must be very low and in that case, the higher price of the required low S feedstock can be transferred to the customer
- petroleum market prices have been subjected to extreme fluctuations. This is especially true at this time. The ICBA has stated that because an important part of the production is based on long term contracts with powerful customers, fluctuations in prices (also for high S feedstock) cannot always be transferred (immediately) to the customer. This puts a more balanced view to the previous point, but does not change the actual situation for individual plants
- there is a possibility that increased demand for low S feedstock will lead to increased prices
- the short feedstock market (in terms of price) is illustrated by the fact that the European carbon black industry imports feedstock from the US
- there is a tendency for the production of lower sulphur automotive fuels, which may also have a positive effect on the availability of low-S feedstock for the carbon black industry, due to increased (hydro)desulphurisation at refineries.

The above-mentioned aspects show that the economic implication of using low S feedstock may be quite significant and, in some cases, may exceed facility profit margins.

On the other hand, experience from three commercially operating plants (see Table 4.15 above) – two of which produce commodity rubber blacks almost exclusively – shows that, based on local conditions, it can be economically viable to operate with low S feedstock.

It should be noted, however, that both the Swedish and Dutch plants have relatively good access to locally available low sulphur feedstocks and, due to the local environmental regulations and other local arrangements and incentives, these plants are, at least partially, specialised in the production of low sulphur carbon black. Therefore, these three plants are not representative of the whole European carbon black industry, which is generally more dependent on deliveries of FCC feedstocks imported from the global market.

### Driving force for implementation

The protection of the environment by reducing the emissions of SO<sub>x</sub> to the atmosphere.

### Example plants

Three European plants have been committed to using a low sulphur feedstock (see Table 4.15 in the 'Description').

### Reference literature

[47, InfoMil, 2002], and [54, EIPPCB, 2004].

## **4.4.3 Tail-gas combustion devices and energy recovery**

### Description

The tail-gas contains significant quantities of hydrogen, carbon monoxide, methane and ethane/acetylene (see Table 4.8). These compounds can be combusted into carbon dioxide (CO<sub>2</sub>) and water (H<sub>2</sub>O), and used for recovering energy (see Section 4.3.5). The tail-gas also contains reduced sulphur compounds (CS<sub>2</sub>, COS and H<sub>2</sub>S) and nitrogen compounds (HCN and NH<sub>3</sub>), all of which are toxic and highly odorous (see also Table 4.8). During combustion, the sulphur compounds are converted into less toxic SO<sub>2</sub>. The nitrogen compounds are converted into inert N<sub>2</sub> and less toxic NO<sub>x</sub>.

The four types of devices, which are currently in use to combust the tail-gases at carbon black production facilities, are:

1. Product dryer combustion chambers
2. Boilers or combined heat and power (CHP) installations
3. Flares
4. Other thermal combustors

Product dryers are used to dry the wet pelletised carbon black. Nowadays, part of the tail-gas is burned to use the heat. Fifteen to thirty per cent of the tail-gas produced, can be combusted in the product dryers. This will reduce the purchased fuel consumption (natural gas) at that facility.

Tail-gas can be burned in a boiler. Sometimes supplemental fuel is added, due to the high moisture content and, therefore, relatively low calorific values of the tail-gas (1.7 – 3.8 MJ/m<sup>3</sup>), or to support the combustion during the short periods necessary for the grade changes in carbon black production. High pressure superheated steam can be generated and subsequently used for various applications in the carbon black plant. However, when all the tail-gas is combusted, carbon black production facilities cannot find use for all the steam generated. The remaining steam is, therefore, exported to neighbouring industry where a market exists, or condensed with air coolers or water-cooled heat exchangers. CHP produces electricity (power) and superheated high pressure steam (heat) simultaneously. The amount of steam produced is lower than in a standalone boiler, due to the production of electricity. CHP is only used when the revenue which can be obtained from the sale of electricity, justifies the investment in a CHP installation.

Flares can also be used to combust the tail-gas without energy recovery as the aforementioned devices do. Therefore, it would generally only be used to facilitate the disposal of excess tail-gas above that needed for the plant energy requirements. Flares at carbon black facilities are different in design compared to those in the oil industry (e.g. refineries), due to the lower calorific value of the tail-gas. At a carbon black facility the diameter of a flare is increased in order to decrease the velocity of the gas flow coming into contact with the flame. This decrease in tail-gas velocity increases the flame stability and contact time between flame and tail-gas. To ensure the stable flame at carbon black facilities, a windshield is placed around the flare tip. Furthermore, it is noticed that flares at carbon black production facilities are naturally smokeless and do not need steam liners or air blowers. In addition, they have been configured to minimise NO<sub>x</sub> generation. Lastly, it is noticed that tail-gas flares at carbon black facilities do not have to be so tall as hydrocarbon flares as there is less radiation heat.

Although the primary function of other thermal combustors and flares is to combust the tail-gas, the efficiencies, costs and designs are different. A flare is a simple design, where a flame (exposed to the atmosphere) is produced at the end of an open pipe, whereas the flame of a thermal combustor is enclosed in a combustion chamber. Because the flame is enclosed, the temperature and the amount of time that the tail-gas stays in contact with the flame are controlled. The temperature of a thermal combustor ranges from 650 to 1000 °C or more. A disadvantage of the higher operating temperature and longer retention time is the increased production of thermal NO<sub>x</sub>. Besides the combustion chamber, a burner management system for natural gas and an air blower is needed. Thermal combustors are capable of achieving combustion efficiencies similar to product dryers and boilers or CHP installations. Thermal combustors would normally, as with flares, only be used to facilitate the disposal of excess tail-gas above that needed for the plant energy requirements.

Although it may not be directly applicable to all carbon black plants, a reference is made here also to information and data included in the following documents:

- Council Directive 2004/8/EC of February 2004 on the promotion of cogeneration based on a useful heat demand in the internal energy market
- BREF on Common Waste Water and Waste Gas Treatment/Management Systems in the Chemical Sector (CWW).

#### Achieved environmental benefits

The toxic and odorous properties of the tail-gas can be largely destroyed by combusting the tail-gas, thus reducing the impact of the carbon black production on the environment.

#### Cross-media effects

As the total calorific value of the tail-gases is low and high volumes of tail-gases are produced, carbon black plants can typically use only a part of the available energy. If a local external customer for energy is not available, the excess tail-gas must be either combusted in flares without heat recovery or vented or the steam generated in boilers must be condensed and then the energy is lost (refer to the 'Description' above and to the 'Operational data' below).

Compared to the option of tail-gas venting, the following cross-media effects also apply to this technique: a) the use of a certain amount of support fuel (natural gas), and b) increased, thermally induced, NO<sub>x</sub> emissions.

#### Operational data

Advantages:

The recovery of the energy generated by tail-gas could be of great benefit to the carbon black plant and would enable it to make use of the energy thus produced, whether it be electric or thermal. The potential energy that can be recovered is dependent on the calorific value of the tail-gases and varies between 17 and 30 GJ/tonne carbon black produced. The energy remaining in excess of the carbon black plant's own requirements could be sold to an outside customer, assuming a market exists. NO<sub>x</sub> emissions of flares are expected to be lower than the NO<sub>x</sub> emissions of thermal combustors/boilers, due to the lower thermal NO<sub>x</sub> production of the flare – refer also to the BREF on LVOC.

Disadvantages:

Plants that fully recover the energy of the tail-gases require or consume only a part of the generated energy (steam/electricity). Finding an outside customer may solve this problem. However, finding an external customer for steam/electricity is frequently difficult and costs of CHP installations are large.



**Applicability**

The use of tail-gas in pellet dryers has been proven in the carbon black industry as the primary application. Most carbon black production plants should be technically able to install a boiler or CHP installation and thus recover and use the energy generated. Boilers and/or CHP installations are considered reliable to varying degrees. The reliability of boilers is much higher than that of CHPs due to their more simplified operation. If all tail-gases are combusted, an excess of heat and/or power is generated. In that case, economic possibilities to sell or re-use excess steam and power is required where local markets exist. Flares and thermal combustors are also generally applied in the carbon black industry.

Table 4.16 shows the number of plants in Europe and in the US, which are equipped with boilers, CHP installations, flares, thermal combustors or a combination of these combustion devices. A more detailed specification is shown in Table 4.17 and Table 4.18. From these tables it appears that there are large differences between the situation in the US and in Europe. Flares and thermal combustors dominate in the US, whereas CHP and boilers dominate in Europe. This is probably due to the historically higher energy price in Europe, which made investments in energy recovery more attractive in the past. The same situation still exists today. In the US, the primary attention has been to reduce toxic and odorous tail-gas emissions. From this perspective, flares and thermal combustors are economically more attractive.

Table 4.16 gives tail-gas combustion control devices (excluding product dryers) in Europe and the US. Most plants in Europe use a combination of devices.

<b>Control device</b>	<b>Europe</b>	<b>US</b>	<b>Total</b>
Boiler	10	3	13
Combined Heat and Power (CHP)	13	-	13
Flare	7	8	15
Thermal combustor	1	8	9
No control	1	3	4
Tail-gas sold	2	-	2
Not available (unknown)	4	2	6

**Table 4.16: Tail-gas combustion control devices in Europe and the US [47, InfoMil, 2002]**

In turn, Table 4.17 gives a summary of tail-gas combustion devices at carbon black plants in Europe (excluding Russia).

Location (Country)	Process	Tail-gas combustion device
Rozenburg (the Netherlands)	Furnace black	CHP and boilers
Berre L'étang (France)	Furnace black	CHP and flare
Stanlow (United Kingdom)	Furnace black	CHP and flare
Puerto de Zierbena (Spain)	Furnace black	Boiler and flare
Ravenna (Italy)	Furnace black	CHP and flare
Valasske-Mezirici (Czech Republic)	Furnace black	Tail-gas sold
Lillebonne (France)	Furnace black	Boiler and flare
Avonmouth (United Kingdom)	Furnace/thermal black	CHP
Hannover (Germany)	Furnace black	CHP
Santander (Spain)	Furnace black	Tail-gas sold
S. Martino di Trecate (Italy)	Furnace black	CHP and combustor
Tiszaujvaros (Hungary)	Furnace black	Boiler
Botlek (The Netherlands)	Furnace black	CHP and boiler
Malmö (Sweden)	Furnace black	CHP and boiler
Ravenna (Italy)	Furnace black	CHP and boiler
Hürth-Kalscheuren (Germany)	Furnace/gas/lamp black	CHP and flare
Sines (Portugal)	Furnace black	Boiler and vent
Ambès (France)	Furnace black	Boiler
Jaslo (Poland)	Furnace black	CHP and boiler
Dortmund (Germany)	Furnace/gas black	CHP and flare
Cutina (Croatia)	Furnace black	Not available (unknown)
Gliwice (Poland)	Furnace black	Not available (unknown)
Pitesti (Romania)	Furnace black	Not available (unknown)
Willebroek (Belgium)	(*)	Not available (unknown)

(\*) Special process for production of carbon black for special applications (e.g. batteries, electronics)

**Table 4.17: Summary of tail-gas combustion devices at carbon black plants in Europe [47, InfoMil, 2002]**

Table 4.18 gives a summary of tail-gas combustion devices at carbon black plants in the US.

Location (State)	Process	Tail-gas combustion device
Canal (LA)	Furnace black	Thermal combustor
Ville Platte (LA)	Furnace black	Flare
Pampa (TX)	Furnace black	None
Ohio River (WV)	Furnace black	Flare
Marshall (WV)	Furnace black	None
North Bend (LA)	Furnace black	Thermal combustor
El Dorado (AR)	Furnace black	Thermal combustor
Hickock (KS)	Furnace black	None
Ponca City (OK)	Furnace black	Thermal combustor
Phenix City (AL)	Furnace black	Thermal combustor
Sunray (TX)	Furnace black	Flare
Ivanhoe (LA)	Furnace black	Flare
Aransas Pass (TX)	Furnace black	Flare
Belpre (OH)	Furnace black	Flare/thermal combustor
Borger (TX)	Furnace/thermal black	Boiler
Echo (TX)	Furnace black	Thermal combustor/boiler
Baytown (TX)	Furnace black	Flare
Addis (LA)	Furnace black	Flare
Big Spring (TX)	Furnace black	Thermal combustor
Borger (TX)	Furnace black	Boiler
Baytown (TX)	Acetylene black	Not available (unknown)
Los Angeles (CA)	Lamp black	Not available (unknown)

**Table 4.18: Summary of tail-gas combustion devices at carbon black plants in the US [47, InfoMil, 2002]**

### Economics

The economic viability of a CHP is dependent upon local electricity costs and the price that can be obtained for the surplus electricity. The economic viability of a boiler is dependent upon the need for steam in the plant and the revenues that can be obtained for the sale of the steam.

In general, the investment costs of a boiler producing superheated high pressure steam (100 bar, 530 °C) varies between EUR 115000/tonne steam/hour (100 tonnes per hour installation) and EUR 70000/tonne steam/hour (200 tonnes per hour) [47, InfoMil, 2002]. In the carbon black industry, the unit will usually be in the range of 100 tonnes per hour at maximum, which would result in an investment of EUR 11.5 million. This corresponds with the figure given by the carbon black industry in Table 4.19.

Table 4.19 gives gross investment cost for flares, incinerators, boilers and CHP in the carbon black industry as stated by ICBA in EUR.

Type of combustion device	Gross investment cost (EUR)
Flare	0.5 – 1.5 million
Incinerator	5 – 15 million
Boiler	10 – 15 million
Combined heat and power	15 – 25 million
Assumptions: Typical plant size 75 kt per year carbon black production; total erection costs, including engineering, installing and additional equipment (stack, controls, foundations, etc.); tail-gas conveying system to combustion devices excluded.	

**Table 4.19: Gross investment cost for flares, incinerators, boilers and CHP in the CB industry [47, InfoMil, 2002]**

### Driving force for implementation

The main incentives for tail-gas combustion are energy recovery and reduction of odorous and toxic emissions to the atmosphere.

### Example plants

There are 24 carbon black plants in Europe (excluding those in Russia) and 22 plants in the US. For more information, see the 'Applicability' above.

### Reference literature

[47, InfoMil, 2002], [54, EIPPCB, 2004], [86, The Council of the EU, 2004].

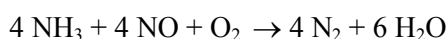
## 4.4.4 Selective Non-Catalytic Reduction (SNCR)

### Description

NO<sub>x</sub> emissions can be controlled either during the combustion process or can be treated by 'end-of-pipe' technologies. Controlling the NO<sub>x</sub> emissions during combustion has already been described in Section 4.4.1. The commercially available 'end-of-pipe' technologies to reduce NO<sub>x</sub> emissions, are Selective Non-Catalytic Reduction (SNCR) and Selective Catalytic Reduction (SCR). SNCR as well as SCR are based on the same mechanism in which the SCR differs from SNCR by using a catalyst.

The SCR process is further elaborated in Section 4.4.5, while this section focuses on the SNCR process.

SNCR is a commercially available process for the reduction of NO<sub>x</sub> emissions. In the SNCR process, ammonia (NH<sub>3</sub>) is used as the chemical to reduce NO<sub>x</sub> emissions. The basic reaction between the NH<sub>3</sub> and NO<sub>x</sub> is shown below.



The aforementioned chemical reaction is fast, normally less than 0.1 seconds. However, in practice longer residence times (up to seconds) are needed. The range of temperatures at which the reaction takes place is called the temperature window. The  $\text{NH}_3$  reacts most effectively with  $\text{NO}_x$  between 850 and 1150 °C. If the temperature is too high, a competing reaction generates unwanted  $\text{NO}_x$ . If the temperature is too low, the efficiency of  $\text{NO}_x$  reduction decreases, and emission of residual ammonia can occur ( $\text{NH}_3$  slip).

The  $\text{NH}_3$  can be introduced into the flue-gas either by direct injection of gaseous ammonia or by injection of an aqueous solution. In the first case, ammonia in its liquid anhydrous form is converted into gaseous ammonia in an evaporator and is subsequently injected with a carrier gas (low pressure steam or compressed air) into the flue-gas stream. If injection of an aqueous solution is the chosen method, the most commonly used solutions are ammonium hydroxide ( $\text{NH}_4\text{OH}$ ) or urea ( $\text{CO}(\text{NH}_2)_2$ ).

Injections of gaseous ammonia and ammonium hydroxide have lower optimum reaction temperatures than an injection of urea, 950 – 1050 °C compared to 1000 – 1150 °C respectively. It is noted that good mixing of reagents and  $\text{NO}_x$  in the flue-gas at the optimum temperature is essential to reach high  $\text{NO}_x$  reduction (50 – 80 %). In order to meet the optimum temperature and to compensate for fluctuations in temperature, several sets of injector nozzles and temperature recorders have to be installed at different levels.

Reference is also made here in particular to information included in the BREF on Common Waste Water and Waste Gas Treatment/Management Systems in the Chemical Sector (CWW).

#### Achieved environmental benefits

Selective Non-Catalytic Reduction (SNCR) is an ‘end-of-pipe’ process applied for the reduction of  $\text{NO}_x$  emissions to the atmosphere.

#### Cross-media effects

SNCR is associated with a certain amount of ammonia slip, the control of which is more difficult during periods of carbon black grade changes and other operational changes (e.g. changing tail-gas flow). In addition, below 280 °C, ammonia slip will form deposits of salts in the flue-gas, thus causing an emission of ammonium bisulphate particulate matter and corrosion. These deposits could be prevented by increasing the operating temperature to above 280 °C, this however would lead to a 7 to 10 % loss of the boiler efficiency. Refer also to the disadvantages in the ‘Operational data’ below.

#### Operational data

Advantages:  $\text{NO}_x$  reduction levels of 50 – 80 % are claimed in power plants. Experience of performance around 60 % is available in the carbon black industry (see also ‘Example plants’ below), where relatively high  $\text{NO}_x$  levels were observed [47, InfoMil, 2002]. SNCR is an attractive process from the point of view that no catalyst (means: less capital) is required, as is the case with Selective Catalytic Reduction (SCR).

Disadvantages: SNCR is associated with a certain amount of ammonia slip. General industrial practice shows that under steady conditions, this slip can be kept below 15 ppmv in the normal range of  $\text{NO}_x$  reduction performance. Experience in the carbon black industry has shown that the control of ammonia slip is more difficult during periods of carbon black grade changes and other operational changes (e.g. changing tail-gas flow).

In addition, below 280 °C and in the presence of  $\text{SO}_x$ , ammonia slip can form deposits of salts (see ‘Cross-media effects’ above).

The various solutions to deal with the problem of deposits are summarised below:

- maintain the ammonia content below 5 ppmv at the exit of the reaction zone
- keep the flue-gas temperature above 280 °C
- size the equipment to avoid obstructive phenomena and increase cleaning frequency.

A reliable strategy is to keep the temperature in the flue-gases over 280 °C. Unavoidably, this will result in some 7 – 10 % efficiency loss of the boiler. This, in turn, puts a significant pressure on the economics and the cross-media of the SNCR – see ‘Economics’ below [47, InfoMil, 2002].

The evaporation and heating of the ammonia solution from ambient temperatures to around 1100 °C requires heat that is provided by the flue-gases. This reduces boiler efficiency with a little over 1 % [47, InfoMil, 2002].

Proper operation of an SNCR system requires continuous monitoring of ammonia and NO<sub>x</sub> in an attempt to prevent significant ammonia slippage and to maintain high NO<sub>x</sub> conversion levels. However, experience has shown that continuous measurement devices for NO<sub>x</sub> and ammonia, which are successfully applied in commercial power plants, exhibit a reduced reliability in carbon black plants. This is partly caused by salt deposits in the tubes leading to the detection head of the measuring system, and partly because of the very high water content of the flue-gases (see ‘Example plants’ below).

The storage and use of gaseous or liquefied ammonia implies an increased safety risk. The complication and costs involved with the handling and storing of ammonia according to safety rules that exist in most countries, makes it favourable to use aqueous ammonia solutions or other chemicals, such as urea solutions. However, the use of urea may lead to the formation of nitrous oxide (N<sub>2</sub>O) as a by-product. Nitrous oxide is a greenhouse gas and its formation would have a negative impact on the overall environmental performance of the SNCR.

From the large number of potential disadvantages that are associated with the application of SNCR, it can be concluded that SNCR is a technique that should be considered with caution. The disadvantages might outweigh the benefits of this technique in certain cases [47, InfoMil, 2002].

Operational information on the application of SNCR at a carbon black plant in Sweden follows:

- it was installed in 1995 on a tail-gas fired CHP. The background for the installation were the unexpectedly high NO<sub>x</sub> emission levels, most probably due to the raw material used. Under optimal operating conditions, meaning a steady operation of the carbon black production and the CHP, a NO<sub>x</sub> reduction exceeding 70 % can be achieved [47, InfoMil, 2002]. However, after each grade change there is a change in tail-gas composition and, therefore, a change in the NO<sub>x</sub> reduction, until optimal operating conditions are reached again. Permit conditions are therefore demanding an average of 60 % NO<sub>x</sub> reduction as a yearly average. Furthermore, the permit requires the ammonia slip to be less than 15 ppmv as a monthly average (at 1.5 % O<sub>2</sub>)
- in 1995, a monitoring installation for NO<sub>x</sub> and NH<sub>3</sub> was also installed. It works by continuous extraction from the stack in heated ducts (200 °C), using infrared photometry in wet gas for analysis. In principle, it has a low detection limit and a high accuracy. This is still ‘state-of-the-art’ equipment for power plants. However, it appeared that the measuring equipment did not provide the data as quickly and as reliably as required in order to ensure an efficient and fast control of the ammonia injection. Specific problems encountered were: the high water content of the flue-gas, which interferes with the NO<sub>x</sub> measurement, and the deposition of ammonium bisulphate in the ducts from the stack to the analyser that interferes with the ammonia measurements. These problems appear to be highly specific to the carbon black industry. Until now, the suppliers of the measuring equipment have not been able to solve the problem with the current equipment. The plant has tried to solve its monitoring problems
- the plant has also experienced serious problems with salt deposits on the heat exchangers. This has led to a loss of boiler efficiency. Furthermore, in combination with the frequent crossing of the dew point during start-up and shut-down and grade changes, serious corrosion has been experienced on the heat exchangers as well. It should be noted that the problems have occurred in a heat exchanger zone where the temperature was below 280 °C. It is not possible for the plant to change the heat exchanger design as the boiler was initially designed for optimised energy recovery.

### Applicability

In principle, SNCR can be applied where a temperature window is available in the range of 850 to 1150 °C. In the carbon black industry, this window occurs in the carbon black reactor and in or after the tail-gas combustion device(s).

There are several reasons why the application of SNCR is not possible/useful in the reactor:

- SNCR disturbs the carbon black production process. It is expected that ammonia injection interferes with the characteristics of the carbon black and has a negative impact on product quality
- due to the high gas velocities in the reactor (up to 450 m/s), the residence time of gases in the reactor is too low to allow for any significant reaction between  $\text{NH}_3$  and  $\text{NO}_x$
- apart from this, the  $\text{NO}_x$  level in the gases from the reactor are relatively low. The majority of the  $\text{NO}_x$  from carbon black plants is thermal- $\text{NO}_x$  and fuel- $\text{NO}_x$  formed during the combustion of tail-gas in dedicated combustion devices. Therefore, it would be rather ineffective to focus on  $\text{NO}_x$  reduction in the carbon black reactor.

Therefore, the only remaining place to implement SNCR in carbon black plants is in or just after the combustion devices (i.e. boiler or thermal combustor) of the tail-gases.

SNCR systems perform best when the required temperature window can be accessed easily and continuously. Thus, steady operating conditions benefit the performance. When operating conditions are not steady, ammonia slip (excessive ammonia emission) or inadequate  $\text{NO}_x$  treatment, resulting in significant  $\text{NO}_x$  emission increases, may occur. In a carbon black plant, operating conditions are not always steady, with frequent grade changes and changes in the tail-gas flow due to changes in dryer demand. Grade changes may occur up to twenty times per month per reactor for a standard rubber black plant and between 0.5 to 4 hours are normally needed to reach a steady reactor operation and tail-gas composition.

This period may be longer for pigment and special rubber grades. A change in dryer demand is generally also related to the grade produced. During these changes, the different flow and calorific value of tail-gas influences the temperature distribution in and after the combustion device. This may result in a drop of SNCR performance until a new steady state is reached.

The SNCR performance can be monitored online by continuous measuring of the temperature in the injection zone, and ammonia slip and  $\text{NO}_x$  in the stack. If the parameters exceed preset levels, automated corrective measures are normally taken. These measures may consist of a change in the injection configuration and an increase or decrease of ammonia injection. Minor fluctuations in operating conditions can normally be sufficiently controlled by this means. The change in combustion conditions during and after a grade change may need further analysis of monitoring data. It may be beneficial to work with default ammonia injection 'programmes' for each different grade. It should be noted that the monitoring of  $\text{NH}_3$  and  $\text{NO}_x$  in the flue-gas from carbon black plants is complicated due to the presence of ammonium sulphates and the high water content of the flue-gases. Although this does not directly influence the performance or applicability of the SNCR, it jeopardises proper control of the SNCR performance.

SNCR is only installed in one plant in the EU; the ICBA considers this technique not successfully demonstrated.

More information on this is given in paragraph 'Example plants' below.

### Economics

Swedish case without energy valorisation:

Based on the annual environmental report of the Swedish plant (described in 'Example plants' below), their economic data, and the Dutch cost effectiveness methodology, a cost effectiveness of EUR 0.84 – 0.91 reduction per kg  $\text{NO}_x$  could be calculated for this plant.

This also involves the cost for early depreciation of old measuring equipment and heat exchangers and 'normal' depreciation for the new measuring equipment and heat exchangers.

Nevertheless, the following aspects should be taken into account when judging the above-mentioned figure:

- costs associated with a reduced boiler efficiency were not valorised (see below for valorisation)
- the initial NO<sub>x</sub> levels of the Swedish plant were high, which results in relatively low cost effectiveness figures. Figures would probably be higher in plants with a lower initial NO<sub>x</sub> value
- the feedstock sulphur levels in this plant are low. In applications with higher S levels, more attention must be paid to the formation of deposits of ammonium bisulphate, leading to more frequent inspections and maintenance, and in extreme cases higher replacement rates for equipment.

Costs of reduced boiler efficiency (general):

Decreased boiler efficiency may represent a significant cost factor. It could be assumed that the boiler efficiency is reduced, because flue-gases should not be cooled to temperatures lower than 280 °C to avoid potential problems with ammonium bisulphate deposits. Normal high sulphur applications without ammonia injection would be able to recover heat from the flue-gases down to around 180 °C. This 100 °C difference represents a certain calorific value. As a rule of thumb, every 10 – 15 °C represents 1 % boiler efficiency.

In addition, the evaporation and heating of the aqueous ammonia solution also reduces the boiler efficiency by around 1 %. Overall, a boiler efficiency reduction of 10 % could be expected when SNCR is installed and when the temperature strategy regarding ammonium bisulphate is adopted (see the disadvantages in the 'Operational data').

For an average energy recovery of 12 GJ/tonne carbon black, the efficiency loss could represent 1.2 GJ/tonne carbon black. The efficiency loss can be valorised by assuming that the lost energy is replaced by (for example) natural gas. In that case, an extra cost of {1.2 GJ/tonne carbon black} x {EUR 5 per GJ (price level natural gas)} = EUR 6 per tonne carbon black can be calculated. This corresponds to an extra reduction of EUR 0.82 per kg NO<sub>x</sub>. If this theoretical energy loss is projected on the Swedish case (refer to paragraph 'Example plants' below), a reduction of around EUR 1.7 per kg NO<sub>x</sub> can be calculated.

However, there are certain drawbacks to the calculation of the lost energy costs:

- many carbon black plants do not normally cool their flue-gases down to 180 °C. Values between 200 and 230 °C are also found. In such a case, the corresponding energy loss is less
- the calculation only makes sense if the lost energy is normally sold or would have to be replaced by another energy source
- the energy loss takes place at the lower end of the heat content of the flue-gas. This is normally the range with the lowest financial value
- it could be discussed by what source the lost energy should be replaced. This may be natural gas, but it may also be steam, district heating, etc.

To continue, the EUR 0.82 per kg NO<sub>x</sub> might represent a realistic value for a worst case approach for energy loss.

For a more realistic cost calculation of energy loss, the local situation needs to be taken as a point of reference.

### Driving force for implementation

The protection of the environment by reducing the emissions of NO<sub>x</sub> to the atmosphere.

#### Example plants

Since 1985, SNCR has been commonly implemented in several industrial sectors, such as the power and chemical industry. Most applications refer to natural gas fired plants (low sulphur and low dust), but there are also many high dust and high sulphur applications from coal and heavy liquid fuel fired power plants, from municipal waste incinerators, and from the glass and cement industries [47, InfoMil, 2002]. To ICBA's knowledge within the worldwide carbon black industry only one plant has installed SNCR; a carbon black plant in Malmö, Sweden, which has a production rate approximately 40000 tonnes carbon black per year for the rubber industry.

#### Reference literature

[47, InfoMil, 2002], [85, EIPPCB, 2004-2005].

### **4.4.5 Selective Catalytic Reduction (SCR)**

#### Description

Selective Catalytic Reduction (SCR) is a commercially available process for the reduction of NO<sub>x</sub> emissions. In the SCR method, the NO<sub>x</sub> concentration in the flue-gas is reduced by the injection of ammonia (NH<sub>3</sub>) in the presence of a catalyst (refer to the BREF on CWW).

In a carbon black plant, operating conditions are not always steady, with frequent grade changes and changes in the tail-gas flow due to changes in dryer demand. During these changes, the different flow and calorific value of the tail-gas influences the temperature distribution in and after the combustion device. This may result in a drop of SCR performance until a new steady state is reached.

Reference is made here also to information and data included in the BREF on Common Waste Water and Waste Gas Treatment/Management Systems in the Chemical Sector (CWW).

#### Achieved environmental benefits

Selective Catalytic Reduction (SCR) is an 'end-of-pipe' process applied for the reduction of NO<sub>x</sub> emissions to the atmosphere.

#### Cross-media effects

Increased dust load (e.g. during failure of a bag of the main product filter) should be taken into account when selecting the catalyst type. SCR is associated with a certain amount of ammonia slip, the control of which is more difficult during periods of carbon black grade changes and other operational changes (e.g. changing tail-gas flow). In addition, below 280 °C and in the presence of SO<sub>x</sub>, ammonia slip can form deposits of salts.

#### Operational data

Advantages:

NO<sub>x</sub> removal efficiencies of 75 to 95 per cent are realised in several industry sectors, such as the power industry and the glass industry. This also includes high dust and high S applications (see 'Example plants' below). However, with current knowledge there is no experience of the SCR process being used on an industrial scale within the carbon black industry. Actual NO<sub>x</sub> reduction depends on the initial NO<sub>x</sub> concentration, the temperature and the number of catalyst layers, the minimum level of residue NO<sub>x</sub> obtainable being limited in practice by the risk of unreacted ammonia and allowed ammonia emission concentrations.



Disadvantages:

- although the flue-gas from tail-gas combustion devices in carbon black plants normally contains no more than around  $35 \text{ mg/Nm}^3$  of dust, a temporarily increased dust load of up to  $1000 \text{ mg/Nm}^3$  may be expected during failure of a bag of the main product filter. This should be taken into account when selecting the catalyst type. Either a plate-type high dust SCR catalyst is selected (with a lower specific area, but also a lower pressure drop) or a honeycomb low dust SCR catalyst with upstream dust filtering or with an SCR bypass system during filter failure. Additional 'blowers' may be required for the high dust application
- SCR is associated with a certain amount of ammonia slip. General industrial practice shows that under steady conditions, this slip can be kept below 15 ppmv in the normal range of  $\text{NO}_x$  reduction performance. In the carbon black industry, it is expected that the control of ammonia slip is more difficult during periods of carbon black grade changes and other operational changes (e.g. changing the tail-gas flow)
- in addition, below  $280^\circ\text{C}$  and in the presence of  $\text{SO}_x$ , deposits of ammonium bisulphate ( $\text{NH}_4\text{HSO}_4$ ) on the catalyst and downstream equipment may occur, causing a deactivation of the catalyst and possibly a decrease in the efficiency of the boiler. This will have an adverse effect on the lifetime of catalyst. See also Section 4.4.4 for more details on the specific aspects of ammonium bisulphate deposition and preventive measures
- proper operation of an SCR system requires (continuous or intermittent) monitoring of ammonia and  $\text{NO}_x$
- in many countries, there are strict regulations for transport and handling, including unloading, of gaseous or liquefied ammonia, due to an increased safety risk. The complication and costs involved with handling and storing according to safety regulations makes it favourable to use ammonia solutions (25 % in water).

### Applicability

In principle, SCR can be applied where a temperature window is available in the range of  $270$  to  $430^\circ\text{C}$  (or  $100 - 150^\circ\text{C}$  for activated carbon applications). In the carbon black industry, this window occurs in the tail-gas heat exchangers (furnace air preheaters and waste heat boiler) and after the tail-gas combustion device(s). There are several reasons why the application of SCR is not possible/useful in the tail-gas heat exchangers:

- the  $\text{NO}_x$  level in the gases from the reactor are relatively low. The majority of the  $\text{NO}_x$  from carbon black plants is thermal  $\text{NO}_x$  and fuel- $\text{NO}_x$  formed during the combustion of the tail-gas in dedicated combustion devices. Therefore, it would be rather ineffective to focus on  $\text{NO}_x$  reduction in the tail-gas
- the temperature zone does not coincide with an available temperature range of tail-gas. This means that additional quench or reheating is necessary, or that the existing heat exchangers must be split
- it can be expected that the SCR interferes with the operation of a plant (pressure drop, negative impact on the product) and vice versa (clogging of SCR, corrosion of catalyst).

Therefore, the only remaining place to implement SCR in carbon black plants is after the combustion devices (i.e. boiler or thermal combustor) of the tail-gas [47, InfoMil, 2002].

The main factors that determine the choice of catalyst and its configuration are the gas temperature, sulphur content and upstream dust loading. There might be restrictions with respect to the deposition of ammonium bisulphate. Furthermore, it is noted that the optimum process temperature for SCR can be tuned with the boiler. However, in many cases this will cause boiler efficiency loss.

An SCR installed after a flare is not feasible, due to combustion into open air.

SCR is not installed in any of the carbon black plants in the world and problems regarding SNCR have already been mentioned in Section 4.4.4. Additionally, clogging of the catalyst is possible due to formation of ammonium bisulphate and ammonium sulphate, which will occur unless a less efficient plate-type catalyst with a lower specific area is used.

#### Economics

Implementing an SCR unit in a Dutch carbon black plant was investigated by Parsons [47, InfoMil, 2002]. The estimated capital costs of the SCR unit included: revision of the boilers' flue-gas ducting, the catalyst module and its housing, flue-gas filtering upstream and downstream, the ammonia storage, a control and injection system, an extra fan and a new stack.

Costs have been developed as factored estimates based on the vendor quotations received, and are believed to be accurate to +31/- 15 %.

The total capital costs were estimated at EUR 18920000. The estimated operating costs, including additional operating personnel, maintenance material and labour, catalyst, chemicals, utilities and dust disposal, are EUR 2782000 per year. The additional fuel, due to the efficiency loss of the boiler, accounts for 35 % of the total, and catalyst replacement 5 %. The basis for catalyst replacement is a complete change every 3 years.

In an investigation on another Dutch carbon black plant, investment costs for a combined deSO<sub>x</sub>/deNO<sub>x</sub> system were calculated as EUR 9.94 million, with operating costs of EUR 1.35 million per year. The carbon black industry considers these costs as too low and theoretical. They argue that adequate regard was not given to the details of ancillary equipment required to retrofit the system into an existing installation, and the investment and operation costs of waste water treatment.

#### Driving force for implementation

The protection of the environment by reducing the emissions of NO<sub>x</sub> to the atmosphere.

#### Example plants

SCR is a commercially available process and has been widely used since the 1980s to reduce NO<sub>x</sub> emissions from combustion equipment ranging from gas turbines to coal-fired steam plants. Furthermore, SCR has been implemented successfully in several industry sectors (chemical industry, glass industry, steel industry). However, with the current knowledge no SCR process is implemented in the carbon black industry.

The majority of worldwide SCR applications include low dust low SO<sub>x</sub> configurations, but many high dust and high SO<sub>x</sub> applications exist as well. Of particular interest for the carbon black industry are the experiences with high dust plate-type SCR catalyst applications in coal fired and heavy liquid fuel fired power plants. Experiences from such plants show excellent operation at high dust and very high SO<sub>x</sub> levels (up to 2300 ppmv) on the catalyst [47, InfoMil, 2002].

#### Reference literature

[47, InfoMil, 2002], [85, EIPPCB, 2004-2005].

### **4.4.6 Flue-gas desulphurisation (deSO<sub>x</sub>)**

#### Description

In order to reduce sulphur emissions to air, the following two routes can be taken:

- removal of sulphur compounds in the tail-gases
- oxidation of the sulphur compounds into SO<sub>x</sub> (step 1) and subsequently treatment of the SO<sub>x</sub> containing flue-gases with an end-of-pipe deSO<sub>x</sub> unit (step 2).

Approximately 30 'end-of-pipe' deSO<sub>x</sub> processes are known and have been widely used for many years now in numerous industries.

Reference is made here also to information and data included in the BREF on Common Waste Water and Waste Gas Treatment/Management Systems in the Chemical Sector (CWW).

### Achieved environmental benefits

Reduction of the emissions of SO<sub>x</sub> to the atmosphere.

### Cross-media effects

Information on various processes can be found in the BREF on CWW.

### Operational data

Refer to the BREF on CWW.

### Applicability

Wet processes, semi-dry processes and dry processes are commercially widely available and are implemented in numerous industries. The alkali-based wet processes are commonly applied in large combustion plants (e.g. power plants). Alkali-based semi-dry and dry processes gain more importance, especially for the process industry (e.g. iron and steel industry, glass industry). The experience with the non-alkali based and/or catalysed processes is less widespread and more limited to niche applications.

In principle, most of the wet, semi-dry, dry and other deSO<sub>x</sub> processes available for industry (refer to the BREF on CWW) would be applicable to desulphurise the flue-gases coming from waste heat boilers, combined heat and power plants, or other thermal combustion devices for the tail-gases.

However, there are large differences in cost, reliability, removal efficiency, cross-media effects, etc. Theoretically, SO<sub>x</sub> removal could also take place in the tail-gas directly after the main unit filter. However, as most of the sulphur compounds in the reactor and the tail-gas are in reduced form, the efficiency of SO<sub>x</sub> reduction equipment would be extremely low and thus application would not be useful.

### Economics

The following references on economics were received from the carbon black industry:

- on request of a carbon black plant in Louisiana, US, a cost analysis was made for the double alkali process. The following data were quoted: Based on a 4 wt-% sulphur feedstock, a flue-gas flowrate of 40908 m<sup>3</sup>/hr and an assumed SO<sub>2</sub> removal efficiency of 90 %, approximately 475 tonnes of sulphur would be removed. The total capital costs were calculated to be USD 3550800 (EUR 3.79 million). The estimated annual operating costs were ranging between USD 762045 and 925690 (EUR 813000 and EUR 987000)
- investment and operating costs for the limestone process are calculated based on vendors quotations. The following data were quoted: The investment costs for limestone scrubbing of approximately 200000 Nm<sup>3</sup>/h wet boiler flue-gas was EUR 20.73 million. Operating costs were calculated at EUR 1.69 million per year (depreciation of capital excluded) or EUR 4.78 million including depreciation of capital at a rate of 14.9 % per year. This figure includes personnel, maintenance, utilities, and chemical supply, and disposal and a nominal cost for treatment and disposal of waste water
- investment and operating costs for the Degussa process have also been estimated. The following data were quoted: For removal of 928 tonnes SO<sub>2</sub> per year, an investment of EUR 19.71 million has to be made. Operating costs per year are EUR 1.88 million, with a capital burden of 14.9 %/yr excluded. The total annual costs would be EUR 4.82 million including capital burden.

#### Driving force for implementation

The protection of the environment by reducing the emissions of SO<sub>x</sub> to the atmosphere.

#### Example plants

In the carbon black industry in Europe and North America, no applications of flue-gas desulphurisation exist.

#### Reference literature

[47, InfoMil, 2002].

### **4.4.7 Dust removal/separation measures**

#### Description

In the carbon black industry, dust removal essentially means the separation of carbon black from various gas streams in the plant. The type of filter that is applicable is highly specific to the gas stream considered, as follows:

- the tail-gas from the reactor
- the purge gas from the product dryers
- the vent of the pneumatic carbon black conveying system
- the vent of dust collection systems
- the flue-gas from the tail-gas combustion device.

In order to separate the carbon black from the process streams, the following dust-arresting techniques can be mentioned:

- cyclones
- fabric filters (FF)
- electrostatic precipitators (ESP)
- scrubbers.

In practice, only fabric filters and scrubbers are applied. Cyclones do not perform well due to the small particle size of the carbon black. They are only applied in conjunction with downstream fabric filter systems in the flue-gases from the dryer.

ESPs involve higher investments with lower separation efficiency compared to fabric filters and are not applied in the carbon black industry.

The key characteristics of fabric filters for use in gas filtration include temperature and resistance to acids, alkalis and flexing (due to bag cleaning). Also, gas humidity can affect the strength and dimensional stability of the fabrics, due to hydrolysis. Several basic fibre properties are summarised in Table 4.20 below.

The most important criteria of performance for filtration devices are collection efficiency and pressure drop, which are determined by the specific filter area. The specific filter area loading in carbon black plants for product separation from the process gas are normally:

- to 0.5 m<sup>3</sup>/(min.m<sup>2</sup>) in filters with reverse flow and mechanical shaking
- 0.25 to 0.4 m<sup>3</sup>/(min.m<sup>2</sup>) in filters with only reverse flow cleaning
- to 1.2 m<sup>3</sup>/(min.m<sup>2</sup>) in filters with pulse-jet cleaning.

At these filter areas loading, the filter pressure drops are between 8 and 35 m bar.

Fabric filter characteristics are given in Table 4.20.

Fabric	Maximum temperature (°C)	Resistance		
		Acid	Alkali	Flex
Cotton	80	Poor	Good	Very good
Polypropylene	95	Excellent	Excellent	Very good
Wool	100	Fair	Poor	Very good
Polyester	135	Good	Good	Very good
Nomex (nylon)	205	Poor to fair	Excellent	Excellent
Teflon	235	Excellent	Excellent	Fair
Fibreglass	260	Fair to good	Fair to good	Fair

**Table 4.20: Fabric filter characteristics**  
[47, InfoMil, 2002]

The tail-gas from the reactor carries the carbon black product to the main product filter, where the product is separated from the tail-gas. These main product filters consist of fabric filters that are essentially highly specific to the carbon black industry and most companies have a proprietary design.

The temperature of the tail-gas in the separation section is around 200 - 250 °C and therefore, the choice of fabric is limited (see Table 4.20). Remaining levels of carbon black in the tail-gas are below 100 mg/m<sup>3</sup>, but occasionally the malfunctioning of a bag may cause levels of up to 1000 mg/m<sup>3</sup> in the tail-gas.

It should be noted that the tail-gases are normally not emitted to the atmosphere, but directed to a tail-gas combustion device. Furthermore, any carbon black passing through the filter means a loss of product and, therefore, it is in the interest of the industry to keep this level low.

During start-up (warming up) and shutdown (cooling down) of the reactor, the fabric filter is bypassed and the gases from the reactor are commonly vented upstream of the main product filter in a dedicated stack. During start-up and shut-down, the gases from the reactor are almost carbon black free as the feedstock supply is stopped or not yet started. However, during emergency stops the vented gases may carry large amounts of carbon black. Therefore, the venting points are normally equipped with simple design wet scrubbers that eliminate most of the carbon black prior to emission to the atmosphere.

The purge gas from the product dryers carries carbon black particles from the dryer drums that are commonly treated by means of fabric filters. In view of the high water content of these purge gases, the temperatures must be kept appropriately over the dew point. Due to this, the temperature is often kept above 150 °C and, therefore, Nomex, Teflon or fibreglass can all be used as fabric.

As for the venting of the pneumatic carbon black conveying system, carbon black facilities usually convey the product from the main filter to the product dryers by means of an air conveying system. The conveying air is filtered prior to venting. Here, temperatures are lower than 150 °C, allowing for the use of numerous types of filters. Typical loads for these filters range from 0.6 to 1.4 m<sup>3</sup>/(min m<sup>2</sup>), and particulate matter concentrations after the filter are 30 mg/Nm<sup>3</sup> or lower.

In principle, dust collection systems are comparable with the pneumatic conveying system due to the low temperature and the use of atmospheric air.

The flue-gases from the tail-gas combustion device are normally not treated. The dust load of this flow is between 10 and 30 mg/Nm<sup>3</sup> (at 10 % O<sub>2</sub>) and contains mainly particulate matter formed after combustion, aerosols (e.g. ammonium sulphates, sulphuric acid) and entrained uncombusted carbon black. In some cases, the dust emissions from this source need correction for sulphuric acid.

Reference is made here also particularly to the BREF on Common Waste Water and Waste Gas Treatment/Management Systems in the Chemical Sector (CWW).

Achieved environmental benefits

Reduction of the emissions of carbon black dust to the atmosphere.

Cross-media effects

Refer to the disadvantages in Table 4.21 below.

Operational data

The advantages and disadvantages of the aforementioned types of dust-arresting techniques are presented below in Table 4.21.

Dust-arresting technique	Advantages	Disadvantages
Cyclones	Robust, relatively simple and reliable. Widely applied in the CB industry.	Low efficiency for carbon black dust. By-product/waste generation.
Fabric filter	Dryer purge gas filter: <math><30 \text{ mg/Nm}^3</math>; >99.90 % efficiency Conveying system filter: <math><30 \text{ mg/Nm}^3</math>; >99.99 % efficiency Dust collection filter: <math><30 \text{ mg/Nm}^3</math>; >99.90 % efficiency Relatively simple and reliable. Widely applied in the CB industry	May generate off-spec carbon black (*). Relatively high energy consumption. Sensitive to moisture.
Electrostatic precipitator (ESP)	Carbon black performance unknown. Relatively low power requirements. Ability to accommodate gas temperatures in the range of 120 – 320 °C.	By-product/waste generation. Fluctuating dust removal efficiency, due to production changes. Corrosion below dew point in the presence of H <sub>2</sub> S, HCN or SO <sub>x</sub> . Deposition of ammonia salts below 280 °C, due to presence of NH <sub>3</sub> in the case of SNCR/SCR.
Scrubbers	Robust, relatively simple and cheap.	Lower efficiency.
(*) Off-spec carbon black can be recycled back into the process to a certain extent. This can be done by admixing small quantities of off-spec carbon black with regular carbon black. Product specifications finally determine the total amount of off-spec carbon black that can be reprocessed.		

**Table 4.21: Advantages and disadvantages of dust-arresting techniques**  
[47, InfoMil, 2002]

Applicability

For information on the applicability of cyclones and scrubbers, see above.

In the carbon black industry, fabric filters are widely used. However, each application has its specific type of fabric filter:

- fabric filters of a special and often proprietary design are used in all carbon black plants around the world to separate the product from the tail-gas in the main process filter
- fabric filters of a common (high temperature, normal pressure drop) design are widely used for treatment of the dryer flue-gas, often in combination with upstream cyclones to reduce the dust load on the fabric filter
- fabric filters of a common (low temperature, low pressure drop) design are commonly used as a purge filter for the pneumatic conveying systems in carbon black plants around the world.

Although theoretically ESPs can be applied in the carbon black industry, because of the high dust loads and humidity as well as fluctuating operating conditions inherent to the production of different carbon black grades, ESPs are less suitable. Furthermore, corrosion problems may occur below the dew point, due to presence of acids ( $\text{H}_2\text{S}$ ,  $\text{HCN}$ ) in the tail-gas or acid forming precursors ( $\text{SO}_x$ ) in the flue-gases from the tail-gas combustion device. Finally, deposition of ammonium bisulphate may occur below  $280\text{ }^\circ\text{C}$  when  $\text{NH}_3$  and  $\text{SO}_x$  are present in the tail-gas (see Section 4.4.4 on SNCR). Because of the difficult operating conditions, particularly at high concentrations of carbon black, ESPs are no longer used in the carbon black industry.

### Economics

There is very little information on the costs of dedusting measures in the carbon black industry. Due to the different types of filters and designs used, distinction should be made between the different applications. Recent investments in Europe for a main product (fabric) filter were EUR 80000 per  $1000\text{ m}^3/\text{hour}$ . These costs include gross investments up to the gas suction. These costs are rather high for a fabric filter, but this is due to the special design and the high requirements for main product filters in general.

### Driving force for implementation

The protection of the environment by reducing carbon black dust emissions to the atmosphere.

### Example plants

In the carbon black industry, fabric filters are widely used. With respect to ESPs, with current knowledge, no ESP is nowadays installed at a carbon black facility.

### Reference literature

[47, InfoMil, 2002].

## 4.5 Best Available Techniques for the production of carbon black

In understanding this section and its contents, the attention of the reader is drawn back to the preface of this document and in particular the fifth section of the preface: 'How to understand and use this document'. The techniques and associated emission and/or consumption levels, or ranges of levels, presented in this section have been assessed through an iterative process involving the following steps:

- identification of the key environmental issues for the sector, including:
  - dependence of the European carbon black industry on the availability of petrochemical and carbochemical feedstocks with a high carbon to hydrogen ratio and high aromatic content, which result in the highest yields and reduced impact on the environment
  - sulphur content in the feedstock used in the production of carbon black and its influence on the emissions of SO<sub>x</sub> to air
  - the modern furnace process used in the European carbon black industry which allows high plant throughput, the most characteristic environmental features of this process being high energy intensity (which offers the potential for improvement of energy efficiency within the process), and the emissions of NO<sub>x</sub>, SO<sub>x</sub> and dust to air
  - process-integrated measures, including primary NO<sub>x</sub> and SO<sub>x</sub> reduction, and tail-gas combustion with energy recovery, followed by possible end-of-pipe measures with the aim to reduce the emissions of NO<sub>x</sub>, SO<sub>x</sub> and dust to air, in order to lessen the impact of the production of carbon black in the EU-25 on the environment
- examination of the techniques most relevant to address these key issues
- identification of the best environmental performance levels, on the basis of the available data in the European Union and worldwide
- examination of the conditions under which these performance levels were achieved; such as costs, cross-media effects, and the main driving forces involved in implementation of the techniques
- selection of the best available techniques (BAT) and the associated emission and/or consumption levels for this sector in a general sense, all according to Article 2(11) and Annex IV of the Directive.

Expert judgement by the European IPPC Bureau and the relevant Technical Working Group (TWG) has played a key role in each of these steps and in the way in which the information is presented here.

On the basis of this assessment, techniques, and as far as possible consumption and emission levels associated with the use of BAT, are presented in this section that are considered to be appropriate to the sector as a whole and in many cases reflect the current performance of some installations within the sector. Where emission or consumption levels 'associated with best available techniques' are presented, this is to be understood as meaning that those levels represent the environmental performance that could be anticipated as a result of the application, in this sector, of the techniques described, bearing in mind the balance of costs and advantages inherent within the definition of BAT. However, they are neither emission nor consumption limit values and should not be understood as such. In some cases it may be technically possible to achieve better emission or consumption levels but due to the costs involved or cross-media considerations, they are not considered to be appropriate as BAT for the sector as a whole. However, such levels may be considered to be justified in more specific cases where there are special driving forces.

The consumption and emission levels associated with the use of BAT have to be seen together with any specified reference conditions (e.g. averaging periods).



The concept of 'levels associated with BAT' described above is to be distinguished from the term 'achievable level' used elsewhere in this document. Where a level is described as 'achievable' using a particular technique or combination of techniques, this should be understood to mean that the level may be expected to be achieved over a substantial period of time in a well maintained and operated installation or process using those techniques.

Where available, data concerning costs have been given together with the description of the techniques presented in the previous section. These give a rough indication about the magnitude of the costs involved. However, the actual cost of applying a technique will depend strongly on the specific situation regarding, for example, taxes, fees, and the technical characteristics of the installation concerned. It is not possible to evaluate such site-specific factors fully in this document. In the absence of data concerning costs, conclusions on economic viability of techniques are drawn from observations on existing installations.

It is intended that the general BAT in this section are a reference point against which to judge the current performance of an existing installation or to judge a proposal for a new installation. In this way they will assist in the determination of appropriate 'BAT-based' conditions for the installation or in the establishment of general binding rules under Article 9(8). It is foreseen that new installations can be designed to perform at or even better than the general BAT levels presented here. It is also considered that existing installations could move towards the general BAT levels or do better, subject to the technical and economic applicability of the techniques in each case.

While the BAT reference documents do not set legally binding standards, they are meant to give information for the guidance of industry, Member States and the public on achievable consumption and emission levels when using specified techniques. The appropriate limit values for any specific case will need to be determined taking into account the objectives of the IPPC Directive and the local considerations.

**For carbon black plants in the EU-25 based on the furnace process, the following are BAT:**

1. Use low sulphur feedstock – see Sections 4.2.2, 4.3.2.7, 4.4.2, and 4.4.6.  
The use of low sulphur primary feedstock with a sulphur content in the range of 0.5 - 1.5 % as a yearly average.

The corresponding BAT specific emission level is 10 – 50 kg SO<sub>x</sub> (as SO<sub>2</sub>) per tonne of rubber grade carbon black produced, as a yearly average. These levels are achieved assuming that the secondary feedstock is natural gas. Other liquid or gaseous hydrocarbons can be used as well.

In the production of speciality grade carbon black (high surface pigment blacks), higher emission levels are expected.

2. Preheat air required in the process to save energy – see Section 4.2.3.1 and 4.3.5.  
Ensure that air required in the process is preheated in heat exchangers by the hot gases (containing carbon black) leaving the furnace black reactor.
3. Maintain optimum operational parameters in the carbon black collecting system – see Sections 4.2.3.1 and 4.4.7.  
Maintain optimum operation of a high performance bag filter to ensure high carbon black collection efficiency and minimum product losses of the residual carbon black in the filtered tail-gas.

- Utilise the energy content of the tail-gas– see Sections 4.3.2.1, 4.3.2.2, 4.3.5 and 4.4.3. For new plants, this aspect should be considered prior to the selection of the location for the carbon black plant, as this gives the highest potential for energy recovery. Possible marketable products are power, steam, hot water and the tail-gas itself.

The combustion of the remaining tail-gas without energy recovery, as is the case in a flare, can only be considered when all the possibilities of economically viable recovery of energy are exhausted – see Sections 4.3.2.1, 4.3.2.2, 4.3.2.3, 4.3.2.7, 4.3.5 and 4.4.3.

- Apply primary deNO<sub>x</sub> techniques to reduce the NO<sub>x</sub> content in flue-gas originating from tail-gas combustion in energy producing systems – see Sections 4.3.2 and 4.4.1. Refer also to Sections 4.4.3, 4.4.4 and 4.4.5.

New plants. The emission levels associated with BAT are <0.6 g NO<sub>x</sub>/Nm<sup>3</sup> as an hourly average at 3 % O<sub>2</sub> during normal production. Higher NO<sub>x</sub> emissions can be expected during carbon black grade changes.

Existing plants. The associated emission levels are in the range of 0.6 – 1.0 g NO<sub>x</sub>/Nm<sup>3</sup> as an hourly average at 3 % O<sub>2</sub> during normal production. Higher NO<sub>x</sub> emissions can be expected during carbon black grade changes.

The NO<sub>x</sub> emissions from flares should be kept as low as possible by proper design and operation – see Sections 4.3.2.1, 4.3.2.2, 4.3.2.3, 4.3.2.7 and 4.4.3.

- Apply fabric filters for the air conveying system, vent collection system and dryer purge gas – see Sections 4.3.2.7 and 4.4.7.

For the low temperature air conveying and vent collector systems, associated emission levels are 10 to 30 mg/Nm<sup>3</sup> as a half-hour average. For the dryer purge filter, associated emission levels are <20 to 30 mg/Nm<sup>3</sup> as a half-hour average. The emissions are not related to a specific oxygen content.

It should be noted, for all filters, that the lower level of the emission range is more difficult to achieve consistently when finer grades of carbon black are dealt with.

- Recycle off-spec carbon black back into the process – see Section 4.4.7. Off-spec carbon black can be recycled back into the process to a certain extent. This can be done by admixing small quantities of off-spec carbon black with regular carbon black. Product specifications finally determine the total amount of off-spec carbon black that can be reprocessed.
- Water recycling – see Sections 4.3.3 and 4.3.3.3. Investigate the possibility of recycling rinsing water and, if possible, storm-water in the process, if it does not affect product quality. The collected rinsing water and (part of) the storm-water can be used after filtration as a source of process water.



## 5 SYNTHETIC AMORPHOUS SILICA

### 5.1 General information

#### 5.1.1 Introduction

Synthetic amorphous silica and silicates (for information on sodium silicate refer to Section 7.8) are used in a wide range of industrial applications. Due to their physico-chemical properties, they are employed in synthetic resins, plastics, rubbers, cosmetics, nutritional products and drugs, for example as fillers or anti-caking agents.

Synthetic amorphous silica and silicates are produced either by a wet process – precipitation of a water glass solution with acids (precipitated silicas, silica gels, silicates) – or by high temperature hydrolysis of chlorosilanes (pyrogenic silicas).

#### 5.1.2 Overview of the types of silica

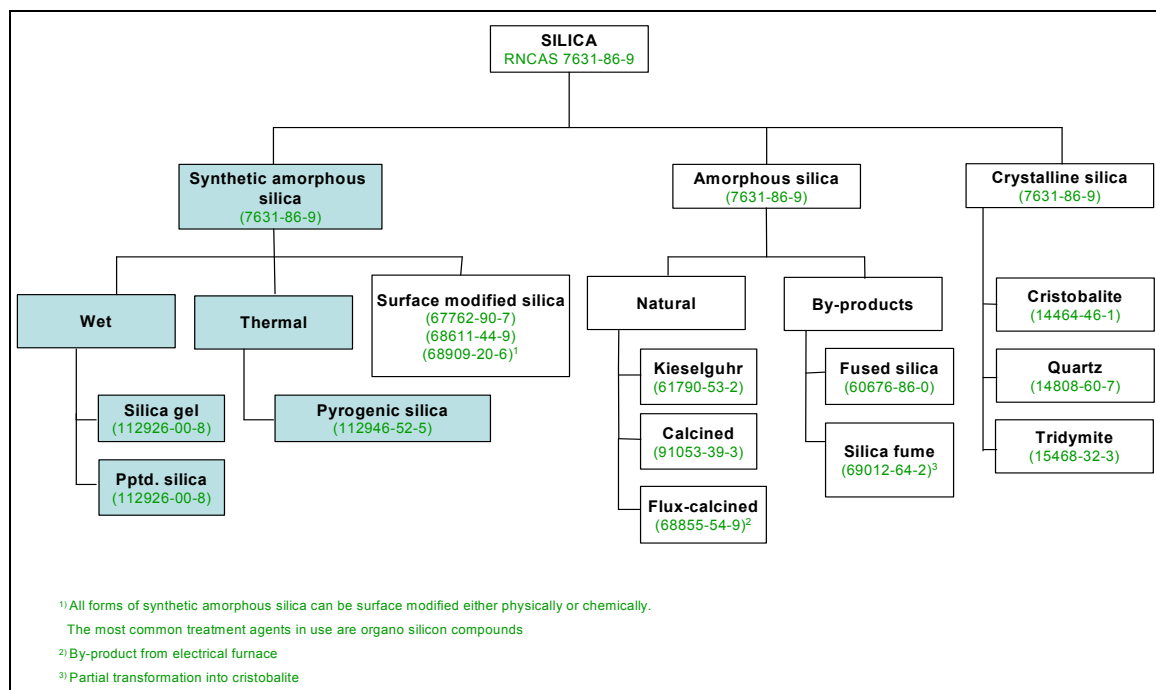
Synthetic amorphous silica is a highly pure, crystalline-free, silicon dioxide, which may be produced as pyrogenic silica, precipitated silica and silica gels. All products appear as a fluffy white powder, however, the process technologies used for the manufacture of these product types are different. Typically, these are the ‘wet-route’ processes (yielding precipitated silica and silica gel) and the thermal route (producing pyrogenic silica). Silica may sometimes be surface-treated to render it hydrophobic, but these specialised products are manufactured at relatively low tonnage levels compared to the untreated material.

An additional form of amorphous silica can be found in silica sols. The most common production process is based on an ion-exchange process with resins, using diluted sodium silicate solution as a feedstock.

Silica sols consist of discrete silica particles (typically 3 - 100 nm) stabilised in a solution (normally water). They may be prepared *in situ* by liberating silica particles for condensation (usually from sodium silicate or via hydrolysis of silica tetrachloride) or by the re-dispersion of existing silica. In this case, mainly silica gels and precipitates are employed by applying very large shearing forces to promote dispersion. Products need to be stabilised to maintain the sol particles in suspension and to protect them from freezing.

Silica, independent of its form and method of preparation (including by-products), is found under registry RNCAS 7631-86-9. However, as the different polymorphs of silica differ in their hazards to human health, it is essential to distinguish carefully between crystalline silica and crystalline-free or amorphous silica. The situation can be complicated as natural forms of amorphous silica, unlike synthetic versions, often contain crystalline impurities (up to 65 % cristobalite in the case of calcination).

An overview of silica types is shown in Figure 5.1.



**Figure 5.1: Silica polymorphs**  
[49, CEFIC-ASASP, 2002]

### 5.1.3 Product identity

Silica, independent of its form and method of preparation (including by-products), is found under registry RNCAS 7631-86-9. Key information on different forms of the silicon dioxide products embrace:

Name: Synthetic amorphous pyrogenic silica  
Trade names: e.g. Aerosil, Cab-O-Sil, HDK, Rheosil  
CAS registry No: 112945-52-5; (old: 7631-86-9)

Name: Synthetic amorphous precipitated silica  
Trade names: e.g. Ultrasil, Sident, Neosyl, Tixosil, Hi-Sil, Perkasil  
CAS registry No: 112926-00-8; (old: 7631-86-9)

Name: Synthetic amorphous silica gel  
Trade names: e.g. Syloid, Sylobloc, Gasil, Lucilite  
CAS registry No: 112926-00-8; (old: 7631-86-9)

General data for Pyrogenic Silica, Precipitated Silica and Silica Gel

EEC No: none  
EEC classification: no classification required (not a hazardous substance)  
EEC labelling: no labelling required (not a hazardous substance)  
EINECS No: 231-545-4  
molecular mass: 60.08  
structural formula:  $\text{SiO}_2$

## 5.1.4 Physical and chemical properties

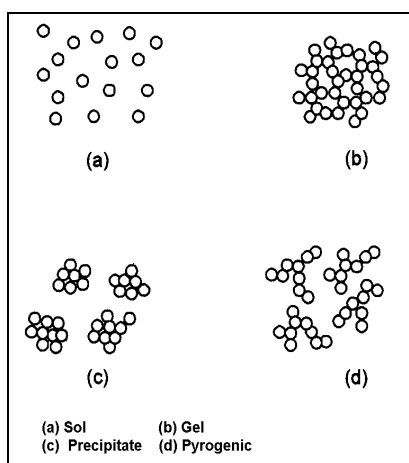
### 5.1.4.1 Physical properties

#### Morphology

Particle size according to DIN 53206 distinguishes three levels: primary particles, aggregates and agglomerates. Primary particles are recognisable as individual particles with suitable physical analytical methods. Electron micrographs show that primary particles of precipitated silica are almost spherical in which the diameter is of the order 2 – 20 nm. Aggregates are assemblies of primary particles which are grown together in the form of chains or clusters. The degree of aggregation defines the ‘structure’ of the silica as aggregates cannot be broken into primary particles by any dispersion process. Agglomerates are loose assemblies of aggregates, held together by van der Waals forces. Agglomerates can be broken into aggregates by optimal dispersion techniques.

By varying process parameters during precipitation and milling, the mean particle size, the particle size distribution and the degree of aggregation can be varied in relatively broad ranges. In essence, the smallest particles in precipitated silica are the aggregates, and not the primary particles.

Figure 5.2 shows the difference between aggregate structures of silica manufactured by different process routes.



**Figure 5.2: Different forms of commercially important synthetic amorphous silicas [49, CEFIC-ASASP, 2002]**

#### Specific surface area

The specific surface area of industrial precipitated silica varies widely from 30 up to 900 m<sup>2</sup>/g. Commercial gel products can be found in the same surface area range.

#### Structure

The structure of precipitated silica is usually characterised by a specialistic absorption method reflecting primary particle size and shape as well as aggregate size and shape. Common values are in the range between 50 and 350 g oil/100g powder. For gel products, the structure is defined by the pore volume and the pore size distribution. The pore volume of typical gel products ranges from 0.3 to 2.0 ml/g, whilst average pore diameters range from <2 to 30 nm, although special products may have pore diameters up to 400 nm.

#### Drying loss

Precipitation products contain between 2 – 10 wt-% of physically bonded water.

#### Ignition loss

Common values for the ignition loss are in a range of 2 to 10 wt-%.

**Tapped density**

Common values are in a range of 50 g/l for the milled product and up to 600 g/l for granulated or very dense material.

**5.1.4.2 Chemical properties****Chemical analysis**

Besides SiO<sub>2</sub> as the main component of industrially produced precipitated silica, traces of other metal oxides like Na<sub>2</sub>O and as well as sulphates and chlorides can be determined. The SiO<sub>2</sub> content is determined gravimetrically by fuming off with hydrofluoric acid. The analysis for metal oxides is then normally performed by means of atomic absorption spectroscopy of the residue remaining from the fuming off process. Sulphate and chloride contents are determined by potentiometric titration. Typical values obtained by analysis are given in Table 5.1 (pyrogenic silica) and Table 5.2 (precipitated silica and silica gel).

After drying, pyrogenic silica typically contains at least 99.8 % SiO<sub>2</sub>, with alkali and heavy metals in the low ppm range. Suitable cleaning steps in the production process typically reduce the content of the by-product hydrochloric acid to less than 250 ppm.

Parameter	wt-%
SiO <sub>2</sub>	>99.8
Al <sub>2</sub> O <sub>3</sub>	<0.05
Fe <sub>2</sub> O <sub>3</sub>	<0.003
HCl	<0.025
TiO <sub>2</sub>	<0.03
Na <sub>2</sub> O	<0.0009

**Table 5.1: Composition of typical synthetic amorphous pyrogenic silica [49, CEFIC-ASASP, 2002]**

After drying, precipitated silica and silica gel typically contain at least 95 % SiO<sub>2</sub> and are solid, amorphous forms of hydrous silicon dioxide distinguished by their microporosity and hydroxylated surfaces.

Parameter	wt. %
SiO <sub>2</sub>	>95
Na <sub>2</sub> O	0.2 – 2.4
Sulphates as SO <sub>3</sub>	0.2 – 3.0
Fe <sub>2</sub> O <sub>3</sub>	<0.05
Trace oxides	<0.07

**Table 5.2: Composition of typical synthetic amorphous precipitated silica/silica gel [49, CEFIC-ASASP, 2002]**

**5.1.5 Production amounts**

The worldwide production of pyrogenic silica was estimated at around 100 kt in 1992. Most of this output is produced in Western Europe, North America and Japan; other origins (Ukraine, India) contribute less than 5000 tonnes. Precipitated silicas have only been produced since the 1950s but they have grown to become the most important group of silica products on the basis of production tonnage. Worldwide, the production capacity for precipitated silica in 1999 was approx. 1100 kt, compared to approx. 400 kt in 1970. Production capacities for silica gels (in 1990) are estimated to be around 90 kt per year on a global basis (however excluding China, the CIS and Eastern Europe).

Production volumes of synthetic amorphous silica in Europe for the year 2000 are shown below [49, CEFIC-ASASP, 2002]:

Product group	Production (tonnes)
Pyrogenic silica	72000
Precipitated silicas	285500
Silica gels	34600

**Table 5.3: Production amounts of synthetic amorphous silica in the year 2000**  
[49, CEFIC-ASASP, 2002]

As given in Table 5.4, synthetic amorphous silica is produced in the following locations in the European Union (EU-15):

Location	Product group
Rheinfelden, Germany	pyrogenic silica
Barry, UK	pyrogenic silica
Antwerpen, Belgium	pyrogenic silica
Rheinfelden, Germany	pyrogenic silica
Wesseling, Germany	precipitated silica
Bonn-Beuel, Germany	precipitated silica
Zubillaga-Lantaron, Spain	precipitated silica
Worms, Germany	silica gel
Duren, Germany	precipitated silica
Hamina, Finland	precipitated silica
Ostende, Belgium	precipitated silica
Uddevalla, Sweden	precipitated silica
Warrington, UK	precipitated silica and silica gel
Delfzijl, the Netherlands	precipitated silica
Collonges au mont d'or, France	precipitated silica
Burghausen, Germany	pyrogenic silica
Nunchritz, Germany	pyrogenic silica

**Table 5.4: Locations of European producers of synthetic amorphous silica by product groups**  
[49, CEFIC-ASASP, 2002]

### 5.1.6 Product applications

Synthetic amorphous silica was commercialised some 50 years ago and is currently used in a wide variety of industrial applications. This summary covers the most important applications for these versatile products.

#### Consumer use products

Due to their inert nature synthetic amorphous silica is used in cosmetics, pharmaceuticals and foods. Synthetic amorphous silicas for pharmaceutical use meet the requirements of international pharmacopoeias. Food additive grades of synthetic amorphous silica meet the requirements of the Joint Expert Committee on Food Additives of WHO/FAO. Amorphous silica is registered in the EU as Hydrated Silica E551 ('E551a' for precipitated amorphous silica and silica gel, 'E551b' for pyrogenic amorphous silica).

#### Animal feed

Many feed additives are added in minute quantities in the form of vitamins and mineral premixes. These premixes are manufactured using synthetic amorphous silica as carriers and anti-caking agents.

#### Rubber and silicones

Synthetic amorphous silica is used as a reinforcing filler for many non-staining and coloured rubber and silicone products. Typical applications are footwear, conveyor belts, mats, seals, etc. A new application for synthetic amorphous silica is in energy conserving automobile tyres (green tyres) where the silica reduces the rolling resistance of the tyre.

#### Paints

Synthetic amorphous silicas are used as functional pigments in emulsion paints.



### Lacquers

The most commonly used flattening agents in lacquers are synthetic amorphous silicas.

### Plastics

Synthetic amorphous silica is used as an anti-blocking agent in plastic films and in polyester and epoxy resins for thixotropy control providing improved handling properties for these materials. Precipitated silica is used for polyethylene battery separators.

### Paper

Small amounts of synthetic amorphous silica added to paper improve its printability and opacity. This makes it possible to produce lower grammage paper grades with savings in wood resources. Synthetic amorphous silica is also used in specially coated paper grades for inkjet printing, copying, etc.

Figure 5.3 presents the West European consumption of synthetic amorphous pyrogenic silica.

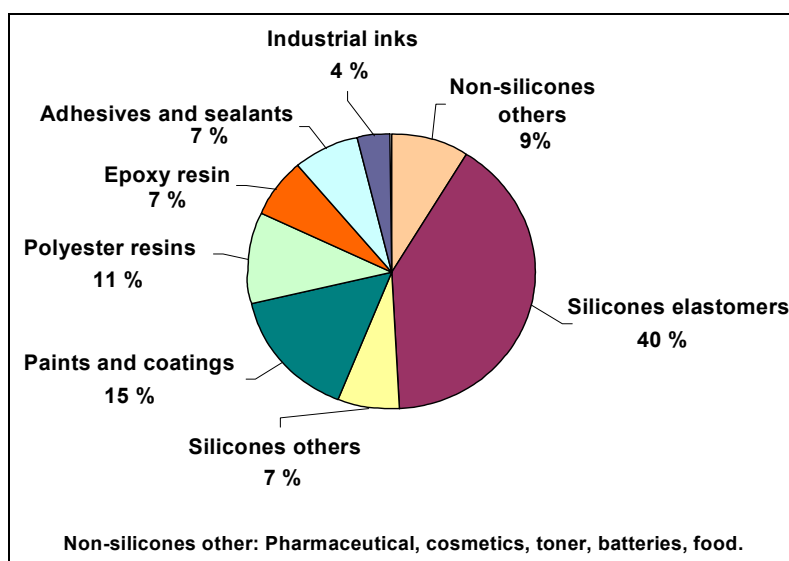


Figure 5.3: West European consumption of synthetic amorphous pyrogenic silica [49, CEFIC-ASASP, 2002]

West European consumption of synthetic amorphous precipitated silica is given in Figure 5.4.

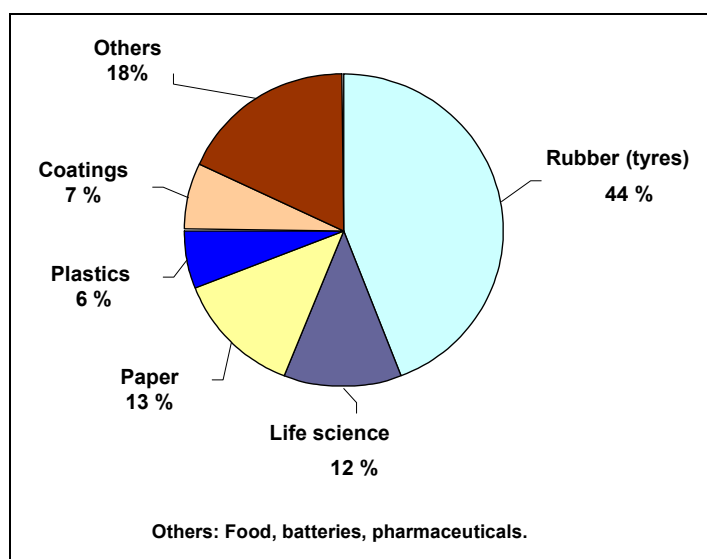


Figure 5.4: West European consumption of synthetic amorphous precipitated silica [49, CEFIC-ASASP, 2002]

West European consumption of synthetic amorphous silica gel is given in Figure 5.5.

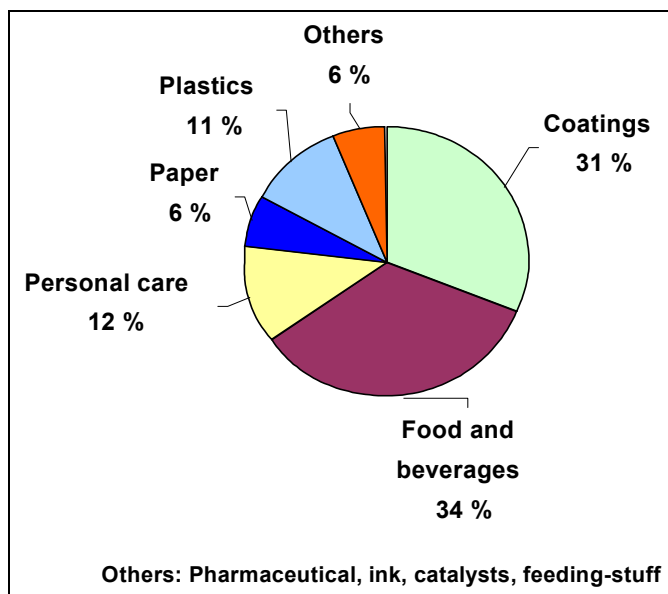


Figure 5.5: West European consumption of synthetic amorphous silica gel [49, CEFIC-ASASP, 2002]

## 5.2 Applied processes and techniques

Due to the different production routes of synthetic amorphous silica, this section is structured as follows: Section 5.2.1 describes the production of pyrogenic silica whereas Section 5.2.2 deals with precipitated silica and silica gel.

### 5.2.1 Synthetic amorphous pyrogenic silica

#### 5.2.1.1 Basic principles of pyrogenic silica particle formation

Volatile chlorosilanes and/or methylchlorosilanes are fed into a reactor together with a mixture of hydrogen and air. A reaction takes place at temperatures between 1200 – 1600 °C and hydrolysis of the silanes leads to SiO<sub>2</sub> molecules. Nucleation, condensation and coagulation leads from molecules to proto-particles of SiO<sub>2</sub> which combine to form primary particles of SiO<sub>2</sub>. Primary particles, under the conditions of the reaction zone stick together building stable SiO<sub>2</sub> aggregates. Primary particles do not exist outside the reaction zone. Aggregates subsequently form agglomerates of SiO<sub>2</sub>. The principles of pyrogenic silica particle formation are illustrated in Figure 5.6.

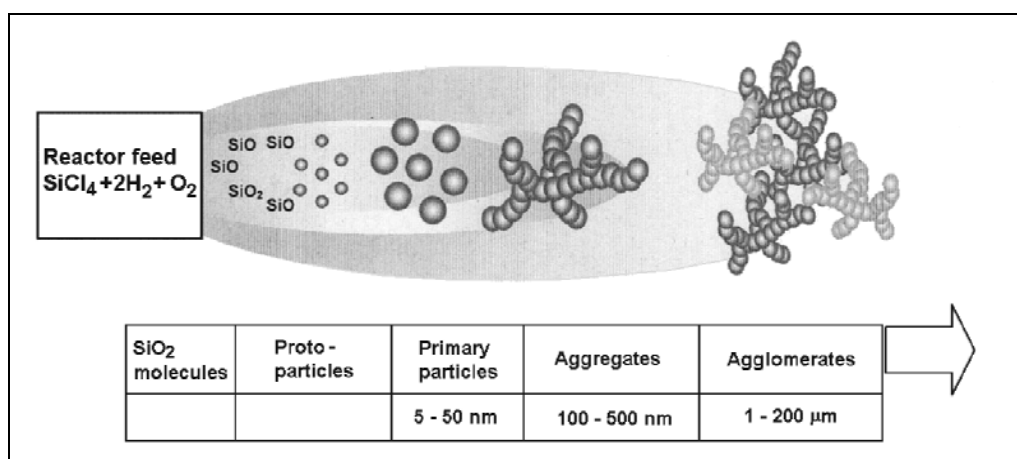


Figure 5.6: Synthetic amorphous pyrogenic silica particle formation [49, CEFIC-ASASP, 2002]

#### 5.2.1.2 Raw materials

The feed for pyrogenic silica production are chlorosilanes (e.g. SiCl<sub>4</sub>, HSiCl<sub>3</sub>) and/or alkylchlorosilanes (e.g. methylchlorosilane CH<sub>3</sub>SiCl<sub>3</sub>). The chlorosilane feed is either produced directly for the synthesis of pyrogenic silica or is a by-product from other manufacturing processes (e.g. the production of pure silicon for the semiconductor industry). Alkylchlorosilanes are by-products from the silicone rubber industry.

Routes to raw materials used in the production of pyrogenic silica are illustrated in Figure 5.7.

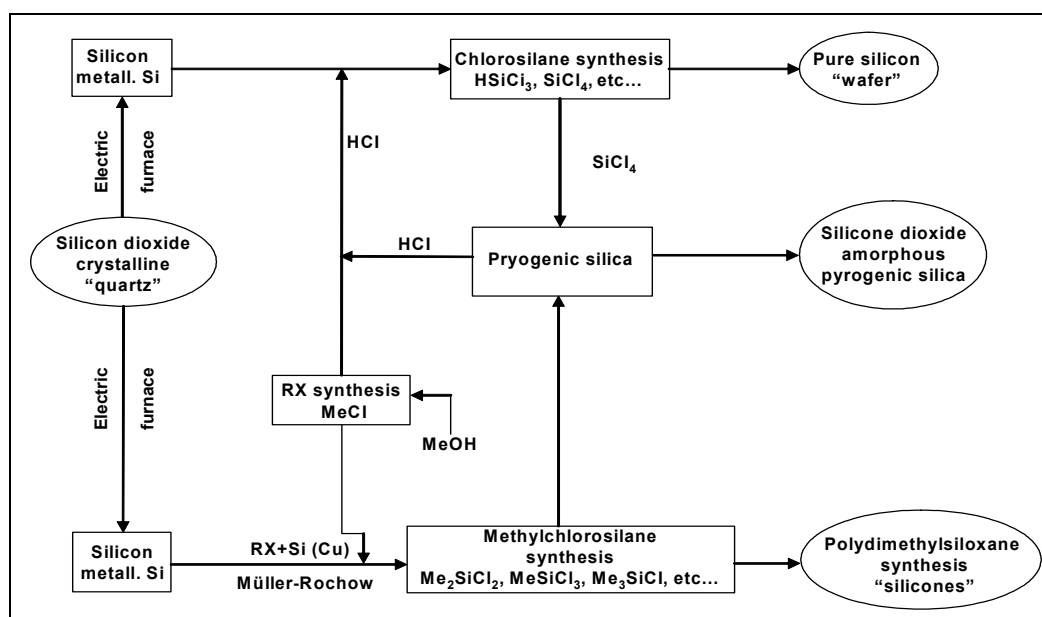


Figure 5.7: Routes to raw materials used in the production of pyrogenic silica [49, CEFIC-ASASP, 2002]

### 5.2.1.3 Process description

A plant for the production of synthetic amorphous pyrogenic silica consists of several units, as outlined in Figure 5.8.

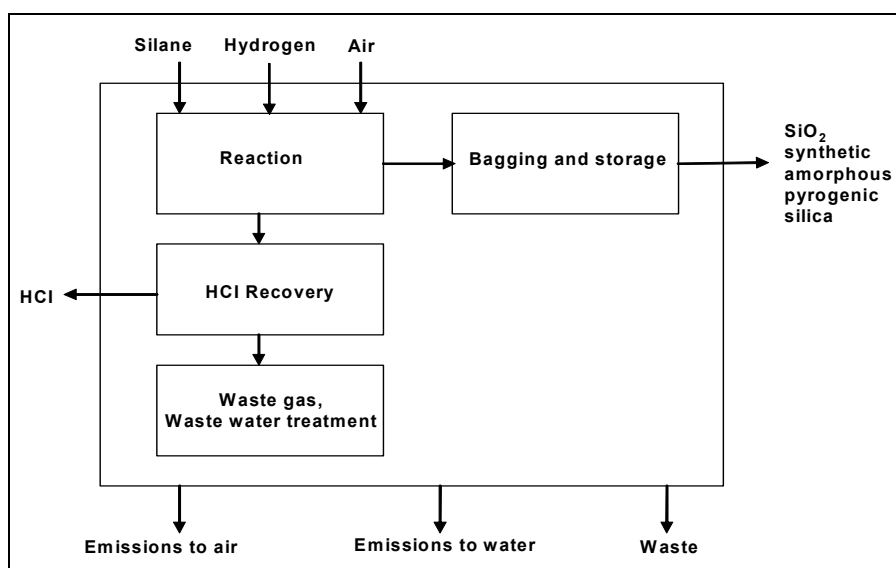
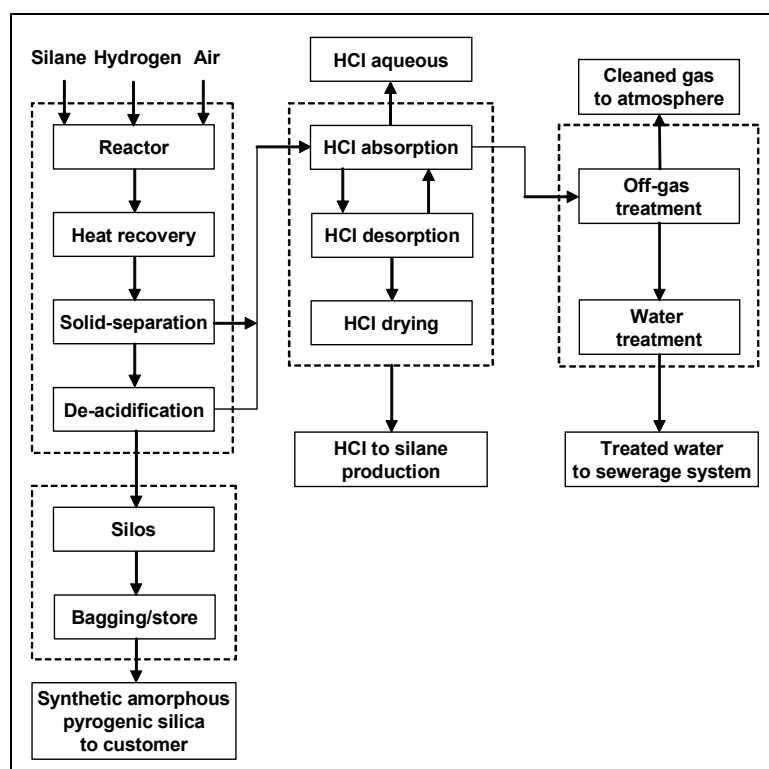


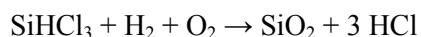
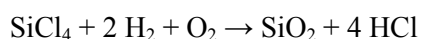
Figure 5.8: Main units of a synthetic amorphous pyrogenic silica plant [49, CEFIC-ASASP, 2002]

In order to track specific consumption and emission levels from the process, Figure 5.9 gives a process flow diagram of a synthetic amorphous pyrogenic silica plant at a sub-unit level.

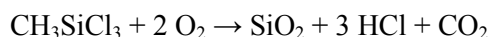


**Figure 5.9: Process flow diagram of a synthetic amorphous pyrogenic silica at a sub-unit level [49, CEFIC-ASASP, 2002]**

The manufacture of pyrogenic silica uses: hydrogen, air and various blends of chlorinated silanes as feedstock. The most common chlorinated feedstocks are silicon tetrachloride ( $\text{SiCl}_4$ ), trichlorosilane ( $\text{SiHCl}_3$ ) and methyltrichlorosilane ( $\text{SiCH}_3\text{Cl}_3$ ).



It is also possible to use methyltrichlorosilane alone or mixed with silicon tetrachloride as the raw material. In this case, the following reaction takes place:



The raw materials: silane, hydrogen and air react in a flame zone of the reactor to yield silica. The gases leaving the reactor are cooled down with all of the silica in the form of an aerosol. The silica is then separated from the hydrochloric acid containing off-gas. Remaining hydrochloride adsorbed onto the surface of the pyrogenic silica is removed in a subsequent step. The silica is transported pneumatically to storage silos and subsequently placed into bags or transported to consumers in bulk by road or rail.

Hydrogen chloride is washed out of the off-gas by absorption to give hydrochloric acid in commercial concentrations (e.g. it can be re-used by reacting it with metallurgical silicon to produce chlorosilanes, such as silicon tetrachloride, and hydrogen).

Chlorine is also a by-product and it is washed out of the off-gas (after absorption of hydrogen chloride) with caustic soda to yield sodium hypochlorite solution. This, in turn, is converted to sodium chloride solution via waste water treatment.

The properties of pyrogenic silica products can be controlled by varying process parameters, such as feedstock, flame composition and flame temperature.

## 5.2.2 Synthetic amorphous precipitated silica and silica gel

The production processes of silica gels as well as precipitated silica can be divided into the following unit operations: raw material storage, synthesis, washing (solid-liquid filtration), drying, packing and storage. Optionally, after the drying step, the product can be milled, granulated or surface treated to promote hydrophobicity. These individual steps are carried out in a continuous or batch process manner.

### 5.2.2.1 Raw materials

Raw materials for the production of precipitated silica and silica gels are aqueous alkali metal silicate solutions (e.g. water glass) and acids, generally sulphuric acid. Precipitation with hydrochloric acid, organohalosilanes, carbon dioxide or combinations of the latter with mineral acids are also undertaken but these are of minor economic importance.

#### 5.2.2.1.1 Water glass

Water glass ( $\text{Na}_2\text{O}_n \text{SiO}_2$ ;  $n = 2$  to  $4$ ) is an aqueous sodium silicate solution (refer to the BREF on the Glass Manufacturing Industry, and to Section 7.8). Industrial production is carried out in two steps. In the first step, water glass cullets are produced from sand and soda ash by melting both components at about  $1300\text{ }^\circ\text{C}$  in a glass furnace. In the second step, these cullets are then dissolved in an autoclave with water, producing water glass. Water glass is a colourless, odourless, non-flammable but strongly alkaline liquid (approx. pH 11). It is characterised by its molar ratio ( $\text{SiO}_2 : \text{Na}_2\text{O}$ ) and its solids content.

#### 5.2.2.1.2 Sulphuric acid

Sulphuric acid ( $\text{H}_2\text{SO}_4$ ) is a colourless, odourless, non-flammable but strongly acidic liquid which is characterised by its concentration (refer to the BREF on LVIC-AAF).

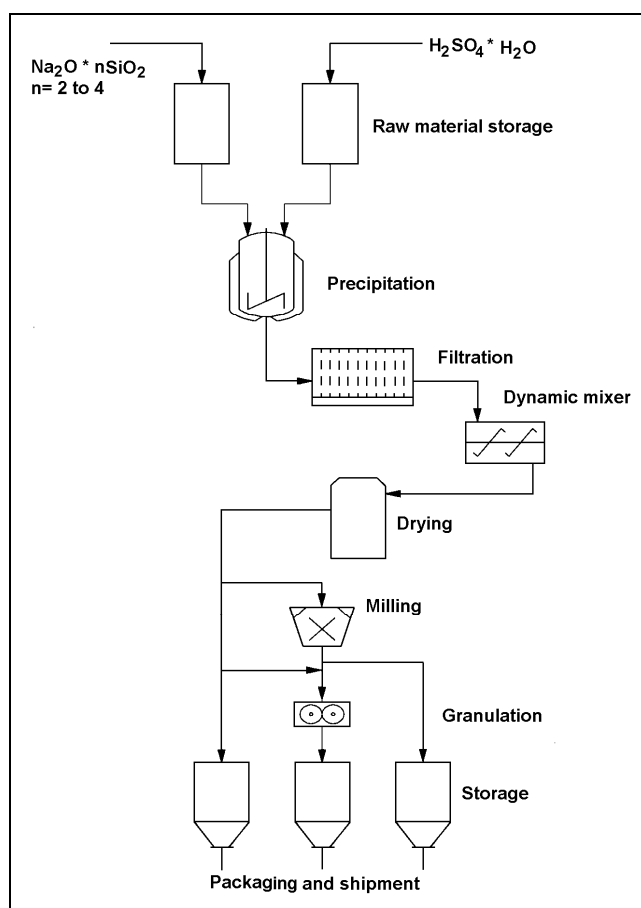
#### 5.2.2.1.3 Raw material storage

Water glass solution is normally stored in closed carbon steel or fibre reinforced plastic tanks, although sometimes other tanks are also used. Tanks with volumes of up to  $1000\text{ m}^3$  are commonly used. Due to a reaction with water glass, aluminium, zinc, zinc coated steel and glass are not suitable materials for tanks. To prevent the water glass from freezing during wintertime, it is preferable to have tanks installed under the roof inside the production units. If tanks are outside however, they should be insulated and heated. Local hot spots should be prevented to avoid building up a precipitation of solid silica.

Sulphuric acid should be stored in closed steel tanks with humidity protection. Storage capacities of several  $100\text{ m}^3$  are generally used in the production process.

### 5.2.2.2 Production process – precipitated silica

The silica production process can be divided into the following batch or continuous unit processes and operations: Raw material storage, synthesis (precipitation), solid-liquid filtration, drying, storage, packaging and shipment. Optionally, the product can be milled, granulated or surface treated after the drying step. An illustration of the production process is shown in Figure 5.10.

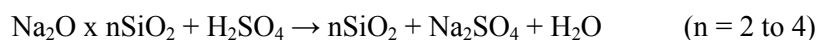


**Figure 5.10: Flow sheet for the production process of precipitated silica [49, CEFIC-ASASP, 2002]**

Note: this process may also be applied for the production of metal silicates such as calcium, magnesium or aluminium silicate, whereby the acid for precipitation is replaced by solutions of metal salts.

#### 5.2.2.2.1 Precipitation process

In the reaction of alkali metal silicate solutions, (e.g. water glass) with mineral acid (e.g. sulphuric acid), the silica precipitates according to the following equation:



In contrast to silica gels, which are produced under acidic conditions, in this case precipitation is carried out in neutral or alkaline media. The properties of the precipitated silica can be influenced by the design of the reactor and by varying the process parameters.

Depending on the intended application of the silica, individual precipitation parameters such as temperature (40 – 95 °C), pH (4.5 – 12.5), flows, residence time (up to several hours), mixing energy, reactor geometry, etc. have to be selected. By regulating these parameters, a wide range of silica products with different characteristics can be produced. The solids content of this step is typically characterised by a density of between 50 and 200 g/l.

To date, only batch precipitation processes in stirred vessels have attained economic importance, although continuous precipitation techniques have been reported.

#### 5.2.2.2 Filtration process

The suspension received from the precipitation step is filtered. For this purpose, usual filter presses, membrane filter presses or belt/drum filters are used. In comparison to filter presses which operate in a batch cycle, drum and belt filters work in a continuous manner. Equipment selection is dependent upon the properties and structure of the silica produced. The solid content of the filter cake typically varies between 15 to 25 wt-%, depending on the filtration technique employed. After filtration, a washing step follows to remove salts (normally done in the filtration section). The level of salt retained in the product depends on the intended application of the final silica.

#### 5.2.2.3 Filter cake treatment

In some cases, in order to achieve certain product properties, the filter cake is re-suspended using high shear filters and then sent to the drying process.

#### 5.2.2.4 Drying process

Drying follows filtering and washing the silica suspension derived from the precipitation process. Since the solid content of the filtered product is in the range of only 15 – 25 wt-% about 400 to 600 kg of water has to be evaporated for each 100 kg of final product. Therefore, the cost of drying represents a considerable proportion of the total silica production costs. Drying is performed according to different processes depending on the characteristics required for the final product. In industrial scale operations belt dryers, turbine dryers, recycling dryers, rotary drum dryers and spray dryers are used. This step allows finely divided, homogenous powder with excellent absorption and free flow properties to be produced.

#### 5.2.2.5 Milling process

After conventional drying, the product is an irregular granulate which has to be milled in jet mills or mechanical mills. This step requires air or steam and is energy intensive. During this process, the particle size distribution and sieve residue characteristics of the product are primarily modified.

#### 5.2.2.6 Granulation process

For certain applications, a dust-free product is required and to fulfil this requirement, the spray dried or milled product has to be granulated. Granulation is normally done with drum granulation equipment.

### 5.2.2.3 Production process – silica gel

As with precipitated silica, silica gels are produced by the neutralisation of aqueous alkali metal silicates with acids. On a commercial scale, the process comprises a raw material dilution section (optional), synthesis (sol formation/gelation), washing/ageing and drying, followed by sieving, milling, or surface modification depending on the required quality of the final product. Subsequent steps such as packaging, storage, and shipment are comparable to the procedures for precipitated silica. An illustration of the production process is shown in Figure 5.11.



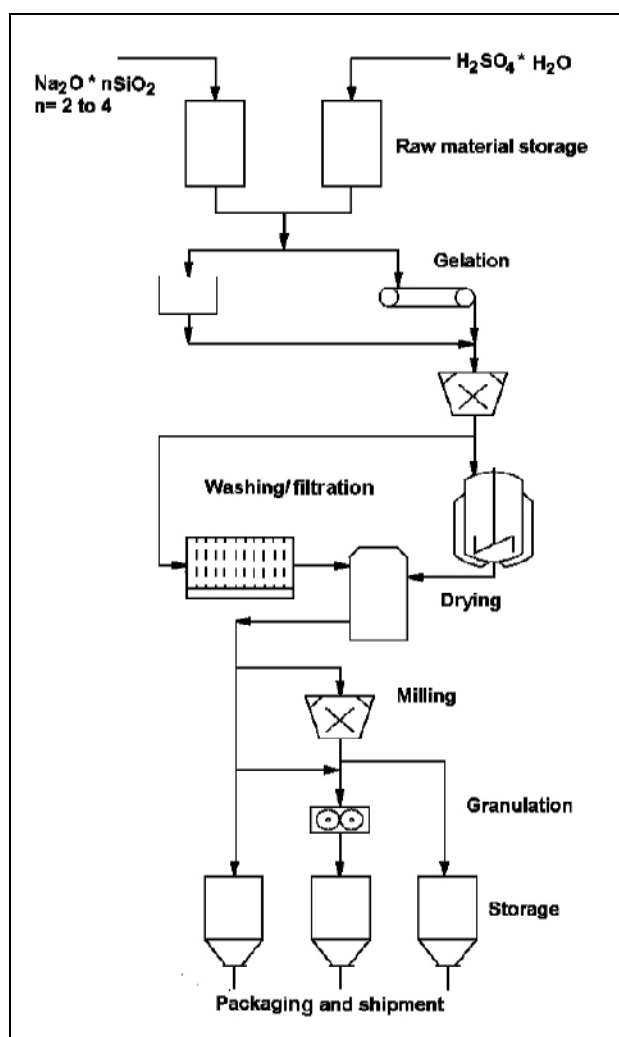


Figure 5.11: Flow sheet for the production process of silica gel [49, CEFIC-ASASP, 2002]

### 5.2.2.3.1 Synthesis

The first synthesis step comprises the formation of a hydrosol which is produced by the controlled mixing of water glass and diluted sulphuric acid. Occasionally, other acids may also be used.

The acidity (pH) and  $\text{SiO}_2$  content of this hydrosol are determined by the concentration of the raw materials and their mixing ratio. The hydrosol phase extends from the point of mixing the raw materials up to the onset of solidification which is characterised by a sudden increase in viscosity, an average molecular weight and a modulus of elasticity. During the sol forming step, an unstable intermediate, monomer orthosilicic acid, is formed which then rapidly undergoes an acid-catalysed condensation reaction to form oligomers. When the molecular weight reaches approx. 6000, a sudden increase of both the viscosity and the modulus of elasticity is observed. This increase marks the transformation of the sol to a gel, that will then further develop its internal structure. In the hydrogel state, larger agglomerates are generated which are cross-linked to form an open, branched-chain structure. Choice of the gelation conditions can define the particle size and form of the hydrogel; industrial processes normally form either lumps or spherical beads.

### 5.2.2.3.2 Washing/ageing

During the subsequent washing process, excess salts are removed in order to purify the gel but this also causes structural changes within the gel's framework. By an appropriate choice of the washing conditions (e.g. pH, temperature, time) different specific surface areas can be achieved for the purified hydrogel. Washing can be performed either in fixed beds or slurries, operating continuously or batch wise. The hydrogel formed has a continuous structure, giving a three-dimensional network of pores filled with water. The total volume of pores per mass-unit is called 'the pore volume' and is a specific characteristic of the gel type.

### 5.2.2.3.3 Drying

Although silica as a hydrogel can be used for a few applications, in most instances the gel must be dried. During the drying process, the surface tension of the solvent in the pores can shrink the hydrogel volume. In slow drying, as water is evaporated from a silica hydrogel, the structure collapses gradually due to the surface tension of the water. Eventually, a point is reached where, even though water is still evaporating, the gel structure no longer shrinks. At this point the gel is called a xerogel. Fast drying can minimise the shrinkage and removal of water by solvent exchange followed by drying has the same effect. Materials that are dried with negligible loss of pore volume are known as aerogels. Sub, or supercritical drying conditions can also be applied to maintain pore volume, but these techniques have no industrial relevance. Commercial hydrogel products typically exhibit a water content of between 50 and 70 %. Additionally, as the removal of water from pores will be diffusion controlled (hence requiring longer drying times or higher temperatures), this combines to generate a need for a very efficient but energy consuming drying method. As the choice of drying equipment will influence the pore volume of the xerogel, various drying techniques are applied on an industrial scale, e.g. tray dryers, belt dryers, recycling dryers, fixed bed dryers and flash dryers. Furthermore, silica suspensions can also be spray dried.

### 5.2.2.3.4 Post-drying

The xerogel can now be sieved, if coarse material is required as for adsorption applications, or milled for other applications. Depending on the required particle size and particle size distribution, silica gels are milled using jet mills or mechanical mills.

### 5.2.2.3.5 Storage

Silica gel should be stored in sealed containers to maintain product quality, particularly to avoid moisture adsorption or desorption.

## 5.2.2.4 Key process parameters – synthetic amorphous precipitated silica and silica gel

### 5.2.2.4.1 Wet stage process

The wet stage process is essentially a destabilisation of an aqueous solution of sodium silicate by the addition of sulphuric acid to yield synthetic silica. Depending on the order of addition, pH, temperature and concentrations, the resulting product is either a precipitated silica, a silica gel or a combination product. The silica gel or precipitated silica slurry is then washed and concentrated either in sequential or combined process units.

The main environmental impact from the wet stage process is the waste water generated. Waste water characteristics having potential environmental effects are:

- effluent volume
- suspended solids
- pH
- temperature
- sodium sulphate content.

Water usage and thus the amount of waste water generated, is to a large extent determined by the required product properties. The concentrations (dilution) of sodium silicate and sulphuric acid have to be accurately controlled to obtain the required silica product. The sodium sulphate by-product formed in the reaction is detrimental in most applications where silica is used and consequently has to be removed by washing.

Control procedures for the key environmental parameters are described below.

### **Effluent volume**

The effluent volume generated is dependent on the operation of the washing/concentration filters. Additionally, the type of silica being produced will influence the effluent volume generated. Product quality strongly depends on the washing steps to attain the purity of silica required. As an example, sodium sulphate content is a limiting factor for the use of silica in the food industry and, therefore,  $\text{Na}_2\text{SO}_4$  must be removed with high efficiency.

### **Suspended solids**

Proper operation and maintenance of the washing/concentration filters play an important role in the control of suspended solids in silica production effluents. When necessary, further reductions in effluent suspended solids can be obtained by applying standard effluent treatment technology: sedimentation, flocculation, filtering, etc.

### **Adjustment of pH**

The pH of the waste water generated in the silica wet process is dependent on the type of silica produced. Before effluent discharge into natural watercourses or the sea, the pH can be adjusted to the required level by acid/alkali addition.

### **Temperature**

The temperature of silica wet process effluents is high enough to be utilised in process water heating and is economically viable for heat recovery. To improve washing efficiency, wash-water can be heated by exhaust gas from the drying process. Higher filter cake temperatures can also save energy in the drying step.

### **Sodium sulphate**

The sodium sulphate concentration is generally too low for its recovery to be economically viable. Most recovery or minimisation techniques have problems as indicated in Section 5.4.2.1.

#### **5.2.2.4.2 Dry stage process**

Prior to drying, the silica slurry is concentrated by filtering. Washing and slurry concentration are often done in the same process unit, typically a filter press or a drum/disk filter. The slurry or filter cake from the wet process is dried, milled and packaged in separate dry stage operations. Silica slurry or filter cake is introduced into a dryer (spray, fluidised-bed, drum, etc.), where the water is evaporated to yield an essentially dry silica product.

The amount of water to be evaporated per tonne of dry silica product depends on:

- silica type (absorptiveness)
- liquid/solid separation
- drying technology.

The drying step is followed by other process operations such as:

- milling and/or granulation
- packaging.

### **Silica type**

Silica type (mainly the absorptiveness of the silica) is the most important factor affecting emissions from the drying process. The amount of water to be evaporated can be as high as 4 - 6 tonnes per tonne of silica product. It should be noted that the structure of various silica product types is a product-specific property and cannot be changed without impairing product functionality.

### **Liquid/solid separation**

The concentration filter in the wet process is used to dewater the silica slurry to reduce the amount of water that has to be evaporated to yield a dry product. Different types of filters will be more or less effective in their dewatering efficiency. Pressure filters generally result in lower filter cake water levels than vacuum filters. In view of this, filter selection is directly linked to the energy consumption at the drying stage. Filter type and dryer type selection is linked together in as much as some dryers can only take slurry feed whilst other types work better with filter cake. Dryers using filter cake feed can take advantage of the lower filter cake water levels that can be obtained with pressure filters. Filter operation has to be optimised for each silica product to yield the lowest possible filter cake water level. Maintenance of the filtration media is another key element in maintaining optimum performance of the filtration unit.

### **Drying technology**

Dryers can be either slurry fed or filter cake fed, as described above. Modern drying equipment operated correctly and using high inlet temperatures will give a high level of thermal efficiency. Some silica products, however, are formed in the drying process to yield a controlled particle size distribution and this may have an effect on overall thermal efficiency. In general terms, the drying step is a very mature process and process economy drivers automatically lead to reduced emissions along with optimal drying costs. Emission volumes and CO<sub>2</sub> levels are strongly influenced by the type of dryer and its operation. For particulates, dryers are always equipped with dust collection equipment, typically bag houses. Other control techniques include venturi scrubbers and cyclones followed by a scrubber or a bag house filter. The disadvantage of the use of scrubber systems is the generation of contaminated waste water which may then itself require treatment. For air emissions with a high moisture content, venturi scrubbers are the only efficient cleaning solution.

### **Milling and/or granulation**

Mills and granulators are used to control the particle size of the finished silica product. Mills are used for the reduction of particle size and are typically variations of hammer mills or jet mills. These units are major energy consumers in a silica plant. Granulators are used to increase the particle size of silica mainly for improved handling and to reduce dusting. Input and output to mills and granulators are often handled by airway systems equipped with bag houses for product recovery and dust extraction.

### **Packaging**

Packaging is typically performed using automatic or manual machines filling paper or plastic bags of 5 – 25 kg, big bags of 100 – 1000 kg or silo containers depending on customer needs. These bagging machines are always equipped with their own dust extraction and control systems to minimise the emission of particulates but, nevertheless, well ventilated and contained packaging areas are also recommended.

### 5.2.3 Handling and transportation of synthetic amorphous silica

The final product is pneumatically conveyed to a silo where it is stored and then shipped in bulk or bagged. Conveyance requires air but the required volumes vary depending on the product being handled. Depending on the case, a dense or diluted phase conveying system is best with respect to quality and investment/operating costs. The less air that is needed for transport, the smaller the area of the individual silo filters can be.

Silo filters can be candle jet filters or bag filters and both reduce the overall emission of dust. In addition to the air used for transportation, air is also used in silos to re-fluidise the powder after a long storage period. For transportation and storage, metal pipes and silos are the industry standard.

The bagging of silica in multilayer paper bags or plastic bags is done by using standard powder packing machines such as: turbine packers, air packers, vacuum packers, screw packers, etc. with appropriate equipment to minimise worker exposure. In addition to sacks, the product is also bagged in bulk containers (e.g. big bags) or shipped in rail cars or trucks. Synthetic amorphous silica is commonly transported by road, rail and sea in bags, big bags, bulk containers and silo road tankers. Standard shipping units are bags on pallets; to limit water uptake the pallets are shrink-wrapped, e.g. in PE foil. Based on international regulations, synthetic amorphous silica is not classified as a hazardous material.

### 5.2.4 Process and product trends

On an industrial scale, synthetic amorphous silica is rendered hydrophobic by surface modification with Si-organic compounds. Surface modified synthetic amorphous silica can be obtained either by physical or chemical treatment. Methods for chemical modifications of the silica particle surface, i.e. silylation are both numerous and varied. The most common treatment agents are organosilicone compounds like dimethyldichlorosilane, hexamethyldisilazane and polydimethylsiloxane fluids.

## 5.3 Present consumption and emission levels

### 5.3.1 Synthetic amorphous pyrogenic silica

The scope for this section is related to Figure 5.8, where the main units of the production process are presented.

#### 5.3.1.1 Consumption of raw materials and energy

##### 5.3.1.1.1 Raw materials

Silanes, hydrogen and air are required for the production of pyrogenic silica. Typical figures for raw materials used are as shown in Table 5.5:

Raw materials	Demand per tonne of silica
Silane	2500 – 2900 kg
Hydrogen	~ 1000 Nm <sup>3</sup>

**Table 5.5: Consumption of raw materials – synthetic amorphous pyrogenic silica [49, CEFIC-ASASP, 2002]**

##### 5.3.1.1.2 Consumption of energy

Energy is consumed for heating hydrogen gas and combustion air, for the evaporation of chlorosilanes (and/or methylchlorosilanes), as well as for removing residual hydrochloride from the silica surface. In the energy consumption figure given in Table 5.6 below, the energy for HCl recovery is also included.

Energy consumption	GJ/tonne silica
Typical value	15 – 18

**Table 5.6: Energy consumption – synthetic amorphous pyrogenic silica [49, CEFIC-ASASP, 2002]**

#### 5.3.1.2 Emission levels

##### 5.3.1.2.1 Emissions to air

Emission points are primarily the off-gas leaving the absorption scrubber system and the venting of conveying air from storage silos to the atmosphere and are given in Table 5.7 below:

Emission concentrations	mg/Nm <sup>3</sup>	kg/tonne of silica
Particulates	<50	<0.3
CO(*)	<3500	
NO <sub>x</sub>	<50	<0.1
Cl <sub>2</sub>	<10	<0.05
HCl	<10	<0.1
VOC	<50	<0.3
CO <sub>2</sub> directly from the process(**)		<640
(*) depending on process design		
(**) depending on the silane feedstock. For certain alkylsilanes <750 kg/t silica.		
Notes:		
1) According to TA Luft 2002, the concentrations of particulates and Cl <sub>2</sub> are much lower, particulates <20 mg/Nm <sup>3</sup> and Cl <sub>2</sub> <3 mg/Nm <sup>3</sup> .		
2) VOC emissions levels are <20 mg/Nm <sup>3</sup> and 0.1 kg/t silica.		
3) Refer also to Section 8.2.3 and to the BREF on CWW.		

**Table 5.7: Emission concentrations and emission values – synthetic amorphous pyrogenic silica [49, CEFIC-ASASP, 2002]**

### 5.3.1.2.2 Emissions to water

In the pyrogenic silica process, emissions to water are of limited concern. The waste water consists principally of aqueous NaCl solutions generated by hypochlorite treatment with small amounts of other materials, giving minor particulates and COD contributions to the effluent. The discharge temperatures of waste water to national watercourses are at the level of 30 °C.

### 5.3.1.2.3 Solid Wastes

Depending on the individual production processes of pyrogenic silica only very little amounts of solid wastes are generated as shown in Table 5.8 below. The product itself is not classified as a hazardous waste.

Waste classification	Amount
Hazardous waste*	<2 kg/t
Non-hazardous waste	<10 kg/t
* Based on the EWC classification, includes e.g. oil, residual raw materials	

**Table 5.8: Waste classification – synthetic amorphous pyrogenic silica [49, CEFIC-ASASP, 2002]**

### 5.3.1.3 Environmental aspects

#### 5.3.1.3.1 Recovery of waste and energy

Recycling of hydrochloric acid, water and energy are integrated components of the pyrogenic silica production plant, which are available to reduce the environmental impact of the process and the production costs. Recycling of packaging material (pallets, big bags) in the manufacturing process is also performed, wherever practicable. Energy recovery is dependent on the local conditions, including the configuration of the plants, the production programme, the types of raw materials required to manufacture the products and their availability to the plants, local market for selling/using energy, as well as local settings and topography as shown in Table 5.9. In each case, the viability of the overall economic aspects have to be taken into consideration.

Recycling	Amount
Packaging recovery	<10 kg/t
Energy recovery	up to 6 GJ/t

**Table 5.9: Packaging and energy recycling – synthetic amorphous pyrogenic silica [49, CEFIC-ASASP, 2002]**

## 5.3.2 Synthetic amorphous precipitated silica and silica gel

### 5.3.2.1 Consumption of raw materials and energy

In the following sections, data are given which reflect average and range values for key input/output parameters associated with precipitated silica and silica gel production.

Recycling of raw materials, water and energy is an integrated part of the silica production process and is carried out to reduce not only environmental impact, but also production costs.





### 5.3.2.2 Emission levels

Two major emissions are generated from the production of precipitated silica and silica gel.

#### 5.3.2.2.1 Emissions to air

Dust emissions mostly occur during the drying process. The emission volume of gases at the outlet of the drying section and the amount of particulates released are dependent upon the drying technology used (direct/indirect) and are shown in Table 5.14 and Table 5.15.

Dust emissions	Amount (kg/tonne of silica)
Particle average emissions	1.3
Slow indirect drying process with high volumes of air, ageing of silica gel	3.3
Fast drying process for precipitated silica, e.g. spray dryers or flash dryers	0.7
Notes:	
1) When typical emission volumes are taken in consideration, as in Table 5.15 below, the resulting dust concentrations are: for silica gel ~37 mg/m <sup>3</sup> outlet air and for precipitated silica ~28 mg/m <sup>3</sup> outlet air.	
2) According to TA Luft 2002, the concentrations of particulates are much lower, i.e. <20 mg/Nm <sup>3</sup> .	
3) A Dutch plant has emission standards for particulates <10 mg/Nm <sup>3</sup> , but they must comply with the new NeR standard, which for dust is <5mg/Nm <sup>3</sup> .	
4) Refer also to Section 8.2.3 and to the BREF on CWW.	

**Table 5.14: Dust emissions – synthetic amorphous precipitated silica and silica gel [49, CEFIC-ASASP, 2002]**

It should be noted that the drying process itself has a strong influence on the desired product properties and cannot readily be changed without affecting product quality.

Process details	Volume (m <sup>3</sup> /tonne of silica)
Silica gel (slow indirect drying)	~ 90000
Precipitated silica (fast drying process)	~ 25000

**Table 5.15: Typical emission volumes – synthetic amorphous precipitated silica and silica gel [49, CEFIC-ASASP, 2002]**

In direct drying processes fired with natural gas, CO and NO<sub>x</sub> are additionally emitted. If other combustibles (oil or coal) were used, SO<sub>2</sub> would also be generated.

Emissions from firing units directly related to the production process of synthetic amorphous precipitated silica and silica gel are given in Table 5.16 below.

Emissions		Amount (kg/tonne of silica)
CO	average	0.825
	highest	1.5
NO <sub>x</sub>	average	0.723
	highest	2.375

**Table 5.16: Emissions from firing units in the production of precipitated silica and silica gel [49, CEFIC-ASASP, 2002]**

It is noted (as is the case in Finland), that CO emissions are not reported from all precipitated silica plants [85, EIPPCB, 2004-2005].

### 5.3.2.2 Emissions to water

In the sodium silicate/sulphuric acid process, the main emissions are by products of the process, normally aqueous  $\text{Na}_2\text{SO}_4$  along with small amounts of other materials, e.g. particulates, pollutants characterised by COD, and in some cases, chlorides. The temperatures of waste water discharged to natural watercourses are in the range from 30 to 40 °C. The pH values of discharged waste waters are typically in the range of 5.5 to 9.0 and, in most cases a pH treatment is necessary.

The average parameter for COD is 1.2 kg/t silica, which comes from organic impurities in the raw materials or additives for removing metal ions during the washing process.

The discharge of particles to natural watercourses is, on average, 6.6 kg/t silica, however, as quoted by Finland (which produces more abrasive silicas of much better sedimentation properties and, therefore, can achieve lower values compared to a normal plant), with the average volume of waste water of 35 m<sup>3</sup>/t silica and solids content of 50 mg/l after solids removal, the particles discharge may be 1.75 kg/t silica [85, EIPPCB, 2004-2005].

Sulphate, normally as a sodium sulphate content in the waste water, is up to 588 kg/t silica as it is generated during the silica synthesis as a by-product [49, CEFIC-ASASP, 2002]. Removal of this pollutant is normally not economically feasible (see Section 5.4.2.1).

### 5.3.2.3 Environmental aspects

#### Product recycling

Silica products are used as ingredients for many types of products and preparations (see Section 5.1.3, e.g. tyres, rubber, paints, paper, toothpaste, etc.). The recovery of silica for direct recycling is, therefore, typically not a viable option. While off-spec material can, to a limited extent, be recycled back into the process, the solids separated from waste water are much more difficult to recycle, as the material is a combination of different products and may contain impurities.

#### Accidental pollution

When chemicals are handled, there is always a risk for accidental pollution. Precipitated silica and silica gel products, however, are of very low risk and are classified as non-hazardous to humans and to the environment. Silica consists essentially of 100 %  $\text{SiO}_2$  which is a common material in soils and our environment. Although there are no concerns about the finished products, there are risks associated with the handling procedures of the raw materials, sulphuric acid and water glass. These risks, however, are well known and all companies take appropriate measures to safeguard the handling of these materials.

## 5.4 Techniques to consider in the determination of BAT

This section sets out techniques considered generally to have potential for achieving a high level of environmental protection in the industries within the scope of the document. Management systems, process-integrated techniques and end-of-pipe measures are included, but a certain amount of overlap exists between these three when seeking the optimum results.

Prevention, control, minimisation and recycling procedures are considered as well as the re-use of materials and energy.

Techniques may be presented singly or as combinations to achieve the objectives of IPPC. Annex IV to the Directive lists a number of general considerations to be taken into account when determining BAT and techniques within this section will address one or more of these considerations. As far as possible a standard structure is used to outline each technique, to enable comparison of techniques and an objective assessment against the definition of BAT given in the Directive.

The content of this section is not an exhaustive list of techniques and others may exist or be developed which may be equally valid within the framework of BAT.

Generally a standard structure is used to outline each technique, as shown in Table 5.17:

Type of information considered	Type of information included
Description	Technical description of the technique
Achieved environmental benefits	Main environmental impact(s) to be addressed by the technique (process or abatement), including emission values achieved and efficiency performance. Environmental benefits of the technique in comparison with others
Cross-media effects	Any side-effects and disadvantages caused by implementation of the technique. Details on the environmental problems of the technique in comparison with others
Operational data	Performance data on emissions/wastes and consumption (raw materials, water and energy). Any other useful information on how to operate, maintain and control the technique, including safety aspects, operability constraints of the technique, output quality, etc.
Applicability	Consideration of the factors involved in applying and retrofitting the technique (e.g. space availability, process specific)
Economics	Information on costs (investment and operation) and any possible savings (e.g. reduced raw material consumption, waste charges) also as related to the capacity of the technique
Driving force for implementation	Reasons for implementation of the technique (e.g. other legislation, improvement in production quality)
Example plants	Reference to a plant where the technique is reported to be used
Reference literature	Literature for more detailed information on the technique

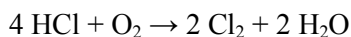
**Table 5.17: Information breakdown for each technique described in this section**

Reference is to be made here also to Section 8.9, providing key information on the Environmental Management System (EMS) which is a tool for IPPC installations that operators can use to address the design, construction, maintenance, operation and decommissioning issues in a systematic demonstrable way.

Techniques broadly applicable in the chemical industry, described in the BREF on Common Waste Water and Waste gas Treatment/Management Systems in the Chemical Sector, are not included in this section (refer to the BREF on CWW).

### 5.4.1 Synthetic amorphous pyrogenic silica

The manufacture of pyrogenic silica uses a feedstock of hydrogen, air and varying blends of chlorinated silanes (see Section 5.2.1). After rapid cooling, the thermodynamic equilibrium favours the formation of hydrogen chloride (HCl). However, due to the presence of excess oxygen and kinetic limitations, between 6 - 10 % of the total chlorine atoms are present in the off-gas as chlorine (Cl<sub>2</sub>). The Deacon reaction that controls the ratio of chlorine to hydrogen chloride is shown below:



The total mass of HCl evolved depends on the ratio of feedstock types being reacted, however it is always significant, as it is approximately double that of the pyrogenic silica produced. This must be recovered in order to make the process economically and environmentally acceptable. Depending upon the silica production requirements and the feedstock blend being used, immediately subsequent to the reaction, the process off-gas contains between 10 – 20 % hydrogen chloride and 1 – 3 % chlorine [49, CEFIC-ASASP, 2002]. The HCl, being soluble, is recovered from the process off-gas after it has been separated from the silica by a wet absorption process. This primary HCl absorption process is considered to be an integral step in the manufacture of pyrogenic silica (process-integrated measure), however, as it has an influence for reducing the impact of silica production on the environment, it is covered in Section 5.4.1.4. The chlorine is hardly soluble in water and passes through the absorption process. It is present in quantities and concentrations too low for direct recovery but due to its potential adverse effects on the environment, the chlorine concentration is reduced to a maximum of about 10 mg/m<sup>3</sup> in the process off-gas before it is discharged into the atmosphere. There are several viable techniques for reducing the chlorine emission levels depending upon the exact pyrogenic silica plant design. More widely adopted techniques are listed below:

#### Process-integrated measures for reducing the chlorine emission levels

- hydrogen injection
- methane and hydrogen injection
- incineration.

Chlorine elimination can take place either before or after primary HCl absorption. Hydrogen and methane/hydrogen injection measures take place before primary HCl absorption and are described in Sections 5.4.1.1 and 5.4.1.2 respectively. Incineration is used after primary HCl absorption and requires a secondary absorption process to recover HCl formed during incineration. This measure is described in Section 5.4.1.3. Table 5.18 gives a comparison of chlorine reduction options integrated within the process.

	H <sub>2</sub> injection	CH <sub>4</sub> /H <sub>2</sub> injection	Incineration
Residual chlorine (mg/m <sup>3</sup> )	300	300 – 1200	40
Residual chloromethanes (mg/m <sup>3</sup> )	0	25 – 50	0
Residual CO (mg/m <sup>3</sup> )	0	<3500	0
Residual CO <sub>2</sub> (mg/m <sup>3</sup> ) (*)	0	3000 – 11000	5000 – 14000
Hydrogen consumption (kg/tonne silica)	10	0 – 6	0
Methane consumption (kg/tonne silica)	0	15 – 40	300
Nitrogen consumption (kg/tonne silica)	50	0	0
<b>Capital cost</b>	<b>Low</b>	<b>Low</b>	<b>High</b>

(\*) The figures do not include the CO<sub>2</sub> contribution from the feedstock.

**Table 5.18: Comparison of chlorine reduction options integrated within the process [49, CEFIC-ASASP, 2002]**

Following the use of one (or more) process-integrated measures for reducing Cl<sub>2</sub> emission levels, all manufacturers employ end-of-pipe caustic scrubber to reduce chlorine concentrations.

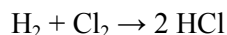
### End-of-pipe measures

Off-gas scrubbing and sodium hypochlorite treatment are used– see Section 5.4.1.5.

#### 5.4.1.1 Chlorine reduction using hydrogen injection

##### Description

Hydrogen injection is used to convert chlorine in the off-gas to hydrogen chloride and has a conversion efficiency of about 99 %. It also has an advantage in that as the conversion to HCl occurs in the cooling section immediately after the silica reaction, only one hydrogen chloride absorption step is required, and hence HCl recovery is facilitated. The reaction between hydrogen and chlorine is shown below:



The reaction takes place between 550 – 650 °C, resulting in a final chlorine concentration of about 300 mg/m<sup>3</sup> in the off-gas. Thus, using hydrogen injection the final chlorine concentration is still sufficiently high to justify a further ‘end-of-pipe’ treatment, before the off-gas is discharged into the atmosphere (refer to Section 5.4.1.5).

The reaction takes place very quickly requiring the need for extremely rapid and complete mixing in order to get a high conversion efficiency. This can be difficult to achieve with hydrogen alone due to the very low molecular mass of a hydrogen molecule, which, by nature, can possess very little momentum. This is overcome by mixing nitrogen, a much heavier molecule, with the hydrogen. This mixture of gases allows for a much more thorough and complete mixing in the process gas stream.

##### Achieved environmental benefits

Reduction of the chlorine emissions (reduction of the chlorine content in the off-gas through its conversion to HCl, which is much easier to wash out in only one absorption step).

##### Cross-media effects

Additional energy is required for the production of hydrogen and nitrogen, used in this technique.

##### Operational data

With hydrogen injection technology it is possible to reduce the chlorine levels in the process off-gas from the manufacture of pyrogenic silica from about 1 – 3 % to 300 mg/m<sup>3</sup>. See also data in Table 5.18 above.

##### Applicability

Applicable to all plants producing synthetic amorphous pyrogenic silica.

##### Economics

No detailed data submitted, apart from those included in Table 5.18 above.

##### Driving force for implementation

The protection of the environment (substantial reduction of Cl<sub>2</sub> content in the off-gas).

##### Example plants

No data submitted. This technique is used in some of the pyrogenic silica plants listed in Table 5.4.

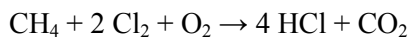
##### Reference literature

[49, CEFIC-ASASP, 2002].

### 5.4.1.2 Chlorine reduction using methane and hydrogen injection

#### Description

Again, the advantage of reacting methane (natural gas) with chlorine to form hydrogen chloride immediately after the reaction is that there only needs to be one hydrogen chloride absorption step, and HCl recovery is facilitated. The reaction is shown below:



As can be seen from the above equation, there needs to be a significant amount of oxygen in the off-gas stream for the reaction to occur. The reaction needs to take place at between 650 - 750 °C, but due to the formation of several species of chloromethanes (chloromethane – CH<sub>3</sub>Cl, methylene chloride – CH<sub>2</sub>Cl<sub>2</sub>, chloroform – CHCl<sub>3</sub>, and carbon tetrachloride – CCl<sub>4</sub>) at the lower temperatures, a more desirable range of temperature is about 700 – 750 °C.

By using this method, about 98 – 99 % of the chlorine is converted to hydrogen chloride. Higher conversions are possible, but this is at the expense of greater chloromethane formation. Careful control of the operating temperature within the optimum range can limit total chloromethane generation to about 100 mg/m<sup>3</sup>. The chloromethanes that are formed during the conversion of chlorine to hydrogen chloride are themselves converted to hydrogen chloride by the injection of a hydrogen ‘polishing’ stream as the off-gas is cooled further downstream. This reduces the chloromethane level in the off-gas to below 50 mg/m<sup>3</sup>.

A new control technology is the installation and accurate operation of multiple methane and hydrogen injection points, jointly with automatic scanning and selection of optimum points for the operating conditions. This could enable lower chlorine levels to be achieved, whilst generating very low levels of chloromethanes. The theory of this reaction predicts the formation of very low levels of carbon monoxide (CO). In practice, however, a lack of hydrogen radicals hinders the formation of HCO radicals by reacting the former with CO and, therefore, oxidation can be hindered from going to completion and forming carbon dioxide (CO<sub>2</sub>). Such reaction conditions can lead to higher contents of CO but by careful control of the temperature and injection flowrates, CO generation can be controlled at the range of about 2000 – 3500 mg/m<sup>3</sup>.

Summing up, with methane and hydrogen injection technology it is possible to reduce the chlorine levels in the process off-gas from the manufacture of pyrogenic silica from about 1 - 3 % to between 300 – 1200 mg/m<sup>3</sup>.

Significant reductions in chlorine in the off-gas are obtained by this method of abatement by converting it to hydrogen chloride, thus enabling it to be recovered and re-used. However, the residual quantity of chlorine is still sufficient to warrant further ‘end-of-pipe’ treatment before the off-gas is acceptable for discharge to the atmosphere.

#### Achieved environmental benefits

Reduction of the chlorine emissions (reduction of the chlorine content in the off-gas through its conversion to HCl, which is much easier to wash out in only one absorption step).

#### Cross-media effects

Additional energy is required for the production of methane and hydrogen, used in this technique. Furthermore, the application of this technique will increase the emission of chloromethane.

#### Operational data

By using this technique, about 98 – 99 % of the chlorine is converted to hydrogen chloride. This results in a chlorine concentration in the off-gas after treatment of between 300 and 1200 mg/m<sup>3</sup>. See also data in Table 5.18 above.

### Applicability

This technique requires oxygen for the reaction to occur and, therefore, it is most suitable for processes with a single-pass main reaction quench system, as the process off-gas contains about 10 – 12 % oxygen after the silica reaction.

### Economics

No detailed data submitted, apart from those included in Table 5.18 above.

### Driving force for implementation

The protection of the environment (substantial reduction of Cl<sub>2</sub> content in the off-gas).

### Example plants

No data submitted. This technique is used in some of the pyrogenic silica plants listed in Table 5.4.

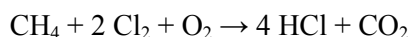
### Reference literature

[49, CEFIC-ASASP, 2002].

## 5.4.1.3 Chlorine reduction using incineration

### Description

Chlorine reduction in the process off-gas stream by thermal combustion takes place after the bulk of the HCl has already been recovered (see Section 5.4.1.4 below). The off-gas, which can contain up to 3 % chlorine, is heated with methane in a furnace to between 900 – 1300 °C; the optimum temperature is about 1000 °C for typical process off-gas from the silica industry. The reaction mechanism is the same as that for methane injection but the process is more efficient with the residual off-gas stream containing about 40 mg/m<sup>3</sup> chlorine and very low levels of chloromethanes and carbon monoxide. This is because the process takes place with excess oxygen at a high temperature, enabling the preferential reaction with chlorine producing HCl to occur:



When designing and installing an incinerator, it is important to assure that there is enough residence time for a complete reaction. Also, the combustion chamber needs to be sized to handle the maximum off-gas throughput, which is about 10 tonnes/tonne of silica. Typically, this type of equipment is designed with a residence time of about 0.5 seconds, which is at least five times greater than the theoretical time needed for the reaction to take place. With such a residence time, an effective operating temperature as low as 850 °C may be used, while still obtaining complete conversion of the chlorine. The longer the residence time, the lower the temperature may be, which has the advantage of lowering the operating costs and lengthening the life of the refractory lining in the furnace. However, this has to be offset against the higher capital cost due to the increased size of the incinerator. After combustion, the off-gas stream is then passed through a second absorption step to recover the hydrogen chloride produced in the incinerator. Even though this process is more efficient than the first two methods (see Sections 5.4.1.1 and 5.4.1.2), post treatment scrubbing of the off-gas is still necessary to reduce the final chlorine concentration in the off-gas to less than 10 mg/m<sup>3</sup> before it is discharged to the atmosphere.

### Achieved environmental benefits

Substantial reduction of the toxic chlorine content in the off-gas through its conversion to HCl, this latter one being easily washed out and recovered in a final scrubbing step.

### Cross-media effects

One process disadvantage is the inefficiency of reheating the entire off-gas stream to its combustion temperature after cooling it to near ambient levels in the first absorption process. This raises the natural gas demand to 300 kg per tonne of silica.

However, some of the energy is usually recovered by the incorporation of a boiler to generate steam from the hot off-gas stream, which can either be used for vaporising the silica feedstock or producing anhydrous hydrochloric acid.

#### Operational data

With the incineration technique it is possible to reduce the chlorine levels in the process off-gas from the manufacture of pyrogenic silica from about 1 – 3 % to 40 mg/m<sup>3</sup>. See also data in Table 5.18 above.

#### Applicability

Incineration is used in pyrogenic silica plants only after the primary HCl absorption step and, therefore, requires a secondary absorption step to recover HCl formed during incineration.

#### Economics

The capital requirements of this method of chlorine reduction are extremely high due to the need for special construction materials to survive the harsh environment, as well as due to the requirement for a second hydrogen chloride absorption step. Typically, the total capital requirements for a pyrogenic silica plant using this technology are of the order of 6 – 10 % higher than those for a plant using the alternative chlorine reduction technologies. In turn, an advantage of the higher chlorine removal efficiency by incineration is that the operating costs associated with the final scrubbing operation are about 10 times less than in the first two methods.

#### Driving force for implementation

The protection of the environment (reduction of Cl<sub>2</sub> content in the off-gas).

#### Example plants

No data submitted. This technique used in some of the pyrogenic silica plants listed in Table 5.4.

#### Reference literature

[49, CEFIC-ASASP, 2002].

### **5.4.1.4 Hydrogen chloride removal from the off-gas**

#### Description

As mentioned in Section 5.4.1, the process off-gas contains between 10 – 20 % hydrogen chloride depending upon the plant's operating conditions. These include factors such as feedstock type, feedstock blend, grade mix, total production requirements, water addition, efficiency of chlorine abatement, etc. For environmental and commercial reasons, it is important to recover as much hydrogen chloride as possible.

With variable off-gas conditions and volumes, today's technology applies aqueous absorption of the hydrochloric acid from the off-gas. An advantage of this process is that the off-gas consists largely of gases that are only slightly soluble in water except for hydrogen chloride, which is to be removed. Using this technology, recovery efficiencies of 99.5 – 99.9 % are predicted.

In theory, under ideal conditions, 99.99 % recovery should be achievable whilst minimising the build up of water in the system. However, in practice, plants operate under constantly changing conditions because of the need to vary loads, feedstock and the grade of silica being manufactured. This results in fluctuations in the absorption system and consequently practical HCl recovery efficiencies are of the order of 97 %.

Both countercurrent and cocurrent process systems are used by the industry. In theory, cocurrent systems should be more efficient as the streams should come to equilibrium quicker. However, in practice, due to the quantity of inert gases in the process, neither configuration is preferable as it is the rate of diffusion through the inert gases that controls the absorption rate. Because of this, both process systems achieve comparable recoveries.



Absorption equipment is very prone to fouling, so the first step in the recovery process is usually the removal of any carryover silica, which has a particle size range of 0.5 – 10 microns in aqueous dispersion, by either venturi scrubber or filtration. It is important to remove these particles because the absorption of hydrogen chloride in water generates approximately 1900 kJ/kg HCl (1.9 - 3.8 GJ/tonne of silica) of heat that must be removed from the system in order to keep the recovery efficiencies high. Significant silica carryover would foul heat exchangers and block the absorption equipment.

It is desirable and most efficient to produce hydrochloric acid that is as concentrated as possible to minimise processing, handling and transport costs. In practice, this is about 32 % HCl because this is about the strongest hydrochloric acid that is stable at ambient temperatures. In order to obtain acid of this strength, a minimum of two absorption stages are normally required. Single pass processes generally start with water, this usually being the case if aqueous hydrochloric acid is being exported from the process and used in another operation or sold to external consumers. Alternatively, recycled acid at about 20 % is used if anhydrous hydrochloric acid is to be generated. The strength of the acid is not taken much lower than this during the production of anhydrous hydrochloric acid because the nearer the acid concentration approaches to the azeotropic strength of 20 %, the harder it becomes to strip-off hydrochloric gas. The heat that is liberated in the recovery process must be removed in order to achieve acceptable recovery efficiencies. An effective way to do this, is to make the second stage an adiabatic absorption step. This minimises the number of heat exchangers required in total, as the heat generated here is used to evaporate the water out of the system that is introduced from the off-gas. Various types of absorption equipment can be utilised for the first stage, such as spray towers, packed towers, and falling film exchangers.

Typically, after the off-gas has been through a two stage absorption process, it will still contain up to 150 mg/m<sup>3</sup> hydrochloric acid. These residual levels of hydrochloric acid are usually recovered by passing the off-gas through either a final absorption column, venturi scrubber or jet washer, depending upon the maximum residual hydrochloric acid that is acceptable in the off-gas. The weak acid solution containing 1 – 2 % hydrochloric acid, that is generated by this recovery process, is then used as a feed stream into the main absorption process.

After the completion of the individual absorption steps virtually all of the hydrochloric acid will have been recovered leaving <10 mg/m<sup>3</sup> of HCl in the off-gas from the process.

### Achieved environmental benefits

Substantial removal of hydrogen chloride from the off-gas released to the atmosphere.

### Cross-media effects

No data submitted.

### Operational data

The process off-gas contains between 10 – 20 % hydrogen chloride. Using this technique, a practical HCl recovery efficiency of 97 % is achieved, and – after the final washing step – <10 mg/m<sup>3</sup> HCl is left in the off-gas from the process.

### Applicability

Applicable to all plants producing synthetic amorphous pyrogenic silica.

### Economics

No detailed data submitted.

### Driving force for implementation

The protection of the environment (substantial reduction of HCl content in the off-gas).  
Production of the marketable hydrochloric acid.

### Example plants

Synthetic amorphous pyrogenic silica plants listed in Table 5.4.

Reference literature

[49, CEFIC-ASASP, 2002].

#### 5.4.1.5 Scrubbing chlorine from the off-gas and sodium hypochlorite treatment

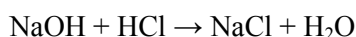
Description

Scrubbing chlorine from the off-gas, and the follow-up sodium hypochlorite treatment, is an integrated, two stage end-of-pipe technique applied in the production of synthetic amorphous pyrogenic silica. Depending upon the type of technology used to minimise chlorine emissions to the air, the off-gas will typically have a chlorine concentration of between 40 – 1200 mg/m<sup>3</sup> after the HCl has effectively been removed.

It is mandatory that this concentration is reduced to about 10 mg/m<sup>3</sup> before the off-gas is discharged to the atmosphere. This is achieved by bringing the off-gas into contact with a weak caustic soda solution in a packed tower. Depending upon the inlet concentration of chlorine, the tower will consist of either one or two packed sections. The caustic soda solution, usually between 2 - 4 % in strength, is recycled at high rates around the tower and maintained within a pH range of 8.0 – 9.0 by constantly adding fresh caustic solution. The chlorine is converted into hypochlorite and salt, as shown in the reaction below:



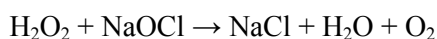
An advantage of this process is that any hydrogen chloride which is not recovered and is carried over into the scrubber is also converted to sodium chloride:



The sodium hypochlorite is only formed between a strength of 0.5 – 1 %. It is not viable to utilise this stream in other processes as it would need to be concentrated significantly before it could be used commercially. This waste sodium hypochlorite stream from the scrubber, which is usually about 500 – 1500 kg/tonne of silica, requires further treatment before it can be discharged to a watercourse.

There are basically two alternative ways to ‘fix’ the chlorine in the waste stream; firstly, by reacting it with a reducing agent such as hydrogen peroxide or, secondly, by catalytically converting sodium hypochlorite to sodium chloride.

When reacting sodium hypochlorite with hydrogen peroxide, a weak H<sub>2</sub>O<sub>2</sub> solution, normally about 2 %, is mixed with the effluent stream from the scrubber, and then enters a holding tank to allow time for the reaction to occur. Oxygen, which is produced, is vented from the system to the atmosphere. The reaction is shown below:



This will reduce the sodium hypochlorite from about 0.5 – 1 % to well below 10 mg/l in the final effluent (treated waste water) discharged to a local watercourse.

Alternatively, a heterogenous catalytic conversion process can be used. The effluent stream is passed through a fixed bed catalytic reactor where the sodium hypochlorite is reduced directly to sodium chloride and oxygen. Efficiency is similar to that obtained with hydrogen peroxide, however, the system is less prone to side effect reactions and is, therefore, considered to be more robust. There are also certain precautions that must be taken in order to maintain maximum catalyst efficiency and its life, which is about three years.

Achieved environmental benefits

Final reduction of the toxic chlorine content in the off-gas by fixing the chlorine in the effluent stream in the form of weak salt brine.

### Cross-media effects

No detailed data submitted, however, in the case of using a catalytic process of NaOCl conversion to NaCl, due precautions need to be taken to avoid discharges of nickel catalyst into the process effluent.

### Operational data

By bringing the the off-gas into contact with a weak caustic soda solution in a packed tower, a chlorine concentration of between 40 – 1200 mg/m<sup>3</sup> is reduced to about 10 mg/m<sup>3</sup> before the off-gas is discharged to the atmosphere. One of the two follow-up alternative sodium hypochlorite treatment technologies is then used to fix the chlorine in the effluent stream by converting it into a weak brine solution of a maximum of 2 % NaCl before further dilution.

### Applicability

End-of-pipe technique, applicable to all plants producing synthetic amorphous pyrogenic silica.

### Economics

No data submitted.

### Driving force for implementation

The protection of the environment.

### Example plants

No data submitted. This technique is used in some of the pyrogenic silica plants listed in Table 5.4.

### Reference literature

[49, CEFIC-ASASP, 2002].

## 5.4.2 Synthetic amorphous precipitated silica and silica gel

The production of synthetic amorphous precipitated silica and silica gel can be divided into two distinct phases:

- wet stage process
- dry stage process.

### **Wet stage process**

In the wet stage of the process, an aqueous solution of sodium silicate is reacted with sulphuric acid to yield synthetic silica. Depending on the process conditions, the resulting product is either a precipitated silica, a silica gel or a combination product. The silica gel or precipitated silica slurry is then washed and concentrated. A main compound of concern in the wet stage process is sodium sulphate formed in the precipitation reaction, washed out and diluted in the waste water. The waste water is the main environmental impact. Practically, all the waste water generated at the washing/filtering stage is discharged into natural watercourses or the sea. Average effluent volumes and properties are described in Sections 5.2.2.4.1 and 5.3.

### **Dry stage process**

The silica slurry or filter cake from the wet process is introduced into a dryer (spray, fluidised-bed, drum, etc.), where the water is evaporated to yield an essentially dry silica product.

The amount of water to be evaporated per tonne of dry silica product depends on:

- silica type (absorptiveness)
- liquid/solid separation
- drying technology.

The main environmental impact from the dry stage process of the production of precipitated silica and silica gel are the emissions to air, presented in Section 5.3.1.2.1. With regard to the production of precipitated silica and silica gel, the following two techniques are described and analysed below:

- a group of methods aimed at removing the sodium sulphate from the waste water (wet stage process)
- drying precipitated silica and silica gel (dry stage process).

#### 5.4.2.1 Sodium sulphate removal from the waste water

##### Description

The sodium sulphate by-product formed in the precipitation reaction is detrimental in most applications where silica is used and, consequently, has to be washed out in order to remove it from the silica produced. For example, the sodium sulphate content is a limiting factor for the use of silica in the food industry and, therefore,  $\text{Na}_2\text{SO}_4$  must be removed with high efficiency. The sodium sulphate, washed out in the production process of precipitated silica and silica gel, is a potential by-product to recover.

However, as claimed by the silica industry, the concentration of sodium sulphate in waste waters from the production of precipitated silica and silica gel is considered to be generally too low for its recovery to be economically viable. Most recovery or minimisation techniques in the precipitated silica industry have problems as indicated in the next paragraphs of the 'Description'.

The spray drying of waste water is inefficient because of the high energy consumption required and  $\text{CO}_2$  generation. Crystallisation also suffers in this respect. Additionally, if the silica plant is not located by the sea, sodium sulphate salt must be assigned to special landfills because of the environmental risks (as it is hazardous to soil, water and water organisms). Operational costs for this type of treatment are approximately EUR 700/t silica (2002 data and prices), split roughly for energy consumption (40 %) and disposal costs (60 %). If there is a market for by-product sodium sulphate, disposal costs could be eliminated and the operational costs (which would then mainly relate to the consumption of energy) could be reduced to approximately 0.4 x EUR 700/t silica ~ EUR 280/t silica.

During precipitation of gypsum, the sulphate content in waste water could be reduced to the level of 3000 – 5000 mg/l by the generation of gypsum (via the addition of calcium oxide or calcium hydroxide). This treatment, however, is cost-intensive and the gypsum produced preferably needs an output as a raw material in other industries – otherwise, its disposal may pose problems. The operational costs for the removal of sulphate by the generation of gypsum are of the order of EUR 225/t silica, with costs being split approximately for energy consumption (50 %), supply of calcium oxide (25 %), and the disposal/recycling fees (25 %). If there is a market for the by-product gypsum, disposal costs could be eliminated, and the operational costs could be reduced by ~ 25 %, i.e. to approximately EUR 170/t silica.

It should be noted, however, that the volumes of generated gypsum would exceed the silica production volume by a factor of at least 2.

Organic precipitation usually involves ethanol causing handling, process and toxicity concerns.

In membrane dialysis, the membranes would be sufficient for pure sodium sulphate solutions but with colloidal silica present in the waste water, the membranes will become blocked and lose their efficiency. Currently, there is no technical solution available on the market to handle this problem.

During ion exchange, the sulphate concentration in the effluent has effectively been generated by an ion exchange reaction. Since both sodium and sulphate are common ions, obviously no other products of value but sodium sulphate could be made by further exchange reactions.

### Achieved environmental benefits

Most sodium sulphate recovery or minimisation techniques have problems as indicated above, and in view of these difficulties, the discharge of dilute solutions to sea outlets, where sodium sulphate is a natural component in the oceans, can represent the best environmental option for disposal, after adjusting other parameters as appropriate.

### Cross-media effects

Although the silica industry claims that the discharge of sodium sulphate waste water into natural waters, like rivers and seas, has no or a low impact on the aquatic environment, in each case an assessment of the discharge of dilute solutions of sodium sulphate to sea outlets and its impact on the aquatic environment (river, river estuary or sea) needs to be carried out.

### Operational data

The silica produced needs to be washed out to remove soluble salts (mostly  $\text{Na}_2\text{SO}_4$ ). The volume of the waste water generated varies in the range between 21 to 46 m<sup>3</sup> per tonne of silica and is normally discharged to natural watercourses (rivers, sea) after passing through waste water treatment plants.

As the content of sodium sulphate in the waste water is up to 588 kg/t silica produced (see Section 5.3.2.2.2), this means that the concentration of  $\text{Na}_2\text{SO}_4$  diluted in the waste waters varies in the range of 13 to 28 g/l, however, for silica plants using less water for washing purposes, the concentration of  $\text{Na}_2\text{SO}_4$  in the waste waters can be up to 40 g/l. This offers better prospects for the recovery of sodium sulphate, provided that product quality is not affected. Refer also to information included in the 'Description' above.

### Applicability

It is reported that the described techniques for the removal of sodium sulphate cannot be used under the current process circumstances, however, after further development, some of the methods included in the 'Description' may become potentially available, in particular to those plants producing precipitated silica and silica gel, which will develop a market niche for the by-product.

### Economics

No other data submitted apart from those included in the 'Description' above.

### Driving force for implementation

Environment protection, and potential recovery of the sodium sulphate as a by-product.

### Example plants

No example plants have been mentioned with regard to this technique.

### Reference literature

[49, CEFIC-ASASP, 2002], [85, EIPPCB, 2004-2005].

## **5.4.2.2 Drying precipitated silica and silica gel**

### Description

Depending on the type of silica produced, the amount of water to be evaporated can be as high as 4 – 6 tonnes per tonne of silica product (refer to Section 5.2.2.4.2).

Liquid/solid separation techniques applied upstream of the silica dryer are directly linked to the energy consumption at the drying stage. Filter type and dryer type selection is linked together in as much as some dryers can only take slurry feed whilst other types work better with filter cake.

Silica slurry or filter cake is introduced into a dryer (spray, fluidised-bed, drum, etc.), where the water is evaporated to yield an essentially dry silica product. Modern drying equipment will give a high level of thermal efficiency. In general terms, the drying step is a very mature process and process economy drivers automatically lead to reduced emissions along with optimal drying costs. The drying process itself has a strong influence on the desired product properties and cannot readily be changed without affecting product quality.

Depending on the technology used (direct natural gas fired dryers, indirect dryers using hot air), the energy required is produced by firing processes or heat exchange processes using high pressure steam.

The emission volume of gases at the outlet of the drying section and the amount of particulates released are dependent upon the drying technology used (direct/indirect). For particulates (see also Section 5.4.3 below), dryers are always equipped with dust collection equipment, typically bag houses. Dust collected in bag house filters can be recovered to minimise material losses and to raise the total efficiency of the process. Other control techniques include venturi scrubbers and cyclones followed by a scrubber or a bag house filter – refer to Section 5.2.2.4.2, to the BREF on CWW, and Chapter 8 of this document.

#### Achieved environmental benefits

Proper selection and integration of liquid/solid separation and silica drying techniques, allows for substantial reduction of energy used for drying silica and, therefore, less CO<sub>2</sub>, SO<sub>x</sub> and NO<sub>x</sub> emissions, that would otherwise result from the generation of an additional amount of energy required for drying silica.

#### Cross-media effects

In direct drying processes fired with natural gas, CO and NO<sub>x</sub> are additionally emitted. If other combustibles (oil or coal) were used, SO<sub>2</sub> would also be generated.

#### Operational data

The drying process cannot be be changed easily, as it has a dramatic influence on the product shape and performance. The major energy demand is for the drying step of silica production, with energy consumption in the range of 15 – 24 GJ per tonne of silica produced. Emission volumes and carbon dioxide levels are strongly influenced by the type of dryer and its operation. Average dryer emission volumes and characteristics are described in Section 5.3.

#### Applicability

This technique is applicable to all plants producing precipitated silica and silica gel.

#### Economics

No detailed data submitted.

#### Driving force for implementation

Improvement of the quality of silica products. Reduction of the energy demand in the process. Minimisation of the impact of the production of precipitated silica and silica gel on the environment (emissions to air).

#### Example plants

This technique is widely used in the precipitated silica and silica gel plants listed in Table 5.4.

#### Reference literature

[49, CEFIC-ASASP, 2002].

### 5.4.3 Dust removal/separation measures

#### Description

Dust removal/separation measures are relevant to the production of synthetic amorphous silica, including both pyrogenic silica and precipitated silica/silica gel (refer also to Section 5.4.2.2). In order to remove synthetic amorphous silica particulates from air, prior to its discharge to the environment, the following techniques need to be considered:

- electrostatic precipitators
- cyclones
- fabric filters.

These techniques are described in detail in the BREF on Common Waste Water and Waste Gas Treatment/Management Systems in the Chemical Sector (CWW) and, therefore, there is no need to describe them here. It should be noted, however, that pyrogenic silica dust is characterised by submicron particles, and more difficult to collect from the gas stream.

#### Achieved environmental benefits

Substantial removal of silica dust from the process off-gases released to the atmosphere.

#### Cross-media effects

In some cases, venturi scrubbers or scrubbers are used for the dedusting in the silica industry. The disadvantage of the use of scrubber systems is the generation of contaminated waste water which may then itself require treatment.

#### Operational data

Cyclones are widely used in the silica industry, often in conjunction with fabric filters. Fabric filters have a high collection efficiency (>99.5 %). When operating efficiently, the process gas stream after a fabric filter will contain <50 mg of silica dust/m<sup>3</sup> of the outlet gas, however, lower values <5 – 20 mg of silica per m<sup>3</sup> of the outlet gas are also reported. Refer to Table 5.7, Table 5.14 and to the following notes:

- according to TA Luft 2002, the concentrations of particulates are <20 mg/Nm<sup>3</sup>
- the Dutch precipitated silica plant has emission standards for particulates of <10 mgN/m<sup>3</sup> but they must comply with the new NeR standard, which for dust is <5 mg/Nm<sup>3</sup>.

#### Applicability

Dust removal/separation techniques in which cyclones are used in conjunction with fabric filters are widely applicable in the silica industry.

#### Economics

No data submitted.

#### Driving force for implementation

- the protection of the environment
- the recovery of silica dust.

#### Example plants

This technique is commonly used in the silica plants which are listed in Table 5.4.

#### Reference literature

[49, CEFIC-ASASP, 2002], [85, EIPPCB, 2004-2005].

## 5.5 Best Available Techniques for the production of synthetic amorphous silica

In understanding this section and its contents, the attention of the reader is drawn back to the preface of this document and in particular the fifth section of the preface: ‘How to understand and use this document’. The techniques and associated emission and/or consumption levels, or ranges of levels, presented in this section have been assessed through an iterative process involving the following steps:

- identification of the key environmental issues for the sector:
  - for the production of synthetic amorphous pyrogenic silica by the thermal process route, the key environmental issue is to reduce the chlorine emission levels by applying process-integrated measures (hydrogen injection, methane and hydrogen injection, incineration), followed by the removal of hydrogen chloride from the off-gas and, finally, by using the end-of-pipe technique of scrubbing residual chlorine from the off-gas and treatment of the resulting sodium hypochlorite stream either with hydrogen peroxide or by catalytic conversion to obtain sodium chloride
  - for the production of synthetic amorphous precipitated silica and silica gel by the wet process route, the most important environmental issue is proper selection and integration of liquid/solid separation and silica drying techniques in order to save energy and reduce the associated emissions of CO<sub>2</sub>, SO<sub>x</sub> and NO<sub>x</sub>
  - dust removal measures (the use of ESPs, cyclones, and fabric filters) are relevant to the production of both pyrogenic silica and precipitated silica and silica gel
- examination of the techniques most relevant to address these key issues
- identification of the best environmental performance levels, on the basis of the available data in the European Union and worldwide
- examination of the conditions under which these performance levels were achieved; such as costs, cross-media effects, and the main driving forces involved in implementation of the techniques
- selection of the best available techniques (BAT) and the associated emission and/or consumption levels for this sector in a general sense, all according to Article 2(11) and Annex IV of the Directive.

Expert judgement by the European IPPC Bureau and the relevant Technical Working Group (TWG) has played a key role in each of these steps and in the way in which the information is presented here.

On the basis of this assessment, techniques, and as far as possible consumption and emission levels associated with the use of BAT, are presented in this section that are considered to be appropriate to the sector as a whole and in many cases reflect the current performance of some installations within the sector. Where emission or consumption levels ‘associated with best available techniques’ are presented, this is to be understood as meaning that those levels represent the environmental performance that could be anticipated as a result of the application, in this sector, of the techniques described, bearing in mind the balance of costs and advantages inherent within the definition of BAT. However, they are neither emission nor consumption limit values and should not be understood as such. In some cases it may be technically possible to achieve better emission or consumption levels but due to the costs involved or cross-media considerations, they are not considered to be appropriate as BAT for the sector as a whole. However, such levels may be considered to be justified in more specific cases where there are special driving forces.

The consumption and emission levels associated with the use of BAT have to be seen together with any specified reference conditions (e.g. averaging periods).



The concept of 'levels associated with BAT' described above is to be distinguished from the term 'achievable level' used elsewhere in this document. Where a level is described as 'achievable' using a particular technique or combination of techniques, this should be understood to mean that the level may be expected to be achieved over a substantial period of time in a well maintained and operated installation or process using those techniques.

Where available, data concerning costs have been given together with the description of the techniques presented in the previous section. These give a rough indication about the magnitude of the costs involved. However, the actual cost of applying a technique will depend strongly on the specific situation regarding, for example, taxes, fees, and the technical characteristics of the installation concerned. It is not possible to evaluate such site-specific factors fully in this document. In the absence of data concerning costs, conclusions on economic viability of techniques are drawn from observations on existing installations.

It is intended that the general BAT in this section are a reference point against which to judge the current performance of an existing installation or to judge a proposal for a new installation. In this way they will assist in the determination of appropriate 'BAT-based' conditions for the installation or in the establishment of general binding rules under Article 9(8). It is foreseen that new installations can be designed to perform at or even better than the general BAT levels presented here. It is also considered that existing installations could move towards the general BAT levels or do better, subject to the technical and economic applicability of the techniques in each case.

While the BAT reference documents do not set legally binding standards, they are meant to give information for the guidance of industry, Member States and the public on achievable consumption and emission levels when using specified techniques. The appropriate limit values for any specific case will need to be determined taking into account the objectives of the IPPC Directive and the local considerations.

**For synthetic amorphous silica plants in the EU-25, the following are BAT:**

### 5.5.1 Synthetic amorphous pyrogenic silica

1. Application of one of the available three primary, process-integrated chlorine reduction techniques ( $H_2$  injection,  $H_2/CH_4$  injection, incineration), followed by the final scrubbing of chlorine from the off-gas with caustic soda solution, to decrease  $Cl_2$  emissions from the off-gas to the level of 3 – 10 mg  $Cl_2/Nm^3$  – see Sections 5.3.1.2.1, 5.4.1, 5.4.1.1, 5.4.1.2, 5.4.1.3 and 5.4.1.5.
2. Hydrogen chloride removal from the off-gas by the application of aqueous absorption, followed by the final scrubbing of hydrogen chloride from the off-gas with caustic soda solution, to decrease HCl emissions to the level of <10 mg HCl/ $Nm^3$  of the outlet gas – see Sections 5.3.1.2.1, 5.4.1, 5.4.1.1, 5.4.1.2, 5.4.1.3, 5.4.1.4 and 5.4.1.5.
3. Treatment of the waste stream of sodium hypochlorite solution, either by reaction with hydrogen peroxide or by heterogenous catalytic conversion, to reduce the content of sodium hypochlorite in the final effluent to a maximum level of <10 g NaOCl per  $m^3$  of liquid effluent (treated waste water) discharged to a local watercourse – see Sections 5.3.1.2.2 and 5.4.1.5.
4. Application of dust removal techniques, including fabric filters, to reduce the content of particulate matter discharged to air to the range of <20 – 50 mg silica per  $m^3$  of outlet air – see Sections 5.3.1.2.1 and 5.4.3.

Note also, that pyrogenic silica dust is characterised by submicron particles, which are more difficult to collect from the gas stream – refer to Section 5.4.3.

5. The typical net consumption of steam and electricity in the range of 15 – 18 GJ per tonne of synthetic amorphous pyrogenic silica produced at a full rate of capacity utilisation of the production plant, including the hydrochloric acid absorption, but without any utility facilities, waste gas and waste water treatment, assuming tetrachlorosilane and hydrogen as the raw materials – see Sections 5.3.1.1.2, 5.3.1.3.1 and 5.4.1.4.

## 5.5.2 Synthetic amorphous precipitated silica and silica gel

1. Optimised design and operation of precipitated silica and silica gel liquid/solid separation, drying and dust collection systems, to achieve the desired product properties, to save energy and to reduce dust emissions – see Sections 5.2.2.2.4, 5.2.2.3.3, 5.2.2.4.2, 5.3.2.1.2, 5.3.2.2.1, 5.4.2.2 and 5.4.3.
2. Application of dust removal techniques, including fabric filters, to reduce the content of particulate matter discharged to air to the range of <math><10 - 20 \text{ mg silica per m}^3</math> of outlet air. For certain product grades, values of up to  $40 \text{ mg/m}^3$  are expected – see Sections 5.3.2.2.1, 5.4.2.2 and 5.4.3.
3. The typical net consumption of steam, electricity and natural gas in the range of 15 – 24 GJ per tonne of synthetic amorphous precipitated silica or silica gel produced at a full rate of capacity utilisation of the production plant without any utility facilities, waste gas and waste water treatment, assuming an aqueous sodium silicate solution (water glass) and mineral acid as the raw materials – see Sections 5.2.2.4.2, 5.3.2.1.2 and 5.4.2.2.



## 6 INORGANIC PHOSPHATES

### 6.1 Introduction

The main applications of inorganic phosphates (volume-wise) are in:

- fertilisers
- animal feeds: calcium phosphates, in particular dicalcium phosphate (DCP), and other phosphates
- detergents, in particular sodium tripolyphosphate (STPP)
- human food or pharmaceutical ingredients: in particular sodium tripolyphosphate (STPP), other sodium phosphates and other non Na-phosphates, based on different cations.

The application of inorganic phosphates as fertiliser is addressed in the BREF on Large Volume Inorganic Chemicals – Ammonia, Acids and Fertilisers (LVIC – AAF), whereas this document covers the production of the latter three groups of inorganic phosphates, in the following order:

- detergents phosphates in Section 6.2
- food phosphates in Section 6.3, and
- feed phosphates in Section 6.4.

Food phosphates are addressed briefly in Section 6.3, but in fact the production of food phosphates, which are manufactured from either purified phosphoric acid or thermal route pure phosphoric acid, is only dealt with separately in this document to a limited extent.

STPP is not only the main detergent-grade inorganic phosphate, but also the largest volume food-grade inorganic phosphate produced in Europe. The production process of food-grade STPP is similar to that for detergent-grade STPP by the purified acid route, and it is, therefore, covered in Section 6.2.

In general terms, all inorganic phosphates can be seen as mostly derived from phosphate rock,  $\text{Ca}_5(\text{PO}_4)_3\text{F}$ .

The process from phosphate rock to final product may schematically be seen to involve four major steps:

- dissolution of phosphate from the rock to yield phosphoric acid
- purification of phosphoric acid to a varying degree of purity
- neutralisation of phosphoric acid by reaction with sodium, calcium, ammonium and/or other ions to produce the required inorganic phosphate
- dehydration, drying or calcination plus optional finishing to give a product in the required form (eg. dry powder).

These steps may be carried out in one location, but quite commonly intermediate products are used as the starting material for downstream steps. Therefore, when comparing several production routes to manufacture a given inorganic phosphate product it is important to consider the different strategies, process boundaries and starting points of the production.

It should be stressed, that all European phosphate production sites manufacture a range of different inorganic phosphate products (e.g. different sodium phosphates including STPP, calcium phosphates, and other phosphates), sometimes covering a range of products for one type of application (industrial, detergent, animal feed, human food), and sometimes covering several applications for inorganic phosphates which are chemically similar products.

The interrelationship between different sectors of the inorganic phosphates industry are shown in Figure 6.1 below, whereas the key steps are described in the following paragraphs.



Phosphoric acids of various degrees of purity are available as global merchant commodities or, in some cases, can be produced at the same site where both acid purification installations and inorganic phosphate production plants are situated. Operators will purchase purified acid of the degree of purity required for the range of inorganic phosphates they are manufacturing, or will purify phosphoric acid onsite to the degree of purity required in downstream operations. Depending on the purity of the acid used, some sites can manufacture inorganic phosphates for different applications (detergent, animal feed, food).

A high purity phosphoric acid may also be obtained by the thermal route. White phosphorus, derived by thermal reduction from phosphate rock or other phosphate sources, is combusted in air, followed by the absorption of phosphorus pentoxide ( $P_2O_5$ ) in water (refer to the BREF on LVIC-AAF).

In general, this process route is seldom used in Western Europe for the production of detergent-grade STPP or for the production of inorganic feed phosphates, as the phosphoric acid produced from elemental phosphorus is of a high quality not necessary for detergent or animal feed applications.

Some inorganic phosphate products have a range of uses which require different levels of purity: for example STPP, which is used in detergents and cleaning products, but also as a human food and pharmaceutical ingredient which requires higher grades of purity.

In some cases, the same installation can be used to manufacture an inorganic phosphate product for various purposes; different quality grades being achieved by using different quality feedstocks (phosphoric acid or phosphate rock of different levels or purity) and/or by additional purification steps operated optionally within the production process.

Purified phosphoric acid is also used as the base for the manufacture of a wide variety of other products containing phosphorus [87, Ullmann's, 2001]. Examples of the areas in which technical products containing phosphorus are used, are shown in Table 6.1.

Industrial cleaning	Car wash, food premises, other cleaning
Toiletry products	Dentifrice, other cleansers
Pharmaceuticals	Intermediates; supplements and buffers
Water and waste water industries	
Metals industries	Surface cleaning, treatments, anticorrosion agents; extraction and refining
Textile production, washing	
Paint manufacture	
Flame-retardants	
Oil industry	Lubricant additives
Ceramics, clay	Ceramics, clay
Paper industry	

**Table 6.1: Examples of technical products containing phosphorus**  
[92, EU DG Environment, 2002]

## 6.2 Detergent phosphates

### 6.2.1 General information

Sodium phosphates are a family of salts prepared from phosphoric acid and sodium hydroxide or sodium carbonate. According to the molar ratio  $Na_2O/P_2O_5$  and to the process conditions, substances with variable acidity and variable molecular weight are obtained. These are principally applied as dispersing agents (food, drilling, muds, cement, pulp and paper) or as sequestering agents (cooling water systems, detergents).

The information given in Section 6.2.1.1 focuses on the production of sodium tripolyphosphate (STPP), which is used for laundry detergent powders, for automatic dishwashers powders and industrial detergents [6, CEFIC, 2002].

Detergents are substances or preparations containing, among other things, soap and/or other surfactants intended for water-based laundry or dishwashing processes. Detergent products may be of any form (liquid, powder, paste, bar, cake, moulded piece, shaped, etc.) and be used for household, institutional or industrial purposes. The function of detergents is to wash and/or clean laundry, fabrics, dishes or kitchen utensils, as well as hard surfaces.

A detergent is a combination of various ingredients for a specific function, depending on the purpose to be achieved, the material to be cleaned, the properties of the water, and so on. A detergent formulation may also differ from one region to another depending on the washing habits of the population [92, EU DG Environment, 2002].

Worldwide, STPP is used as a detergent builder more than zeolites: 4.7 million tonnes compared to 1 million tonnes or somewhat more. Zeolites are used in the US, Canada, Japan, Switzerland and much of the EU-15, while STPP is predominantly used in laundry detergents mainly in the rest of the world. Zeolites cannot be used in dishwasher detergents.

The new European detergents regulation (Regulation EC No. 648/2004), published on 8 April 2004 (OJ L 104, 8,4,2004, p 1), among others in its Article 16 calls on the Commission to evaluate by 8 April 2007, submit a report on and, where justified, present a legislative proposal on the use of phosphates with a view to their gradual phase-out or restriction to specific applications [97, The Council of the EU, 2004].

As illustrated in Table 6.2, detergent-grade STPP is currently manufactured in six locations in Western Europe.

Location	Country	Maximum detergent STPP capacity (kt per year)
Huelva (plant 1)	Spain	150
Huelva (plant 2)		150
Engis	Belgium	130
Vlissingen	The Netherlands	165
Ladenburg	Germany	30
Budenheim		30
<b>Six locations</b>	<b>Four Member States</b>	<b>655</b>
Note: This table does not include capacities for the production of food grade STPP		

**Table 6.2: CEFIC data on West European STPP manufacturing capacities (2004)** [92, EU DG Environment, 2002], [85, EIPPCB, 2004-2005]

As sodium tripolyphosphate, STPP,  $\text{Na}_5\text{P}_3\text{O}_{10}$ , is the main inorganic phosphate present in detergents, the remaining part of this section addresses the production of detergent-grade STPP.

### 6.2.1.1 Production of detergent phosphates (STPP)

For the production of STPP, it is vital to have a low amount of impurities present in the starting materials. Caustic soda and soda ash are normally pure, but the most widely available form of phosphoric acid, the so-called green acid, is contaminated to a considerable extent with fluoride and metals such as magnesium, iron and aluminium. It also contains excess sulphuric acid from the production stage. Green acid is produced from phosphate rock by sulphuric acid attack (refer to the BREF on LVIC-AAF). Impurities in green acid need to be removed before the STPP is produced. There are two ways of doing this, which give rise to two distinct production routes towards the feedstock orthophosphate solution for the proper STPP process.

These two routes are:

1. Production of STPP feedstock starting directly from non-purified green acid.
2. Production of STPP feedstock from phosphoric acid purified by solvent extraction or from thermal phosphoric acid, both of which are global market commodities [85, EIPPCB, 2004-2005].

Thermal phosphoric acid, produced from elemental phosphorus (obtained directly from phosphate rock by the thermal reduction process), can also be used as a feedstock for non detergent-grade STPP production. Offering high purity, it is only used for some food (food-grade STPP) or some special technical applications.

#### **6.2.1.1.1 Production of STPP feedstock from non-purified green acid**

In this process, the green acid is treated to remove sulphuric acid, and then neutralised by caustic soda or soda ash, causing the remaining impurities to precipitate. These are filtered off as a cake. In this process route the first step of STPP production also ensures the purification of the acid in the same reaction. The filtrate is then concentrated, yielding a largely purified orthophosphate solution comparable to that obtained under (2), but the purification, as operated today, is not sufficient to produce food grade quality phosphates without further steps. This process route therefore currently results in STPP of a technical grade for use in detergents.

#### **6.2.1.1.2 Production of STPP feedstock from purified phosphoric acid**

This section relates to the production of STPP feedstock from green phosphoric acid, which has been purified by solvent extraction and concentrated. This purification and concentration takes place in a dedicated unit, on the same site as the STPP production or elsewhere (for example, in the country of the phosphate rock extraction). An alternative way towards very pure phosphoric acid, among other applications also used for the production of food STPP, is the combustion of elemental phosphorus. The process route to a very pure phosphoric acid is covered in the BREF on LVIC-AAF (refer also to Section 6.3). For both types of acids, a simple mixing step with caustic soda or soda ash ensures the desired neutralisation, yielding concentrated sodium hydrogen orthophosphate solution used in the second step of the STPP production. The process route based on purified phosphoric acid (depending on the degree of purification achieved) results in STPP suited for use both in food and/or detergents.

#### **6.2.1.2 Comparison of the two process routes to produce STPP**

The above-mentioned two process routes for the production of STPP use different raw materials (green or purified phosphoric acid) and result in different grades of STPP, and hence cannot be compared in terms of the overall emissions, energy consumption, etc. Lower on-site energy consumption, emissions, and waste streams for the purified acid route are largely the consequence of the fact that relevant emissions occur upstream in the acid purification step.

The STPP resulting from route (2), using fully purified phosphoric acid as a raw material, is of food grade quality and corresponds to purity requirements for use as an additive in human and animal food products, however, it can also be used in detergent applications.

The STPP resulting from route (1) as operated today, is non-food grade quality and is used for detergent applications. Route (2) thus currently offers the advantage of commercial flexibility for plant operation/product applications, whereas route (1) has the advantage of not purifying the product more rigorously than is necessary for detergent applications. It is also possible to operate route (2) with a less complete purification process to produce only (non-food purity) detergent-grade STPP, and processes may be developed in the future to obtain food purity STPP from route (1).



Purified phosphoric acid is a global market commodity a large part of which is used for products other than STPP (technical phosphates such as flame-retardants, animal feeds, food phosphates other than STPP – refer also to Sections 6.3 and 6.4).

As described above, purified phosphoric acid can be manufactured either from green acid (using solvent extraction or other purification processes) or from elemental phosphorus (produced directly from phosphate rock by the thermal reduction process). For economic and environmental reasons, the comparatively high cost, high energy input elemental P route is mainly reserved for the manufacture of industrial P chemicals other than phosphoric acid. Elemental phosphorus is also converted to high-purity phosphoric acid which may be used for the manufacture of food grade and other high purity phosphates. Since pure phosphoric acid is a market commodity on its own, its production is included in the BREF on LVIC-AAF. A comparison of the overall emissions, waste production and energy use for the two above-mentioned production routes towards STPP would necessarily have to include the acid purification process, and take the common starting material green acid as a reference point for such an evaluation.

Therefore, this section, relating to STPP production, addresses both:

- (1) production of detergent-grade STPP directly from green acid, and
- (2) production of detergent and food grade STPP, using purified phosphoric acid as a raw material (refer also to Section 6.3).

Such a definition of boundaries for the STPP production process, corresponds to the commercial and technical realities of industry and plant structure, covering those unit operations which are dedicated solely to the production of STPP [93, CEFIC-CEEP, 2004].

For the outline of boundaries of the production process of STPP refer to Figure 6.1 above.

## 6.2.2 Applied processes and techniques

### 6.2.2.1 General description of the STPP production process

Phosphates – (and more precisely defining orthophosphates discussed here, which are the salts of orthophosphoric acid  $\text{H}_3\text{PO}_4$  – refer to Annex 1 – Basic classes of inorganic compounds) – are phosphorus compounds containing the  $\text{PO}_4^{3-}$  anion in which each phosphorus atom is surrounded by four oxygen atoms located at the apices of a tetrahedron.

The basis of orthophosphates is the simple tetrahedron  $\text{PO}_4^{3-}$  monomer unit. This group of compounds includes monosodium phosphate (MSP,  $\text{NaH}_2\text{PO}_4$ ), disodium phosphate (DSP,  $\text{Na}_2\text{HPO}_4$ ) and trisodium phosphate (TSP,  $\text{Na}_3\text{PO}_4 \cdot \frac{1}{4} \text{NaOH} \cdot 12 \text{H}_2\text{O}$ ). These sodium salts are obtained from neutralising purified phosphoric acid (i.e. orthophosphoric acid) by adjusting sodium carbonate or sodium hydroxide, in adequate molecular proportions.

If the orthophosphates MSP or DSP are heated, the  $\text{PO}_4^{3-}$  orthophosphate units are condensed, forming short or long chains with P-O-P bonds. Each  $\text{PO}_4^{3-}$  tetrahedron now shares oxygen atoms with its neighbours. From DSP a maximum of two units can be produced (pyrophosphate,  $\text{P}_2\text{O}_7$ ), whereas MSP can yield very long chains. Using either of these or a mixture of the two, any desired chain length may be obtained. Sodium tripolyphosphate, (STPP,  $\text{Na}_5\text{P}_3\text{O}_{10}$ ) is the most important of these condensed phosphates. In STPP, three  $\text{PO}_4^{3-}$  units are linked together.

To produce STPP, an orthophosphate solution with a mixture of MSP and DSP is needed, with a molar Na:P ratio of 5:3. This corresponds to an MSP: DSP ratio of 1:2. This solution is then heated to produce the tripolyphosphate salt, either directly in a spray tower or via an intermediate step of drying orthophosphates. Any STPP process contains these two steps: make-up of the solution, and then calcining orthophosphates to form STPP.

Sodium tripolyphosphate (STPP) is used as a builder in powder detergents, acting as a sequestering agent to trap calcium and magnesium in washing batch from water hardness and dirt, thereby allowing detergent surfactants to work – refer also to [92, EU DG Environment, 2002].

In order to make STPP, phosphoric acid and a source of sodium oxide, usually caustic soda (NaOH) or soda ash (Na<sub>2</sub>CO<sub>3</sub>), are needed.

The most readily available phosphoric acid of adequate quality, is green acid – one of the most abundantly available chemicals. This is produced from phosphate rock by attacking it with sulphuric acid (refer to the BREF on LVIC-AAF). The resulting acid contains most impurities from the rock, the most notable of which are fluoride, magnesium, iron, and aluminium. Also, some of the sulphuric acid needed for its production is still contained in the acid.

Whereas these impurities allow the production of fertilisers from green acid (by far the most important application of green acid) without its further treatment, they need to be largely eliminated in order to produce detergent-grade STPP. For food grade quality STPP, the purity requirements are even more rigorous [84, A. Davister, 1981].

Green acid, initially produced from phosphate rock, contains around 25 – 30 % P<sub>2</sub>O<sub>5</sub>. Before being transported and sold on the world market, it is usually concentrated to around 52 – 54 % P<sub>2</sub>O<sub>5</sub>, i.e. ‘Merchant Grade Acid’ (MGA).

One way to obtain the required acid purity is to clean green acid in an extraction process. In such a process, the green acid is put into contact with a solvent in a series of steps. The acid is mixed with the solvent and is then re-extracted from the solvent-acid mixture into water. Most impurities remain in the so-called raffinate stream, which also retains a part of the acid.

Since this process requires the addition of water, the cleaned product stream needs to be concentrated. The resulting purified phosphoric acid is sold for many applications. Depending on the type of purification process used and purification level, the acid is now suitable either for the production of detergent-grade STPP or for the production of both food and detergent-grade STPP (refer to Figure 6.1).

Another route towards STPP takes green acid as feedstock. The process takes advantage of a side effect, since the phosphoric acid needs to be neutralised with soda ash or caustic soda anyway. When this is done, the resulting increase of the pH value of the solution causes many impurities to precipitate. These are filtered off, yielding a largely purified orthophosphate solution. Since the precipitation process requires the addition of water for dilution and cake washing, the solution needs to be concentrated before it is fed into the STPP calcination step. The quality of the STPP derived from this route is not sufficient for application in foodstuffs without further process steps, and therefore this STPP is detergent-grade only.

For this route in which unpurified green acid is used as a feedstock, either concentrated (MGA) green acid can be used, if acid is being purchased or transported from outside the STPP production site, or the non-concentrated green acid derived directly from phosphate rock, if the phosphoric acid process is being operated at the site within an integrated chemical complex. Depending on the process route used, the energy consumption of the STPP process will vary considerably as a function of the concentration of the green acid raw material.

For both processes, the sulphate contained in the green acid is not removed sufficiently by the cleaning routes. Therefore, both routes usually have a separate sulphate removal step before the cleaning operation. Although both routes may somewhat differ with the technology applied, they contain the same key steps, i.e. sulphate removal, removal of the other impurities, and concentration.

As noted in Section 6.2.1.1 above, the purification of acid by extraction yields a pure concentrated phosphoric acid market product, which also has a wide range of applications other than only STPP. This route is, therefore, excluded from this document. The precipitation route, on the other hand, is dedicated solely to the production of STPP and is, therefore, included here (refer to Figure 6.1 in which the borderline limits of the production process of STPP are indicated by the dotted line).

Figure 6.2 illustrates process steps applied in STPP production. These relate to the process routes presented in Figure 6.1.

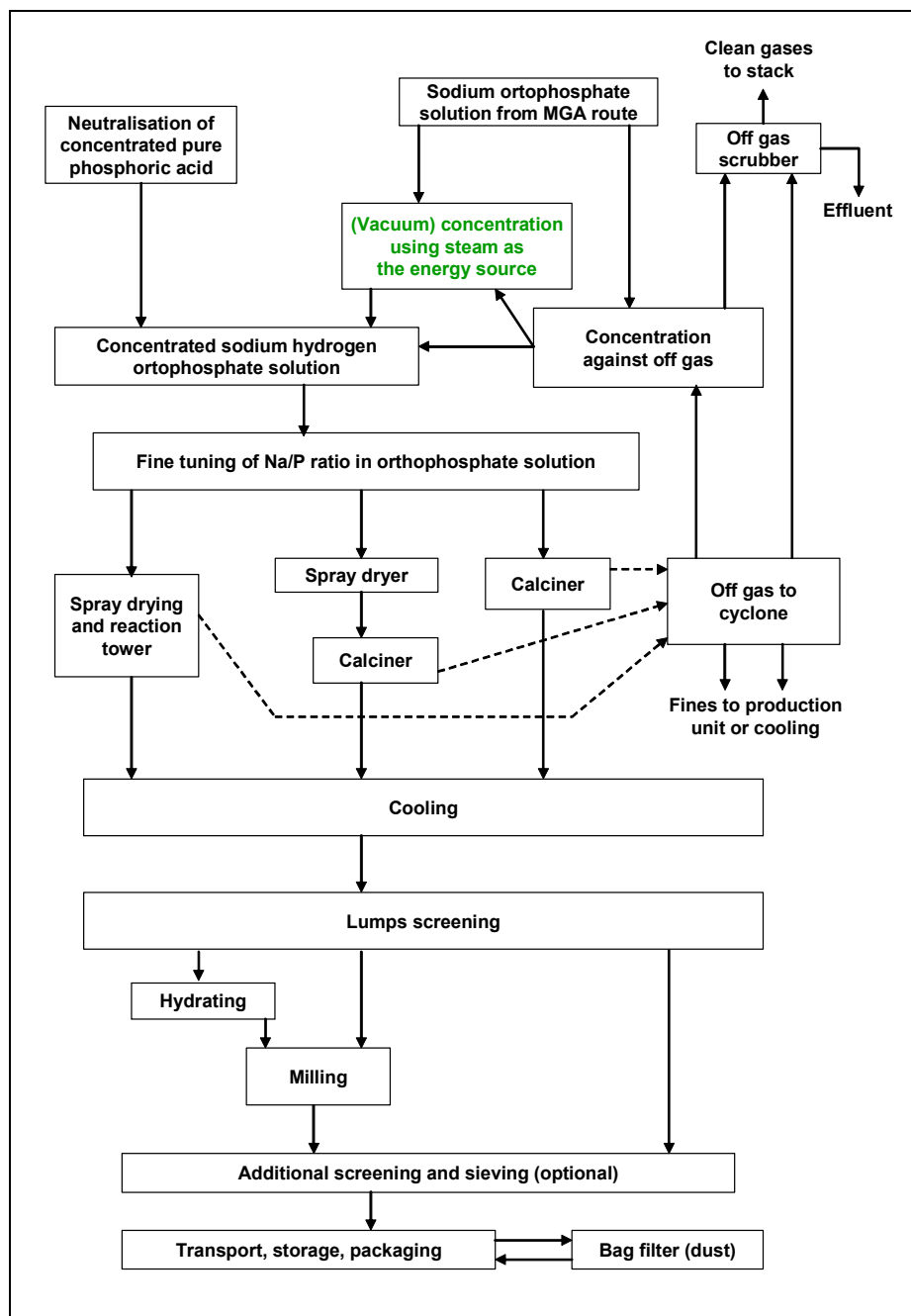


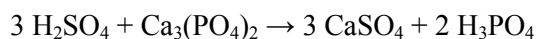
Figure 6.2: Process routes and process steps applied in STPP production [93, CEFIC-CEEP, 2004]

The application of an off-gas scrubber, an off-gas cyclone, and a bag filter in this process is not universal.

### 6.2.2.2 Process route: from green acid to sodium orthophosphate solution

#### 6.2.2.2.1 Pretreatment of the green acid

The purpose of the pretreatment or purification step is basically to eliminate the sulphuric acid related impurities formed during the manufacture of phosphoric acid. This is done by adding lime, phosphate rock or recycled calcium phosphates. The main precipitate is calcium sulphate (gypsum) as well as minor amounts of precipitates of other metals in the form of complex fluorinated compounds. Organic matter may be removed at the same time by adding activated charcoal. The main reaction in this step is as follows:



The precipitate is separated by settling and filtering operations. The resulting product is a sulphate-depleted green acid which is then processed in the neutralisation (second and main purification) step.

#### 6.2.2.2.2 Neutralisation of the pretreated green acid

The process scheme of green acid neutralisation and purification is given in Figure 6.3. The application of off-gas treatment in this process is not universal.

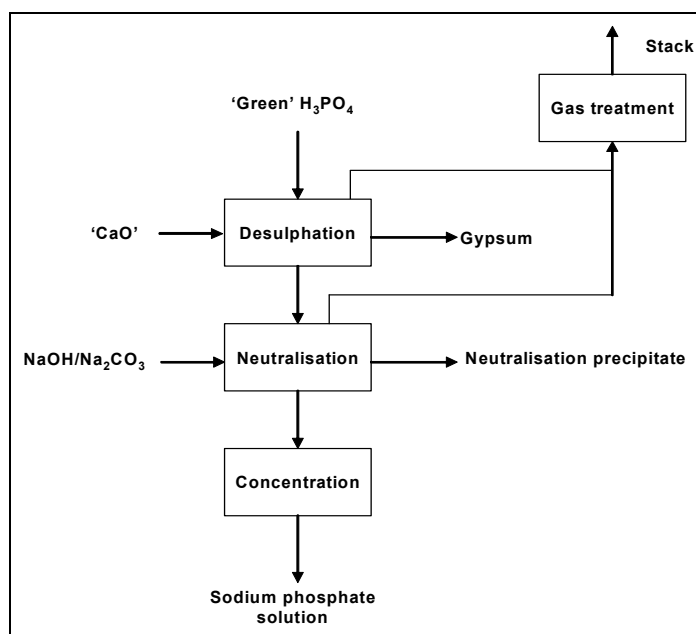


Figure 6.3: The process scheme – green acid neutralisation and purification [93, CEFIC-CEEP, 2004]

The neutralisation step involves the addition of sodium hydroxide or carbonate to the pretreated green acid, in order to obtain a Na:P molar ratio of around 5:3, i.e. the final proportion of these elements in STPP. The choice of which type of alkali to add depends on market availability. When sodium hydroxide is used, it comes with a water content of 50 %, leading to higher energy consumption during the concentration step.

Neutralisation/precipitation is performed in several steps to improve both the P<sub>2</sub>O<sub>5</sub> yield and to eliminate impurities. The exact process setup used depends on the nature and amount of the impurities in the green acid. The amount of precipitated cake also depends on this. Most of the impurities originate from the phosphate rock used to produce the green acid, which varies considerably in composition from source to source.

The phosphoric acid is converted into an orthophosphate solution with an adequate Na:P molar ratio, that increases from the first step to the second. In these two neutralisation steps, certain precipitates are formed and then eliminated by the corresponding filtration operations that are usually carried out with rotary, or press filters. Additional treatment of the cake may take place.

The filter cakes that are finally obtained, with usually less than 20 %  $P_2O_5$  and a variable fluorine content, consist of insoluble metal phosphates and complex metal fluorine compounds, which imply an important elimination of impurities coming from the initial raw material. This residue may be moved to decanting ponds together with the gypsum obtained during the purification step, or may be used elsewhere. The resulting filtrate, i.e. the sodium orthophosphate solution, is passed on for clarification. The intermediary product is a dilute pure sodium orthophosphate, composed of monosodium and disodium phosphate in a molar ratio of 1:2.

### **6.2.2.2.3 Concentration of the sodium orthophosphate solution**

The concentration step entails eliminating the water content of sodium orthophosphate to convert it into concentrated orthophosphate, increasing the concentration from an initial  $P_2O_5$  level of about 18.5 % to 29 – 31 %. This is necessary to ensure a smooth operation in the next step (either in a calcination kiln or a spray tower).

If virgin steam is used in the concentration step, it may be performed in single, double or triple action evaporators, the latter unit being the most energy efficient. Alternatively, various sources of heat available locally may be used, such as calciner off-gas from the next process stage.

### **6.2.2.3 Process route: from purified acid to orthophosphate solution**

#### **6.2.2.3.1 Neutralisation of the purified acid**

Since the acid used in this route is already purified, this step consists of a simple acid-based reaction, the chemistry which is equivalent to the process described in Section 6.2.2.2.2, but no cakes are formed and the addition of water is not required. The neutralisation step involves the addition of sodium oxide in the form of hydroxide or carbonate, in order to obtain a Na:P molar ratio of around 5:3, which is the final proportion of these elements in STPP.

The choice regarding which type of sodium oxide to add depends on market availability (refer to Section 6.2.2.2.2). The neutralisation is performed in batch in two steps. In the first one, the pre-neutralisation, a sodium phosphate solution with a Na:P molar ratio of about 1:6 is produced. Subsequently, this solution is transferred to the one of two post-neutralisation reactors where its molar ratio is finely adjusted to 1:666. This operation is performed by several additions of sodium hydroxide or phosphoric acid. It is continuously monitored by an online analyser. The resulting product is a concentrated pure sodium orthophosphate solution with a monosodium to disodium phosphate molar ratio of 1:2.

### **6.2.2.4 Process route: from orthophosphate solution to STPP**

#### **6.2.2.4.1 Calcination**

In this step, the orthophosphate solution is dried to form orthophosphates solids. These are further treated to achieve poly-condensation. It is possible to perform these steps in one operation; other process setups have two separated steps. Usually the process is continuous.

The chemistry of the calcination process for manufacturing STPP is based on a condensation reaction of a blend of one molecule of MSP and two of DSP, which releases two molecules of water to form STPP. When this blend of phosphates is heated to between 300 and 500 °C for a length of time and then slowly cooled, all of the product will be in a tripolyphosphate form.

The calcination step is based on the following reaction:



It is possible to use either a spray tower or a rotary kiln to perform the drying and condensation steps.

Possible STPP plant setups are:

- a single rotary kiln, where hot orthophosphate solution is pumped in at one end of the kiln. Along the length of the kiln there is an evaporation area, a drying area and a calcination area, with the solution running cocurrently with, or countercurrently to, the flow of the hot gases entering the kiln. The ortho-solution evaporates when moving through the kiln, and at about the halfway point becomes a risk by forming a cake that can adhere to the inner surface of the kiln, initiating significant problems. This risk is minimised through maintaining the adequate gradient of temperature, as well as by the geometry inside the kiln and a set of hammers that tap the outside of the casing, so that the new product is granulated over the circulating bed and can be carried into the calcination area. Both, the setups with a single pass and a solids recirculation are known. The kiln may be extended with an ageing container, ensuring that the reaction to STPP is complete
- a spray tower for the drying of the ortho-solution, where the solution is atomised in hot gases, ensuring the solution drying to powder, followed then by calcination in a rotary kiln where the dry sodium orthophosphate is converted into STPP. The kiln is fed with dry solids which are taken out of the spray tower. Also here, an ageing step may be included after the kiln
- a spray tower where the solution is dried and the solids are poly-condensed (calcined) in the tower itself, thereby performing the process in essentially one step in only a spray tower. A proper residence time in the bottom of the tower at elevated temperatures ensures full ageing towards STPP.

Depending on the setup of the STPP plant, fine or coarse powders, or a granular product are obtained. Single rotary kiln setups may include circulation of its contents through both milling and screening steps, if necessary. Natural gas is used as a fuel in most cases, although other combustible gases can be used when locally available and when their usage is more practicable than that of natural gas.

Downstream of these calcination or atomisation/calcination process steps, cyclones may remove residual solids from the gas stream, and a scrubber system is used to scrub stack gases that may contain fluorides, orthophosphate droplets, or fine particles/aerosols of orthophosphate and STPP. The wash-water of this scrubber system can be used for the production of the purified sodium orthophosphate solution.

The off-gas heat can optionally be used to concentrate the incoming orthophosphate solution.

Calcination can be performed at varying temperatures, that determine which of the two crystallographic phases (I or II) of STPP are formed. Higher temperatures give rise to a higher phase I content. Both have their own specific fields of application, differing mainly in the behaviour of the STPP during slurring/dissolution in subsequent applications.

Pieces of off-spec product may be recycled back into the process as solids or through the solution.

#### 6.2.2.4.2 Cooling and hydration

In all three process options, the ageing step is followed by a cooling step. This may take place in a water-cooled rotary drum or a cooler with an airflow. The final STPP product exits at a temperature of about 40 – 80 °C.

The STPP may also be hydrated by the addition of demineralised water during or after these process steps. The hydration enables conversion of a part of the phase I or phase II product into STPP hexahydrate, which improves STPP performance in a number of detergent applications (increased rate to dissolve).

#### 6.2.2.4.3 Milling and screening

After cooling, and the optional hydration step, the product may be milled or screened to obtain various particle sizes. The milled and screened STPP product is transported either pneumatically or by a belt conveyor to the storage silos and then into suitable containers or packaged in bags. To prevent the release of dust into the atmosphere, a cyclone and bag filter system is used to retain any particles and ensure that dust emission requirements are met.

### 6.2.3 Present consumption and emission levels

The principal environmental aspects and contaminating agents generated in the production process of sodium tripolyphosphate according to the process routes analysed above, are illustrated in the following Sections 6.2.3.1, 6.2.3.2 and 6.2.3.3.

#### 6.2.3.1 From green acid to orthophosphate solution

Step	Environmental problem	Effect
Desulphation	Consumption	Reagents: phosphoric acid and calcium oxide/hydroxide/phosphate Optional secondary reagents: activated charcoal Electrical power: mixers and pumps
	Atmospheric contamination	Off-gases: fluoride vapours and orthophosphate solution droplets
	Liquid waste	-
	Solid waste	Gypsum (calcium sulphate precipitate)
	Noise contamination	Not quantified
Neutralisation and filtration	Consumption	Reagents: desulphatised green acid and sodium carbonate and/or caustic soda Optional secondary reagents: additives (anti-foaming agents, activated charcoal if used, filtering agents) Electrical power: mixers and pumps
	Atmospheric contamination	Phosphate solution droplets or dust particles
	Liquid waste	-
	Solid waste	Cakes with an insoluble phosphate content, paper bags for activated charcoal if used, used filtering fabric, bags for other additives
	Noise contamination	Not quantified
Concentration	Consumption	Reagents: dilute sodium orthophosphate Secondary reagents: Energy: steam and electric power or other locally available secondary heat
	Atmospheric contamination	
	Liquid waste	Optional: cooling water
	Solid waste	
	Noise contamination	Not quantified

**Table 6.3: Environmental aspects – STPP process: from green acid to orthophosphate solution [93, CEFIC-CEEP, 2004], [85, EIPPCB, 2004-2005]**

### 6.2.3.2 From purified acid to orthophosphate solution

Step	Environmental problem	Effect
Neutralisation	Consumption	Reagents: purified phosphoric acid and sodium carbonate and/or caustic soda Secondary reagents and additives: sodium nitrate Energy: - steam - electrical power: mixers and pumps
	Atmospheric contamination	-
	Liquid waste	-
	Noise contamination	Not quantified

**Table 6.4: Environmental aspects – STPP process: from purified acid to orthophosphate solution [93, CEFIC-CEEP, 2004]**

### 6.2.3.3 From orthophosphate solution to STPP

Step	Environmental problem	Effect
Calcination (atomisation) Ageing and cooling	Consumption	Reagents: concentrated sodium orthophosphate solution Secondary reagents: oxidants (optional) Energy: natural gas or fuel, and electric power (oven, fans, pumps)
	Atmospheric contamination	STPP particles, fluorides, CO <sub>2</sub> , NO <sub>x</sub> , SO <sub>x</sub>
	Liquid waste	Optional: scrubber effluent
	Solid waste	-
	Noise contamination	Not quantified in decibels
Milling and packaging	Consumption	Reagents: sodium tripolyphosphate Electrical power: mills, vacuum, and conveyor belts/blowers
	Atmospheric contamination	Dust particles
	Liquid waste	
	Solid waste	Used bag filters
	Noise contamination	Not quantified in decibels

**Table 6.5: Environmental aspects – STPP process: from orthophosphate solution to dry STPP [93, CEFIC-CEEP, 2004], [85, EIPPCB, 2004-2005]**

### 6.2.3.4 Electricity consumption for the whole process – both routes

Electricity consumption in the whole process based on the green acid route and the purified acid route (from the acid to dry STPP) is given in Table 6.6 below.

Process route	Energy input	Units	Range
Green acid route	Electricity	kWh/tonne STPP dry	160 – 200
Purified acid route	Electricity	kWh/tonne STPP dry	90 – 180

**Table 6.6: Electricity consumption in the whole process based on the green acid route and the purified acid route (from the acid to dry STPP) [93, CEFIC-CEEP, 2004]**

In turn, the inputs and emissions relating to the production of STPP are given in the following Sections 6.2.3.5, 6.2.3.6 and 6.2.3.7 below, in which data are consequently split to two optional process routes leading to orthophosphate solution, followed by the final process part leading from orthophosphate solution to the dry STPP product.



### 6.2.3.5 Consumptions and emissions: green acid to orthophosphate solution

Consumption	Units	Range	Concentration of gaseous emissions
'Green' phosphoric acid	P <sub>2</sub> O <sub>5</sub> equivalent in kg/tonne STPP dry	580 – 605	
NaOH/Na <sub>2</sub> CO <sub>3</sub>	NaOH equivalent in kg/tonne STPP dry	570 – 600	
Electricity	kWh/tonne STPP dry	See Table 6.6	
Heat energy/steam ***	GJ/tonne STPP dry	1.1 – 5.1	
Cooling water +	m <sup>3</sup> /tonne STPP dry	0 – 0.5	
Process water +	m <sup>3</sup> /tonne STPP dry	0 – 4	
<b>Other ingredients</b>			
Active carbon	kg/tonne STPP dry	<1	
Calcium oxide *	kg CaO equivalent per tonne STPP dry	10 – 26	
Sulphides		Data confidential	
<b>Product: Sodium orthophosphate solution fed into next process stage</b>			
<b>Emissions</b>			
<b>Solid emissions</b>			
Gypsum cake (sulphates)	kg dry matter/tonne STPP dry	40 – 80	
Cake of other impurities	kg dry matter/tonne STPP dry	65 – 150	
<b>Gaseous emissions</b>			
CO <sub>2</sub> **	kg/tonne STPP dry	0 – 335	0 – 765000 mg/Nm <sup>3</sup> <sub>dry</sub>
Fluorine	kg/tonne STPP dry	<0.2	4.5 – 20 mg/Nm <sup>3</sup> <sub>dry</sub>
Phosphate	kg/tonne STPP dry	<0.05	10 – 33 mg/Nm <sup>3</sup> <sub>dry</sub>
Sulphides	kg/tonne STPP dry	Not quantified	0.8 – 1 mg/Nm <sup>3</sup> <sub>dry</sub>
* Calcium oxide is usually input as limestone or in phosphate rock, depending on the process route			
** Emissions of CO <sub>2</sub> depend on the use of Na <sub>2</sub> CO <sub>3</sub> as the neutralisation agent as opposed to the use of NaOH			
*** Energy consumption will depend directly on the concentration of green acid being used as a raw material and on the concentration of orthophosphate solution being produced as an output, and therefore varies widely			
+ 'zero' figures for cooling and process water consumption correspond to the recycling of these waters in closed systems or their re-use in gas scrubbers or other installations related to STPP production or elsewhere in integrated sites			

**Table 6.7: Consumption and emissions levels – green acid to orthophosphate solution**  
[93, CEFIC-CEEP, 2004], [85, EIPPCB, 2004-2005]

### 6.2.3.6 Consumptions and emissions: purified acid to orthophosphate solution

Consumption	Units	Range
Purified phosphoric acid	kg P <sub>2</sub> O <sub>5</sub> /tonne STPP dry	581 – 588
NaOH/Na <sub>2</sub> CO <sub>3</sub>	NaOH equivalent in kg/tonne STPP dry	545 – 550
Electricity	kWh/tonne STPP dry	*
Heat energy/steam ***	GJ/tonne STPP dry	0.6 – 0.8
<b>Product: Sodium orthophosphate solution fed into next process stage</b>		
<b>Gaseous emissions</b>		
CO <sub>2</sub> **	kg/tonne STPP dry	0 – 335
* See Section 6.2.3.4 above		
** Emissions of CO <sub>2</sub> depend on the use of Na <sub>2</sub> CO <sub>3</sub> as the neutralisation agent as opposed to the use of NaOH		
*** Energy consumption will depend directly on the concentration of purified acid being used as a raw material and on the concentration of orthophosphate solution being produced as output, and therefore varies widely		

**Table 6.8: Consumption and emissions levels – purified acid to orthophosphate solution**  
[93, CEFIC-CEEP, 2004]

### 6.2.3.7 Consumptions and emissions: orthophosphate solution to dry STPP

Consumption	Units	Range	Concentration of gaseous emissions
<b>Sodium orthophosphate solution from the above processes</b>			
Electricity	kWh/tonne STPP dry	◇	
Heat energy ***	GJ/tonne STPP dry	4.2 – 7.5	
Cooling water +	m <sup>3</sup> /tonne STPP dry	0 – 50	
Process water +	m <sup>3</sup> /tonne STPP dry	0 – 0.6	
<b>Additives</b>			
Oxidising agents *	kg/tonne STTP dry	<5	
De-foaming agents, filter aids	kg/tonne STTP dry	<5	
<b>Gaseous emissions</b>			
CO <sub>2</sub> **	kg/tonne STPP dry	250 – 465	30000 – 200000 mg/Nm <sup>3</sup> <sub>dry</sub>
CO	kg/tonne STPP dry	1 – 9.2	300 – 3600 mg/Nm <sup>3</sup> <sub>dry</sub>
VOC	kg/tonne STPP dry	0 – 2.4	1 – 2000 mg C/Nm <sup>3</sup> <sub>dry</sub>
Fluorine	kg/tonne STPP dry	<0.3	1 – 70 mg/Nm <sup>3</sup> <sub>dry</sub>
NO <sub>x</sub>	kg/tonne STPP dry	<1.1	50 – 250 mg/Nm <sup>3</sup> <sub>dry</sub>
SO <sub>2</sub>	kg/tonne STPP dry	0.02 – 0.4	1 – 35 mg/Nm <sup>3</sup> <sub>dry</sub>
P <sub>2</sub> O <sub>5</sub> droplets and dust	kg/tonne STPP dry	<0.5	30 – 190 mg/Nm <sup>3</sup> <sub>dry</sub>
Dust	kg/tonne STPP dry	<0.9	5 – 130 mg/Nm <sup>3</sup> <sub>dry</sub>
<p>* Different chemicals can be used as oxidising agents including sodium chlorate, sodium nitrate, etc.  **Actual CO<sub>2</sub> emissions will depend on the combustible used. For the purpose of this table, all combustibles are converted to CO<sub>2</sub> emissions calculated as equivalent to natural gas.  *** Energy consumption will depend directly on the concentration of orthophosphate solution used as a raw material (from previous processes), and this varies significantly  + 'zero' figures for cooling and process water consumption correspond to the recycling of these waters in closed systems or their re-use in gas scrubbers or other installations related to STPP production or elsewhere in integrated sites.  ◇ See Section 6.2.3.4 above.  Note: The nature and levels of aqueous discharge are largely a function of the proprietary gas cleaning (flue-gas scrubbing) systems installed. Aqueous streams are re-injected into the system (through, e.g. recycling of process water in scrubbers) before being treated in general integrated site water treatment systems.</p>			

**Table 6.9: Consumption and emissions levels – orthophosphate solution to dry STPP [93, CEFIC-CEEP, 2004], [85, EIPPCB, 2004-2005]**

Finally, it should be noted that the energy consumption and emissions resulting from orthophosphate and then STPP production based on the green acid route, are not comparable to those resulting from the STPP production based on the purified phosphoric acid route, since the purification of the acid, and hence emissions related to this step, have taken place upstream of the latter process, and therefore, they are outside the scope of this document – refer to Sections 6.2.3.1 through to 6.2.3.7 above.

## 6.2.4 Techniques to consider in the determination of BAT

This section sets out techniques considered generally to have potential for achieving a high level of environmental protection in the industries within the scope of the document. Management systems, process-integrated techniques and end-of-pipe measures are included, but a certain amount of overlap exists between these three when seeking the optimum results.

Prevention, control, minimisation and recycling procedures are considered as well as the re-use of materials and energy.

Techniques may be presented singly or as combinations to achieve the objectives of IPPC. Annex IV to the Directive lists a number of general considerations to be taken into account when determining BAT and techniques within this section will address one or more of these considerations. As far as possible a standard structure is used to outline each technique, to enable comparison of techniques and an objective assessment against the definition of BAT given in the Directive. The content of this section is not an exhaustive list of techniques and others may exist or be developed which may be equally valid within the framework of BAT.

Generally a standard structure is used to outline each technique, as shown in Table 6.10:

Type of information considered	Type of information included
Description	Technical description of the technique
Achieved environmental benefits	Main environmental impact(s) to be addressed by the technique (process or abatement), including emission values achieved and efficiency performance. Environmental benefits of the technique in comparison with others
Cross-media effects	Any side-effects and disadvantages caused by implementation of the technique. Details on the environmental problems of the technique in comparison with others
Operational data	Performance data on emissions/wastes and consumption (raw materials, water and energy). Any other useful information on how to operate, maintain and control the technique, including safety aspects, operability constraints of the technique, output quality, etc.
Applicability	Consideration of the factors involved in applying and retrofitting the technique (e.g. space availability, process specific)
Economics	Information on costs (investment and operation) and any possible savings (e.g. reduced raw material consumption, waste charges) also as related to the capacity of the technique
Driving force for implementation	Reasons for implementation of the technique (e.g. other legislation, improvement in production quality)
Example plants	Reference to a plant where the technique is reported to be used
Reference literature	Literature for more detailed information on the technique

**Table 6.10: Information breakdown for each technique described in this section**

Reference is to be made here also to Section 8.9, providing key information on the Environmental Management System (EMS) which is a tool for IPPC installations that operators can use to address the design, construction, maintenance, operation and decommissioning issues in a systematic demonstrable way.

Techniques broadly applicable in the chemical industry, described in the BREF on Common Waste Water and Waste gas Treatment/Management Systems in the Chemical Sector, are not included in this section (refer to the BREF on CWW).

### 6.2.4.1 Green acid pretreatment, neutralisation and purification

#### Description

The green acid purification step is characterised as having the largest environmental impact due to the generation of solid emissions.

These solid emissions occur inevitably in possibly different forms in any route from unpurified phosphoric acid (produced from phosphate rock) to phosphate products. The quantity and nature of the emissions depends firstly on the quality and nature of the phosphate rock (levels of impurities) and on the route from the rock through to phosphate products. As regards this document, for the route producing detergent STPP directly from green acid (refer to Section 6.2.1.1.1), the solid emissions will be generated and managed at the STPP production site, whereas for the route using purified phosphoric acid as the raw material (refer to Section 6.2.1.1.2), the emissions will be generated upstream at the site of production of the purified phosphoric acid.

However, since the route to the production of detergent STPP from purified phosphoric acid does not include the green acid purification step (the purification in this route is carried out upstream, with the associated solid emissions occurring at this upstream step, outside of the scope of this document), it is not possible to fully compare the two routes to produce detergent STPP (see Sections 6.2.1.1.1 and 6.2.1.1.2) and to evaluate the overall environmental impact relating to these routes in this document.

Therefore, the route for the green acid pretreatment by the desulphation and neutralisation of the green acid with NaOH/Na<sub>2</sub>CO<sub>3</sub>, resulting in the removal of impurities, is the only route included here (see Figure 6.1).

The neutralisation step involves the addition of sodium hydroxide or sodium carbonate to the pretreated green acid (see Section 6.2.2.2.2). Neutralisation/precipitation is performed in several steps to improve both the P<sub>2</sub>O<sub>5</sub> yield and to eliminate impurities. The filter cakes that are finally obtained, with typically less than 20 % P<sub>2</sub>O<sub>5</sub> and a variable fluorine content, consist of insoluble metal phosphates and complex metal fluorine compounds. This residue is usually moved to decanting ponds together with the gypsum obtained during the purification step.

The solid emissions are the sulphate cake (gypsum) and the precipitation cakes containing other impurities. The amount of cakes produced during the purification step depends on the amount of impurities in the green phosphoric acid and the setup of the precipitation section (the number of process steps, and the pH and acid concentrations in these). Each plant has its own dedicated, proprietary methods to deal with a certain green acid or a mixture of various grade phosphoric acids.

The resulting filtrate, i.e. the sodium orthophosphate solution, is passed on for clarification and then for concentration.

The gaseous emissions in this step are the ventilation/exhaust gases of the various reaction vessels in the purification plant (see Figure 6.3). These off-gases are cleaned in gas scrubbers.

#### Achieved environmental benefits

The green acid route (as in Section 6.2.1.1.1) for the production of detergent STPP has the advantage of integrating the purification and neutralisation steps and not purifying the acid to a level higher than necessary for detergent-grade product, and thus the overall environmental impact from the phosphate rock to detergent is optimised in this route.

However, direct comparison with the route consisting of the purification of acid followed by STPP production from purified acid (Section 6.2.1.1.2) is not possible, because on the one hand the purification process can have very varying environmental impacts and on the other hand it is not included in the scope of this document.

### Cross-media effects

The sulphate content in the green phosphoric acid is converted to gypsum, which can, in some cases and subject to appropriate process design and control, be used as a construction material. Other impurities extracted from the green acid are the precipitates, which are also solid wastes.

### Operational data

See data submitted in Table 6.3 through to Table 6.9.

### Applicability

Applicable to plants producing detergent-grade STPP by the green acid route.

### Economics

No data submitted.

### Driving force for implementation

The quality of the STPP produced.

### Example plants

Two detergent-grade STPP plants in Huelva, Spain

One detergent-grade STPP plant in Vlissingen, the Netherlands.

### Reference literature

[93, CEFIC-CEEP, 2004], [85, EIPPCB, 2004-2005].

## **6.2.4.2 Concentration of the sodium orthophosphate solution**

### Description

Where virgin energy sources are used onsite and the heat from other processes is not recycled, the second largest environmental impact relates to the step of the orthophosphate solution concentration. Here, the largest differences in energy consumption occur.

The concentration step may be performed with a source of secondary heat and either with single, double or triple action evaporators, the latter unit being the most energy efficient. The use of locally available waste heat is advantageous to keep energy consumption very low.

Table 6.11 gives characteristics of the techniques available for the concentration step of the orthophosphate solution.

Issue to be evaluated		Double action evaporator	Triple action evaporator	Other locally available secondary heat source
<b>Material consumption</b>	Raw materials	Orthophosphate solution	Orthophosphate solution (18 – 19 % P <sub>2</sub> O <sub>5</sub> )	Orthophosphate solution (18 – 19 % P <sub>2</sub> O <sub>5</sub> )
	Steam	0.70 – 0.75 kg/kg of evaporated water	0.56 – 0.60 kg/kg of evaporated water	None (uses other locally available waste heat)
	Air	-		
<b>Energy</b>	Energy efficiency	Medium-high	High	Very high
<b>Environmental aspects</b>	Atmospheric contamination	Fumes (some water vapour escape) Contaminated cooling water	Fumes -	None
	Liquid waste	-	-	-
	Noise contamination	-	-	-
	Solid waste	-	-	-
<b>Influence on final product quality</b>				
<b>Costs</b>	Investments	Medium-high	High	Medium-high
	Operating costs	Medium-low	Low	Low
	Total	Medium-high	High	Medium
<b>Previous experience</b>	Years on market			>30
	No. of applications	1	2	1

**Table 6.11: Techniques available for the orthophosphate solution concentration step [93, CEFIC-CEEP, 2004]**

The amount of energy required during the concentration step depends on the concentration of the orthophosphate solution (see Section 6.2.2.2.3).

If a steam/vacuum evaporator is used, the selection can be for a parallel flow system, a countercurrent flow system or a combination of these. In a parallel flow system arrangement, the solution passes from one evaporator to the next in the same direction as the steam. This has the advantage that, as pressure increases in the various evaporators, the solution flows from one evaporator to the next by the force of gravity.

The disadvantage is that the weakest (pressure) and coldest (temperature) steam must evaporate the most concentrated solution, and therefore, a greater vacuum is needed for each evaporator to achieve a sufficient rise in temperature for proper heat transfer. Pure condensates obtained from indirect steam contact in the concentration step can be utilised to produce steam. This setup may be desirable when the water balance of the process needs to be optimised. Alternatively a secondary heat source, available locally, can be used to concentrate the orthophosphate solution.

The use of other locally available heat to concentrate the solution does not yield a condensate and, even though the plant is optimised in terms of consumed energy, it is also a net consumer of water. The choice between the two options available will depend on local circumstances.

#### Achieved environmental benefits

Minimisation of the energy required for the concentration of the sodium orthophosphate solution and, hence, for the reduction of gaseous emissions resulting from the combustion of fuels.

#### Cross-media effects

No side effects reported.

### Operational data

As in Table 6.11 above. Refer also to data included in Table 6.3 through to Table 6.9.

### Applicability

To varying degrees, this technique is applicable for the plants producing STPP (see the number of applications in Table 6.11 above).

### Economics

Refer to data included in Table 6.11.

### Driving force for implementation

Energy efficient concentration of the sodium orthophosphate solution.

### Example plants

Two detergent-grade STPP plants in Huelva, Spain

One detergent-grade STPP plant in Vlissingen, the Netherlands.

### Reference literature

[93, CEFIC-CEEP, 2004].

## **6.2.4.3 Sodium tripolyphosphate calcination**

### Description

In this step, the orthophosphate solution is dried to form orthophosphates solids. These are further treated to achieve poly-condensation (refer to Section 6.2.2.4.1). It is possible to perform these operations in one step (either a spray tower or a rotary kiln); other process setups have two separated steps (a spray tower and a rotary kiln). The amount of energy consumed during the calcination step depends on the concentration of the incoming concentrated orthophosphate solution, and the temperature necessary to produce the product with the desired specifications.

The energy consumption for the evaporation of the remaining water plus the actual poly-condensation, are the major energy consumption parts of the calcination step. The average temperature at which STPP is produced, and the heat losses in the STPP plant setup are the main sources of variations in actual energy consumption. Dust particles (refer to Section 6.2.4.4) in the off-gas are the main emissions in this step.

### Achieved environmental benefits

Minimisation of the energy required for the calcinations of STPP and, hence, the reduction of gaseous emissions resulting from the combustion of fuels.

### Cross-media effects

Residual amounts of fluoride in the off-gas are the emissions in this step.

### Operational data

Refer to Section 6.2.2.4.1 and to data included in Table 6.3 through to Table 6.9.

### Applicability

To varying degrees, depending on a STPP plant configuration, this technique is applicable for the plants producing STPP.

### Economics

No data submitted.

### Driving force for implementation

The quality of the STPP product used in final applications.

Example plants

The STPP plants listed in Table 6.2 above.

Reference literature

[93, CEFIC-CEEP, 2004].

**6.2.4.4 Techniques available to control atmospheric emissions**

This section contains a concise techno-economic assessment of the techniques available to control and minimise atmospheric emissions from STPP manufacturing plants. Refer also to the information included in the BREF on Common Waste Water and Waste Gas Treatment/Management Systems in the Chemical Sector (CWW).

Table 6.12 gives characteristics of emission reduction techniques used in STPP plants.

Technique	Advantages	Disadvantages	Cost analysis	Comments
<b>Cyclones*</b>	Moderate pressure losses. Large space not required. Capable of working with high dust loads and in high pressure and temperature conditions. Available in a wide variety of materials	Low filtering efficiencies for particles below 3 microns (<25 %); problems may be encountered with abrasive particles	Low investment and operating costs, including maintenance	This technique is often used upstream of other, more costly and complex purification systems, for the purpose of eliminating larger particles
<b>Gas scrubber*</b>	High performance particle elimination	Medium or high energy and varying water consumption	Refer to the BREF on CWW	Wet or gas scrubbers are of the natural or forced draught type. The latter has a higher energy consumption
<b>Bag filter*</b>	Particle elimination efficiency >99 %. Dry operation	Higher energy consumption due to pressure losses; gas cooling systems are needed upstream of the filtration step (max temperatures 200 – 250 °C). Regular replacement of the bags needed	Low investment costs for simple designs or applications not requiring additional equipment. Maintenance costs (bag repair and replacement)	Costs depend on ancillary equipment requirements (gas cooler, scrubbers, etc.)
* See Section 8.2.3.7				

**Table 6.12: Characteristics of emission reduction techniques used in STPP plants [93, CEFIC-CEEP, 2004]**

Description**Cyclones**

The operating principle of this equipment is based on the utilisation of various types of mechanical action, in particular, centrifugal force that works on the particles to separate them from the gas stream. The effect is achieved by means of geometry and the type of intake, resulting in the flow patterns usually seen in these types of systems. Cyclones are composed of a cylindrical chamber that tapers downward towards the collected dust exit. Cyclones may be either conventional or high efficiency units. The latter have a smaller diameter, and therefore achieve a greater centrifugal effect. The final choice must be made by considering both the technical and economic aspects, as the higher efficiency units have higher pressure losses, which entails greater energy consumption.



Cyclones are used extensively and are normally connected to another more efficient system that removes larger particles, reducing the flow of such large particles into the main purification equipment.

Cyclones can separate particles above 10 microns with a maximum efficiency of 90 %, although the efficiency for particle sizes below 2 – 3 microns is no more than 25 %.

### **Gas scrubbers**

Wet gas scrubbers are types of devices where a liquid (usually water) is used to collect dust and mist. To trap particles, liquid is sprayed into the gas current forming a mist, the droplets of which pick up most of the particles. Depending on the design and the operating conditions, these scrubbers can be adapted to retain both coarse and fine particles. The operating process consists of two different steps: one of contact, in which the mist is generated and the dust-laden gas flow comes into contact with it, and a second entrainment separation step, in which the mist and dust particles are separated from clean gas by inertia or impact.

Venturi scrubbers are the most widely used type in this industry because of their simplicity and flexibility. Current designs are based on the down-flow of gas through the venturi contactor. They are useful as gas absorbers for relatively soluble gases. Other less energy consuming types of scrubbers are also applied.

### **Bag filters**

The efficiency in the retention of particles in a bag filter depends on an adequate choice of filter. In general, bag filters consist of a series of tubes with a wall made of the filtering medium (bags) supported by an adequate structure. The assembly contains a cylindrical or parallel piped chamber that terminates at the bottom in a hopper-shaped collector. The gas stream to be treated passes through the filtering medium, where the particles are retained on the surface, gradually building up a thickness that improves retention efficiency, but increases the pressure drop. The filters are cleaned regularly by mechanical means (vibration, tapping) or by air circulated in the opposite direction, either continuously or in bursts. The selection of filtering material must take into account the composition and temperature of the gases, the nature of the particles and their size, the de-dusting efficiency required, and the economics of the process. High gas temperatures frequently require the use of a gas cooling system, since the maximum temperatures that these bag filters can withstand rarely exceed 250 °C.

The selection of filtering material is an essential factor from a technical and economic point of view. This material may account for 5 to 20 % of the total cost of the equipment. In addition, the repair and replacement of bags is one of the main items of the operating cost. Bag filters can achieve particle retention efficiencies higher than 99 %. The achievable emission ranges for bag filters are less than 20 mg/m<sup>3</sup>, with some applications attaining levels well below this value.

### Achieved environmental benefits

Reduction of dust emissions from the production of STPP.

### Cross-media effects

Waste waters may be generated when wet gas scrubbers are used. However, some setups do not generate waste water, for instance by re-using it in the sodium orthophosphate purification step or by collecting relatively clean water obtained by condensation during the concentration step.

### Operational data

No other data have been submitted other than those included in Table 6.12 above.

### Applicability

This technique is applicable for the plants producing STPP.

### Economics

See data included in Table 6.12. Refer also to data included in Table 6.3 through to Table 6.9.

### Driving force for implementation

The protection of the environment and the recovery of the STPP dust.

### Example plants

The STPP plants listed in Table 6.2 above.

### Reference literature

[93, CEFIC-CEEP, 2004].

## 6.3 Food phosphates

### 6.3.1 General information

For several reasons food phosphates are briefly addressed in this section, but since sodium tripolyphosphate STPP is also the largest volume food phosphate produced in Europe, the production of food phosphates (human food or pharmaceutical ingredient phosphates) is broadly covered in Section 6.2.

Food phosphates are a very large family of substances manufactured from purified phosphoric acid or thermal-route pure phosphoric acid.

Therefore, from the view point of raw material selection and the overall interrelationship within the group of inorganic phosphates (see Figure 6.1), food phosphates can be considered as having distinct linkages to both detergent phosphates and feed phosphates.

Apart from its main representative, food-grade sodium tripolyphosphate ( $\text{Na}_5\text{P}_3\text{O}_{10}$ ), all other food phosphate products are smaller volume products and do not qualify as large volume products to be included in the scope of this document. The family of food phosphates includes, among many others [6, CEFIC, 2002]:

- tripotassium phosphate,  $\text{K}_3\text{PO}_4$  – a potassium salt of phosphoric acid, produced by neutralisation with potassium carbonate and/or hydroxide and drying
- trisodium phosphate,  $\text{Na}_3\text{PO}_4$  – a sodium salt of phosphoric acid, produced by neutralisation with sodium carbonate and/or hydroxide and drying
- monopotassium phosphate,  $\text{KH}_2\text{PO}_4$  – a potassium salt of phosphoric acid, produced by partial neutralisation with potassium hydroxide/carbonate and crystallisation
- dipotassium phosphate,  $\text{K}_2\text{HPO}_4$  – a potassium salt of phosphoric acid, produced by partial neutralisation with potassium carbonate and/or hydroxide and drying
- dicalcium phosphate,  $\text{CaHPO}_4$  – a calcium salt of phosphoric acid, produced by neutralisation with calcium hydroxide and drying
- tricalcium phosphate,  $\text{Ca}_3\text{OH}(\text{PO}_4)_3$  – a calcium salt of phosphoric acid, produced by neutralisation with calcium hydroxide and drying
- monomagnesium phosphate,  $\text{Mg}(\text{H}_2\text{PO}_4)_2$  – a magnesium salt of phosphoric acid, produced by partial neutralisation with magnesium oxide/carbonate and drying
- trisodium diphosphate,  $\text{Na}_3\text{HP}_2\text{O}_7\cdot\text{H}_2\text{O}$  – a trisodium salt, produced by the hydration of sodium diphosphate mixtures.

As a detergent, food, and feed phosphates use the similar raw material base and fall under the same category of non-fertiliser grade inorganic phosphates covered in this chapter (see Section 6.1 and Figure 6.1), this section should, therefore, be read in conjunction with Section 6.2 on detergent phosphates (as these groups of inorganic phosphates share the same main product: sodium tripolyphosphate), and with Section 6.4 on feed phosphates (as these groups share the same main raw material: purified non-fertiliser grade wet phosphoric acid).

### 6.3.2 Applied processes and techniques

Since the production process of food-grade STPP is, in principle, the same as that for detergent-grade STPP by the purified acid route, it is therefore covered in Section 6.2 above.

### 6.3.3 Present consumption and emission levels

Refer to Section 6.2 above.

### 6.3.4 Techniques to consider in the determination of BAT

For an introduction on understanding the ‘techniques to consider in the determination of BAT’ section and its contents, refer to Section 6.2.4.

#### 6.3.4.1 Raw material selection for the production of food phosphates

##### Description

As compared to the detergent-grade phosphate STPP, manufactured from partially purified wet phosphoric acid (chemical purification), and feed-grade phosphate DCP (see Section 6.4 below), manufactured mainly from deeply purified wet phosphoric acid (involving solvent extraction), food-grade phosphates are the only family of inorganic phosphates which are manufactured using either deeply purified non-fertiliser grade wet phosphoric acid or thermal grade pure, arsenic-free phosphoric acid.

The type and the purity of food-grade phosphoric acid used as a raw material has a major influence on the quality of the end food-grade phosphate product. Impurities, heavy metals and fluorine should be avoided in the raw materials since they are not removed in any downstream purification step. Therefore, a preselection between deeply purified non-fertiliser grade wet phosphoric acid and pure, arsenic-free thermal grade phosphoric acid (refer to Figure 6.1) needs to be made first.

Both of these high purity acids are global market commodity raw materials and are typically manufactured upstream of the site of the food-grade phosphate plant. However, in some cases, they are manufactured at the food phosphate production site.

Although, on the basis of economics, deeply purified non-fertiliser grade wet phosphoric acid is the most typically used raw material for the production of inorganic food phosphates. In some locations and in specific cases, the use of pure thermal grade phosphoric acid may still prove to be a favourable option, in particular when the highest quality requirements of inorganic food-grade phosphate products are to be met.

##### Achieved environmental benefits

The selection between and the use of either purified non-fertiliser grade wet phosphoric acid or pure thermal grade phosphoric acid, has an advantage of not purifying the acid to a level higher than necessary for food-grade phosphate products, and thus the overall impact on the environment, from the phosphate rock to food phosphate, is minimised.

##### Cross-media effects

The production of food phosphates based on thermal grade phosphoric acid from elemental phosphorus involves large amounts of energy required for the production of elemental phosphorus, upstream of the thermal grade phosphoric acid and food-grade phosphate production site. In turn, the production of food phosphates based on purified wet phosphoric acid involves the generation of large amounts of phosphogypsum, and other solid wastes generated in the acid purification stage, typically upstream of the food-grade phosphate process, but in some cases at the same production site.

Operational data

No detailed data submitted. However, refer to Section 6.2 above and to Section 6.4 below, as this technique is, to some degree, characteristic to the whole sector of inorganic phosphates.

Applicability

Applicable to food-grade phosphate plants, which use the purified wet phosphoric acid or pure thermal grade phosphoric acid, and manufacture high quality inorganic phosphate products.

Driving force for implementation

Minimisation of the impact of the production of phosphates on the environment, in the whole chain of operations, starting from the phosphate rock raw material, through phosphoric acid intermediate product and ending at food-grade phosphate product.

The highest quality requirements of food-grade phosphate products.

Example plants

A food-grade phosphate plant in Huelva, Spain (based on purified wet phosphoric acid)

A food-grade phosphate plant in Engis, Belgium (based on purified wet phosphoric acid)

A food-grade phosphate plant in Vlissingen, the Netherlands (based on pure thermic acid).

Other food-grade phosphate plants in the EU based on the supplies of purified wet phosphoric acid or pure thermic acid from outside of the food phosphate production sites.

Reference literature

[65, CEFIC-IFP, 2004], [79, BIPROKWAS, 1985-1995], [84, A. Davister, 1981], [93, CEFIC-CEEP, 2004], [101, RIZA, 2000], [102, UNIDO, 1980], [85, EIPPCB, 2004-2005].

## 6.4 Feed phosphates

### 6.4.1 General information

#### 6.4.1.1 Introduction

Inorganic feed phosphates include compounds containing phosphorus from phosphate rock  $\text{Ca}_5\text{F}(\text{PO}_4)_3$  or purified phosphoric acid. By the reaction of phosphate with mineral cations, a large variety of phosphates for different feeding purposes, are produced. The phosphates most commonly used for animal feed are calcium phosphates, with dicalcium phosphate as a main representative in this group, as well as magnesium phosphates, sodium phosphates, ammonium phosphates, and combination phosphates [6, CEFIC, 2002].

In this section, eleven different industrial processes for the production of feed phosphates are discussed. For each product, a detailed process description is given. However, the consumption and emission levels are only given for dicalcium phosphate (DCP) produced by two different processes. The reason for this is that a lot of different inorganic feed phosphates are produced by the phosphoric acid route and hence this document would become very elaborate if emissions were discussed for each single phosphate product. On the other hand, dicalcium phosphate is characterised by the highest production volume and, therefore, a good reference product to indicate emissions in a phosphate production plant [65, CEFIC-IFP, 2004].

For a general introduction concerning inorganic phosphates, refer to Section 6.1 above.

#### 6.4.1.2 Phosphorus – a vital source of animal nutrition

Phosphorus is one of the most important minerals in animal nutrition [65, CEFIC-IFP, 2004]. It is the second most abundant element in an animal's body after calcium, with 80 % of phosphorus found in bones and teeth, with the remainder located in the body fluids and soft tissue. Phosphorus plays a key metabolic role and has more physiological functions than any other mineral. These functions involve major metabolic processes such as:

- development and maintenance of skeletal tissue
- maintenance of osmotic pressure and acid base balance
- energy utilisation and transfer
- protein synthesis, transport of fatty acids, amino acid exchange
- growth and cell differentiation
- appetite control, efficiency of feed utilisation, and fertility.

An adequate supply of phosphorus is essential if optimal livestock health and productivity are to be achieved. Without an adequate supply of phosphorus, an animal will suffer from a phosphorus deficiency, the consequences of which are varied, but in all cases affect the animal's physical well-being, as well as its economic performance.

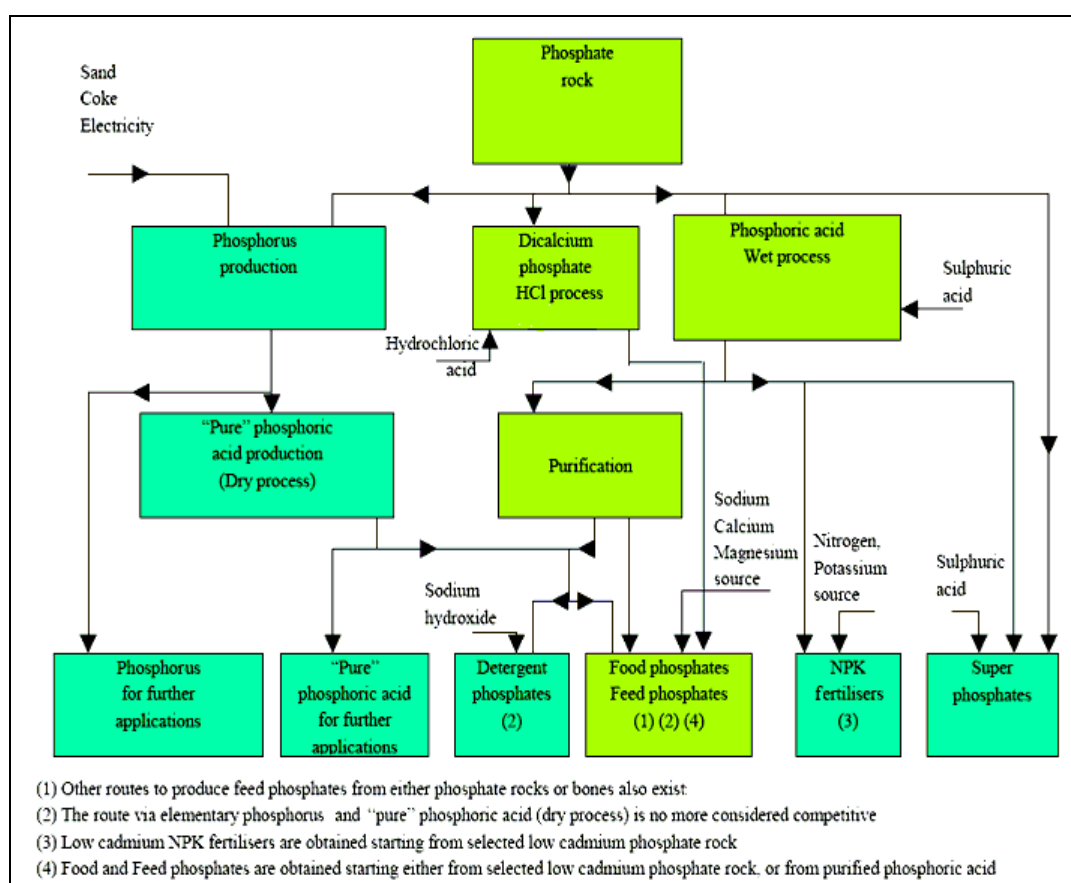
The high chemical reactivity of phosphorus means that it only occurs in nature combined with oxygen or other elements in the form of phosphates. Main phosphate sources are of plant, animal and inorganic origin, containing varying quantities of phosphorus in several different chemical forms.

Although plant (vegetable) material invariably plays the largest role in animal nutrition, the levels of phosphorus provided by normal pasture and plant material are not sufficient, the more so that the digestibility of phosphorus of these sources is very low. Therefore additional phosphorus is necessary on a regular basis to satisfy the needs of the animal.

High quality inorganic feed phosphates offer the combination of a consistently high total phosphorus content and excellent digestibility and are, therefore, widely used as supplementary phosphorus. Most inorganic phosphates used for this purpose are derived from natural rock phosphates, principally found in Africa, northern Europe, Asia, the Middle East and the US (see the BREF on LVIC-AAF). However, in their natural form inorganic phosphates are unsuitable for direct use in animal feed because the phosphorus they contain cannot be metabolised by animals. Rock phosphates must, therefore, be chemically treated so that the phosphorus they contain is changed into the digestible orthophosphate form ( $\text{PO}_4^{3-}$ ). During this process, close control of the production parameters is essential to avoid deterioration of the orthophosphate molecule into unavailable forms of phosphorus, such as pyrophosphate and metaphosphate, and to ensure a suitable calcium to phosphorus ratio for animal nutrition.

#### 6.4.1.3 Phosphate rock – the main downstream processes and products

As illustrated in Figure 6.4, phosphate rock is used as a raw material for all industrial phosphorus-based products, such as fertilisers, phosphoric acid, detergent phosphates, food phosphates, feed phosphates. For a general introduction to, and the interrelationship between different sectors of the inorganic phosphates industry, refer to Section 6.1 and to Figure 6.1.



**Figure 6.4: Phosphate rock – main downstream processes and applications**  
 [65, CEFIC-IFP, 2004]

The main products derived from phosphate rock are predominantly various phosphate fertilisers (see the BREF on LVIC-AAF). The consumption of feed phosphates in Western Europe from 1999 until 2002 was around 0.49 – 0.53 million tonnes of  $\text{P}_2\text{O}_5$  (approximately 1.2 to 1.3 million tonnes feed phosphate products), and is only a small fraction of the consumption of phosphate fertilisers, which in the same period ranged from 3 to 3.6 million tonnes of  $\text{P}_2\text{O}_5$ .

In Europe, inorganic feed phosphates are mainly produced in different ways. The most popular way of producing feed phosphates is by reacting purified feed-grade phosphoric acid with a calcium, magnesium, sodium, ammonium source or a mixture of these sources. In this way, a range of feed phosphates are formed: calcium phosphates (dicalcium, monocalcium and monodicalcium phosphate); magnesium phosphate, sodium phosphate, ammonium phosphate or combined phosphates like calcium-magnesium and sodium-calcium-magnesium phosphate.

A second way to produce inorganic feed phosphates is by reacting rock phosphate with hydrochloric acid. With this process, a crystalline dicalcium phosphate is formed.

Inorganic feed phosphates are also produced by defluorinating phosphate rock. This is done by heating (>1200 °C) a mixture of phosphate rock, phosphoric acid and sodium hydroxide or sodium carbonate with the formation of calcium-sodium phosphate and tricalcium phosphate. Fluorine is driven off and trapped as hydrogen fluoride. This process is still regularly used in Russia and the United States but is not applied in the European Union and will, therefore, not be discussed here.

Instead of the inorganic phosphate rock, feed phosphates can also be produced from an organic source, i.e. animal bones, or a raw material for the production of gelatin. The production process is quite similar to the hydrochloric acid – phosphate rock production process, only the raw materials are different. A process route to the organic bone phosphates is briefly described here, but no consumption and emission figures are given for this process (see the BREF on the Slaughterhouses and Animal By-products Industries).

Table 6.13 indicates that there are about 20 producers of inorganic feed phosphates in Europe. Altogether, they have an estimated capacity of between 2.2 and 2.5 million tonnes per year in terms of feed phosphate products (0.90 – 1.04 million tonnes per year of P<sub>2</sub>O<sub>5</sub>). The capacities given in Table 6.13 are those of the CEFIC members and those of the non-members estimated by the CEFIC members. The largest proportion of the feed phosphates is produced in the European Union (capacities about 2.14 – 2.34 million tonnes per year). A breakdown of the capacities by process indicates that feed phosphates are mainly produced by the phosphoric acid route. The other part of feed phosphates is produced by the hydrochloric acid route, in which the capacities are the sum of inorganic (based on phosphate rock) and organic (based on bones) feed phosphates.

The estimated total European production capacities of feed phosphates is given in Table 6.13.

Country of production	Number of producers	Estimated total capacities Min – Max kt per year
Italy	3	235 to 325
Greece	1	40 to 60
France	2	220 to 260
Germany	2	25 to 30
United Kingdom	1	5 to 10
Spain + Portugal	4	330 to 365
Benelux	3	860 to 865
Scandinavia	1	425
Eastern Europe	3	60 to 185
<b>Estimated total for Europe</b>	<b>20</b>	<b>2200 to 2525</b> <b>(904 to 1037 as P<sub>2</sub>O<sub>5</sub>)</b>
<b>Estimated total per process:</b>		
Phosphoric acid		1655 to 1925
Hydrochloric acid (incl. bones)		545 to 600

**Table 6.13: Estimated total European production capacities of feed phosphates [65, CEFIC-IFP, 2004]**

## 6.4.2 Industrial processes

### 6.4.2.1 Phosphoric acid based processes

#### 6.4.2.1.1 Dicalcium phosphate (DCP)

Purified phosphoric acid is reacted with quick lime and/or calcium carbonate under strictly controlled conditions. The main reactions are:

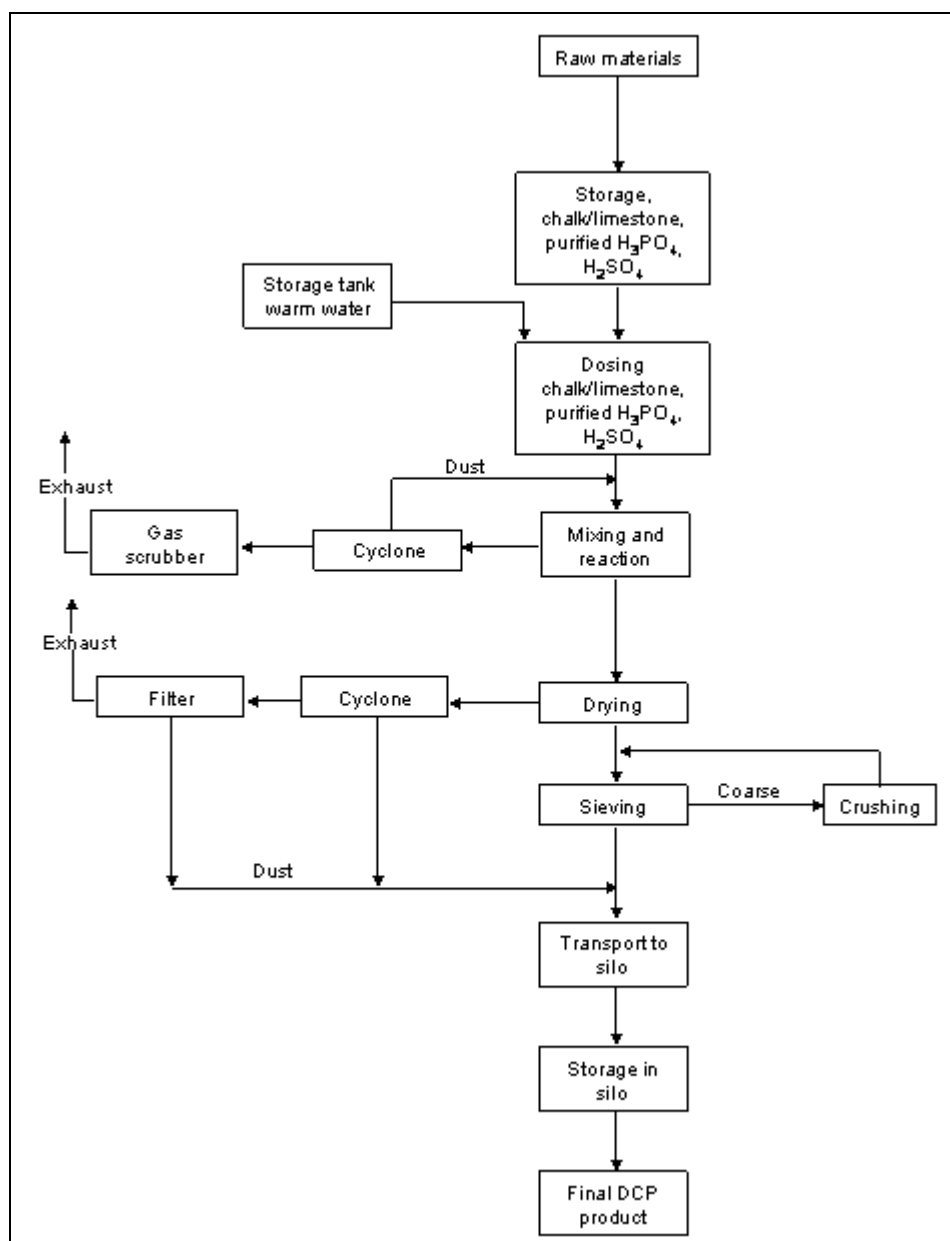
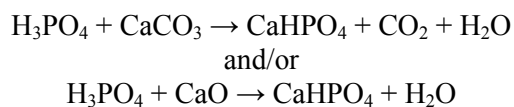


Figure 6.5: Block diagram - dicalcium phosphate (DCP) process [65, CEFIC-IFP, 2004]



## 6.4.2.1.2 Monocalcium phosphate (MCP)

Feed-grade monocalcium phosphate is produced by reacting purified phosphoric acid and a calcium source in a granulator under precise conditions. Either dicalcium phosphate (see description below) or limestone/quick lime (see description below) can be used as a source of calcium. After granulation, the product is screened to an appropriate granule size, cooled and stored.

Reaction with dicalcium phosphate

Monocalcium phosphate is obtained by a direct reaction of concentrated defluorinated and purified phosphoric acid with dicalcium phosphate. There is also evidence of the presence of a small amount of unreacted dicalcium phosphate. The global reaction is:

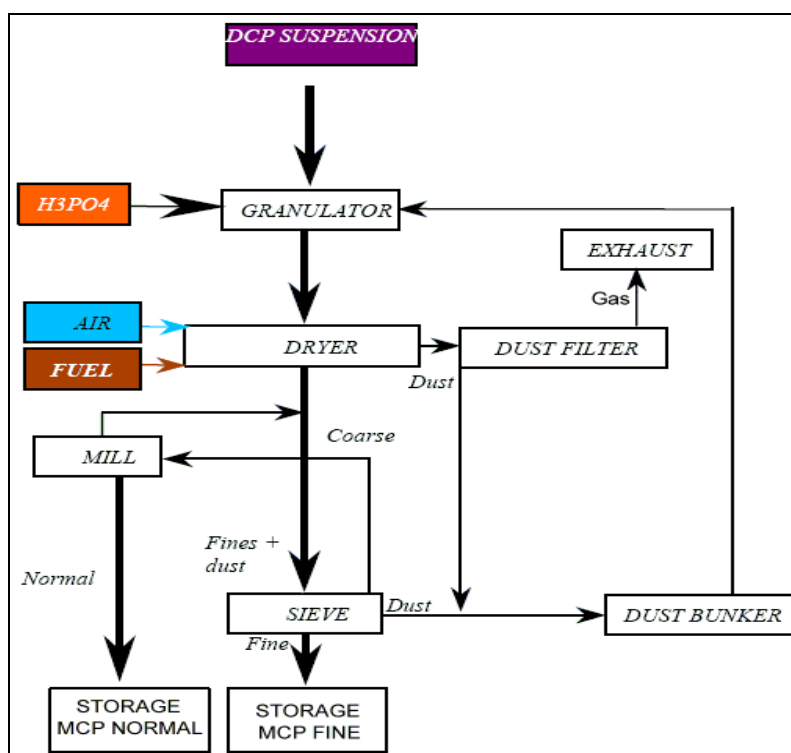
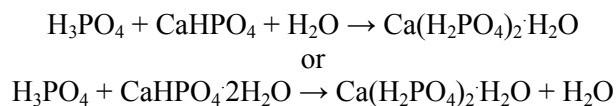
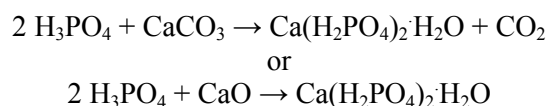


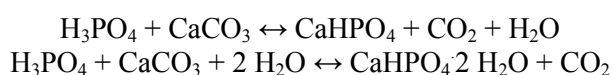
Figure 6.6: Block diagram - monocalcium phosphate (MCP) process [65, CEFIC-IFP, 2004]

Reaction with limestone/quick lime

Monocalcium phosphate is obtained by a direct reaction of concentrated defluorinated and purified phosphoric acid with finely grinded limestone or quick lime. The global reaction is:



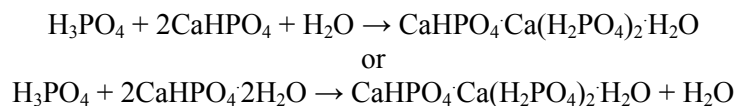
Furthermore, there is also evidence of the formation of dicalcium phosphate during the neutralisation process:



### 6.4.2.1.3 Monocalcium phosphate (MDCP)

Monocalcium phosphate, a granular intermediate between monocalcium and dicalcium at a calcium-phosphorus ratio of approximately 1:1, is produced by reacting purified phosphoric acid and a calcium source in a granulator under precise conditions. Either dicalcium phosphate or limestone can be used as a source of calcium. After granulation, the product is screened to an appropriate granule size, cooled and stored.

The reaction with dicalcium phosphate is:



The reaction with limestone is:



### 6.4.2.1.4 Calcium-magnesium phosphate (CaMgP)

Calcium-magnesium phosphate is produced from finely ground sources of magnesium and calcium together with phosphoric acid. All raw materials are dosed into a granulator, where chemical reactions take place under strictly controlled conditions. After granulation, the product is screened, cooled and stored. This procedure results in an end-product that consists of a chemical complex containing all the added macro elements. The reaction is:

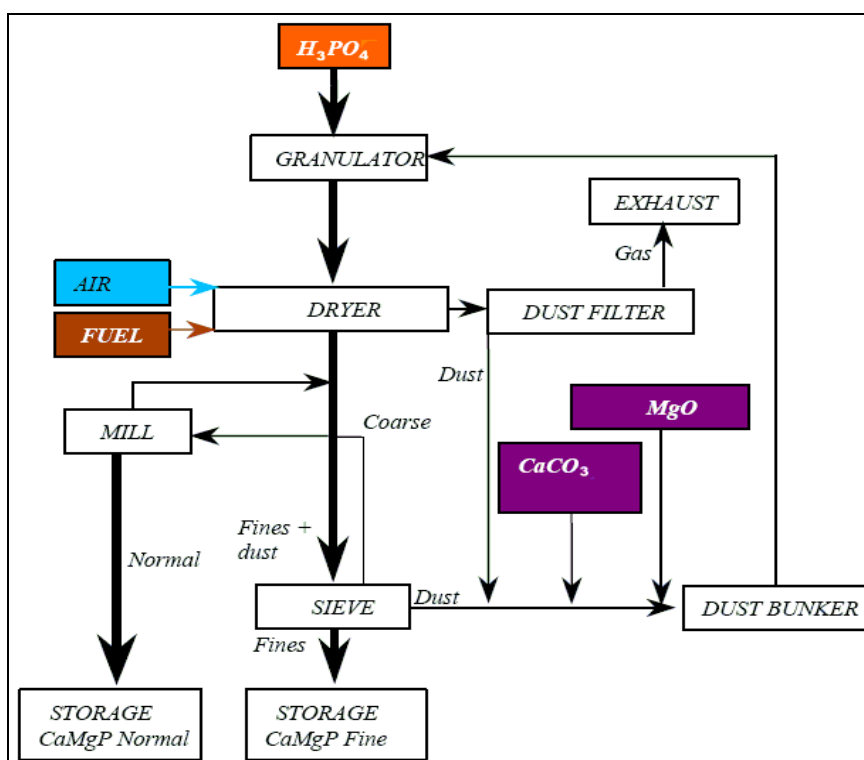
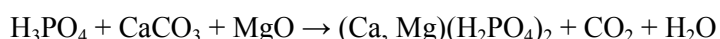


Figure 6.7: Block diagram – calcium-magnesium phosphate (CaMgP) process [65, CEFIC-IFP, 2004]

## 6.4.2.1.5 Magnesium phosphate (MgP)

Magnesium phosphate is produced by reacting purified phosphoric acid and magnesium oxide in a granulator under precise conditions. After granulation, the product is screened, cooled and stored.

The reaction is:

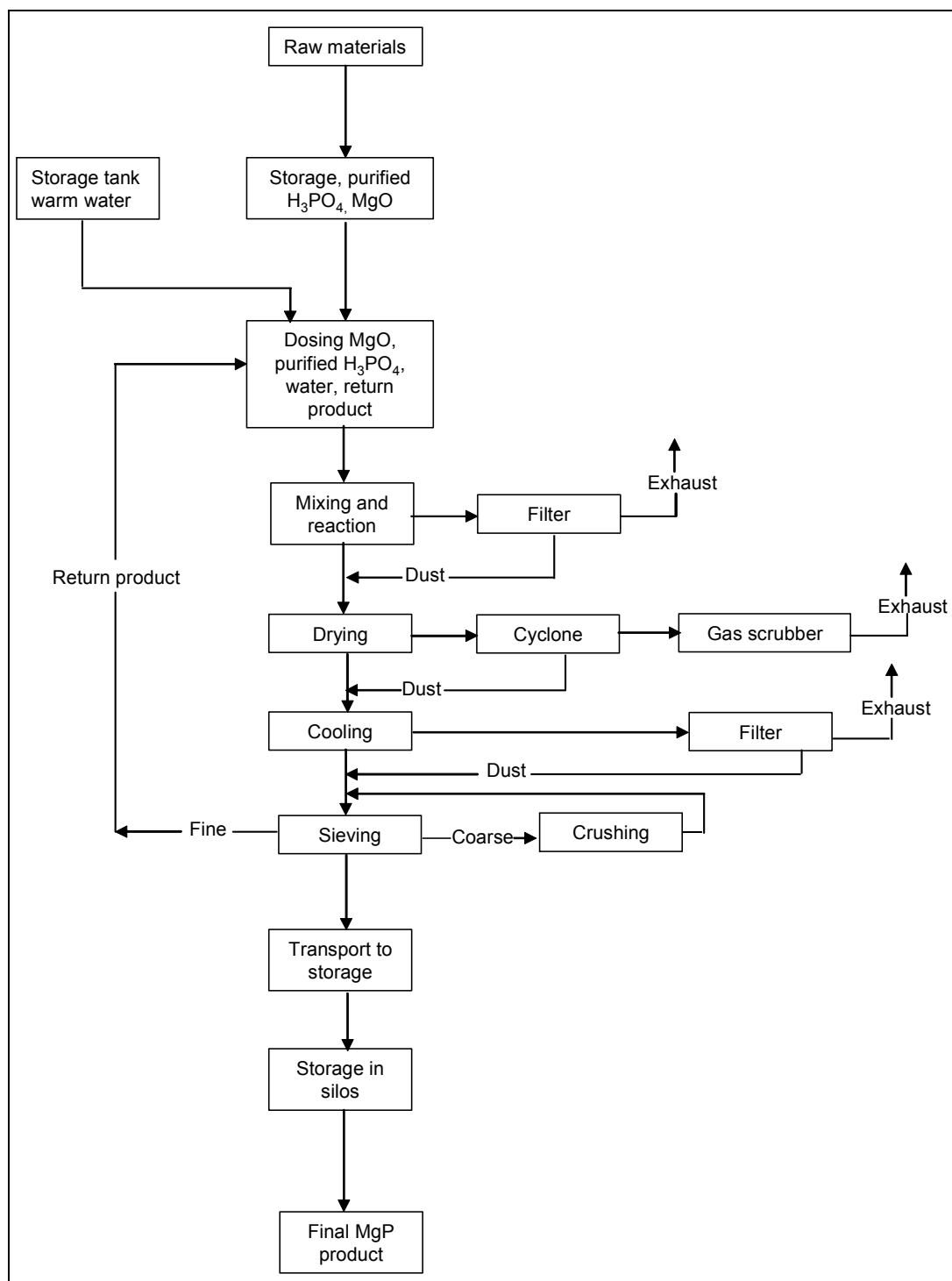
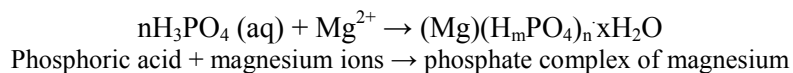


Figure 6.8: Block diagram – magnesium phosphate (MgP) process [65, CEFIC-IFP, 2004]

### 6.4.2.1.6 Sodium-calcium-magnesium phosphate (NaCaMgP)

Sodium-calcium-magnesium phosphate is produced from finely ground sources of magnesium, sodium and calcium together with phosphoric acid. All raw materials are dosed into a granulator, where chemical reactions take place under strictly controlled conditions. After granulation the product is screened, cooled and stored. This procedure results in an end-product that consists of a chemical complex containing all the added macro elements. The main reaction is (however, the reaction formula is not balanced):

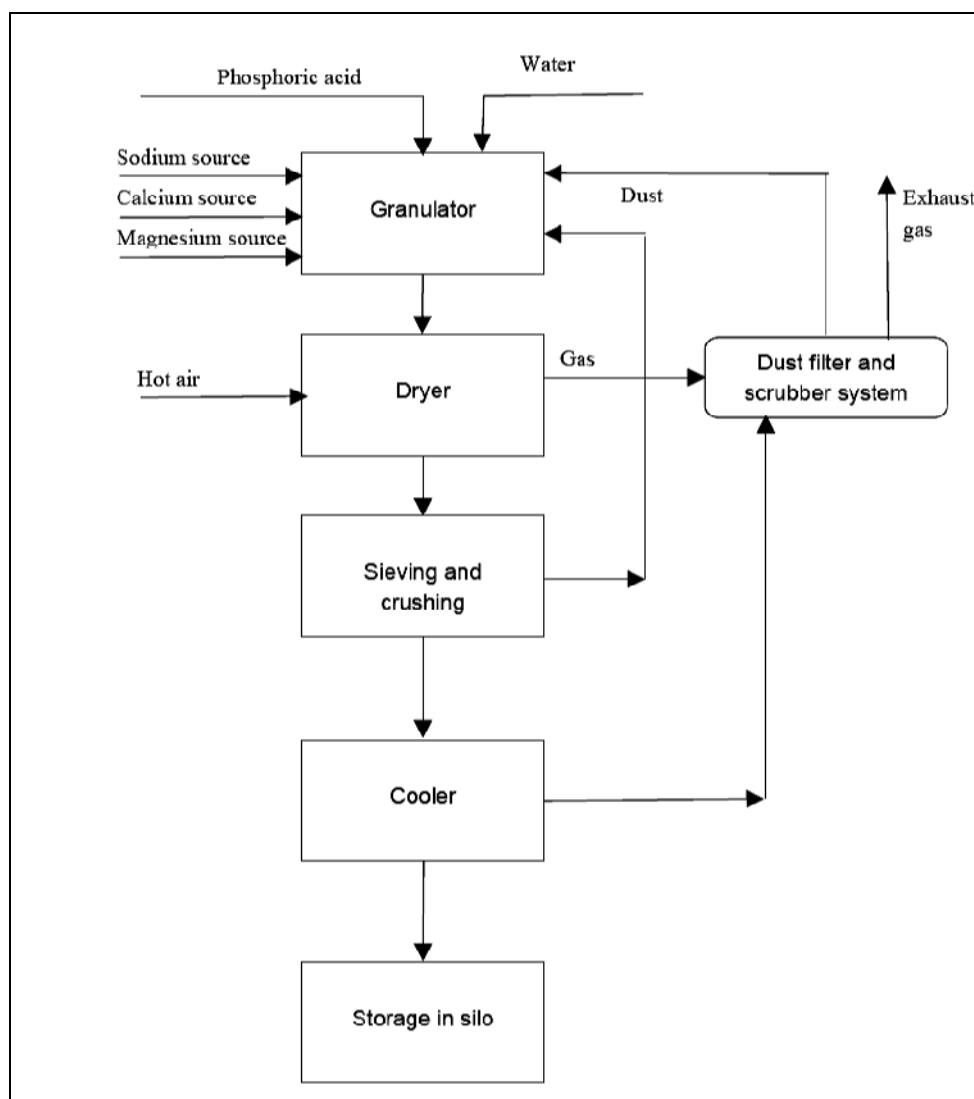
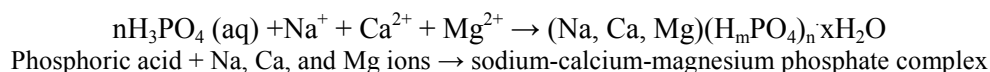
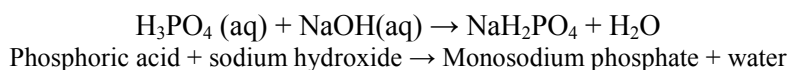


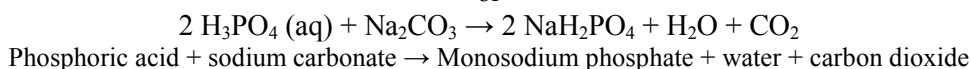
Figure 6.9: Block diagram – sodium-calcium-magnesium phosphate (NaCaMgP) process [65, CEFIC-IFP, 2004]

### 6.4.2.1.7 Monosodium phosphate (MSP)

Monosodium phosphate is produced by reacting pure phosphoric acid and a sodium source in a granulator under precise conditions. The source of sodium can be either sodium hydroxide or sodium carbonate. After granulation, the product is screened, cooled and stored. The reaction is:



or

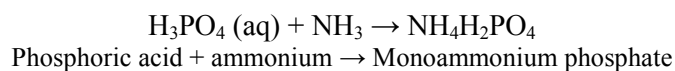


A process flow sheet of MSP production is very similar to that of the NaCaMgP process illustrated in Figure 6.9 above – but this time only the Na source is fed into granulator (no Ca and Mg sources).

#### 6.4.2.1.8 Monoammonium phosphate (MAP)

Monoammonium phosphate is produced by the chemical reaction of purified phosphoric acid with ammonia under strictly controlled conditions. After granulation, the product is screened, cooled and stored (see BREF on LVIC-AAF).

The reaction is:

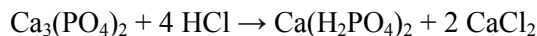


#### 6.4.2.2 Hydrochloric acid based processes (dicalcium phosphate)

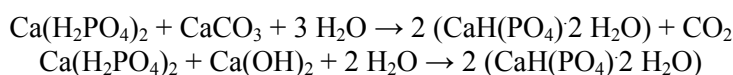
##### 6.4.2.2.1 From phosphate rock

Dicalcium phosphate is produced according to the following steps:

1) Phosphate rock is digested with hydrochloric acid under precise, strictly controlled conditions necessary for the production of monocalcium phosphate.



2) Monocalcium phosphate is precipitated with limestone or milk of lime, and dicalcium phosphate crystals are formed

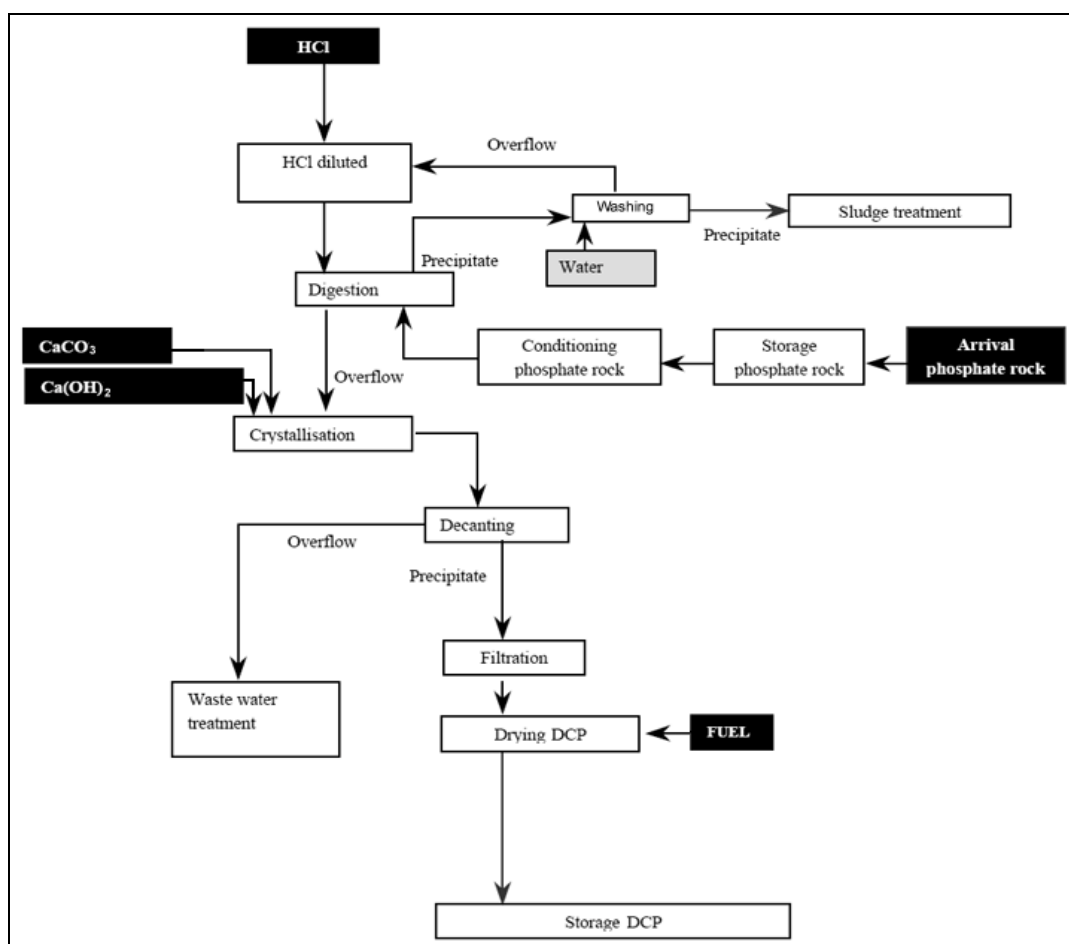


3) Filtration and drying of the dicalcium phosphate

##### The production of dicalcium phosphate – process description

Phosphate rock is sieved and ground before being digested with hydrochloric acid. Dust emissions to the atmosphere are minimised by the use of adequate dust removal equipment. The collected dust is also sent to the digestion unit. The ground phosphate rock is digested in dilute hydrochloric acid in digestion reactors. Insoluble residues are separated in thickeners with a centre drive and after washing and filtration by filter presses, they are stored in a controlled landfill. The overflow of the thickeners (monocalcium phosphate solution) is sent to the next process step. To prevent odour problems the air of the digestion reactors is collected and treated chemically before being sent to the atmosphere. In a crystallisation section, the monocalcium phosphate solution is treated with limestone or milk of lime to precipitate dicalcium phosphate crystals. The crystals are separated in thickeners, filtered (vacuum filtration) and dried (drum dryers). The off-gas of the dryers is treated in humid and dry dust removal units before being released into the atmosphere.

A flow diagram for dicalcium phosphate process based on hydrochloric acid route is given in Figure 6.10 below.



**Figure 6.10: Block diagram – dicalcium phosphate process route based on hydrochloric acid [65, CEFIC-IFP, 2004]**

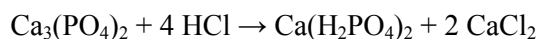
#### 6.4.2.2.2 From bone phosphates (dicalcium phosphate)

The production process for this type of dicalcium phosphates is very similar to that described in Section 6.4.2.2.1. The raw material is the main difference.

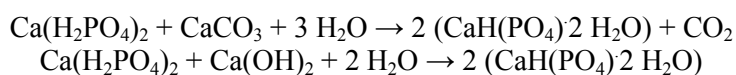
During the manufacture of gelatin (refer to the BREF on the Slaughterhouses and Animals By-products Industries), tricalcium phosphate is removed from bones and dissolved with hydrochloric acid under precise, strictly controlled conditions. The phosphate ions obtained are precipitated with limestone or milk of lime. The resulting dicalcium phosphate is separated from the residue and dried to powder.

The reactions are:

- 1) Bones are digested with hydrochloric acid under precise, strictly controlled conditions with the production of monocalcium phosphate.



- 2) Monocalcium phosphate is precipitated with limestone or milk of lime, and dicalciumphosphate crystals are formed.



### 6.4.3 Present consumption and emission values

#### 6.4.3.1 Dicalcium phosphate – the phosphoric acid process route

The consumption and emission values given in Table 6.14 and Table 6.15 below are for the production of dicalcium phosphate (DCP) from purified feed-grade phosphoric acid.

As indicated in Figure 6.4, phosphoric acid is produced from phosphate rock. This process is described in the BREF on LVIC-AAF. The main environmental aspects of wet process phosphoric acid production are emissions of gaseous fluorine compounds and dust, discharges to water, waste gypsum and radioactivity. During the production of phosphoric acid, the impurities are distributed between phosphoric acid and gypsum. Therefore, phosphoric acid must be further purified to become feed-grade phosphoric acid.

The purification of phosphoric acid has not been described in the BREF on LVIC-AAF as, for most fertiliser production processes, such a step is not necessary. Concrete information on consumption and emissions from the phosphoric acid purification step are not available.

Energy and water consumption values for the production of dicalcium phosphate (DCP) based on purified feed-grade phosphoric acid are given in Table 6.14.

<b>Raw materials</b>	
Purified feed-grade $H_3PO_4$ , as $P_2O_5$	0.41 – 0.49 tonnes $P_2O_5$ per tonne of DCP 18 %
CaO and/or $CaCO_3$ , as Ca	0.24 – 0.28 tonnes Ca per tonne of DCP 18 %
<b>Energy</b>	
Electricity	20 – 120 kWh per tonne of DCP 18 %
Fuel oil	0 – 0.028 tonnes per tonne of DCP 18 %
Natural gas	0 – 27.1 m <sup>3</sup> per tonne of DCP 18 %
Total energy consumption	37 – 348 kWh per tonne of DCP 18 %
<b>Water</b>	0 – 0.45 m <sup>3</sup> per tonne of DCP 18 %

**Table 6.14: Consumption values – production of dicalcium phosphate from the phosphoric acid route**  
[65, CEFIC-IFP, 2004]

In Table 6.15, emission values for the production of dicalcium phosphate (DCP) based on purified feed-grade phosphoric acid are given.

<b>Emissions to air*</b>	
Volume exhaust gas	1950 – 7800 m <sup>3</sup> per tonne of DCP 18 %
Fluorine in exhaust gas (mg F per m <sup>3</sup> exhaust gas)	Below detection limit or not available
Dust in exhaust gas	0.13 – 25 mg dust per m <sup>3</sup> of exhaust gas
<b>Emissions to water*</b>	
Volume waste water	0 – 0.15 m <sup>3</sup> per tonne of DCP 18 %
Phosphorus in waste water	0 – 5 g P per m <sup>3</sup> of waste water
<b>Solid waste*</b>	
Nature of residues	Dust from facilities and equipment cleaning
Quantities of solid waste	0 – 2 kg per tonne of DCP 18 %
Destination/ways to re-use	Fertiliser production or disposal
* Excluding the production and purification of phosphoric acid	

**Table 6.15: Emission values – production of dicalcium phosphate from the phosphoric acid route**  
[65, CEFIC-IFP, 2004]

### 6.4.3.2 Dicalcium phosphate – the hydrochloric acid process route

Current consumption and emission values given in Table 6.16 and Table 6.17 below are for the production of dicalcium phosphate (DCP) based on the hydrochloric acid route (from phosphate rock only).

In Table 6.16, consumption values for the production of dicalcium phosphate (DCP) based on hydrochloric acid and phosphate rock are given.

<b>Raw materials</b>	
Rock phosphate	1.3 – 1.5 tonnes rock per tonne of DCP 18 %
Hydrochloric acid (HCl 100 %)	0.60 – 0.80 tonnes of 100 % HCl per tonne of DCP 18 %
CaO, Ca(OH) <sub>2</sub> or CaCO <sub>3</sub> , as Ca	0.125 – 0.290 tonnes of Ca per tonne of DCP 18 %
<b>Energy</b>	
Electricity	51 – 205 kWh per tonne of DCP 18 %
Fuel oil	0 – 0.058 tonnes per tonne of DCP 18 %
Natural gas	0 – 100 m <sup>3</sup> per tonne of DCP 18 %
Total energy consumption	547 – 1145 kWh per tonne of DCP 18 %
<b>Water</b>	19.5 – 33.0 m <sup>3</sup> per tonne of DCP 18 %

**Table 6.16: Consumption values – production of dicalcium phosphate, hydrochloric acid route [65, CEFIC-IFP, 2004]**

In Table 6.17 emission values for the production of dicalcium phosphate (DCP) based on hydrochloric acid and phosphate rock are given.

<b>Emissions to air</b>	
Volume exhaust gas	2400 – 9000 m <sup>3</sup> per tonne of DCP 18 %
Fluorine in exhaust gas (mg F per m <sup>3</sup> exhaust gas)	Below detection limit or not available
Hydrogen chloride	10 – 30 mg HCl per m <sup>3</sup> of exhaust gas
Dust in exhaust gas	10 – 50 mg dust per m <sup>3</sup> of exhaust gas
<b>Emissions to water</b>	
Volume waste water	20 – 34 m <sup>3</sup> per tonne of DCP 18 %
Phosphorus in waste water	1 – 8 g P per m <sup>3</sup> of waste water
Calcium chloride in waste water	30 – 70 kg CaCl <sub>2</sub> per m <sup>3</sup> of waste water
Metals in waste water	<1 ppm per m <sup>3</sup> of waste water (sum of Cd, As, Pb, Hg, Cr, Cu, Ni, Zn)
<b>Solid waste</b>	
Nature of residues	Insolubles; filter cakes
Quantities of solid waste	100 – 240 kg per tonne of DCP 18 %
Destination/ways to re-use	Fertiliser production or controlled storage

**Table 6.17: Emission values – production of dicalcium phosphate, hydrochloric acid route [65, CEFIC-IFP, 2004]**



#### 6.4.4 Techniques to consider in the determination of BAT

For an introduction on understanding the ‘techniques to consider in the determination of BAT’ section and its contents, refer to Section 6.2.4.

Feed phosphates, with their main product dicalcium phosphate (DCP), are produced in the EU using two main process routes: the phosphoric acid route and the hydrochloric acid route. The third route, based on the ion exchange process is not included here, as the only plant in the EU which operated this process has closed down [85, EIPPCB, 2004-2005].

##### 6.4.4.1 Dicalcium phosphate – the phosphoric acid process route

In some cases, purification takes place in a dedicated plant by employing solvent extraction which leads to the production of a high quality phosphoric acid. Optionally, additional techniques (for removal of arsenic, sulphate or fluoride) may be applied.

However, because of the lack of sufficient information and detailed data, a technique relating to the process routes available for the purification of ‘green’ non-fertiliser grade phosphoric acid, pertaining to a varying degree to the whole family of feed, food and detergent-grade phosphates, has not been included in this document. For information on this technique, refer to the ‘Additional information submitted during the information exchange on LVIC-S industry’ document, accessible through the EIPPCB website. In this document, the production either by a chemical process or a physical process (solvent extraction) is described.

###### 6.4.4.1.1 Recovery of spills from acid conditioning, reaction, and water re-use

###### Description

All phosphoric acid conditioning operations take place in a closed area, where all spills can be recovered. Recovered drainage water is used to dilute the acid. Gases, water vapour and dust coming from the reactor can be either washed in a scrubber, using water for diluting the acid, or sent to the dryer. In various production plants using this process, there is no or a very small quantity of waste water. When a scrubber is not used as dedusting equipment, the addition of water to the system is not needed and waste water is not generated. When a scrubber is used, water can be held in a closed loop. In such a way, the process allows water to be re-used.

Reference is made here also particularly to the BREF on Common Waste Water and Waste Gas Treatment/Management Systems in the Chemical Sector (CWW).

###### Achieved environmental benefits

Recovery of acid spills, washing out of gases and vapours, dedusting off-gases, and water re-use benefit in reducing the impact of the production of DCP on the environment.

###### Cross-media effects

No side-effects or disadvantages are caused by the implementation of this technique.

###### Operational data

No detailed data submitted. Refer to Section 6.4.3.1.

###### Applicability

Applicable to the plants producing feed phosphates by the phosphoric acid route..

###### Driving force for implementation

The protection of the environment and re-use of water.

###### Example reference plants

This technique is used in several plants, including a feed and detergent-grade phosphate plant in Huelva, Spain.

###### Reference literature

[65, CEFIC-IFP, 2004], [93, CEFIC-CEEP, 2004].

#### 6.4.4.1.2 Dedusting of air from drying operations

##### Description

If the product needs to be dried, rotary, fluidised bed or flash dryers can be used. All of them require large quantities of drying air. This air needs to be dedusted before being released to the atmosphere. Natural gas or oil is used as the energy source. Dryers, conveyors, screens, crushers and various points in the production process are all connected to a dedusting system.

Dedusting equipment such as cyclones, scrubbers and filters are used for this purpose. The collected dust is recovered and re-used in the production process.

Refer also to the BREF on LVIC-AAF and the BREF on Common Waste Water and Waste Gas Treatment/Management Systems in the Chemical Sector (CWW).

##### Achieved environmental benefits

Dedusting of air coming from the drying systems and the equipment for product handling.

##### Cross-media effects

No side-effects or disadvantages are caused by the implementation of this technique.

##### Operational data

No detailed data submitted.

##### Applicability

Applicable to the plants producing feed phosphates by the phosphoric acid route.

##### Driving force for implementation

The protection of the environment and the recovery of DCP dust.

##### Example reference plants

This technique is used in several plants, including a feed and detergent-grade phosphate plant in Huelva, Spain.

##### Reference literature

[65, CEFIC-IFP, 2004], [93, CEFIC-CEEP, 2004].

#### 6.4.4.2 Dicalcium phosphate – the hydrochloric acid process route

The following five techniques are identified for DCP production by the hydrochloric acid route, in which phosphate rock is used [65, CEFIC-IFP, 2004].

It should be noted that the techniques used in the production of DCP in which animal bones are used, are similar to those described below. The secondary raw material (animal bones and not phosphate rock) is the main difference.

For information on the techniques on the manufacture of gelatin, refer to the BREF on the Slaughterhouses and Animals By-products Industries (SA).

##### 6.4.4.2.1 Integrated production of dicalcium phosphate and potassium sulphate

##### Description

The production of dicalcium phosphate by the hydrochloric acid process route is, in most cases, associated with the production of potassium sulphate for fertilisers. Sulphuric acid reacts with potassium chloride in a furnace with the formation of potassium sulphate and hydrochloric acid, this latter one is then used for the production of DCP. Integrated production of DCP and  $K_2SO_4$ , leads to the minimisation of raw materials and energy usage, and is a typical technique for DCP production by the hydrochloric acid route.

### Achieved environmental benefits

Instead of considering the hydrochloric acid as a waste stream, it is further used for the production of crystalline dicalcium phosphate.

### Cross-media effects

Cross-media effects were not reported, however, when analysing this technique in more detail, factors noted in Annex IV to the IPPC Directive also need to be taken into consideration.

### Operational data

No detailed data submitted. Refer to the consumption and emission levels included in Section 6.4.3.2.

### Applicability

Applicable to the plants producing feed phosphates by the hydrochloric acid process route.

### Driving force for implementation

The utilisation of the by-produced HCl in order to protect the environment and to decrease the cost of DCP production.

### Example reference plants

No data submitted, however, this technique is used in some plants.

### Reference literature

[65, CEFIC-IFP, 2004].

## **6.4.4.2.2 Reduction of emissions to air – dust, odour and noise**

### Description

Dust and odour are the only relevant outlets to the atmosphere when producing feed phosphates based on the hydrochloric acid production process. In this process, there are no emissions of gaseous fluorides to the atmosphere. The emissions of dust are generated mainly during the unloading, handling (conveying) and storage of raw materials and final products. Dust is also generated at various points in the feed phosphate production process. Phosphate rock, which is the solid raw material used for the production of inorganic feed phosphates, can be a dusty material. Phosphate rock is normally supplied by ship, unloaded by cranes and transferred to storage. In order to limit the dust emissions during the transshipments of phosphate rock, specially designed ship unloaders with integrated dust removal equipment are used.

The dust free loading of inorganic feed phosphates to or from trucks, trains and ships is ensured by the use of loading systems with integrated or centralised dust removal. The dust emissions at source are also kept as low as possible by the storage of the raw materials and the end-products in dedicated silos or enclosed buildings. Bay loaders and scrapers handle material in the storage. The dust generated at various points in the production process (e.g. during the handling of dusty products and during the drying process), remains limited due to the installation of dust filters at several points in the process. The dust collected in these filters is recovered and re-used in the production process. The vent gases from the phosphate rock digestion reactors are treated in wet scrubbers to prevent odour emissions.

The scrubbing liquids are recycled back into the production process. The grinders are the only relevant equipment causing noise. To reduce the noise, the grinding machines are installed inside buildings equipped with soundproof walls.

Reference is made here also particularly to the BREF on Common Waste Water and Waste Gas Treatment/Management Systems in the Chemical Sector (CWW).

### Achieved environmental benefits

The reduced emission of dust, odour, and noise to the environment.

Cross-media effects

No side-effects or disadvantages are caused by the implementation of this technique.

Operational data

No detailed data submitted, however, reference is made here to the consumption and emission levels included in Section 6.4.3.2.

Applicability

Applicable to the plants producing feed phosphates by the hydrochloric acid route.

Driving force for implementation

The protection of the environment (reduction of the emissions of dust, odour and noise) and the recovery of DCP dust.

Example reference plants

No data submitted, however, this technique is used in some plants.

Reference literature

[65, CEFIC-IFP, 2004], [93, CEFIC-CEEP, 2004].

**6.4.4.2.3 Liquid effluent treatment**Description

During DCP production by the hydrochloric acid process route, calcium chloride and some of the impurities derived from the phosphate rock are released into the waste water. The recovery of solid calcium chloride dissolved in waste water is reported to be not feasible for technical, economic and environmental reasons. Distillation results in CO<sub>2</sub> emissions and requires a large amount of energy mainly in the form of steam to concentrate the diluted solution to solid calcium chloride. Moreover, the market for calcium chloride is limited and the concentrated salt would have to be dumped. For these reasons, there are no calcium chloride recovery units present in feed phosphate production plants (refer also to Section 7.11).

Reference is made here also particularly to the BREF on Common Waste Water and Waste Gas Treatment/Management Systems in the Chemical Sector (CWW).

Achieved environmental benefits

The waste waters are purified (by the separation of impurities derived from the phosphate rock in thickeners, followed by washing and filtration of impurities by a filter press), before they are discharged to a natural watercourse.

Cross-media effects

As there is a very limited market for calcium chloride, substantial amounts of CaCl<sub>2</sub> dissolved in waste water are directed to natural watercourses.

Operational data

No detailed data submitted, however, reference is made here to the consumption and emission levels included in Section 6.4.3.2.

Applicability

Applicable to the plants producing feed phosphates by the hydrochloric acid route.

Driving force for implementation

A large amount of energy required to concentrate the diluted solution to solid calcium chloride.

Example reference plants

No data submitted, however, this technique is used in some plants.

### Reference literature

[65, CEFIC-IFP, 2004], [33, CEFIC-ESAPA, 2004], [56, InfoMil, 2004], [85, EIPPCB, 2004-2005], [95, CEFIC-Brunner Mond, 2004].

#### **6.4.4.2.4 Separation of insoluble residue from phosphate rock**

##### Description

To produce high quality feed phosphates by the hydrochloric acid process route with a minimum content of undesirable substances, the insoluble impurities from phosphate rock are separated out in the form of solid residual substances, which consist mainly of calcium fluoride. In order to reduce the quantity of solid effluents, a countercurrent digestion process optimises the extraction of the phosphorus from the phosphate rock.

Radioactivity of the insoluble residue from phosphate rock: all natural materials contain naturally occurring radioactive nuclides. The radioactivity of phosphate rock is mainly from the radioactive decay serie of U-238. When producing feed phosphates by the hydrochloric acid process the main radioactive nuclide, radium, largely remains in the insoluble residue from phosphate rock.

Valorisation of the insoluble residue from phosphate rock: the valorisation of the solid residual substances as the secondary raw material in the fluorine industry is reported to be impossible due to the presence of impurities such as silicon, radium and phosphorus. Also, in the cement industry it is impossible to use the solid effluent due to the presence of phosphorus and radium. In order to reduce the volume of the solid waste to a minimum, a dehydrated form is obtained by filter presses.

Moreover, in this way the dehydrated residual substances are also physically more stable. Due to the fact that the residue is inflammable, landfilling is reported to be carried out in a safe and environmentally sound manner and is in accordance with the new provisions of the European Directive on the dumping of wastes. Special attention is paid to prevent dust, soil and groundwater pollution around the landfill site, as well as to track and monitor the radioactivity in the insoluble residue from phosphate rock.

##### Achieved environmental benefits

The separation of residue (which consists largely of calcium fluoride) from the phosphate rock, brings an environmental benefit, as the fluorine content from phosphate rock is reduced to the insoluble form, before the residue is landfilled.

##### Cross-media effects

The main component in the residue (namely  $\text{CaF}_2$ ) and other inorganic chemical impurities, such as silicon, radium and phosphorus, are landfilled.

##### Operational data

No detailed data submitted (refer to Section 6.4.3.2).

##### Applicability

Applicable to the plants producing feed phosphates by the hydrochloric acid route.

##### Driving force for implementation

The highest quality of the produced feed phosphates.

##### Example reference plants

No data submitted, however, this technique is used in some plants.

##### Reference literature

[65, CEFIC-IFP, 2004], [93, CEFIC-CEEP, 2004].

#### 6.4.4.2.5 Solid effluents – sludge from waste water cleaning

##### Description

When producing high quality feed phosphates by the hydrochloric acid process with a minimum content of undesirable elements, a number of heavy metals deriving from the phosphate rock are passed via digestion, crystallisation and decanting steps of the process and are finally released into the waste water. The waste water streams are purified in different steps before they are discharged and, in particular they do not contain phosphorus because the precipitation of the dicalcium phosphate is carried out in such a way that the precipitation efficiency is maximised.

The sludge containing the heavy elements in a concentrated non-leaching form can be easily dehydrated by filter presses. Due to the fact that the sludge cannot be recycled, and since it is non-flammable, landfilling in a safe and environmentally sound manner is in accordance with the new provisions of the European Directive on the dumping of wastes.

##### Achieved environmental benefits

Waste waters derived from the production of feed phosphates by the hydrochloric acid process route are purified in different process steps, followed by a physico-chemical process before they are discharged to a natural watercourse. This allows a reduced sludge to be obtained that can be easily dehydrated.

##### Cross-media effects

The sludge containing heavy elements in a concentrated non-leaching form, is dehydrated and then landfilled.

##### Operational data

No detailed data submitted (refer to Section 6.4.3.2).

##### Applicability

Applicable to the plants producing feed phosphates by the hydrochloric acid route.

##### Driving force for implementation

The protection of the aquatic environment. The highest quality of the produced feed phosphates.

##### Example reference plants

No data submitted, however, this technique is used in some plants.

##### Reference literature

[65, CEFIC-IFP, 2004], [93, CEFIC-CEEP, 2004].

## 6.5 Best Available Techniques for the production of inorganic phosphates

In understanding this section and its contents, the attention of the reader is drawn back to the preface of this document and in particular the fifth section of the preface: 'How to understand and use this document'. The techniques and associated emission and/or consumption levels, or ranges of levels, presented in this section have been assessed through an iterative process involving the following steps:

- identification of the key environmental issues for the sector:
  - as noted in Section 6.1, all inorganic phosphates are indirectly derived from phosphate rock and, depending on the type of rock and the pretreatment (purification) of the intermediate phosphoric acid used in downstream operations as well as on the required quality of the final products, the impact on the environment varies, with the cross-media effects also varying to a large degree. Detailed comparisons are not possible, as detailed information available on the techniques applied for the purification of non-fertiliser grade wet phosphoric acid are very limited (this process stage being situated outside the scope of this document – refer to Figure 6.1)
  - for detergent-grade phosphate STPP, based on the chemical pretreatment of 'green' phosphoric acid, two main environmental process-related issues can be identified: in the wet stage of the process – the cakes of gypsum and other impurities originating from the raw materials used, and in the dry stage of the process – emissions of fluorine and  $P_2O_5$  droplets and STPP dust. Other gaseous emissions are mainly related to fuels used in the process
  - for food-grade phosphate STPP, based mainly on the purified non-fertiliser grade wet phosphoric acid (or the pure thermal-grade phosphoric acid), the main environmental impact is located upstream in the wet stage of acid purification. In the dry stage of the STPP process, the main issues are again the emissions of fluorine and  $P_2O_5$  droplets and dust. Other gaseous emissions are mainly related to fuels used in the process
  - for feed phosphates, and its main representative DCP, the impact varies depending on the process applied. In the phosphoric acid process route, based on the purified non-fertiliser grade wet phosphoric acid, the main environmental impact is located upstream in the wet stage of acid purification. In the dry stage of the DCP process, the main issues are the emissions of dust to air, and phosphorus to water. In the hydrochloric acid route (based on diluted HCl and phosphate rock), the main environmental issues are relate to the emissions of dust and HCl to air, phosphorus to water, and solids waste (originating from the phosphate rock) to land
- examination of the techniques most relevant to address these key issues
- identification of the best environmental performance levels, on the basis of the available data in the European Union and worldwide
- examination of the conditions under which these performance levels were achieved; such as costs, cross-media effects, and the main driving forces involved in implementation of the techniques
- selection of the best available techniques (BAT) and the associated emission and/or consumption levels for this sector in a general sense, all according to Article 2(11) and Annex IV of the Directive.

Expert judgement by the European IPPC Bureau and the relevant Technical Working Group (TWG) has played a key role in each of these steps and in the way in which the information is presented here.

On the basis of this assessment, techniques, and as far as possible consumption and emission levels associated with the use of BAT, are presented in this chapter that are considered to be appropriate to the sector as a whole and in many cases reflect the current performance of some installations within the sector.

Where emission or consumption levels ‘associated with best available techniques’ are presented, this is to be understood as meaning that those levels represent the environmental performance that could be anticipated as a result of the application, in this sector, of the techniques described, bearing in mind the balance of costs and advantages inherent within the definition of BAT. However, they are neither emission nor consumption limit values and should not be understood as such. In some cases it may be technically possible to achieve better emission or consumption levels but due to the costs involved or cross-media considerations, they are not considered to be appropriate as BAT for the sector as a whole. However, such levels may be considered to be justified in more specific cases where there are special driving forces.

The consumption and emission levels associated with the use of BAT have to be seen together with any specified reference conditions (e.g. averaging periods).

The concept of ‘levels associated with BAT’ described above is to be distinguished from the term ‘achievable level’ used elsewhere in this document. Where a level is described as ‘achievable’ using a particular technique or combination of techniques, this should be understood to mean that the level may be expected to be achieved over a substantial period of time in a well maintained and operated installation or process using those techniques.

Where available, data concerning costs have been given together with the description of the techniques presented in the previous chapter. These give a rough indication about the magnitude of the costs involved. However, the actual cost of applying a technique will depend strongly on the specific situation regarding, for example, taxes, fees, and the technical characteristics of the installation concerned. It is not possible to evaluate such site-specific factors fully in this document. In the absence of data concerning costs, conclusions on economic viability of techniques are drawn from observations on existing installations.

It is intended that the general BAT in this chapter are a reference point against which to judge the current performance of an existing installation or to judge a proposal for a new installation. In this way they will assist in the determination of appropriate ‘BAT-based’ conditions for the installation or in the establishment of general binding rules under Article 9(8). It is foreseen that new installations can be designed to perform at or even better than the general BAT levels presented here. It is also considered that existing installations could move towards the general BAT levels or do better, subject to the technical and economic applicability of the techniques in each case.

While the BAT reference documents do not set legally binding standards, they are meant to give information for the guidance of industry, Member States and the public on achievable consumption and emission levels when using specified techniques. The appropriate limit values for any specific case will need to be determined taking into account the objectives of the IPPC Directive and the local considerations.

**For inorganic phosphates plants in the EU-25, the following are BAT:**

**6.5.1 Detergent-grade STPP product, based on ‘green’ phosphoric acid**

1. Minimise the use of raw materials and energy, and the discharge of solid wastes at the STPP production site by entering into (or maintaining) long term agreements with the suppliers of the merchant grade ‘green’ phosphoric acid on the quality of the supplied acid, and by controlling both the concentration of the acid and the content of the impurities in the acid, on a regular basis (see Sections 6.1, 6.2.2, 6.2.3 and 6.2.4.1).

Similarly, the quality of phosphate rock is important where this is used directly as the phosphate source.



2. Maintain the consumption of main raw materials in the maximum range of 580 – 605 kg P<sub>2</sub>O<sub>5</sub> equivalent and 570 – 600 kg NaOH equivalent per tonne of dry STPP product, by optimising the process operations of pretreatment, neutralisation and purification of merchant grade ‘green’ phosphoric acid (see Sections 6.2.3 and 6.2.4.1).
3. Depending on the quality of ‘green’ acid used and the quality requirements of the final detergent-grade STPP product, reduce the total emissions of solid wastes (e.g. by ensuring that the gypsum produced is of a quality and form that can be, and is, effectively valorised), to the level of 100 – 230 kg of solid waste per tonne of dry STPP product, including non-valorised gypsum and other impurities (see Sections 6.2.3 and 6.2.4.1).
4. Reduce the total emissions of fluorine, phosphate and dust to air respectively to below 0.5 kg F/tonne STPP dry, 0.5 kg P<sub>2</sub>O<sub>5</sub> equivalent/tonne STPP dry (wet airstreams), and 0.9 kg dust/tonne STPP dry (dry airstreams) by applying a suitable combination of preventive and abatement techniques (see Sections 6.2.2, 6.2.3 and 6.2.4.2 through to 6.2.4.4). The AEL for dust is <20 mg/Nm<sup>3</sup> (dry airstreams) and for fluorine is <3 mg F/Nm<sup>3</sup> (dry airstreams).
5. Depending on the concentration of the supplied ‘green’ acid, minimise the total usage of thermal energy within the range of 5 – 12 GJ per tonne of dry STPP product by controlling the concentration of the supplied acid, optimising the process and advanced control of its operation (see Sections 6.2.3 and 6.2.4.2 through to 6.2.4.3).

### **6.5.2 Food and detergent-grade STPP product, based on purified wet phosphoric acid**

1. Reduce the impact on the environment (in particular by eliminating solid wastes originating from the process and reducing the consumption of energy), by selecting either purified non-fertiliser grade wet phosphoric acid or pure thermal grade phosphoric acid for the production of food-grade phosphates, as appropriate (see Sections 6.1 and 6.3.4.1).
2. Maintain the consumption of main raw materials in the maximum range of 581 – 588 kg P<sub>2</sub>O<sub>5</sub> equivalent and 545 – 550 kg NaOH equivalent per tonne of dry food-grade STPP product, by optimising and controlling process parameters (see Sections 6.2.2.3, 6.2.3.6 and 6.2.4.1).
3. Reduce the total emissions of fluorine, phosphate and dust to air respectively to below 0.3 kg F/tonne STPP dry, 0.5 kg P<sub>2</sub>O<sub>5</sub> equivalent/tonne STPP dry (wet airstreams), and 0.9 kg dust/tonne STPP dry (dry airstreams) by applying a suitable combination of preventive and abatement techniques (see Sections 6.2.2, 6.2.3 and 6.2.4.2 through to 6.2.4.4). the AEL for dust is <20 mg/Nm<sup>3</sup> (dry airstreams) and for fluorine is <3 mg F/Nm<sup>3</sup> (dry airstreams).
4. Depending on the concentration of the used purified non-fertiliser grade wet phosphoric acid, minimise the total consumption of thermal energy within the range of 4.8 – 8.3 GJ per tonne of dry food-grade STPP product by controlling the concentration of the supplied acid, and by optimising the process on a regular basis (see Sections 6.2.3, 6.2.4.2, 6.2.4.3, and 6.3.4.1).

### 6.5.3 Feed phosphates – feed-grade DCP product

#### 6.5.3.1 Feed phosphates manufactured by the phosphoric acid route

1. Reduce the impact on the environment (in particular by minimising the quantities of solid wastes originating from the process and reducing the consumption of energy), by selecting for the production of feed-grade phosphates purified non-fertiliser grade wet phosphoric acid of the quality most appropriate for the production of feed phosphates (see Section 6.1).
2. Maintain the consumption of main raw materials: purified feed-grade phosphoric acid and CaO (and/or CaCO<sub>3</sub>) in the maximum range of 0.4 – 0.5 tonnes P<sub>2</sub>O<sub>5</sub> equivalent and 0.2 – 0.3 tonnes Ca equivalent per tonne of 18 % DCP product, by optimising and controlling process parameters (see Section 6.4.3.1).
3. Reduce the content of phosphates in the waste waters to 0 – 5 g P per m<sup>3</sup> of waste water by recovery of the spills from acid conditioning and reaction, and the re-use of water (see Sections 6.4.3.1 and 6.4.4.1).
4. Reduce total dust emissions to air to <20 mg/Nm<sup>3</sup> (dry airstreams) in the exhaust gas by using a suitable combination of preventive measures and dedusting techniques (see Sections 6.4.3.1 and 6.4.4.1.2).
5. Depending on the concentration of the used purified non-fertiliser grade wet phosphoric acid, minimise the total consumption of the energy within the range of 40 – 350 kWh per tonne of dry feed-grade 18 % DCP product by controlling the concentration of the supplied acid, and by optimising the process on a regular basis (see Sections 6.4.2.1.1 and 6.4.3.1).

#### 6.5.3.2 Feed phosphates manufactured by the hydrochloric acid route

1. Reduce the impact on the environment (in particular by utilising the waste stream of hydrochloric acid), by integrating the production of feed-grade dicalcium phosphate with the production of potassium sulphate, thus allowing minimisation of the consumption of raw materials and energy (see Section 6.4.4.2.1).
2. Maintain the consumption of main raw materials: phosphate rock, hydrochloric acid and CaO, CaCO<sub>3</sub>, and/or Ca(OH)<sub>2</sub>, in the maximum range of: 1.30 – 1.50 tonnes phosphate rock, 0.6 – 0.8 tonnes 100 % HCl, and 0.125 – 0.290 tonnes Ca per tonne of 18 % DCP product, by optimising and controlling process parameters (see Section 6.4.3.2).
3. Reduce the content of phosphates in the waste waters to 1 – 8 g P per m<sup>3</sup> of waste water by purifying waters in the process, the re-use of water, and by liquid effluent treatment (see Sections 6.4.3.2, 6.4.4.2.3 and 6.4.4.2.5).
4. Reduce total dust emissions to air from the drying process towards the lower level of the operational range of 10 – 50 mg dust per Nm<sup>3</sup> of the exhaust gas (dry airstreams) and from the other steps towards the lower level of the operational range of 10 - 20 mg/Nm<sup>3</sup> (dry airstreams), by using a suitable combination of preventive measures and dedusting techniques (see Sections 6.4.3.2 and 6.4.4.2.2).
5. Reduce emissions of hydrogen chloride to air towards the lower level of the operational range of 10 – 30 mg HCl per Nm<sup>3</sup> of the exhaust gas by using a suitable combination of preventive measures and wet scrubbers, also allowing the reduction of odour emissions (see Sections 6.4.3.2 and 6.4.4.2.2).

6. Minimise the discharge of solid waste from the process to 100 – 240 kg per tonne of 18 % DCP product, by controlling the purity of the phosphate rock used in the process on a regular basis (see Sections 6.4.3.2 and 6.4.4.2.4).
7. Minimise the total consumption of the energy within the range of 550 – 1150 kWh per tonne of dry feed-grade 18 % DCP product by controlling operational parameters, and by optimising the process (see Sections 6.4.2.2.1, 6.4.3.2 and 6.4.4.2.1).

## 7 SELECTED ILLUSTRATIVE LVIC-S INDUSTRY PRODUCTS

### 7.1 Aluminium fluoride

#### 7.1.1 General information

In addition to cryolite, aluminium fluoride ( $\text{AlF}_3$ ) is primarily used as a fluxing agent for the electrolysis of aluminium, but also in the glass industry and in the enamel industry for the production of white enamels. According to IFPA statistics [85, EIPPCB, 2004-2005], Table 7.1 shows estimated 2003 capacities for aluminium fluoride in kt per year:

World	North America	South America	Western Europe	Eastern Europe	Asia	Japan	Africa
630	169	15	112	105	189	?	40

**Table 7.1: Aluminium fluoride capacities in 2003 by region [85, EIPPCB, 2004-2005]**

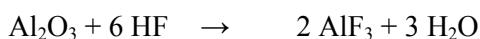
Within the EU/EEA region,  $\text{AlF}_3$  is produced in Italy, Norway, Spain and Sweden, and the total EU/EEA production amounted to 106765 tonnes in 2000 [68, Norwegian Pollution Control Authority, 2003].

Aluminium fluoride is essentially used in metal aluminium production to adjust the physical properties (e.g. the melting point) of the content of the aluminium electrolysis cells [6, CEFIC, 2002], refer also to the BREF on the Non Ferrous Metals Industries.

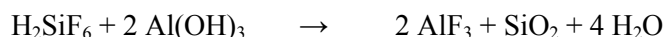
As the fluorine emissions to air of aluminium cells have been lowered very significantly in the last 30 years, the consumption of aluminium fluoride has decreased sharply (the specific consumption of cryolite  $\text{AlF}_3 \cdot 3 \text{NaF}$  was also reduced for the same reasons).

The following two main industrial processes are currently used for  $\text{AlF}_3$  production; the dry fluorspar process and the wet fluosilicic acid (FSA) process:

From the reaction of gaseous hydrogen fluoride on alumina according to the following reaction:



From the liquid phase reaction of by-product hexa-fluosilicic acid solutions (see the BREF on LVIC-AAF) with aluminium hydroxide according to the following reaction [6, CEFIC, 2002]:



The dry fluorspar process yields a high density (1.4 – 1.6 kg/l)  $\text{AlF}_3$  product, while the wet process yields a low density (0.7 – 0.8 kg/l) product. High density  $\text{AlF}_3$  is the preferred product for aluminium smelters using point feeders.

Based on the information from Sweden [85, EIPPCB, 2004-2005], in aluminium smelting the preferred density is the one equal to the density of  $\text{Al}_2\text{O}_3$ . Both, low density and high density  $\text{AlF}_3$ , can be used in all types of feeding systems. The low density  $\text{AlF}_3$  product contains a higher content of  $\text{AlF}_3$  than the high density product, which has a higher content of impurities.

High density  $\text{AlF}_3$  production (dry fluorspar process) generates 2.4 tonnes of waste anhydrite per one tonne of  $\text{AlF}_3$ .

In turn, the wet FSA process (production of low density  $\text{AlF}_3$ ) generates 0.67 tonnes of by-product  $\text{SiO}_2$  and 0.26 tonnes of  $\text{CaF}_2$  per one tonne of  $\text{AlF}_3$  [85, EIPPCB, 2004-2005].

## 7.1.2 Industrial processes applied

### 7.1.2.1 Dry fluorspar process

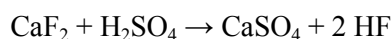
Although the wet FSA process becomes more and more important, the dry fluorspar process is the dominating process worldwide, counting for approximately 65 % of total  $\text{AlF}_3$  production. The main raw materials in the dry fluorspar process are fluorspar ( $\text{CaF}_2$ ), aluminium hydroxide ( $\text{Al}(\text{OH})_3$ ) and sulphuric acid ( $\text{H}_2\text{SO}_4$ ). The fluorspar comes originally from mines.

The two main steps of the process are:

- (1) the generation of gaseous HF from fluorspar and sulphuric acid
- (2) the production of  $\text{AlF}_3$  from gaseous HF and  $\text{Al}(\text{OH})_3$  (activated to  $\text{Al}_2\text{O}_3$ ).

#### 7.1.2.1.1 Generation of gaseous HF

Dried fluorspar and sulphuric acid (refer also to the BREF on LVIC-AAF) may be preheated to 120 – 150 °C and fed into a rotary kiln, often via a pre-reactor. In a pre-reactor the residence time is typically a few minutes, and the conversion rate is usually 30 – 50 %. The conversion is completed in a directly or indirectly heated rotary kiln where the temperature of the reactants is raised to 200 – 300 °C at the outlet end of the kiln. The residence time in the rotary kiln is typically 4 – 6 hours. The overall reaction can be described by the following equation:



The reaction is endothermic, so it requires a continuous input of heat for its completion. Oil or gas is usually used for the drying of fluorspar, the preheating of the reactants and the heating of the rotary kiln.

Some of the producers introduce the HF gas directly into the  $\text{AlF}_3$  reactor while some producers go via liquid HF, which is then evaporated. This latter process is often referred to as the wet HF process, and counts for approximately 18 % of the world production of  $\text{AlF}_3$ .

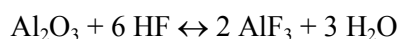
Synthetic anhydrite is removed from the rotary kiln outlet end as a waste product and either transported to a landfill or discharged as slurry to the sea. However, the anhydrite waste might also be further processed to obtain a saleable product. The anhydrite is then cooled down and traces of sulphuric acid are neutralised with lime before the product is ground to the required fineness.

Synthetic anhydrite has some important advantages over natural anhydrite, notably the fine crystal structure and the unchanging chemical composition. Synthetic anhydrite from  $\text{AlF}_3$  plants is used mainly for the construction of self levelling floors, as an additive to cement production and in the fertiliser industry.

The effluent gas from the rotary kiln contains 40 – 100 % HF and is passed through scrubbers to remove dust, elemental sulphur and other impurities before it is used to synthesise  $\text{AlF}_3$ .

#### 7.1.2.1.2 $\text{AlF}_3$ reaction

$\text{Al}(\text{OH})_3$  is transformed to  $\text{Al}_2\text{O}_3$  by heating it up to approximately 400 °C, and  $\text{Al}_2\text{O}_3$  is then fed into a fluidised bed reactor where the reaction with gaseous HF takes place according to the following overall equation:



This reaction takes place in a single or multi-bed fluidised reactor. The reaction is exothermic, and external heat is needed only for start-up, to heat the reactor.

Depending on the HF recovery system, a yield of 94–98 % based on HF entering the aluminium fluoride reactor is achieved.

The flow sheet of aluminium fluoride production by the dry fluorspar process route is given in Figure 7.1.

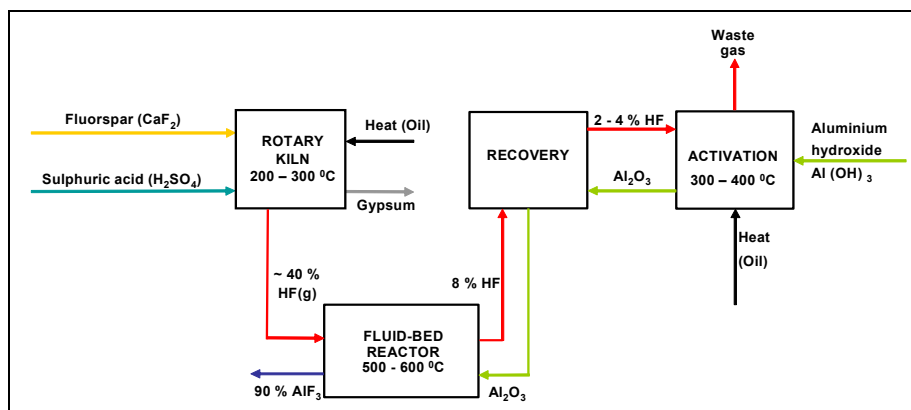


Figure 7.1: Flow sheet of aluminium fluoride production by the dry fluorspar process [68, Norwegian Pollution Control Authority, 2003]

### 7.1.2.1.3 Abatement techniques

Effluent gases from the production of  $\text{AlF}_3$  are cleaned by passing the gas through cyclones (pretreatment for dust) and one or several wet scrubbers for the removal of HF, sulphur compounds and dust before being emitted to the atmosphere. The emissions of HF are reduced by >99 % in this type of treatment system.

Fabric filters are used to reduce dust emissions from the drying of fluorspar and from storage silos for raw materials (fluorspar, lime) and products ( $\text{AlF}_3$ , anhydrite).

The anhydrite waste can be recovered and further processed to obtain a saleable product, as described above. Landfilling of the remaining gypsum waste may be used, provided that the landfill is operated in compliance with the provisions of the EU Directive on the landfill of waste.

Disposal of anhydrite waste into a seawater recipient may be considered only in the case when a site-specific evaluation proves this to be environmentally acceptable and not in violation with requirements of the EU Water Framework Directive [68, Norwegian Pollution Control Authority, 2003].

### 7.1.2.2 Wet FSA process

This process route accounts for about 17 % of the world production of  $\text{AlF}_3$ , but the importance of this process is still growing [85, EIPPCB, 2004-2005]. The main raw materials used are fluosilicic acid ( $\text{H}_2\text{SiF}_6$ ), which is a fluorine source, and aluminium hydroxide ( $\text{Al}(\text{OH})_3$ ).

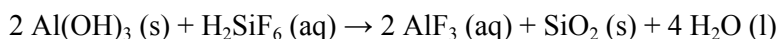
Fluosilicic acid (FSA) is mainly a by-product of the conversion of apatite (or phosphate rock) to phosphoric acid and phosphate fertilisers (see the BREF on LVIC-AAF), and is readily available in certain parts of the world.

World production of FSA was around 1650000 tonnes in 1998, and only a minor part of this is re-used today. FSA represents a potential pollution problem in phosphoric acid/phosphate fertiliser industries, and the utilisation for  $\text{AlF}_3$  production is, therefore, beneficial [68, Norwegian Pollution Control Authority, 2003].

The FSA process is divided into four main steps, namely: reaction, crystallisation, drying and calcination [85, EIPPCB, 2004-2005].

### 7.1.2.2.1 Reaction step

In the reaction step, fluorosilicic acid is heated and batched into a reactor together with aluminium hydroxide. The reaction is exothermic, thereby raising the temperature of the reacting mixture to approximately 100 °C. During the reaction, a precipitate of amorphous silica,  $\text{SiO}_2$ , and an aqueous solution of  $\text{AlF}_3$  are yielded. The overall reaction is:



The precipitated silica is removed from the aluminium fluoride solution by filtration.

### 7.1.2.2.2 Crystallisation

After separating the amorphous  $\text{SiO}_2$  from the liquid, the meta-stable  $\text{AlF}_3$  solution is transferred to crystallisers, where crystallisation to solid aluminium fluoride trihydrate,  $\text{AlF}_3 \cdot 3\text{H}_2\text{O}$ , takes place. The resulting crystals of aluminium fluoride trihydrate are separated from the aqueous phase. The crystals hold approximately 5 – 10 % free moisture. The aqueous phase is pH adjusted with lime yielding a precipitate of calcium fluoride ( $\text{CaF}_2$ ), which is removed from the liquid.

### 7.1.2.2.3 Drying

After centrifuging, the crystals of  $\text{AlF}_3 \cdot 3 \text{H}_2\text{O}$  are fed to a drying step. When the solid material exits the drying step, it has a composition approximately equal to  $\text{AlF}_3 \cdot 0.15 \text{H}_2\text{O}$ .

### 7.1.2.2.4 Calcination

In order to remove the final fractions of crystal water, calcination is necessary. The material is fed to a calcination oven operating at a high temperature. The resulting product is a water-free  $\text{AlF}_3$ .

All effluent gases pass through bag filters for dust removal, before being scrubbed in absorption towers, this reducing the fluorine content of the gases to a minimum before they are discharged to the atmosphere. The liquid effluent from the process consists of scrubbing water, mother liquor and cleaning water. These streams are collected and neutralised with lime giving mainly calcium fluoride, which is either sent to deposit or commercialised.

### 7.1.3 Present consumption and emission levels

#### 7.1.3.1 Dry fluorspar process

Typical consumption levels for the dry fluorspar process are summarised in Table 7.2 [68, Norwegian Pollution Control Authority, 2003].

Raw material/ energy carrier	Typical specific consumption levels (per tonne AlF <sub>3</sub> produced)
CaF <sub>2</sub>	1.54 t/t
H <sub>2</sub> SO <sub>4</sub>	1.85 t/t
Al(OH) <sub>3</sub>	1.03 t/t
Ca(OH) <sub>2</sub> <sup>(2)</sup>	0.03 t/t
Fuel, HF section <sup>(3)</sup>	(4.5 GJ/t)
Fuel, AlF <sub>3</sub> section <sup>(1)</sup>	21 GJ per start-up
Electricity	0.165 MWh/t
Steam	0.2 t/t
<sup>(1)</sup> Used only during start-up of reactor from cold conditions <sup>(2)</sup> Typical for the Norwegian plant. In fact, the consumption of Ca(OH) <sub>2</sub> depends on many factors <sup>(3)</sup> Typical for the Norwegian plant, where the HF unit is an integral part of the AlF <sub>3</sub> plant. The consumption of fuel depends on the 'battery limits' chosen for the AlF <sub>3</sub> plant and, for the comparison with the wet FSA process, this usage of fuel should not be taken into account. Refer also to the BREF on LVIC-AAF.	

**Table 7.2: Consumption of raw materials and energy carriers**  
[68, Norwegian Pollution Control Authority, 2003], [85, EIPPCB, 2004-2005]

An example of specific emissions to air from an AlF<sub>3</sub> plant in Norway using the dry fluorspar process is given in Table 7.3.

Component	Specific emissions (per tonne AlF <sub>3</sub> produced)
SO <sub>2</sub> <sup>(1)</sup>	0.07 kg/t
NO <sub>x</sub> <sup>(1)</sup>	0.39 kg/t
CO <sub>2</sub> <sup>(1)</sup>	0.41 tonne/t
Fluoride <sup>(3)</sup>	0.01 kg/t
Dust <sup>(3)</sup>	0.05 kg/t
Hg <sup>(2)</sup>	0.08 g/t
<sup>(1)</sup> Typical for the Norwegian plant, where the HF unit is an integral part of the AlF <sub>3</sub> plant and where light oil is employed as a fuel. Lower emission values are relevant where natural gas is used. <sup>(2)</sup> Typical for the Norwegian plant, for which data are presented here. According to other sources (IFPA, Italy), there is no justification for any Hg emissions to air. <sup>(3)</sup> Only F and dust emissions are considered typical for the dry AlF <sub>3</sub> fluorspar process (IFPA, Italy).	

**Table 7.3: Emissions to air – dry fluorspar AlF<sub>3</sub> production process (2001)**  
[68, Norwegian Pollution Control Authority, 2003], [85, EIPPCB, 2004-2005]

In turn, an example of specific emissions to water from an AlF<sub>3</sub> plant in Norway using the dry fluorspar process is given in Table 7.4.

Component <sup>(2)</sup>	Specific discharges (per tonne AlF <sub>3</sub> produced)
Anhydrite	2.4 t/t <sup>(1)</sup>
SO <sub>2</sub>	71.7 kg/t
Fluoride	5.1 kg/t
Hg	0.04 g/t
Pb	0.16 kg/t
Sulphuric acid	15.0 kg/t
<sup>(1)</sup> Part of the total amount was sold as a product. <sup>(2)</sup> Typical for the Norwegian plant, for which data are presented here – disposal route to the sea.	

**Table 7.4: Discharges to sea – dry fluorspar AlF<sub>3</sub> production process (2001)**  
[68, Norwegian Pollution Control Authority, 2003], [85, EIPPCB, 2004-2005]



It should be stressed, that for anhydrite the Norwegian  $\text{AlF}_3$  plant mainly uses the disposal route to the sea. This is an exception to a normal situation in which discharges from the typical  $\text{AlF}_3$  plant to water contain F, suspended solids and  $\text{SO}_4$ .

Due to the common water treatment typically applied at the site, as well as different absorption capacity of the reception media, it is not possible to determine exact values – refer to the BREF on CWW.

Alternative methods of disposal (re-use or landfill of anhydrite) should be evaluated, taking into consideration information on contaminants present in the sludge [85, EIPPCB, 2004-2005] – refer also to the BREF on LVIC-AAF.

### 7.1.3.2 Wet FSA process

Typical consumption levels for the wet fluorosilicic acid process are summarised in Table 7.5 below.

Raw material/ energy carrier	Typical specific consumption levels (per tonne $\text{AlF}_3$ produced)
Fluosilicic acid (as 100 % $\text{H}_2\text{SiF}_6$ )	1.2 t/t <sup>(1)</sup>
$\text{Al}(\text{OH})_3$	1.03 t/t <sup>(2)</sup>
$\text{Ca}(\text{OH})_2$	0.09 t/t <sup>(3)</sup>
Fuel (LPG + natural gas)	1.37 MWh/t <sup>(4)(5)</sup>
Electricity	0.3365 MWh/t

<sup>(1)</sup> Based on the Polish data [79, BIPROK WAS, 1985-1995]  
<sup>(2)</sup> Consumption of  $\text{Al}(\text{OH})_3$  in the wet FSA process is quoted the same as in the dry fluorspar process.  
<sup>(3)</sup> Typical for the Swedish plant. In fact, the consumption of  $\text{Ca}(\text{OH})_2$  depends on many factors  
<sup>(4)</sup> Typical for the Swedish plant, where the fluorine content ( $\text{H}_2\text{SiF}_6$ ) is supplied from outside of the  $\text{AlF}_3$  plant. The consumption of fuel depends on the 'battery limits' chosen for the  $\text{AlF}_3$  plant.  
<sup>(5)</sup> Steam generator heated with natural gas. Energy consumption for steam included in the fuel.

**Table 7.5: Consumption of raw material and energy in the wet FSA process [68, Norwegian Pollution Control Authority, 2003] [85, EIPPCB, 2004-2005]**

Examples of specific emissions to air from an  $\text{AlF}_3$  plant in Sweden using the wet FSA process are given in Table 7.6 below.

Component	Specific emissions (per tonne $\text{AlF}_3$ produced)
$\text{NO}_x$ <sup>(1)</sup>	0.21 kg/t
$\text{CO}_2$ <sup>(1)</sup>	277 kg/t
Fluoride <sup>(2)</sup>	0.015 kg/t
Dust <sup>(2)</sup>	0.004 kg/t

<sup>(1)</sup> Typical for the Swedish plant based on the wet FSA process, where LPG and natural gas are used as fuels.  
<sup>(2)</sup> Typical for the Swedish  $\text{AlF}_3$  plant, for which data are presented here.

**Table 7.6: Emissions to air from  $\text{AlF}_3$  plant using the wet FSA process [68, Norwegian Pollution Control Authority, 2003] [85, EIPPCB, 2004-2005]**

Specific emissions to water from an  $\text{AlF}_3$  plant in Sweden using the wet FSA process are given in Table 7.7 below.

Component <sup>(1)</sup>	Specific discharges (per tonne AlF <sub>3</sub> produced)
SO <sub>2</sub>	0.0048 kg/t
Fluoride	0.107 kg/t
Hg	0.62 mg/t
Pb	5.98 mg/t

<sup>(1)</sup> Typical for the Swedish AlF<sub>3</sub> plant, for which the data are presented here. It should be noted that both, by-produced synthetic silica (0.67 t SiO<sub>2</sub>/t AlF<sub>3</sub>) and calcium fluoride (0.26 t CaF<sub>2</sub>/t AlF<sub>3</sub>) are sold.

**Table 7.7: Emissions to water from AlF<sub>3</sub> plant using the wet FSA process [68, Norwegian Pollution Control Authority, 2003] [85, EIPPCB, 2004-2005]**

### 7.1.4 Techniques to consider in the determination of BAT

This section sets out techniques considered generally to have potential for achieving a high level of environmental protection in the industries within the scope of the document. Management systems, process-integrated techniques and end-of-pipe measures are included, but a certain amount of overlap exists between these three when seeking the optimum results. Prevention, control, minimisation and recycling procedures are considered as well as the re-use of materials and energy.

Techniques may be presented singly or as combinations to achieve the objectives of IPPC. Annex IV to the Directive lists a number of general considerations to be taken into account when determining BAT and techniques within this section will address one or more of these considerations.

As far as possible a standard structure is used to outline each technique, to enable comparison of techniques and an objective assessment against the definition of BAT given in the Directive.

The content of this section is not an exhaustive list of techniques and others may exist or be developed which may be equally valid within the framework of BAT.

Generally a standard structure is used to outline each technique, as shown in Table 7.8:

Type of information considered	Type of information included
Description	Technical description of the technique
Achieved environmental benefits	Main environmental impact(s) to be addressed by the technique (process or abatement), including emission values achieved and efficiency performance. Environmental benefits of the technique in comparison with others
Cross-media effects	Any side-effects and disadvantages caused by implementation of the technique. Details on the environmental problems of the technique in comparison with others
Operational data	Performance data on emissions/wastes and consumption (raw materials, water and energy). Any other useful information on how to operate, maintain and control the technique, including safety aspects, operability constraints of the technique, output quality, etc.
Applicability	Consideration of the factors involved in applying and retrofitting the technique (e.g. space availability, process specific)
Economics	Information on costs (investment and operation) and any possible savings (e.g. reduced raw material consumption, waste charges) also as related to the capacity of the technique
Driving force for implementation	Reasons for implementation of the technique (e.g. other legislation, improvement in production quality)
Example plants	Reference to a plant where the technique is reported to be used
Reference literature	Literature for more detailed information on the technique

**Table 7.8: Information breakdown for each technique described in this section**

Reference is to be made here also to Section 8.9, providing key information on the Environmental Management System (EMS) which is a tool for IPPC installations that operators can use to address the design, construction, maintenance, operation and decommissioning issues in a systematic demonstrable way.

Techniques broadly applicable in the chemical industry, are not included in the respective Sections 4 of this Chapter 7 (refer to the BREF on CWW).

### 7.1.4.1 $\text{AlF}_3$ production by the dry fluorspar process

Aluminium fluoride production by the dry fluorspar process is the dominating process route used worldwide, in which the main process inputs are: fluorspar, sulphuric acid, aluminium hydroxide, and fuel, such as heating oil or natural gas, while the main process outputs are: aluminium fluoride product, synthetic anhydrite, and waste gas. The following three techniques to consider in the determination of BAT have been identified with regard to the production of aluminium fluoride based on the dry fluorspar process.

#### 7.1.4.1.1 Usage of pure raw materials and the recovery of synthetic anhydrite

##### Description

Trace elements like mercury and lead are present in variable amounts in the raw materials. When alternatives exist, raw materials containing less trace elements are used, to obtain a high quality  $\text{AlF}_3$  product and to allow for the recovery of synthetic anhydrite from the process. Synthetic anhydrite is removed from the process as a waste product. However, it can also be processed to obtain a saleable product. The anhydrite is then cooled down and traces of sulphuric acid are neutralised with lime before the product is ground to the required fineness. Synthetic anhydrite has some important advantages over natural anhydrite, notably the fine crystal structure and the unchanging chemical composition. Synthetic anhydrite from  $\text{AlF}_3$  plants is used mainly for the construction of self levelling floors, as an additive to cement production and in the fertiliser industry.

Synthetic anhydrite is the main waste product of the dry fluorspar process. Conversion of waste anhydrite into a saleable product will, therefore, improve the overall yield of the process and reduce the amount of waste that otherwise will have to be disposed of.

Landfilling of the waste anhydrite may be considered if there are no possibilities for selling the synthetic anhydrite, and provided that the landfill is operated in compliance with the provisions of the EU Landfill Directive.

Disposal of gypsum waste into a seawater recipient may be considered only if there are no possibilities for selling the synthetic anhydrite, and a site-specific evaluation proves this to be environmentally acceptable and not in violation of the requirements in the EU Water Framework Directive.

##### Achieved environmental benefits

There is at least partial recovery and utilisation of synthetic anhydrite, that otherwise would have to be landfilled or discharged of as slurry into the sea.

##### Cross-media effects

Synthetic anhydrite from the production of  $\text{AlF}_3$  will share market competition with the white gypsum from the production of titanium dioxide and with natural anhydrite.

##### Operational data

As much as 2.4 tonnes of synthetic anhydrite is generated per one tonne of  $\text{AlF}_3$  produced (refer to Section 7.1.3.1 above). The purer the raw materials for the production of  $\text{AlF}_3$ , the better the quality of the synthetic anhydrite by-product and the better the prospects for its selling.

Applicability

Applicable to the plants producing  $\text{AlF}_3$  by the dry fluorspar process.

Economics

No data submitted.

Driving force for implementation

The protection of the environment by reducing the amount of waste to be disposed of.

Example plants

This technique is partially applied in the Norwegian  $\text{AlF}_3$  plant (see Table 7.4).

Reference literature

[68, Norwegian Pollution Control Authority, 2003].

**7.1.4.1.2 Energy recovery from the hot process gases**Description

The use of hot process gases for drying and preheating purposes is a technique to consider for reducing overall and specific energy consumption.

Achieved environmental benefits

Less energy is required for the production of  $\text{AlF}_3$ . This results in the lower usage of fuel, such as heating oil or natural gas, and in the reduction of gaseous emissions from the combustion of the fuels.

Cross-media effects

No side effects or disadvantages are caused by the implementation of this technique.

Operational data

No detailed data submitted. The following information shows the approximate ranges of the temperature of the gases at the outlets of:

- the rotary kiln, about 200 – 300 °C
- the activator, about 300 – 400 °C
- the fluid-bed reactor, about 500 – 600 °C.

The gradients of temperature between the hot process gases and the raw materials, are high enough to recover the energy from the hot process gases and to use it for drying fluorspar and preheating the reactants.

Applicability

Applicable to the plants producing  $\text{AlF}_3$  by the dry fluorspar process.

Economics

No data submitted.

Driving force for implementation

Improved energy efficiency of the process, decreased manufacturing cost of  $\text{AlF}_3$  production.

Example plants

This technique is applied in the Norwegian  $\text{AlF}_3$  plant.

Reference literature

[68, Norwegian Pollution Control Authority, 2003].

### 7.1.4.1.3 Abatement of effluent gases and dust from the production of $\text{AlF}_3$

#### Description

Effluent gases from the production of  $\text{AlF}_3$  by the dry fluorspar process contain fluoride and sulphur compounds and need to be scrubbed before being emitted to the atmosphere. It might be necessary to use a series of washing steps to reach acceptable concentrations in the off-gas.

Effluent air from storage silos of raw material and also products from various drying operations can be treated in dry filter systems. For some types of dust, concentrations of  $1 - 5 \text{ mg/Nm}^3$  in the off-gas can be achieved in a well designed, well maintained and well operated fabric filter.

Raw materials are handled and stored in such a way that dust emissions and discharges to water and soil are minimised. The techniques described in the BREF on Emissions from Storage, are relevant in this context.

#### Achieved environmental benefits

The reduction of the emission levels to air. Refer to data included in Table 7.3.

#### Cross-media effects

No side effects or disadvantages are caused by the implementation of this technique.

#### Operational data

No detailed data submitted. Refer to Table 7.3.

#### Applicability

Applicable to the plants producing  $\text{AlF}_3$  by the dry fluorspar process.

#### Economics

No data submitted.

#### Driving force for implementation

The protection of the environment.

#### Example plants

This technique is applied in the Norwegian  $\text{AlF}_3$  plant.

#### Reference literature

[68, Norwegian Pollution Control Authority, 2003].

### 7.1.4.2 $\text{AlF}_3$ production by the wet fluosilicic acid process

#### Description

Aluminium fluoride production by the wet fluosilicic acid process is the second  $\text{AlF}_3$  production process route, in which the main process inputs are: fluosilicic acid and aluminium hydroxide, while the main process outputs are: aluminium fluoride product and the by-product raw silica, whereas calcium fluoride is a second by-product.

Fluosilicic acid (FSA) is a by-product of the fertiliser industry and is usually available in the chemical industrial complexes producing phosphoric acid and/or phosphate fertilisers. FSA represents a pollution problem in these industries, and the utilisation of FSA for  $\text{AlF}_3$  production is, therefore, beneficial.

Different wet FSA process configurations and equipment arrangements are possible, the most characteristic feature of this process being the usage of fluosilicic acid, which otherwise would have to be neutralised and discharged into the waste water system.

Process improvements are typically aimed at the maximum utilisation of the by-produced raw silica and calcium fluoride into saleable products, as this improves the overall yield of the process and reduces the amount of solid waste that is disposed of from the process.

#### Achieved environmental benefits

At least partial utilisation of fluosilicic acid, the discharges of fluorine compounds that are very harmful to the environment.

#### Cross-media effects

Apart from the raw silica by-product, a sludge is generated in the process that contains calcium, aluminium and silica compounds originating from the impurities included in the raw materials.

#### Operational data

Refer to Sections 7.1.2.2 and 7.1.3.2 above. Drying and calcination of the  $\text{AlF}_3$  product are both associated with the usage of combustibles (LPG or natural gas). The effluent gases from the process are scrubbed to remove fluorine before being discharged to the atmosphere.

The liquid effluent from the process consists of scrubbing water, mother liquor and cleaning water. These streams are collected and neutralised with lime giving mainly calcium fluoride, which is either sent to deposit or commercialised.

#### Applicability

Applicable to the plants producing  $\text{AlF}_3$  by the wet FSA process.

#### Economics

No data submitted.

#### Driving force for implementation

The protection of the environment by reducing the amount of waste fluosilicic acid to be disposed of to the waste waters.

#### Example plants

$\text{AlF}_3$  plant in Sweden, based on the wet FSA process. No other recent information available. In the 1980s, the wet FSA process was also operated in Poland, Romania, Tunisia, and Japan.

#### Reference literature

[68, Norwegian Pollution Control Authority, 2003], [79, BIPROKWAS, 1985-1995], [85, EIPPCB, 2004-2005], [48, W. Buchner et al, 1989].

### **7.1.5 Best Available Techniques for the manufacture of aluminium fluoride**

In understanding this section and its contents, the attention of the reader is drawn back to the preface of this document and in particular the fifth section of the preface: 'How to understand and use this document'. The techniques and associated emission and/or consumption levels, or ranges of levels, presented in this section have been assessed through an iterative process involving the following steps:

- identification of the key environmental issues for the sector
- examination of the techniques most relevant to address these key issues
- identification of the best environmental performance levels, on the basis of the available data in the European Union and worldwide
- examination of the conditions under which these performance levels were achieved; such as costs, cross-media effects, and the main driving forces involved in implementation of the techniques
- selection of the best available techniques (BAT) and the associated emission and/or consumption levels for this sector in a general sense, all according to Article 2(11) and Annex IV of the Directive.

Expert judgement by the European IPPC Bureau and the relevant Technical Working Group (TWG) has played a key role in each of these steps and in the way in which the information is presented here.

On the basis of this assessment, techniques, and as far as possible consumption and emission levels associated with the use of BAT, are presented in this chapter that are considered to be appropriate to the sector as a whole and in many cases reflect the current performance of some installations within the sector. Where emission or consumption levels ‘associated with best available techniques’ are presented, this is to be understood as meaning that those levels represent the environmental performance that could be anticipated as a result of the application, in this sector, of the techniques described, bearing in mind the balance of costs and advantages inherent within the definition of BAT. However, they are neither emission nor consumption limit values and should not be understood as such. In some cases it may be technically possible to achieve better emission or consumption levels but due to the costs involved or cross-media considerations, they are not considered to be appropriate as BAT for the sector as a whole. However, such levels may be considered to be justified in more specific cases where there are special driving forces.

The consumption and emission levels associated with the use of BAT have to be seen together with any specified reference conditions (e.g. averaging periods).

The concept of ‘levels associated with BAT’ described above is to be distinguished from the term ‘achievable level’ used elsewhere in this document. Where a level is described as ‘achievable’ using a particular technique or combination of techniques, this should be understood to mean that the level may be expected to be achieved over a substantial period of time in a well maintained and operated installation or process using those techniques.

Where available, data concerning costs have been given together with the description of the techniques presented in the previous chapter. These give a rough indication about the magnitude of the costs involved. However, the actual cost of applying a technique will depend strongly on the specific situation regarding, for example, taxes, fees, and the technical characteristics of the installation concerned. It is not possible to evaluate such site-specific factors fully in this document. In the absence of data concerning costs, conclusions on economic viability of techniques are drawn from observations on existing installations.

It is intended that the general BAT in this chapter are a reference point against which to judge the current performance of an existing installation or to judge a proposal for a new installation. In this way they will assist in the determination of appropriate ‘BAT-based’ conditions for the installation or in the establishment of general binding rules under Article 9(8). It is foreseen that new installations can be designed to perform at or even better than the general BAT levels presented here. It is also considered that existing installations could move towards the general BAT levels or do better, subject to the technical and economic applicability of the techniques in each case.

While the BAT reference documents do not set legally binding standards, they are meant to give information for the guidance of industry, Member States and the public on achievable consumption and emission levels when using specified techniques. The appropriate limit values for any specific case will need to be determined taking into account the objectives of the IPPC Directive and the local considerations.

Aluminium fluoride is currently produced in the EU using two distinct process routes: the dry fluorspar process and the wet fluosilicic acid process.

Although the dry fluorspar process is still dominant in the EU, the wet fluosilicic acid process is gradually gaining importance as it uses fluosilicic acid by-produced in the fertiliser industry.

However, as both processes use different raw materials and yield different density products (each product having its specific supply-demand balance), neither process is selected as BAT and conclusions for both processes are presented here in parallel, as follows.

**For the production of aluminium fluoride by the dry fluorspar process, BAT is to:**

1. Reduce specific fluorine emissions to air to 0.01 kg F per tonne  $\text{AlF}_3$  produced by using one or a series of washing steps for the efficient removal of HF from the process off-gas (see Sections 7.1.3.1 and 7.1.4.1.3).
2. Maintain total specific dust emissions to air from different sources at a level below 0.05 kg dust per tonne  $\text{AlF}_3$  produced by using a combination of cyclones, wet scrubbers and fabric filters, as appropriate (see Sections 7.1.3.1 and 7.1.4.1.3).
3. Recover energy from the hot process gases leaving the fluid-bed reactor, the activator and the rotary kiln, and use it for drying fluorspar and preheating the reactants in order to improve the overall energy efficiency of the process (see Section 7.1.4.1.2).
4. Maintain discharges of fluoride to water at a level of below 5 kg F per tonne  $\text{AlF}_3$  produced by optimising process parameters and process control (see Section 7.1.3.1).
5. Reduce the amount of solid waste disposed of from the process by maximising the recovery of waste anhydrite and its processing into synthetic anhydrite by-product. The purer the raw materials for the production of  $\text{AlF}_3$ , the better the quality of the synthetic anhydrite by-product and the better the prospects for its sale (see Section 7.1.4.1.1).

**For the production of aluminium fluoride by the wet fluosilicic acid process, BAT is to:**

1. Reduce specific fluorine emissions to air to 0.015 kg F per tonne  $\text{AlF}_3$  produced by using a combination of filters and absorption towers for the efficient removal of fluorine compounds from the process off-gases (see Sections 7.1.3.2 and 7.1.4.2).
2. Reduce specific emissions of fluoride to water to 0.1 kg F per tonne  $\text{AlF}_3$  produced by neutralising liquid effluent streams from the process with lime (see Sections 7.1.3.2 and 7.1.4.2).
3. Reduce the amount of solid waste disposed of from the process by maximising the utilisation of raw silica and calcium fluoride into saleable by-products (see Section 7.1.4.2).

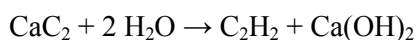


## 7.2 Calcium carbide

### 7.2.1 General information

#### 7.2.1.1 Introduction

Of all the carbides, calcium carbide [87, Ullmann's, 2001] is the most important industrially. It is still the basis of the acetylene welding-gas industry in the world where raw materials and energy are available and petroleum is in short supply, as well as the starting material for the products of declining acetylene chemistry:



The fertiliser cyanamide and derived products are still produced in the world to a limited extent. Calcium carbide is used for the desulphurisation of pig iron and steel, and in foundry technology, where it is mixed with other metal treatment additives.

The world production of calcium carbide has drastically decreased since the mid 1950s, due to the preferred use of petrochemical feedstock in the organic chemical industry (the substitution of acetylene by ethene). In 1982, the world production of  $\text{CaC}_2$  was only 6100 kt per year, and the largest producers with a total world share of over 50 % were China, Germany, Russia and Japan [48, W. Buchner et al, 1989].

The illustration of declining world calcium carbide production [87, Ullmann's, 2001] is given in Table 7.9.

Region	1962	1972	1982	1990
Western Europe	2540	1410	660	500
Eastern Europe	2200	3300	2600	1710
America	1400	710	470	570
Asia and Africa	1860	2080	2670	2080
<b>World production</b>	<b>8000</b>	<b>7500</b>	<b>6400</b>	<b>4860</b>

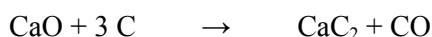
**Table 7.9: World calcium carbide production (kt per year)**  
[87, Ullmann's, 2001]

$\text{CaC}_2$  manufacture is very energy intensive (2800 to 3100 kWh/t) and, therefore, the electricity price is crucial for the economics of carbide production [48, W. Buchner et al, 1989].

Modern large electric furnaces, with power ratings of up to 70 MW, and carbon electrodes are completely closed so that the carbon monoxide by-product can be recovered. Development in recent years has been in the direction of reliable, medium-sized closed furnaces more suited to the market situation and available raw material [87, Ullmann's, 2001], [48, W. Buchner et al, 1989].

Calcium carbide remains a large volume chemical and, although production of acetylene as a building block for the manufacture of organic chemicals has declined, it is still used to produce acetylene for arc-cutting and welding; and finds applications in the desulphurisation of metals [6, CEFIC, 2002].

Calcium carbide is produced at a high temperature (1800–2100 °C) by the reaction of lime with carbon (coke, anthracite):



Since the purity requirements of raw materials are stringent, the feedstock are carefully selected for their low content of metal oxides (Si, Al, Mg, and Fe) which react and give further operating problems. Also, their particle size is adjusted to allow the reaction gas to cross the solid layer in the reactor evenly.

The reaction takes place in an electric furnace, fitted with carbon electrodes dipped deeply into the reaction mixture through the boring of which fines of coke and lime are injected. The rest of the coke and the lime are fed directly into the reaction zone.

A liquid mixture of calcium carbide (80 %) and lime (20 %) is extracted discontinuously from the furnace, the presence of excess lime allowing the mixture to be liquid at the operating temperature of 1800 – 2100 °C. The molten mixture is poured into a sort of foundry ladle where it solidifies as blocks and then cools down slowly.

The off-gas from the furnace is either filtered or scrubbed to remove entrained solids, before being sent to a fuel gas network or used as a process input. Excess off-gas is flared [6, CEFIC, 2002], [85, EIPPCB, 2004-2005].

The blocks of solidified calcium carbide are crushed, and the resulting products are separated by sieving, before being shipped, usually in drums or containers.

Emissions to air, once the reaction off-gas has been combusted, include small quantities of particulates, which the de-dusting system did not remove. Also dust emissions can be encountered during the storage, handling and preparation of feedstock. Emissions to water are when the off-gas is water scrubbed, and they are mainly contaminated by dissolved lime and particulates of coke and lime.

Emissions of solid wastes are not an important issue. However, energy consumption (electricity) is important [6, CEFIC, 2002].

### 7.2.1.2 Basic information on calcium carbide production

In the former EU-15, approx. 300000 tonnes calcium carbide ( $\text{CaC}_2$ ) are produced yearly [60, UBA-Austria, 2004]. After the production of calcium carbide in Norway was stopped, only four calcium carbide sites in the former EU-15 remain. Germany accounts for the largest share (120000 – 130000 tonnes per year), followed by Sweden, Austria and Spain (each around 35000 tonnes per year).

Poland, Slovakia and Slovenia are also reported to produce calcium carbide, however, no data on production capacity are available [85, EIPPCB, 2004-2005].

There are two main applications of calcium carbide in the EU: manufacture of acetylene and desulphurisation of pig iron, cast iron and steel. Acetylene is steadily used in the field of gas welding. The strict standards regarding the sulphur content in the production of steel have led to an increasing importance of the application of calcium carbide [60, UBA-Austria, 2004].

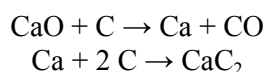
## 7.2.2 Industrial processes used

For the production of calcium carbide, a carbonaceous component and a lime-bearing component are needed. Available carbonaceous materials are coke from bituminous coal or lignite, anthracite, petroleum coke and charcoal. The coke must be dried below 2 % moisture content; the ash content must be below 15 %. For closed furnaces, a grain size of 3 – 25 mm is used.

The lime containing component of the raw material mixture is predominantly quicklime. For closed furnaces the magnesium content should be below 2 % and the grain size should be between 6 and 50 mm. The lime is usually burned in lime kilns to be as soft as possible and to reduce the  $\text{CO}_2$  content to less than 2 % [60, UBA-Austria, 2004].

The principal impurities in the raw materials are iron oxides,  $\text{SiO}_2$ ,  $\text{Al}_2\text{O}_3$ ,  $\text{MgO}$  and compounds of nitrogen, sulphur and phosphorus which cause undesirable side reactions and waste of energy.

In all industrial processes, the raw material mixture is heated to 1800 – 2100 °C. The reaction takes place in two steps:



All the calcium carbide produced today is manufactured by melting the carbonaceous material with  $\text{CaO}$  in an electrothermic furnace. All modern carbide furnaces are now three-phase furnaces where the electrodes are arranged symmetrically around the centre. Well designed circular furnaces have the advantage that high power factors can be achieved. The calcium carbide produced this way is in a liquid state and is then tapped from the bottom of the furnace.

Modern furnaces are closed in order to collect the produced dust-laden furnace gas. The two main components of a closed furnace are the hearth and the electrodes. The hearth usually consists of a welded steel outer casing. The base of the hearth is lined with carbon blocks and rammed carbon; the side walls are lined with refractory bricks or rammed refractory material. Furnaces are equipped with hollow Söderberg electrodes where lime and coke fines are introduced directly into the molten region through a central pipe by a carrier gas ( $\text{CO}$  or  $\text{N}_2$ ).

To tap off the calcium carbide, the furnace is opened mechanically or by burning a tapping hole with an electric arc. The tapping electrode is a 10 – 12 cm thick baked electrode. Modern tapping machines, equipped with a hydraulic manipulator, can carry out all tapping operations, thus reducing tapping personnel.

In order to cool the tapped calcium carbide, most carbide plants use the block casting method. Here, the liquid calcium carbide is tapped off into a ladle or a cast-iron crucible and solidifies to a block. After cooling to approx. 400 °C, the block is crushed usually to <100 mm. Then the desired size grading is obtained by sieving, further crushing or milling. Magnetic separators installed in the size reduction process remove all magnetic impurities.

Figure 7.2 shows the flow sheet of a typical calcium carbide production process. Two options of furnace gas cleaning (dry and wet de-dusting systems) are illustrated in the flow sheet. For specific applications of the furnace gas, an additional waste gas treatment may be necessary.

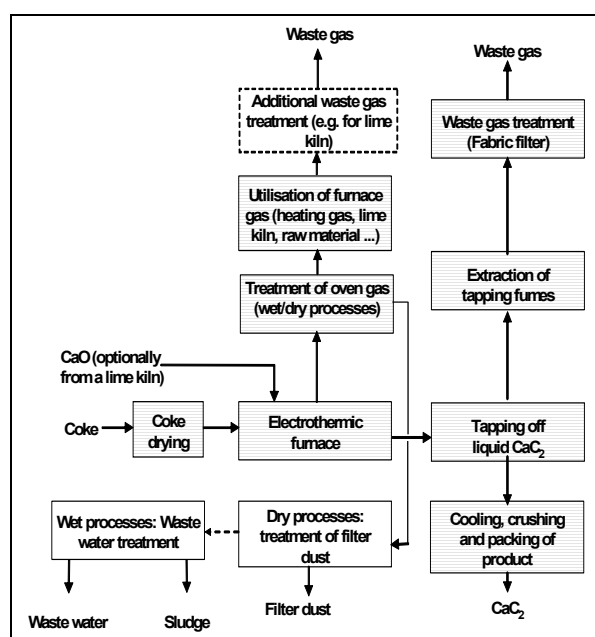


Figure 7.2: Flow sheet of a typical calcium carbide production process [60, UBA-Austria, 2004]

The end-product is a technical-grade calcium carbide of about 80 % CaC<sub>2</sub> content, with calcium oxide the leftover, and mainly SiO<sub>2</sub> and Al<sub>2</sub>O<sub>3</sub> as impurities from raw materials. The calcium carbide product is stored in airtight containers.

## 7.2.3 Present consumption and emission levels

### 7.2.3.1 Emissions to air

The main emissions from the production of CaC<sub>2</sub> are dust, CO<sub>2</sub> and NO<sub>x</sub> mainly from the combustion of the CO rich furnace gas. In case a lime kiln is operated at the same site, emissions of CO<sub>2</sub> from calcination are then also relevant.

The CO furnace gas is a by-product of calcium carbide production. Some carbide producers in the world have developed additional chemical processes to use both products as efficiently as possible. For example, CO gas is an important raw material in the manufacturing of dicyandiamide or cyanamide, as there do not appear to be any CO gas emissions during such an integrated production process.

Emissions of dust can be encountered at various stages over the whole production process. The main source of dust emissions is the dust-laden furnace gas. Depending on the dedusting system, dust emissions from the use of furnace gas are between <5 and 15 mg/Nm<sup>3</sup>. Diffuse emissions arising from the tapping of liquid CaC<sub>2</sub> can be reduced by a fume extraction system and waste gas treatment to a large extent.

Further dust emission sources are from the handling of raw materials, tapping off liquid calcium carbide in the furnace and post-processing the produced calcium carbide until it is stored. Emission sources and data on typical dust emissions from the Austrian plant at different process stages are presented in Table 7.10.

Emission source	Abatement technology	Concentration (mg/Nm <sup>3</sup> )	Emission factor (g dust/t CaC <sub>2</sub> )
Tapping off liquid CaC <sub>2</sub>	Fume extraction and fabric filter	2	9.0
	(With wet scrubber treatment of tapping fumes)		(76)
Coke drying	Fabric filter	5	5.8
Dedusting of raw materials	Fabric filter	3	16.2
Calcium carbide storage	Fabric filter	5	1.6
Wagon tilting plant	Fabric filter	1	0.8
Crushing of CaC <sub>2</sub>	Fabric filter	1	1
<b>CaC<sub>2</sub> production without use of furnace gas</b>			<b>49</b>
Usage of furnace gas (e.g. lime kiln)	Venturi scrubber	15	<b>80.9</b>

**Table 7.10: Emission sources and typical dust emissions from the production of calcium carbide [60, UBA-Austria, 2004]**

Notes regarding emission levels in CaC<sub>2</sub> production in Ruše, Slovenia:

1. A dust content in furnace and tapping gas after the dedusting process is <110 g/t CaC<sub>2</sub> and <3 mg/Nm<sup>3</sup> respectively (common dedusting system for tapping and furnace gas).
2. A final dust content by crushing and packing of CaC<sub>2</sub> (in drums and containers) is <30 g/t CaC<sub>2</sub> and <1 mg/Nm<sup>3</sup> respectively (dust content being dependent on the method of block crushing).

### 7.2.3.2 Emissions to water

One primary usage of water is for the indirect cooling of the furnace and other devices. In this case, water does not get contaminated.

Waste water arises when applying wet dedusting systems. In a plant in Landeck, Austria about 28 - 32 m<sup>3</sup>/t CaC<sub>2</sub> of waste water originates from the wet gas purification system.

Waste water contains cyanides, which have to be removed by chemical treatment, such as oxidation with Cl<sub>2</sub> or H<sub>2</sub>O<sub>2</sub>. Relevant waste water parameters (treatment with Cl<sub>2</sub>) from the Donauchemie 2003 data are presented in Table 7.11.

Parameter	Emission values *	Limit values for discharge into running water **
Total CN	0.4 mg/l	1.0 mg/l
Free Cl <sub>2</sub>	0.12 mg/l	0.2 mg/l
Sulphite	0.4 mg/l	1.0 mg/l
<b>Filterable substances</b>	30 mg/l	50 mg/l
* Internal measurements, average for year 2003.		
** For existing discharge of waste water limit values have to be met from 2008 onwards		

**Table 7.11: Waste water emissions from the production of calcium carbide in Austria [60, UBA-Austria, 2004]**

### 7.2.3.3 Solid wastes

Waste arises from unburned furnace granulate material and from furnace gas cleaning, in the case of applying the wet treatment option. In the wet process for furnace gas cleaning, sludge is produced in the course of the waste water treatment. In the Austrian reference plant, about 1000 tonnes of sludge are produced per year from which around 200 tonnes per year can be recycled back into the production process. The remainder has to be disposed of. Waste on this reference plant consists of 15 % C and 5 – 25 % CaO. The remainder is made up of MgO, Fe<sub>2</sub>O<sub>3</sub>, Al<sub>2</sub>O<sub>3</sub>, SiO<sub>2</sub> and CO<sub>2</sub>. Dust from the filter of dry dedusting systems has a typical composition of 35 - 40 % CaO, 15 – 25 % MgO, 8 % Fe<sub>2</sub>O<sub>3</sub> + Al<sub>2</sub>O<sub>3</sub>, 7 % SiO<sub>2</sub>, 10 % CO<sub>2</sub> and 9 % C. At a German site, unburned furnace granulate material from the production of calcium carbide is partly used in the brickyard. In this case, the deposited waste could be reduced from approx. 6000 m<sup>3</sup> per year to approx. 1500 m<sup>3</sup> per year.

### 7.2.3.4 Raw materials and energy

A modern large furnace without hollow electrodes requires 950 kg lime (94 % CaO), 550 kg coke (dry, 10 % ash), 20 kg electrode material, and 3000 – 3300 kWh electricity per tonne of calcium carbide [87, Ullmann's, 2001]. At the example plant in Landeck, Austria 930 kg lime and 3200 kWh electricity per tonne of calcium carbide are required. Necessary amounts of coke and electrode material are the same as that stated above.

## 7.2.4 Techniques to consider in the determination of BAT

### Introduction: Techniques to consider in the determination of BAT – refer to Section 7.1.4

When analysing the manufacturing process for CaC<sub>2</sub> production in Europe, the following techniques are considered in the determination of BAT [60, UBA-Austria, 2004]:

- total collection of furnace gas, such as with a closed electrothermic furnace
- treatment of furnace gas with dry processes, including the removal of CN from the filter dust or with wet processes, including waste water treatment for CN removal
- use of furnace gas (e.g. for energy purposes)
- collection and treatment of tapping fumes
- waste gas treatment for dust removal from other emission sources (e.g. coke drying, product disaggregation).

These are individually presented below in Sections 7.2.4.1 through to 7.2.4.7.

### 7.2.4.1 Complete collection of furnace gas

#### Description

The CO furnace gas is a by-product of calcium carbide production in plants using closed three-phase furnaces, which permit a complete collection of furnace gas. In the EU, the furnaces are either closed (e.g. Austria, Germany), half-covered (e.g. Sweden) or open type (e.g. Spain, Slovenia). Development in recent years has been in the direction of reliable, medium-sized closed furnaces more suited to the market situation and available raw material.

#### Achieved environmental benefits

Modern electric furnaces are completely closed, so that the dust-laden furnace gas containing the carbon monoxide by-product can be collected, cleaned and then utilised (refer to Section 7.2.4.5), instead of being flared.

#### Cross-media effects

No information submitted.

#### Operational data

As in Section 7.2.3 above. It should be noted that in cases where an open type furnace is used, CO is not collected and, therefore, it is not a usable by-product of calcium carbide production. However, there are other advantages of this process, such as the possibility of selecting a broader range of raw materials used and a very high flexibility of the process.

#### Applicability

Applicable to the plants producing calcium carbide.

#### Economics

No data submitted.

#### Driving force for implementation

The protection of the environment and the utilisation of the energy content in the furnace gas.

#### Example plants

The calcium carbide plant in Landeck, Austria (closed furnace).

The calcium carbide plant in Trostberg, Germany (closed furnace).

The calcium carbide plant in Ruše, Slovenia (open furnace).

#### Reference literature

[60, UBA-Austria, 2004], [87, Ullmann's, 2001], [85, EIPPCB, 2004-2005], [48, W. Buchner et al, 1989], [6, CEFIC, 2002].

### 7.2.4.2 Dry dedusting system for furnace gas cleaning

#### Description

In the dry dedusting process, the furnace gas is, e.g. filtered by self-supporting candle filters made of ceramic fibres. Their surfaces are cleaned offline by jet pulses of previously cleaned gas or nitrogen. A final dust content of  $<1 \text{ mg/Nm}^3$  can be attained. Finally, the hot furnace gas is cooled in a heat exchanger.

It should be noted, that in cases where the open type furnace is used, a final dust content is  $<3 \text{ mg/Nm}^3$ . However, a considerable dilution of the waste gas has to be taken into account.

#### Achieved environmental benefits

The dust-laden furnace gas containing the carbon monoxide by-product is filtered, and then it can be utilised (refer to Section 7.2.4.5).

#### Cross-media effects

The disposal of dust is a problem due to the presence of soluble cyanides. Filter residues have to be calcined in order to destroy the cyanide.

#### Operational data

As in Section 7.2.3 above.

#### Applicability

Applicable to the plants producing calcium carbide.

#### Economics

No data submitted.

#### Driving force for implementation

The protection of the environment and the utilisation of the energy content in the furnace gas.

#### Example plants

The calcium carbide plant in Landeck, Austria (closed furnace).

The calcium carbide plant in Ruše, Slovenia (open furnace).

#### Reference literature

[60, UBA-Austria, 2004], [87, Ullmann's, 2001], [85, EIPPCB, 2004-2005].

### 7.2.4.3 Wet dedusting system for furnace gas cleaning

#### Description

In the wet process, the gas is passed through several washing towers and sprayed with circulating water. In the last stage, Theisen washers (disintegrators) reduce the dust content to approx.  $5 \text{ mg/Nm}^3$ .

In Landeck, Austria the wet process for gas cleaning is applied. In a two-stage washing tower, the carbon monoxide rich gas is purified before entering the lime kiln as combustible. The flue-gas from this downstream lime kiln is then cleaned with a venturi scrubber.

#### Achieved environmental benefits

The dust-laden furnace gas containing the carbon monoxide by-product is washed. Dedusted gas is then utilised (refer to Section 7.2.4.5).

#### Cross-media effects

Applying the wet process for gas purification additionally requires waste water treatment to remove cyanides contained in the dust-laden furnace gas.

Operational data

As in Section 7.2.3 above.

Applicability

Applicable to the plants producing calcium carbide.

Economics

No data submitted.

Driving force for implementation

The protection of the environment and the utilisation of the energy content in the furnace gas.

Example plants

The calcium carbide plant in Landeck, Austria.

Reference literature

[60, UBA-Austria, 2004], [87, Ullmann's, 2001].

**7.2.4.4 Waste water treatment (for the wet dedusting process)**Description

Scrubbing water arising from wet furnace gas treatment (see Section 7.2.4.3 above) contains cyanides which have to be destroyed by chemical treatment. In a sedimentation tank, sewage sludge is removed, washed out (reduction of Mg) and dewatered mechanically in a filter press, and then thermally in a dryer. It then may be partially reinjected through the hollow electrodes, however, magnesium causes problems of evaporation and of crust formation. As is the case in Landeck, Austria, the residual dewatered sludge is dumped. Cyanide in the slurry is also reported to be precipitated as an iron complex and the slurry separated by thickeners (e.g. hydrocyclones). In Landeck, Austria, the waste water treatment comprises chemical cleaning by adding  $\text{Cl}_2$  to destroy the cyanide. Chlorine dosage and control is accomplished by a redox electrode according to the cyanide concentration. The slurry is further treated and partially recycled (up to 20 %) as described above.

Achieved environmental benefits

Scrubbing water from wet furnace gas treatment contains cyanides which are destroyed by chemical treatment, thus reducing the impact of  $\text{CaC}_2$  production on the environment.

Cross-media effects

No information submitted.

Operational data

No other data submitted apart from those included in Section 7.2.3 above.

Applicability

Applicable only to those plants producing calcium carbide, that use the wet dedusting system for furnace gas cleaning.

Economics

No data submitted.

Driving force for implementation

The protection of the aquatic environment.

Example plants

The calcium carbide plant in Landeck, Austria.

Reference literature

[60, UBA-Austria, 2004], [87, Ullmann's, 2001].



#### 7.2.4.5 Use of the furnace gas

##### Description

The furnace gas has a typical composition of 80 – 90 % CO, 1 % CH<sub>4</sub>, 6 – 15 % H<sub>2</sub>, 2 – 7 % N<sub>2</sub> and 0.5 – 3 % CO<sub>2</sub>, depending on the characteristics of the raw material. The carbon monoxide rich furnace gas is usually utilised as fuel after cleaning – see Section 7.2.4.3. The excess carbon monoxide rich gas is flared. Different applications are known for the usage of the furnace gas. In Landeck, Austria, the cleaned furnace gas is used in a lime kiln.

In Trostberg, Germany, the cleaned and compressed furnace gas is transferred to a nearby industrial site where it is used as process heating gas and raw material.

##### Achieved environmental benefits

The dust-laden furnace gas containing carbon monoxide by-product is dedusted and then utilised, instead of being flared.

##### Cross-media effects

No information submitted.

##### Operational data

No detailed data submitted. Refer to Section 7.2.3 above.

##### Applicability

Applicable to the plants producing calcium carbide, integrated either with other downstream plants where the cleaned furnace gas can be utilised or connected to a fuel gas network.

##### Economics

No data submitted.

##### Driving force for implementation

The protection of the environment and the utilisation of the energy content in the furnace gas.

##### Example plants

The calcium carbide plant in Landeck, Austria.

The calcium carbide plant in Trostberg, Germany.

##### Reference literature

[60, UBA-Austria, 2004], [6, CEFIC, 2002].

#### 7.2.4.6 Collection and treatment of tapping fumes

##### Description

Fume extraction equipment is usually used for the removal of fumes arising from tapping. Fabric filters are used for emission reduction. At the example plant in Landeck, dust emissions from tapping were reduced from about 76 g/t CaC<sub>2</sub> to about 9 g/t CaC<sub>2</sub> due to the installation of a fume treatment dry system.

##### Achieved environmental benefits

The removal of fumes arising from tapping results in a substantial reduction of calcium carbide dust emissions from tapping operations.

##### Cross-media effects

No information submitted.

##### Operational data

Refer to Section 7.2.3 above.

Applicability

Applicable to the plants producing calcium carbide.

Economics

No data submitted.

Driving force for implementation

The protection of the environment.

Example plants

The calcium carbide plant in Landeck, Austria.

Reference literature

[60, UBA-Austria, 2004].

**7.2.4.7 Waste gas treatment for other emission sources**Description

For the abatement of dust from other stages of production (wagon tilting-plant, crusher, coke drying, raw material dedusting, calcium carbide storage, recirculation of sewage sludge) fabric filters are applied.

Achieved environmental benefits

The reduction of dust emissions into the atmosphere.

Cross-media effects

No information submitted.

Operational data

Characteristic dust emissions from the example plant in Landeck are presented in Table 7.10.

Applicability

Applicable to the plants producing calcium carbide.

Economics

No data submitted.

Driving force for implementation

The protection of the environment.

Example plants

The calcium carbide plant in Landeck, Austria.

Reference literature

[60, UBA-Austria, 2004].

**7.2.5 Best Available Techniques for the manufacture of calcium carbide**

For general information on understanding a BAT Section and its contents, see Section 7.1.5.

Calcium carbide is produced in large electrothermic furnaces in a very energy intensive process at a high temperature by the reaction of lime with carbon (usually coke). In modern furnaces, carbon electrodes are completely closed, so that the carbon monoxide by-product can be recovered and the energy content in the furnace gas utilised downstream (e.g. lime kilns, fuel gas network). However, in the EU-25 calcium carbide is produced using closed, half-closed and open type furnaces and, as far as possible, BAT conclusions address those configurations.

**For the production of calcium carbide by the electrothermic furnace, BAT is to:**

1. Select appropriate quality raw materials and check their purity to avoid an excessive content of impurities in the raw materials, such as iron oxides,  $\text{SiO}_2$ ,  $\text{Al}_2\text{O}_3$ ,  $\text{MgO}$  and compounds of nitrogen, sulphur and phosphorus, to minimise undesirable side reactions and waste of energy – see Section 7.2.2. In particular:
  - use coke dried of below 2 % moisture content, with an ash content of below 15 % (optimally 10 %), and (for closed furnaces) a grain size of 3 – 25 mm
  - maintain the magnesium content in the lime below 2 % and the grain size between 6 and 50 mm. Use lime (usually quicklime) which is as soft as possible to allow the reduction of the  $\text{CO}_2$  content to less than 2 %.
2. Design, maintain and properly operate the calcium carbide plant, to save raw materials and energy and reduce the impact of the production of  $\text{CaC}_2$  on the environment. In particular:
  - in the calcium carbide plant with a closed furnace, use 930 kg lime (94 %  $\text{CaO}$ ), 550 kg coke (dry, 10 % ash), 20 kg electrode material, and 3200 kWh electricity respectively per tonne of  $\text{CaC}_2$  and, utilise the energy content of the CO furnace gas or use the furnace gas as a process input – see Sections 7.2.3.1, 7.2.3.4, 7.2.4.1 and 7.2.4.5
  - in the calcium carbide plant with an open type furnace (where CO gas is not collected), save raw materials and energy and reduce the impact of the production on the environment, also taking advantage of the possibility to select a broader range of raw materials used and of a higher flexibility of the process – see Sections 7.2.3.1, 7.2.3.4 and 7.2.4.1.
3. In the calcium carbide plants using closed furnaces, collect totally the dust-laden CO furnace gas, clean the gas to 1 – 5  $\text{mg}/\text{Nm}^3$  by using a dry or wet dedusting system, as appropriate, and utilise the energy content of the dedusted CO furnace gas in downstream operations at the site or outside of the calcium carbide plant site – See Sections 7.2.3.1, 7.2.4.1, 7.2.4.2, 7.2.4.3 and 7.2.4.5

Notes:

In the calcium carbide plants with closed furnaces, use a dry dedusting system with self-supporting candle filters made of ceramic fibres for furnace gas cleaning to below 1  $\text{mg}/\text{Nm}^3$ , cool the hot dedusted furnace gas in a heat exchanger, and calcine the filter residues in order to destroy the cyanide – see Section 7.2.4.2 or, alternatively, use a wet dedusting system for furnace gas cleaning to below 5  $\text{mg}/\text{Nm}^3$ , with an associated waste water treatment system for CN removal – see Section 7.2.4.2, 7.2.4.3 and 7.2.4.4.

The cleaned furnace gas has a typical composition of 80 – 90 %  $\text{CO}$ , 1 %  $\text{CH}_4$ , 6 - 15 %  $\text{H}_2$ , 2 – 7 %  $\text{N}_2$  and 0.5 – 3 %  $\text{CO}_2$ , depending on the characteristics of the raw materials used. The carbon monoxide rich furnace gas is usually utilised as fuel via a fuel gas network and the excess of the gas is flared. Other applications are known for the usage of the furnace gas (such as in a lime kiln, or as a process heating gas and raw material in other industries) – see Section 7.2.4.5.

4. In the  $\text{CaC}_2$  plants where an open type furnace is used, reduce a final dust content in the furnace and tapping gas to below 3  $\text{mg}/\text{Nm}^3$  using a common dedusting system – see Sections 7.2.3.1 and 7.2.4.2.

5. Reduce emissions of fumes originating from the tapping operation to 9 g dust per tonne of  $\text{CaC}_2$  produced by using a dry system of fume extraction and treatment in fabric filters (see Sections 7.2.3.1 and 7.2.4.6).
6. Capture the air and reduce dust emissions from other emission sources (wagon tilting-plant, crusher, coke drying, raw material dedusting, calcium carbide storage) to 1 - 5  $\text{mg}/\text{Nm}^3$  by using fabric filters – see Sections 7.2.3.1 and 7.2.4.7.

## 7.3 Carbon disulphide

### 7.3.1 General information

#### 7.3.1.1 Introduction

Carbon disulphide is an important industrial chemical with an extensive and well developed chemistry [87, Ullmann's, 2001].

Its solvent power was recognised early, and for some time carbon disulphide was widely used for the extraction of fats and oils. It was, however, not until the early 1900s with the introduction of the viscose rayon process, which uses carbon disulphide to solubilise cellulose, that it began to assume the role of a large-scale industrial chemical. By the late 1960s, competition from petroleum-based synthetic fibres began to affect the earlier rapid growth of rayon; the 1970s witnessed a decline of the rayon market and correspondingly that of carbon disulphide. The usage of carbon disulphide has since stabilised, and a small market growth is projected for the future. Of the 1.1 million tonnes of carbon disulphide produced worldwide in 1984, over 75 % was used by the regenerated cellulose industry. The remainder was consumed by the production of carbon tetrachloride and miscellaneous organic sulphur compounds used as rubber chemicals, flotation agents, and pesticides.

Carbon disulphide is commercially manufactured by the reaction of sulphur with charcoal or methane. Since the methane process was first introduced in the early 1950s, it has steadily replaced the older charcoal process, which is no longer a factor in carbon disulphide manufacture in the United States, Europe, and Japan. As given in Table 7.12 for 1984, an estimated 1.1 million tonnes of carbon disulphide was produced worldwide in the following areas (production figures in kt per year):

North America	235
Western Europe	260
Eastern Europe	250
Latin America	50
Asia	160
Africa	10
USSR	120
<b>World</b>	<b>1085</b>

**Table 7.12: 1984 production of carbon disulphide worldwide**  
[87, Ullmann's, 2001]

The production capacity for carbon disulphide in Western Europe (in 1984) was reported to be located in the United Kingdom, France, Germany and Spain, while in Eastern Europe in Poland, Romania, and Bulgaria respectively [87, Ullmann's, 2001].

#### 7.3.1.2 Characteristics of carbon disulphide

Carbon disulphide is a clear liquid with the following remarkable characteristics [88, UBA - Germany, 2004]:

- high density: 1.260 g/cm<sup>3</sup>
- high volatility: 60 % above those of diethyl ether
- low boiling point: 46 °C
- wide explosion limits: 1 – 60 vol %
- low flashpoint: -30 °C
- low ignition point: 102 °C

High safety standards have to be applied to prevent fire and explosions. The toxicity to humans is well investigated: there is a strong toxic effect to the nervous system. The MAK-Value (maximum tolerable concentration at working places) is  $30 \text{ mg/m}^3$ . Mutagenicity has not been evaluated adequately yet.

Carbon disulphide is a basic chemical used mainly for the following five processes:

1. Production of viscose

The most important application of carbon disulphide is the production of viscose silk (rayon). Cellulose fibres are transformed by sodium hydroxide and carbon disulphide to liquid cellulose xanthate. From this solution, different products of cellulose with distinct properties are regenerated with sulphuric acid: staple fibre, filament yarn (rayon), cellophane (artificial sausage skin, synthetic sponge). Rayon and cellophane are increasingly substituted by cheaper polymers, e.g. polyesters and polypropylene. Due to its high temperature resistance, the yarn is indispensable in the production of tyres.

2. Production of vulcanisation agents

The reaction of carbon disulphide with secondary amines, partial addition to sulphur chains and subsequent oxidation, leads to the production of thiurams with the common formula  $\text{R}_2\text{N-C(S)-S}_0$ ,  $2\text{-C(S)-NR}_2$ . These compounds are used as vulcanisation agents in the production of tyres.

3. Production of rhodanides/thiocyanates

The salts of thiocyanic acid are produced by the reaction of carbon disulphide with ammonia. These compounds are used for the production of synthetic fibres (NaSCN is a solvent for polyacrylonitrile), in the photographic chemistry (fixing bath) and in the production or formulation of herbicides and fungicides.

4. Application as a pesticide (e.g. vine pest).

5. Feedstock for the sulphur-organic chemistry.

### 7.3.1.3 The scale of $\text{CS}_2$ production in Europe

According to Akzo estimation, due to declining applications, global production of  $\text{CS}_2$  decreased from 1.3 million tonnes in 1979 to 0.9 million tonnes in 1990.

As illustrated in Table 7.13, there are four producers of carbon disulphide (1997) in Europe with the total capacity of approx. 350 kt per year [88, UBA - Germany, 2004]:

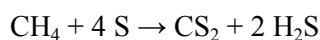
Location (Country)	Capacity in tonnes per year
Cologne (DE)	85000
Barcelona (ES)	40000
St. Clair du Rhône (FR)	110000
Staszow (PL)	110000

**Table 7.13: European carbon disulphide producers and production capacity [88, UBA - Germany, 2004]**

No recent information is available on the  $\text{CS}_2$  production in Romania and Bulgaria.

### 7.3.2 Industrial processes used

The modern process for the production of carbon disulphide is the methane process. It is based on the reaction of sulphur with natural gas at temperatures of between 500 and 700 °C under a pressure of 4 to 9 bar. The reaction is accelerated by a solid catalyst.



Carbon disulphide is separated from the mixture by cooling and condensation, purified by double distillation and washed with sodium hydroxide. Hydrogen sulphide is purified by absorption with mineral oil and directed to a Claus process unit for the recovery of elemental sulphur (refer to the BREF on Mineral Oil and Gas Refineries). Outside of Western Europe, production of carbon disulphide might exist using coal as a feedstock.

A flow chart of carbon disulphide production in Cologne, Germany is given in Figure 7.3 below.

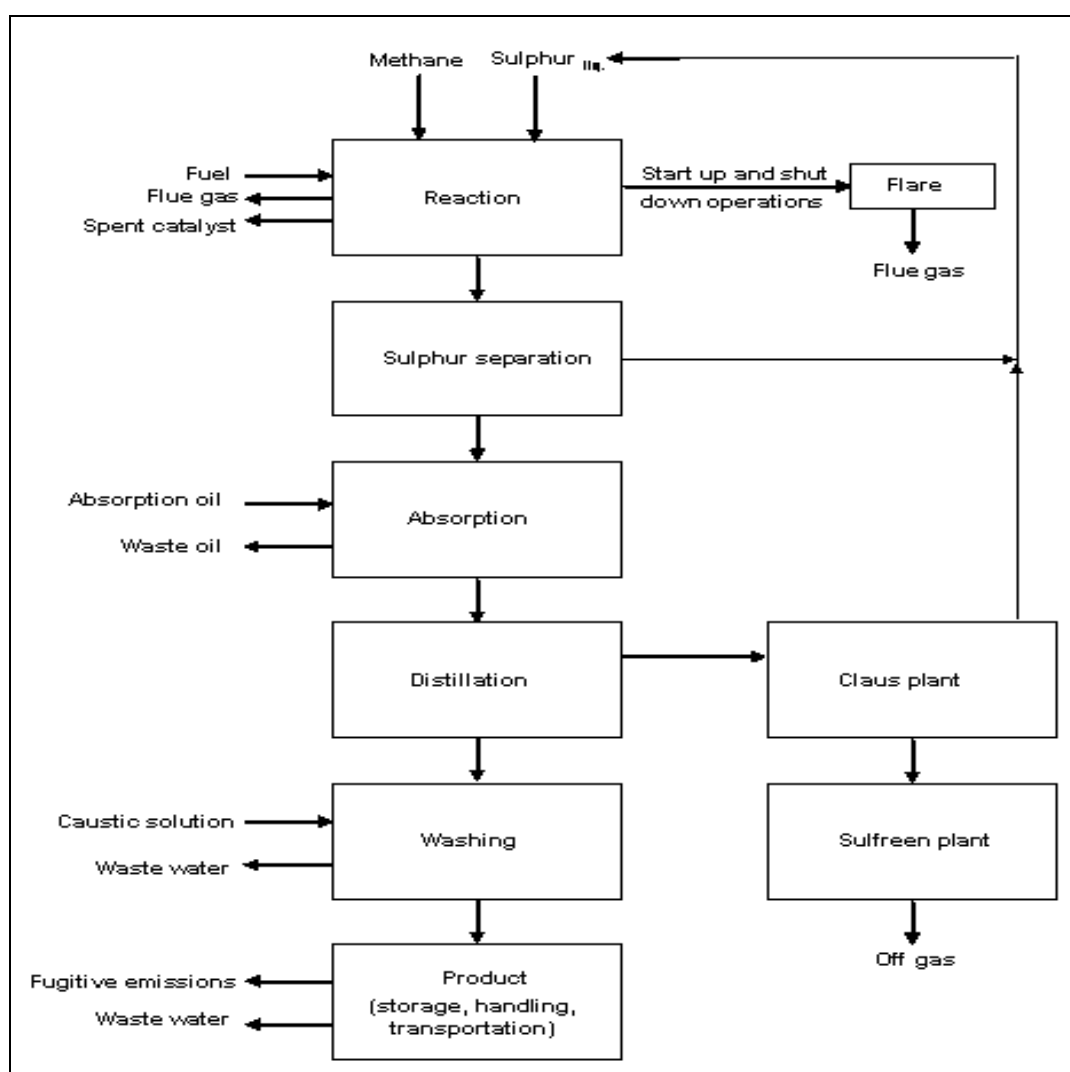


Figure 7.3: A flow chart of carbon disulphide production in a CS<sub>2</sub> plant in Cologne, Germany [88, UBA - Germany, 2004], [85, EIPPCB, 2004-2005]

### 7.3.3 Present consumption and emission levels

#### 7.3.3.1 Emissions to air

The production of carbon disulphide is realised in a closed reactor system. Emissions can occur at fugitive sources like fittings, valves, flanges and pumps, at flares during start-up and shut-down procedures and at storage and transport facilities.

For safety reasons, the headspace above the carbon disulphide in the storage tanks is always filled with water or nitrogen. In the case of water capping, vapour balancing with vessels to fill is not possible and emissions occur from the replaced waste gas, which is washed with mineral oil. Additional emissions occur from the storage tanks of the water used as a cap for the product. In the case of nitrogen capped CS<sub>2</sub> storage, fugitive emissions from tank breathing occur.

Emissions of carbon disulphide in the German plant in Cologne in 1991 were [88, UBA - Germany, 2004]:

- diffuse sources and flare: 540 kg per year
- waste gas from filling (vapour): 35 kg per year
- emissions from storage (water): 400 kg per year
- total Emissions: 975 kg per year
- specific emissions: 12 g/tonne of produced CS<sub>2</sub>.

An additional source of emissions is the Claus process for sulphur recovery. These emissions are mainly N<sub>2</sub>, CO<sub>2</sub>, NO<sub>x</sub>, H<sub>2</sub>O, COS and H<sub>2</sub>S. The concentration of sulphur components in the waste gas after the Claus unit and additional waste gas treatment (Sulfreen plant) is below 5 ‰. Using appropriate waste gas treatment with completing waste gas incineration, specific emissions of less than 8 kg SO<sub>2</sub>/tonne CS<sub>2</sub> can be achieved [88, UBA - Germany, 2004].

#### 7.3.3.2 Emissions to water

Waste water is produced by washing the product to remove hydrogen sulphide and from the overspill water tank in the case of water capped storage. In the CS<sub>2</sub> plant in Cologne, there are approximately 1920 m<sup>3</sup> waste water per year from the washing of the product and approximately 10000 m<sup>3</sup> waste water per year from as overspill from the storage tanks [88, UBA - Germany, 2004]. Concentrations and loads are not available as the water is treated in a central waste water treatment plant.

#### 7.3.3.3 Solid wastes

Two types of waste are generated in this process:

- spent catalyst, after a regular lifetime of two to three years under optimised conditions
- absorption oil from the purification of hydrogen sulphide gas from carbon disulphide. In the CS<sub>2</sub> plant in Cologne, it amounts to 50 tonnes per year [88, UBA - Germany, 2004].



### 7.3.4 Techniques to consider in the determination of BAT

**Introduction: Techniques to consider in the determination of BAT – refer to Section 7.1.4**

#### 7.3.4.1 Prevention measures applied to reduce emissions to air

##### Description

As the emissions from the flare still contribute significantly to the total emissions, the number of start-up and shut-down events should be minimised by proper operation of the plant and a well planned production schedule. Fugitive emissions can be minimised to  $10^{-4}$  mg/sec.m<sup>3</sup> by the installation of high quality flange seals and fittings with metal bellows. Shaft-seal-free pumps are technically tight.

The emissions caused by the evaporation of CS<sub>2</sub> from the overspill water tank and from filling processes are specific for the water-capped storage tanks. These emissions can be reduced by covering the surface of the water with floating balls. The vapour displaced from the headspace of the vessels must be caught and directed to a treatment facility. One option for treatment is its absorption in mineral oil, which permits residual CS<sub>2</sub> concentrations of approximately 500 mg/m<sup>3</sup> in the waste gas. Other options for waste gas treatment include the cryogenic condensation of the CS<sub>2</sub> or the thermal oxidation of the waste gas. Product storage in fixed dome tanks is also possible. Then, vapour balancing with transport vessels is possible and only fugitive emissions from tank breathing are released. One of the described methods for product storage has safety advantages (water-capped storage) while the other (fixed dome tanks) leads to lower emissions to the air. There is apparently no generally preferred option.

The waste gas from the Claus process contains still high amounts of SO<sub>2</sub> and H<sub>2</sub>S. Therefore, a waste gas treatment is required, e.g. the Sulfreen or the Scot processes. When applying one of these processes, the conversion factor can be increased from 98.5 to 99.9 %. The tail-gas contains amounts of COS and H<sub>2</sub>S. After waste gas incineration, a concentration below 3 mg/m<sup>3</sup> of sulphidic sulphur remains.

##### Achieved environmental benefits

The reduction of gaseous emissions of CS<sub>2</sub> vapours, SO<sub>2</sub>, H<sub>2</sub>S, and COS released from the process, as well as the minimisation of releases to air of combustion products generated during the flaring of the off-gases from the CS<sub>2</sub> plant.

##### Cross-media effects

No information submitted.

##### Operational data

Based on the industrial experience gathered at the carbon disulphide example plant in Cologne, Germany, the following are the main, complex operational measures to be applied in the production of CS<sub>2</sub> with regard to abatement of emissions to air [88, UBA - Germany, 2004]:

- minimise the number of start-up and shut-down events
- use of extra tight fittings, flange seals and shaft-seal-free pumps to prevent diffuse emissions
- cover the water surface in the water storage tanks when product storage with a water cap is carried out
- capture and treatment of replaced air during the filling of vessels when product storage with a water cap is carried out
- use of vapour balancing systems, white painted tanks and safety valves for high and low pressure when fixed dome tanks are used for product storage
- install a high performance treatment system for the waste gas of the Claus process, allowing for a conversion rate of above 99.8 %, and in the case of existing installations of above 99.5 %, to be achieved.

With the above-mentioned measures applied, specific emissions to air as low as 12 g of CS<sub>2</sub> per one tonne of carbon disulphide produced can be achieved.

#### Applicability

Applicable to the plants producing CS<sub>2</sub> by the methane process (refer to Section 7.5.2).

#### Economics

No data submitted.

#### Driving force for implementation

The increased safety in the operation of the CS<sub>2</sub> plants, and the reduced impact of the production of CS<sub>2</sub> on the environment.

#### Example plants

The carbon disulphide plant in Cologne, Germany.

#### Reference literature

[88, UBA - Germany, 2004], [87, Ullmann's, 2001].

For information on the techniques applied in, and the emissions resulting from, the Claus process refer to the BREF on Mineral Oil and Gas Refineries.

### **7.3.4.2 Waste water treatment**

#### Description

The waste water from the alkaline washing of the carbon disulphide contains sodium sulphide, which can be oxidised with H<sub>2</sub>O<sub>2</sub>.

Due to its content of carbon disulphide, the overspill of storage water must be stripped. The stripping can be effectuated by the use of an airlift pump. The resulting waste gas can be directed to a thermal oxidation of CS<sub>2</sub> before release.

#### Achieved environmental benefits

The reduction of Na<sub>2</sub>S content and CS<sub>2</sub> content in the waste waters released from the CS<sub>2</sub> plant.

#### Cross-media effects

The oxidation of sodium sulphide with hydrogen peroxide will yield sodium sulphites/sulphates, which are, however, less troublesome to the aquatic environment. In turn, stripping of carbon disulphide and its thermal oxidation will yield gaseous combustion products (CO<sub>2</sub>, and SO<sub>2</sub>).

#### Operational data

No detailed operational data submitted with regard to the oxidation of sodium sulphide and to the stripping of carbon disulphide.

#### Applicability

Applicable to the plants producing CS<sub>2</sub> by the methane process (refer to Section 7.5.2).

#### Economics

No data submitted.

#### Driving force for implementation

The reduced impact of the production of CS<sub>2</sub> on the aquatic environment.

#### Example plants

The carbon disulphide plant in Cologne, Germany.

#### Reference literature

[88, UBA - Germany, 2004].

### 7.3.4.3 Waste

#### Description

The service life of the catalyst is extended to avoid solid waste generation. This is achieved by reducing the temperature in the reactor and minimising any side reactions. Since carbon resulting from pyrolysis might block the catalyst, the use of natural gas with a high content of methane and a low content of other hydrocarbons is preferred. An accurate operation of the reaction is essential. Recycling of the mineral oil used for absorption of CS<sub>2</sub> vapours should be applied.

#### Achieved environmental benefits

An extended life-span of the catalyst used for the reaction will result in the reduction of solid waste. Recycling of the mineral oil will result in the reduction of waste generated.

#### Cross-media effects

No information submitted.

#### Operational data

No detailed data submitted. Waste minimisation by increasing the service life of the catalyst (optimisation of the catalyst, the gas quality and the process conditions).

#### Applicability

Applicable to the plants producing CS<sub>2</sub> by the methane process (refer to Section 7.5.2).

#### Economics

No data submitted.

#### Driving force for implementation

Higher operability of the plant, decreased manufacturing cost of the production of carbon disulphide, and the protection of the environment.

#### Example plants

The carbon disulphide plant in Cologne, Germany.

#### Reference literature

[88, UBA - Germany, 2004].

## 7.3.5 Best Available Techniques for the manufacture of carbon disulphide

For general information on understanding a BAT Section and its contents, see Section 7.1.5.

Carbon disulphide is produced in the EU by the methane process, based on the high temperature, catalysed reaction of sulphur with natural gas. After being separated from the gaseous mixture, CS<sub>2</sub> is purified by distillation and washed with sodium hydroxide.

The by-produced hydrogen sulphide is purified and converted to elemental sulphur using the Claus process.

**For the production of carbon disulphide by the methane process, BAT is to:**

1. Reduce emissions of carbon disulphide to air to below 12 g CS<sub>2</sub> per tonne of the final CS<sub>2</sub> product applying preventive measures to reduce emissions to air (see Sections 7.3.3.1 and 7.3.4.1), including:
  - minimisation of the plant's number of start-up and shut-down events
  - usage of extra tight fittings, flange seals and shaft seal-free designed pumps to prevent diffuse emissions
  - covering of the water surface in the water storage tanks when product storage with water cap is carried out
  - capture and treatment of replaced air during filling of vessels when product storage with water cap is carried out
  - usage of vapour balancing systems, white painted tanks and safety valves for high and low pressure when fixed-dome tanks are used for product storage.
2. Maintain a high conversion rate of sulphur compounds (SO<sub>2</sub> and H<sub>2</sub>S), originating from the waste gas of the Claus process, to elemental sulphur of above 99.8 %, and in the case of existing installations of above 99.5 %. This can be achieved by installing a high performance waste gas treatment system, followed by waste gas incineration to achieve the final concentration of sulphidic compounds below 3 mg S/Nm<sup>3</sup> of the outlet gas (see Sections 7.3.3.1 and 7.3.4.1).
3. Treat waste waters, originating from alkaline washing of the CS<sub>2</sub> product and containing sodium sulphide (Na<sub>2</sub>S), by oxidation with hydrogen peroxide (H<sub>2</sub>O<sub>2</sub>) to yield sodium sulphites and sulphates in order to lessen the impact of discharged waste waters on the aquatic environment – see Section 7.3.4.2.
4. Treat waste waters (originating from overflows in the CS<sub>2</sub> storage) by stripping, followed by a thermal oxidation of CS<sub>2</sub> contained in the resulting waste gas, in order to reduce the impact of discharged waste waters on the aquatic environment – see Section 7.3.4.2.
5. Minimise solid waste to land by increasing the service life of the catalyst (optimisation of the catalyst, the gas quality and the process conditions), and by recycling of the mineral oil used for absorption of CS<sub>2</sub> vapours – see Section 7.3.4.3.

## 7.4 Ferrous chloride

### 7.4.1 General information

#### 7.4.1.1 Introduction – ferrous chloride (FeCl<sub>2</sub>)

Of all the halides of iron, only iron (II) chloride (ferrous chloride) is covered in this document, as its production is directly linked to the manufacture of titanium dioxide by the chloride process route – see Section 3.2. For the information on ferric chloride refer to the ‘Additional information submitted during the information exchange on LVIC-S industry’ document, accessible through the EIPPCB website, as well as to the BREF on Ferrous Metals Processing Industry (FMP). For the description of other routes for the production of ferrous chloride refer to the BREF on Ferrous Metals Processing Industry (FMP).

Ferrous chloride, i.e. iron (II) chloride FeCl<sub>2</sub>, exists in an anhydrous form, as well as in hydrated forms, FeCl<sub>2</sub>·2 H<sub>2</sub>O and FeCl<sub>2</sub>·4 H<sub>2</sub>O. Anhydrous iron (II) chloride can be made by passing a stream of dry hydrogen chloride HCl over heated metal.

The hydrated forms can be made using dilute hydrochloric acid. The etching of steel with hydrochloric acid yields large amounts of iron (II) chloride [87, Ullmann's, 2001].

A solution of iron (II) chloride is also obtained as a by-product from the chloride process for the production of titanium dioxide (refer to Section 3.2.2.4), and the remainder of this section relates only to the production of ferrous chloride (FeCl<sub>2</sub>) integrated with the production of TiO<sub>2</sub> by the chloride process route [90, CEFIC-INCOPA, 2004].

#### 7.4.1.2 Background information on ferrous chloride (FeCl<sub>2</sub>)

Product Name : Ferrous chloride  
 Chemical Formula: FeCl<sub>2</sub>  
 CAS number : 7758-94-3

Ferrous chloride – iron (II) chloride FeCl<sub>2</sub> – is a very common iron salt, the major uses of which are shown in Table 7.14 below.

Use	Application
Water treatment	As a coagulant either directly or after conversion to an iron (III) compound
H <sub>2</sub> S reduction	Additive for municipal sewerage systems to reduce the H <sub>2</sub> S odour
Pigment	As a raw material for use in the production of iron oxide pigments
Soil immobilisation	Immobilisation of the elements As, Cr, V, and Cd in soil

**Table 7.14: Major uses of ferrous chloride**  
 [90, CEFIC-INCOPA, 2004]

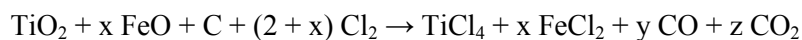
Ferrous chloride production is an integral part of the production of titanium dioxide by the chloride process route, based on iron containing titanium dioxide feedstock (refer to Section 3.2.2.4). Sale of the ferrous chloride allows for the full utilisation of this raw material resource.

The required market needs to be in balance with the TiO<sub>2</sub> market which is not always the case, this leading to the requirement for producing to meet the market demand and resulting in low overall prices. The low average prices preclude significant competition from ferrous chloride as a waste product from the steel industry.

The European capacity of ferrous chloride is estimated to be 250000 tonnes of which about 80000 tonnes is produced by the steel industry.

## 7.4.2 Process description

Iron chlorides are formed directly from the chlorination of iron/titanium ores in the presence of carbon as a reducing agent as required by the chloride route titanium dioxide production process.



At least 940 kg of 20 %  $\text{FeCl}_2$  solution per tonne of  $\text{TiO}_2$  pigment produced can be recovered from the production of titanium dioxide [42, UBA-Germany, 2001].

The iron chloride dust is separated from the production process gases in a cyclone and reslurried into a weak hydrochloric acid. Depending on the iron content of the raw material used, a marketable ferrous chloride solution can be processed, otherwise the material has to be neutralised and subsequently dumped. In the case of a high iron content, the carbon dust, which is also separated in the cyclone, has to be removed in a filtration step and further treated for sale.

Depending on customer requirements, the content of the co-metals (heavy metals as trace elements) in the ferrous chloride solution can be adjusted by selective precipitation, i.e. the co-metals are precipitated as hydroxides or sulphides and subsequently separated from the ferrous chloride solution and landfilled.

The process flow diagram for the manufacture of ferrous chloride, linked upstream to the production of titanium dioxide by the chloride process route, is given in Figure 7.4.

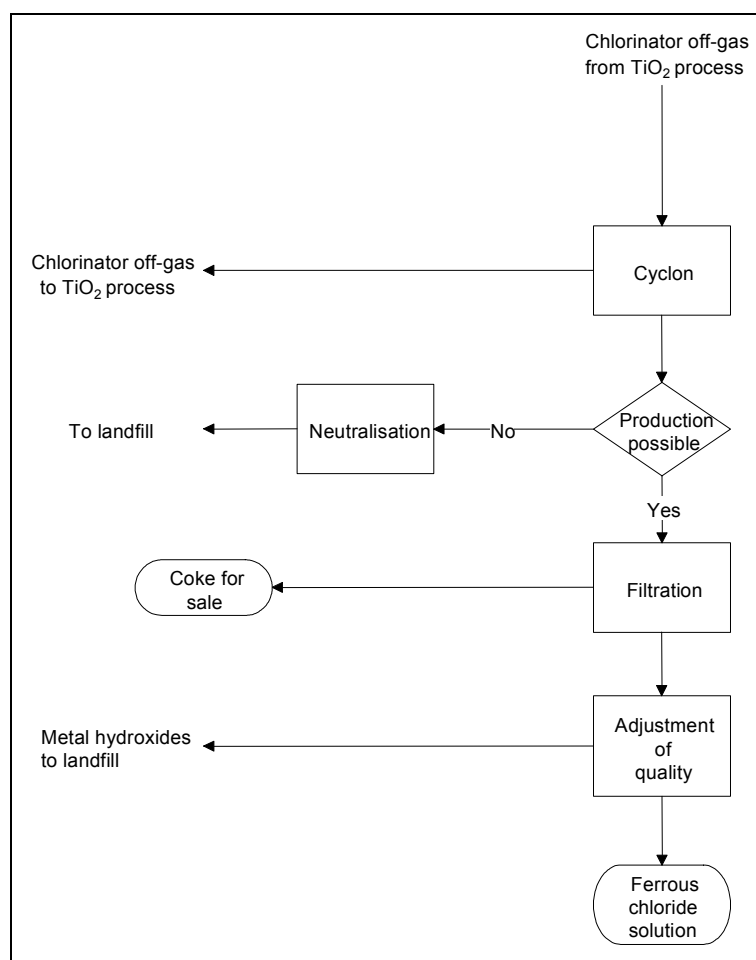


Figure 7.4: Process flow diagram for the manufacture of ferrous chloride [90, CEFIC-INCOPIA, 2004]

The possibility of the manufacturing of a marketable ferrous chloride solution will be related to the iron concentration of the titaniferous ore used in the production titanium dioxide. To process a marketable ferrous chloride, the ratio Fe:Ti in the ore has to be <1:7.5. For the production of titanium dioxide pigments, the ore with an iron content of >10.5 % is used depending on the chlorination technology.

### 7.4.3 Present consumption and emission levels

Typical consumption and emission values in the manufacture of ferrous chloride are given in Table 7.15.

<b>Raw materials and energy consumption</b>	
HCl consumption m <sup>3</sup> /t product	0.007
Energy consumption GJ/t product	0.12
<b>Emissions to air</b>	
Chemical	Emission kg/t product
None	N/A
<b>Emissions to water</b>	
Chemical	Emission kg/t product
None	N/A
<b>Waste to land</b>	
Chemical	Waste kg/t product
Filter cake	N/A
Metal hydroxides	160 kg/t purified FeCl <sub>2</sub> solution

**Table 7.15: Typical consumption and emission values in the manufacture of ferrous chloride [90, CEFIC-INCOPIA, 2004]**

Indirect emissions are applicable related to energy consumption. However, the energy consumption is included in the figures quoted in the TiO<sub>2</sub> production by the chloride process route (refer to Chapter 3). There are no significant differences in energy consumption between different filtration equipment used [90, CEFIC-INCOPIA, 2004].

### 7.4.4 Techniques to consider in the determination of BAT

**Introduction: Techniques to consider in the determination of BAT – refer to Section 7.1.4**

#### 7.4.4.1 FeCl<sub>2</sub> production integrated with the production of TiO<sub>2</sub>

##### Description

The chlorinator off-gas from the TiO<sub>2</sub> plant, which is the main process stream from the manufacture of TiO<sub>2</sub> by the chloride process route, is the raw material for the production of ferrous chloride. Following the separation of the iron chloride dust in a cyclone, the gas is recycled back for the production of TiO<sub>2</sub>. The iron chloride dust is reslurried in a weak hydrochloric acid. Depending on the iron content of the raw material used, a marketable ferrous chloride solution can be processed, otherwise the material has to be neutralised and subsequently dumped. In the case of a high iron content, the carbon dust, which is also separated in the cyclone, has to be removed in a filtration step and further treated for sale.

Apart from wastes emitted to land, which are mainly metal hydroxides to landfill (refer to Figure 7.4), there are no direct emissions from the filtration, neutralisation and extraction equipment used in the production of the ferrous chloride solution.

##### Achieved environmental benefits

Ferrous chloride production is an environmentally benign process. The processing of the metal chlorides and the coke downstream of the cyclone to marketable products, has a positive environmental benefit, since every tonne that is produced and used relieves the need for subsequent treatment of the main TiO<sub>2</sub> plant effluent.

Cross-media effects

To process a marketable ferrous chloride, the ratio Fe:Ti in the titaniferous ore has to be <1:7.5. Otherwise, the material has to be neutralised and landfilled (refer to Figure 7.4).

Operational data

No detailed data submitted.

Applicability

Applicable only to the FeCl<sub>2</sub> installations integrated with the TiO<sub>2</sub> plants based on the chloride process route.

Economics

No data submitted, however, it should be noted that maximising the sales and distribution of ferrous chloride is a key part of the factory's environmental management system.

Driving force for implementation

The protection of the environment. The enlarged spectrum of marketable products, directly associated with the production of titanium dioxide by the chloride process route.

Example plants

The ferrous chloride plant, integrated with the TiO<sub>2</sub> plant based on the chloride process route in Leverkusen, Germany (refer to Table 3.6).

Reference literature

[90, CEFIC-INCOPIA, 2004], [20, CEFIC-TDMA, 2004], [42, UBA-Germany, 2001].

#### **7.4.5 Best Available Techniques for the manufacture of ferrous chloride**

For general information on understanding a BAT Section and its contents, see Section 7.1.5.

As presented earlier in this document, anhydrous ferrous chloride and ferrous chloride solution can be produced using different process routes. However, based on the submitted information, BAT conclusions relate only to the production of FeCl<sub>2</sub> solution integrated with the production of TiO<sub>2</sub> by the chloride process route – refer to Sections 3.2.4.3 and 7.4.

**For the production of ferrous chloride solution, integrated with the production of TiO<sub>2</sub> by the chloride process route, BAT is to:**

1. Remove FeCl<sub>2</sub> dust from the chlorinator off-gas (recycled back to the TiO<sub>2</sub> plant) and recover at least 940 kg of 20 % FeCl<sub>2</sub> solution per tonne of TiO<sub>2</sub> produced by using and optimising the sequence of the following techniques (see Sections 7.4.2, 7.4.3 and 7.4.4.1):
  - separation of the FeCl<sub>2</sub> dust in a cyclone
  - reslurrying the FeCl<sub>2</sub> dust in a weak hydrochloric acid
  - filtration of the FeCl<sub>2</sub> slurry
  - adjustment of the content of heavy metals in the FeCl<sub>2</sub> solution by selective precipitation (approx. 160 kg metal hydroxides per tonne of purified FeCl<sub>2</sub> solution to be landfilled).
2. Remove carbon dust from the FeCl<sub>2</sub> slurry by filtration and treat it further to obtain a marketable coke product (see Sections 7.4.2 and 7.4.4.1).



## 7.5 Copperas and related products

The information covered in this section is for the manufacture of iron salts, which are co-products in the manufacture of titanium dioxide. All these chemicals are derived from, or are related to, 'copperas', which is the commonplace name for ferrous sulphate heptahydrate, originating from the manufacture of TiO<sub>2</sub> by the sulphate process route.

### 7.5.1 Ferrous sulphate heptahydrate

#### 7.5.1.1 Background information

Product Name : Ferrous sulphate  
 CAS Number : 7782-63-0 (heptahydrate), 7720-78-7 (general)

Ferrous sulphate heptahydrate (copperas) is a very common iron salt, whose major uses are shown in Table 7.16.

Use	Application
Water treatment	As a coagulant either directly or after conversion to an iron (III) compound
Agriculture/horticulture	Prevention of iron chlorosis in plants grown on Fe deficient soils. Moss control.
Pigment	As a raw material for use in the production of iron oxide pigments.
Cr(VI) reduction	Treatment of cement to reduce any chromium from the 6 <sup>+</sup> to the 3 <sup>+</sup> oxidation state, thereby preventing the risk of chrome dermatitis for users

**Table 7.16: Major uses of ferrous sulphate heptahydrate (copperas)**

Copperas production is an integral part of the titanium dioxide production process based on the sulphate route and ilmenite feedstock [59, CEFIC-TDMA, 2004]. Sale of the copperas allows for the full utilisation of this raw material resource. The required market needs to be in balance with the TiO<sub>2</sub> market which is not always the case, leading to the need of some stockpiling and low overall prices. The low average prices preclude significant competition from outside Europe for the ferrous sulphate heptahydrate product.

The major European producers of ferrous sulphate heptahydrate are as listed in Table 7.17.

Country	Number of sites	Capacity (tonnes per year)
United Kingdom	1	95000
Spain	1	170000
Germany	2	370000
Norway	1	108000
France	1	50000
Finland	1	268000
Czech Republic	1	70000
Poland	1	90000
<b>Total</b>	<b>9</b>	<b>1221000</b>

**Table 7.17: Major European producers of ferrous sulphate heptahydrate [59, CEFIC-TDMA, 2004], [85, EIPPCB, 2004-2005]**

### 7.5.1.2 Process description

Iron sulphates are formed directly from the digestion of mixed iron/titanium ores with sulphuric acid as required by the sulphate route titanium dioxide production process.



The iron sulphate is then separated from the production process liquors by concentration and cooling which results in crystallisation of the ferrous sulphate heptahydrate. This product can then be extracted, typically by thickening and removal by centrifuge. The crystallised product may be washed with water or acid to produce the desired quality. The product contains a small amount of free moisture and may be referred to as 'damp crystal'. For some markets the product may be dried to remove free moisture to improve handling properties or further dried to produce the monohydrate product. For any particular production programme, the proportion of the available iron removed is dictated by the market and controlled by the properties of the process liquor. If too much copperas is removed from the process liquor then control of the hydrolysis process, which produces the  $\text{TiO}_2$  crystallites, can be lost. This instability can substantially lower the quality of the final  $\text{TiO}_2$  pigment.

The process flow diagram of copperas manufacture is given in Figure 7.5.

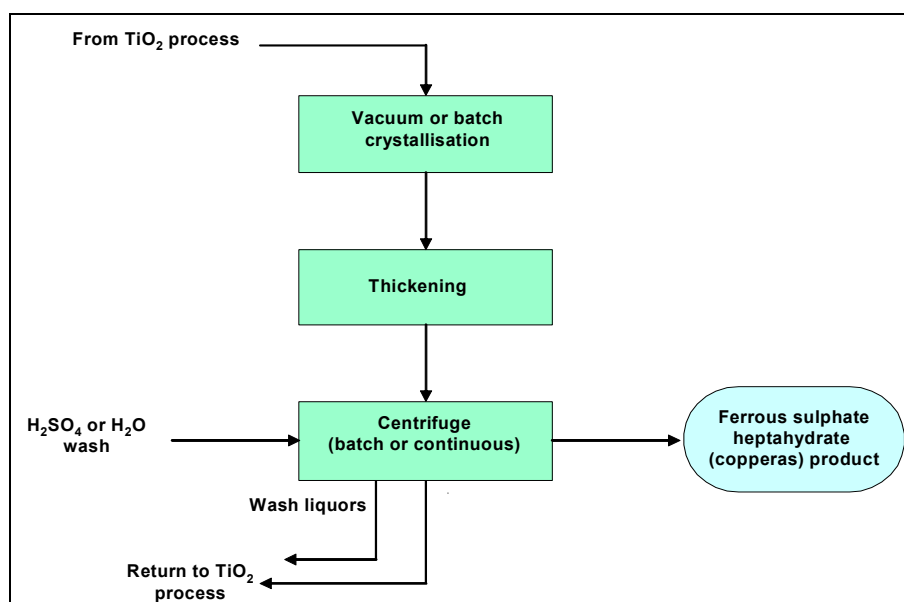


Figure 7.5: Process flow diagram – copperas manufacture [59, CEFIC-TDMA, 2004]

### 7.5.1.3 Present consumption and emission levels

Typical consumption and emission values in the manufacture of copperas are given in Table 7.18.

Energy and water consumption	
Energy consumption GJ/t product	0.1 – 0.6
Water consumption m <sup>3</sup> /t product	2.0 (20 – 30 for once through cooling)
Emissions to air	
Chemical	Emission kg/t product
None	N/A
Emissions to water	
Chemical	Emission kg/t product
None	N/A
Waste to land	
Chemical	Waste kg/t product
None	N/A

**Table 7.18: Typical consumption and emission values of for the manufacture of copperas [59, CEFIC-TDMA, 2004]**

Indirect emissions relating to energy consumption are applicable, however, this energy consumption is included in the figures quoted in the TiO<sub>2</sub> production by the sulphate process route (refer to Section 3.3.3).

### 7.5.1.4 Techniques to consider in the determination of BAT

**Introduction: Techniques to consider in the determination of BAT – refer to Section 7.1.4**

As there are no direct emissions from the ferrous sulphate heptahydrate production process, the crystallisation and extraction equipment used is not considered critical in terms of BAT.

#### 7.5.1.4.1 Copperas production integrated with the production of TiO<sub>2</sub>

##### Description

There are no direct emissions from the production of ferrous sulphate associated with the sulphate route of titanium dioxide manufacture, and no liquid or solid wastes are released from the crystallisation and copperas extraction equipment (centrifuge) used. The raw material feed is the main process stream from TiO<sub>2</sub> manufacture or the mother liquor from hydrolysis, and the filtrates liquor, following extraction of ferrous sulphate, is recycled to the TiO<sub>2</sub> production process or to the acid reconcentration plant for treatment and recycling. Similarly, wash liquors for the product are recycled back into the TiO<sub>2</sub> production process (see Figure 7.5 above).

The quantity of copperas produced is related to the iron concentration of the mixed titanium/iron ore used in the titanium dioxide production process, the level of oxidation of the ore, as additional iron may be added to reduce the digested liquors, and the efficiency of the crystallisation and extraction. For the titanium dioxide production processes that also have acid reconcentration plants, it may be possible to adjust the ratio between ferrous sulphate heptahydrate and ferrous sulphate monohydrate/filter salts depending on market demand.

##### Achieved environmental benefits

Copperas production is an environmentally benign process and copperas itself has a positive environmental benefit since every tonne that is produced and used reduces the need for subsequent treatment of the main TiO<sub>2</sub> plant effluent.

Cross-media effects

No information submitted.

Operational data

No detailed data submitted. Production levels are up to 4.5 tonne of copperas per tonne of TiO<sub>2</sub> produced (partly dependent upon the iron content of the ore).

Applicability

Applicable only to the copperas installations integrated with the TiO<sub>2</sub> plants based on the sulphate process route.

Economics

No data submitted, however, it should be noted that maximising the sales and distribution of copperas is a key part of the factory's environmental management system.

Driving force for implementation

The protection of the environment. Reducing the impact on the environment, also stems from the requirements of the TiO<sub>2</sub> Harmonisation Directive [21, The Council of the EU, 1992].

The enlarged spectrum of marketable products, directly associated with the production of titanium dioxide by the sulphate process route.

Example plants

The copperas plant in Pori, Finland associated with the TiO<sub>2</sub> plant based on the sulphate process

Reference literature

[59, CEFIC-TDMA, 2004], [20, CEFIC-TDMA, 2004], [42, UBA-Germany, 2001].

### 7.5.1.5 Best Available Techniques for the manufacture of ferrous sulphate heptahydrate (FeSO<sub>4</sub>·7H<sub>2</sub>O)

For general information on understanding a BAT section and its contents, see Section 7.1.5.

#### For the production of ferrous sulphate heptahydrate (FeSO<sub>4</sub>·7H<sub>2</sub>O), BAT is to:

Minimise the impact of the effluents discharged from the TiO<sub>2</sub> plant on the environment by integrating and optimising the process of TiO<sub>2</sub> production based on the sulphate route with the process for the production of saleable ferrous sulphate heptahydrate (copperas). Dependent upon the iron content in the titaniferous ore, the copperas extraction and utilisation levels can be up to 4.5 tonne FeSO<sub>4</sub>·7H<sub>2</sub>O per tonne of TiO<sub>2</sub> produced (see Section 7.5.1.4.1).

## 7.5.2 Ferrous sulphate monohydrate

### 7.5.2.1 Background information

Product Name : Ferrous sulphate  
CAS Number. : 17375-41-6 (monohydrate), 7720-78-7 (general)

When the iron or the acid concentration of the solution is increased so that the available water diminishes, then the ferrous sulphate will crystallise as a monohydrate rather than as a heptahydrate [59, CEFIC-TDMA, 2004]. Such conditions occur in acid recycling systems for the sulphate route of the titanium dioxide process where the recovered acid from the process is concentrated by heating and evaporation to recover the acid values, and therefore, ferrous sulphate monohydrate can be referred to as filter salt from acid recycling. This product typically has a lower Fe content than monohydrate produced by the drying of copperas, leading to different uses, as shown in Table 7.19 below:

Product	Use	Application
Ferrous sulphate monohydrate from acid recycling	Agriculture Cr(VI) reduction	Raw material for fertiliser or compost manufacture. Treatment of cement to reduce any chromium from the 6 <sup>+</sup> to the 3 <sup>+</sup> oxidation state, thereby preventing risk of chrome dermatitis for users

**Table 7.19: Major uses of ferrous sulphate monohydrate**

The major European producers are as listed in Table 7.20.

Country	Number of Sites	Capacity tonnes per year
Spain	1	100000
Germany	1	50000
France	1	100000
<b>Total</b>	<b>3</b>	<b>250000</b>

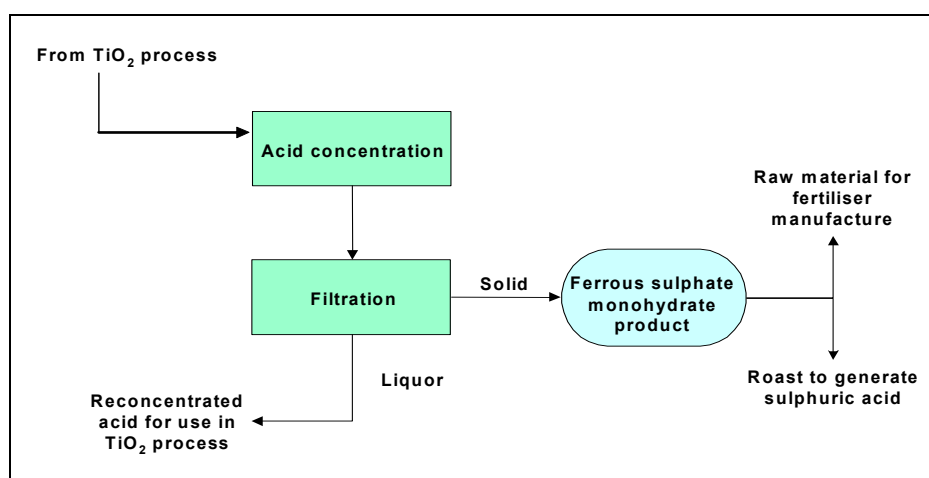
**Table 7.20: Major European producers of ferrous sulphate monohydrate (excluding TiO<sub>2</sub> manufacture)**

[59, CEFIC-TDMA, 2004]

### 7.5.2.2 Process description

The precipitated ferrous sulphate monohydrate is extracted from the acid liquors by filtration. This may be a multistage process with more stages than just concentration and filtration of the product. The acid recycling process is covered in Section 3.3.2.10.1 of this document.

The process flow diagram of the manufacture of ferrous sulphate monohydrate from acid recycling is given in Figure 7.6.



**Figure 7.6: Process flow diagram – ferrous sulphate monohydrate manufacture**

[59, CEFIC-TDMA, 2004]

### 7.5.2.3 Present consumption and emission levels

Typical consumption and emission values in the manufacture of ferrous sulphate monohydrate are given in Table 7.21.

Energy and water consumption	
Energy consumption GJ/t product	6 (for acid concentration)
Water consumption m <sup>3</sup> /t product	5
Emissions to air	
Chemical	Emission kg/t product
None	N/A
Emissions to water	
Chemical	Emission kg/t product
None	N/A
Waste to land	
Chemical	Waste kg/t product
None	N/A

**Table 7.21: Consumption and emission values – ferrous sulphate monohydrate manufacture [59, CEFIC-TDMA, 2004]**

### 7.5.2.4 Techniques to consider in the determination of BAT

**Introduction: Techniques to consider in the determination of BAT – refer to Section 7.1.4**

#### 7.5.2.4.1 FeSO<sub>4</sub> monohydrate manufacture integrated with the production of TiO<sub>2</sub>

##### Description

The precipitated ferrous sulphate monohydrate is extracted from the acid liquors by filtration. There are no direct emissions from the production of ferrous sulphate monohydrate, and the filtration equipment used is not considered critical in terms of the impact on the environment (see Figure 7.6 above). For the sulphate route based TiO<sub>2</sub> plants with both ferrous sulphate heptahydrate extraction and acid recycling, the balance of production between the monohydrate and heptahydrate can be adjusted in line with market demand. The purity of the product will relate to the ore used in the TiO<sub>2</sub> production process.

##### Achieved environmental benefits

The precipitated ferrous sulphate monohydrate production is an environmentally benign process and has a positive environmental benefit since every tonne that is produced and used relieves the need for subsequent treatment of the main TiO<sub>2</sub> plant effluent.

##### Cross-media effects

Where no market is available, neutralisation and landfill is possible.

##### Operational data

No detailed data submitted.

##### Applicability

Applicable only to precipitated ferrous sulphate monohydrate installations integrated with the TiO<sub>2</sub> plants based on the sulphate process route.

##### Economics

No data submitted, however, it should be noted that maximising the sales and distribution of copperas is a key part of the factory's environmental management system.

##### Driving force for implementation

The protection of the environment. The enlarged spectrum of marketable products, directly associated with the production of titanium dioxide by the sulphate process route.

Example plants

The precipitated ferrous sulphate monohydrate plant in Huelva, Spain (which is associated with the TiO<sub>2</sub> plant based on the sulphate process route).

Reference literature

[59, CEFIC-TDMA, 2004], [20, CEFIC-TDMA, 2004], [42, UBA-Germany, 2001].

### 7.5.2.5 Best Available Techniques for the manufacture of ferrous sulphate monohydrate (FeSO<sub>4</sub>·H<sub>2</sub>O)

For general information on understanding a BAT chapter and its contents, see Section 7.1.5.

#### For the manufacture of ferrous sulphate monohydrate (FeSO<sub>4</sub>·H<sub>2</sub>O), BAT is to:

Integrate and optimise the operations of sulphuric acid concentration and filtration in the process of TiO<sub>2</sub> production based on the sulphate route with the process for the production of saleable ferrous sulphate monohydrate extracted from the acid liquors by precipitation and filtration. The balance of production between the monohydrate and heptahydrate can be adjusted in line with market demand (see Section 7.5.2.4.1).

## 7.5.3 Ferrous sulphate heptahydrate and monohydrate

### 7.5.3.1 Background information

Product Name: Ferrous sulphate

CAS Number: 7782-63-0 (heptahydrate)

7720-78-7 (general)

17375-41-6 (monohydrate).

Dried ferrous sulphate heptahydrate and ferrous sulphate monohydrate are produced by copperas drying. Simple drying of ferrous sulphate heptahydrate from the sulphate route TiO<sub>2</sub> process is used to give either a dry heptahydrate product with the free moisture removed or a monohydrate product with the removal of water of crystallisation [59, CEFIC-TDMA, 2004]. These products have superior handling properties to the 'damp crystal' heptahydrate product initially extracted by centrifuge. Major uses are shown in Table 7.22.

Product	Use	Application
Dried ferrous sulphate heptahydrate and ferrous sulphate monohydrate from the drying of copperas	Animal feedstuff	Iron addition in animal feedstuff
	Horticulture	Moss control for grass
	Cr(VI) reduction	Treatment of cement to reduce any chromium from the 6 <sup>+</sup> to the 3 <sup>+</sup> oxidation state thereby preventing risk of chrome dermatitis for users

**Table 7.22: Major uses of ferrous sulphate monohydrate**

The major European producers of dried ferrous sulphate heptahydrate and ferrous sulphate monohydrate from the drying of copperas are listed in Table 7.23.

Country	No. of sites	Capacity in tonnes per year
Germany	1	45000
United Kingdom	1	14000
Finland	1	98000
Norway	1	18000
Czech Republic	1	8000*
Poland	1	6000
<b>Total</b>	<b>6</b>	<b>181000*</b>

\*Excluding monohydrate made as intermediate for iron oxide

**Table 7.23: Major European producers of ferrous sulphate heptahydrate/ferrous sulphate monohydrate**  
[59, CEFIC-TDMA, 2004], [85, EIPPCB, 2004-2005]

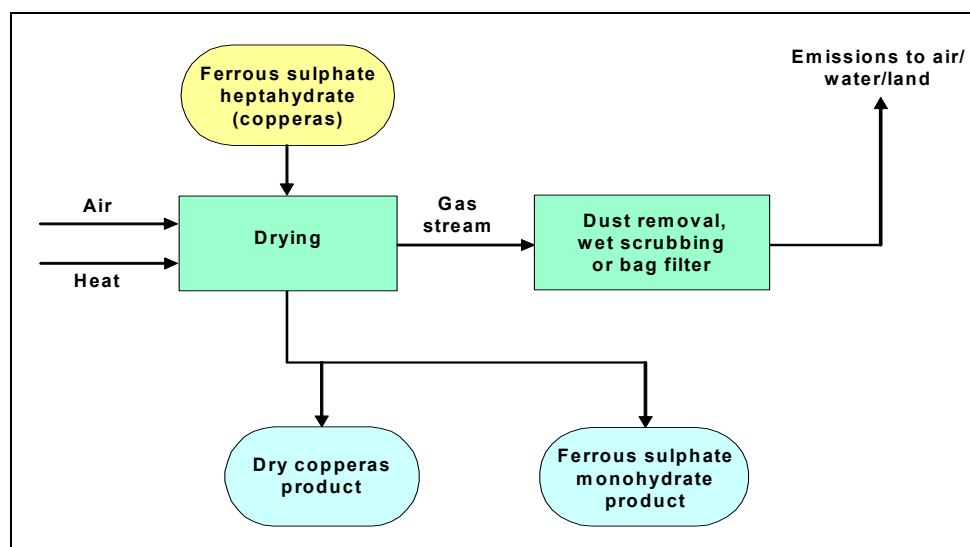
There is market competition from Asia, with production in China and Malaysia. However, some markets such as horticulture are highly seasonal.

### 7.5.3.2 Process description

Dried copperas and ferrous sulphate monohydrate are produced by the direct application of heat to the ‘damp crystal’ heptahydrate product. The degree of heating/drying determines the product generated.



Typically, this could be achieved by the use of a gas fired rotary kiln or fluidised bed dryer, with the drying achieved by the contact of hot gases with the heptahydrate. Gas stream temperatures of approx. 40 °C and 100 – 300 °C are used to remove free moisture and give monohydrate respectively. Dust emissions are minimised by wet scrubbing systems or bag filters. The process flow diagram of dried ferrous sulphate heptahydrate and ferrous sulphate monohydrate from the drying of copperas is given in Figure 7.7.



**Figure 7.7: Process flow diagram – dried  $\text{FeSO}_4 \cdot 7\text{H}_2\text{O}$  and  $\text{FeSO}_4 \cdot \text{H}_2\text{O}$  from the drying of copperas**  
[59, CEFIC-TDMA, 2004]



### 7.5.3.3 Present consumption and emission levels

Typical values relating to the production of dried ferrous sulphate heptahydrate and ferrous sulphate monohydrate from the drying of copperas are given in Table 7.24.

<b>Energy and water consumption</b>		
Energy consumption GJ/t product	0.003 – 0.8 (dried copperas) 3.0 – 5.0 (monohydrate)	
Water consumption m <sup>3</sup> /t product	0.9 – 2 (dried copperas/monohydrate wet scrubbing)	
<b>Emissions to air</b>		
Chemical	Emission kg/t product	Emission concentration
SO <sub>x</sub>	0.06 (dried copperas using natural gas)	<10mg/Nm <sup>3</sup>
NO <sub>x</sub>	0.002 (dried copperas)	No data
SO <sub>x</sub>	<0.008 – 0.8 (monohydrate using natural gas fuel)	<1.0 – <150 mg/Nm <sup>3</sup>
NO <sub>x</sub>	0.8 (monohydrate)	<150 mg/Nm <sup>3</sup>
Dust (FeSO <sub>4</sub> ·H <sub>2</sub> O)	0.004 – 0.08 (monohydrate and dried copperas) – bag filters <sup>(*)</sup> . 0.4 (monohydrate) – wet scrubbing	<30 – <50 mg/m <sup>3</sup> (*)
<b>Emissions to water</b>		
Chemical	Emission g/t product	Comments
Fe salts	0.75 (as Fe)	With wet scrubbing
<b>Waste to land</b>		
Chemical	Waste kg/t product	Comments
FeSO <sub>4</sub> ·H <sub>2</sub> O	8 – 25	
<sup>(*)</sup> Based on information from TDMA - bag filters may not always be applicable because of the physical nature of this dust		

**Table 7.24: Consumption and emission values – dried FeSO<sub>4</sub>·7H<sub>2</sub>O and FeSO<sub>4</sub>·H<sub>2</sub>O [59, CEFIC-TDMA, 2004], [85, EIPPCB, 2004-2005]**

### 7.5.3.4 Techniques to consider in the determination of BAT

**Introduction: Techniques to consider in the determination of BAT – refer to Section 7.1.4**

#### 7.5.3.4.1 The use of bag filters for the dedusting of air used in copperas drying

##### Description

The type of dryer used for this process is not considered critical in terms of impact on the environment. The use of bag filters for gas cleaning allows the vast majority of dust to be recycled within the process. However, wet scrubbing is sometimes used.

##### Achieved environmental benefits

Dedusting of the air used in the drying of copperas will reduce the impact of the production of ferrous sulphate heptahydrate and ferrous sulphate monohydrate on the environment.

##### Cross-media effects

The necessity to deal with scrubbing waters in the case where a wet dedusting system is used.

##### Operational data

As given in Table 7.24.

##### Applicability

Technique applicable to the installations used for the drying of copperas to produce ferrous sulphate heptahydrate and ferrous sulphate monohydrate (see Figure 7.7 above).

##### Economics

No data submitted.

##### Driving force for implementation

The protection of the environment.

Example plants

Ferrous sulphate heptahydrate and ferrous sulphate monohydrate units, combined with the copperas plant in Pori, Finland (all of them associated with the TiO<sub>2</sub> plant at this site, which is based on the sulphate process route).

Reference literature

[59, CEFIC-TDMA, 2004].

### 7.5.3.5 Best Available Techniques for the manufacture of ferrous sulphate heptahydrate and monohydrate

For general information on understanding a BAT Section and its contents, see Section 7.1.5.

**For the manufacture of ferrous sulphate heptahydrate and monohydrate, BAT is to:**

Reduce dust emissions to 0.004 – 0.08 kg per tonne of dried ferrous sulphate heptahydrate and per tonne of ferrous sulphate monohydrate, by using bag filters for gas cleaning from the copperas dryer (see Section 7.5.3.4.1).

## 7.5.4 Ferric sulphate

### 7.5.4.1 Background information

Product Name: Ferric sulphate

CAS Number. 10028-22-5.

Ferric sulphate is commonly manufactured as a 40 – 50 % acidic solution but may be further treated to produce either a powdered or granulated solid product [59, CEFIC-TDMA, 2004]. The major uses of ferric sulphate are shown in Table 7.25.

Use	Application
Water treatment	As a coagulant in water purification systems
Chemical	Various

**Table 7.25: Major uses of ferric sulphate**

Ferric sulphate is an added value product which is most commonly produced by the oxidation of ferrous sulphate heptahydrate. It can also be produced by the reaction of ferric oxide with sulphuric acid [59, CEFIC-TDMA, 2004].

There is currently no significant competition from outside the EU as transport costs for the liquid product are high and the solid product is only manufactured in Europe.

The major European producers of ferric sulphate in both the solid and liquid form are listed in Table 7.26.

Country	Number of sites	Capacity (solution) tonnes per year
United Kingdom	1	125000
Spain	1	60000
Finland	1	27000
Czech Republic	1	120000
<b>Total (solution)</b>	<b>4</b>	<b>332000</b>
Country	Number of sites	Capacity (solid) tonnes per year
Spain	1	20000
Finland	1	30000
<b>Total (solid)</b>	<b>2</b>	<b>50000</b>

**Table 7.26: Major European producers of ferric sulphate [59, CEFIC-TDMA, 2004]**

### 7.5.4.2 Process description

There are two main process routes for producing ferric sulphate from ferrous sulphate heptahydrate (copperas) [59, CEFIC-TDMA, 2004].

#### 7.5.4.2.1 The reaction of ferrous sulphate with nitric and sulphuric acids

Ferric sulphate is produced by the reaction of ferrous sulphate with a mixture of nitric and sulphuric acids according to the following reaction equation:



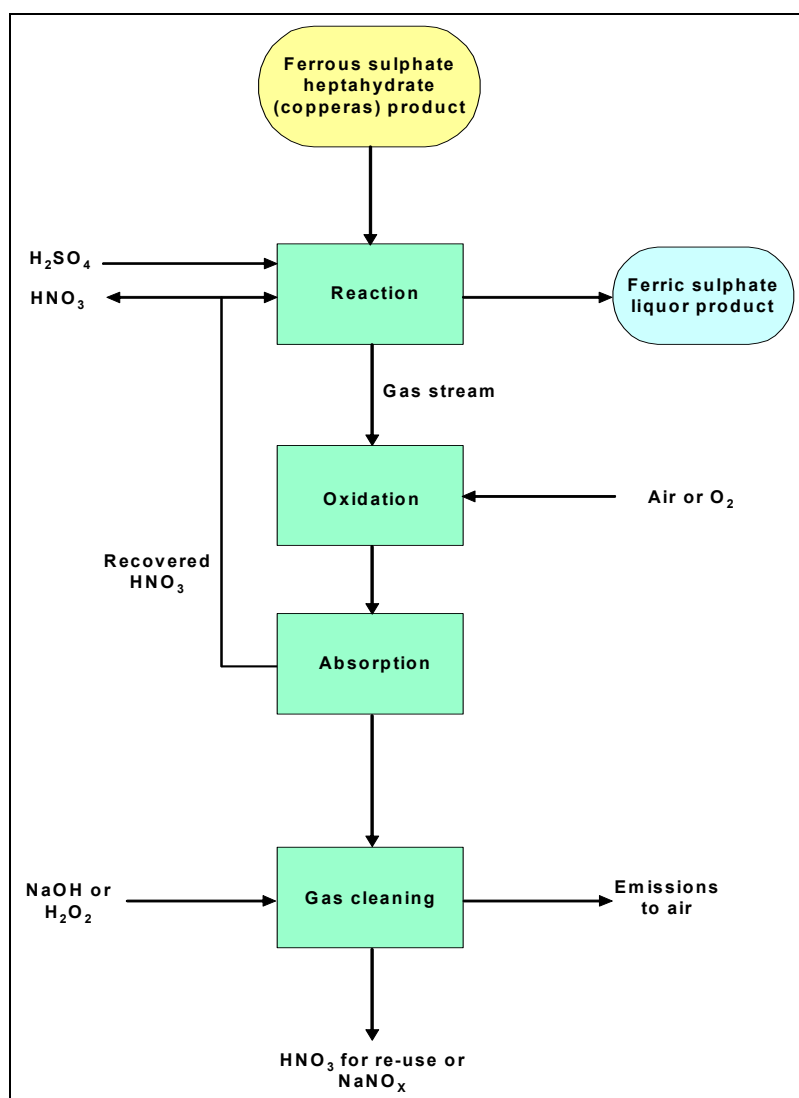
The released NO gas is oxidised to NO<sub>2</sub> and absorbed into water to re-form nitric acid, which can be re-used in the process. The overall conversion can be represented as below but is, in fact, more complex than indicated.

- Oxidation:  $2 \text{NO} + \text{O}_2 \rightarrow 2 \text{NO}_2$
- Absorption:  $2 \text{NO}_2 + \text{H}_2\text{O} \rightarrow 2 \text{HNO}_3 + \text{HNO}_2$   
 $\text{HNO}_2 \rightarrow \text{H}_2\text{O} + \text{NO}$

Oxidation may be achieved by using atmospheric oxygen or further encouraged by enriching the air with oxygen. Any residual nitrogen oxides not captured by the adsorption system can be scrubbed using gas cleaning systems based on either NaOH or H<sub>2</sub>O<sub>2</sub> solutions.

- NaOH scrubbing:  $\text{NO} + \text{NO}_2 \rightarrow \text{N}_2\text{O}_3$   
 $\text{N}_2\text{O}_3 + 2 \text{NaOH} \rightarrow 2 \text{NaNO}_2 + \text{H}_2\text{O}$   
 $2 \text{NO}_2 + 2 \text{NaOH} \rightarrow \text{NaNO}_2 + \text{NaNO}_3 + \text{H}_2\text{O}$
- H<sub>2</sub>O<sub>2</sub> scrubbing:  $\text{HNO}_2 + \text{H}_2\text{O}_2 \rightarrow \text{HNO}_3 + \text{H}_2\text{O}$ .

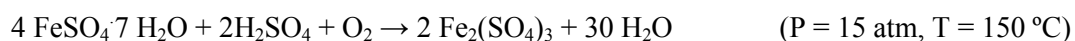
As illustrated in Figure 7.8, ferric sulphate is produced by the reaction of ferrous sulphate with a mixture of nitric and sulphuric acids.



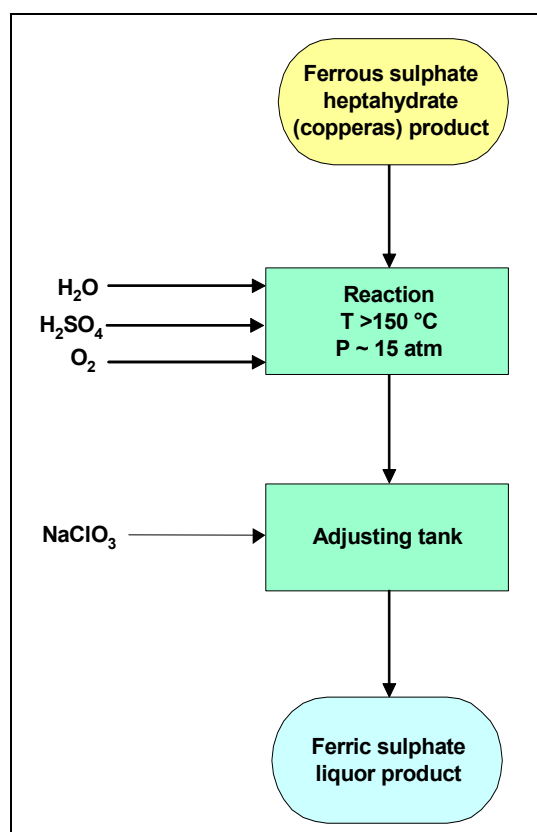
**Figure 7.8:** Ferric sulphate produced by the reaction of ferrous sulphate with nitric and sulphuric acids  
[59, CEFIC-TDMA, 2004]

#### 7.5.4.2.2 Direct oxidation of ferrous sulphate with oxygen and sulphuric acid

Ferric sulphate is produced by the direct oxidation of ferrous sulphate with oxygen and sulphuric acid at an elevated temperature and pressure.



As illustrated in Figure 7.9, ferric sulphate is produced by the direct oxidation of ferrous sulphate with oxygen and sulphuric acid at an elevated temperature and pressure.

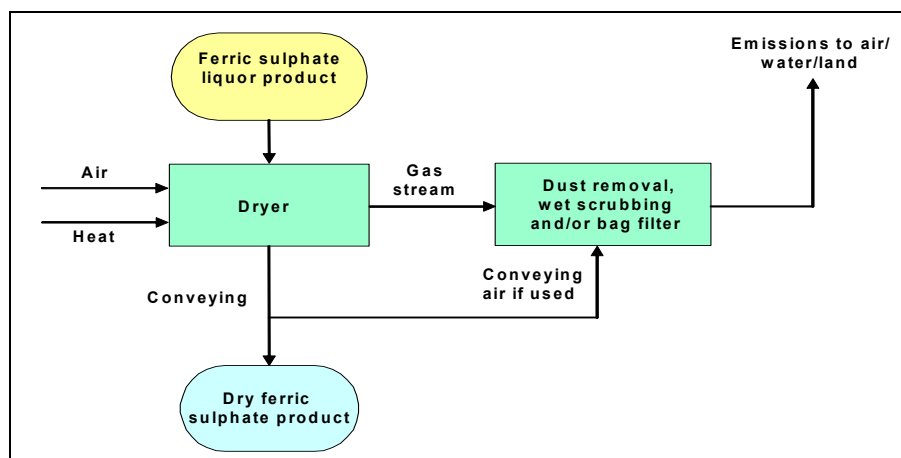


**Figure 7.9: Ferric sulphate produced by direct oxidation of ferrous sulphate [59, CEFIC-TDMA, 2004]**

The first step is dissolving copperas in water. The slurry is mixed and heated. In the next step, the slurry is pumped to the pressure reactor where sulphuric acid is added in the presence of a catalyst and oxidation by oxygen gas occurs. After oxidation, the ferric sulphate is pumped to an adjusting tank, where sodium chlorate is added to ensure complete oxidation.

The reactions detailed above typically give a 40 % solution of  $\text{Fe}_2(\text{SO}_4)_3$ . The product from either reaction can be dried to give a solid ferric sulphate product containing the bound water of crystallisation in the range 5 to 9  $\text{H}_2\text{O}$ . Dust/product emissions are minimised by the use of water scrubbers and sock filters.

Figure 7.10 illustrates the production of dried ferric sulphate.



**Figure 7.10: Production of dried ferric sulphate [59, CEFIC-TDMA, 2004]**

### 7.5.4.3 Present consumption and emission levels

#### 7.5.4.3.1 Typical values for production using nitric and sulphuric acids

Energy and water consumption		
Energy consumption GJ/t product	0.3	
Water consumption m <sup>3</sup> /t product	0.15	
Emissions to air		
Chemical	Emission kg/t product	Emission concentration
NO <sub>x</sub>	0.04	600mg/Nm <sup>3</sup> average <sup>(*)</sup>
Emissions to water		
Chemical	Emission kg/t product	
None	N/A	
Waste to land		
Chemical	Waste kg/t product	Comments
None	N/A	

<sup>(\*)</sup> Based on information from TDMA – high NO<sub>x</sub> value due to problems at start-up.

**Table 7.27: Typical values for production of ferric sulphate using nitric and sulphuric acids [59, CEFIC-TDMA, 2004], [85, EIPPCB, 2004-2005]**

#### 7.5.4.3.2 Typical values for production using pressure oxidation

Energy and water consumption		
Energy consumption GJ/t product	0.9	
Water consumption m <sup>3</sup> /t product	0.1 – 0.3	
Emissions to air		
Chemical	Emission kg/t product	Emission concentration
None	None	N/A
Emissions to water		
Chemical	Emission kg/t product	
Fe	0.2 – 0.8	0.32 kg/m <sup>3</sup> *
SO <sub>4</sub>	0.2 – 2.0	0.8 kg/m <sup>3</sup> *
Waste to land		
Chemical	Waste kg/t product	Comments
Insoluble residue	Up to 0.8	This process is used to recover stockpiled copperas. The waste is due to the removal of contamination

\*These are the releases to the water stream that drains into the gypsum plant. The actual emissions are:  
Fe: 0.0001 kg/t product (0.001 kg/m<sup>3</sup>); sulphates: 0.35 kg/t product (2.3 kg/m<sup>3</sup>)

**Table 7.28: Typical values for the production of ferric sulphate using pressure oxidation [59, CEFIC-TDMA, 2004]**

### 7.5.4.3.3 Conversion of ferric sulphate solution to a solid ferric sulphate product

Energy and water consumption		
Energy consumption GJ/t product	0.5	
Water consumption m <sup>3</sup> /t product	0.06	
Emissions to air		
Chemical	Emission kg/t product	Emission concentration
NO <sub>x</sub>	0.07 – 0.26	18 mg/Nm <sup>3</sup>
SO <sub>x</sub>	0.02	1.5 mg/Nm <sup>3</sup>
Dust, Fe <sub>2</sub> (SO <sub>4</sub> ) <sub>3</sub>	0.03 – 0.5	35 mg/Nm <sup>3</sup>
Emissions to water		
Chemical	Emission kg/t product	
None	N/A	
Waste to land		
Chemical	Waste kg/t product	Comments
None	N/A	

**Table 7.29: Typical values for the conversion of ferric sulphate solution to a solid Fe<sub>2</sub>(SO<sub>4</sub>)<sub>3</sub> product**  
[59, CEFIC-TDMA, 2004]

### 7.5.4.4 Techniques to consider in the determination of BAT

**Introduction: Techniques to consider in the determination of BAT – refer to Section 7.1.4**

Ferric sulphate belongs to the family of iron salts, which are co-products in the manufacture of titanium dioxide. Ferric sulphate is derived from ferrous sulphate heptahydrate ‘copperas’, which is a main co-product originating from the manufacture of TiO<sub>2</sub> by the sulphate process route. The common strategy of the titanium dioxide industry is to avoid the need of landfilling copperas by converting it into the whole spectrum of the marketable iron chemicals. The broader the family of the final, marketable products derived from copperas, the higher the degree of copperas utilisation, and the lower the combined impact of the production of TiO<sub>2</sub> by the sulphate process route on the environment. The two different process routes leading to the ferric sulphate solution are described below in Sections 7.5.4.4.1 (copperas oxidation with acids) and 7.5.4.4.2 (direct copperas oxidation). In turn, the conversion of ferric sulphate solution to a dry product is described in Section 7.5.4.4.3.

The direct emissions from the nitric acid/sulphuric acid oxidation process need to be compared in detail with the indirect emissions for a pressure oxidation process. Nitric acid oxidation typically achieves recovery levels of >98%, so when overall energy consumption and associated emissions from its generation are assessed, including that required for reagent production (O<sub>2</sub> and HNO<sub>3</sub>) and the process itself, typically the overall NO<sub>x</sub> release will be higher for pressure oxidation. However, this can only be assessed on an individual process related to the location of the production facility.

#### 7.5.4.4.1 Production of ferric sulphate by the oxidation process with acids

##### Description

The solution of ferric sulphate is produced by the reaction of copperas with a mixture of nitric and sulphuric acids. The process is carried out as described in Section 7.5.4.2.1. The released NO gas is oxidised to NO<sub>2</sub>, which is then absorbed in water and the nitric acid formed is recycled to the reaction step. Any residual nitrogen oxides are scrubbed by NaOH or H<sub>2</sub>O<sub>2</sub> solutions. For the nitric acid process, scrubbing with H<sub>2</sub>O<sub>2</sub> is considered to give lower discharge levels than NaOH scrubbing but similar discharge levels can be achieved by combining the use of O<sub>2</sub> for NO oxidation with NaOH scrubbing (see Figure 7.8). The efficiency of NaOH scrubbing is affected by the NO/NO<sub>2</sub> ratio, so the use of oxygen both reduces the load on a NaOH scrubber by converting more NO to HNO<sub>3</sub> for recycling and gives a better NO/NO<sub>2</sub> ratio for scrubbing.

Achieved environmental benefits

Downstream production of the ferric sulphate solution from copperas, results in a higher degree of copperas utilisation, and in reducing the impact of the TiO<sub>2</sub> production on the environment.

Cross-media effects

NO<sub>x</sub> emissions to air after final scrubbing of the process gas. Estimated NO<sub>x</sub> emissions amount to 0.04 kg NO<sub>x</sub> per tonne of the product, on average equivalent to 600 mg/Nm<sup>3</sup> of the gas released to the atmosphere.

Operational data

No detailed data submitted. Refer to Table 7.27.

Applicability

Technique applicable to the ferric sulphate plants based on the oxidation process with the mixture of nitric and sulphuric acids.

Economics

No data submitted.

Driving force for implementation

Full utilisation of the copperas co-product from the production of titanium dioxide, which results in a reduction of the impact of the production process on the environment. Ferric sulphate is an additional value added product in this group.

Example plants

No detailed information submitted. Refer to Table 7.26.

Reference literature

[59, CEFIC-TDMA, 2004], [20, CEFIC-TDMA, 2004], [42, UBA-Germany, 2001].

**7.5.4.4.2 Ferric sulphate production from copperas by the direct oxidation process**Description

In this process, the slurry of copperas is pumped to the pressure reactor where sulphuric acid is added in the presence of a catalyst and oxidation by oxygen gas occurs. After oxidation, the ferric sulphate obtained is pumped to an adjusting tank, where sodium chlorate is added to ensure complete oxidation.

Achieved environmental benefits

Downstream production of the ferric sulphate solution from copperas, results in a higher degree of copperas utilisation, and reduces the impact of the production of TiO<sub>2</sub> on the environment.

Cross-media effects

No detailed data submitted, however, releases of the sulphates to water are reported (refer to Table 7.28). Also, indirect emissions to air are generated due to the production of oxygen.

Operational data

No detailed data submitted. Refer to Table 7.28.

Applicability

Technique applicable to the ferric sulphate plants by the direct oxidation process with oxygen.

Economics

No data submitted.



### Driving force for implementation

Full utilisation of the copperas co-product from the production of titanium dioxide, which results in a reduction of the impact of the production process on the environment. Ferric sulphate is an additional value added product in this group.

### Example plants

No detailed information submitted. Refer to Table 7.26.

### Reference literature

[59, CEFIC-TDMA, 2004], [20, CEFIC-TDMA, 2004], [42, UBA-Germany, 2001].

### **7.5.4.4.3 Production of dried ferric sulphate**

#### Description

The manufacture of ferric sulphate is led by market demand. The supply of liquid ferric sulphate is normally in the country of production due to the relatively high cost of transport. The dried product is manufactured to supply more distant markets. Conversion of ferric sulphate solution to a dry product is typically carried out using a spray dryer. The energy consumption will reflect the level of crystallisation water in the final product, which varies between manufacturers and gives different properties in terms of ease of dissolution and handling. Gas cleaning will typically comprise wet venturi scrubbing and bag filters.

#### Achieved environmental benefits

Downstream production of the solid ferric sulphate (from the ferric sulphate solution derived from copperas), results in a higher degree of copperas utilisation, and reduces the impact of the production of TiO<sub>2</sub> on the environment.

#### Cross-media effects

Drying the ferric sulphate product from the original concentration of 40 % Fe<sub>2</sub>(SO<sub>4</sub>)<sub>3</sub> solution involves the usage of combustibles and, hence, the releases of NO<sub>x</sub>, SO<sub>x</sub> and (possibly) dust to the atmosphere.

#### Operational data

No detailed data submitted. Refer to Table 7.29.

#### Applicability

Technique applicable to the plants producing solid ferric sulphate.

#### Economics

No data submitted.

#### Driving force for implementation

Full utilisation of the copperas co-product from the production of titanium dioxide, which results in a reduction of the impact of the production process on the environment. Ferric sulphate is an additional value added product in this group.

#### Example plants

The ferric sulphate plant in Pori, Finland.

The ferric sulphate plant in Huelva, Spain.

#### Reference literature

[59, CEFIC-TDMA, 2004], [20, CEFIC-TDMA, 2004].

### 7.5.4.5 Best Available Techniques for the manufacture of liquid and solid ferric sulphate $\text{Fe}_2(\text{SO}_4)_3$

For general information on understanding a BAT section and its contents, see Section 7.1.5.

**For the manufacture of liquid and solid ferric sulphate, BAT is to:**

1. To achieve a high degree of copperas utilisation in given local conditions (market demand for ferric sulphate, the need to recover stockpiled copperas, plant configuration, energy supply-demand balance, and others), apply the process for the production of ferric sulphate liquor either by the reaction of copperas with a mixture of nitric and sulphuric acids or by direct oxidation of copperas with oxygen and sulphuric acid (see Sections 7.5.4.4.1 and 7.5.4.4.2).
2. Reduce dust emissions resulting from spray drying of 40 %  $\text{Fe}_2(\text{SO}_4)_3$  solution to 0.03 - 0.5 kg per tonne of solid ferric sulphate product by using wet venturi scrubbing and bag filters (see Sections 7.5.4.3.3 and 7.5.4.4.3).

## 7.5.5 Iron chlorosulphate

### 7.5.5.1 Background information

Product Name : Iron chlorosulphate  
CAS Number. : 12410-14-9

The main application of iron chlorosulphate (ferric chloride sulphate) is in the water treatment sector, especially drinking water and industrial water preparation. It is suitable as a flocculent, for phosphate precipitation and the removal of a sulphide from an effluent. It is also suitable for sludge conditioning, however this step of effluent treatment often uses cheaper additives, such as ferrous chloride solutions or copperas solutions[59, CEFIC-TDMA, 2004].

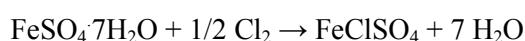
The major European iron chlorosulphate producers are listed in Table 7.30.

Country	No. of sites	Capacity tonnes per year
Germany	1	110000
France	1	50000
<b>Total</b>	<b>2</b>	<b>160000</b>

**Table 7.30: Major European iron chlorosulphate producers**  
[59, CEFIC-TDMA, 2004]

### 7.5.5.2 Process description

Copperas is dissolved in hot water (energy input) first. The solution is chlorinated with  $\text{Cl}_2$  in bubble columns with countercurrent recirculation. Unreacted (not absorbed)  $\text{Cl}_2$  is scrubbed with ferrous sulphate (copperas) solution in a separate scrubber. The scrubber liquor is periodically discharged and mixed with fresh ferrous sulphate solution going to a chlorination column. The chlorinated ferric sulphate solution is subsequently discharged from the column into a settling tank to separate the insoluble contents. The clear solution is marketed without further treatment.



This is an exothermic reaction, and the temperature rises from 50 to 80 °C.

The process flow diagram of the manufacture of iron chlorosulphate is given in Figure 7.11.

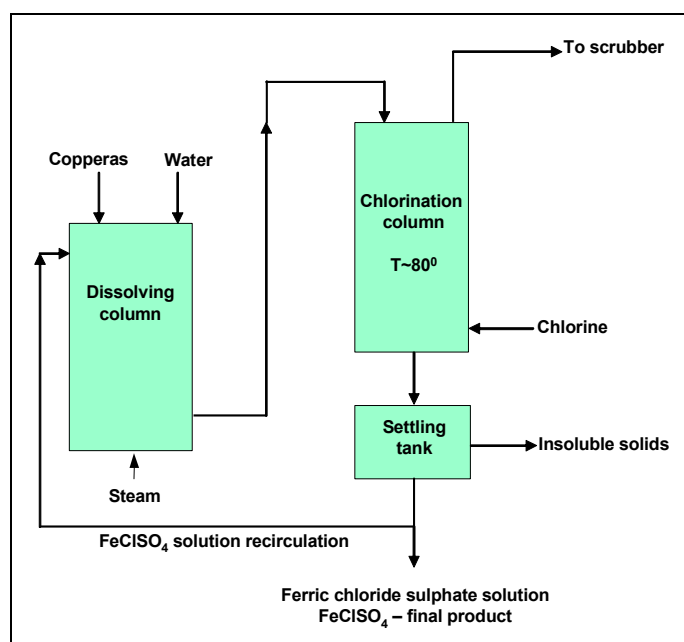


Figure 7.11: Process flow diagram – ferric chloride sulphate manufacture [59, CEFIC-TDMA, 2004]

### 7.5.5.3 Present consumption and emission levels

Typical consumption and emission values for the production of iron chlorosulphate are given in Table 7.31.

Energy and water consumption		
Energy consumption GJ/t product	0.15 – 1.17	
Water consumption m <sup>3</sup> /t product	320	
Emissions to air		
Chemical	Emission kg/t product	Emission concentration
Cl		<0.2 ppm
Emissions to water		
Chemical	Emission kg/t product	
None	N/A	
Waste to land		
Chemical	Waste kg/t product	Comments
None	N/A	

Table 7.31: Typical consumption and emission values – production of iron chlorosulphate [59, CEFIC-TDMA, 2004]

### 7.5.5.4 Techniques to consider in the determination of BAT

Introduction: Techniques to consider in the determination of BAT – refer to Section 7.1.4

#### 7.5.5.4.1 Iron chlorosulphate produced from copperas by chlorination

##### Description

Iron chlorosulphate belongs to the family of iron salts, which are co-products in the manufacture of titanium dioxide. Iron chlorosulphate is derived from ‘copperas’, which is the main by-product in the manufacture of TiO<sub>2</sub> by the sulphate process route. The broader the family of the final marketable products derived from copperas, the higher the degree of copperas utilisation, and the lower the combined impact of the production of TiO<sub>2</sub> by the sulphate process route on the environment.

The hot solution of copperas is chlorinated with gaseous chlorine. Unreacted  $\text{Cl}_2$  is scrubbed with copperas solution, which is recycled back into the process. The chlorinated ferric sulphate (iron chlorosulphate) solution is marketed without further treatment.

#### Achieved environmental benefits

Downstream production of the iron chlorosulphate solution from copperas results in a higher degree of copperas utilisation, and reduces the impact of the production of  $\text{TiO}_2$  on the environment.

#### Cross-media effects

No information submitted.

#### Operational data

No information submitted. Refer to Table 7.31.

#### Applicability

Technique applicable to the iron chlorosulphate plants by the chlorination process with chlorine.

#### Economics

No information submitted.

#### Driving force for implementation

Full utilisation of the copperas co-product from the production of titanium dioxide, which results in a reduction of the impact of the production process on the environment. Ferric sulphate is an additional value added product in this group.

#### Example plants

No detailed information submitted. Refer to Table 7.30.

#### Reference literature

[59, CEFIC-TDMA, 2004], [20, CEFIC-TDMA, 2004], [42, UBA-Germany, 2001].

### **7.5.5.5 Best Available Techniques for the manufacture of iron chlorosulphate ( $\text{FeClSO}_4$ )**

For general information on understanding a BAT section and its contents, see Section 7.1.5.

#### **For the manufacture of iron chlorosulphate, BAT is to:**

Reduce chlorine emissions to air to a level below 0.2 ppm of  $\text{Cl}_2$  in the off-gas from the scrubber by washing the outlet chlorinator gas with ferrous sulphate (copperas) solution (see Sections 7.5.5.3 and 7.5.5.4.1).

## **7.5.6 Iron oxide pigment**

### **7.5.6.1 Background information**

Product Name: Iron oxide pigment  
CAS Number: 1309-37-1

The manufacture of iron oxide pigment from copperas has a number of advantages from an environmental point of view [59, CEFIC-TDMA, 2004], namely:

- it uses excess copperas
- sulphuric acid is generated which is re-used
- it fulfils a market needs.

The major use of iron oxide pigment is shown in Table 7.32 below.

Use	Application
Pigment	Used in a wide range of decorative finishes where yellow, red and black tones are required

**Table 7.32: Major use of iron oxide pigment**

The major European producer is shown in Table 7.33 below.

Country	No. of sites	Capacity tonnes per year
Czech Republic	1	12000

**Table 7.33: Major European iron oxide pigment producer**

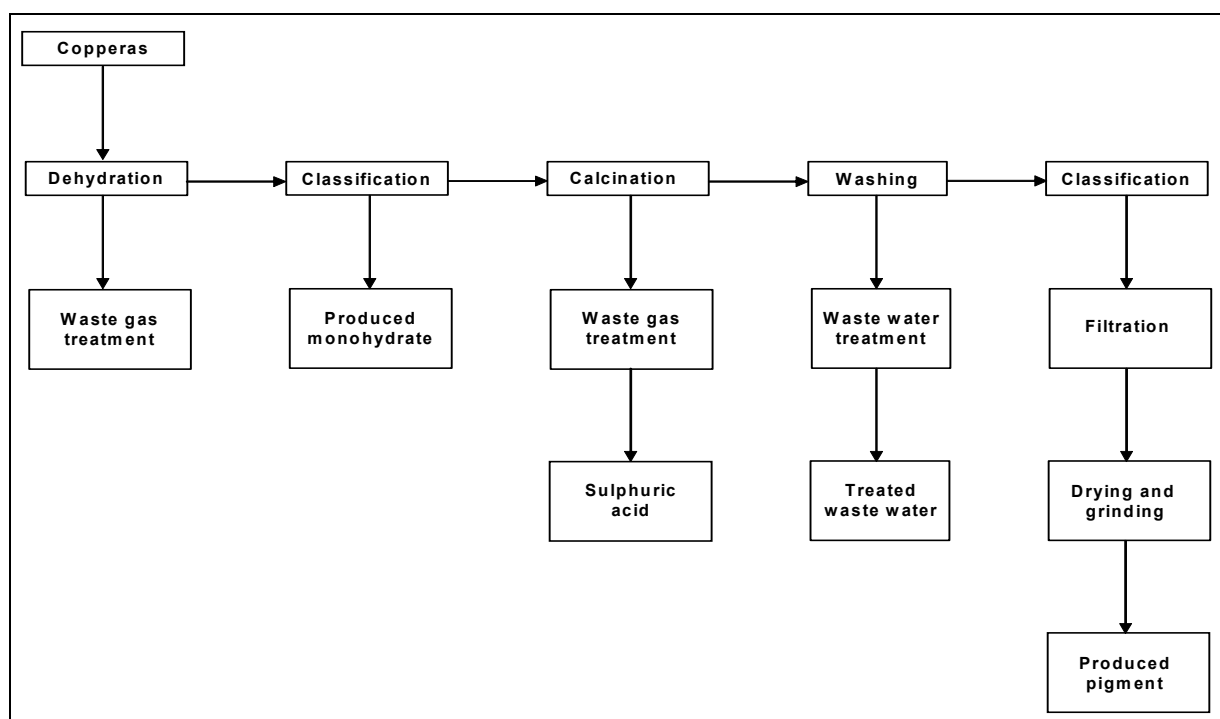
For the information on the production of iron oxide pigments refer to the SIC BREF.

### 7.5.6.2 Process description

The technology is based on the roasting of copperas [59, CEFIC-TDMA, 2004]. The first step is dehydration of copperas in a dehydration kiln to form ferrous sulphate monohydrate. Granules of the produced monohydrate are classified. In the next step, the coarse part of the monohydrate is calcined and the fine part of the monohydrate is sold. Waste gas (SO<sub>3</sub>) from calcination of the monohydrate is treated in the sulphuric acid plant. The sulphuric acid that is produced is used in titanium dioxide production. The calcined product is suspended in water. Soluble salts (ferric and ferrous sulphates) are washed out. All the waste water is treated in the neutralisation plant (which is common for all Precheza plants, i.e. titanium dioxide and sulphuric acid). Washed slurry is classified and non-pigment particles are removed (waste oxides). These waste oxides are disposed of to landfill. Classified slurry is dewatered and dried in the dryer. The dried pigment is ground, homogenised and packed in 25 kg paper bags or 1000 kg big bags.



The flow chart of iron oxide pigment production is given in Figure 7.12.



**Figure 7.12: Flow chart of iron oxide pigment production**  
[59, CEFIC-TDMA, 2004]

### 7.5.6.3 Present consumption and emission levels

The consumption of energy and water for the overall iron oxide pigment plant is shown in Table 7.34.

Energy and water consumption	
Energy consumption GJ/t product	28
Water consumption m <sup>3</sup> /t product	27

**Table 7.34: Consumption of energy and water for the overall iron oxide pigment plant**

The typical emission values for the dehydration of copperas are shown in Table 7.35.

Emissions to air		
Chemical	Emission kg/t product	Emission concentration
SO <sub>x</sub>	2.6	<150 mg/Nm <sup>3</sup>
NO <sub>x</sub>	2.6	<150 mg/Nm <sup>3</sup>
Dust (FeSO <sub>4</sub> ·H <sub>2</sub> O)	1.3	<90 mg/Nm <sup>3</sup>

**Table 7.35: Typical emission values for the dehydration of copperas**

The typical emission values for calcination are shown in Table 7.36.

Emissions to air		
Chemical	Emission kg/t product	Emission concentration
SO <sub>x</sub>	32	<1200 mg/Nm <sup>3</sup>
NO <sub>x</sub>	1.6	<60 mg/Nm <sup>3</sup>
Dust (FeSO <sub>4</sub> + Fe <sub>2</sub> O <sub>3</sub> )	0	0

**Table 7.36: Typical emission values for calcination**

The typical emission values for drying are shown in Table 7.37.

Emissions to air		
Chemical	Emission kg/t product	Emission concentration
SO <sub>x</sub>	0.04	<10 mg/Nm <sup>3</sup>
NO <sub>x</sub>	0.26	<50 mg/Nm <sup>3</sup>
Dust (Fe <sub>2</sub> O <sub>3</sub> )	0.006	<10 mg/Nm <sup>3</sup>
Waste to land		
Chemical	Waste kg/t product	Comments
None	55	

**Table 7.37: Consumption and emission values for the production of the iron oxide pigment [59, CEFIC-TDMA, 2004]**

### 7.5.6.4 Techniques to consider in the determination of BAT

**Introduction: Techniques to consider in the determination of BAT – refer to Section 7.1.4**

#### 7.5.6.4.1 Iron oxide produced from copperas by dehydration and calcination

##### Description

Iron oxide belongs to the family of iron salts, which are co-products in the manufacture of titanium dioxide. Iron oxide is derived from ‘copperas’, which is the main by-product in the manufacture of TiO<sub>2</sub> by the sulphate process route. The broader the family of the final marketable products derived from copperas, the higher the degree of copperas utilisation, and the lower the combined impact of the production of TiO<sub>2</sub> by the sulphate process route on the environment.

The manufacture of iron oxide pigments by the roasting of copperas is led by market demand. The technology is based on the roasting of copperas. The first step is the dehydration of copperas in a kiln to form ferrous sulphate monohydrate, which is then calcined. Waste gas ( $\text{SO}_3$ ) from calcination of the monohydrate is treated in the sulphuric acid plant. The sulphuric acid that is obtained is used in the production of titanium dioxide.

The calcined product is suspended in water. Soluble salts are washed out. The waste water is treated in the neutralisation plant. Washed slurry is classified and non-pigment particles are removed and disposed of to landfill. Classified slurry is dewatered, and the dried pigment is ground and homogenised.

### Achieved environmental benefits

Downstream production of the iron oxide pigment from copperas results in a higher degree of copperas utilisation, and reduces the impact of the production of  $\text{TiO}_2$  on the environment.

### Cross-media effects

Potential substantial emissions of  $\text{SO}_x$ , where the production of the iron oxide pigment from copperas is not integrated at the site with the production of sulphuric acid. Also, waste oxides are disposed of to landfill.

### Operational data

Refer to data included in Section 7.5.6.3 above.

### Applicability

In principle, applicable to the iron oxide pigment installation integrated with a plant which can utilise  $\text{SO}_x$ -laden off-gas from the calcination of iron oxide, e.g. a sulphuric acid plant.

### Economics

No data submitted.

### Driving force for implementation

Full utilisation of the copperas results in a reduction of the impact of the production process on the environment. Ferric sulphate is an additional value added product in this group.

### Example plants

The iron oxide plant in Precheza, the Czech Republic.

### Reference literature

[59, CEFIC-TDMA, 2004], [20, CEFIC-TDMA, 2004], [42, UBA-Germany, 2001].

## **7.5.6.4.2 Sulphuric acid production from waste gas in the production of iron oxide**

### Description

The type of calciner used in the process is not critical in terms of the impact on the environment. Sulphuric acid production from the waste gas derived from the production of iron oxide pigment (calcination step) is possible. The capacities of both plants then need to be harmonised, in order to allow for a high flexibility of the operation on a long term basis with a minimum impact of gaseous emissions of  $\text{SO}_x$  on the environment. Refer also to Figure 7.12.

### Achieved environmental benefits

When the iron oxide pigment installation is integrated with a plant which can utilise  $\text{SO}_x$ -laden off-gas from the calcination of iron oxide, such as a sulphuric acid plant, a substantial reduction of  $\text{SO}_x$  emissions to the air can be achieved.

Cross-media effects

No data submitted, however, the impact of the impurities in the waste gas on both the life-span of the vanadium catalyst used in the sulphuric acid plant, and on the quality of sulphuric acid produced need to be analysed.

Operational data

Refer to data included in Section 7.5.6.3 above. See also Figure 7.12.

Applicability

This technique is applicable for the integrated production of iron oxide pigment and sulphuric acid, provided it is possible to re-use the sulphuric acid produced.

Economics

No data submitted.

Driving force for implementation

The protection of the environment and the reduction of the manufacturing cost of iron oxide.

Example plants

The iron oxide and sulphuric acid plants in Precheza, the Czech Republic.

Reference literature

[59, CEFIC-TDMA, 2004], [20, CEFIC-TDMA, 2004], [42, UBA-Germany, 2001].

### **7.5.6.5 Best Available Techniques for the manufacture of iron oxide pigment ( $\text{Fe}_2\text{O}_3$ )**

For general information on understanding a BAT section and its contents, see Section 7.1.5.

**For the manufacture of iron oxide pigment, BAT is to:**

1. Maintain the overall energy consumption in the process below 28 GJ per tonne of  $\text{Fe}_2\text{O}_3$  product by optimising the chain of operations in the process, from the dehydration of raw material copperas in the kiln to drying and grinding iron oxide pigment (see Sections 7.5.6.3 and 7.5.6.4).
2. Reduce  $\text{NO}_x$  emissions to air from the copperas dehydration kiln to a level below 2.6 kg  $\text{NO}_2$  per tonne of  $\text{Fe}_2\text{O}_3$  produced (equivalent to about 150 mg  $\text{NO}_2/\text{Nm}^3$ ) by controlling and optimising process parameters in the dehydration of copperas to ferrous sulphate monohydrate (see Sections 7.5.6.3 and 7.5.6.4).
3. Reduce  $\text{SO}_x$  emissions to air from the calcination of ferrous sulphate monohydrate to a level below 32 kg  $\text{SO}_2$  per tonne of  $\text{Fe}_2\text{O}_3$  produced (equivalent to about 1200 mg  $\text{SO}_2/\text{Nm}^3$ ) by integrating the operations of the  $\text{Fe}_2\text{O}_3$  plant with the sulphuric acid plant at the site and harmonising the utilisation of capacities of both plants on a long term basis (see Sections 7.5.6.3 and 7.5.6.4).
4. Reduce dust emissions from the production of  $\text{Fe}_2\text{O}_3$  pigment to air to 1.3 kg per tonne of  $\text{Fe}_2\text{O}_3$  produced by using a combination of dust removal techniques, including bag filters (see Sections 7.5.6.3 and 7.5.6.4 and Section 7.5.3.3).



## 7.6 Lead oxide

### 7.6.1 General information

#### 7.6.1.1 Introduction

This section concerns the production of lead oxide, more specifically red lead ( $\text{Pb}_3\text{O}_4$ ) and litharge ( $\text{PbO}$ ).

There is another form of lead oxide, a partially oxidised material commonly known as 'battery oxide' or 'grey oxide'. This is used exclusively by the lead-acid battery industry and the vast majority is produced on site for captive demand. Therefore, it is, in principle, not covered in this section.

Currently some 1 million tonnes of lead is consumed yearly in the lead-acid battery market in Europe for the production of automotive starter batteries as well as industrial traction and stationary batteries. For more information on 'battery oxide' refer to Council Directive 91/157/EEC of 26/03/1991, and to the Proposal for a Directive of the EP and Council on Batteries and Accumulators and Spent Batteries and Accumulators COM(2003) 723 final, 21/11/2003 [85, EIPPCB, 2004-2005].

As the manufacture of lead compounds is heavily regulated, all lead oxide manufacturers take precautions to avoid emissions from their production plants. This implies the high standard of precautions and emission abatement methods used in lead oxide production plants and also includes employees who have contact with lead compounds in the plant (refer to Section 7.6.2.3 below).

#### 7.6.1.2 Background information

The usage of lead continues to increase and has risen from 4 million tonnes per year worldwide in the 1960s to 6 million tonnes in the 1990s. Nearly 2 million tonnes per year are produced in Europe. Secondary production or recycling is now widely practised and currently accounts for some 70 % of usage worldwide. Lead has some important properties, in particular malleability, ease of production, ease of melting and joining, and good corrosion resistance in the most common environments.

Lead oxide constitutes a family of compounds with varying numbers of oxygen atoms per molecule, depending on the valence state ( $\text{Pb}^{+2}$  or  $\text{Pb}^{+4}$ ) of the lead, and the two different crystal structures (tetragonal and orthorhombic) with the same chemical formula [96, CEFIC-ELOA, 2004].

Depending on the degree of oxidation, lead oxide can exist in various forms, some of which are listed in Table 7.38.

No	Formula	Complex formula	Degree of oxidation	Pb content (%)
1	$\text{PbO}$		$\text{PbO}_{1.000}$	92.832
2	$\text{Pb}_3\text{O}_4$	$2 \text{PbO} \cdot \text{PbO}_2$	$\text{PbO}_{1.333}$	90.665
3	$\text{PbO}_2$		$\text{PbO}_{2.000}$	86.622

**Table 7.38: Common forms of lead oxide**  
[96, CEFIC-ELOA, 2004]

In addition to the different degrees of oxidation,  $\text{PbO}$  exists in two crystal forms, leading to different physical properties. The degree of oxidation and the different lattice modifications require a variety of production processes and operating conditions to achieve the desired product and a high purity lead oxide product.

The three types of lead oxide commonly produced in the EU-15 are presented in Table 7.39.

Type of oxide	Name	Trivial name	Formula
Litharge	$\beta$ -lead monoxide	Yellow lead oxide	PbO
Red lead	Minium	Minium	Pb <sub>3</sub> O <sub>4</sub>
Battery oxide	Mix of $\alpha$ -lead oxide and $\beta$ -lead oxide	'Grey oxide' or 'leady oxide'	Pb/PbO

**Table 7.39: Types of lead oxide commonly produced in the EU-15 [96, CEFIC-ELOA, 2004]**

Battery oxide ('grey oxide' or 'leady oxide') is a mixture of PbO and Pb (containing approx. 70 % PbO and 30 % Pb). This form of lead oxide is used exclusively by the lead-acid battery industry and the vast majority is produced on site where it is required – see Section 7.6.1.1.

### 7.6.1.3 Usage patterns and economic importance

#### 7.6.1.3.1 Applications for litharge

Litharge is used for the following applications [96, CEFIC-ELOA, 2004]:

##### Technical glass

In television screens and other cathode ray tubes (e.g. computer monitors), lead oxide is used to shield users from harmful radiation. The high density and good optical properties of leaded glass make it useful for this application. The funnel glass contains some 22 % lead oxide, the neck and stem contain 30 % lead oxide and the frit ('solder glass' used to join the different sections) contains 70 % lead oxide. The use of lead oxide in television screens is one of its largest current applications. Both litharge and red lead can be used in a variety of optical glass applications (lenses, fibres, etc.).

##### Crystal glass

Lead oxide has been added to glasses since ancient times. The main advantage to early glass-makers was the great reduction in melting temperature. The addition of lead oxide also changes other properties of glass. Leaded glass has an increased refractive index giving it a more attractive appearance in crystal and making it suitable for certain optical glass. Lead oxide in crystal glass is used to enhance the colour, tone and handling. Lead crystal contains around 24 % lead oxide (refer also to the BREF on the Glass Manufacturing Industry).

##### Ceramics industry

There is an extremely long history of the use of lead compounds for glazing. Litharge enhances the physical properties of ceramic glazes improving their temperature-flow characteristics and colour properties. Vitreous enamels for metals can be formulated with litharge, chiefly for the coating of cast iron.

##### Stabilisers for PVC

All thermoplastics require small amounts of additives, called stabilisers, to prevent the material degrading rapidly during manufacture or in service. Litharge is consumed in significant quantities in the European plastics industry. Litharge is used to manufacture PVC stabilisers (lead sulphates, lead phosphites, lead stearates, etc.). In general these lead salts, used in relatively small quantities – <2 % – significantly improve the thermal and light stability of PVC products, like window frames, guttering, pipes and other products used outside.

##### Others

Lead oxide is used in specialist lubricants, as petroleum refining additives, as a rubber vulcanising agent and as an inorganic pigment.

### 7.6.1.3.2 Applications for red lead

Red lead is used for the following applications [96, CEFIC-ELOA, 2004]:

#### Lead acid storage batteries

Red lead is used in battery plates either on its own (mostly in industrial batteries) or as a mix with battery oxide in automotive batteries. The red lead enhances the electrochemical properties of the battery.

#### Technical glass

In television screens and other cathode ray tubes (computer monitors), red lead is also used to shield users from harmful radiation.

#### Other glass

Optical glass (lenses and fibres) is also an application for red lead and litharge.

#### Ceramic and glass industries

Similar to litharge, red lead is used for the manufacture of glasses and glazes improving the thermal and physical properties as well as the handling.

#### Paints and pigments

Red lead has been traditionally used as a very effective anti-corrosion pigment. This is now declining and red lead is only used for some specialist industrial applications.

### 7.6.1.4 Economic importance

The consumption of lead for the manufacture of ‘pigments and other compounds’ in the EU-15 is reported by the International Lead and Zinc Study Group. However, it must be noted that these data cover all lead compounds and not just lead oxide. Table 7.40 gives the consumption of lead for the manufacture of pigments and other compounds in the EU-15 in 2000 [96, CEFIC-ELOA, 2004]. The estimated consumption of lead metal in the EU-15 for ‘free market’ lead oxides by application (i.e. not including oxides produced internally by lead acid battery manufacturers) is presented in Table 7.41 below [96, CEFIC-ELOA, 2004].

Country	Lead consumption (tonnes)
Germany	88300
Italy	23900
Spain	23500
United Kingdom	18600
France	16600
Austria	14500
Netherlands	4000
Belgium	1800
<b>Total EU-15</b>	<b>191200</b>

Table 7.40: EU-15 consumption of lead for the manufacture of pigments and other compounds [96, CEFIC-ELOA, 2004]

Application	Consumption (tonnes)
Television glass	33000
Crystal glass	25000
PVC stabilisers	50000
Ceramics	25000
Pigments	16000
Batteries (free market only)	8500
Miscellaneous	8500
<b>Total EU-15</b>	<b>166000</b>

Table 7.41: Estimated EU-15 consumption of lead metal for ‘free market’ lead oxides [96, CEFIC-ELOA, 2004]

## 7.6.2 Applied processes and techniques

### 7.6.2.1 Process boundaries

Within the West European lead oxide industry, some companies produce lead oxides for external sale almost exclusively, others produce lead oxide for further processing into lead stabiliser compounds, and still others purchase lead oxide externally to produce lead stabiliser compounds. It should be noted that the final formulated stabiliser product is a complex blend of various components and there are some producers in Western Europe who perform the blending only, and do not manufacture the primary raw materials used in the blends.

Due to the different production routes, it is necessary to subdivide this by product. Lead is the main input raw material, usually with a purity of 99.9 %, for lead sheet and lead oxide production. Lead oxide production focuses on three of the previously mentioned oxides ( $\text{PbO}$ ,  $\text{Pb}_3\text{O}_4$  and  $\text{Pb/PbO}$ ). These products are input materials for other downstream manufacturing processes external to lead oxide production. In a few cases only, the lead stabiliser and lead oxide production are located within the same plant. The process boundaries for lead oxide manufacture are defined as shown in Figure 7.13.

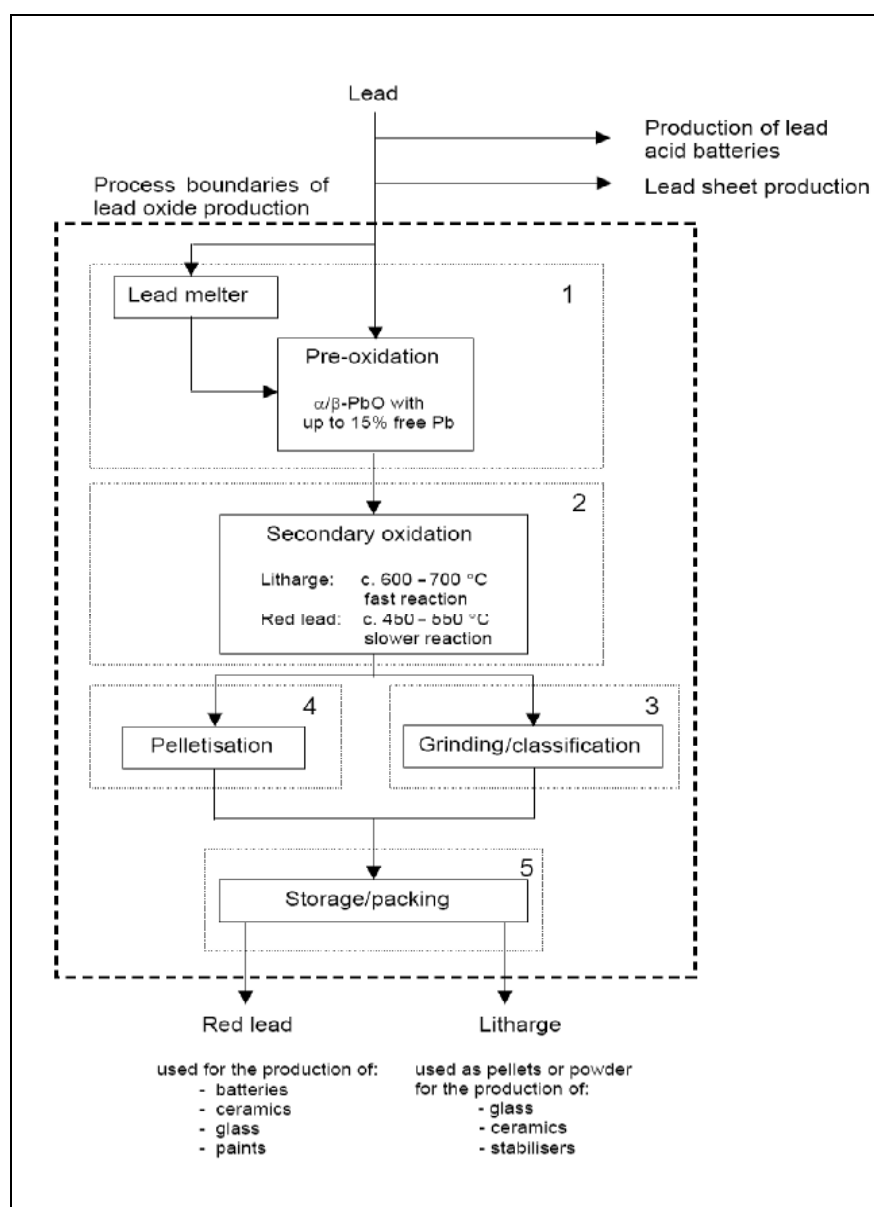


Figure 7.13: Process boundaries indicating different process steps in lead oxide production [96, CEFIC-ELOA, 2004]

### 7.6.2.2 Lead oxide production process

In general, the production of lead oxide encompasses the production of 'litharge' (PbO), 'battery oxide' (Pb/PbO) and 'red lead/minium' (Pb<sub>3</sub>O<sub>4</sub>). As shown in Figure 7.13, lead oxide production is carried using the following five main processing steps:

1. Pre-oxidation (production of 'crude' oxide)
2. Secondary oxidation (final oxidation)
3. Grinding/classification
4. Pelletisation
5. Packaging.

These five steps will be explained in the following five sections.

#### 7.6.2.2.1 Pre-oxidation (production of 'crude' oxide)

In the pre-oxidation step, solid or liquid lead raw material is oxidised with air at a temperature from 350 to 650 °C. The lead ingots can be fed into a lead melter to produce a liquid lead feed to a stirred reactor (Barton process), or complete ingots are fed directly into a rotary furnace. Both the stirred reactor and the rotary furnace operate under negative pressure with the oxide being transported into a filter separation system. The temperature and airflow are used in the process to control the free lead and crystal structure of the crude oxide produced. A free lead of up to 15 % is common.

All industrial manufacturing processes of lead oxides use highly refined metallic lead (99.9 %) as raw material. The oxidation of lead metal is exothermic. However, for the stirred reactor process, the lead must first be melted. For the rotary furnace process, gas is commonly used to heat the first section of the furnace in order to melt the lead ingot feed. Once the oxidation reaction has been initiated the temperature profile in the process can be maintained without additional heat. The chemistry of the process is an oxidation of lead with atmospheric oxygen. The degree of oxidation can vary from 60 % up to 99 %, depending on the plant design and operational methods. The reaction temperature (usually set between 400 and 640 °C), the oxygen partial pressure of air and the residence time in the process, determine whether the crude material obtained is most suitable for battery oxide (i.e. no further processing), red lead or litharge. Examples of these techniques are described below:

#### Stirred reactor

The oxidation of molten lead commonly takes place in an agitated reactor. In this agitated reactor, the oxidation known as the 'Barton Process' takes place in a continuous process. The degree of oxidation can vary from 60 % up to 99 %, depending on the design of a plant and operational methods. Other process variables have already been described above.

A schematic diagram showing the stages of the Barton process (pre-oxidation in a stirred reactor) is given in Figure 7.14.

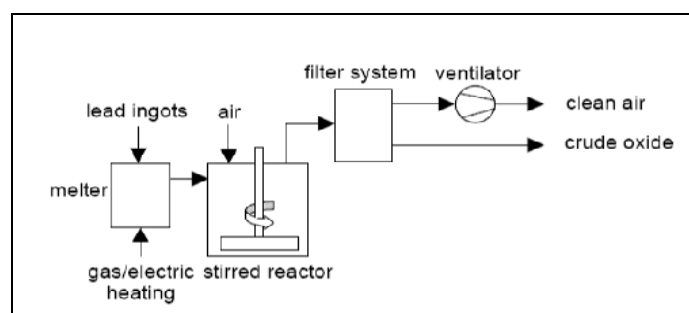


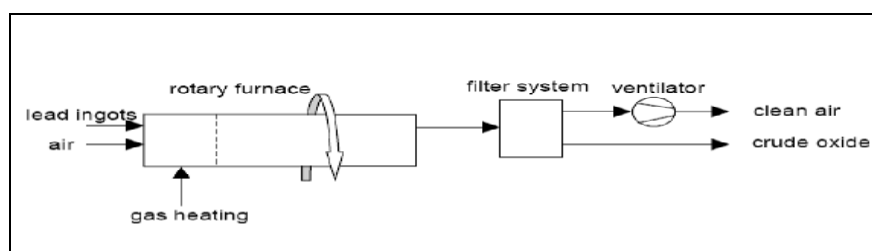
Figure 7.14: Pre-oxidation in a stirred reactor  
[96, CEFIC-ELOA, 2004]

The melting pot containing molten lead at 400 – 500 °C is installed in close proximity to the reactor and normally higher than the reactor. The oxide is drawn out of the reactor under suction by air. The separation of the product and air takes place in a filter system. A cyclone can be used before the main filter, but is not always required.

The oxide is removed in the cyclone/main product filter (filter bags). A second stage filter (either local to the main filter or a central second filter plant) can be used as a security filter in the event of a hole in a bag in the product filter. All the filter units are monitored for both temperature and pressure drop. Modern fabric filter units with a high surface area in combination with automatic cleaning, ensure that the requirements of the European pollution control legislation are met.

### Rotary furnaces

Pre-oxidation is also carried out in rotary furnaces – a schematic process outline is shown in Figure 7.15. The main furnace runs on rollers and is driven by a pinion and crown wheel. The drum interior is divided into four sections surrounded by a refractory lined housing which serves as heat insulation and heat control. The first section is continuously heated externally with the aim of melting the lead ingots fed into the drum. This section is comparable to the melting pot of the stirred reactor, although there is already an initial degree of oxidation. As the material moves along the furnace, it is further oxidised. Fine oxide is removed by the airflow through the furnace and carried through the filter system. As the oxidation reaction is exothermic, water injection inside the drum is required to control the reaction temperature. A crude oxide with a content of 90 – 99 % PbO can be obtained in a rotary furnace.



**Figure 7.15: Pre-oxidation in a rotary furnace**  
[96, CEFIC-ELOA, 2004]

In comparison to a stirred reactor, the rotary furnace has a large production capacity and a lower specific energy consumption. However, the stirred reactor process is far more flexible and reaches stable production within a short time, whereas the rotary furnace requires some time to stabilise.

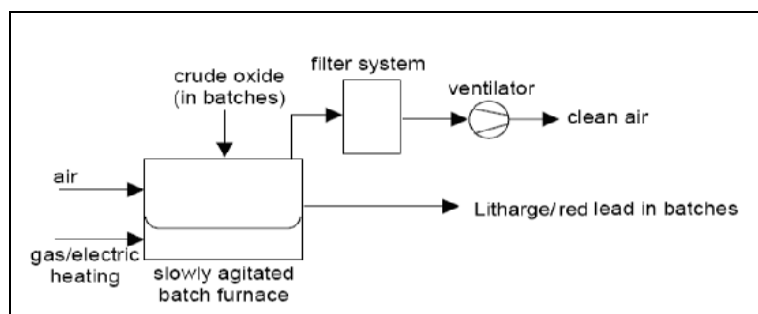
#### 7.6.2.2.2 Secondary oxidation (final oxidation)

The crude oxides produced in the pre-oxidation step contain a certain percentage of metallic lead. These lead residues must be further oxidised to obtain the desired products. The secondary oxidation step can be carried out in a variety of reaction vessels (e.g. batch furnaces, heated tubular furnaces, heated rotary furnaces). Each of the above processes differs in terms of the temperature-residence time profile seen by the crude oxide and offers different advantages in terms of production cost, time cycle, and product quality.

As mentioned above, lead residues contained in the crude oxides must be further oxidised to obtain litharge, or in the case of red lead, the lead monoxide itself must be further oxidised. Battery oxide, being partially oxidised material does not need any further oxidation. For the production of litharge, the second oxidation step, which is also called calcination, is conducted at a minimum temperature of 580 °C, although temperatures in excess of 600 °C are common. The oxidation process required to form red lead is generally carried out at 480 – 490 °C, when the unit runs at an increased oxygen partial pressure, and at around 550 °C when the process is conducted at atmospheric pressure. The secondary oxidation of both products can take place in a number of different units, several of which are described below.

### Hearth/batch furnace

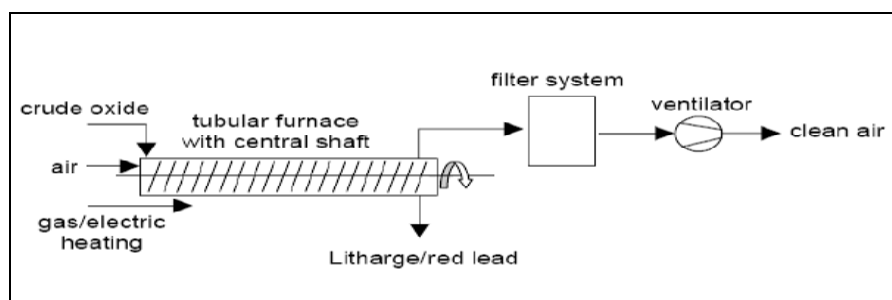
In the case of batch furnaces the most common technique applied is indirect heating from below and sometimes with special fans for hot gas circulation. The oxide can be slowly agitated by a central shaft with raking arms; for litharge furnaces manually raking (with long poles) can also be used. The crude oxide remains in the furnace until the metallic lead is fully oxidised. In this manner, the crude oxide is processed in batches. The processing takes between 90 and 120 minutes for litharge while for red lead the processing time can be from 8 to 36 hours depending upon the crude oxide quality, free lead content and the required degree of oxidation in the final red lead. Figure 7.16 shows the block scheme of secondary oxidation in a batch furnace.



**Figure 7.16: Secondary oxidation in a batch furnace**  
[96, CEFIC-ELOA, 2004]

### Heated tubular furnace

The principle of an indirectly heated screw conveyor for calcination is fairly simple and very efficient. In a heated tube the material is continuously conveyed by moving paddles. Larger capacity litharge and red lead furnaces are composed of a number of such heated tubes connected in series/parallel. The continuous mode of operation requires a crude oxide feed material of a constant quality to ensure complete oxidation. Red lead requires a processing time some 10 to 20 times greater than that for litharge (depending upon the raw oxide quality and the final degree of oxidation required). A schematic diagram of second stage oxidation in a heated screw tube conveyor is presented in Figure 7.17.

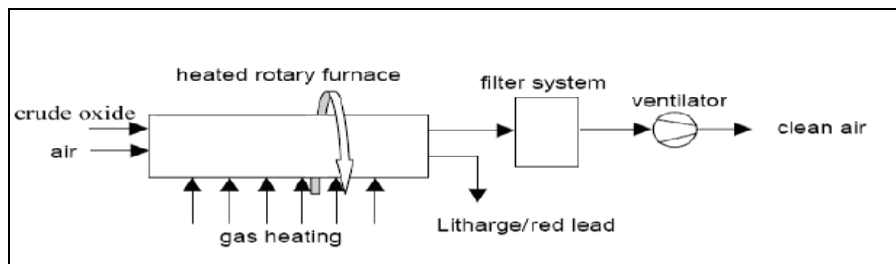


**Figure 7.17: Secondary oxidation in a tubular furnace**  
[96, CEFIC-ELOA, 2004]

### Heated rotary furnace

The rotary furnace for secondary oxidation operates very much on the same principle as that for the pre-oxidation. Crude oxide is continuously fed into the main drum. The oxide moves gradually along the drum being slowly rotated and heated externally at the same time. Processing time is controlled by the number of rotations per minute, the filling level and the flow of oxide through the unit.

Figure 7.18 shows a scheme of the secondary oxidation in a rotary furnace.



**Figure 7.18: Secondary oxidation in a rotary furnace**  
[96, CEFIC-ELOA, 2004]

### 7.6.2.2.3 Grinding/classification

After the oxidation process, some additional finishing processes are required, such as grinding or classification to remove agglomerates formed during the secondary oxidation. Due to secondary processing, free lead and temperature, a degree of agglomeration is to be expected. A variety of common grinding/milling processes are used – a common feature being that they operate under suction to minimise any possible emissions. The coarse and hard agglomerates can also be separated and recycled back into the process. These grinding and classification steps are normally fitted with filter units with large surface areas and often include automatic cleaning. Litharge is very often required in a powder form to ensure good reactivity in further chemical processing (e.g. stabiliser production). For red lead, grinding is usually required to achieve a certain density of the product. Both grinding/milling and air classification are common processes. In some cases, both processes are applied, as follows.

#### Grinding

The simplest process is a single-step grinding process. Grinding litharge, however, can cause deposits inside the mill housing. The coarse and hard agglomerates are recycled to the calcination process. Red lead on the other hand, is easily milled and causes little or no problems with deposits in the mill or pipework. Pinned disc mills and turbo mills have been found to be most suitable for litharge and red lead. They work with a relatively high volume airflow under suction with the product settling out in a storage silo and the carrier air passing through a filter system.

#### Air classification

In some cases, air classifiers are used. The material dispersed in the carrier air is always subjected to relatively high stress that can help to break up loose agglomerates. The lighter/powdered material is carried with the air into a filter system. Harder agglomerates settle out and are removed. The application of pinned disc mills, turbo mills and air classifiers require an effective dedusting of the exhaust air. This can be achieved by using a dual filtration system, normally in the form of fabric bag filter units with a large surface area, equipped with automatic cleaning.

### 7.6.2.2.4 Pelletisation

There are a number of techniques used to produce a pelletised lead oxide. This is most common in litharge production but can also be used for red lead. The pelletisation can range from: selection of the agglomerates produced within the oxidation process; mechanical compaction; use of additives such as water glass; specialised pelletisation furnaces where the lead oxide is liquefied, then sprayed to produce a 'melt' granule; sintering in a direct fired rotating chamber. In all of these processes there is a need for a further sieving of the pellets to select the fraction required by the customer. Oversize and undersize particles can be returned to the process.



The following are pelletisation processes in common use for the manufacture of granules/pellets starting from lead oxide (mostly litharge, but some small amounts of red lead) powder:

- agglomerates are produced naturally by secondary oxidation. The selective removal of these agglomerates produces a pelletised product. This process is only used for litharge
- litharge can be fed forward into a mechanical compacting plant where the moistened powder product is pressed through rollers. The compacted material is broken up and the required size fraction separated out
- litharge can be moistened and fed into a directly heated slowly rotating drum. This causes the oxide to agglomerate and form hard particles that can be selected by sieving
- additives such as water glass/silica can also be added to lead oxide and put through a rotating drum/table with heating to form a pelletised product
- for technical glass, a melt litharge particle is preferred due to its relative hardness. This type of pellet requires a large (directly) gas heated furnace. The crude oxide/litharge is fed into a melt chamber where the temperature is raised to over 900 °C. The litharge melts and runs out of the chamber, where it is either hit by an air jet or a rotating steel plate. Both of these cause the liquid litharge to form small particles that drop down and then cool in a large chamber.

For pelletised products, the main considerations for the end-user are the ease of handling, flow and mixing properties, hardness and dusting, as well as the relative cost. It must be stated that for all the production steps described, the actual technology employed in a given situation depends, to a large extent, on a variety of technical and commercial factors (e.g. energy availability and cost, production volumes and qualities, variability of production load through the year, etc.).

### **7.6.2.2.5 Packaging**

The finished products of the oxidation processes are almost exclusively stored in silos or hoppers fed via closed pneumatic or mechanical conveyor systems. Storage and transport systems are connected to filter plants to ensure that they are held under suction and thereby minimising any possible dust emissions. The final products may be packaged and transported in silo cars, fabric big bags, plastic sacks, steel containers, paper sacks or steel drums. Packaging for lead oxides have to be approved for the transport of dangerous goods.

Handover points and filling and packing machines are equipped with air extraction systems in order to minimise fugitive dust emissions – refer also to Section 7.6.2.3 below. Packaging materials contaminated with lead compounds are disposed of in closed systems - refer to Section 7.6.3.1.3 below [85, EIPPCB, 2004-2005].

### **7.6.2.3 Management system for reduction of diffuse emissions and exposure to lead**

The manufacturers of lead oxide have to avoid or minimise lead emissions to reduce the environmental impact of lead and to protect the health of their employees. In particular, of key importance are the measures applied to reduce fugitive emissions in the production of lead oxide. As mentioned above in Section 7.6.2.2.5, air extraction systems are applied to minimise fugitive dust emissions. Closed circuits held under negative pressure for all the process operations, from the lead melter to product handling, packaging and storage, prevent or reduce diffuse emissions and are in particular effective in combination with management systems for reduction of exposure to lead. Besides the measures applied for the reduction of diffuse emissions, additional control systems are introduced to minimise the inhalation of lead dust. The additional measures to protect the health of the employees can be summarised as follows [96, CEFIC-ELOA, 2004]:

- regular cleaning of the workplace to avoid accumulation of dust
- monitoring air lead concentrations and observing limits. The maximum permissible workspace level of lead in the air is  $0.15 \text{ mg/m}^3$  in the EU. Some Member States have stricter regulations (e.g.  $0.1 \text{ mg/m}^3$ )
- use of appropriate personal protection equipment, particularly respiratory protection
- periodic screening of employees for general health and lead exposure. There are statutory levels of exposure above which the employer must take action to reduce the exposure of the individual, and above which the individual must be removed from the area where he will be exposed to lead
- effective hygiene practices for the reduction of lead exposure to personnel. This includes the provision of clean areas for eating and drinking, provision of clothes to be worn on site and changed when leaving, no smoking on site, hand washing before eating.

### 7.6.3 Present emission and consumption levels

#### 7.6.3.1 Emissions from the manufacture of lead oxide

Emissions from the manufacture of lead oxide are summarised in Figure 7.19.

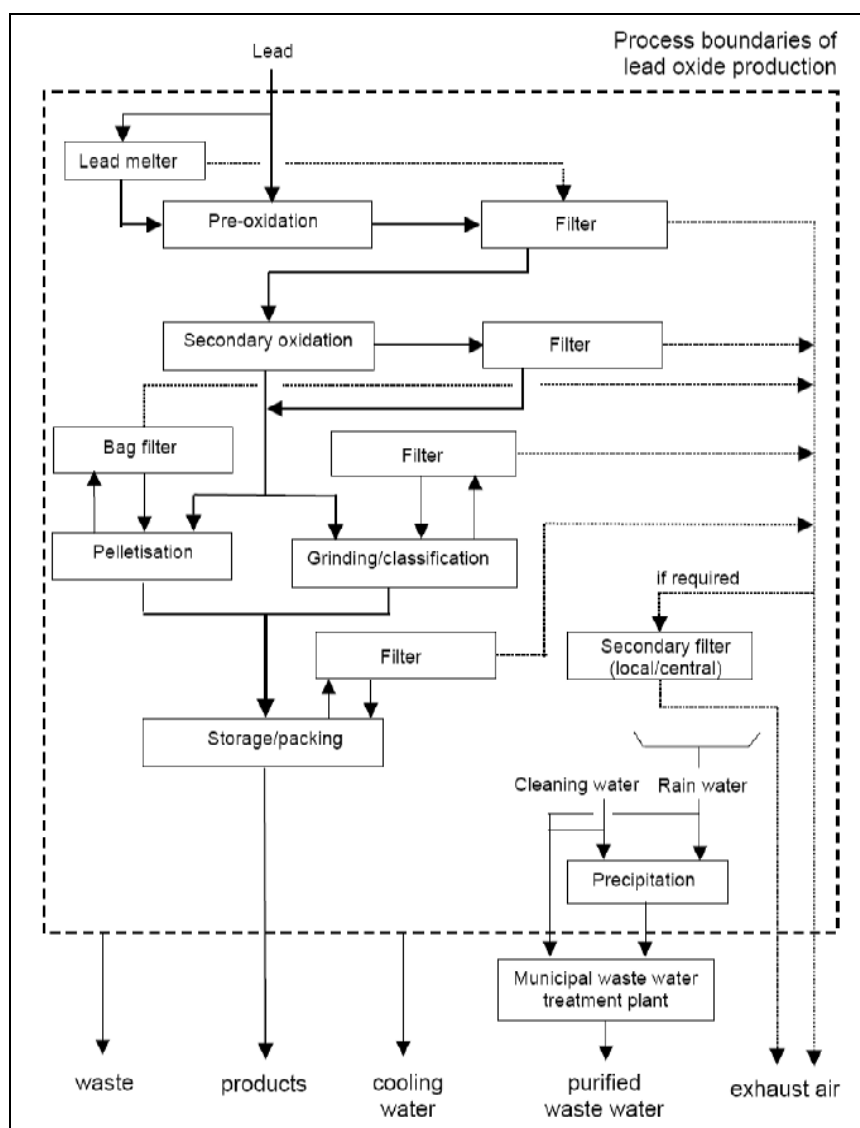


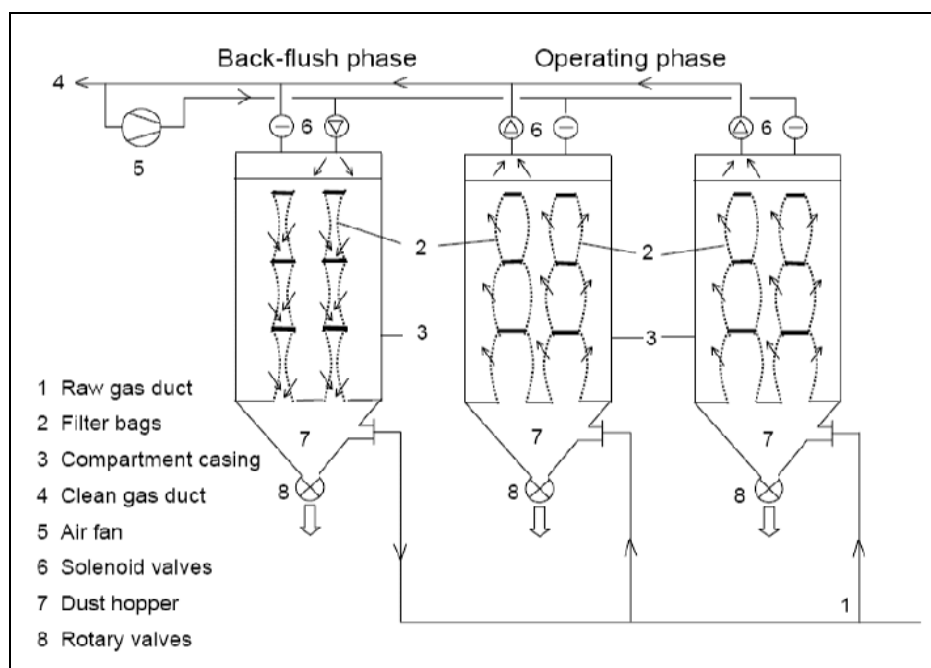
Figure 7.19: Emissions from the production of lead oxide [96, CEFIC-ELOA, 2004]

## 7.6.3.1.1 Emissions to air

Due to the environmental and health effects of the production of lead compounds, the total production process for lead oxides is a largely closed circuit held under negative pressure. Crude oxides, fully oxidised products and finished products are commonly transported via pneumatic conveyors, by screw feeders and bucket elevators. Modern filter separation units to separate the powder/product from the carrying air stream, are standard practice. In general, the filter system consists of a main product filter and can be followed by a second security filter. The second filter can be a single unit connected directly to the product filter or a central large security filter.

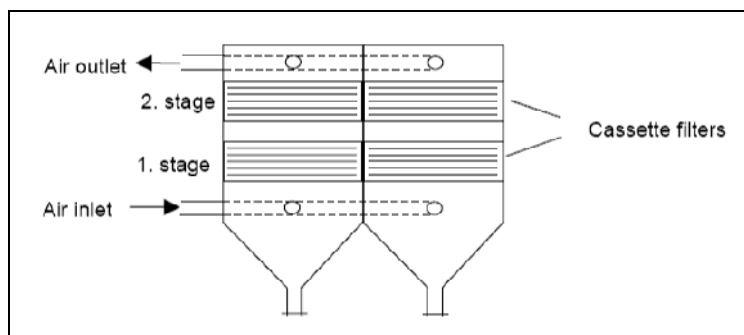
The main product filter is usually a bag-house type with fabric filter sacks. A common filter bag material used in the production of lead oxide is a polyester needle felt. This type of filter material can operate at temperatures of up to 140 °C.

Filter units are usually fitted with inlet air temperature monitoring and alarms to protect the filter bags, as well as with continuous differential pressure measurement. The principle of the fabric filter system used in the lead oxide industry, is shown in Figure 7.20 [96, CEFIC-ELOA, 2004], see also the BREF on the Waste Water and Waste gas Treatment/Management Systems in the Chemical Sector (CWW).



**Figure 7.20: Example of a fabric filter system used in the lead oxide industry [96, CEFIC-ELOA, 2004]**

If required, secondary filters are usually cassette type units (see Figure 7.21). These are also fitted with differential pressure drop measurement. In such a case the differential pressure is more likely to detect a sudden rise in pressure caused by oxide carryover from a holed bag in the main product filter. The secondary filter ensures that there are no oxide releases to the environment.



**Figure 7.21: Principle of a cassette filter system**  
[96, CEFIC-ELOA, 2004]

Depending on the combination of filter systems, exhaust air from the production of lead oxide is cleaned to values between 0.7 up to 6 g Pb emitted to air per tonne Pb produced or used.

### 7.6.3.1.2 Emissions to water

Water is only used for the indirect cooling of furnaces or for direct injection within the process. Lead oxide production is a dry process, so that no process water is emitted. However, lead oxide manufacturers have to consider the following part streams:

- rainwater
- water from cleaning operations
- cooling water.

Contrary to cooling water, rainwater and water from cleaning operations normally has to be purified to reduce the Pb concentration. In most cases, the waste water is treated by physico-chemical means. With the support of water additives, e.g. organic polymers, the lead content is reduced by precipitation to below the legal limit of 0.5 mg Pb/l. The emission factor varies from 0.07 – 0.18 g Pb emitted in water per tonne Pb produced or used. In accordance with local legal requirements, other enterprises discharge their partly contaminated streams to the municipal waste water treatment plant.

### 7.6.3.1.3 Solid wastes

The main solid residues from the production of lead oxide are, in principle, similar to those encountered in other industrial activities [96, CEFIC-ELOA, 2004], [85, EIPPCB, 2004-2005]. The selected method of solid waste treatment from the production of lead oxide depends mainly on the degree of contamination with lead compounds (residues from the production, lead oxide packaging materials) and hazardous substances (e.g. brickwork).

The recycling rate of waste depends on the lead content and cost. Depending on the kind of waste, the following types of waste treatment are executed (see Table 7.42 below):

Recycling	e.g. residues with a high Pb content to the smelter
Incineration	e.g. packaging material contaminated with Pb (disposed of in closed systems)
Landfill	e.g. brickwork (inorganic waste containing Pb and other hazardous substances)

**Table 7.42: The main methods of solid waste treatment used in the lead oxide industry**  
[96, CEFIC-ELOA, 2004], [85, EIPPCB, 2004-2005]

The quantity of waste, which has to be incinerated, disposed of or recycled outside the process boundaries, varies significantly from year to year, depending on the type of waste, e.g. such as brickwork. Most lead oxide production plants have specific emission factors for inorganic solid waste of between 2 and 6 kg Pb/t Pb produced or used.

### 7.6.3.2 Energy consumption and associated CO<sub>2</sub> emissions

In most of the plants, gas is used to heat the furnaces, while electrical energy is necessary for ventilation and rotating machinery. Therefore, the energy consumption of a lead oxide production plant includes both a demand for gas and electricity. The specific energy demand (kWh) per tonne lead is summarised in Table 7.43 below:

Energy consumption per tonne of Pb		
Gas	min	190 kWh
	max	640 kWh
Electricity	min	160 kWh
	max	250 kWh
Total energy	min	350 kWh
	max	890 kWh

**Table 7.43: Energy consumption per tonne lead of a typical lead oxide production plant [96, CEFIC-ELOA, 2004]**

The range between the min. and max. values depends mainly on the production capacity of the plant, the effective production volume, and the different technologies used. Depending on the gas consumption of a typical lead oxide production plant, the calculated CO<sub>2</sub> emissions per tonne product are given in Table 7.44.

CO <sub>2</sub> emissions	min	38 kg
	max	126 kg

**Table 7.44: CO<sub>2</sub> emissions per tonne lead [96, CEFIC-ELOA, 2004]**

In several cases, electric furnaces are used for the production of lead oxide. The electrical energy demand for the whole plant (furnaces, ventilation, machinery) is in the range of 390 - 420 kWh per tonne lead. These units do not emit CO<sub>2</sub> (compare this with the energy consumption given in Table 7.43 above).

## 7.6.4 Techniques to consider in the determination of BAT

**Introduction: Techniques to consider in the determination of BAT – refer to Section 7.1.4**

### 7.6.4.1 Exhaust gas cleaning from the production of lead oxide

#### Description

The total production process for lead oxides, including lead melter, pre-oxidation, secondary oxidation, pelletisation, grinding/classification, and storage/packaging is a largely closed circuit held under negative pressure (see Figure 7.19 above). Crude oxides, fully oxidised products and finished products are transported via pneumatic conveyors, by screw feeders and by bucket elevators. Modern filter separation units used to separate the powder/product from the carrying air stream, are standard practice.

The filter system consists of a main product filter and can be followed by a second security filter. The second filter can be a single unit connected directly to the product filter or a central large security filter. The main product filter is usually a bag-house type with fabric filter sacks. A common filter bag material used in the production of lead oxide is a polyester needle felt. This type of filter material can operate at temperatures of up to 140 °C. The principle of the fabric filter system used in the lead oxide industry, is shown in Figure 7.20. If required, secondary filters are usually cassette type units (see Figure 7.21). The secondary filter ensures that there are no lead oxide releases to the environment (refer also to Section 7.6.3.1.1 above).

#### Achieved environmental benefits

Application of the main and the secondary filters in the whole lead oxide production process allows for the cleaning of exhaust air and results in the minimisation of lead emissions to the atmosphere.

#### Cross-media effects

No side effects or disadvantages caused by the implementation of this technique have been reported.

#### Operational data

With the above-mentioned filter systems, and depending on the configuration of the filters used, exhaust air from the production of lead oxide is cleaned to values of between 0.7 up to 6 g Pb emitted to air per tonne Pb produced or used.

It has been reported, that with the application of a combination of a bag filter and a secondary cassette filter, very low dust emission figures of about 0.05 mg/Nm<sup>3</sup> are achieved in the lead oxide plant in Austria.

However, according to current experience of the lead oxide industry, when using a layout of a fabric/cloth main filter, followed by a cassette secondary filter or central secondary filter, emissions lower than 0.2 mg/Nm<sup>3</sup> can generally be achieved.

Emission values <0.1 mg/Nm<sup>3</sup> are difficult to measure, and values of 0.05 mg/Nm<sup>3</sup> imply an uneconomic replacement rate for filters and may require a turn-down in the production rate. Moreover, filter suppliers will not guarantee emissions of <0.15 mg/Nm<sup>3</sup> for plants based on current technology.

#### Applicability

This technique is applicable to the plants producing lead oxide.

#### Economics

No data submitted.

#### Driving force for implementation

The protection of the environment and the minimisation of staff contact with lead oxide.

#### Example plants

The lead oxide plant in Austria.

#### Reference literature

[96, CEFIC-ELOA, 2004], [85, EIPPCB, 2004-2005].

Refer also to the BREF on the Waste Water and Waste gas Treatment/Management Systems in the Chemical Sector (CWW).

### **7.6.4.2 Waste water cleaning**

#### Description

Rainwater and water from cleaning operations has to be purified to reduce the Pb concentration. In most cases, the waste water is treated by physico-chemical means. With the support of water additives, e.g. organic polymers, the lead content is reduced by precipitation to below the legal limit of 0.5 mg Pb/l. In accordance with local legal requirements, other enterprises discharge their partly contaminated streams to the municipal waste water treatment plant (see Figure 7.19 above).

#### Achieved environmental benefits

The minimisation of the emissions of lead compounds to the aquatic environment.

#### Cross-media effects

No information submitted.

#### Operational data

The emission factor varies from 0.07 – 0.18 g Pb emitted to water per tonne Pb produced or used. No other data submitted.

### Applicability

This technique is applicable to the plants producing lead oxide.

### Economics

No data submitted.

### Driving force for implementation

The protection of the environment.

### Example plants

No information submitted.

### Reference literature

[96, CEFIC-ELOA, 2004].

## **7.6.4.3 Recycling residues with high Pb content in the lead smelter**

### Description

The main residues from the production of lead oxide and the methods applied for the treatment of solid wastes are described in Section 7.6.3.1.3 above. As the generation of the solid waste containing lead compounds cannot be avoided in the industrial manufacture of lead oxide, the most important from the environment protection point of view, is the recycling of the residues with a high Pb content in the lead smelter (refer to Figure 7.13 above).

### Achieved environmental benefits

The reduction of discharge of the solid waste containing lead compounds.

### Cross-media effects

No information submitted.

### Operational data

Most lead oxide production plants have specific emission factors for inorganic solid wastes of between 2 and 6 kg Pb/t Pb produced or used.

### Applicability

This technique is applicable to the plants producing lead oxide.

### Economics

No data submitted.

### Driving force for implementation

The protection of the environment.

### Example plants

No information submitted.

### Reference literature

[96, CEFIC-ELOA, 2004].

#### 7.6.4.4 Systems available for energy use in the production of lead oxide

##### Description

In most of the plants producing lead oxide, natural gas is used to heat the furnaces, while electrical energy is necessary for ventilation and rotating machinery. The energy consumption of a lead oxide production plant includes both a demand for gas and electricity. The specific energy demand (kWh) per tonne lead is summarised in Table 7.43 above. Depending on the gas consumption of a typical lead oxide production plant, the calculated CO<sub>2</sub> emissions per tonne product are given in Table 7.44 above.

In several cases, electric furnaces are used for the production of lead oxide. The electrical energy demand for the whole plant (furnaces, ventilation, machinery) is then much lower. These units do not emit CO<sub>2</sub> at the lead oxide production site.

##### Achieved environmental benefits

High energy efficiency systems, used in particular in the lead furnaces, result in the reduced impact of the manufacture of lead oxide on the environment.

##### Cross-media effects

The more primary energy used for the production of lead oxide, the higher the levels of the emissions of CO<sub>2</sub> to the atmosphere.

In order to compare the above-mentioned two operational options in more detail, an analysis of the demand for primary fuels (natural gas used directly for the lead furnace vs. coal to produce electricity outside of the PbO plant, which is then used for the lead furnace) needs to be carried out, also taking into consideration the associated emissions of CO<sub>2</sub>, SO<sub>x</sub>, and NO<sub>x</sub> into the atmosphere.

##### Operational data

Depending on the capacity of the plant and the technology used, when natural gas is used for the lead furnace, the total consumption of energy (gas and electricity) in the manufacture of lead oxide varies between 350 – 890 kWh per tonne of lead produced. In turn, when an electric furnace is used, the total consumption of energy (electricity) for the manufacture of lead oxide varies between 390 – 420 kWh per tonne of lead produced.

##### Applicability

This technique is applicable to the plants producing lead oxide based the furnaces being heated by both natural gas and by electrical energy.

##### Economics

No data submitted.

##### Driving force for implementation

High energy efficiency in this process, which decreases the manufacturing cost of lead oxide and reduces the impact from the production of lead oxide on the environment.

##### Example plants

No information submitted.

##### Reference literature

[96, CEFIC-ELOA, 2004].



### 7.6.5 Best Available Techniques for the manufacture of lead oxide

For general information on understanding a BAT section and its contents, see Section 7.1.5.

As described earlier in this section, BAT conclusions drawn here relate to the production of lead oxide, more specifically red lead ( $\text{Pb}_3\text{O}_4$ ) and litharge ( $\text{PbO}$ ), but do not relate to the production of battery oxide ( $\text{Pb}/\text{PbO}$ ). Given several processes and unit operations applied in the production of lead oxide, conclusions primarily focus on these techniques, for which it was possible to justify that they satisfy the environmental objectives and meet the performance targets associated with BAT, as follows.

#### **For the production of lead oxide, BAT is to:**

1. Reduce dust emissions to  $<0.1 - 0.2 \text{ mg}/\text{Nm}^3$  by using a product main filter, followed by a security filter (see Sections 7.6.3.1.1 and 7.6.4.1).
2. Reduce the Pb content in waste waters to  $0.07 - 0.18 \text{ g Pb}$  per tonne of Pb produced by purifying contaminated rainwater and water from cleaning operations, using physico-chemical treatment with the support of water additives allowing for the precipitation and separation of lead compounds from waste waters (see Sections 7.6.3.1.2 and 7.6.4.2).
3. Recycle the residues with a high Pb content in the lead smelter to reduce the solid waste containing lead compounds to  $2 - 6 \text{ kg Pb}$  per tonne of Pb produced (see Sections 7.6.3.1.3 and 7.6.4.3).
4. Depending on the technology used for the manufacture of lead oxide and the capacity of the plant, apply high energy efficiency systems in the lead furnaces to maintain the overall consumption of energy in the range of  $350 - 890 \text{ kWh}$  per tonne of lead produced when natural gas fired furnaces are used, and  $390 - 420 \text{ kWh}$  per tonne of lead produced when electric furnaces are used (see Sections 7.6.3.2 and 7.6.4.4).

## 7.7 Magnesium compounds

### 7.7.1 General information

#### 7.7.1.1 Introduction

Magnesium is the eighth most frequent element in the Earth's crust with a content of 2.1 % and the third most frequent element in seawater, which is an inexhaustible source of magnesium related raw materials. Apart from seawater, other main sources of Mg are in dolomite, magnesite rock, brines and salt deposits. Magnesium has never been found in the elemental form, but usually as the chloride, hydrated oxide, sulphate, silicate or carbonate, either in complex or simple salts [31, R. N. Shreve, 1945]. Industrially, the most important magnesium minerals are magnesium carbonate ( $\text{MgCO}_3$ , magnesite), calcium magnesium carbonate ( $\text{CaCO}_3\cdot\text{MgCO}_3$ , dolomite), magnesium chloride  $\text{MgCl}_2$  and its double salt with potassium chloride ( $\text{KCl}\cdot\text{MgCl}_2\cdot 6\text{H}_2\text{O}$ , carnallite), magnesium sulphate ( $\text{MgSO}_4\cdot\text{H}_2\text{O}$ , kieserite) and magnesium silicates such as asbestos or olivine [48, W. Buchner et al, 1989]. Magnesium compounds are used extensively for the production of metallic magnesium, refractories and insulating compounds, and find applications in the rubber, printing ink, pharmaceutical and toilet industries [31, R. N. Shreve, 1945].

#### **Magnesium chloride**

Produced from seawater, salt lakes, underground brines, residual brines of the potash industry, and  $\text{MgCO}_3$  or  $\text{MgO}$ . The production of  $\text{MgCl}_2$  is closely linked with the manufacture of metallic magnesium. In 1984 approx. 1 million tonnes of magnesium chloride was manufactured in western world, over 80 % of which was used in the electrolytic manufacture of magnesium. The main consumers of Mg metal are the US, Russia and Germany, and the main producers are the US, Russia and Norway. For the information on the production of primary magnesium metal in Europe refer to the BREF on Non Ferrous Metal Industries.

#### **Magnesium carbonate (magnesite)**

It is the most important open-pit mined Mg mineral. About 12 million tonnes of raw magnesite were mined in 1985, with the main mining countries being China, Russia, North Korea, Austria and Greece. Only small amounts of  $\text{MgCO}_3$  are produced by synthesis of Mg salts and  $\text{CO}_2$ . Natural magnesite is almost exclusively utilised for the manufacture of  $\text{MgO}$  (magnesia), by calcination above  $550\text{ }^\circ\text{C}$  into different, mainly refractory, grade magnesia products [48, W. Buchner et al, 1989].

#### **Magnesium oxide (MgO, magnesia)**

It is the most important industrial magnesium compound, finding its main applications in the refractory industry and in steel works. World production of  $\text{MgO}$  amounted to approx. 6.5 million tonnes in 1984. The raw materials for the production of magnesium oxide are either natural magnesium carbonate (magnesite) which is mentioned above, or magnesium chloride or hydroxide from seawater and brines, but this latter route is decreasing in importance because its energy requirements are three times higher than those of the magnesite process. Dolomite can also be utilised as a starting material [48, W. Buchner et al, 1989]. Refer also to the BREF on Cement and Lime Manufacturing Industries (CL).

The different magnesia qualities differ in the type and temperature of the process used to calcine magnesium carbonate or hydroxide. The following are the main MgO types [48, W. Buchner et al, 1989]:

- chemically more reactive (caustic) magnesia, burned at 600–900 °C, used in the manufacture of fertiliser and animal feedstuffs, building materials (Sorel cement, lightweight building panels), chemical and pharmaceutical products, and in water treatment
- dead-burned sintered magnesia, burned at 1600–2000 °C, the most important MgO product used for the refractory industry (lining of metallurgical furnaces, raw materials for refractory bricks) – refer to the BREF on Ceramic Manufacturing Industry (CER)
- fused magnesia, melted at 2800–3000 °C in an electric arc furnace, used for high temperature crucibles and as an insulating material in the electrical heating industry.

Magnesium oxide finds most of its applications in the production of refractory materials (the BREF on CER), with other uses in agriculture and in the building industry [6, CEFIC, 2002].

Two major production processes are used:

- starting from magnesium chloride, by a high temperature hydrolysis reaction. Magnesium chloride brine may be obtained from, e.g. seawater
- starting from magnesium hydroxide, by a high temperature dehydration reaction. Magnesium hydroxide itself may be obtained from the treatment of seawater or ores.

Besides dust and flue-gas, the emissions to air may include some hydrochloric acid. The emissions to water are normally of secondary importance. Waste production is not predictable, as long as feedstock as different as ores or seawater can be used.

The remainder of this section covers the magnesium compounds, produced by the wet process route, including: magnesium chloride ( $\text{MgCl}_2$ ), magnesium oxide ( $\text{MgO}$ ) and magnesium hydroxide  $\text{Mg}(\text{OH})_2$ . Calcium chloride ( $\text{CaCl}_2$ ) is included, because it is produced as a by-product.

There is a link with the BREF on Cement and Lime Manufacturing Industries (CL) due to the use of calcium magnesium lime (dolime) as raw material in the production of magnesium hydroxide and in the production of a high purity grade dead-burned dolomite, used for the manufacture of refractories (see also the BREF on CER).

There is a link with potash or potassium production because magnesium chloride can be produced in large quantities from the end brines of the potash industry. There is also a link with the manufacturing of titanium because magnesium chloride is produced as a by-product.

### 7.7.1.2 Background information on magnesium compounds

Magnesium chloride,  $\text{MgCl}_2$ , is one of the primary constituents of seawater and occurs in most natural brines and salt deposits formed from the evaporation of seawater. Anhydrous magnesium chloride is used mainly as a raw material in the production of magnesium metal. Another important use is as animal feed supplements and in the preparation of oxychloride cements. Magnesium chloride is one of the most commercially important magnesium compounds [56, InfoMil, 2004].

Magnesium oxide,  $\text{MgO}$ , also known as magnesia, occurs in nature most commonly as groups of crystals in marble. The principal commercial forms of magnesia are dead-burned magnesia (DBM), caustic-calcined magnesia (light burned magnesia), hard-burned magnesia, and calcined magnesite. Dead-burned magnesia is used extensively for refractory applications in the form of basic granular refractories and brick (refer to the BREF on CER).

Magnesium hydroxide,  $\text{Mg}(\text{OH})_2$ , occurs naturally as the mineral brucite. The principal use of magnesium hydroxide is in the pulp and paper industries. The main captive use is in the production of magnesium oxide, chloride, and sulphate [56, InfoMil, 2004].

Calcium chloride,  $\text{CaCl}_2$ , is a white, crystalline salt that is very soluble in water. Solutions containing 30 – 45 wt-%  $\text{CaCl}_2$  are used commercially. It is extremely hygroscopic and liberates large amounts of heat during water absorption and on dissolution. Calcium chloride is used for de-icing, in oilfields and finds many other applications.

The world production of dead-burned magnesia was more than 9 million tonnes in the year 2000, and the world production of caustic calcined magnesia was 1.3 million tonnes. There are four raw materials used as a Mg source for the production of magnesium oxide: magnesite ( $\text{MgCO}_3$ ), dolomite ( $\text{MgCO}_3 \cdot \text{CaCO}_3$ ), seawater and solution mined  $\text{MgCl}_2$  brines [56, InfoMil, 2004].

As given in Table 7.45, a variety of production facilities in Europe produce magnesia ( $\text{MgO}$ ).

Country	Number of producers	Raw material*	Capacity (in kt MgO/year)	
			Caustic calcined	DBM
Austria	2	M	35	250
France	1	S	30	
Greece	1	M	120	80
Ireland	1	S		90
Israel	1	S	10	60
Italy	3	M+S/B	30	130
Netherlands	1	D+B	5	150
Norway	1	S	25	
Poland	1	M		10
Russia	2	M	10	2670
Serbia and Montenegro	1	M	40	200
Slovakia	2	M		440
Spain	2	M	155	60
Turkey	4	M	50	310
Ukraine	2	M+S/B	20	200
United Kingdom	1	S/B	70	80
<b>Total Europe</b>	<b>26</b>		<b>600</b>	<b>4730</b>

\* Raw material M=magnesite, S=seawater, B=brine, S/B=seawater or brine, D=dolomite  
 Note: In the EU-25, the wet process to produce dead burned magnesia (DBM) is currently used only in Ireland and the Netherlands, while DBM plants in Italy and United Kingdom based on the wet process are closed.

**Table 7.45: European facilities for the production of different grades of magnesium oxide [56, InfoMil, 2004]**

Production of dead-burned magnesia (DBM) and caustic calcined magnesia in the rest of the world, in the year 2000 is given in Table 7.46.

Country	Number of producers	Raw material*	Capacity (kt MgO/year)	
			Caustic calcined	DBM
Australia	2	M	50	120
Brazil	2	M	60	275
China	12	M	200	2485
India	9	M	25	260
Japan	2	S/B	65	265
Korea (N+S)	2	M+S/B		550
United States	3	M+S/B	210	265
<b>Total rest of the world</b>	<b>32</b>		<b>610</b>	<b>4220</b>

\* Raw material M=magnesite, S=seawater, B=brine, S/B=seawater or brine  
 Note: Outside of Europe, the wet process to produce dead-burned magnesia is used only in Japan and the US.

**Table 7.46: Production of magnesia for the year 2000 in the rest of the world [56, InfoMil, 2004]**

The magnesia plant in Veendam, the Netherlands (an example plant for the wet process applied in the EU) produces synthetic dead-burned magnesia (DBM), caustic calcined magnesia, magnesium chloride, magnesium hydroxide and calcium chloride. The raw materials used are MgCl<sub>2</sub> brine and dolomite, which are very pure.

The production capacity of the magnesia plant in the Netherlands in 2002 is given in Table 7.47.

MgO (DBM+caustic)	155
MgCl <sub>2</sub> (100 %)	30
Mg(OH) <sub>2</sub> (100 %)	3
CaCl <sub>2</sub> (x10 <sup>3</sup> m <sup>3</sup> /year) (100 %)	31

**Table 7.47: Production capacity (kt/year) of the magnesia plant in the Netherlands in 2002 [56, InfoMil, 2004]**

It should be noted, however, that for the total capacity of dead burned magnesia (DBM) in the EU, amounting to 1080 kt/year, the wet process route – covered in this document – is currently applied only in two Member States (the Netherlands: 150 kt/year, and Ireland: 90 kt/year), and covers approximately 22 % of the total EU DBM capacity.

In turn, the dry process route to produce dead-burned magnesia (DBM) is currently used in Austria, Greece, Poland, Slovakia and Spain, and covers approximately 78 % of the total EU DBM capacity [85, EIPPCB, 2004-2005].

Whilst the wet process route used by the Dutch plant in Veendam, starting from pure raw materials, i.e. MgCl<sub>2</sub> brine and dolomite (CaOMgO), is fully addressed in this document, the dry process route for the production of dead-burned magnesia (MgO), starting from mined natural magnesite (MgCO<sub>3</sub>), is not covered in this document – refer to the revision of the BREF on Cement and Lime (CL).

This is mainly because the dry process route to dead burned magnesia, which is applied by the majority of the EU manufacturers, has its main linkages within the mineral industry sector, outside of the boundaries of the chemical industry sector [85, EIPPCB, 2004-2005].

Therefore, it should be also stressed that the BAT conclusions on magnesium compounds drawn in this document, based on data and information relevant to the wet process route, cannot be considered illustrative for the dry process route.

## 7.7.2 Industrial processes used

As stated above the wet process described in this section is that of the magnesia plant in Veendam, in the Netherlands. This plant produces dead-burned magnesia as an end-product from two raw materials, calcium magnesium lime (dolime) and magnesium chloride brine. The dolime is imported, while the company mines the magnesium chloride itself.

Figure 7.22 schematically shows the overall diagram of the production processes applied in the magnesia plant in Veendam, the Netherlands. The diagram is split into three areas: mining, wet sections and dry sections.

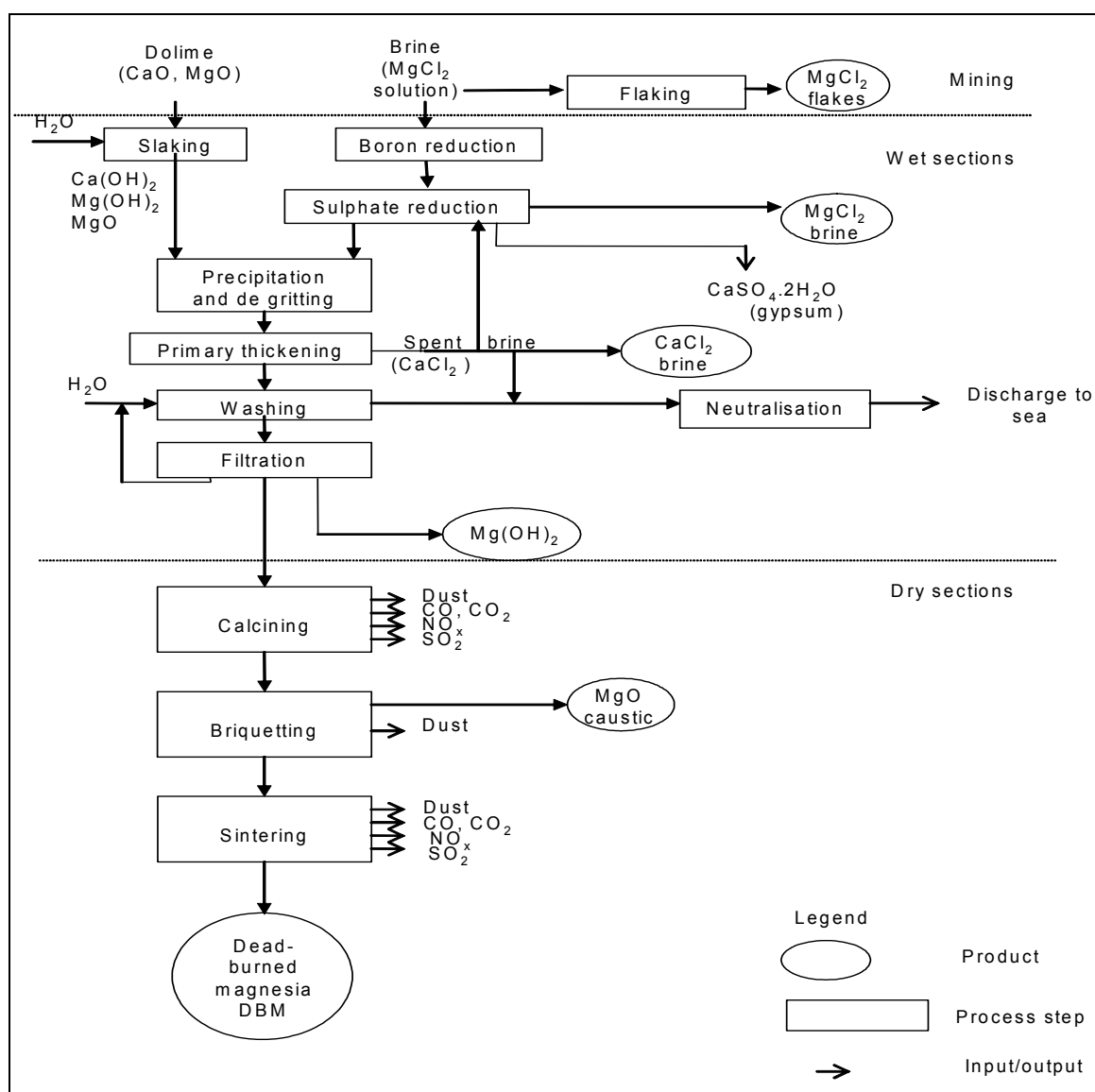


Figure 7.22: Flow diagram of the production of magnesium oxide (DBM) in the Netherlands [56, InfoMil, 2004]

### 7.7.2.1 Solution mining

Solution mining (denoted in the diagram as mining) is the easiest way to extract salts from the deep underground. Solution mining is achieved by applying mostly oil and gas drilling techniques to reach hole depths of hundreds to thousands of metres. Water injection results in salt dissolution. To achieve this, two tubes are placed in a casing.

Through one tube the water is pumped downwards, while the dissolved brine is pressed to the surface in the other (refer also to Chapter 2 – soda ash, applying such techniques to the solution mining of salt brine). Solution mining in salt creates caverns, which after depletion of the salt deposit, is sometimes used as storage containers (e.g. for oil or gas).

### 7.7.2.2 Magnesium chloride production (solid)

Magnesium chloride is also produced in a solid form, the process is called flaking. Condensation water of the evaporation process preheats the 34 wt-% magnesium chloride brine to approximately 95 °C. The water evaporates from the brine by boiling at a temperature of 170 °C to get a saturated solution of 47 wt-%. This hot concentrated liquid is then transported to a water cooled rotating drum, where solid magnesium chloride (bischofite,  $\text{MgCl}_2 \cdot 6 \text{H}_2\text{O}$ ) flakes are formed by crystallisation. The energy supply for the evaporator comes from thermic oil of 240 °C by means of heat exchange. The thermic oil is heated by three natural gas fired furnaces.

### 7.7.2.3 Production of DBM and other Mg compounds (wet sections)

#### 7.7.2.3.1 Boron/sulphate reduction

Crude magnesium chloride brine for the production of MgO is treated in an ion exchanger for boron removal. Hydrochloric acid regenerates the boron selective resin. Spent hydrochloric acid is gathered and used for neutralising the effluent.

To reduce the sulphate in the magnesium chloride brine, calcium chloride brine is subsequently used. A vacuum belt filter thickens and dewateres the gypsum precipitate ( $\text{CaSO}_4 \cdot 2\text{H}_2\text{O}$ ) formed. The overflow from the thickener is purified brine ready for use in the magnesium hydroxide precipitation stage. The gypsum precipitate is transported to the mining location and pumped into the caverns.

The chemical reaction of brine desulphurisation is:



Boron is reduced in order to improve the chemical purity of the magnesium hydroxide and the refractoriness of sintered magnesium oxide respectively. The sulphate content in the raw magnesium chloride brine must be decreased to reduce  $\text{SO}_2$  emissions from sintering at a later process stage. High sintering temperatures can even cause emissions of elementary sulphur when present.

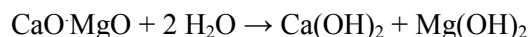
#### 7.7.2.3.2 Purification

Some applications require additional purification of the magnesium chloride brine. Filtration removes undissolved iron. Further purification is achieved by oxidation of the dissolved iron into Fe(III) precipitate followed by membrane filtration.

### 7.7.2.3.3 Slaking of dolomite

The other raw material, solid dolime (calcium oxide/magnesium oxide) has to be slaked before it can be used in the process.

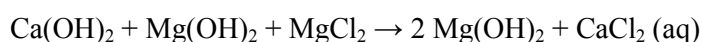
During slaking, the calcium oxide component hydrates completely while only part of the magnesium oxide hydrates. The chemical reaction is:



For dolomite mining see the BREF on the Cement and Lime Manufacturing Industries (CL).

### 7.7.2.3.4 Magnesium hydroxide precipitation

The slaked dolime is mixed with the pretreated magnesium chloride brine ( $\text{MgCl}_2$ ). The net chemical reaction is:



During the washing process, magnesium oxide hydrates further to form magnesium hydroxide. The magnesium hydroxide precipitate is washed, filtered and fed into the calciners. The calcium chloride is partly re-used for brine desulphurisation. The other part is used for the production of concentrated and prilled calcium chloride.

### 7.7.2.3.5 Washing and thickening

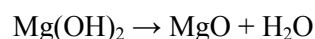
The slurry containing magnesium hydroxide solids and dissolved calcium chloride, is washed countercurrently to remove all chlorides. During this process a flocculant is added to improve the settling and compaction behaviour of the magnesium hydroxide suspension. In three vacuum rotary drum filters, the magnesium suspension is dewatered to form a filter cake with approximately 54 wt-% solids. The spent brine is partly recycled to the desulphation step, while the other part together with wash-water is the effluent, which is neutralised to prevent it from silting up.

## 7.7.2.4 Dry sections applied in the production of magnesium compounds

Dry processes applied in the production of magnesium compounds include: calcining, briquetting, and sintering.

### 7.7.2.4.1 Calcining

A part of the magnesium hydroxide filter cake is directly fed into the top of the multistage Herreshoff furnace. The material dries further and calcines to form caustic magnesium oxide. The other part of the filter cake is fed to the pre-dryer. There to it is mixed with the already dried  $\text{Mg}(\text{OH})_2$  and is dosed with the hot off-gases to the pre-dryer. This pre-dried magnesium hydroxide filter cake is fed halfway into the calcining furnace. This calcination process is carried out at controlled temperatures of up to 1100 °C, using natural gas/air burners. The chemical reaction of calcining is:



The caustic powder produced is transported to the briquetting section or sold as caustic MgO powder.



### 7.7.2.4.2 Briquetting

In two stages, the caustic magnesium oxide powder is compacted into almond shaped briquettes. During pre-compression, caustic MgO mixes with sieved material from the second step. This pre-compressed material is further compressed in the second step. Subsequently these so called 'green' briquettes are sieved. The fine material is returned to the pre-compression step, while the coarse fraction is fed into the shaft kilns for sintering or supplied to the market and sold as it is.

### 7.7.2.4.3 Sintering

The green briquettes are sintered (dead-burned) in a shaft kiln with an oval shaped cross-section. The shaft kiln is gas-fired. A mixture of natural gas and primary air is burned with preheated secondary air. The green briquettes are fed continuously to the shaft kiln. The briquettes sag slowly in the kiln during which they are compressed because of the high temperature. In the bottom section of the kiln, the hot briquettes are cooled by secondary air. This preheated secondary air is responsible for the complete combustion of the natural gas. The residence time in the shaft kiln is controlled by a drag bar, which is a moving beam on a table, that removes the product from the kiln. A temperature of up to 2200 °C is reached, to produce dense high purity dead-burned magnesia. After leaving the shaft kiln, the product is cooled and stored in bunkers. The hot off-gases from the product cooler are dedusted and are mixed with the off-gases from the kiln.

## 7.7.3 Present consumption and emission levels

The main environmental issues associated with the production of magnesium compounds are air pollutants, the use of water and energy and waste production.

### 7.7.3.1 Use of raw material and energy consumption

For the production of one tonne of dead-burned magnesia 1.2 tonnes of dolime as well as 1.2 tonnes of MgCl<sub>2</sub> brine is needed. Energy used for mining is mainly for compressing and pumping. The main energy consumption for the production of magnesium compounds is for the calcining and sintering processes. The energy intake is both electricity and natural gas. The overall energy use for the production of magnesium oxide is about 11.5 GJ/tonne MgO [56, InfoMil, 2004].

### 7.7.3.2 Emissions to air

The emissions to air are mainly off-gases from calcining and sintering containing NO<sub>x</sub>, CO, CO<sub>2</sub>, SO<sub>2</sub> and magnesia containing dust (MgO). Also small amounts of chlorides and fluorides are emitted due to the decomposition of salts caused by the high sintering temperature.

The emissions to air from flaking are relatively small compared to calcining and sintering. The NO<sub>x</sub> emissions are approx. 1 to 2 tonnes per year, while the concentration is approx. 70 mg/Nm<sup>3</sup>. The emission CO<sub>2</sub> conforms to the use of natural gas between 3.5 to 4 kt/year. The evaporated acid (HCl) vapour is condensed, neutralised with caustic soda and used as injection water for mining.

**7.7.3.2.1 Dust**

The total dust emission of the magnesia plant in the Netherlands is about 0.3 kg dust/tonne of magnesia (as MgO) produced [56, InfoMil, 2004]. The overall mean dust concentration is 35 mg/Nm<sup>3</sup>, mainly due to the new ESPs (electrostatic precipitator).

The main sources of dust emissions are the off-gas emissions from calcining and sintering. At the briquetting section, air is collected to prevent MgO dust emissions. The filtered air is emitted separately from the chimney stack. The dolime intake and the loading of the end DBM product result in minor dust emissions compared with the off-gases. The air here is also collected from the belt conveyor as well as the loading equipment to prevent dust emissions. After dust filtering, this air is released at roof level to the atmosphere.

**7.7.3.2.2 NO<sub>x</sub>, CO and CO<sub>2</sub>**

Due to the combustion processes of natural gas and air, in both calcining and sintering, there are emissions of nitrogen oxides as well as carbon oxides. The carbon content of natural gas, about 2 kg CO<sub>2</sub>/Nm<sup>3</sup> also contributes to the CO<sub>2</sub> emissions.

**7.7.3.2.3 SO<sub>2</sub>, Cl<sup>-</sup> and F<sup>-</sup>**

Because of the high sintering temperature, even salts of remaining chlorides, sulphates and fluorides evaporate or decompose to volatile constituents. A part of these volatile constituents condenses in the top of the shaft kiln or in the off-gas channel before the scrubber.

**7.7.3.2.4 Calcining and sintering**

The indicative emissions from the magnesia plant in the Netherlands in the year 2002 from the calcining furnaces and the sintering kilns are given separately, because they each emit through a separate chimney stack [56, InfoMil, 2004], [85, EIPPCB, 2004-2005].

Calcining furnaces off-gas emissions (kg/tonne MgO production):

- SO<sub>2</sub>            n.a. (not available)
- CO                2 – 9
- NO<sub>x</sub>            0.1 – 0.4

Sintering kilns off-gas emissions (kg/tonne MgO production):

- SO<sub>2</sub>            0.6
- CO                1.5 – 5.5
- NO<sub>x</sub>            2.0 – 4.0

The total indicative NO<sub>x</sub> emission for calcining and sintering is 2.1 – 4.4 kg NO<sub>x</sub> (as NO<sub>2</sub>)/t MgO, however, according to the Performance Standard Rate (PSR 2005), the process emission of NO<sub>x</sub> is at a higher level of 5.2 kg NO<sub>2</sub>/tonne MgO produced [85, EIPPCB, 2004-2005].

The total indicative CO emission for calcining and sintering is 3.5 – 14.5 kg CO/t MgO.

The total indicative CO<sub>2</sub> emission for calcining and sintering is: 570 kg/tonne MgO.

### 7.7.3.3 Emissions to water

Almost 3 million m<sup>3</sup> of waste water (see below) is discharged yearly by a pipeline to the surface water in the Ems-Dollard estuary in the Netherlands. Most of it is spent calcium chloride brine from the magnesium hydroxide thickener.

The other streams are from the purification of magnesium chloride, from the boron/sulphate reduction and spent wash-water from the magnesium hydroxide washing process. The effluent is analysed on Mg<sup>2+</sup>, Ca<sup>2+</sup>, K<sup>+</sup>, Na<sup>+</sup>, Cl<sup>-</sup>, SO<sub>4</sub><sup>2-</sup>, B<sup>3+</sup> and chromium and zinc. These substances come from the raw materials used, dolime (Cr and Zn) and magnesium chloride brine (the other elements). The suspended solids content is normally below 0.01 kg/m<sup>3</sup>.

The mean concentrations and mean yearly load based on the average concentration and flow in the magnesia plant in the Netherlands for 2002 are given in Table 7.48.

	Mg <sup>2+</sup>	Ca <sup>2+</sup>	K <sup>+</sup>	Na <sup>+</sup>	Cl <sup>-</sup>	SO <sub>4</sub> <sup>2-</sup>	B <sup>3+</sup>	Cr	Zn
Conc. mg/l							2.5	0.064	0.032
Load kg/yr								213.5	105.5
Conc. g/l	0.33	21.11	0.54	2.21	41.99	0.35			
Load tonne/yr	1099	70285	1785	7359	139807	1163	8.6		

Note: In 2002 the magnesia plant in the Netherlands discharged 3329400 m<sup>3</sup>/yr of which 340000 m<sup>3</sup> was from a neighbouring company. Given the load of waste waters from MgO production of about 3 million m<sup>3</sup>/year and a MgO plant with a capacity of 155 kt/year (see Section 7.7.1.2 above), a specific load of waste waters discharged per 1 tonne of the product is ~20 m<sup>3</sup>/t MgO.

**Table 7.48: Emissions to water – mean concentrations and mean yearly load (the Netherlands) [56, InfoMil, 2004]**

### 7.7.3.4 Solid wastes

Gypsum from desulphation (3200 tonnes per year) is disposed of in the MgCl<sub>2</sub> caverns. There is a relatively small amount of dangerous waste from mining and from magnesium compounds production, 7.8 tonnes in 2002. The spent scrubber liquid is thickened and then centrifuged to get solid material, which is stored in big bags. In spite of the fluoride (F) concentration (present in the dolime), it can be disposed of as waste. The management of the Dutch magnesia plant in Veendam is studying other applications for treating about 700 tonnes/year stream. The amount of non-dangerous waste mainly consists of 10.3 tonnes of dolime waste. The other product streams are internally re-used or sold as by-products, see Figure 7.22.

## 7.7.4 Techniques to consider in the determination of BAT

**Introduction: Techniques to consider in the determination of BAT – refer to Section 7.1.4**

### 7.7.4.1 Abatement techniques for the emissions of dust

#### Description

Abatement techniques for calcining, briquetting and sintering are described below.

#### Calcining

The hot off-gas from the calcining furnace, including MgO dust, is used in the magnesium hydroxide pre-dryer to evaporate the water from the filter cake. After the pre-dryer, a cyclone separates the solid dust particles from the off-gases, which are sent back to the calcining furnace. Subsequently, the fine dust is caught in an electrostatic precipitator (ESP). The cleaned off-gas is released to the atmosphere by the chimney stack. The separated dust is transported to the bag filter and fed back halfway into the calcining furnace. The electrostatic precipitators were replaced by new ones, and hence they now remove about 99 % of the dust from the off-gases of the calcining furnace.

### **Briquetting**

In several places of the briquetting section, air is collected to prevent dust from being released into the production area. This exhaust air is cleaned by a bag filter. The separated dust is returned to the briquetting section while the cleaned air is emitted separately from the chimney stack.

### **Sintering**

The combustion gases leave the shaft oven at the top by the off-gas channel. The hot off-gases are treated in three steps. First, the larger dust particles are separated in a drop-out box. Subsequently, a cyclone separates the smaller particles. This so-called 'shaft kiln dust' can either be fed back to the process or gathered and sold. The next cleaning step uses a venturi scrubber which, along with HCl and SO<sub>2</sub>, also removes volatile substances and dust. To effectuate this, water is injected into the venturi scrubber, followed by spraying gases with recirculating scrubber liquid. The treated off-gas saturated with water vapour is led through a demister and mixed with the hot air of the product cooler. The combined stream is released to the atmosphere through the chimney stack of the shaft kilns.

#### Achieved environmental benefits

Abatement techniques used for the emission of dust in the production of magnesium compounds allow for the reduction of MgO dust released to the atmosphere.

#### Cross-media effects

No side effects or disadvantages are caused by the implementation of this technique.

#### Operational data

In the calcination section, a monthly average dust concentration of <35 mg/Nm<sup>3</sup> is reached. In the sintering section, dust emissions are reduced to about 115 mg/Nm<sup>3</sup>. Further investigations to reduce SO<sub>2</sub> emission are also focused on decreasing dust emissions to the level of about 50 mg/Nm<sup>3</sup>.

#### Applicability

Applicable to the plants producing dead-burned magnesia.

#### Economics

No data submitted.

#### Driving force for implementation

The protection of the environment.

#### Example plants

The dead-burned magnesia plant in Veendam, the Netherlands.

#### Reference literature

[56, InfoMil, 2004].

### **7.7.4.2 Abatement techniques for the emissions of SO<sub>2</sub> from sintering**

#### Description

As described in Section 7.7.4.1 above, the third cleaning step uses a venturi scrubber which, along with HCl and SO<sub>2</sub>, also removes volatile substances and dust. To effectuate this, water is injected into the venturi scrubber, followed by spraying gases with recirculating scrubber liquid. The treated off-gas saturated with water vapour is led through a demister and mixed with the hot air of the product cooler. The combined stream is released to the atmosphere through the chimney stack of the shaft kilns.

#### Achieved environmental benefits

Reduction of SO<sub>2</sub> emissions to the atmosphere.

### Cross-media effects

No side effects or disadvantages are caused by the implementation of this technique.

### Operational data

In the venturi scrubbers after the sintering shaft kilns, SO<sub>2</sub> is also removed, but only 20 %. Investigations are being carried as to whether or not it is technically and economically feasible to reduce SO<sub>2</sub> to <200 mg/Nm<sup>3</sup>.

### Applicability

Applicable to the plants producing dead-burned magnesia.

### Economics

No data submitted.

### Driving force for implementation

The protection of the environment.

### Example plants

The dead-burned magnesia plant in Veendam, the Netherlands.

### Reference literature

[56, InfoMil, 2004].

## 7.7.4.3 Abatement techniques for the emissions of NO<sub>x</sub> and CO

### Description

Abatement techniques for flaking, calcining and sintering are described below.

#### **Flaking**

The NO<sub>x</sub> emissions from flaking have been reduced by replacing one burner by a low NO<sub>x</sub> burner for the gas burned furnace.

#### **Calcining**

For the calcining ovens, burner regulation is standard procedure. The CO emission of the calciners is high due to non-optimal burning conditions. With new equipment, regulating the air/gas ratio by flow, the burning efficiency is going to be increased and the CO emission will be lower [56, InfoMil, 2004].

#### **Sintering**

From an evaluation study in the late 1990s, it appeared that SCR (selective catalytic reduction) used as the deNO<sub>x</sub> technique for the combustion gases from the sintering kilns is very uncertain technically as well as economically. This is mainly due to the uncertainty in the life-time of the catalyst and the strong pollutive nature of the off-gases [56, InfoMil, 2004]. The emissions of NO<sub>x</sub> and CO from the shaft kilns for sintering have, therefore, been reduced by process-integrated measures. The quantity of secondary excess air is reduced to achieve stoichiometric burning conditions. Secondary excess air is used for cooling the hot product from the kiln. Therefore, the decrease of temperature must be compensated with extra water injection. The accompanying CO emission can be decreased by changing the depth of the burners [56, InfoMil, 2004].

### Achieved environmental benefits

Substantial reduction of NO<sub>x</sub> and CO emissions to the atmosphere.

### Cross-media effects

No information submitted.

Operational data

In the sintering section, the CO emission is in the range of 1.5 – 5.5 kg/tonne MgO produced and the NO<sub>x</sub> emission is in the range of 2 – 4 kg/tonne MgO produced. See Section 7.7.3.2.4.

The total indicative NO<sub>x</sub> emission for calcining and sintering is 2.1 – 4.4 kg NO<sub>x</sub> (as NO<sub>2</sub>)/t MgO. The total indicative CO emission for calcining and sintering is 3.5 – 14.5 kg CO/t MgO.

Applicability

Applicable to the plants producing dead-burned magnesia.

Economics

No data submitted.

Driving force for implementation

The protection of the environment.

Example plants

The dead-burned magnesia plant in Veendam, the Netherlands.

Reference literature

[56, InfoMil, 2004].

### 7.7.5 Best Available Techniques for the manufacture of magnesium compounds

For general information on understanding a BAT Section and its contents, see Section 7.1.5.

BAT conclusions concerning magnesium compounds relate, in principle, to the production of dead-burned magnesia (MgO) starting from MgCl<sub>2</sub> brine and dolomite, and are divided into three groups: joint conclusions on the wet and dry process, and then conclusions relating to the wet stage process, followed by conclusions on the dry process, as follows.

#### **For the wet and dry stage sections applied in the production of dead-burned magnesia (MgO), starting from MgCl<sub>2</sub> brine and dolomite, BAT is to:**

1. Maintain the consumption of raw materials and energy at the levels of:
  - 1.2 tonnes of MgCl<sub>2</sub> brine per tonne of DBM (MgO) produced
  - 1.2 tonnes of dolime per tonne of DBM (MgO) produced
  - 11.5 GJ of energy per tonne of DBM (MgO) produced

by optimising the process of dead-burned magnesia – see Section 7.7.3.1.

#### **For the wet stage sections applied in the production of dead-burned magnesia, starting from MgCl<sub>2</sub> brine and dolomite, BAT is to:**

1. Maintain the overall volume of waste water discharged from the wet stage process at a level below 20 m<sup>3</sup> of waste water per tonne of MgO produced, with the content of chlorides below 42 g Cl<sup>-</sup> per litre of waste water, among others by checking the purity of raw materials (MgCl<sub>2</sub> brine and dolime) and the concentration of the raw MgCl<sub>2</sub> brine used in the process (see Sections 7.7.1.2 and 7.7.3.3).
2. Reduce solid waste by controlling the process of desulphating the MgCl<sub>2</sub> brine and disposing gypsum (CaSO<sub>4</sub>·2H<sub>2</sub>O) in the caverns of raw MgCl<sub>2</sub> brines (see Section 7.7.3.4).

**For the dry stage sections applied in the production of dead-burned magnesia, starting from MgCl<sub>2</sub> brine and dolomite, BAT is to:**

1. Reduce dust emissions to air to below 0.3 kg dust per tonne of dead-burned magnesia (as MgO) produced, equivalent to <math><35\text{ mg/Nm}^3</math>, by using a combination of dust abatement techniques, such as a cyclone and an electrostatic precipitator (in the calcining step), a bag filter (in the briquetting step), and a drop-out box, followed by a cyclone and a wet venturi scrubber (in the sintering step) – see Sections 7.7.3.2.1 and 7.7.4.1.
2. Reduce SO<sub>2</sub> emissions from the sintering kilns section to below 0.6 kg SO<sub>2</sub> per tonne of dead-burned magnesia (as MgO) produced by using a venturi scrubber, which also allows the removal of HCl volatile substances and dust (see Sections 7.7.3.2.4 and 7.7.4.2).
3. Reduce emissions of NO<sub>x</sub> and CO, respectively to 2.1 – 4.4 kg NO<sub>x</sub> (as NO<sub>2</sub>) and 3.5 - 14.5 kg CO per tonne of MgO produced, by using process-integrated measures (see Sections 7.7.3.2.4 and 7.7.4.3), including the application of:
  - a low NO<sub>x</sub> burner for the gas burned furnace in the flaking section
  - a burner regulation, with an adjustment of the air/gas ratio by flow in the calcining section
  - a reduction in the quantity of secondary excess air to optimise burning conditions and changing the depth of the burners in the sintering section.

## 7.8 Sodium silicate

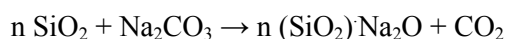
### 7.8.1 General Information

#### 7.8.1.1 Introduction

Sodium silicates are either used as a solid (water glass solid) or as a solution in water (water glass solution). They are characterised by a molar ratio  $\text{SiO}_2:\text{Na}_2\text{O}$  in the range of 1:4. Sodium silicates with low molar ratios (e.g. 1) are used as a solution in detergents (e.g. dishwashing); sodium silicates with intermediate ratios (e.g. 2) are used as feedstock for zeolites, while sodium silicates with higher ratios (above e.g. 2.5) find application in the production of amorphous synthetic silica [6, CEFIC, 2002].

A whole series of derivatives are produced in a reaction between soda ash ( $\text{Na}_2\text{CO}_3$ ) and silica ( $\text{SiO}_2$ ) by varying the ratio of soda ash to silica.

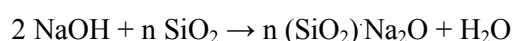
When solid sodium silicate is sought, the process used has large similarities with the production of glass (see BREF on Glass Manufacturing Industry), and it involves the high temperature reaction of selected sand and soda ash at more than 1100 °C as per the following reaction which yields molten water glass:



The reactor furnace operates continuously or by batch. The feedstock mixture is fed into a liquid pool of molten water glass maintained typically at 1100 °C by gas/oil burners. The molten water glass overflows and is cooled/solidified on a belt cooler, but it may also be dissolved in water to yield a water glass solution, which is further clarified by filtration and then shipped.

Air emissions include the flue-gas from the reaction kiln;  $\text{NO}_x$  and dust emissions are important issues. Also dust from feedstock handling (sand, soda ash) needs to be considered. The process does not generate significant amounts of waste water and solid waste, however, the consumption of (fuel oil or natural gas) is important [6, CEFIC, 2002].

Some processes operate in the aqueous phase, using selected sand and sodium hydroxide, and they then lead directly to sodium silicate in solution:



Silicate solutions are processed further with mineral acids to manufacture different kinds of amorphous silicas, including precipitated silica and silica gel (refer to Chapter 5 on synthetic amorphous silica).

#### 7.8.1.2 Basic data on the glass manufacturing industry in the EU-15

The BREF on the Glass Manufacturing Industry, which also covers the 'special glass' sector, contains information on the producers, capacities and techniques used in the production of sodium silicate (solid water glass) in the European Union (EU-15).

Production of solid water glass in the European Union (EU-15) in 1997 was recorded at 560000 tonnes, with capacities estimated at 600000 tonnes per year. Solid water glass is produced in Germany, the UK, the Netherlands, France, Finland, Portugal and Spain. The capacities of sodium silicate furnaces range from below 40 up to 350 tonnes per day and are mainly cross-fired regenerative or recuperative tank furnaces, although other furnace configurations are in use in Europe.



In the case of a molar ratio between 2 – 2.5, water glasses are directly produced by melting sand and sodium hydroxide under pressure (the hydrothermal procedure). Approximately 20 – 30 % of water glass in the EU-15 is produced using the hydrothermal process, which involves the direct dissolution of sand in sodium hydroxide to produce a crystal silicate solution in one step. The reaction takes place in autoclaves, specially designed to withstand the aggressive conditions. After filtration, the product is obtained as a sodium silicate solution of 48 % solid and a weight ratio (WR) of 2.0 – see also Figure 7.23 and Section 7.8.3.6 below.

Finally, it should be also noted that potassium silicate can be produced in the reaction with sand via either the furnace or hydrothermal process by replacing the sodium salt (carbonate or hydroxide) with the equivalent potassium salt.

### 7.8.1.3 Sodium silicate uses and producers in Europe

Sodium silicates are mostly used for the production of detergents. Moreover, they are used in large volumes as a basic product for the manufacture of silicic acid, as additives for rubbers and plastics, and as cracking catalysts for the petrochemical industry. They are also used for the synthesis of zeolites, kieselgels and brines, for glues, as binding agents for aqueous painting colours, for ore flotation, in the ceramic, cement and foundry industries, as flocculants for water treatment, as well as for the chemical solidification of soils.

The required production volumes will probably increase importantly over the next few years, because the tyre production demands greater quantities of sodium silicate. The use of sodium silicate for tyre production reduces the roll resistance friction by 5 %, which leads to cars and trucks needing less fuel.

Potassium water glass solutions are mostly used for the production of covers for welding electrodes, as binding agents for fluorescent material in picture tubes, for the impregnation of bricks and walls, and as binding agents for scours. Another important application field is in paper recycling. In the ‘de-inking’ process, liquid water glass is used for stabilising the pH values.

Based on the submitted data [43, UBA - Germany, 2001], German suppliers of sodium silicates are given in Table 7.49 below as example producers for Europe.

Sodium silicate plants in Germany	Product category	Plant capacity
Wurzen	Solid glass/solution	Capacity in Germany approx. 350000 tonnes per year (solid glass as SiO <sub>2</sub> )
Düsseldorf	Solid glass/solution	
Ludwigshafen	Solid glass/solution	

**Table 7.49: Locations of sodium silicate plants and capacities in Germany [43, UBA - Germany, 2001]**

This capacity refers to the production volume of solid glass. One part is sold directly in a solid state, and one part as liquid glass after being dissolved. Some of the smaller suppliers of liquid glass do not manufacture any solid glass because of economic considerations, but they buy the solid glass from abroad. For the evaluation of environmental effects, the specific conditions at the production site have to be considered, therefore, those suppliers of solutions, are not relevant under German environmental aspects and consequently do not figure in Table 7.49.

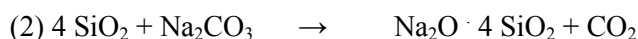
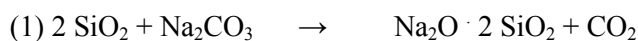
Compared to 2001 data from Germany, it is noted that the total production of alkaline silicates in Western Europe in 1995 was recorded at 757000 tonnes, of that 704000 tonnes in 13 CEES (European silicate producers) member production plants, including 260000 tonnes of 3.3 WR (weight ratio) furnace lumps, 300000 tonnes of 3.3 WR furnace liquor, 91000 tonnes of 2.0 WR hydrothermal liquor, 15000 tonnes of 2.0 WR spray powder, and 38000 tonnes of metasilicate pentahydrate [116, M. Fawer, 1996] – see also Figure 7.23 below.

## 7.8.2 Applied processes and techniques

The chemical and physical basis of sodium silicates is presented below.

### 7.8.2.1 Chemical reactions

The main process route leading to the production of sodium silicate is by melting very pure quartz sand and sodium carbonate (soda ash), in most cases in a furnace at temperatures of 1300 – 1500 °C. The following equations illustrate the stoichiometry of the process reactions:



As shown in the equations, different molar ratios between soda and sand are possible. Due to the different properties of products with different molar ratios, they can be used for various applications.

A general distinction is made between solid silicates and liquid silicate solutions. Silicates are solid glasses, which are produced by solidification of the melt of soda and sand. Glasses dissolved in water are liquid glasses. Important technical grades of sodium silicates have a molar ratio in the range of 2 – 4 mol SiO<sub>2</sub> per 1 mol Na<sub>2</sub>O. Most commercial products are concentrated water glass solutions, which are produced using solid silicates with a molar ratio of about 3.3.

There are also sodium silicates with a molar ratio of 1 mol SiO<sub>2</sub> per 1 – 1.5 mol Na<sub>2</sub>O. These products are less important and are offered in the form of water-free crystals or as hydrates. Silicates are usually classified according to their raw materials (potassium or sodium) or to their quotient wt-% of SiO<sub>2</sub> per wt-% of Me<sub>2</sub>O. More important than the weight ratio is the molar ratio, which is obtained by multiplying the weight ratio of sodium silicate by 1.032. The molar ratio SiO<sub>2</sub>/Na<sub>2</sub>O is decisive for the properties of the different sodium silicates.

### 7.8.2.2 Different qualities of sodium silicates

#### 7.8.2.2.1 Non-aqueous sodium silicates with a molar ratio of SiO<sub>2</sub>/Na<sub>2</sub>O ≥ 2

Non-aqueous silicates are transparent pieces of glass. Their shapes depend on the type of receptacle in which they are solidified. Their colour can be blue to green in different shades due to the Fe<sup>2+</sup> ions, and respectively yellow to brown in different shades due to the Fe<sup>3+</sup> ions. Solid glass is produced on the basis of pure sand. Usually commercial sodium silicate glasses are not stoichiometric compounds. They often have an average molar ratio of SiO<sub>2</sub>/Na<sub>2</sub>O, which assures that the solution is stable. Table 7.50 shows commercial sodium silicate glasses with a molar ratio of SiO<sub>2</sub>/Na<sub>2</sub>O ≥ 2.

Quality	wt-% SiO <sub>2</sub>	wt-% Na <sub>2</sub> O	wt/molar ratio	
High silicate containing natronglass	80	20	3.8 – 4.0	3.9 – 4.1
‘Neutral natronglass’	77	23	3.3 – 3.4	3.4 – 3.5
‘Alkaline natronglas’	67	33	2.0 – 2.1	2.1 – 2.2

**Table 7.50:** Typical commercial sodium silicate solid glasses with a molar ratio of SiO<sub>2</sub>/Na<sub>2</sub>O ≥ 2 [43, UBA - Germany, 2001]

Sodium silicates with a molar ratio of  $\text{SiO}_2/\text{Na}_2\text{O} \geq 3$  are hardly affected by water at an ambient temperature. Sodium silicates with a molar ratio of  $\text{SiO}_2/\text{Na}_2\text{O} = 2$  are hygroscopic to a certain extent and stick together in case of humid storage. They can already be dissolved at a temperature around the boiling-point of the solution. In order to accelerate the dissolving process, a temperature of 150 – 160 °C is often used.

### 7.8.2.2.2 Water glass solutions with a molar ratio of $\text{SiO}_2/\text{Na}_2\text{O} \geq 2$

Solutions of sodium silicates with a molar ratio of  $\text{SiO}_2/\text{Na}_2\text{O} \geq 2$  are colourless, transparent and more or less viscous. The viscosity increases with the concentration and, under an unchanged concentration of silicic acid, with the molar ratio of  $\text{SiO}_2/\text{Na}_2\text{O}$ . After passing the point of critical concentration, the viscosity increases significantly with further concentration. For each molar ratio, there exists a maximum concentration. After having passed this maximum concentration, the solution becomes too viscous or unstable for technical handling.

Table 7.51 gives information concerning the physical composition of commercial water glass solutions in Germany.

Quality	Density kg/m <sup>3</sup> at 20 °C	wt-% SiO <sub>2</sub>	wt-% Na <sub>2</sub> O	wt-% water glass	Ratio wt/mole		Viscosity at 20 °C mPa	pH at 20 °C
HK 30	1255 – 1270	21.8 – 23.2	5.6 – 6.0	27.4 – 29.2	3.70 – 3.90	3.82 – 4.02	10 – 30	10.8
Water glass 37/40 Germany	1345 – 1355	26.6 – 27.0	7.8 – 8.2	34.4 – 35.2	3.30 – 3.40	3.40 – 3.51	50 – 100	11.4
58/60	1690 – 1710	36.0 – 37.0	17.8 – 18.4	53.8 – 55.4	2.06 – 2.12	2.06 – 2.12	~60000	12.2

**Table 7.51: Physical data of commercial sodium silicate solutions**  
[43, UBA - Germany, 2001]

All water glass solutions show alkaline reactions (pH >10.6). Dilution reduces the pH value, for example a dilution of the 37/40 quality of water glass to a solution of 1 wt-% causes a reduction of the pH value from 11.4 to 10.7. The liquid sodium silicate 37/40 with a concentration of 3.35 wt-% is the highest volume liquid water glass product in Germany.

### 7.8.2.2.3 Sodium silicates with a molar ratio of $\text{SiO}_2/\text{Na}_2\text{O} \leq 1$

These products are divided into non-aqueous sodium silicates and sodium silicates containing crystal water. The non-aqueous sodium silicate  $\text{Na}_2\text{SiO}_3$ , which is the only technically important product of this kind, is manufactured with sand and soda at a molar ratio of 1:1. Sodium metasilicate is a product which crystallises easily and is readily dissolved in water.

In the range of the products with a molar ratio of  $\text{SiO}_2/\text{Na}_2\text{O} < 1$  there are several technically important sodium silicates containing crystal water, for example hydrates of the metasilicate acid  $\text{Na}_2\text{H}_2\text{SiO}_4 \cdot x \text{H}_2\text{O}$ , where  $x = 4, 5, 7$  or  $8$ .

Sodium silicates containing crystal water are manufactured by mixing either water glasses with sodium hydroxide or sodium metasilicate with water, adding the required quantity of crystal water and crystallising them with the aid of inoculant crystals.

### 7.8.2.3 Production procedures

#### 7.8.2.3.1 General information

For better illustration of the main procedures applicable in the sodium silicate industry sector, Figure 7.23 shows a schematic flow chart for the production of four different groups of sodium silicates [116, M. Fawer, 1996]:

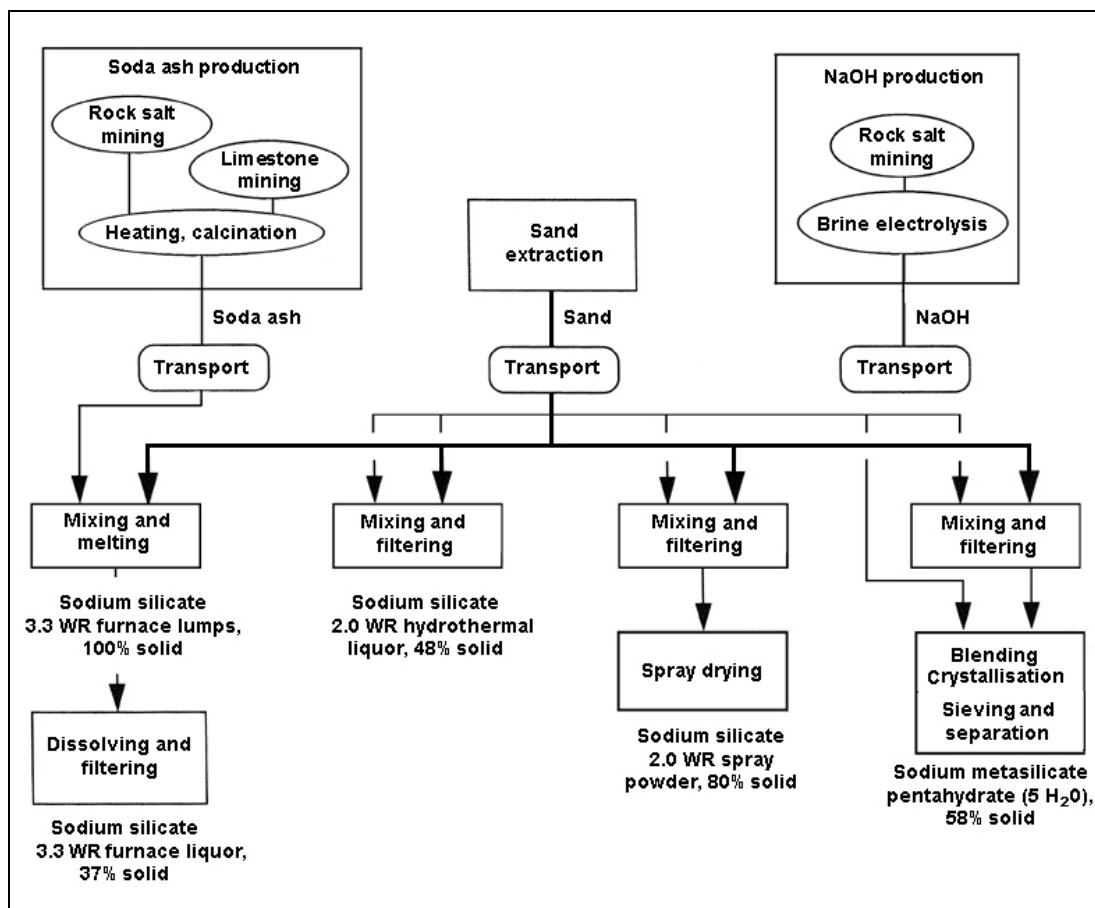


Figure 7.23: Schematic flow chart for the production of four different groups of sodium silicates [116, M. Fawer, 1996]

Since Chapter 7 concerns in principle ‘selected illustrative’ LVIC-S products, it was considered justified to concentrate in this document in particular on techniques applied in the large volume production of sodium silicate by the melting process route, i.e. on the manufacture of (3.3 WR) furnace lumps and furnace liquor.

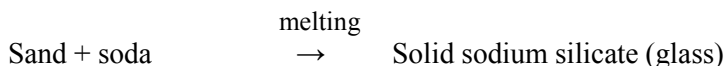
The production of sodium silicate (2.0 WR) liquor by the hydrothermal process route is briefly described in Section 7.8.1.2, however, to a lesser extent, with the consumption and emission data for this process quoted in Section 7.8.3.6 below [116, M. Fawer, 1996].

The process routes leading to sodium silicate 2.0 WR spray powder and to sodium metasilicate pentahydrate, are not included in this document, as these products are not classified as large volume inorganic chemicals – solid and others (the EU combined capacity threshold much below the indicative level of 100 kt per year) – refer to Section 1.1.3 (paragraph 10).

Also, it was considered not useful to repeat, in this section, the information on production techniques relating to the glass manufacturing industry and the special glass sector (such as oxy-fuel furnace, electric furnace, and sodic reaction), which are described in the BREF on the Glass Manufacturing Industry (GLS).

### 7.8.2.3.2 Production procedures of sodium silicate by the melting route

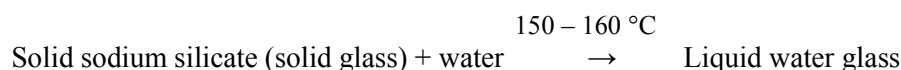
The production process of sodium silicate by the melting route is the following:



Solid glasses are cheap commodities, however, in spite of the relatively favourable energy costs, their import and export is not a good economic procedure, because of the high transport costs.

The production of solid glasses requires much energy, mostly natural gas or heavy heating oil. The use of heavy heating oil results in increased emissions of sulphur oxides because of the sulphur content in the fuel (<1 % S). The emissions can be reduced by applying SO<sub>x</sub> reduction methods in fuel gas.

When compared to the melting process, the energy demand and the environmental impact of the solution process, in which liquid water glass is obtained, are much lower. Some plants in Europe produce liquid water glasses, where production requires less energy, but this is in the case when solid sodium silicate is imported from a neighbouring country and converted into liquid water glass by the addition of water:



In the following sections, the overall manufacturing procedure from raw materials to the product (liquid water glass) is described. A distinction, however, is made between the use of a revolving hearth furnace and a tank furnace for the melting process, because it determines the required process procedures, the energy demand and the emission volumes.

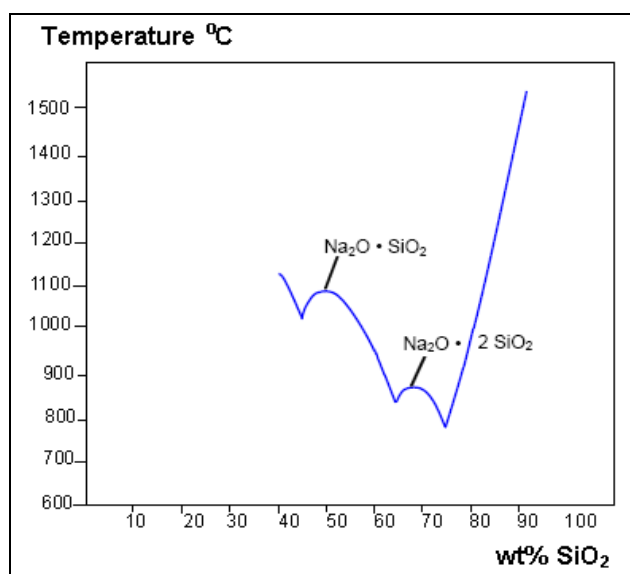
In most cases, quartz sand is used as the silicic acid component. It should be pure and washed, have a low iron and clay content, and granulation size of between 0.1 and 0.5 mm. Generally the purity of quartz-sand is as high as 99.7 % of SiO<sub>2</sub>. Other components, totalling 0.3 %, are iron, calcium, aluminium, magnesium, copper, titanium and some trace elements.

For the production of most pure sodium silicates, often for scientific purposes, the very clean and dispersed silicic acid (e.g. aerosil) is recommended. Sodium oxide is added as carbonate or hydroxide. The higher the required purity of the final product, the purer the raw material and additional components should be.

For example, in Germany there is only one producer, who uses the process in which dispersed silicic acid is applied, but this covers less than 15 % of the whole German product capacity. Generally, the technique of tank furnaces is used in most cases.

The required temperature of the furnace is determined by the desired product quality, which in turn, depends on the molar ratios of the feedstock components. Figure 7.24 shows the melting diagram of the system SiO<sub>2</sub>/Na<sub>2</sub>O as a function of the wt-% of SiO<sub>2</sub>.

It illustrates that for the production of sodium silicate with a molar ratio of SiO<sub>2</sub>/Na<sub>2</sub>O >3, and temperatures above 1300 °C are required. This diagram, however, presupposes ideal operating conditions, e.g. ideal feedstock relations.

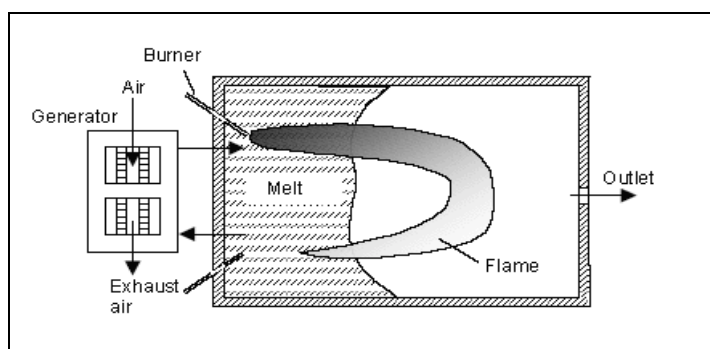


**Figure 7.24: Melting diagram of the system  $\text{SiO}_2/\text{Na}_2\text{O}$**   
[43, UBA - Germany, 2001]

### 7.8.2.3.3 Manufacture of sodium silicate in a tank furnace

The technique used in most production sites in Germany is the tank furnace for melting different substances. The working principles of a tank furnace are illustrated both in Figure 7.25 below, as well as in Figure 2.1 of the BREF on the Glass Manufacturing Industry (GLS). However, other configurations of furnace design can also be found in the EU sodium silicate industry.

Soda ash and sand are led into a tank and are heated from the top with gas or heating oil by means of a burner. Due to the stream of exhaust air, the flame of the burner forms the shape of a letter 'U' above the melt.



**Figure 7.25: Working principle of a tank furnace**  
[43, UBA - Germany, 2001]

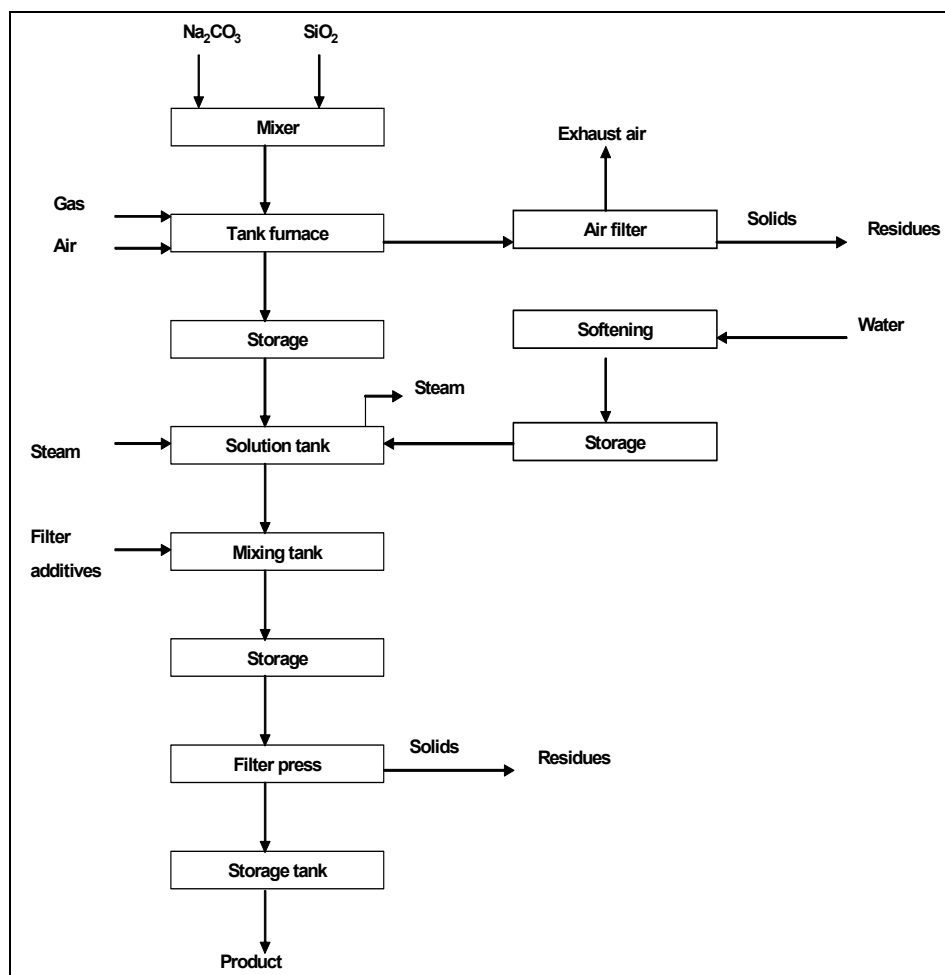
Outside Germany there are two types of tank furnaces used: continuous (such as in Germany) and batch. In the continuous furnace, the feedstock is continuously fed into the furnace and the melted product is continuously coming out, the level of the molten product remaining more or less stable. In the batch furnace, with the closed outlet, the feedstock is fed into the furnace until a certain level is reached. Then the feeding stops, and only after some hours the outlet is opened and the furnace discharges until the lower level of a molten product is reached, upon which a new batch cycle starts.

The main difference of a tank furnace in comparison to a revolving hearth furnace is that inside the tank furnace the melt is led to the outlet only because of a difference between the density of feedstock sand/soda and the density of the melt. In a tank furnace, feedstock components are not mixed (as by rotation in a revolving hearth furnace).

Consequently, the retention time in a tank furnace (generally between 12 – 18 hours, sometimes even up to 36 hours) is much longer than that in a revolving hearth furnace. The melting temperature is 1300 – 1400 °C.

Due to longer retention times and higher melting temperatures, the substances are melted more effectively than in a revolving hearth furnace. Consequently, in the case of a tank furnace, the content of residual sand grains in the solid sodium silicate product is much lower.

The flow diagram of the complete procedure for the production of sodium silicate using a tank furnace, including solution process and filtration, is shown in Figure 7.26.



**Figure 7.26: Flow diagram of the production of sodium silicate using a tank furnace**  
[43, UBA - Germany, 2001]

The feedstock components are led by a mixing system into the tank furnace, where they are melted. Before being discharged into the atmosphere, the exhaust air is filtered. In one plant, a fabric filter with a preceding sorption step is installed. Dust emission concentrations are in the range 5 – 30 mg/Nm<sup>3</sup>; typically below 20 mg/Nm<sup>3</sup> can be reached. The filtered dust is recycled.

The melt coming out of the tank furnace is fed to a transport system, such as forming rollers or an elevator (which may include additional cooling), where the melt very quickly solidifies. In the case of batch furnaces, the melt is fed to a cooling table, where it takes longer to solidify.

After an intermediate storage, the solid water glass is put into a solution tank, where water and steam are added. The liquid water glass is filtered with the aid of filter additives and then pumped into storage tanks.

### 7.8.2.3.4 Manufacture of sodium silicate in a revolving hearth furnace

The different production procedures of solid sodium silicate and liquid water glass respectively, can be divided as follows:

- type of melting furnace used
- energy recovery system used, and
- wash process (for liquid water glass) applied.

Figure 7.27 shows the flow diagram of the complete procedure for the production of sodium silicate with a revolving hearth furnace (including solution process and filtration). This applies to only one German plant, where sodium silicate with a molar ratio of 3.45 is produced.

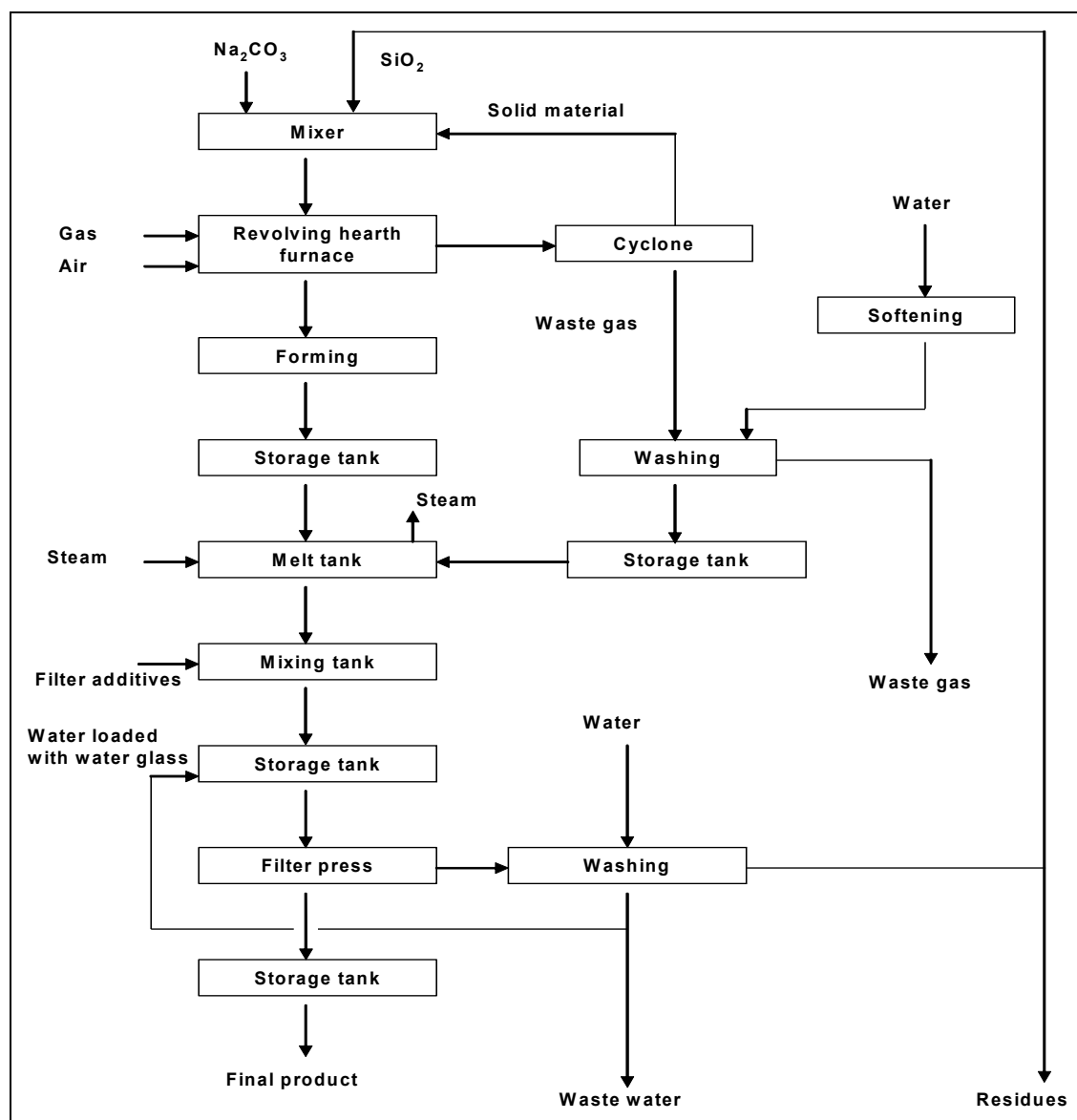


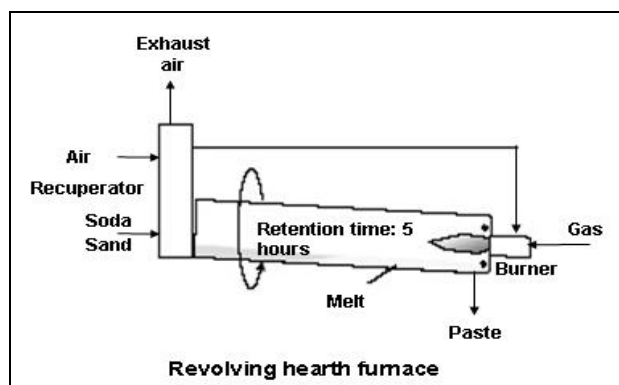
Figure 7.27: Flow diagram of the production of sodium silicate using a revolving hearth furnace [43, UBA - Germany, 2001]

Sand and soda are transported by a conveyor from two bunkers into a mixer. The humidity of the analysed sand is 5 – 6 %. In order to assure stable feedstock ratios, the humidity is regularly controlled.



Even a slight modification of the molar ratio may trigger important changes in the required product quality. The feedstock mixture is then transmitted to a revolving hearth furnace and melted at a temperature of 1100–1200 °C. The heat is generated by a gas burner, countercurrently to the inlet of the sand/soda mixture. The retention time of the sodium glass melt in the furnace is about 5 hours. By continuous rotation, the melt is slowly transmitted to the deepest point of the furnace. There, it leaves the furnace as a viscous paste and is led onto a conveyor. The paste solidifies very quickly on the conveyor and looks like glass. The paste which is still and flexible is formed by a drum, installed on top of the conveyor.

Figure 7.28 shows the working principle of a revolving hearth furnace.



**Figure 7.28: Working principle of a revolving hearth furnace**  
[43, UBA - Germany, 2001]

The solid sodium silicate thus produced, is led into a storage tank and then filled into an autoclave (melt tank), where it is dissolved in water. First the autoclaves are filled with gas, then softened water is added. During the cycle of rotation, the autoclaves are under pressure with the aid of live steam (160 °C, at 8 bar). Once the dissolving process is finished, the liquid water glass is fed into a mixer. After the addition of filter additives, like kieselguhr or perlite, the contaminants are separated from the product in a membrane filter press. The obtained transparent end-product, with a solids content of about 36 %, is finally fed into storage tanks.

The filter cake consists of undissolved sand, traces of iron oxide, calcium, aluminium, filter additives, and traces of dust from the off-gas treatment. The filter cake is washed, in order to rinse out the water glass solution. This also helps to avoid the filter cake solidifying too quickly, which would impede its recovery. Approximately 80 % of the filter cake is recycled and is remelted together with sand and soda ash. About 20 % of the filter cake is separated from the recycling process and is re-used, for instance, in the building industry. The water glass solution rinsed out of the filter cake is recycled back to the storage tank and filtered again, while part of it is discharged as waste water.

### 7.8.3 Present consumption and emission levels

#### 7.8.3.1 Tank furnace process – energy consumption

As an alternative to the heat recovery in a recuperator, the combustion air may be preheated, as shown in Figure 7.29, by the alternating use of regenerators. The hot flue-gas flows out via a brick layer, which is heated by the hot flue-gas. After a certain time, another regenerator is used. The warm regenerator is now filled with inflowing cold air, which is heated by the warm bricks. A continuous operation is reached by regular changes of the regenerators. The counter-stream principle of inflow and exhaust air cannot be used in the case of a tank furnace.

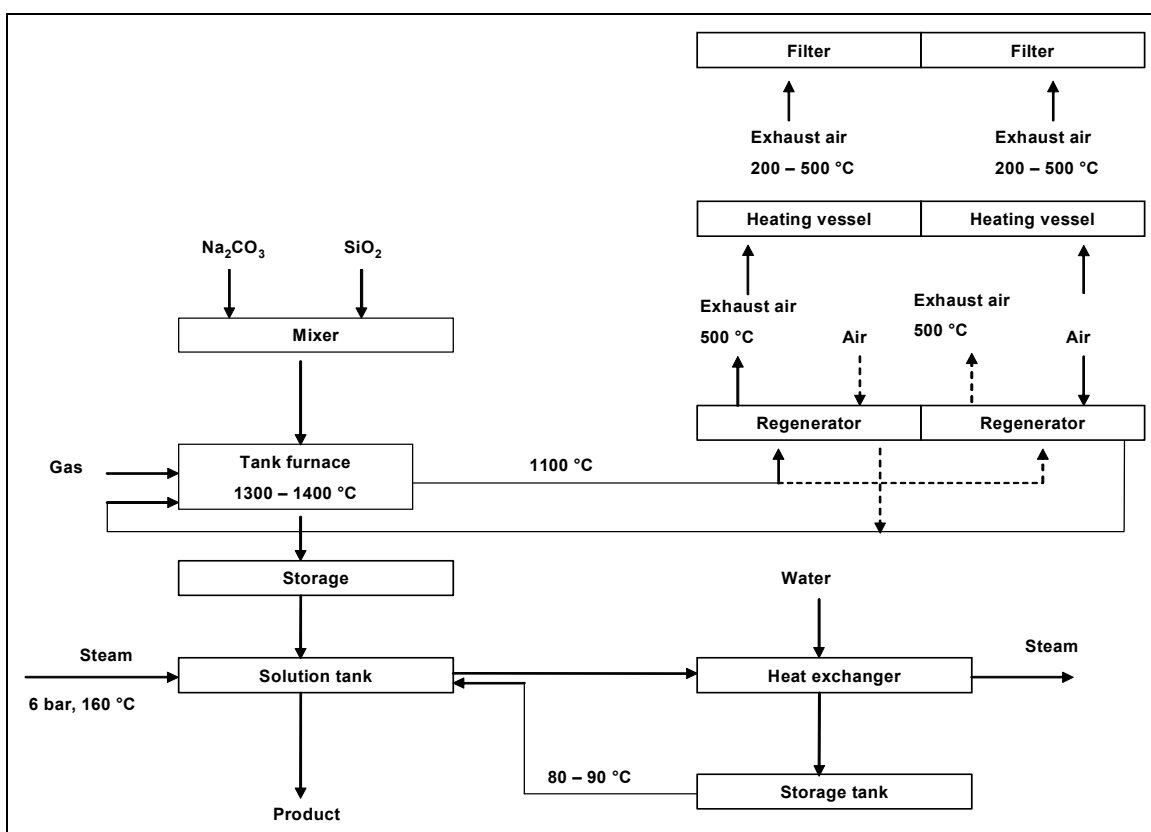


Figure 7.29: Heat recovery by regenerators  
[43, UBA - Germany, 2001]

Under similar molar ratios (3.3 – 3.45), the specific energy demand in the tank furnace may be similar to that in the revolving hearth furnace. When considering secondary energy production in regenerators, the overall energy efficiency of the tank furnace may be almost as high as for the hearth furnace. The specific energy demand for liquid water glass is max. 0.1 t steam/tonne of solution, equivalent to approximately 280 MJ/tonne liquid water glass.

### 7.8.3.2 Tank furnace process – emissions

Figure 7.30 shows the different emission sources in the production of sodium silicate using a tank furnace and their specific loads:

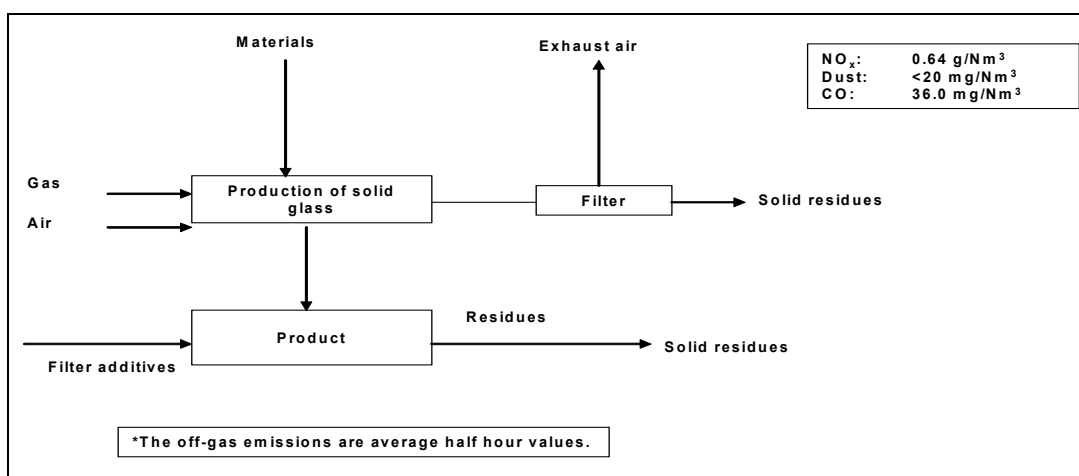


Figure 7.30: Emissions from the production of sodium silicate using a tank furnace  
[43, UBA - Germany, 2001]

## 7.8.3.2.1 Emissions to air

Table 7.52 gives the concentrations of exhaust air from a tank furnace plant. The emission values ( $\text{mg}/\text{Nm}^3$ ) are related to the air in a standard state (273 °K, 101.3 kPa) after removing the water vapour. The obtained results relate to an oxygen content in the exhaust air of 8 %. The emissions of sulphur dioxide depend strongly on the fuel used for the production of sodium silicate. When natural gas is used,  $\text{SO}_2$  emissions are very low. In the case of heavy heating oil (<1 % S) sulphur dioxide emissions should be reduced by secondary measures. This, however, does not apply to the gas fired furnaces, which use heavy oil as emergency back up only (in the case of a break in gas supply).

The composition of the exhaust air from a production site working with a tank furnace and natural gas is shown in Table 7.52.

Parameter	Unit	Max. average ½ hourly value
Carbon monoxide	$\text{mg}/\text{Nm}^3$	36.0
Nitrogen oxide	$\text{mg}/\text{Nm}^3$	640
Sulphur oxide(depending on the fuel)	$\text{mg}/\text{Nm}^3$	100
Emission of dust	$\text{mg}/\text{Nm}^3$	<20
Inorganic gaseous chlorine compounds, as hydrogen chloride	$\text{mg}/\text{Nm}^3$	2.0
Fluorine and fluorine gaseous or vapour compounds, as hydrogen fluoride	$\text{mg}/\text{Nm}^3$	0.4
This is based on dry waste gas under normal conditions, oxygen content 8 vol-%.		

**Table 7.52: Composition of the exhaust air – a site with a tank furnace and using natural gas [43, UBA - Germany, 2001]**

Table 7.53 shows emission concentrations in waste gas from another producer, working with a tank furnace and heavy oil:

Parameter	Concentrations (average ½ hourly values)
Dust	14 $\text{mg}/\text{Nm}^3$
Nitrogen oxide	406 $\text{mg}/\text{Nm}^3$
Carbon monoxide	<4 $\text{mg}/\text{Nm}^3$ (maximum average ½ hourly value), under the measurable limit in most cases
Sulphur dioxide	364 $\text{mg}/\text{Nm}^3$
Hydrogen chloride	3.8 $\text{mg}/\text{Nm}^3$
Hydrogen fluoride	1.07 $\text{mg}/\text{Nm}^3$
This is based on dry waste gas under normal conditions, oxygen content 8 vol-%	

**Table 7.53: Emission concentrations in waste gas – a site with a tank furnace and using heavy oil [43, UBA - Germany, 2001]**

The main difference between a tank furnace and a revolving hearth furnace is the concentration of  $\text{NO}_x$  in the exhaust air. More nitrogen is converted to  $\text{NO}_x$  in a tank furnace due to higher operating temperatures.

## 7.8.3.2.2 Emissions to water

In the case of sodium silicate production with a tank furnace, the filter cake is not recycled. Consequently, with this option there are no washing processes and no waste water emissions, apart from the case of a water cooled elevator, where waste water emissions will occur.

### 7.8.3.2.3 Solid wastes

The amount of residues is very low. The amount of filter additives is about 0.3 – 0.4 kg/t of liquid water glass.

### 7.8.3.3 Revolving hearth furnace – energy consumption

#### 7.8.3.3.1 Energy consumption in the production of solid water glass

The cost of energy used in the production of solid water glass is determined by the energy demand. In most cases, the energy demand of the sodium silicate production depends on:

- type and efficiency of the energy recovery
- retention time in the reactor.

Figure 7.31 shows the system of heat recovery in a sodium silicate plant based on a revolving hearth furnace.

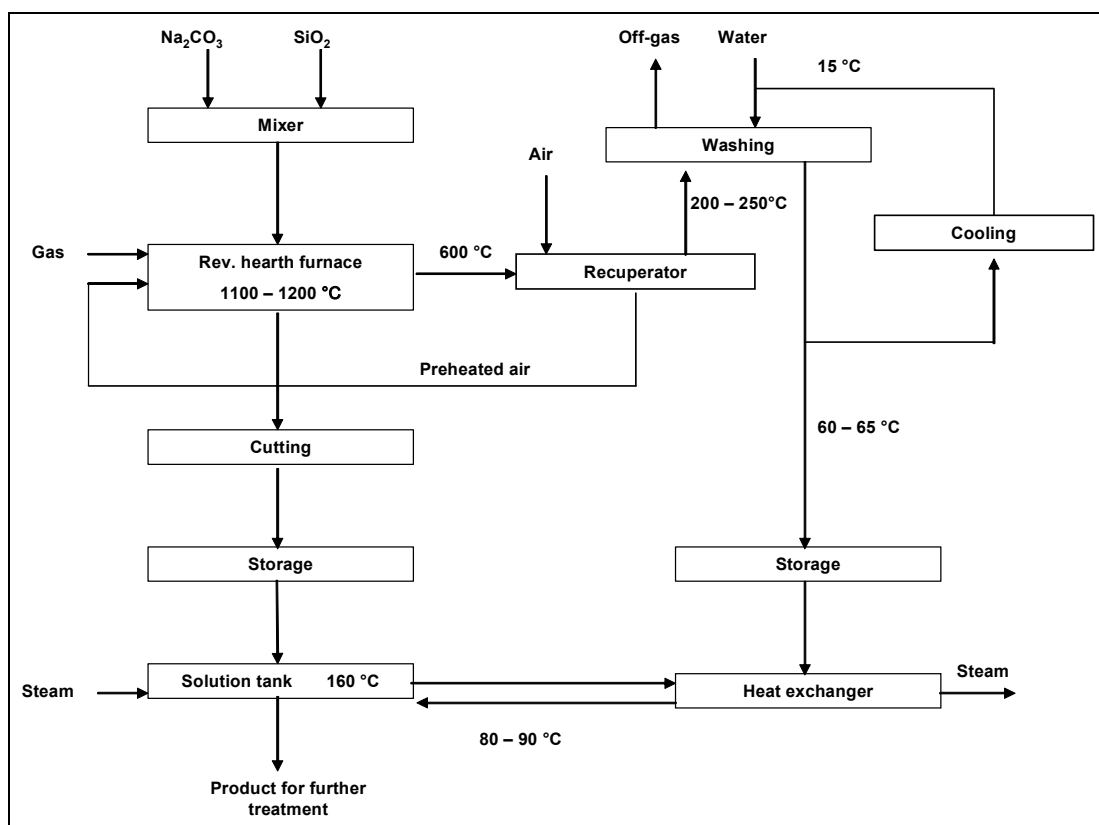


Figure 7.31: The principle of heat recovery in a sodium silicate plant (revolving hearth furnace) [43, UBA - Germany, 2001]

In order to increase energy efficiency and to meet the energy demand in a sodium silicate plant using a revolving hearth furnace, the following principles need to be taken into consideration:

#### Counter-stream principle

To obtain maximum energy recovery, the hot waste gas heats the incoming feedstock as far as possible. Hence, the mixture of sand and soda has to be led countercurrently to the outflowing exhaust air. The furnace rotates and consequently the sand/soda mixture is heated to a very high melting temperature (above 1100 °C). Meanwhile, the exhaust air leaves the furnace at about 600 °C. This allows for an intense heat exchange between the incoming feedstock and the exhaust air.



#### 7.8.3.4.1 Emissions to air

The composition of the exhaust air depends on the chemical reactions and the conditions of the combustion process. CO<sub>2</sub> is generated by the reaction of soda and quartz-sand. Carbon dioxide is also generated by the combustion of gas and air.

Table 7.54 gives specific emission rates and concentrations of pollutants. The values relate to the air in a standard state (273 °K, 101.3 kPa), and are given in mg/Nm<sup>3</sup> after removal of the water vapour. They relate to an oxygen content in the off-gas of 8 %.

Parameter	Specific emissions per tonne of water glass	Concentration
Carbon dioxide from the combustion of gas	238 kg	
Carbon dioxide from the reaction	165 kg	
Nitrogen oxide	0.075 – 0.32 kg	<200 mg/Nm <sup>3</sup>
Dust	45 – 85 g	<50 mg/Nm <sup>3</sup>
The concentrations are average half hourly values, based on several measurements; O <sub>2</sub> content 8 vol-%		

**Table 7.54: Emissions and concentrations of pollutants in exhaust air – revolving hearth furnace [43, UBA - Germany, 2001]**

#### 7.8.3.4.2 Emissions to water

Emissions of waste water depend on the desired product quality of the water glass and the necessity to filter the liquid water glass. Due to steadily increasing product quality requirements, the filtration of the liquid water glass may become obligatory in the future.

In the above-mentioned case of the production of sodium silicate using a revolving hearth furnace, emissions of waste water are caused by the softening process and the washing process of the filter cake. The waste water is alkaline with a pH value ≤10.

The concentration of settleable solids oscillates between 30 – 60 mg/l. There are, however, no or only traces of organic elements and heavy metals in the waste water. The volume of waste water is between 0 and 3 m<sup>3</sup>/tonne water glass.

#### 7.8.3.4.3 Solid wastes

In the revolving hearth furnace, about 1 % per tonne water glass are residues. This is because quartz-sand does not react to 100 % efficiency with sodium carbonate. Other residues from the off-gas treatment are less important.

By filtration of the liquid water glass, the residues are separated from the product. From 0.5 to 1 kg of filter additives per tonne liquid water glass have to be added to the balance of solid residues.

In the process of sodium silicate production using a revolving hearth furnace, about 0.8 – 1.6 kg residues per tonne of solid sodium silicate are generated. This is equivalent to about 20 % of the total filter cake volume.

#### 7.8.3.5 Inputs and outputs in the production of solid water glass

In order to make a comparison of some data available on consumption and emission levels in sodium silicate production, Table 7.55 presents inputs and outputs from the production of solid water glass, taken from the BREF on Glass Manufacturing Industry, as follows:

Inputs per tonne of water glass		Outputs per tonne of water glass	
<b>Raw materials</b>		<b>Product water glass</b>	1000 kg
Sand (dry)	772.1 kg		
Sodium carbonate	399.6 kg	<b>Air emissions</b>	
<b>Ancillary materials</b>		Fluoride (HF)	0.4 g
Water (steam production)	7.3 kg	Carbon dioxide **	540 kg
Water treatment chemicals	0.1 kg	Carbon monoxide	0.258 kg
<b>Water consumption</b>		Chloride (HCl)	0.024 kg
Process water	0.28 m <sup>3</sup>	Oxides of sulphur (as SO <sub>2</sub> )	1.322 kg
Cooling water	0.94 m <sup>3</sup>	Dust	0.212 kg
Washing water	0.18 m <sup>3</sup>	Oxides of nitrogen (as NO <sub>2</sub> )	2.028 kg
(Recycled water)	68 kg	<b>Waste water</b>	0.28 m <sup>3</sup>
<b>Energy *</b>		BOD	0.17 g
Total	6053 MJ	COD	0.003 g
Recovered	708 MJ	Suspended solids	4.2 g
Consumption	5344 MJ	<b>Solid waste</b>	0.65 kg
* This process was fitted with a heat recovery boiler			
** Carbon dioxide emissions resulting from both the reaction and burning fuel.			

Table 7.55: Inputs and outputs in solid water glass production

### 7.8.3.6 Inputs and outputs – sodium silicate by the hydrothermal route

Table 7.56 shows the main average process data of the hydrothermal process (mixing and filtering) to produce 2.0 WR sodium silicate liquor with 48 % solid content:

Inputs per tonne of sodium silicate liquor		Outputs per tonne of sodium silicate liquor	
<b>Raw materials</b>		<b>Product Na-silicate liquor (48 % s.)</b>	1000 kg
Washed sand	337 kg		
NaOH 100 % (50 % aq.)	209 kg	<b>Recyclable materials</b>	
<b>Auxiliary materials</b>		Filter residues	0.7 kg
Water (steam production)	155 kg	Water	69 kg
Additives	0.7 kg	<b>Water emissions</b>	
<b>Water consumption</b>		Waste water	0.11 m <sup>3</sup>
Process water	0.46 m <sup>3</sup>	COD (as g O <sub>2</sub> )	6.3 g
Cooling water	0.01 m <sup>3</sup>	Chlorides (Cl <sup>-</sup> )	47 g
Washing water	0.30 m <sup>3</sup>	Iron (Fe)	0.04 g
<b>Energy</b>		Nitrates (NO <sub>3</sub> <sup>-</sup> )	0.14 g
Process energy,	589 MJ	Phosphates (PO <sub>4</sub> <sup>3-</sup> )	0.01 g
<i>of which:</i>		Silicates	1643 g
<i>Electricity</i>	53 MJ	Suspended solids	611 g
<i>Gas</i>	429 MJ	<b>Solid waste</b>	
<i>All the other process uses</i>	107 MJ	Mineral waste	8.7 kg
Recovered energy	None	Filter residues	1.2 kg
Fuel production and delivery	184 MJ	Inert chemicals	0.02 kg
<b>Total energy consumption</b>	773 MJ	<b>Air emissions</b>	<b>None</b>

Table 7.56: Inputs and outputs in the production of Na-silicate by the hydrothermal route [116, M. Fawer, 1996]

The average amounts of sand (337 kg/t) and NaOH (209 kg/t) used in this process are very close to the theoretical values of 320 kg/t and 206.5 kg/t respectively. The spread lies between 323 - 345 kg/t for sand and 207 – 212 kg/t for NaOH.

The average energy use for the hydrothermal process (mixing and filtering), including fuel production and delivery, to produce 2.0 WR sodium silicate liquor with 48 % solid content, is 773 MJ/t, while the figures for individual companies vary between 420 – 1250 MJ/t.

## 7.8.4 Techniques to consider in the determination of BAT

### Introduction: Techniques to consider in the determination of BAT – refer to Section 7.1.4

Sodium silicate (solid water glass) is produced by melting soda ash and sand in a high energy intensive process. The main environmental problems in the production of sodium silicate are associated with the emissions to air from the furnaces fired with natural gas (or fuel oil).

The capacities of furnaces range from below 40 up to 350 tonnes per day and are mainly cross-fired regenerative or recuperative tank furnaces, although rotary furnaces are also used – refer to the BREF on GLS, where other furnace configurations used in Europe are also described.

Apart from the emission of combustion products ( $\text{CO}_2$ ,  $\text{SO}_x$ ,  $\text{NO}_x$ ), furnace emissions also contain dust and traces of chlorides and fluorides that were present in the raw materials (soda ash and sand).

It should also be noted, that in the production of liquid water glass, solid wastes are generated from the filtration step (filter cake). However, the amount of solid residues is so small that techniques to consider in the determination of BAT have not been examined.

Therefore, the following five techniques, relating to cleaning the outlet air from sodium silicate furnaces, aimed at the reduction of the emissions of dust,  $\text{SO}_2$ ,  $\text{NO}_x$ , HCl, and HF to the atmosphere, are presented below.

### 7.8.4.1 Reduction of dust emissions using fabric filters or electrostatic precipitators

#### Description

In order to reduce dust emissions from the production of sodium silicates, fabric filters or electrostatic precipitates are used. Fabric filter systems are used for many applications within the glass industry, due to their high efficiency in controlling the fine particulate matter encountered in mineral operations (refer to the BREF on Glass Manufacturing Industry). However, fabric filters may not be the preferred choice in all applications, and therefore, electrostatic precipitators should also be taken into consideration, as they are capable of operating over a wide range of conditions and are not particularly sensitive to particle size. Where appropriate, a bag filter system or an electrostatic precipitator, can operate in conjunction with a dry or semi-dry acid gas scrubbing system.

#### Achieved environmental benefits

The reduction of dust emissions to the atmosphere.

#### Cross-media effects

There are no reported disadvantages caused by the implementation of this technique.

#### Operational data

Refer to information included in Section 7.8.3 above, and particularly to data included in Table 7.52, Table 7.53, Table 7.54, and in Table 7.55.

According to German environmental standards, fabric filters or electrostatic precipitators should be used in order to reduce dust emissions from the production of sodium silicates (solid water glass) to below  $20 \text{ mg/m}^3$  of outlet air.

Refer also to the BREF on the Glass Manufacturing Industry, in which the emission level associated with the use of an electrostatic precipitator or bag filter in the special glass sector (representative to solid water glass) is estimated at  $5 - 30 \text{ mg/m}^3$  of outlet air.



### Applicability

This technique may be applicable to the plants producing sodium silicate using continuous tank furnaces and revolving hearth furnaces. For batch furnaces refer to the BREF on GLS.

### Economics

No data submitted. Refer to the BREF on the Glass Manufacturing Industry.

### Driving force for implementation

The protection of the environment.

### Example plants

Refer to Table 7.49.

### Reference literature

[43, UBA - Germany, 2001], [85, EIPPCB, 2004-2005]. The BREF on the Glass Manufacturing Industry. The BREF on Common Waste Water and Waste gas Treatment/Management Systems in the Chemical Sector.

## **7.8.4.2 Reduction of SO<sub>2</sub> emissions using low sulphur fuel**

### Description

One of the main environmental problems in the production of sodium silicates is associated with the emission of combustion products from the furnace operations, including SO<sub>x</sub>. Also, the sulphate content in the molten solid silicate has some influence on the level of SO<sub>x</sub> emissions, however, to a limited extent only.

Therefore, to keep the emissions of SO<sub>2</sub> from the sodium silicate furnaces at a low level, low sulphur fuel, preferably sulphur free natural gas, is used. Low sulphur content natural gas is widely available in Europe, however, the purer the gas, the higher the price.

If required, dry acid scrubbing is considered as a secondary, end-of-pipe measure to reduce the emission of SO<sub>2</sub>, in particular in the sodium silicate plants based on fuel oil. This, however, does not apply to the gas fired furnaces, which use heavy oil as emergency back up only (in the case of a break in gas supply).

### Achieved environmental benefits

The reduction of SO<sub>2</sub> emissions to the atmosphere.

### Cross-media effects

There are no reported disadvantages caused by the implementation of this technique. If required, the potential desulphurisation of a fossil fuel (gas or fuel oil) is normally carried out upstream of the sodium silicate production site.

### Operational data

Refer to information included in Section 7.8.3 above, and particularly to data included in Table 7.52, Table 7.53, and in Table 7.55.

According to German environmental standards, low sulphur fuel, preferably sulphur free natural gas, should be used in order to reduce SO<sub>2</sub> emissions in the production of sodium silicates (solid water glass) below 200 mg/m<sup>3</sup> of outlet gas. However, it should be noted, that with the emission SO<sub>2</sub> level in the outlet air of below 200 mg/m<sup>3</sup> of outlet gas, the recycling of dust and cullet to the furnace may be difficult.

Refer also to the BREF on the Glass Manufacturing Industry (GLS), where the ranges of SO<sub>2</sub> emissions for the special glass industry, including water glass, are quoted at the levels of 200 - 500 mg/Nm<sup>3</sup> (gas fired furnaces) and 500 - 1200 mg/Nm<sup>3</sup> (oil fired furnaces).

Applicability

This technique is applicable to the plants producing sodium silicate using continuous tank furnaces and revolving hearth furnaces. For batch furnaces, the usage of low sulphur fuel should be considered as a primary measure (for batch furnaces refer to the BREF on GLS).

Economics

No data submitted. Refer to the BREF on the Glass Manufacturing Industry.

Driving force for implementation

The protection of the environment.

Example plants

Refer to Table 7.49.

Reference literature

[43, UBA - Germany, 2001], [85, EIPPCB, 2004-2005]. The BREF on the Glass Manufacturing Industry. The BREF on Common Waste Water and Waste Gas Treatment/Management Systems in the Chemical Sector.

**7.8.4.3 Reduction of NO<sub>x</sub> emissions using primary measures**Description

One of the main environmental problems in the production of sodium silicates is associated with the emission of combustion products from the furnace operations, including NO<sub>x</sub>.

In order to keep the emissions of NO<sub>x</sub> to the atmosphere at a low level, primary measures are used, including: reduced air/fuel ratio, reduced combustion air temperature, staged combustion, and in particular low NO<sub>x</sub> burners. Low NO<sub>x</sub> burners are the optimised fuel burning systems designed to minimise NO<sub>x</sub> formation during burning of fossil fuels (gas, oil).

Emission reductions of around 30 % are achieved using these optimised systems. Primary measures (e.g. low NO<sub>x</sub> burners) can be supplemented by secondary measures, i.e. the application of SNCR or SCR techniques.

Achieved environmental benefits

The reduction of NO<sub>x</sub> emissions to the atmosphere.

Cross-media effects

No detailed information submitted. It should be noted that according to the experience gathered from the glass industry, gas fired furnaces result in higher NO<sub>x</sub> emissions than fuel oil fired furnaces. In turn, the use of fuel oil fired furnaces results in higher SO<sub>2</sub> emissions than gas fired furnaces.

Therefore, the fuel choice in favour of fuel oil, is a very limited option here as a primary deNO<sub>x</sub> reduction measure. Refer to the BREF on Glass Manufacturing Industry.

Operational data

Refer to information included in Section 7.8.3 above, and particularly to data included in Table 7.52, Table 7.53, Table 7.54, and in Table 7.55. According to German environmental standards, primary deNO<sub>x</sub> measures, should be used, if required, supplemented by secondary deNO<sub>x</sub> measures (SNCR or SCR) in order to reduce NO<sub>x</sub> emissions in the production of sodium silicates (solid water glass) below 500 mg/m<sup>3</sup> of outlet gas [85, EIPPCB, 2004-2005].

Refer also to the BREF on the Glass Manufacturing Industry, where the range of NO<sub>x</sub> emissions (expressed as NO<sub>2</sub>) for the special glass industry, including water glass, are quoted at the level of 500 – 700 mg/Nm<sup>3</sup>.

### Applicability

This technique is applicable to the plants producing sodium silicate using continuous tank furnaces and revolving hearth furnaces. For batch furnaces refer to the BREF on GLS.

### Economics

No data submitted. Refer to the BREF on the Glass Manufacturing Industry.

### Driving force for implementation

The protection of the environment.

### Example plants

Refer to Table 7.49.

### Reference literature

[43, UBA - Germany, 2001], [47, InfoMil, 2002]. The BREF on the Glass Manufacturing Industry. The BREF on Common Waste Water and Waste gas Treatment/Management Systems in the Chemical Sector.

## **7.8.4.4 Reduction of HCl emissions using low chloride soda**

### Description

Sodium silicate (solid water glass) is produced by melting soda ash and sand in furnaces fired with natural gas or fuel oil. Apart from the emission of combustion products (CO<sub>2</sub>, SO<sub>x</sub>, NO<sub>x</sub>), furnace emissions also contain dust and traces of chlorides and fluorides that were present in the raw materials (soda ash and sand).

Of particular importance here is the content of the chloride ions (primarily as NaCl) in soda ash used for the production of sodium silicate. Soda ash has a residual NaCl content of approximately 0.05 – 0.15 %. Pressure from the glass industry has led soda ash producers to lower NaCl levels significantly in recent years (now generally around 0.1 %), however, in some cases a residual NaCl content in soda ash may be higher. Therefore, in order to reduce the emissions of hydrogen chloride into the atmosphere, the primary measure to be applied before all others, is to use low chloride soda ash.

### Achieved environmental benefits

The reduction of the emissions of hydrogen chloride to the atmosphere.

### Cross-media effects

There are no reported disadvantages caused by the implementation of this technique.

### Operational data

Refer to information included in Section 7.8.3 above, and particularly to data included in Table 7.52, Table 7.53, and in Table 7.55. According to German environmental standards, low chloride soda should be used for the production of sodium silicate, if necessary followed by the secondary measure of dry acid scrubbing in order to reduce the emissions of hydrogen chloride into the atmosphere to below 30 mg/m<sup>3</sup> of outlet gas [85, EIPPCB, 2004-2005]. Refer also to the BREF on the Glass Manufacturing Industry.

### Applicability

This technique is applicable to the plants producing sodium silicate using continuous tank furnaces and revolving hearth furnaces. For batch furnaces, the usage of low chloride soda ash should be also considered as a primary measure (for batch furnaces refer to the BREF on GLS).

### Economics

No data submitted. Refer to the BREF on the Glass Manufacturing Industry.

### Driving force for implementation

The protection of the environment.

Example plants

Refer to Table 7.49.

Reference literature

[43, UBA - Germany, 2001]. The BREF on the Glass Manufacturing Industry. The BREF on Common Waste Water and Waste gas Treatment/Management Systems in the Chemical Sector.

**7.8.4.5 Reduction of HF emissions using dry acid scrubbing**Description

Sodium silicate (solid water glass) is produced by melting soda ash and sand in furnaces fired with natural gas or fuel oil. Apart from the emission of combustion products, furnace emissions also contain dust and traces of chlorides and fluorides that were present in the raw materials (soda ash and sand).

In some cases, of particular importance here is the content of the fluoride ions (F<sup>-</sup>) in sand used for the production of sodium silicate (e.g. when a dolomite deposit is neighbouring a sand quarry) and, hence, the primary measure to be applied, is to use low fluoride sand. Also, following customer requests, specific solid water glass formulations may require the use of sand containing fluoride, and then there will be emissions of hydrogen fluoride. The addition of cullet may have an opposing influence on the emissions of hydrogen fluoride, as from one side, cullet may contain a high content of fluoride, and from the other, the addition of cullet would lower the melting temperature and the volatilisation of the fluorides.

To keep the emissions of hydrogen fluoride in the outlet gas at a low level, raw materials low in fluoride should be used for the production of sodium silicate, combined with the dry acid scrubbing. The dry acid scrubbing, which – if necessary – may also be applied as a secondary end-of-pipe measure in the abatement of the emissions of SO<sub>2</sub> and HCl (see Sections 7.8.4.2 and 7.8.4.4 above), consists in the dispersion of the reactive material (the absorbent) in the waste gas stream. The absorbents are chosen to form with SO<sub>x</sub>, HCl and HF solid particles, which are subsequently removed from the waste gas stream by a bag filter system or electrostatic precipitator.

Achieved environmental benefits

The reduction of hydrogen fluoride emissions to the atmosphere.

Cross-media effects

No detailed information submitted.

Operational data

Refer to information included in Section 7.8.3 above, and particularly to data included in Table 7.52, Table 7.53, and in Table 7.55.

According to German environmental standards, dry acid scrubbing should be used in order to reduce the emissions of hydrogen fluoride into the atmosphere to below 5 mg/m<sup>3</sup> of outlet gas. Refer also to the BREF on the Glass Manufacturing Industry.

Applicability

This technique is applicable to the plants producing sodium silicate using continuous tank furnaces and revolving hearth furnaces. For batch furnaces refer to the BREF on GLS.

Economics

No data submitted. Refer to the BREF on the Glass Manufacturing Industry.

Driving force for implementation

The protection of the environment.

### Example plants

Refer to Table 7.49.

### Reference literature

[43, UBA - Germany, 2001], [85, EIPPCB, 2004-2005]. The BREF on the Glass Manufacturing Industry. The BREF on Common Waste Water and Waste gas Treatment/Management Systems in the Chemical Sector.

## 7.8.5 Best Available Techniques for the manufacture of sodium silicate

For general information on understanding a BAT Section and its contents, see Section 7.1.5.

Sodium silicate (water glass) is currently produced in the EU by the:

- melting process route, typically by the dominating continuous tank furnace process (some plants use batch tank furnace process), but also by the continuous revolving hearth process (one plant identified). In the melting process sodium silicate water glasses (lumps) are produced by the direct fusion of pure quartz sand ( $\text{SiO}_2$ ) and soda ash ( $\text{Na}_2\text{CO}_3$ ) in oil, gas, or electrically-fired furnaces at temperatures above 1000 °C. This process yields sodium silicate lumps with weight ratios (WR) between 1.8 – 3.5 and covers approximately 70 - 80 % water glass production capacities in the EU
- hydrothermal process route, which covers approximately 20 – 30 % water glass production capacities in the EU.

As both process routes yield different quality products (the melting route yields 3.3 WR sodium silicate furnace lumps and furnace solution, while the hydrothermal route 2.0 WR sodium silicate liquor, these yields being most illustrative for data included in Section 7.8). However, no process is selected as BAT and conclusions for both processes are presented here in parallel.

Because of a very limited scope of information submitted on batch process, only some clear BAT conclusions (e.g. relevant to the purity of raw materials used for the production of water glass or the usage of low sulphur fuel) are also applicable to batch furnaces operating by the melting process route.

However, it should be noted that the discontinuous batch process introduces large variations in emission concentrations along each cycle which would oblige the installation of excessively expensive equipment to reach the values indicated for the continuous process. It is also worth mentioning that the batch process is usually used by small capacity tank furnaces (<20 t/day) and, therefore, installing additional equipment would then cause the production facilities using batch process to be economically not viable.

**For the production of sodium silicate by the melting process route, BAT is to:**

1. Reduce dust emissions to air to 10 – 20 mg/Nm<sup>3</sup> of the outlet gas (as average ½ hourly values) for a continuous tank furnace. Techniques such as improved furnace/firing modifications, scrubbers or fabric filters can be used. When only primary measures can be applied, values of up to 50 mg/Nm<sup>3</sup> are achieved.

Reduce dust emissions to air to 30 – 60 mg/Nm<sup>3</sup> of the outlet gas (as average ½ hourly values) for a revolving hearth furnace. Techniques such as scrubbers can be used.

2. Reduce SO<sub>2</sub> emissions to air to 100 – 200 mg SO<sub>2</sub>/Nm<sup>3</sup> of the outlet gas (as average ½ hourly values) by using low sulphur fuel (natural gas) in the operation of both continuous and batch furnaces (see Sections 7.8.3.2.1 and 7.8.4.2).

Notes:

The above-mentioned performance BAT target may not be satisfied in cases when:

- water glass dust and glass cullet are recycled to the furnace
  - the gas fired furnaces use heavy fuel oil as an emergency back-up (for the periods of breaks in continuous gas supply)
  - the sodium silicate plant is based on fuel oil, with SO<sub>2</sub> emissions typically much higher, which can then be reduced by using secondary measures, such as dry acid scrubbing.
3. Reduce NO<sub>x</sub> emissions from the tank furnace to air to 400 – 600 mg NO<sub>2</sub>/Nm<sup>3</sup> of the outlet gas (as average ½ hourly values) by using primary measures, including: reduced air/fuel ratio, reduced combustion air temperature, staged combustion and, in particular, low NO<sub>x</sub> burners (see Sections 7.8.1.3, 7.8.3.2.1 and 7.8.4.3).

Notes:

For the revolving hearth furnace NO<sub>x</sub> emissions are quoted at a much lower level 50 - 190 mg NO<sub>2</sub>/Nm<sup>3</sup> of the outlet gas, as more nitrogen (originating from the combustion air) is converted to NO<sub>x</sub> in a tank furnace due to higher operating temperatures.

Gas-fired furnaces result in higher NO<sub>x</sub> emissions than fuel oil-fired furnaces. However, because of higher SO<sub>2</sub> emissions resulting from fuel oil-fired furnaces, the fuel choice in favour of fuel oil is a very limited option as a primary deNO<sub>x</sub> reduction measure. Therefore, if required in a given local situation, primary deNO<sub>x</sub> measures should be supplemented by secondary deNO<sub>x</sub> measures (SNCR or SCR).

4. Reduce combined emissions of chlorine and fluorine compounds to 2.5 – 5 mg (HCl + HF)/Nm<sup>3</sup> of the outlet gas (as average ½ hourly values) by using low chloride and low fluoride content soda ash as a primary measure for the reduction of emissions of halogens into air (see Sections 7.8.3.2.1 and 7.8.4.4).

Notes:

The usage of low chloride and low fluoride soda ash should also be considered as a primary measure for the reduction of emissions of halogens into air in batch furnaces.

5. Reduce emissions of fluorine compounds to 0.4 – 1 mg HF/Nm<sup>3</sup> of the outlet gas (as average ½ hourly values) by using low fluoride content sand as a primary measure of the reduction of emissions of fluorine into air and, if necessary, combine it with the dry acid scrubbing as a secondary end-of-pipe measure (also used in the abatement of SO<sub>2</sub> and HCl emissions to air) – see Sections 7.8.3.2.1 and 7.8.4.5.
6. Maintain the overall energy consumption in the production of sodium silicate in the range from 4 GJ per tonne solid water glass product for the continuous revolving hearth furnace up to 5 GJ per tonne solid water glass product for the continuous tank furnace by applying available energy recovery systems used in the revolving hearth furnace (counter-stream principle applied, heat recuperators used for preheating air, changeable product retention time) and in the tank furnace (heat regenerators, heat recovery boilers) – see Sections 7.8.3.1, 7.8.3.3 and 7.8.3.5.

Notes:

The above-mentioned performance target associated with BAT for tank furnaces (5 GJ per tonne solid water glass product) may not be satisfied in cases when the batch process is used, usually by small capacity, less energy efficient, tank furnaces.

**For the production of sodium silicate by the hydrothermal route, BAT is to:**

1. Maintain the consumption of raw materials at the level of 323 – 337 kg sand and 207 - 209 kg NaOH per tonne of 48 % Na-silicate liquor product by using improved process control in the mixing and filtering steps of the process in order to minimise the discharge of sodium silicate to water (see Sections 7.8.1.2, 7.8.2.3 and 7.8.3.6).
2. Maintain the net consumption of process energy in the range of 0.4 – 0.6 GJ per tonne of 48 % Na-silicate liquor product by using improved process control in mixing and filtering steps of the process (see Sections 7.8.1.2 and 7.8.3.6).

## 7.9 Silicon carbide

### 7.9.1 General information

#### 7.9.1.1 Introduction

Silicon carbide (SiC) is a substance which only occurs naturally as the mineral moissanite in the meteorite iron of Canon Diablo in Arizona, in the US.

Silicon carbide finds applications in the production of abrasives (due to its extreme hardness), of sophisticated refractories, of high temperature electric resistances (due to its electric conductivity), and of diodes for electric rectifiers (due to its semi-conducting properties). It is also used in the metallurgical industry. Traditionally, the metallurgical, abrasive and refractory industries are the largest users of silicon carbide. SiC is also used for the heating elements in electric furnaces and electronic devices. Current production in Europe is approximately 50 % of metallurgical grade and 50 % of high grade for refractories and abrasives applications. The market share however could be different from the above quoted figures.

The first commercial production began at the end of the nineteenth century when Acheson developed a process of reacting sand and coke in a resistance furnace. It is still the basic silicon carbide manufacturing process used today. In 2005, the world production was estimated to be around 750000 tonnes per year.

The following plants in Europe produce silicon carbide:

Country	Location	Capacity (tonnes per year*)
Norway	Orkanger, Orkdal	15000
	Arendal	25000
	Lillesand	18000
Romania	Turda	20000
	Titu, Slatina	30000
Russia	Volgograd	72000
Spain	Mansilla de las Mulas, Puente de Vadillos	30000
Switzerland	Bodio	Unknown
The Netherlands	Delfzijl	65000
Ukraine	Zaporozsky	30000
*Based on 2002 data		

**Table 7.57: Silicon carbide producers in Europe and assessed capacities of SiC plants [67, InfoMil - Dutch Authorities, 2004]**

The production of SiC is influenced by two important constraints. It consumes a significant amount of energy and, therefore, many producers have located their plants close to low cost energy sources. Another constraint, which is increasingly affecting mainly producers in Europe and the US, is a necessity to comply with strict environmental regulations.

#### 7.9.1.2 Physico-chemical properties

The properties of silicon carbide make it a useful material for several manufacturing processes. It is a very hard material occupying a relative high position on Moh's hardness scale between alumina at 9 and diamond at 10. It has a very high resistance to heat, in reducing conditions subliming at approximately 2700 °C. It also has a very high thermal conductivity. Although very hard, it is also very brittle, making it difficult to keep large pieces intact.



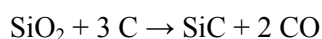
Chemically, SiC is a very non-wetting material, giving it high resistance to many molten slags and metals. Since the slags do not coat the SiC well, it inhibits any reacting with them.

The content of SiC in metallurgical grade is in the range 60 – 90 %. The content in the high grade will be higher than 90 %, typically 97 – 98 %.

## 7.9.2 Applied processes and techniques

Silicon carbide is commercially produced by a high temperature electrochemical reaction of high grade silica sand (quartz) and carbon (usually low or medium sulphur petroleum coke), selected for their purity and their particle size. The process carried out in electric resistor furnaces operated batch wise is highly energy intensive (typically 6.2 – 8 MWh/t 100 % SiC).

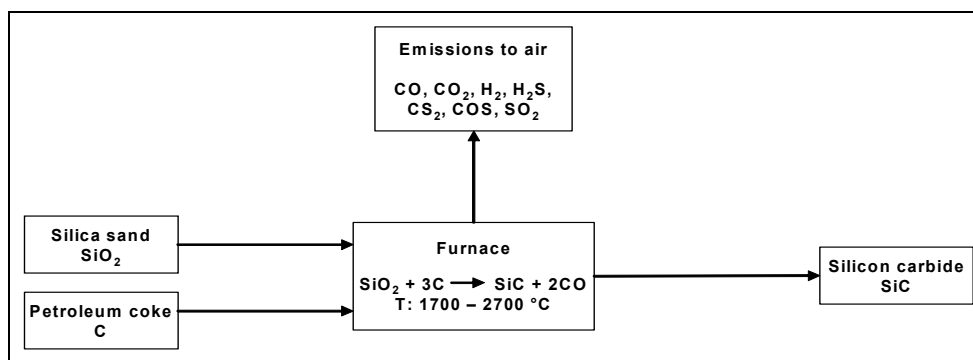
The basic reaction is:



The reaction requires 2.8 – 2.9 kg of raw material for 1 kg SiC. The stoichiometric consumption is 2.4 kg of raw materials. The balance is mostly moisture, volatiles and sulphur.

The heating resistor is immersed in the previously mixed feedstock, and the reaction takes place around the resistor. Once the reaction cycle is over, the furnace is allowed to cool, and different grades of silicon carbide are recovered, depending on their distance to the electrode.

A simplified process flow diagram given in Figure 7.33 illustrates the application of a SiC furnace technique.



**Figure 7.33: Simplified diagram of silicon carbide production**  
[67, InfoMil - Dutch Authorities, 2004]

Most producers around the world use variations of the Acheson electric furnace. When the furnace is started, the carbon electrodes are joined by the graphite core, which is laid in the length of the furnace in the middle of the mixture which fills the furnace. The electric current passing through the resistance core generates a temperature of about 2400 °C. In 2 – 20 days time, depending on the size of the furnace and the transformer, the chemical reaction of silica and carbon is complete. Once the furnace cycle is completed, the result is a silicon carbide ingot consisting of 80 – 100 % SiC. The purity of the SiC decreases from the core of the ingot to the outer layers.

Any unreacted material is re-used in a new batch. The inner, high grade SiC material is very compact and is often referred to in the market place as ‘crystalline’ SiC or crude SiC. The outer lower grade material is termed ‘amorphous’ or ‘metallurgical’.

The silicon carbide produced in the batch is sorted: part of it requires reprocessing, while the best quality product is crushed to meet the appropriate particle size distribution. After removing the SiC cylinder and breaking it down, the crude is crushed and sorted, usually in specific refining facilities, according to SiC quality and particle size.

Emissions to air are a major concern in SiC production processes. In particular, the carbon monoxide may be recovered, but some plants have no possibility to undertake such a recovery.

### 7.9.2.1 Furnace set-up – traditional design

Most SiC production facilities in the world are made up of traditional stationary type SiC furnaces. The traditional facility comprises two to six furnaces per group with a transformer.

The furnaces are placed inside furnace halls and are usually equipped with removable refractory sides. A mobile SiC furnace consists of a single sole or a coupled series of wheeled sections. It can be moved from place to place on rails.

The size of the conventional furnaces ranges from 10 to 20 m. Their thermal efficiency amounts to 50–65%. The reaction time in the traditional furnace is about one to three days. A characteristic of the traditional set-up is a higher yield of crystalline SiC, due to a relatively steep temperature gradient.

### 7.9.2.2 Furnace set-up – freiland design

In the 1970s, a new design called ‘freiland’ was developed. The high-capacity SiC furnaces are up to 60 m long, with bottom electrodes (straight line of U-shape) and without end or side walls. Furnaces are placed outdoors. The reaction time is about eight days.

The new design enables a reduction of some of the environmental problems arising from the production of SiC. Although, thermodynamic efficiency of the freiland furnace without gas collection is reported to be at the similar range as for the traditional furnace set, the freiland process has better energy efficiency due to a larger capacity of the furnace and better insulation.

If the process gas is collected under the PE foil, it can be consequently treated. The energy from the process gas can be further recovered in an energy recovery plant. This further improves the overall thermodynamic efficiency.

The freiland furnace technique is applied in the Netherlands, US, Brazil and Venezuela.

Both the Dutch and the US SiC producers use an integrated pollution prevention system by collecting the gas under the foil and use a desulphurisation installation. The Dutch SiC plant also has an installation for energy recovery. Both the Brazilian and the Venezuelan SiC producers burn the process gas on the furnace.

### 7.9.3 Present consumption and emission levels

Considering the environmental impact of SiC production, a distinction should be made between the two different furnace set-ups – the traditional and the freiland techniques. Both techniques might differ in or have different environmental implications and possibilities to apply end-of-pipe techniques.

The emissions originates from the following production activities:

- furnace terrain
- furnacing
- sorting and processing of crude silicon carbide
- storage and transport of silicon carbide.

The emissions can also be related to the use of environmental installations regarding the furnace technique:

- gas collection
- desulphurisation
- energy recovery
- deNO<sub>x</sub> techniques
- dust prevention and collection
- low sulphur petroleum cokes
- waste water treatment.

The raw material usage of silica sand and carbon is independent of furnace design.

### 7.9.3.1 Emissions to air

The process gas is the most important source of emissions to air. About 92 – 95 % of the process gas is formed by CO, H<sub>2</sub> and CO<sub>2</sub>. The remainder contains H<sub>2</sub>S, CS<sub>2</sub>, COS, N<sub>2</sub>, O<sub>2</sub>, CH<sub>4</sub> and traces of CH<sub>3</sub>SH. The volatile sulphur compounds (SO<sub>2</sub>, H<sub>2</sub>S, CS<sub>2</sub>, COS and CH<sub>3</sub>SH) originate from the sulphur present in the coke, a by-product from the oil refinery. H<sub>2</sub>S emission and other volatile components, causing odour problems even in very low concentrations, are relevant locally.

The coke contains further polycyclic aromatic hydrocarbons (PAHs) and heavy metals in small amounts. For the production of green silicon carbide, N-source may be added to the furnace, resulting in NO<sub>x</sub> emissions. (No nitrogen is added to the process in the two Norwegian plants producing green crude.) Dust emissions are caused by the following activities: building and breaking down of the furnaces, storage and transporting the feedstock (sand, coke, and insulation material), coke grinding and charge mixing.

In order to compare, in a complex way, the traditional and the freiland furnace operations and to draw firm conclusions on the advantages of each of these processes due to the complexity of measurement and considering the capacity utilisation level the plants are running at, more detailed information, illustrating the following options, would be necessary:

- the traditional furnace vs. the freiland furnace, both processes operating without gas collection (basic SiC process set-up)
- the traditional furnace without gas collection vs. the freiland furnace with gas collection
- the traditional furnace with a dust prevention and collection system vs. the freiland furnace with a dust prevention system.

Although there are some differences in data relating to operating parameters and emissions quoted in the traditional furnace vs. the freiland furnace, Table 7.58 and Table 7.59 give an approximate overview of potential air pollutants, their sources and an indication of the specific emissions of these pollutants.

The figures are based on 100 % SiC production. Table 7.58 refers to measurements from Norwegian plants. The reported data are assuming CO<sub>2</sub> and sulphur compounds to remain the same disregarding the installation of dust removal systems. For particulate matter the data refer to data after dust removal systems. Table 7.59 refers to measurements from the Dutch producer and specifies emission levels for no control system, after desulphurisation and after energy recovery.

Emission component	Origin	Specific emission (kg per tonne SiC)		
		Arendal	Lillesand	Orkdal
CO <sub>2</sub>	Product of combustion of the process gas	2180 – 2800		
Total sulphur as SO <sub>2</sub>	Oxidation of sulphur present in petroleum coke	23 – 35	29 – 36	29 – 36
SO <sub>2</sub>	Oxidation of sulphur present in petroleum coke	15 – 24	17 – 23	-
COS	Sulphur compounds present in petroleum coke	4.5 – 6.7	5.6 – 7.2	-
CS <sub>2</sub>		2.2 – 3.3	2.9 – 3.6	-
H <sub>2</sub> S		0.3 – 0.7	0.5	-
(CH <sub>3</sub> ) <sub>2</sub> S		1.1 – 1.7	1.4 – 1.8	-
NO <sub>x</sub>		-	-	0.5
Particulate matter		11 – 12	6	11 – 13
<b>Specific emissions (g per tonne SiC)</b>				
PAH	Present in the raw materials	33	32 – 33	19 – 21
As		-	0.6	1.3
Cd		-	0.14	2.1
Cr <sup>-3</sup>		2.3	7.5	2.1
Cu		2.2	7.7	2.1
Hg		-	0.06	0.007
Pb		4.8	10.2	0.6
Comments: <u>CO<sub>2</sub></u> : A factor of 2.56 kg CO <sub>2</sub> per kg SiC produced is currently being used by the Norwegian producers for calculating CO <sub>2</sub> emissions. This is somewhat higher than the stoichiometric factor of 2.2 which can be deduced from the general equation SiO <sub>2</sub> + 3 C = SiC + 2 CO. This is because it takes into account that the conversion is not 100 % effective. <u>'Total sulphur as SO<sub>2</sub>'</u> reflects the theoretical emissions of SO <sub>2</sub> , if all sulphur present in the petroleum coke was converted to SO <sub>2</sub> (which is not the case). <u>SO<sub>2</sub></u> is the part of the total sulphur emissions which actually occur as SO <sub>2</sub> . Previous studies conducted at the Saint-Gobain plants, have indicated that around 2/3 of the total sulphur emissions is SO <sub>2</sub> , while 1/3 are other gases like COS, CS <sub>2</sub> , (CH <sub>3</sub> ) <sub>2</sub> S and H <sub>2</sub> S. <u>COS, CS<sub>2</sub>, (CH<sub>3</sub>)<sub>2</sub>S and H<sub>2</sub>S</u> : Norwegian producers have reported annual emissions of these gases since 2000. The intervals given in the table reflect variations in the sulphur content of the coke over the last three years (2005 data). <u>Heavy metals</u> : were measured/calculated in 2000. The specific emissions listed in the table are calculated on the basis of the distribution of heavy metals found in that particular study.				

**Table 7.58: Specific emissions from the traditional furnace operation (Norwegian companies) [67, InfoMil - Dutch Authorities, 2004]**

Emission component	Origin	Specific emission (kg per tonne SiC)		
		Freiland	Desulphurisation unit	Energy recovery plant
CO	Product of incomplete combustion of the process gas	1500 <sup>1</sup>	-	5.3 – 11
CO <sub>2</sub>	Product of <u>complete</u> combustion of the process gas	2300	-	2300
SO <sub>2</sub>	Oxidation of sulphur compounds present in the process gas	42 – 85 <sup>2</sup>	6.4 – 11	42 – 85
H <sub>2</sub> S	Release of gas during the breaking down of the furnace Water vapour during spraying and from the spraying water basins	0.2 (typical data - Dutch producer) 0.8 <sup>3</sup>		
Oxides of nitrogen (NO <sub>x</sub> ), nitrogen compounds	Present in the process gas (coke, N-base to produce green SiC) Emission from the processing activities (e.g. drier), energy recovery plant 2/3 process emission, 1/3 thermal emission (combustion)	-	-	1.8 – 2.1
Particulate matter (e.g. SiC dust, SiO <sub>2</sub> , coke)	Building and breaking down of the furnace, storage and transport of the feedstock, processing of the crude	2.5 <sup>4</sup>	-	-
PAH and heavy metals	Present in the coke	Small amount	-	-

<sup>1</sup> When CO is not burned to CO<sub>2</sub>, in practice the specific emission in relation to the concentration of the process gas is 650 – 1000 kg per tonne SiC. This is burned in the energy recovery plant, resulting finally into approx 5 to 6 kg per tonne SiC of diffuse CO emission.

<sup>2</sup> 42 kg per tonne SiC if coke with 1.5 % sulphur content is used, 85 kg per tonne SiC if coke with 3 % sulphur content is used

<sup>3</sup> Before building the waste water unit

<sup>4</sup> Permission to emit 2.55 kg per tonne SiC, based on the report of an independent consultant, February 1995.

**Table 7.59: Specific emissions from the freiland furnace operation (Dutch company) [67, InfoMil - Dutch Authorities, 2004]**

### 7.9.3.2 Emissions to water – emissions from water to air

The indoor traditional furnace operation uses no or very little water addition. Therefore, water pollution is not a subject of concern for this type of operation.

In the SiC plants using freiland furnace technology (the Netherlands, US, Venezuela and Brazil), water is used to spray the furnaces and cool them down after the production cycle is completed and before the SiC cylinder is removed. Most of the spray water evaporates on the surface of the furnace. The spray water also prevents emissions of dust and odour from the furnace. The whole production terrain is generally also sprayed in order to prevent dust emissions.

The Dutch SiC plant uses a closed furnace spraying water circuit. From under each furnace a water drainage system collects the spray water. The drainage water is polluted by PAHs and H<sub>2</sub>S. Also the condensate, which is formed after the process gas is cooled down, contains PAHs and H<sub>2</sub>S. Both waste water streams are treated in the waste water treatment plant. The cleaned water is gathered in the water basins and used again for spraying. If the waste water unit is not working (due to a breakdown or a maintenance stop), untreated water is collected in special basins.

Water is temporarily stored here before it can be treated in the waste water unit. These basins are both lined and covered with foil as a protection against emission to the soil and air.

The following water streams can be further distinguished in relation to the use of environmental installations:

- regeneration water from the demi-water installation
- waste liquid from the LRSR (Liquid Redox Sulphur Recovery) process.

### 7.9.3.3 Soil (groundwater) pollution

If raw materials are stored indoor and little or no water is used, as in the traditional furnace operation, there will be no soil or groundwater pollution [85, EIPPCB, 2004-2005].

In some cases, however, production of silicon carbide, as any other operation involving pet cokes, can cause soil pollution. The following activities/installations can be sources of pollution:

- storage of coke, grinding, charge mixing – PAHs, mineral oils, heavy metals
- furnace terrain – PAHs, mineral oils, heavy metals.

In turn, regarding environmental installations applied at the freiland furnace set-up in the Dutch SiC plant, the following activities can be sources of pollution:

- gas condensate pits – PAHs, mineral oils
- desulphurisation unit – PAHs, mineral oils
- waste water treatment unit – PAHs, mineral oils
- water basins (sludge) – PAHs, mineral oils, heavy metals.

### 7.9.3.4 Solid wastes

SiC production generates hardly any process-related waste. Unreacted material from the furnaces is re-used in a new batch as an insulation or reaction material.

Process-related waste fractions from the operation of conventional traditional furnaces include mainly scrapped fragments of furnace walls and spent electrodes. Filter dust collected in the process gas treatment systems is recovered.

Some waste streams can be identified in connection with the use of the environmental measures in the freiland process (e.g. PE foil) and environmental installations (e.g. sludge from the waste water treatment plant).

### 7.9.3.5 Energy consumption

The production of silicon carbide is an energy intensive process. The specific energy consumption of traditional furnace installations varies between 7 to 8 MWh per tonne 100 % SiC. The Norwegian plants report consuming around 7.5 MWh per tonne 100 % SiC.

Installations using the freiland furnace technique need less energy. The furnaces are larger and better insulated. The specific energy consumption in the Dutch plants amounts to 6.2 - 7.2 MWh per tonne 100 % SiC. Design of the freiland furnaces further enables the recovery of energy from the process gas after its desulphurisation. The SiC plant in the Netherlands is, however, the only installation in the world which has an energy recovery plant. In this installation, energy consumption amounts to 5.2 - 6.2 MWh per tonne 100 % SiC.

## 7.9.4 Techniques to consider in the determination of BAT

**Introduction: Techniques to consider in the determination of BAT – refer to Section 7.1.4**

### 7.9.4.1 Use of low sulphur coke

#### Description

The use of low sulphur coke is, in general, the only applied measure to minimise H<sub>2</sub>S and SO<sub>2</sub> emissions when using the traditional furnace technique. These conventional furnaces use mostly petroleum coke containing <1.5 to 3 % sulphur.

Generally in Europe, the percentage of sulphur is not prescribed in the permits. Instead, emissions are regulated by SO<sub>2</sub> emission limits.

Freiland furnaces equipped with a desulphurisation unit are also prepared to use coke with a higher sulphur content, but the use of low sulphur content coke in this process can further reduce the total SO<sub>2</sub> emission. For the SiC plant in the Netherlands, under normal operation, the percentage of sulphur in coke is not prescribed. However, during planned maintenance stops of the desulphurisation unit exceeding 48 hours, 1.5 % sulphur in the mixture has to be used.

#### Achieved environmental benefits

The use of low sulphur coke results in the reduction of H<sub>2</sub>S and SO<sub>2</sub> emissions, particularly when using the traditional furnace technique.

#### Cross-media effects

There are no reported disadvantages caused by the implementation of this technique.

#### Operational data

Refer to Section 7.9.3.1 and, in particular, to data in Table 7.58, Table 7.59, and Table 7.60.

Table 7.60 shows the percentage of sulphur in the coke used over the last 10 years (1993 - 2002) at the three SiC Norwegian plants:

Location	1993	1994	1995	1996	1997	1998	1999	2000	2001	2002
Arendal	1.91	1.73	2.42	2.01	1.46	1.51	1.74	1.54	1.12	1.55
Lillesand	2.23	2.08	2.17	1.87	1.76	1.38	1.94	1.65	1.50	1.79
Orkdal	3.00	2.57	2.85	2.85	2.84	2.26	1.53	1.59	1.28	1.27

**Table 7.60: Sulphur content in the coke used at the three Norwegian plants (1993-2002) – showed in percentage**  
[67, InfoMil - Dutch Authorities, 2004]

#### Applicability

This technique is applicable to the plants producing silicon carbide, and particularly to the SiC plants using the traditional furnaces, which are not coupled with a desulphurisation unit.

#### Economics

No data submitted.

#### Driving force for implementation

The protection of the environment.

#### Example plants

The silicon carbide plants in Orkdal, Arendal, and Lillesand, Norway.

For the freiland furnace technique: the plant in the Netherlands – see Table 7.57.

#### Reference literature

[67, InfoMil - Dutch Authorities, 2004].

### 7.9.4.2 Gas desulphurisation

#### Description

If gas is collected, desulphurisation techniques can be applied before or after burning process gas. The SiC plants in the Netherlands and in the US are the only plants using a desulphurisation installation (2005 data).

The process gas, consisting of CO, CO<sub>2</sub>, H<sub>2</sub> and different sulphur compounds (H<sub>2</sub>S, SO<sub>2</sub>, COS and CS<sub>2</sub>) is collected under the PE foil and led through the gas collecting system to the desulphurisation installation.

#### **Process gas desulphurisation**

In the process used in the SiC plant in the Netherlands, COS and CS<sub>2</sub> are first catalytically transformed into H<sub>2</sub>S. Further, a LRSR (Liquid Redox Sulphur Recovery) process is used. An aqueous solution containing an iron complex, catalyses the oxidation reaction of H<sub>2</sub>S with oxygen to elemental sulphur and water.

Advantages of the LRSR process are the relative insensitiveness to CO<sub>2</sub> and the large flexibility with respect to the amount (volume and concentration) of gas and H<sub>2</sub>S. A large content of CO<sub>2</sub> makes the application of, e.g. the Claus process used by refineries, not possible.

Theoretically speaking, it is also possible to use desulphurisation for the flue-gas. According to current knowledge (2005), it has been implemented only in a Swiss plant optimised for producing graphite.

#### Achieved environmental benefits

Process gas desulphurisation allows for a substantial reduction of the emissions of different sulphur compounds (H<sub>2</sub>S, COS and CS<sub>2</sub>) to the atmosphere.

#### Cross-media effects

Degenerated, non toxic, bio-degradable waste water of the liquid iron complex solution. Sulphur can be used in the sulphur processing industry.

#### Operational data

The SO<sub>2</sub> emissions at the SiC plant in the Netherlands range between 6.4 – 11 kg per tonne of 100 % SiC, including (maintenance) stops. The SiC plants in the US do not convert COS and CS<sub>2</sub> to H<sub>2</sub>S, so these compounds are not removed by the process, making the overall removal efficiency lower.

#### Applicability

This technique is applicable when process gas is collected.

#### Economics

No data submitted.

#### Driving force for implementation

The protection of the environment.

#### Example plants

The silicon carbide plant in Delfzijl, The Netherlands – see Table 7.57.

#### Reference literature

[67, InfoMil - Dutch Authorities, 2004].



### 7.9.4.3 Energy recovery

#### Description

Process gas collection enables energy recovery. The gas is collected under the PE foil. It is led to the energy recovery plant where the gas is combusted and energy recovered. The electricity is led back to the production process. The Dutch SiC plant is the only existing installation having an energy recovery plant. The recovered energy covers about 15 % of the energy consumption of the company.

#### Achieved environmental benefits

The recovery of energy results in the reduction of fossil fuels used in the generation of electricity required for the production of silicon carbide and, therefore, in global terms has a positive impact on the environment.

#### Cross-media effects

There are additional NO<sub>x</sub> emissions reported which are caused by the implementation of this technique.

#### Operational data

The production of silicon carbide is a very energy intensive process. The specific energy consumption of traditional furnace installations varies between 7 to 8 MWh per tonne SiC. Installations using the freiland furnace technique need less energy, i.e. 6.2 – 7.2 MWh per tonne SiC.

With the recovery of energy from the process gas in the silicon carbide plant in the Netherlands, energy consumption amounts to 5.2 – 6.2 MWh per tonne SiC (refer to Section 7.9.3.5 above).

#### Applicability

This technique is applicable to the silicon carbide installations equipped with with a process gas collection system.

#### Economics

No data submitted, however, the energy savings are about 1 MWh per tonne SiC produced.

#### Driving force for implementation

High energy efficiency in the process, combined with the protection of the environment.

#### Example plants

The silicon carbide plant in Delfzijl, the Netherlands – see Table 7.57.

#### Reference literature

[67, InfoMil - Dutch Authorities, 2004].

### 7.9.4.4 DeNO<sub>x</sub> techniques

#### Description

NO<sub>x</sub> emissions are of minor importance if considering process-related emissions. However, it is considerable with respect to the operation of the energy recovery plant as usual when burning gas for the production of electricity. The plant in the Netherlands examined different deNO<sub>x</sub> techniques in the past but this did not lead to any concrete application. It is said to be due to the alternating composition of the process gas regarding flowrate, calorific value and moisture content.

#### Achieved environmental benefits

This technique has not yet been applied on an industrial scale and, therefore, there are no known benefits.

Cross-media effects

No information submitted.

Operational data

No information submitted.

Applicability

If successful, the potential technique would be applicable to the silicon carbide installations equipped with energy recovery.

Economics

No data submitted.

Driving force for implementation

The protection of the environment.

Example plants

This technique has not yet been applied on an industrial scale.

Reference literature

[67, InfoMil - Dutch Authorities, 2004].

### 7.9.4.5 Dust prevention

Description

Dust emissions from SiC furnaces depend strongly on how they are operated. The largest dust emissions usually occur during the breaking down of furnaces and also when furnaces are 'blowing'.

The following measures are relevant:

- use of long cooling times before the breaking down of furnaces:  
dust emissions from the breaking of furnaces could be reduced by allowing the furnaces to cool down as much as possible before they are broken down, thus reducing the buoyancy of process gases and dust. This could either be done by spraying the surface of a furnace with water or by allowing it to cool for a prolonged period of time before breaking down
- rapid quenching of blows:  
blowing should be quenched as soon as possible in order to limit emissions to air. This is usually done by covering the surface of the furnace with charge material
- 'end-of-pipe' treatment of dust emissions for traditional furnaces placed indoors:  
the two most important end-of-pipe measures at the Norwegian SiC plants are the fabric filter system at Arendal<sup>1</sup> and the treatment units installed in the stacks at Lillesand<sup>2</sup>. Furthermore, fabric filter systems are installed to reduce dust emissions from coke grinding, charge mixing and refining facilities. All three Norwegian plants (listed in Table 7.57) have indoor coke grinding and charge mixing facilities, as well as closed/indoor conveyor belts for the transport of raw materials. All raw materials are stored indoors.

<sup>1</sup> A fumes collection and filter system is installed in one of the furnace halls at Arendal. The system consists of dampers and fans which collect process gases from inside the furnace hall and direct them to a conventional fabric filter. The filter system is not dimensioned for handling the entire air volume which leaves the furnace hall. The capacity of the filter is 750000 m<sup>3</sup>/h while the total air is around 2 million m<sup>3</sup>/hour. It is, therefore, important that the dampers and fans are operated in such a way that the most heavily polluted process gases are collected at any moment. When, for instance, a furnace is to be broken down, the dampers in the ceiling right above this furnace should be closed, so that dust arising from the breaking down operation could be collected and filtered.

<sup>2</sup> At Lillesand, process gases and dust leave the furnace hall through 28 stacks. Treatment units resembling electrostatic filters were installed in all stacks in 1998 to reduce dust emissions. The total capacity of the fans in the stacks is 2 million m<sup>3</sup>/h. The treatment units reduce dust emissions by 30 – 35 %.

The following main measures are applied in the Dutch SiC plant in Delfzijl:

- water spraying during the breaking down of furnaces
- water spraying of the site areas with a mobile spray installation
- daily sweeping of the site areas
- dust reduction by filter systems during breaking down and crushing crude in the processing halls
- moistening (wetting) of the coke in the storage areas with spray water
- storing sand and fine products in closed boxes
- closed systems for coke grinding and charge mixing, without dust emissions.

### Achieved environmental benefits

Reduction of dust emissions to air.

### Cross-media effects

No information submitted.

### Operational data

No other information submitted apart from that included in the 'description' paragraph above. Refer also to data on the emissions of particulate matter included in Table 7.58 and Table 7.59.

### Applicability

To a varying degree, this technique is applicable to all the silicon carbide installations.

### Economics

No data submitted.

### Driving force for implementation

The protection of the environment.

### Example plants

The silicon carbide plants in Arendal and Lillesand, Norway.

The silicon carbide plant in Delfzijl, The Netherlands – for water spraying – see Table 7.57.

### Reference literature

[67, InfoMil - Dutch Authorities, 2004].

## **7.9.4.6 Soil and groundwater protection**

### Description

Apart from storing raw materials indoors and using little or no water, a fluid-retaining measure for the coke storage floor, coke grinding, charge mixing and furnace terrain to prevent soil and groundwater pollution can be applied regarding the traditional furnace set-up.

Regarding the freiland furnace set-up there is:

- a measure retaining fluid for the coke storage floor, coke grinding and charge mixing
- a measure retaining fluid at the bottom of the furnace terrain in combination with a system to collect furnace drainage water, and a groundwater monitoring system
- a fluid tight floor at the desulphurisation unit and at the waste water treatment unit
- a fluid tight foil lining at the bottom of the waste water basins.

### Achieved environmental benefits

The minimisation of solid and liquid wastes from the SiC process operations discharged to soil and groundwaters.

### Cross-media effects

There are no reported disadvantages caused by the implementation of this technique.

Operational data

No other information submitted apart from that included in the ‘description’ paragraph above.

Applicability

To a varying degree, this technique is applicable to all the silicon carbide installations.

Economics

No data submitted.

Driving force for implementation

The protection of the environment.

Example plants

The silicon carbide plant in Delfzijl, The Netherlands – see Table 7.57.

Reference literature

[67, InfoMil - Dutch Authorities, 2004].

## 7.9.5 Best Available Techniques for the manufacture of silicon carbide

For general information on understanding a BAT section and its contents, see Section 7.1.5.

In 2005, silicon carbide was produced using a high temperature chemical reaction of silica (quartz) and carbon (coke, coal and char) in a batch process carried out in electric resistor furnaces, using two different furnace set-ups: the traditional (either indoor or outdoor) and the freiland (outdoor) – see Section 7.9.2.

The freiland set-up might have less environmental impact than the traditional one, as it enables the use of environmental installations (desulphurisation unit, energy recovery plant, waste water treatment plant). However, if the freiland furnace installation is operated without collecting the process gas, this set-up has comparable environmental implications to the traditional set-up.

Dust prevention techniques can be used for the freiland set-up. Dust prevention and dust collection can be used for the traditional set-up when furnaces are indoors.

It is generally believed in the silicon carbide community that for the production of silicon carbide by the freiland furnace, there are some technical feasibilities that generally enable lower emission levels compared to the traditional furnace. These are the already proven possibilities of installing a desulphurisation unit as described in Section 7.9.4.2 and of using an energy recovery unit as described in Section 7.9.4.3.

As the application of BAT differs with respect to the furnace set-ups that are used, BAT conclusions are drawn for the traditional furnace set-up and the freiland set-up respectively, as follows.

### **For the production of silicon carbide based on the traditional furnace set-up, BAT is to:**

1. Design, maintain and properly operate the silicon carbide plant, to save raw materials and energy and reduce the impact of the production of SiC on the environment – see Sections 7.9.2 and 7.9.3.

Note:

Taking the health and safety of workers into consideration is also an important objective.

2. Use silica and pet cokes as raw materials at 2.8 – 2.9 tonnes per tonne of 100 % SiC and 7 – 8 MWh electricity per tonne of 100 % SiC – see Sections 7.9.2 and 7.9.3.5.

3. Use coke with as low a sulphur content as possible, preferably below 1.5 % sulphur on average, and in no case above 2.5 % on average, as a primary measure to minimise the emissions of H<sub>2</sub>S, SO<sub>2</sub> and other S-compounds to air (see Sections 7.9.3.1 and 7.9.4.1).
4. Reduce dust generation and emissions as much as possible by applying a combination of process-integrated measures, end-of-pipe and dust abatement techniques (see Sections 7.9.3.1 and 7.9.4.5), including:
  - usage of long cooling times before breaking down the furnaces
  - rapid quenching of blows by covering the surface of the furnace with charge material
  - application of a fabric filter system or treatment resembling electrostatic filters to reduce dust emissions in the production halls
  - indoor storage of raw materials
  - closed/indoor conveyor belts for the transport of raw materials
  - application of fabric filter systems in coke grinding, charge mixing and refining facilities (to be placed indoors).
5. Limit dust emissions to levels below 13 kg per tonne 100 % SiC— see Section 7.9.3.1.

Note:

The BAT level is reported according to the measurement method used in Norway.

6. Protect soil (and groundwater) by storing raw materials indoors, using little water in all the operations and, if required, by using measures retaining fluid for the floors at the coke storage, coke grinding, charge mixing and furnace terrain, as appropriate (see Sections 7.9.3.3 and 7.9.4.6).

**For the production of silicon carbide based on the freiland furnace set-up, BAT is to:**

1. Design, maintain and properly operate the silicon carbide plant, to save raw materials and energy and reduce the impact of the production of SiC on the environment – see Sections 7.9.2 and 7.9.3.  
Taking into consideration the health and safety of workers is also an important objective.
2. Use silica and pet cokes as raw materials at 2.8 – 2.9 tonnes of raw material and 6.2 - 7.2 MWh electricity per tonne of 100 % SiC – see Sections 7.9.2, 7.9.3.5 and 7.9.4.3.
3. Install gas collecting equipment in order to remove sulphur and recover energy from the gas (see Sections 7.9.4.2 and 7.9.4.3).
4. Reduce SO<sub>2</sub> emissions to air to a range of 6.4 – 11 kg per tonne of 100 % SiC. In the Netherlands, this is reached by applying desulphurisation techniques, including catalytic conversion of COS and CS<sub>2</sub> to H<sub>2</sub>S, followed by the oxidation of H<sub>2</sub>S to elemental sulphur using a chelated iron process (see Sections 7.9.3.1, 7.9.4.1 and 7.9.4.2).

Low sulphur cokes should be used if the range of 6.4 – 11 kg SO<sub>2</sub> per tonne of 100 % SiC cannot be reached.

5. Recover energy from the process gas, to recover approx. 1 MWh energy per tonne of SiC produced, by using a gas combustion and an electricity generation system (see Sections 7.9.3.5 and 7.9.4.3).

6. Reduce dust generation and emissions to air by applying a combination of process-integrated measures, end-of-pipe and dust abatement techniques (see Sections 7.9.3.1 and 7.9.4.5), including:
  - water spraying during breaking down of the furnaces (if using this measure, a closed furnace spraying water circuit and waste water treatment plant should be applied)
  - water spraying of the site ways with mobile spray installation
  - daily sweeping of the site ways
  - indoor storage of raw materials; if coke is stored outside, it should be moistened with spraying water
  - closed/indoor conveyor belts for the transport of raw materials
  - closed systems for coke grinding and charge mixing.
7. Limit dust emissions to levels below 2.5 kg per tonne 100 % SiC – see Sections 7.9.3.1 and 7.9.4.5.

Note:

The BAT level is reported according to the measurement method used in the Netherlands.

8. Protect soil and groundwater using (see Sections 7.9.3.3 and 7.9.4.6) one or a combination of the following techniques:
  - measures retaining fluid for the floor at the coke storage, coke grinding and charge mixing
  - measures retaining fluid at the bottom of the furnace terrain in combination with a system to collect furnace drainage water and a groundwater monitoring system
  - fluid-tight floors at the desulphurisation unit and waste water treatment unit
  - fluid-tight foil at the bottom of waste water basins.

## 7.10 Zeolites

### 7.10.1 General information

#### 7.10.1.1 Introduction

Zeolites are natural or synthetic aluminosilicates (predominantly) of sodium, but also potassium, calcium, magnesium, and other cations with an open three-dimensional crystal structure, in which water molecules are held in cavities within the lattice. Synthetic zeolites are designed for their application. This is carried out thanks to the operating conditions needed to produce the basic sodium silico-aluminate and the finishing operations like ion exchange, precious metals inclusions, acid or thermal treatments, granulation, etc. [6, CEFIC, 2002]. Zeolites find applications in the detergent industry as a sequestering agent for calcium and magnesium, as adsorbers for gases and water (e.g. drying, purification, separation) – for this reason they are often called ‘molecular sieves’, and as a basis for catalysts used in oil refinery, the petrochemical industry and synthesis of intermediate organic products.

Zeolites gained industrial importance in the 1950s when synthetic zeolites became available on an industrial scale. Since then, the world consumption in the fields of ion exchange, adsorption and catalysis has grown continuously. In new zeolites, the aluminium and silicon of the classical zeolites are partly replaced by other elements [58, CEFIC ZEAD-ZEODET, 2004], [87, Ullmann's, 2001].

The consumption of zeolites in the main application sectors: adsorption, detergents, and catalysts determine their production capacity and production. Production volumes of zeolites in Europe in 2002 are given in Table 7.62 below.

Zeolites are chemically differentiated by the Si/Al ratio in their anionic framework. This varies between 1 (in zeolite A) and  $\infty$  in silicalite (an aluminum-free crystalline silica-modification).

Industrially, the most important synthetic zeolite is zeolite A, followed by zeolites X and Y with Si:Al ratios of 1.5:3. The acid resistance and thermal stability of zeolites increase as the Si/Al ratio increases [13, EIPPCB, 2000], [48, W. Buchner et al, 1989].

Due to its worldwide use as a detergent builder, Zeolite A – its chemical formula being:  $\text{Na}_{12}(\text{AlO}_2)_{12}(\text{SiO}_2)_{12} \cdot 27 \text{H}_2\text{O}$  – is produced in the greatest volume and is by far the most important single product of the large and rapidly growing molecular sieve family [13, EIPPCB, 2000].

Raw materials are a sodium silicate solution and a sodium aluminate solution, prepared by aluminium hydroxide dissolving in caustic soda. The reaction is usually operated in a stirred reactor where the zeolite gel is precipitated. This gel is further washed and filtered. The zeolite is either dried and shipped as a solid, or brought into suspension and sold as such, or shipped in both forms [6, CEFIC, 2002].

Many detergent manufacturers prefer zeolite slurry instead of a zeolite powder. Water and suspension stabiliser, which prevents rapid sedimentation, are in this case added to the filtered zeolite. Otherwise, the zeolite is spray-dried [13, EIPPCB, 2000].

Variations in the reaction conditions (ratio  $\text{SiO}_2/\text{Na}_2\text{O}$ , reaction temperature, residence time, stirring intensity, etc.) lead to other types of zeolites, e.g. zeolite Y or zeolite ZSM-5 used largely to produce catalysts (isomerisation, alkylation, etc.) [6, CEFIC, 2002].

Air emissions are an issue when dry zeolites are produced, and dust emissions in the vent streams from the dryer, and from further handling, have to be considered. Emissions to water are negligible: usually the mother liquor and wash-water are concentrated; the evaporated water is practically free of pollutant, while the remaining part containing the salts is recycled into the reactor. The generation of wastes is negligible [6, CEFIC, 2002].

### 7.10.1.2 Product identity

Zeolites are crystalline, hydrated aluminosilicates with a framework structure, composed of silica ( $\text{SiO}_2$ ) and alumina ( $\text{Al}_2\text{O}_3$ ) in various proportions plus metallic oxides. They are produced by hydrothermal treatment of a solid aluminosilicate or of a gel obtained by the reaction of sodium hydroxide, alumina hydrate and sodium silicate. The product obtained initially or a naturally occurring analog, may be partially ion-exchanged to introduce other cations. Specific zeolites are identified by notations indicating their crystal structure and their predominant cation, e.g. KA, CaX, NaY [58, CEFIC ZEAD-ZEODET, 2004].

### 7.10.1.3 Physical and chemical properties

#### 7.10.1.3.1 Physical properties

Most of the physico-chemical properties of zeolite are essentially determined by the aluminium content of their framework [58, CEFIC ZEAD-ZEODET, 2004] as given in Table 7.61.

Type	Formula	Pore Size (Å)	$\text{SiO}_2/\text{Al}_2\text{O}_3$ (molar ratio)
Zeolite A	$\text{Na}_{12} \{(\text{AlO}_2)_{12}(\text{SiO}_2)_{12}\} 27 \text{H}_2\text{O}$	4.1	2.0 – 2.5
Zeolite X	$\text{Na}_{86} \{(\text{AlO}_2)_{86}(\text{SiO}_2)_{106}\} 264 \text{H}_2\text{O}$	7.4	2.0 – 3.0
Zeolite Y	$\text{Na}_{56} \{(\text{AlO}_2)_{56}(\text{SiO}_2)_{136}\} 250 \text{H}_2\text{O}$	7.4	3.0 – 5.5
Zeolite L	$\text{K}_9 \{(\text{AlO}_2)_9(\text{SiO}_2)_{27}\} 22 \text{H}_2\text{O}$	7.1	6.0 – 10.0
Zeolite P	$\text{Na}_6 \{(\text{AlO}_2)_6(\text{SiO}_2)_6\} 15 \text{H}_2\text{O}$	3.1 x 4.5 2.8 x 0.48	2.0 – 5.0
Mordenit	$\text{Na}_{8.7} \{(\text{AlO}_2)_{8.7}(\text{SiO}_2)_{39.3}\} 24 \text{H}_2\text{O}$	6.7 x 7.0	8.0 – 10.0
ZSM 5	$\text{Na}_{0.3} \text{H}_{3.8} \{(\text{AlO}_2)_{4.1}(\text{SiO}_2)_{91.9}\}$	5.4 x 5.5 5.1 x 5.5	30 – ∞
ZSM 11	$\text{Na}_{0.1} \text{H}_{1.7} \{(\text{AlO}_2)_{1.8}(\text{SiO}_2)_{94.2}\}$	5.1 x 5.5 5.1 x 5.5	25 – ∞

**Table 7.61: Physical and chemical properties of different types of zeolites [58, CEFIC ZEAD-ZEODET, 2004]**

Synthetic zeolites containing alkali (sodium) metal are normally colourless crystalline powders. Colours occur if the zeolites contain transition metals by ion exchange or impurities. The primary particle of synthesised zeolites have an average size of 0.1 to 15  $\mu\text{m}$ . The single crystal often forms large aggregates. When heated, hydrated zeolites release water.

Many zeolites can be almost completely freed of adsorbed water without damaging the crystal structure. This activation is normally carried out at 400 to 700 °C. The free pore volumes are then available for the adsorption of guest molecules. In spite of their open structure, the zeolites have good thermal stability.

#### 7.10.1.3.2 Chemical properties

Strong acids decompose low silica zeolites such as zeolite A and zeolite Y by dissolving the aluminium atoms out of the framework with the consequent breakdown of the crystal structure. With an increasing  $\text{SiO}_2/\text{Al}_2\text{O}_3$  ratio, the zeolite becomes less sensitive, but high silica zeolites are structurally stable even in strong acids. However, the ion-exchange capacity of zeolites decreases with an increasing  $\text{SiO}_2/\text{Al}_2\text{O}_3$  ratio.



### 7.10.1.4 Production amounts

The main use of zeolites initially was adsorption, whereas detergent builders now represent the largest application quantitatively. In Western Europe, zeolites have replaced phosphates as detergent builders.

Production volumes for European CEFIC members in 2002, split to different types of zeolites, are given in Table 7.62.

Zeolite type	Production (tonnes per year)
A Zeolite	500000
Y Zeolite	75000
X Zeolite	Not published
Specialities	Not published

**Table 7.62: Zeolites production volumes in 2002 for European CEFIC members [58, CEFIC ZEAD-ZEODET, 2004]**

### 7.10.1.5 Product applications

Zeolites can be used for a large number of different applications. The uses can be grouped into:

- ion exchange
- adsorption
- catalysis
- other applications.

#### 7.10.1.5.1 Ion exchange

The largest production quantities of synthetic zeolites (A zeolites) are used as ion exchange in detergents. The function of zeolite A, as the detergent builder, is to exchange  $\text{Ca}^{2+}$  and  $\text{Mg}^{2+}$  ions from the washing water with  $\text{Na}^+$  ions from the zeolite to avoid precipitation of primary calcium salts. In addition, the zeolite adsorbs metal ions and, therefore, supports the bleaching effect of the detergent composition.

#### 7.10.1.5.2 Adsorption

Zeolites are important adsorbents with a wide range of use. Besides the highest adsorption capacity, zeolites also show great selectivity, which is an important part of the zeolite design and production process. In general, adsorption technology is split into the so-called static and dynamic applications.

Examples for the static applications are:

- insulating glass
- coolant cycles
- non-cellular polyurethane systems.

Examples for the dynamic applications are:

- dynamic water adsorption processes including drying of natural gas, cracked gas, organic solvents and air
- purification of air and gases (A and X zeolites)
- separation of substances.

### 7.10.1.5.3 Catalysis

Zeolite catalysts are used in different fields of technology: oil-refining (FCC process/hydro cracking), petrochemistry and synthesis of organic intermediates, environmental protection.

### 7.10.1.5.4 Other applications

- carrier or reservoirs for reactive substances
- anti-cracking agent
- anti-caking agent in food
- additive to plastics
- additive to cosmetics.

## 7.10.2 Applied processes and techniques

The production processes for zeolites can be divided into the following operations:

- raw material storage
- synthesis
- washing solid, liquid filtration
- stabilisation
- granulation
- drying and activation
- storage.

### 7.10.2.1 Raw materials

Raw materials for the production of synthetic zeolites are aqueous alkali metal silicate solutions (e.g. water glass) and aluminate (e.g. sodium aluminate) or aluminium hydroxide and sodium hydroxide solution. Syntheses with other raw materials are also undertaken but these are of minor importance.

#### 7.10.2.1.1 Water glass

Water glass ( $\text{Na}_2\text{O} \cdot n \text{SiO}_2$ , where  $n = 2$  to  $4$ ) is an aqueous sodium silicate solution. For more detailed information refer to Section 7.8 and to [58, CEFIC ZEAD-ZEODET, 2004].

#### 7.10.2.1.2 Sodium aluminate

Sodium aluminate ( $\text{AlNaO}_2$ ) is available as a solid or as an aqueous solution. In some cases, sodium aluminate is produced on site using sodium hydroxide solution and aluminium hydroxide.

Sodium aluminate solution is corrosive and causes burns. Its handling requires personal protection equipment such as eye and hand protection and respiratory protection if aerosols or vapours are generated [58, CEFIC ZEAD-ZEODET, 2004].

#### 7.10.2.1.3 Sodium hydroxide solution

Sodium hydroxide solution ( $\text{NaOH}$ ) is available as a solid or as an aqueous solution. It is corrosive and causes severe burns. Its handling requires personal protection equipment equal to that described in Section 7.10.2.1.2 above. Refer also to the BREF on Chlor-Alkali Manufacturing Industry.

### 7.10.2.1.4 Aluminium hydroxide

Aluminium hydroxide  $\{\text{Al}(\text{OH})_3\}$  is a solid substance. It is classified as non-hazardous, although normal precautionary measures for the handling of fine particulate material have to be taken.

### 7.10.2.1.5 Raw materials storage

The liquid raw materials are normally stored in closed steel tanks. Due to the reaction of water glass with sodium aluminate or sodium hydroxide and metals or metal compounds, technical rules (e.g. the rules of the German DECHEMA e.V.) are applied.

## 7.10.2.2 Production process – synthetic zeolites

The synthesis of a single-phase microcrystalline zeolite powder is normally not the final stage of the production process. Other properties are also important. For many applications, the as-synthesised zeolite must be chemically or physically modified by processes such as ion exchange, de-alumination or acid treatment. Finally, for many applications in adsorption or catalysis, shaped products are required which usually contain binders. The manufacturing of zeolites includes more than the actual synthesis which is not a uniformed process but a very individual one, depending on the type and application of the zeolites and consists of a well defined series of individual steps aimed at providing a specific spectrum of tailored processes.

### 7.10.2.2.1 Production of synthetic zeolite A

Two processes are used for the commercial production of detergent zeolites:

- the aluminosilicate hydrogel route
- crystallisation of calcined kaolin clay (of minor importance).

The hydrogel route using sodium aluminate and sodium silicate (water glass) has the greatest importance. In the zeolite production process, sodium silicate and sodium aluminate solution are mixed together resulting in the formation of amorphous sodium aluminosilicate. This material is hydrothermally crystallised to yield zeolite A, and is then further processed either to a slurry or dry powder [58, CEFIC ZEAD-ZEODET, 2004].

A flow diagram of the zeolite A production process is given in Figure 7.34.

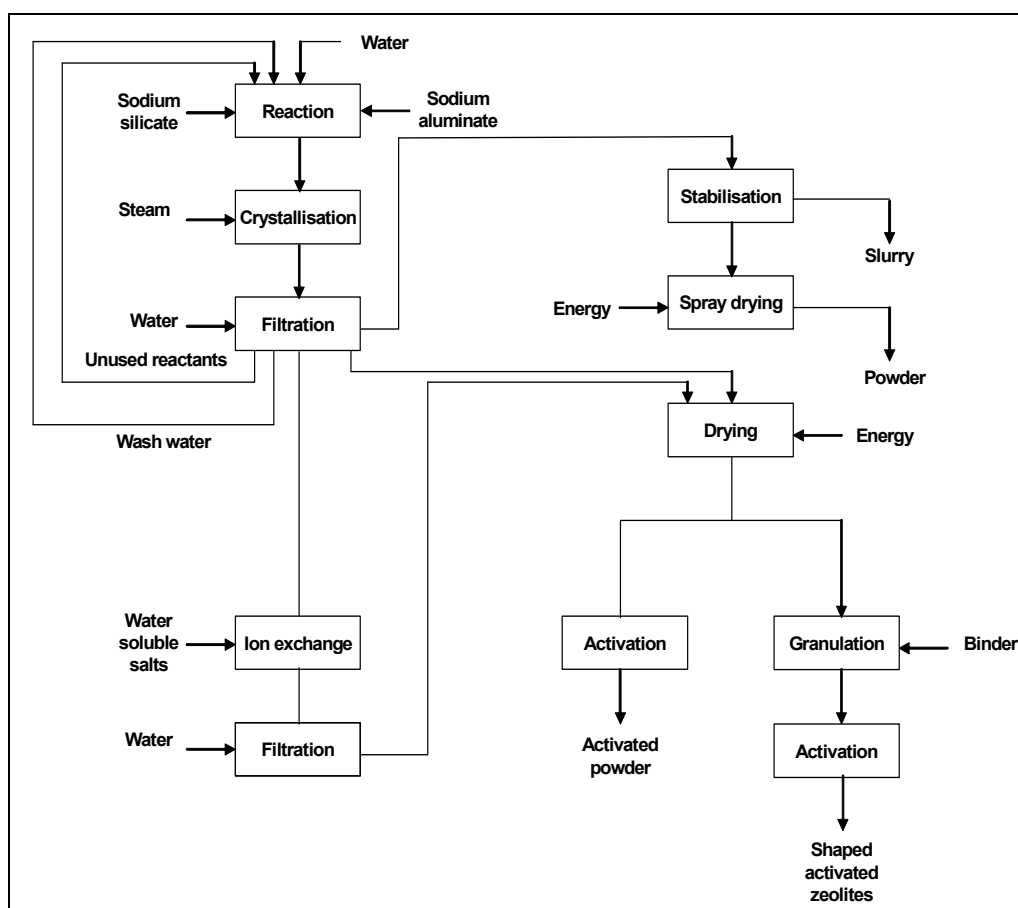


Figure 7.34: Flow diagram of the zeolite A production process [58, CEFIC ZEAD-ZEODET, 2004]

After being processed either by stabilisation and/or spray drying, zeolite A is used as a detergent builder. Additional process steps: drying and activation or drying, granulation and activation, enable the modification of the pore structure of zeolite A, by using different salts to exchange sodium with, e.g. potassium, calcium, lithium, and others. The zeolite is filtered, washed and dried. Depending on its use, the zeolite is shaped by using binders, e.g. natural clay, water glass, etc. or is directly activated as a powder. Typical use of such products is for the application of adsorption.

#### 7.10.2.2.2 Production of synthetic zeolite Y

The commercially available Y zeolites have an  $\text{SiO}_2/\text{Al}_2\text{O}_3$  ratio 5.0 – 5.6. In principle, materials with a higher  $\text{SiO}_2$  content can be produced by direct synthesis. Zeolite Y is used as the basis for the zeolite components of fluid cracking and hydrocracking catalysts.

The raw materials: sodium silicate (water glass) and sodium aluminate, plus a seeding are mixed together. Crystallisation is carried out at temperatures of 85 to 100 °C. The time needed for a well crystallised zeolite Y can amount to 12 – 48 h. In some cases vigorous stirring can lead to the formation of foreign phases. In addition, if the duration of heating is too long, it may cause the formation of the more stable zeolite P [58, CEFIC ZEAD-ZEODET, 2004].

A flow diagram of the zeolite Y production process is given in Figure 7.35.

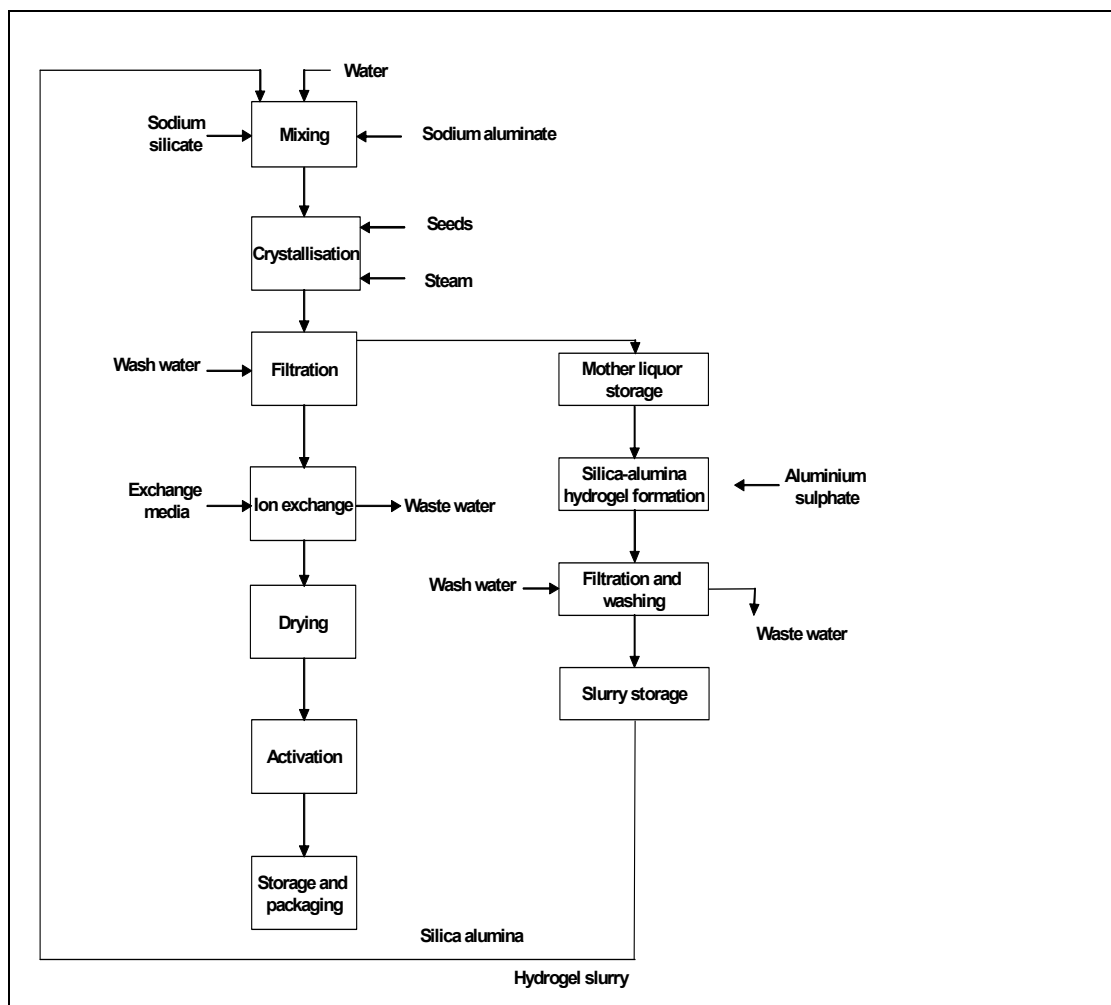


Figure 7.35: Flow diagram of the zeolite Y production process [58, CEFIC ZEAD-ZEODET, 2004]

The ion exchange process must be applied to remove/reduce the sodium content of the zeolite, as the excessive sodium content may harm the performance of the catalyst based on zeolite Y.

#### 7.10.2.2.3 Production processes of other synthetic zeolite forms

The production process of zeolite P is quite similar to that of zeolite Y, while the production process of zeolite X is comparable to that of zeolite A.

Other production processes are of minor industrial importance. One of the examples of such a process is the synthesis of zeolite ZSM 5, which differs from that of zeolite A or zeolite Y, mainly insofar as it is carried out in pressure vessels at 120 to 180 °C. Zeolite ZSM 5 can be crystallised with or without template compounds. The crystal suspension obtained is treated as described for the zeolite A or Y process. If organic template compounds are used, it must be calcined out from the ZSM 5 pores.

In addition to the zeolite ZSM 5, the following zeolites are produced with organic templates: ZSM 11, Offretit, ZK 5,  $\Omega$ , Losod,  $\beta$ , ZSM 34, ZSM 39, FU-1 and Theta-1.

### 7.10.3 Present consumption and emission levels

#### 7.10.3.1 Consumption of raw materials and water

The two main raw materials along with water (for the washing and optional ion-exchange process) are used in the production of synthetic zeolites. These are sodium aluminate and water glass, other various water-soluble salts and binders being of less importance.

The consumption of raw materials and water in the production of zeolites is given in Table 7.63.

	Raw materials used	Consumption t/t zeolite
Zeolite A	Water glass	0.636 (*1)
	Aluminum hydroxide	0.606 (*1)
	Water	19.1
Zeolite P	Water glass	No information
	Sodium aluminate	No information
	Water	No information
Zeolite X	Water glass	No information
	Sodium aluminate	No information
	Water	No information
Zeolite Y	Sodium aluminate	0.480(*1)
	Water glass	0.615(*1)
	Water	<20
*1 – anhydrous form		

**Table 7.63: Raw materials demand for the production of synthetic zeolites [58, CEFIC ZEAD-ZEODET, 2004]**

#### 7.10.3.2 Consumption of energy

The major energy demand results from the drying of zeolites, followed by the (direct) heating during the crystallisation and by the (optional) activation process.

Depending on the technology used for drying and activation (direct natural gas-fired dryers, indirect dryers using hot air), the required energy inputs are provided either by firing processes or by heat exchange using high pressure steam.

The consumption of energy in the production of zeolites is given in Table 7.64.

Energy consumption	GJ/t zeolites
Detergent zeolites A	11.2 to 26.7 <sup>(1)</sup>
Specialities	5.5 to 15.0 <sup>(2)</sup>
1. range is valid for the zeolite slurry and zeolite powder	
2. depending on the type and modification of the zeolite	

**Table 7.64: Energy consumption in zeolites production [58, CEFIC ZEAD-ZEODET, 2004]**

#### 7.10.3.3 Emission levels

##### 7.10.3.3.1 Emission to air

Dust emissions mainly occur during the drying and activation process, but also during the handling of the powders, including natural binders. Emission volumes and the amount of particulates released to the environment are dependent upon the drying and activation technology used. Direct drying and activation processes with natural gas firing, cause additional emission of CO<sub>2</sub>, CO, NO<sub>x</sub> and, in the case of other combustibles (e.g. oil or coal), also SO<sub>2</sub>.

Releases of dust particulates during the production of zeolites are given in Table 7.65.

Particle emission	kg/t zeolites
Zeolite A powders	~ 0.8
Specialties	~ 1.5

**Table 7.65: Releases of dust particulates during the production of zeolites**  
[58, CEFIC ZEAD-ZEODET, 2004]

#### 7.10.3.3.2 Emissions to water

The zeolites produced need to be washed to remove soluble salts and used reactants. The waste water from this process is normally recycled or, after passing through waste water treatment plants, discharged to natural watercourses (rivers, sea).

The amounts of waste water generated during the production of zeolites are given in Table 7.66.

Waste water generation	m <sup>3</sup> /t zeolites
Average	17.7
Lowest	3.6
Highest	28.2

**Table 7.66: Waste water generation during the production of zeolites**  
[58, CEFIC ZEAD-ZEODET, 2004]

#### 7.10.3.3.3 Emission to water from the ion exchange process

In the production of zeolite adsorbents, the most important techniques for increasing or decreasing the apparent pore diameters are those involving ion exchange. Zeolite A pore diameters are modified by the exchange of sodium ions with calcium or potassium ions. Catalytic zeolite Y also needs to be modified by ion exchange. Therefore, apart from the typical emission to water during the production process of synthetic zeolite A or Y, the change of pH and temperature and the emission of solids and salts from the associated ion exchange process should also be taken into consideration.

In most cases, mother liquids are recycled for economic reasons. The use of template compounds in the production of speciality zeolites presents greater problems. The organic compounds are difficult to destroy by oxidation in the mother liquid. Therefore, a two-step programme has been considered. The first step is to minimise the amount of the compounds in the synthesis, and special waste water treatment is required for the second step.

#### 7.10.3.3.4 Solid wastes

Due to the efficient processes employed for the production of zeolite, only very small amounts of solid wastes are generated. Hazardous waste generation is not considered relevant for the production of zeolites and related processes. The recycling of process wastes is carried out where practicable. Recycling of raw materials, water and energy are an integrated part of the zeolite production process and is carried out to reduce both environmental impact and production costs.

#### 7.10.3.4 Other environmental aspects

##### Product recycling

Zeolite products are used as an ingredient for many types of products and preparations. The recovery of zeolites for direct recycling is, therefore, not a viable option.

### Accidental pollution

When chemicals are handled there is always a risk of accidental pollution. Zeolite products, however, are of very low risk and in most cases are classified as non-hazardous to humans and to the environment. In Germany, non-activated zeolites are classified as a danger to water – class 1. Although there are no concerns about the finished products, there are risks associated with the handling of the raw materials. However, these risks are well-known and all companies take appropriate measures to safeguard the handling of these materials.

## 7.10.4 Techniques to consider in the determination of BAT

### Introduction: Techniques to consider in the determination of BAT – refer to Section 7.1.4

The zeolite production process is divided into batch or continuous unit operations. Typical equipment available on the market is used for the individual production steps. In some cases, the equipment has been modified to increase the process efficiency and to meet higher product quality requirements.

The production of synthetic zeolites can be divided into two distinct phases, which are also characterised by different impacts on the environment:

- wet stage process – (waste water generated along with emissions to water)
- dry stage process – (dust and combustion products generated along with emissions to air).

### 7.10.4.1 Wet stage process in the production of synthetic zeolites

#### Description

The wet stage process is essentially the destabilisation of an aqueous solution of sodium silicate by the addition of sodium aluminate to yield a synthetic zeolite. Depending on the ratio of raw materials, pH, temperature, time, and concentration of the reagents, the resulting product is either zeolite A, P, X or Y.

The main environmental impacts from the wet process phase are the mother liquor, wash-water or filtrate generated in the synthesis step and in the ion exchange step. These have the following potential environmental effects:

- aluminium compounds dissolved in water streams
- pH change
- suspended solids (including colloidal silica)
- temperature change
- salts from the ion exchange process.

Water usage and hence the amount of waste water generated is, to a large extent, determined by the required product properties – refer to Figure 7.34 and Figure 7.35.

Prior to drying, the zeolite slurry is concentrated by filtering. Washing and slurry concentration are often carried out in the same process unit, typically in a filter press, drum/disk or belt filter.

All wash-water (containing aluminium compounds and colloidal silica) is discharged into natural watercourses or into the sea.

In the case of the ion exchange process, depending on the ion built into the zeolite, a special waste water pretreatment step is necessary for the removal of critical ions.



### Achieved environmental benefits

A two-step programme is typically used. The first step is to minimise the amount of the compounds in the synthesis of zeolites (recycling), and in the second step, depending on the ion built into the zeolite, a special waste water pretreatment may be considered for the ion exchange process (the removal of organic compounds and critical ions).

### Cross-media effects

No data submitted.

### Operational data

The zeolites produced need to be washed to remove soluble salts and used reactants. The waste water from this process is normally recycled or, after passing through waste water treatment plants, discharged to natural watercourses (rivers, sea). The amounts of waste water generated in the production of zeolites are given in Table 7.66. Apart from the typical emission to water during the production process of synthetic zeolite A or Y, the change of pH and temperature, and the emission of solids and salts from the associated ion exchange process should also be taken into consideration.

### Applicability

To a varying degree, this technique is applicable to the plants producing different types of zeolites, including zeolite A and zeolite Y, and carrying out the ion exchange processes.

### Economics

No data submitted.

### Driving force for implementation

The protection of the environment.

### Example plants

No information submitted.

### Reference literature

[58, CEFIC ZEAD-ZEODET, 2004], [87, Ullmann's, 2001], [13, EIPPCB, 2000], [48, W. Buchner et al, 1989], [6, CEFIC, 2002].

#### **7.10.4.2 Dry stage process in the production of synthetic zeolites**

The slurry of the filter cake from the wet process containing zeolite products, is either: stabilised as a slurry and sold, or used as such, or dried. In the case of speciality zeolites, it is also milled or granulated, activated, and packed in separate dry stage operations.

Mills and granulators for specialities are used to prepare shaped forms (beads) of zeolites to be used in different highly specific applications. For granulation processes, binders, e.g. natural clays or water glass, are used (refer to Figure 7.34).

Dust emissions mainly occur during the drying and activation process, but also during the handling of the powders, including natural binders. Input and output to mills and granulators are handled by airway systems equipped with bag house filters for product recovery and dust extraction. Packaging of powders or beads is typically performed using automatic or manual machines filling paper or plastic bags, big bags or silo containers depending on customer needs.

### Achieved environmental benefits

Reduction of dust emissions to the atmosphere from the drying and activation operations.

### Cross-media effects

Direct drying and activation operations with natural gas firing cause emissions of CO<sub>2</sub>, CO, NO<sub>x</sub> and, in the case of other combustibles (e.g. oil or coal), also SO<sub>2</sub>. No abatement techniques are applied for the emissions of combustion products.

Operational data

Emission volumes and the amount of particulates released to the environment are dependent upon the drying and activation technology used – refer to Table 7.65. For the information on energy demand in the production of zeolites – refer to Table 7.64.

Applicability

To a varying degree, this technique is applicable to the plants producing different types of zeolites, including zeolite A and zeolite Y.

Economics

No data submitted.

Driving force for implementation

The protection of the environment.

Example plants

No information submitted.

Reference literature

[58, CEFIC ZEAD-ZEODET, 2004], [87, Ullmann's, 2001], [13, EIPPCB, 2000], [48, W. Buchner et al, 1989], [6, CEFIC, 2002].

### 7.10.5 Best Available Techniques for the manufacture of zeolites

For general information on understanding a BAT section and its contents, see Section 7.1.5.

Two main groups of zeolites are currently produced in the EU: synthetic zeolite A and synthetic zeolite Y, using similar unit operations (reaction of sodium silicate and sodium aluminate to sodium aluminosilicate, crystallisation to yield zeolite, filtration, ion exchange, zeolite drying and activation, and mother liquor processing and recirculation).

However, from the view point of the impact of the production of synthetic zeolites on the environment, a wet stage process (emissions to water) and a dry stage process (emissions to air) can be distinguished for which separate BAT conclusions are drawn below.

#### **For the wet stage process applied in the production of zeolites, BAT is to:**

1. Optimise the amount of wash-water used for the removal of soluble salts and reactants within the range of 4 – 28 m<sup>3</sup> per tonne of zeolites produced – see Sections 7.10.3.3.2, 7.10.3.3.3 and 7.10.4.1. This must be carried out taking into consideration:
  - on the one hand, the required product properties as against the allowable degree of recycling the mother liquor from the filtration to the reaction stage
  - on the other hand, the content of aluminium compounds and suspended solids (including colloidal silica) in the waste water discharged to the aquatic environment (the first step of waste water treatment applied in the production of synthetic zeolites).
2. Remove organic compounds (difficult to destroy in the mother liquor by oxidation) and salts (dependent on the ions built into the zeolite) from filtrates and waste waters (originating from the ion exchange process) of zeolite plants carrying out the ion exchange process. This must be carried out by using a special waste water pretreatment system as a second step applied for waste water treatment in the production of synthetic zeolites (see Sections 7.10.3.3.3 and 7.10.4.1).

**For the dry stage process applied in the production of zeolites, BAT is to:**

1. Reduce dust emissions to air to below 0.8 kg per tonne of zeolites (and to below 1.5 kg per tonne of speciality zeolites) produced by using dedicated airway systems equipped with bag filters for dust extraction and product recovery from zeolite drying and activation, and final product handling and packaging – see Sections 7.10.3.3.1 and 7.10.4.2.
2. Maintain the consumption of energy in the production of synthetic zeolites in the range between 11 – 27 GJ per tonne of final product (the lower level for zeolite slurry, and the upper level for dried zeolite powder) – see Sections 7.10.3.2 and 7.10.4.2.
3. Maintain the use of energy in the range between 5.5 – 15 GJ per tonne of final speciality product, depending on the type and the required modification of the zeolite to produce speciality zeolites (involving separate dry stage operations: milling, granulation, activation, and packing), – see Sections 7.10.3.2 and 7.10.4.2.

## 7.11 Calcium chloride

### 7.11.1 General information

#### 7.11.1.1 Introduction

Calcium chloride is an inorganic salt and is one of the few soluble calcium compounds. It is produced on an industrial scale as a commodity product, with its down stream uses being geared to its chemical and physical properties.

Chemically, it provides a valuable source of calcium ions ( $\text{Ca}^{2+}$ ) generally used as a source of calcium in 'end-products' or as a means of precipitating various cations or covalent 'salts' as a route to purification or extraction of particular compounds. Examples include the controlled addition of calcium ions for the artificial hardening of water for the brewing industry, the removal of unwanted carbonate or sulphate ions from solution and the precipitation of alginates from seaweed extraction [95, CEFIC-Brunner Mond, 2004].

Calcium chloride is produced in large quantities as a by-product from different chemical processes, e.g. in the Solvay ammonia soda process, the production of magnesium salts from magnesium chloride brine and from the neutralisation of hydrogen chloride.

All use naturally occurring calcium compounds as the source of calcium ions, e.g. limestone or chalk ( $\text{CaCO}_3$ ), dolomite ( $\text{CaCO}_3 \cdot \text{MgCO}_3$ ), etc. In the majority of cases, this represents a valorisation of a waste stream which otherwise has to be disposed of to the natural environment.

However, of the total amount of calcium chloride generated only a small quantity is worked up to pure calcium chloride. As an example [48, W. Buchner et al, 1989], the 1985 US production of calcium chloride was 725 kt (as the dihydrate) and the majority (>80 %) was from natural sources (brines, minerals). There are no known natural calcium chloride brines within the EU-25.

#### 7.11.1.2 $\text{CaCl}_2$ applications

Calcium chloride exhibits a number of key physico-chemical attributes giving it a wide range of applications used in both solution and solid forms.

The following list shows the major applications of calcium chloride, although more exhaustive lists can be found in the literature [79, BIPROK WAS, 1985-1995], [95, CEFIC-Brunner Mond, 2004], [48, W. Buchner et al, 1989]:

- as a dust binder for road consolidation and in mines
- as a defrosting and antifreeze agent, e.g. road de-icing, and cooling brines in refrigeration
- as 'heavy brines' used in oil and gas exploration drilling and work-over fluids
- as a dehydration or drying agent, e.g. drying of moist air in houses
- for soil stabilisation
- as a source of calcium ion in the chemical, water purification and animal feed industries
- several other applications in the mining, chemical, food, and metallurgical industries.

The following list shows the EU-25 range of applications for  $\text{CaCl}_2$  provided by the EU producers (2005 data) [114, CEFIC, 2005]:

- dust binder: 35 %
- road de-icing agent: 25 %
- technical purposes: 25 %
- crude oil production: 15 %

### 7.11.1.3 World calcium chloride market and production potential

Information regarding the total world position on supply and demand for calcium chloride is sketchy and, therefore, potentially inaccurate. The best estimate of the total world market for calcium chloride is about 2.5 million tonnes per year [114, CEFIC, 2005]. Table 7.67 gives an approximation of the split of production between geographic regions and sources of the product.

Production capacity kt per year (as 100 % CaCl <sub>2</sub> )	EU-25	Rest of Europe	North America	Latin America	Asia	Other regions	Total
Solvay ammonia soda	145	400					
Magnesium oxide	50						
Reaction with HCl	135						
Natural brines?	nil						
<b>Total</b>	<b>330</b>	<b>400</b>	<b>1300</b>	<b>40</b>	<b>500</b>	<b>?</b>	<b>2570</b>

**Table 7.67: World calcium chloride market – split by geographic location and production route [95, CEFIC-Brunner Mond, 2004], [114, CEFIC, 2005]**

In turn, the calcium chloride European market by grades produced is given in Table 7.68:

Production capacity kt per year (as 100 % CaCl <sub>2</sub> )	EU-25
Liquors	154
Hydrated solids	153
Anhydrous solids	22
<b>Total</b>	<b>329</b>
Note: Products are differentiated by various quality aspects such as solution concentration, purity, etc. according to their end uses.	

**Table 7.68: Calcium chloride European market by grades produced [95, CEFIC-Brunner Mond, 2004], [114, CEFIC, 2005]**

#### 7.11.1.4 CaCl<sub>2</sub> product grades

Calcium chloride as a marketed product is manufactured in a number of different forms depending upon the individual manufacturing process and end-user requirements. Primarily, the product is sold as an aqueous solution of 30 to 41 % CaCl<sub>2</sub>, or as hydrated or anhydrous solid. The production process may require the solution to be concentrated to 41 % CaCl<sub>2</sub> but, since at this concentration the solution can start to crystallise at ambient temperatures, it may be diluted to avoid this risk.

The major CaCl<sub>2</sub> product grades are listed in Table 7.69:

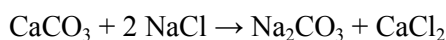
Name	CAS Number	Molecular formula	Molecular weight (g/mol)	CaCl <sub>2</sub> content of common market products (%-wt)
Calcium chloride (anhydrous)	10043-52-4	CaCl <sub>2</sub>	111	>97
Calcium chloride monohydrate	22691-02-7	CaCl <sub>2</sub> ·H <sub>2</sub> O	129	~ 85
Calcium chloride dihydrate	10035-04-8	CaCl <sub>2</sub> ·2H <sub>2</sub> O	147	73 – 81
Calcium chloride tetrahydrate	25094-02-4	CaCl <sub>2</sub> ·4H <sub>2</sub> O	183	58 – 62
Calcium chloride hexahydrate	7774-34-7	CaCl <sub>2</sub> ·6H <sub>2</sub> O	219	~ 50
Calcium chloride solutions	(10043-52-4)	aq. solutions	111	30 – 41

**Table 7.69: Calcium chloride product grades [95, CEFIC-Brunner Mond, 2004], [114, CEFIC, 2005]**

## 7.11.2 Applied production processes

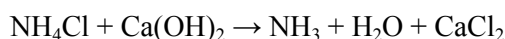
### 7.11.2.1 Co-product of soda ash manufacture

The Solvay ammonia soda process is covered by the global equation:



The detailed process chemistry of this procedure is covered in Chapter 2 of this document.

High purity limestone is decomposed to produce calcium oxide and carbon dioxide, the CO<sub>2</sub> being used to carbonate ammoniated brine to precipitate sodium bicarbonate. The bicarbonate is filtered and decomposed by heating to produce sodium carbonate (soda ash) and the liberated CO<sub>2</sub> is returned to the carbonation stage. However, the filtrate is predominantly ammonium chloride solution and is sent for ammonia recovery. The calcium oxide from the lime-kilns is normally hydrated to 'a milk of lime' slurry (calcium hydroxide) and this reacts with the ammonium chloride rich filtrate to liberate ammonia which is then steam distilled. This leaves behind a calcium chloride solution containing suspended inert material derived from impurities in the limestone, brine and coke ash and some insoluble reaction products obtained during the distillation phase [95, CEFIC-Brunner Mond, 2004]. The overall distillation reaction is:



The liquid stream from the distillers, after the removal of solid matter, is the source material for calcium chloride production, in which a number of purification and concentration steps is used.

#### 7.11.2.1.1 CaCl<sub>2</sub> liquor production from soda ash manufacture

The normal procedures are to maximise the initial strength of the calcium chloride solution by avoiding, as much as possible, any dilution in the earlier stages. Also, to maximise energy efficiency evaporation, technology may include the use of recovered low grade heat from other processes and the use of multi-effect evaporation at a reduced pressure. It is normal in a first stage to evaporate the solution from 10 – 12 % CaCl<sub>2</sub> up to about 41 %. This renders any residual sodium chloride virtually insoluble and also allows for the precipitation of other insoluble calcium salts such as sulphates, carbonates and basic carbonates. These salts are removed by filtration or centrifuging and are returned to the main effluent treatment plant of the soda ash production unit for appropriate disposal. Customers generally require 35 % CaCl<sub>2</sub> liquors to avoid crystallisation problems, so it is usual to dilute the 41 % liquor back to about 35 % for liquor sales [114, CEFIC, 2005].

#### 7.11.2.1.2 Solid CaCl<sub>2</sub> product from soda ash co-production

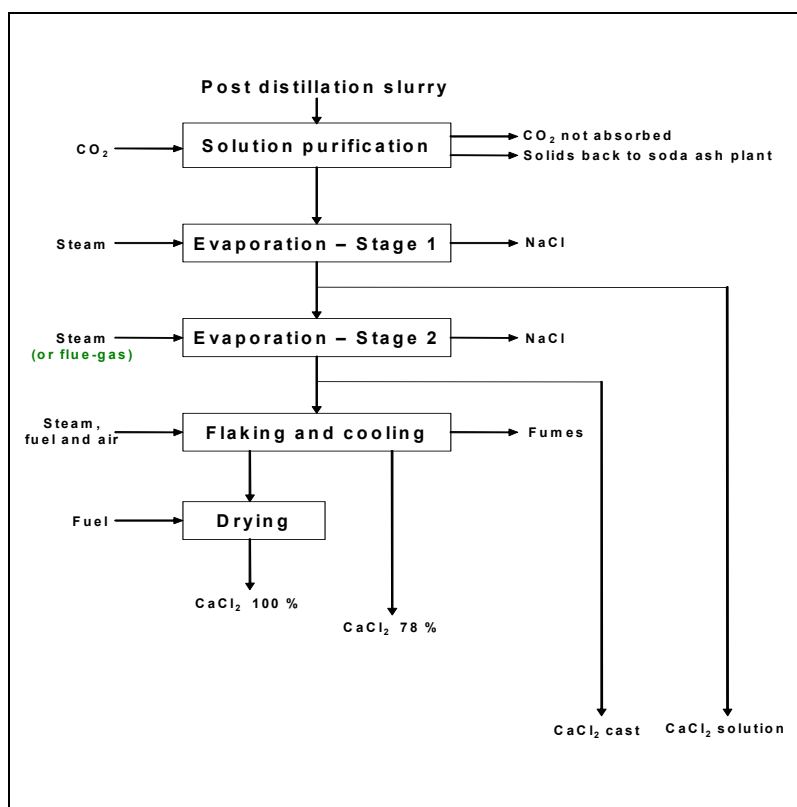
Alternatively, the 41 % liquor may be further evaporated to produce a range of solid products e.g. 77 % and 100 % CaCl<sub>2</sub> (see Table 7.68 and Table 7.69).

The final evaporation of the solution to the concentration of 70 – 72 wt-% CaCl<sub>2</sub> takes place in the second stage steam or flue-gas heated evaporator. The concentrated solution is then sent to a flaking machine, where CaCl<sub>2</sub> flakes are obtained. These then pass to a rotary drum dryer in which calcium chloride flakes are dried by combustion gases generated by burning natural gas. The product is then cooled in a rotary drum cooler, bagged, palletised and sent to storage [79, BIPROK WAS, 1985-1995].

The final calcium chloride product ( $\text{CaCl}_2 \cdot 2 \text{H}_2\text{O} + \text{CaCl}_2 \cdot \text{H}_2\text{O}$ ) in the form of flakes with a sieved size of 3 – 4 mm has a bulk density of 0.8 – 0.9 t/m<sup>3</sup>. Its chemical composition (wt-%) is as follows:

- $\text{CaCl}_2$  76 – 78
- residual Na 0.8 – 1.2
- insolubles in water 0.1 – 0.2.

A simplified process flow diagram of the production of various  $\text{CaCl}_2$  grades (solution, flakes, cast  $\text{CaCl}_2$ ) from soda ash derived calcium chloride is given in Figure 7.36 below. Refer also to Chapter 1, Figure 1.15.



**Figure 7.36: Process flow diagram of the production of various  $\text{CaCl}_2$  grades** [79, BIPROKVAS, 1985-1995], [114, CEFIC, 2005]

The location of a calcium chloride plant is conditioned by the availability of raw materials and technological interconnections, so it may be placed on the site of a soda ash plant.

#### 7.11.2.1.3 Market limitation of $\text{CaCl}_2$ co-produced with soda ash production

The soda ash process produces approximately 1 tonne of  $\text{CaCl}_2$  for every tonne of soda ash made. There are limited  $\text{CO}_2$  emissions from this route since the carbon dioxide produced in lime burning is process gas for soda ash manufacture (refer to Chapter 2). Given the EU-25 production of soda ash by the ammonia soda process of 7.7 million tonnes per year, a similar amount of calcium chloride could theoretically be available via this route [95, CEFIC-Brunner Mond, 2004]. However, the demand for all grades of calcium chloride within the EU-25 is only about 330 kt per year of which only about half is made via the soda ash route.

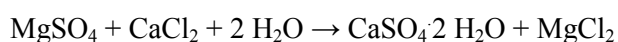
There are only four plants that produce saleable calcium chloride in Europe in association with soda ash manufacture, two of these only produce liquor grades.

### 7.11.2.2 Co-product of magnesium salts production

Calcium chloride is a co-product of magnesia (MgO) production from the raw materials magnesium chloride and dolime. Dolime is calcium-magnesium oxide (MgO.CaO) derived from the burning of dolomite limestone  $\text{MgCO}_3 \cdot \text{CaCO}_3$  – refer to Section 7.7 above.

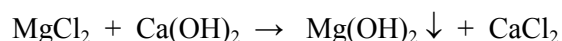
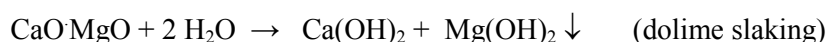
Magnesium salts occur naturally within the halite deposits of the Zechstein Salt Basin of Europe, their occurrence being dependent on the local conditions under which the halite was deposited. Typically, these magnesium chlorides evaporated later in the evaporative process and therefore tend to appear on top of, or on the edges of, other halite deposits (sodium and potassium chlorides). However, the solubility of magnesium chloride is much greater than sodium chloride and in saturated conditions, very little sodium chloride is dissolved in the saturated magnesium chloride brine [95, CEFIC-Brunner Mond, 2004].

After solution mining of the halite deposit to produce a magnesium chloride brine, the first step is to remove any sulphate ions by the addition of calcium chloride:



This is essentially brine purification.

The other raw material for this magnesia production process is, i.e. burnt dolomite (CaO.MgO) so-called ‘dolime’ Dolime introduces a second source of magnesium oxide and considerably increases the yield of the magnesium oxide production. The dolime is slaked with water, which gives an initial precipitation of magnesium hydroxide, and the calcium hydroxide component is then reacted with the purified magnesium chloride brine to produce further magnesium hydroxide and calcium chloride [95, CEFIC-Brunner Mond, 2004], [56, InfoMil, 2004]:



To complete the process, the magnesium hydroxide is washed and calcined to drive off water and produce magnesium oxide.

The by-product calcium chloride (brine of 14 – 16 wt-% concentration) is transported to sea by a dedicated pipeline. The remainder is either used for the brine purification mentioned above or further concentrated for commercial use.

Since 14 – 16 % calcium chloride brine is a by-product of the magnesium oxide production process (refer to the BREF on CL), the only  $\text{CO}_2$  and other environmental contributions to be attributed to the calcium chloride production process, are the aspects of calcium chloride solution concentration and prilling (energy consumption, emissions, etc.).

#### 7.11.2.2.1 Calcium chloride liquor production

The first step in calcium chloride production is the (further) removal of sulphate ions by the addition of barium chloride. Within this process step, barium sulphate is precipitated and removed from the calcium chloride. No additional purification of the calcium chloride brine is necessary due to the high purity of the raw materials.

The desulphated calcium chloride ‘brine’ (14 – 16 wt-%) is further concentrated by means of a mechanical vapour compressor (reboiler). The brine from this stage is then processed using multi-step vacuum evaporation techniques. The calcium chloride brine from the evaporation process is primarily sold as an aqueous solution of 30 – 40 wt-%.



### 7.11.2.2 Calcium chloride solid production

The calcium chloride from the last stage of the evaporation process is then fed into the prilling tower (fluidised bed agglomeration). Within this process, the calcium chloride is spray-dried and granulated into anhydrous solid material (prills).

The following specific advantages of calcium chloride prills (anhydrous  $\text{CaCl}_2$ ) against flaked calcium chloride (76 – 82 wt-%) exist:

- a higher  $\text{CaCl}_2$  content (less transport costs/energy and less storage capacity needed)
- superior free-flowing characteristics: less problems with storage in bunkers (silos) and less dust problems with handling
- higher moisture absorbent capacity per kg dry solid
- higher solubility rate due to porous characteristics of the prills produced
- higher production of heat of solution, required for some special applications.

### 7.11.2.3 Acid-limestone production

A simplified process flow diagram for  $\text{CaCl}_2$  production via the acid-lime neutralisation route is given in Figure 7.37 below.

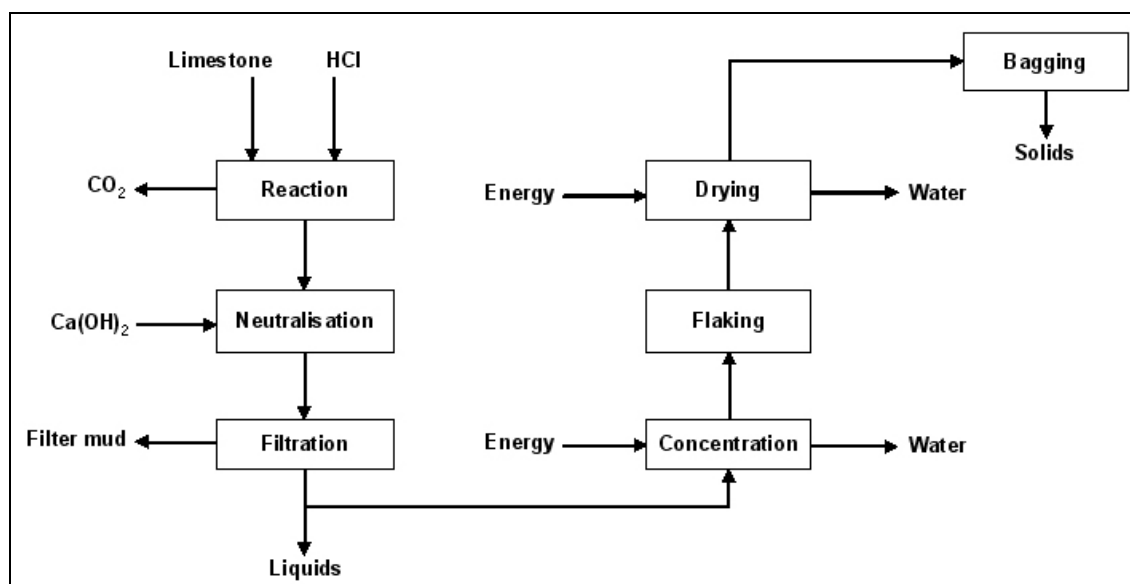
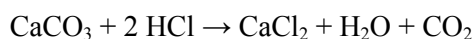


Figure 7.37: Process flow diagram for  $\text{CaCl}_2$  production via the acid-lime neutralisation route [114, CEFIC, 2005]

Probably the most significance (in terms of world production) this route has for calcium chloride is the reaction of HCl with limestone. This may occur as a deliberate direct process or indirectly when the limestone is used in HCl acid fume abatement technology. In both cases, the process goes essentially according to the following reaction equation:



The quality and strength of the solution produced will depend on the purity of the raw materials and the concentration of the acid used.

Therefore, it is of vital importance to use limestone of consistently high quality with low amounts of contaminants such as iron, heavy metals and magnesium.

Usually the  $\text{CaCO}_3$  content of the limestone used should reach a minimum of 98 %, but as a natural product its composition is variable, depending on the individual quality of the quarry representing the geological conditions during formation of the limestone deposit.

The acid should ideally have a concentration of 30–40 % and contain low amounts of contaminants, e.g. with 33 % hydrochloric acid it is possible to produce a calcium chloride solution with a concentration of about 36 %. Further purification is usually done by adding milk of lime ( $\text{Ca(OH)}_2$  slurry). The increase in pH will cause the precipitation of magnesium and also of iron and other metals as their hydroxides. The solid components are removed by filtration.

The carbon dioxide liberated by the process, about 0.4 tonne for every tonne of calcium chloride produced according to the chemical equation, may either be cleaned to remove HCl and aerosols by scrubbing with water and exhausted into the atmosphere or may be compressed and further condensed to its liquid state to be used in various applications. This further improves the economy and raw material utilisation in the process.

Liquor produced via this route may be used in the production of flakes or prills as described in Section 7.11.2.1.2 and 7.11.2.2.2 respectively.

#### 7.11.2.4 $\text{CaCl}_2$ production from natural brines

Calcium chloride occurs ‘naturally’ in a few locations of the world, usually in association with other chlorides including sodium, potassium and magnesium as halite deposits in geological evaporation basins. The halite deposits may also contain iodides and bromides, which are also commercially worked. By careful control of the solution mining processes, it is possible to achieve differential extraction of individual chlorides although calcium and magnesium chloride are inseparable at this stage. In the US mixed magnesium/calcium chloride is produced as 32 to 45 % mixed chloride solutions by initial evaporation of the extracted solution, which normally contains about 25 % total chloride. There are no known naturally occurring deposits of calcium chloride within the EU-25.

### 7.11.3 Environmental impacts and abatement technologies

#### 7.11.3.1 Production via the soda ash or magnesium oxide routes

The process routes to calcium chloride made via the soda ash or magnesium oxide routes are essentially ‘involuntary’ production and the downstream utilisation is, in fact, abatement technology associated with the primary manufacturing processes. The production of saleable  $\text{CaCl}_2$  reduces the direct disposals from these processes and optimises the use of the raw materials. Impurities removed from solutions produced via the soda ash route are normally handled with other effluent streams from the soda ash process. The only other potential impact are those associated with the great amount of energy required to evaporate the initial rather dilute calcium chloride liquor and the mechanisms by which the evaporated water is handled. Some may be lost by the direct emission of evaporated water vapour to the atmosphere, while others will be removed as a condensate, which may be used as a process hot water or may be put directly to drain if there are no appropriate end-users [95, CEFIC-Brunner Mond, 2004], [56, InfoMil, 2004].

For the solid grades, drying technologies include fluid bed or flash dryers, falling film evaporators, prilling towers, etc. In these cases, the most critical potential environmental impact is the emission of dust, which is controlled by normal technologies, cyclones, scrubbers or predominantly dry bag filters (refer also to Section 7.11.2.1.2 above).

### 7.11.3.2 Production via the acid-limestone route

Production of calcium chloride via the acid-limestone route is a direct route to calcium chloride. It can also be regarded as a method for taking care of excess hydrochloric acid from other processes (see Section 7.11.2.3) and hence reduces the direct disposals from these processes. The geographical location of the plant is important and is normally placed close to or directly at the site of a hydrochloric acid production facility. The solid residues, from limestone dissolution and filtration of the liquid calcium chloride consists mainly of sparingly soluble calcium and magnesium salts and the acid-insoluble part of the limestone. The environmental impact of these residues is considered minimal and it can be disposed of at a suitable site. Since a relatively concentrated solution of calcium chloride (30 – 40 %) is produced during limestone digestion, no extra energy is required in this step.

### 7.11.3.3 Present consumption and emission levels

Present consumption and emission levels relating to production processes leading to the production of  $\text{CaCl}_2$  liquors and solid  $\text{CaCl}_2$  products are given below in Table 7.70 through to Table 7.73.

The energy values (GJ) are to be understood as primary energy, all consumption values are for one tonne 100 %  $\text{CaCl}_2$  for all four tables below.

Raw material and energy inputs for the production of  $\text{CaCl}_2$  liquor are given in Table 7.70.

Data/process route	Soda ash	MgO	HCl limestone
<b>Raw materials</b>			
Raw $\text{CaCl}_2$ feed (% $\text{CaCl}_2$ )	10 – 12	14 – 16	Nil
Liquid feed ( $\text{m}^3/\text{t}$ $\text{CaCl}_2$ )	9 – 11.5	6.3 – 7.1	Nil
HCl (100 %) kg/t	0 – 60 †		670 – 735
$\text{CO}_2$ lime kiln gas (40 %) kg/t	0 – 21 †		Nil
Limestone kg/t	Nil		1000 – 1170
$\text{Ca}(\text{OH})_2$ (100 %), kg/t	Nil		14 – 150
<b>Energy consumption</b>			
Thermal energy GJ/t	7 – 9	2 – 3	Nil
Electrical energy GJ/t	0.3 – 0.5	0.4 – 0.5	0.3
Cooling water $\text{m}^3/\text{t}$	40	Not available	Nil
† Usage of $\text{CO}_2$ or HCl depends on the technique used to neutralise residual alkalinity			

**Table 7.70: Raw material and energy inputs for calcium chloride liquor production [114, CEFIC, 2005]**

Energy usages for the production of solid  $\text{CaCl}_2$  from concentrated liquor are given in Table 7.71.

Energy input/finishing operation	76 – 82 % Flake	100% Prills*
Thermal Energy (GJ)	5 – 5.4	7 – 9
Electrical Power (GJ)	0.20 – 0.25	0.6 – 0.8
Cooling Water ( $\text{m}^3$ )	13 – 64	n/a
* Figures for total evaporation from 14 – 16 % $\text{CaCl}_2$ content to 100 % $\text{CaCl}_2$		

**Table 7.71: Energy use for calcium chloride solid production from concentrated liquor [114, CEFIC, 2005]**

Environmental impacts from the production of CaCl<sub>2</sub> liquor are illustrated in Table 7.72.

Environmental impact/process route	Soda ash	MgO	HCl limestone
Solid waste – inert or precipitated calcium salts (kg/t)	10	4 – 6	140 – 280
CO <sub>2</sub> from carbonation (kg/t)	2 – 3	nil	nil
CO <sub>2</sub> from chemical reaction (kg/t)	nil	nil	250 – 400*
Hot cooling water (m <sup>3</sup> /t)	30	n/a	n/a
HCl from chemical reaction (kg/t)			<0.1

\* Emission of CO<sub>2</sub> heavily dependent upon ability to utilise the gas.

**Table 7.72: Environmental impacts from the production of calcium chloride liquor [114, CEFIC, 2005]**

Environmental impacts from the production of solid CaCl<sub>2</sub> chloride are illustrated in Table 7.73.

Environmental impact/process route	Soda ash	MgO	HCl limestone
CO <sub>2</sub> from combustion (kg/t)	40	400 – 500	482 – 723
NO <sub>x</sub> from fuel (mg/Nm <sup>3</sup> )	n/a	70	n/a
Fumes and Cooling Air (Nm <sup>3</sup> )	1100	n/a	n/a
Hot cooling water (m <sup>3</sup> /t)	64	n/a	10 - 30
Dust* (mg/Nm <sup>3</sup> )	n/a	<50	n/a
Dust** (kg/t)	n/a	n/a	0.15 – 0.40

\* Figures for total evaporation from 14 – 16 % CaCl<sub>2</sub> to 100 % CaCl<sub>2</sub>  
 \*\*The deliquescent nature of the dust particles makes them form a solution in a very short period of time. Scrubbers prove to be particularly efficient (close to 100 %) with this type of material.

**Table 7.73: Environmental impacts from the production of solid calcium chloride [114, CEFIC, 2005]**

#### 7.11.4 Techniques to consider in the determination of BAT

**Introduction: Techniques to consider in the determination of BAT – refer to Section 7.1.4**

All the routes used to produce both liquid and solid grades of calcium chloride are essentially an opportunity for the production of a material that would otherwise be disposed of primarily to the aqueous environment. This may be in the form of a weak calcium chloride solution as produced by the ammonia soda process for the production of soda ash or co-production with magnesium oxide production. Alternatively, calcium chloride solutions of saleable concentrations can be produced via the direct action of hydrogen chloride or hydrochloric acid on limestone. Clearly what determines the quantity produced is the size of the available market and this is well below the potential capacity based on the availability of raw material.

##### 7.11.4.1 Production processes for CaCl<sub>2</sub> based on the effluent from the soda ash plant

###### Description

The production of calcium chloride liquors and solid as co-products of the ammonia-soda process are described in Section 7.11.2.1. Therefore, the descriptions below focus on the emissions from this process, as follows:

###### **Gaseous emissions**

Although some water from the early stages of evaporation may be emitted to the atmosphere the majority of the derived steam is condensed through the various stages of multi-effect evaporation. Small amounts of inert gases may be emitted from the final stage evaporator ejectors which provide the vacuum applied to the final evaporator. Substantial amounts of energy are required to produce a solid product from solution due to the evaporation of water.

The use of multi-effect evaporation and heat recovery systems are designed to minimise the total amount of energy used and the consequential associated emission of combustion gases.

The off-gases from the steam-boiler ( $\text{CO}_2$  and  $\text{NO}_x$ ) are directly emitted to the atmosphere, although are not generally considered part of the process.

Flake plants are not prone to dust emissions due to the hygroscopic nature of the product and the virtual 100 % efficiency of water scrubbers on the atmospheric vents.

### **Aqueous emissions**

Waste water from the production of calcium chloride consists mainly of diluted calcium chloride (rinsing water from installations) and condensate. The condensate is normally re-used within the process. The production of calcium chloride gives a direct and significant reduction in the aqueous emission of  $\text{CaCl}_2$  to the aqueous environment.

### **Waste**

Solids separated from the calcium chloride solution are normally processed through the site effluent treatment system, although under certain circumstances small amounts of sodium chloride may be discharged directly to the aqueous environment.

### Achieved environmental benefits

The co-production of  $\text{CaCl}_2$  with soda ash allows for the reduction of the amount of the post-distillation slurry discharged from the production of soda ash and, therefore, mitigates the impact of the combined production on the environment.

### Cross-media effects

Substantial amounts of energy are required to produce  $\text{CaCl}_2$  product in a solid state, and this result in the emissions of combustion products. A part of energy required for concentration of the  $\text{CaCl}_2$  solution can be integrated within the overall balance of energy required for the production of soda ash, in particular, when a given soda ash plant is combined with a CHP unit.

### Operational data

See Table 7.70, Table 7.71, Table 7.72, and Table 7.73 above.

### Applicability

This technique is applicable to the plants producing solid  $\text{CaCl}_2$ , which are integrated with the production of soda ash by the Solvay process – refer to Figure 1.15.

### Economics

The production of  $\text{CaCl}_2$  by this route requires large amounts of energy, this making it very sensitive to any increase of energy prices. Moreover, the market for  $\text{CaCl}_2$  is limited. For these reasons, the number of  $\text{CaCl}_2$  recovery units operating in soda ash plants has progressively decreased.

### Driving force for implementation

The availability of a large amount of very cheap raw material and the possibility to reduce the amount of  $\text{CaCl}_2$  discharged by the soda ash plant.

However, the high energy consumption and limited market restrict the possibility of implementation.

### Example plants

The calcium chloride plants integrated with soda ash plants – one in Poland (Matwy), one in Italy (Rosignano), one in the UK (Winnington) and one in the Netherlands (Delfzijl).

### Reference literature

[79, BIPROK WAS, 1985-1995], [95, CEFIC-Brunner Mond, 2004], [33, CEFIC-ESAPA, 2004], [56, InfoMil, 2004], [114, CEFIC, 2005].

#### 7.11.4.2 Production processes for CaCl<sub>2</sub> based on the MgO route

##### Description

The production of calcium chloride liquors and solid as co-products of the magnesium oxide process are described in Section 7.11.2.2 above. Therefore, the descriptions below focus on the emissions from this process, as follows:

##### *Gaseous emissions*

Substantial amounts of energy are required to produce a solid product from solution due to the evaporation of water.

The most critical environmental impacts are due to the calcium chloride prills production, and the emissions of dust. The off-gases from the prilling tower (containing dust) are scrubbed with calcium chloride brine (which is recycled), to reduce the amount of CaCl<sub>2</sub> dust.

The off gases from the steam boiler (CO<sub>2</sub> and NO<sub>x</sub>) are directly emitted to the atmosphere.

##### *Aqueous emissions*

Waste water from the production of CaCl<sub>2</sub> consists mainly of diluted calcium chloride (rinsing water from installations) and condensate. The condensate is re-used within the magnesia production process. The production of calcium chloride in combination with the magnesia process gives a direct and significant reduction in the aqueous emission of CaCl<sub>2</sub> to the sea. The environmental impact of the emission of calcium chloride to the sea is considered minimal.

##### *Waste*

As described earlier, the solid material consists mainly of barium sulphate, which is partly sold as drilling fluid (drilling for oil and gas). Heavy metal contents in the solid material are negligible. The unsold barium sulphate is disposed of as industrial waste (land filling). The environmental impact of this solid waste is considered minimal.

##### Achieved environmental benefits

Reduction of aqueous emissions of calcium chloride to the sea and reduced emissions of dust from the calcium chloride production process.

##### Cross-media effects

Production avoids some disposal of calcium chloride solution to the sea.

##### Operational data

See Table 7.70, Table 7.71, Table 7.72, and Table 7.73 above.

##### Applicability

The techniques are applicable to plants producing calcium chloride, which are integrated with the production of magnesium oxide from dolime and magnesium chloride brine raw materials – refer to Section 7.7 above.

##### Economics

No data available.

##### Driving force for implementation

Reducing the amount of calcium chloride discharged to the environment.

##### Example plants

The calcium chloride plant integrated with the MgO plant in Veendam, the Netherlands.

##### Reference literature

[56, InfoMil, 2004]

### 7.11.4.3 Production processes for CaCl<sub>2</sub> via the acid-limestone route

#### Description

Production processes for CaCl<sub>2</sub> via the acid-limestone route are described in Section 7.11.2.3.

#### *Gaseous emissions*

The off-gas from the chemical reaction step may be emitted into the atmosphere either directly or after scrubbing with water to remove HCl and aerosols. If suitable co-installations exist at the production site, the off-gas may be subsequently compressed and some of the CO<sub>2</sub> condensed to its liquid state to be used further in various applications. Substantial amounts of energy are required to produce a solid CaCl<sub>2</sub> product from solution due to the evaporation of water. The most critical environmental impact due to the calcium chloride flakes production is the emission of dust. The off-gases from the flake dryers are scrubbed with calcium chloride brine (which is recycled), to reduce the amount of calcium chloride dust.

The off-gases from the steam boiler (CO<sub>2</sub> and NO<sub>x</sub>) are directly emitted to the atmosphere.

#### *Aqueous emissions*

Small amounts of intermediate wash-waters consist of diluted CaCl<sub>2</sub> solution (rinsing water from installations) and diluted hydrochloric acid from off-gas scrubbing systems. Wash-waters may be re-used within the production process, directed to a common effluent treatment plant or discharged directly to the aqueous environment if a suitable receptor is available.

#### *Waste*

The solid waste generated in the process consists mainly of acid-insoluble residues and precipitated calcium and magnesium salts such as Ca(OH)<sub>2</sub>, Mg(OH)<sub>2</sub> and CaSO<sub>4</sub>. The heavy metal content in the solid material is negligible. Solid waste is usually dewatered and is deposited at an approved site, e.g. re-used as inert material for landfill or underground working.

#### Achieved environmental benefits

Reduction of carbon dioxide emissions at locations with possibilities of subsequent CO<sub>2</sub> utilisation. Reduction of HCl emissions. Minimising amounts of waste water and solid waste some of which may be re-used as inert fill in certain applications.

#### Cross-media effects

Economic use and abatement of the by-product hydrochloric acid. Transport of limestone from quarry to production site.

#### Operational data

See Table 7.70, Table 7.71, Table 7.72, and Table 7.73 above.

It should be noted that in Germany, emissions of HCl into the atmosphere are subject to controls established by 'TA-Luft' which recommends to keep the emission concentration below 30 mg/Nm<sup>3</sup> or the mass flow of HCl below 0.15 kg/h.

#### Applicability

Applicable to all plants using the acid-limestone route.

#### Economics

No data available.

#### Driving force for implementation

Minimising the environmental impact of residual acids by calcium chloride production.

#### Example plants

The calcium chloride plants in Kokkola, Finland and in Frankfurt, Germany.

#### Reference literature

[114, CEFIC, 2005]

### 7.11.5 Best Available Techniques for the manufacture of calcium chloride

For general information on understanding a BAT section and its contents, see Section 7.1.5.

Calcium chloride is produced in the EU using three distinct process routes to  $\text{CaCl}_2$  liquors of a concentration in the range of 30 – 41 %  $\text{CaCl}_2$ , for which BAT conclusions are drawn in parallel, and two process routes to solid  $\text{CaCl}_2$  (flakes and prills), for which BAT conclusions are drawn jointly, as below.

#### **For the production of calcium chloride liquor based on the effluent from the soda ash process, BAT is to:**

Utilise 9 – 11.5 m<sup>3</sup> of the 10 – 12 wt-%  $\text{CaCl}_2$  effluent solution from the manufacture of soda ash by evaporation to make one tonne of  $\text{CaCl}_2$  100 % as saleable  $\text{CaCl}_2$  liquor product, with minimum energy usage in the range of 7.3 – 9.5 GJ per tonne of  $\text{CaCl}_2$  100 % as 41 wt-%  $\text{CaCl}_2$  liquor. This is carried out by recovering low grade heat and using multistep evaporation at reduced pressure (see Sections 7.11.2.1.1, 7.11.3.3 and 7.11.4.1).

#### **For the production of calcium chloride liquor based on the MgO route, BAT is to:**

Utilise 6.3 – 7.1 m<sup>3</sup> of the 14 – 16 wt-%  $\text{CaCl}_2$  solution from the production of magnesium salts by its evaporation to make one tonne of  $\text{CaCl}_2$  100 % as saleable  $\text{CaCl}_2$  liquor product, with minimum energy usage in the range of 2.4 – 3.5 GJ per tonne of  $\text{CaCl}_2$  100 % as 30 – 40 wt-%  $\text{CaCl}_2$  liquor. This is carried out by applying a mechanical vapour compressor (re-boiler), followed by multistep vacuum evaporation techniques (see Sections 7.11.2.2.1, 7.11.3.3 and 7.11.4.2).

#### **For the production of calcium chloride liquor via the acid-limestone route, BAT is to:**

1. Reduce the emissions of hydrogen chloride to air to below 0.1 kg HCl per tonne of  $\text{CaCl}_2$  100 % as 36 wt-%  $\text{CaCl}_2$  liquor product, by scrubbing the reaction off-gas with water to remove HCl and aerosols, thus reducing the emissions of carbon dioxide in all those locations where subsequent utilisation of clean  $\text{CO}_2$  is possible (see Sections 7.11.2.3, 7.11.3.2, 7.11.3.3 and 7.11.4.3).
2. Reduce the discharge of solid waste (inert or precipitated calcium and magnesium salts) from the process to land to 140 – 280 kg per tonne of  $\text{CaCl}_2$  100 % as 36 wt-%  $\text{CaCl}_2$  liquor product, by using high purity raw materials, including a high  $\text{CaCO}_3$  content limestone (preferably not less than 98 %  $\text{CaCO}_3$ ), and a high strength hydrochloric acid (preferably not less than 33 % HCl) – see Sections 7.11.2.3, 7.11.3.2, 7.11.3.3 and 7.11.4.3.

Note that the discharge of solid waste at the upper level of the operational range results in the reduced material efficiency in the process (the lower the limestone quality, the lower the efficiency of limestone and lime usage in the process).

#### **For the production of solid calcium chloride, BAT is to:**

1. Rationalise the consumption of energy in the subsequent unit operations (second stage of  $\text{CaCl}_2$  liquor concentration, followed by either flaking or prilling), depending on the concentration of the  $\text{CaCl}_2$  liquor obtained via one of the three wet process routes available (30 – 41 wt-%  $\text{CaCl}_2$ ). This is carried out by utilising locally available options for saving energy, and by improved process control (see Sections 7.11.2.1.2, 7.11.2.2.2, 7.11.2.3, 7.11.3 and 7.11.4).



2. Reduce dust emissions to air to 0.15 – 0.40 kg CaCl<sub>2</sub> per tonne of solid CaCl<sub>2</sub> product by dedusting off-gases from the flake dryer and the prilling tower, using available abatement techniques, among them efficient scrubbing with calcium chloride brine (which is to be recycled to the process) – see Sections 7.11.2.1.2, 7.11.2.2.2, 7.11.3 and 7.11.4.

## 7.12 Precipitated calcium carbonate

### 7.12.1 General information

#### 7.12.1.1 Product

PCC stands for Precipitated Calcium Carbonate (also known as purified or refined calcium carbonate). It has the same chemical formula ( $\text{CaCO}_3$ ) as other types of calcium carbonate. PCC is produced by combining carbon dioxide ( $\text{CO}_2$ ) with lime ( $\text{CaO}$ ) based on a stoichiometric reaction under carefully controlled conditions. PCC is sometimes compared to Ground Calcium Carbonate (GCC). The main differences between PCC and GCC are:

- higher purity of PCC
- control of PCC crystal morphology
- finer PCC crystallites (in the nanometre range)
- particles (down to some hundredths of a micron)
- control of agglomerate dimensions in the PCC product (in the micron range).

The physical and chemical properties of PCC give it outstanding performances in many applications [94, CEFIC-SOLVAY S.A., 2004], [115, CAA-Europe, 2004].

#### 7.12.1.2 Applications

The main applications of PCC are paper, paint, adhesives, sealants, inks, plastics, rubber, healthcare, pharmaceuticals, and many others. PCC is not only a filler but in many cases it significantly improves some characteristics of the product such as: whiteness, UV resistance, abrasivity, rheology, etc. The consumption breakdown of PCC in Europe is presented in Table 7.74.

Application	Per cent of total (%)
Paper	87
Paints and coatings	5
Adhesives and sealants	5
Plastics	2
Cosmetics	<1
Pharmaceuticals	<1
Others	<1
Total	100 %

**Table 7.74: Consumption breakdown of PCC in Europe (reference year: 2002)**  
[94, CEFIC-SOLVAY S.A., 2004]

For some applications (adhesives, sealants, inks, plastics, etc.), PCC can be coated with organic or inorganic molecules. PCC can be delivered as dry powder (bags or bulk) or slurry. Slurry is common in the paper industry – see Figure 7.38 below.

#### 7.12.1.3 Production process

The process described here is the most common way to produce PCC, by the reaction of calcium hydroxide ( $\text{Ca}(\text{OH})_2$ ) with carbon dioxide ( $\text{CO}_2$ ). Some other ways may be used [94, CEFIC-SOLVAY S.A., 2004], such as:

- reaction between calcium chloride ( $\text{CaCl}_2$ ) and sodium carbonate ( $\text{Na}_2\text{CO}_3$ )
- reaction between calcium hydroxide and sodium carbonate.

Reference should also be made here to the process of recycled mineral filler precipitated calcium carbonate (RMF PCC) described in the BREF on the Pulp and Paper Industry (PP).

### 7.12.1.4 Plant locations

PCC is produced by a crystallisation route, therefore the quality of raw materials is crucial, as some chemical impurities (even at a low level) may modify the morphology of crystallites.

As a consequence, PCC plants can be located close to high quality lime (or limestone) sources, which are usually also linked to the cement and lime industry. The plants can be linked to other factories from which they use part of the exhaust CO<sub>2</sub> (power plant, paper mill, soda ash plant). In such a case, the other raw material is lime or milk of lime, delivered by one or a few suppliers.

The selection of the location for a PCC plant is based on many considerations varying from product delivery methods, customer's requirements, raw materials sourcing, customers portfolio, infrastructure needs, etc. [115, CAA-Europe, 2004].

PCC plants can be broadly divided into two groups: those serving one or a few customers (a PCC satellite plant), and those serving many customers (a merchant PCC plant).

In the PCC for the paper industry, it is very common to locate the PCC manufacturing plant at the customer site (PCC 'satellite' concept), where the PCC product is delivered in a form of slurry via pipeline, while waste flue-gas from the customer process is used as feedstock for the PCC plant, and where, in most cases, customer's infrastructure can meet the demand for utilities required by the PCC plant without substantial modifications done at the site. In such a case, the only transport requirement left, is to source the lime [115, CAA-Europe, 2004].

In the case of 'merchant' PCC plants, location is often driven by the customer proximity requirement, as well as the need to secure a good quality source of raw materials: lime and CO<sub>2</sub>. If CO<sub>2</sub> is not available, limestone with an appropriate quality for PCC production is calcined in a kiln to obtain lime and CO<sub>2</sub> (see the BREF on CL). In such a case, the kiln must be specially operated to produce lime suitable for PCC production [94, CEFIC-SOLVAY S.A., 2004].

For a better understanding of possible interlinkages in the production of PCC, refer to Figure 7.38 below, in which lime and CO<sub>2</sub> are indicated as main raw materials used, limestone burning being illustrated as a process option, with the lime kiln included in the process flow diagram for the manufacture of PCC, but situated outside of the scope of the BREF on LVIC-S.

For information on lime production from limestone, refer to the BREF on Cement and Lime Manufacturing Industries (CL) [94, CEFIC-SOLVAY S.A., 2004], [115, CAA-Europe, 2004].

### 7.12.1.5 Production capacity in the world and in Europe

#### 7.12.1.5.1 PCC production capacity by main world regions

The production capacity of PCC by main world regions in kt per year is given in Table 7.75 below (reference year: 2002).

US	EU-25	Japan	Rest of the world	Total
2500	2600	1000	2000	8100

**Table 7.75: Production capacity of PCC by main world regions**  
[94, CEFIC-SOLVAY S.A., 2004]

The production capacity of PCC in other regions of the world, including non-EU-25 East European countries, North America (Canada, Mexico), Asia, South America, Africa and Australia/Oceania has been estimated at 2000 kt per year.

## 7.12.1.5.2 Production capacity of PCC in the European Union

The production capacity of PCC in the EU-25 is given in Table 7.76 (reference year: 2003).

Producers	Country	Location	Capacity		Type of PCC
			kt per year	%	
	Finland	Imatra			Slurry
	Finland	Kemi			Slurry
	Finland	Kuusankosi			Slurry
	France	Etival Clairefontaine			Slurry
	Portugal	Setubal			Slurry
	Sweden	Nymölla			Slurry
	Sweden	Lessebo			Slurry
<b>Producer A</b>		<b>Subtotal</b>	<b>550</b>	<b>21.0</b>	
	Austria	Golling			Slurry
	Hungary	Szolnok			Slurry
	Netherlands	Moerdijk			Slurry
	Portugal	Fatima			Slurry
	Spain	Hernani			Slurry
<b>Producer B</b>		<b>Subtotal</b>	<b>555</b>	<b>21.2</b>	
	Austria	Wattens			Slurry
	Germany	Hahnstätten			Dry
	Germany	Neidenfels			Slurry
<b>Producer C</b>		<b>Subtotal</b>	<b>88</b>	<b>3.3</b>	
	Austria	Ebensee			Dry
	UK	Lostock			Dry
	France	Giraud			Dry
	France	Quimperlé			Slurry
	Germany	Rheinberg			Dry-slurry
	Italy	Angera			Dry
<b>Producer D</b>		<b>Subtotal</b>	<b>224</b>	<b>8.5</b>	
	Belgium	Hermalle sous Huy			Dry-slurry
	UK	Lifford			Dry
	Finland	Äänekoski			Slurry
	Finland	Anjalankoski			Slurry
	Finland	Lappeenranta			Slurry
	Finland	Tervakoski			Slurry
	France	Saillat			Slurry
	France	Docelles			Slurry
	France	Alizay			Slurry
	Germany	Schongau			Slurry
	Germany	Walsum			Slurry
	Poland	Kwidzyn			Slurry
	Portugal	Figueira da Foz			Slurry
	Slovakia	Ruzomberok			Slurry
<b>Producer E</b>		<b>Subtotal</b>	<b>1100</b>	<b>42.0</b>	
	Spain	Argelaguer			Dry
	Germany	Leuna			Dry
	France	Caffiers			Dry
	Poland	Janikowo			Dry
	Poland	Inowroclaw			Dry
	UK	Brassington			Dry
	Spain	Revilla de Camargo			Dry
<b>Other Producers</b>		<b>Subtotal</b>	<b>105</b>	<b>4.0</b>	
<b>Total</b>			<b>2622</b>	<b>100</b>	

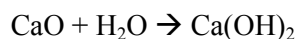
Table 7.76: EU-25 PCC capacity and producers (reference year: 2003)  
[94, CEFIC-SOLVAY S.A., 2004], [115, CAA-Europe, 2004]

In total there are 12 producers of PCC identified in the EU-25 area, carrying out their operations in 42 locations in 14 Member States, including Poland, Hungary and Slovakia. The total PCC capacity in the EU-25 area is slightly over 2600 kt per year [94, CEFIC-SOLVAY S.A., 2004], [115, CAA-Europe, 2004].

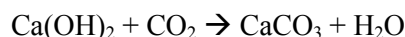
### 7.12.2 Process description

The most common way to produce PCC is by the stoichiometric reaction of calcium hydroxide with carbon dioxide. In the process illustrated in Figure 7.38 below [115, CAA-Europe, 2004], CO<sub>2</sub> emissions from an adjacent waste stream is recovered to react with hydrated lime in the form of a slurry for the synthesis of PCC. In the case of a waste stream not being available, liquid CO<sub>2</sub> or lime kiln exhaust gas can be used – in this latter case, refer to the BREF on CL. It should be noted that this document does not cover issues concerning the flue-gas source or any other CO<sub>2</sub> production method, as those are not part of the PCC process.

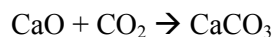
The first step of the PCC production process is the slaking of the lime, which is hydration of quick lime (reaction of lime with water), as per the following reaction. The slaking process is often a continuous process, but can be a batch process as well.



The second step of the process is carbonation, or precipitation of CaCO<sub>3</sub> from milk of lime and CO<sub>2</sub>. Carbonation is usually a discontinuous process. In this step, the recovered flue-gas (or lime kiln exhaust gas or gaseous CO<sub>2</sub> derived from another source) is put in contact with the milk of lime, which results in the crystallisation of calcium carbonate.



Thus, the overall stoichiometric reaction is:



PCC characteristics are controlled by:

- temperature (milk of lime may be cooled or heated before carbonation)
- CO<sub>2</sub> concentration and flowrate
- agitation level
- particle size, impurities and concentration of the hydrated lime slurry
- additives.

In the case of the PCC ‘satellite’ concept, this generally completes the process as the PCC product is delivered to the customer in a form of slurry by pipeline and is ready for use directly from the crystallisation process.

The following steps are generally continuous and are all (or a combination of them) used to meet either specific customers’ requirements or to reduce the quantity of water for off-site deliveries:

- coating (for some PCC grades)
- dewatering of the PCC slurry
- dispersion
- drying
- grinding
- packaging.

The equipment used in these processing steps is designed taking into account the final PCC characteristics, such as:

- some grades are fragile (risk of crystals or agglomerates breakage)
- some grades are heat sensitive.

Also, several stages of separation are included to remove the impurities:

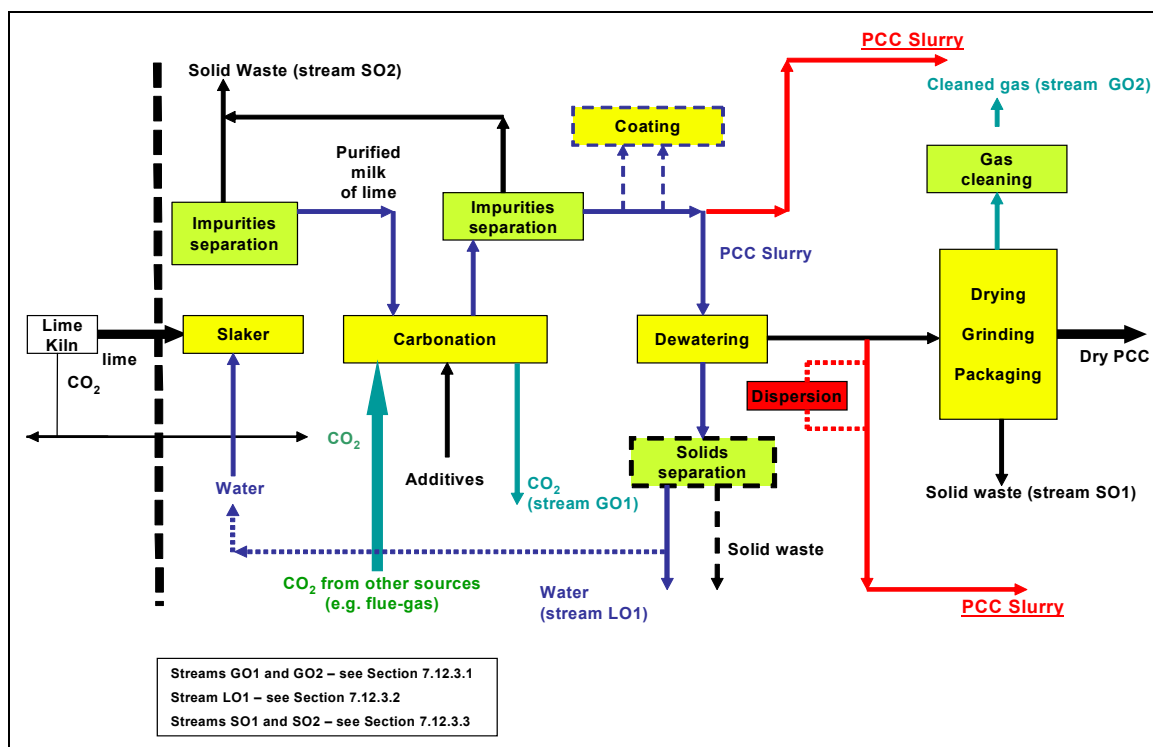
- separation of solid impurities from the milk of lime (sieves, hydrocyclones)
- separation of solid impurities (grit) from the PCC slurry
- scrubbing of flue-gas.

If the PCC plant is not linked to another plant supplying CO<sub>2</sub>, lime and CO<sub>2</sub> are produced by calcination of limestone in lime kilns. More detailed information about lime manufacturing techniques may be found in the BREF on Cement and Lime Manufacturing Industries (CL).



Some loss of CO<sub>2</sub> in the process may have to be compensated by producing an excess of lime.

Figure 7.38 gives a process flow diagram for the manufacture of PCC: the lime kiln (covered in the BREF on CL) and the main PCC process (covered in this document).



**Figure 7.38: Process flow diagram for the manufacture of PCC** [94, CEFIC-SOLVAY S.A., 2004], [115, CAA-Europe, 2004]

### 7.12.3 Present consumption and emission levels

The environmental impacts of lime kilns (or any upstream source supplying other raw material for PCC production) are not considered in this section. The BREF on Cement and Lime Manufacturing Industries (CL), to which reference is made here, provides valuable information about these potential impacts. However, it needs to be noted that special attention must be paid to the purity of CO<sub>2</sub> when operating kilns for PCC production, as it influences the quality of the final PCC product [94, CEFIC-SOLVAY S.A., 2004].

The main environmental issues associated with the production of PCC are: solid waste, dust emission and energy consumption [94, CEFIC-SOLVAY S.A., 2004].

Solid waste mainly consists of calcium carbonate: PCC, calcium oxide or hydroxide, and mineral impurities originating from the lime.

Table 7.77 indicates the major input and output of the process. The values indicated in this table are related to actual PCC grades.

Consumption/emission	per tonne PCC <sup>(*)</sup>	Location in the PCC process	Comment
<b>Main raw material</b>			
Raw lime	600 – 660 kg	Slaking	
CO <sub>2</sub>	500 – 800 kg	Carbonation	(1)
<b>Process water</b>	2 – 10 m <sup>3</sup>	Slaking	(11)
<b>Energy</b>			
Fuel	0 – 7.5 GJ	Carbonation, drying	(2)
Electricity	60 – 500 kWh		(3)
<b>Emission to air</b>			
CO <sub>2</sub> (4)	50 – 350 kg	Carbonation (GO1)	(1)
Dust	Not reported	Drying, grinding, packaging (GO2)	(5)
<b>Emissions to water</b>			
Chemical additives	Little	Dewatering (LO1)	(6)
pH	6.0 – 12.4	Plant effluent	(10)
Suspended solids	1 – 30 kg	Dewatering (LO1)	(7)
<b>Solid wastes</b>			
Fine particles (<100 micron)	<10 kg	Drying, grinding, packaging (SO1)	(8)
Coarse particles (1 mm – 50 mm)	2 – 100 kg	Slaking, carbonation (SO2)	(9)

(1) absorption efficiency can be low for some grades (depending of temperature, milk of lime viscosity, CO<sub>2</sub> flowrate, CO<sub>2</sub> content in the flue-gas, etc.)  
 (2) depending on the carbonation process and dewatering efficiency. Large range of fuel consumption is explained by different configuration of PCC plants. Most of the PCC plants produce PCC as slurry (fuel consumption around a low level; some PCC producers do not use fuel at all), while the PCC plants manufacturing dry PCC product (drying step involved) use much more fuel (fuel consumption around a high level)  
 (3) including CO<sub>2</sub> compression  
 (4) the PCC process is typically a net consumer of CO<sub>2</sub> (the difference between the used and emitted CO<sub>2</sub>). The data do not include CO<sub>2</sub> related to energy consumption (cross-media effect)  
 (5) exhaust gases are filtered or washed  
 (6) additives (low quantities) can be used at the carbonation or coating step. Part of them can remain in water. Depends upon the process used.  
 (7) dewatering devices (filters, centrifuges, etc.) are designed to separate solids properly. In the case of ultrafine PCC production, too many ultrafine particles might remain in water. In this case, settling devices could be installed.  
 (8) out of grade PCC, leakages  
 (9) pieces of uncalcined limestone and sands from milk of lime purification; grids from PCC slurry purification  
 (10) effluent from the PCC plant located at a customer's site is typically discharged to the central waste water treatment plant at the site  
 (11) depending on the local situation, additional quantities of process water may be used.  
 (\*) figures in this table are indicative ranges of annual averages based on various measurements or estimation techniques. Production of new grades (dimensions, shapes, coating, etc.) can have a certain impact on the process and for a change of input and output levels.

**Table 7.77: Major input/output levels in the PCC production process**  
 [94, CEFIC-SOLVAY S.A., 2004], [115, CAA-Europe, 2004]

### 7.12.3.1 Emissions to air

CO<sub>2</sub> emissions come from the carbonation step and the lime kiln (but only in the case of an isolated plant not linked to a factory providing CO<sub>2</sub>). In most cases, however, the PCC process is a net consumer of CO<sub>2</sub>, as it uses the carbon dioxide generated in other industrial activities.

Dust is emitted at different steps of the process (lime receiving, PCC drying, grinding, packaging) and is collected in standard filtering or washing devices (stream GO2 – see Figure 7.38 and Table 7.77). If ammonia is used in the coating step, some diffuse emission to air may also occur.

### 7.12.3.1.1 CO<sub>2</sub> capture in the carbonation step

The CO<sub>2</sub> absorption rate depends on the following parameters:

- milk of lime viscosity
- temperature (also related to particle shapes and dimensions)
- agitation (also related to particle aggregation)
- CO<sub>2</sub> concentration and flowrate (related to PCC quality).

The amount of CO<sub>2</sub> required to make one tonne of PCC is based on the stoichiometry, as 440 kg of CO<sub>2</sub> must react with 740 kg of calcium hydroxide to produce 1000 kg of PCC. While the rate of CO<sub>2</sub> absorption can be changed, the amount of CO<sub>2</sub> absorbed per tonne of PCC cannot. If PCC production is not directly associated with lime kilns, the synthesis of PCC consumes stoichiometric amounts of CO<sub>2</sub> originating from the waste stream of a combustion source.

Therefore, the efficiency of CO<sub>2</sub> absorption in the PCC process has no impact upon the amount of CO<sub>2</sub> emitted to the atmosphere from the original CO<sub>2</sub> source (the combustion process).

### 7.12.3.1.2 CO<sub>2</sub> emissions from the lime kiln

If the lime kiln is included in the PCC plant, CO<sub>2</sub> emission occurs when the kiln production rate is too high compared with CO<sub>2</sub> consumption at the carbonation step. Since the lime kiln works in a continuous regime and carbonation is a discontinuous operation, each carbonation interruption will produce CO<sub>2</sub> emission to air. Therefore, adequate operation and maintenance planning is important – for emission levels relating to a lime kiln refer to the BREF on CL.

### 7.12.3.2 Emissions to water

The main emission to water comes from the dewatering step (stream LO1 – see Figure 7.38 and Table 7.77). Water very often contains part of the additives introduced at the carbonation and the coating steps in order to control or modify PCC characteristics. Water also contains dissolved salts from the hydration of calcium oxide to calcium hydroxide. Recycling of this water at the slaking step significantly impacts the synthesis of PCC. Water recycling is affected by the quality of the original water, raw material quality and product quality requirements.

When producing ultra fine particles, water coming from the dewatering step may contain too much PCC. In this case, water may be filtered or treated in settling devices.

### 7.12.3.3 Solid wastes

The main solid waste which is in the range of 2 – 200 kg per tonne of PCC comes from the slaking and carbonation steps (stream SO2 – see Figure 7.38 and Table 7.77). Some minor part of solid waste is also generated in the step of solids separation, downstream of the step of dewatering the PCC slurry. The secondary part of solid waste comes from drying, grinding and packaging operations (stream SO1 – see Figure 7.38 and Table 7.77). In some cases, the production of out-of-grade PCC may also be the source of quite a significant waste stream.



## 7.12.4 Techniques to consider in the determination of BAT

### Introduction: Techniques to consider in the determination of BAT – refer to Section 7.1.4

PCC is used in a wide range of applications for which very different physical properties may be required (e.g. particle size distributions and morphologies of crystallites and agglomerates). Therefore, the complexity of a PCC plant will depend on the amount of product applications required.

Energy consumption and the amount of waste are also related to PCC quality specifications. In addition, the location of the PCC plant (whether it is located at a customer's or raw material supplier's facility site or off-site) affects the design of the PCC facility. PCC plants located at the site of a customer's or supplier's facility can rely upon the 'host' plant for many environmental services, including water supply, effluent treatment, storm-water control and solid waste management. In future, PCC improvement for current or new applications may imply new production methods [94, CEFIC-SOLVAY S.A., 2004], [115, CAA-Europe, 2004].

### 7.12.4.1 PCC plant design, configuration and operation

#### Description

The following are considerations to be taken into account in PCC plant design, configuration and operation, in order to reduce the amount of solid waste and energy consumption:

- availability of appropriate raw material (lime, CO<sub>2</sub>, water)
- purification of raw materials and intermediate products (the consequence is production of solid waste containing impurities from raw materials such as silica, alumina, etc.)
- production devices adapted for a wide range of PCC grades (wide range of energy consumption).

Some examples are [94, CEFIC-SOLVAY S.A., 2004], [115, CAA-Europe, 2004]:

- milk of lime quality is influenced by lime quality and slaking conditions
- in some applications, PCC properties depend on the aggregation of particles. Dewatering devices are designed to prevent breakage. In this case, dewatering efficiency is not maximised and the energy consumption for drying may be high
- in sealants, inks, and plastics applications, ultra fine PCC particles are required. The production of these small particles may imply the need for:
  - cooling of milk of lime (cooling water usage, and energy for refrigeration when needed)
  - cleaning of carbonation vessels (additional waste generation). In the case of unsuitable seeding, crystallisation will not be under control. In some cases wash-waters can be treated and recycled as such (or, where the PCC plant is part of a larger processing complex, recycled into such operations as production of dry hydrate).
  - improvement of PCC slurry sieving (increased amount of waste)
  - grinding (increased electricity consumption).

#### Achieved environmental benefits

The design, configuration and operation of the PCC plant is carried out as such to reduce the amount of solid waste and energy consumption, thus minimising the impact of the production of precipitated calcium carbonate on the environment.

#### Cross-media effects

This technique does not cause any side-effects or disadvantages. On the contrary, an integrated approach to protecting the environment is taken into consideration from the outset in a well designed PCC plant.

#### Operational data

Refer to data included in Table 7.77 and see Figure 7.38. Refer also to Figure 1.15 and to Chapter 2 of this document.

Applicability

This technique is applicable to the PCC plants producing different grades of the final product in the form of the slurry or the dry product (refer to Table 7.76).

Economics

No data submitted.

Driving force for implementation

High material and energy efficiency in the PCC plant, the protection of the environment, high quality of the PCC product, low manufacturing cost of the production of precipitated calcium carbonate.

Example plants

No specific example plants mentioned. Refer to the list of the PCC plants in the EU-25, given in Table 7.76.

Reference literature

[94, CEFIC-SOLVAY S.A., 2004], [33, CEFIC-ESAPA, 2004], [115, CAA-Europe, 2004]. Refer also to the BREF on Cement and Lime Manufacturing Industries (CL).

**7.12.4.2 Solid waste reduction**Description

When possible, recycling of solid waste is a technique to consider in the determination of BAT, in particular as far as the following waste solid streams are concerned:

- out of grade PCC product (including stream SO1 – see Figure 7.38 and Table 7.77) to be recycled into the PCC process. The recycling rate must be compatible with quality requirements. It may be possible to sell some out-of-grade products at a lower premium
- other solid wastes (in particular stream SO2 – see Figure 7.38 and Table 7.77) to be recycled as raw material as they are still a valuable calcium source. Recycling into the cement or lime industry is the most practicable potential option, in particular when the cement and/or lime plant is located nearby (refer to Section 7.12.1.4 above), however, whether this is practicable will depend upon the type of calcination equipment employed
- another very promising option is to use the solid waste (stream SO2 – see Figure 7.38 and Table 7.77) from the PCC plant as a soil amendment. The high alkalinity of the PCC solid wastes allows this material to be used as a replacement for agricultural lime. However, the technology of lime spreading (even the distribution of particles is a prerequisite for proper lime assimilation in the soil) usually requires the sludges to be incorporated into pellets.

Achieved environmental benefits

The recycling of out-of-grade products to the PCC process and solid waste from the slaker as raw material, preferably to the cement or lime industry, results in the reduction of solid waste from the PCC production.

Cross-media effects

No information submitted.

Operational data

Refer to data included in Table 7.77 and see Figure 7.38. Refer also to Chapter 2 of this document.

Applicability

To a varying degree, this technique is applicable to the PCC plants producing different grades of the final product in the form of the slurry or the dry product (refer to Table 7.76).

Economics

No data submitted.

### Driving force for implementation

High material and energy efficiency in the PCC process and the protection of the environment.

### Example plants

No specific example plants.

### Reference literature

[94, CEFIC-SOLVAY S.A., 2004], [33, CEFIC-ESAPA, 2004], [115, CAA-Europe, 2004].

Refer also to the BREF on Cement and Lime Manufacturing Industries (CL).

### **7.12.4.3 Capture of CO<sub>2</sub> and reduction of CO<sub>2</sub> emissions**

#### Description

The production of the basic raw material (calcium oxide) for the manufacture of PCC, results in the emission of fuel- and calcination-related CO<sub>2</sub>. These emissions are covered in the BREF on Cement and Lime Manufacturing Industries (CL).

The PCC carbonation process uses CO<sub>2</sub> as a raw material. Apart from the case in which the lime kiln is incorporated in the PCC plant (see below), no CO<sub>2</sub> is generated from the PCC carbonation process. The amount of CO<sub>2</sub> required to make one tonne of PCC (440 kg CO<sub>2</sub> per tonne PCC), is based on stoichiometry and it is impossible to change the amount of CO<sub>2</sub> absorbed per tonne of PCC. Each PCC plant produces a finite amount of PCC and thus absorbs a fixed amount of CO<sub>2</sub>, regardless of CO<sub>2</sub> absorption efficiency in the carbonation step.

Two major possibilities are to be considered with regard to increasing the efficiency of CO<sub>2</sub> absorption and, in the case when a PCC plant is associated with a lime kiln, the reduction of CO<sub>2</sub> emissions:

- CO<sub>2</sub> absorption may, in some cases, be increased by improving the agitation efficiency (e.g. impeller design)
- dedicated process control can reduce CO<sub>2</sub> emissions from the gas source (or lime kiln) by applying:
  - automatic start up of discontinuous carbonation
  - automation of the carbonation sequence
  - optimisation of CO<sub>2</sub> production and consumption rate.

#### Achieved environmental benefits

Typically, the PCC process utilises CO<sub>2</sub> (usually from a combustion source such as a paper mill power boiler or calciner) as a raw material. Thus, the PCC process results in a reduction of CO<sub>2</sub> emissions to the atmosphere from the supply source. However, this does not influence the global CO<sub>2</sub> balance, as carbon dioxide evolves elsewhere in the production of CaO necessary for the PCC process.

Environmental benefits can only be achieved in the case when a PCC plant is associated with a lime kiln, and applied are the measures for the reduction of CO<sub>2</sub> emissions are applied, as mentioned in the Description paragraph above.

#### Cross-media effects

When increasing CO<sub>2</sub> absorption by the improved efficiency of the agitation, attention should be paid to the increase of electricity consumption and to the breakage of PCC agglomerates, which may influence the PCC product quality.

#### Operational data

Refer to data included in Table 7.77 and see Figure 7.38. Refer also to Chapter 2 of this document.

Applicability

To a varying degree, the measures included in this technique are applicable to the PCC plants producing different grades of the final precipitated calcium carbonate product in the form of the slurry or the dry product (refer to Table 7.76).

Economics

No data submitted.

Driving force for implementation

High degree of the utilisation of the CO<sub>2</sub> gas in the PCC process and the protection of the environment.

Example plants

No specific example plants.

Reference literature

[94, CEFIC-SOLVAY S.A., 2004], [33, CEFIC-ESAPA, 2004], [115, CAA-Europe, 2004].  
Refer also to the BREF on Cement and Lime Manufacturing Industries (CL).

**7.12.4.4 Emissions to water**Description

Effluents from a PCC plant may only be part of the liquid effluents released from a soda ash plant or an associated industrial chemical complex. In such a case, effluents from a PCC plant are normally collected and treated in the waste water treatment system common for the chemical complex in question. If the PCC plant is isolated, the content of suspended solids in the aqueous effluent may be decreased by using settling systems.

Achieved environmental benefits

Proper treatment of the liquid effluents released from the PCC plant, either in an integrated or an isolated waste water treatment system, reduces the impact of the production of precipitated calcium carbonate on the environment.

Cross-media effects

No information submitted.

Operational data

Refer to data included in Table 7.77 and see Figure 7.38. Refer also to Chapter 2 of this document.

Applicability

To a varying degree, the measures included in this technique are applicable to both the PCC plants integrated with a soda ash plant or an associated industrial chemical complex and to the isolated PCC plants (refer to Table 7.76).

Economics

No data submitted.

Driving force for implementation

The protection of the aquatic environment.

Example plants

No specific example plants.

Reference literature

[94, CEFIC-SOLVAY S.A., 2004], [33, CEFIC-ESAPA, 2004], [45, UBA - Germany, 2001].

### 7.12.5 Best Available Techniques for the manufacture of precipitated calcium carbonate

For general information on understanding a BAT section and its contents, see Section 7.1.5.

As described earlier in this document, precipitated calcium carbonate (PCC) is produced by the reaction of calcium hydroxide with carbon dioxide yielding either a PCC slurry product or PCC dry product. Two major process arrangements are possible. The majority of PCC plants in the EU use raw lime delivered from other sources and utilise gaseous CO<sub>2</sub> available locally from other processes at the site (or from combustion sources at neighbouring sites), and the PCC plant is then a net consumer of CO<sub>2</sub>.

However, in some cases, both lime and CO<sub>2</sub> are derived from the lime kiln integrated with the PCC plant at the site, and the PCC plant is then a net emitter of CO<sub>2</sub>.

Therefore, bearing in mind that information concerning the operation of lime kilns is included in the BREF on Cement and Lime, BAT conclusions for the production of both PCC based on the utilisation of CO<sub>2</sub> and lime from other processes, and for the production of PCC by the lime kiln route, are drawn jointly, as follows.

#### **For the production of PCC based on both the utilisation of CO<sub>2</sub> and lime from other processes and the usage of CO<sub>2</sub> and lime from the lime kiln at the site, BAT is to:**

1. Optimise plant operation and process parameters in particular in the carbonation step (including viscosity of milk of lime, temperature, rate of agitation, CO<sub>2</sub> concentration and flowrate, etc.), as well as by dedicated process control (automatic start up of discontinuous carbonation, automation of the carbonation sequence, optimisation of CO<sub>2</sub> supply and consumption rate), to minimise the consumption of raw materials and energy, and to reduce excess CO<sub>2</sub> discharged from the PCC plant – see Sections 7.12.3, 7.12.3.1.1 and 7.12.4.3.
2. Reduce dust emissions to air from lime reception and PCC drying, grinding and packaging operations, using a suitable combination of dust preventive and abatement techniques, e.g. bag filters and scrubbers (see Sections 7.12.3 and 7.12.3.1). More information can be found in Section 8.2.3.7 and in the CWW BREF.
3. Reduce emissions of suspended solids and chemical additives to water to 1 – 30 kg per tonne of dry PCC produced by controlled recycling of waste water from the dewatering step to the lime slaking step (taking into consideration: the quality of input process water, the quality of raw materials, and the quality of the final PCC product), followed, if required, by additional treatment of liquid effluents released from the PCC plant, either in an integrated or an isolated waste water treatment system (additional filtration or settling devices) – see Sections 7.12.3, 7.12.3.2 and 7.12.4.4.
4. Minimise the amount of solid wastes discharged to land from the steps of slaking and carbonation and the solids separation step (grit) from the PCC slurry. Consumption levels for raw lime of 600 – 660 kg per tonne of dry PCC product (and given the stoichiometric figure of 560 kg CaO to produce 1 tonne of PCC), the efficiency of lime usage varies in the range between 93 % (at 600 kg/t) and 85 % (at 660 kg/t). These latter figures are lower performance targets, as about 15 % of raw material ends up as a solid waste (see Sections 7.12.3, 7.12.3.3 and 7.12.4.2).
5. Reduce the amount of solid waste by recycling out-of-grade PCC product into the PCC process (bearing in mind that the recycling rate must be compatible with the quality requirements of the PCC product), and by utilising other solid waste streams from the PCC process (as the calcium source) in the cement and lime industry and, if locally possible, as a soil amendment (see Sections 7.12.3 and 7.12.4.2).

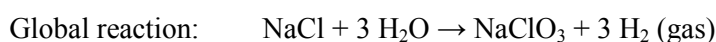
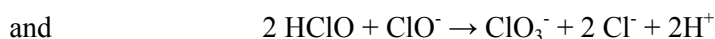
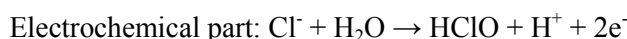
## 7.13 Sodium chlorate

### 7.13.1 General information

#### 7.13.1.1 Introduction

Sodium chlorate ( $\text{NaClO}_3$ ) is an intermediate product principally (more than 95 %) used in pulp and paper production, where it is converted into chlorine dioxide ( $\text{ClO}_2$ ), which is a bleaching agent for chemical wood pulp [6, CEFIC, 2002].

The process is based on the electrolysis of sodium chloride brine, in pH conditions where the chlorine from the anode remains combined with sodium hydroxide under the form of sodium hypochlorite, which is then decomposed into sodium chlorate and chloride. The equations are:



The brine preparation consists mainly of removing calcium, magnesium, heavy metals, and sulphates, and the process is very close to the one described in the BREF on Chlor-Alkali Manufacturing Industry (CAK) and in Chapter 2 of this document on soda ash.

The pH in the electrolysis is carefully controlled and stabilised by the buffer agent, sodium dichromate. The sodium hypochlorite, which is contained in the liquor leaving the electrolysis cells, is converted into sodium chlorate, and the resulting solution is sent for crystallisation. Here, solid sodium chlorate crystals are separated from the mother liquor, water washed, and shipped wet or dry depending on the application, while the mother liquor is recycled to the electrolysis step.

The hydrogen produced at the electrolysis step needs a treatment before being re-used as a fuel or as feedstock for chemical processes.

Air emission sources are principally due to the sodium chlorate dryer (when installed), to the handling of solids, and to the release of excess hydrogen gas.

When the plant is fed with solid salt, there is only negligible water emission. Solid wastes are generated at the brine treatment step and depend on the salt purity (refer to Chapter 2 above and to Section 7.13.2.2 below).

It should be noted that potassium chlorate ( $\text{KClO}_3$ ) is another 'selected illustrative' LVIC-S product listed in Annex I, point 4.2 (d) to the IPPC Directive.

Potassium chlorate is manufactured in two sodium chlorate plants in Europe. Less than 5 % of the European capacity is used for the manufacture of potassium chlorate.

As there are clear similarities in processes and techniques used in the production of sodium and potassium chlorate (typically, both  $\text{NaClO}_3$  and  $\text{KClO}_3$  are produced in the same convertible plant), the sodium chlorate process, based on the electrolysis of sodium chloride brine, is taken as illustrative for the production of  $\text{KClO}_3$  based on the electrolysis of potassium chloride brine, and the environmental effects from the production of  $\text{KClO}_3$  are included in this section.

### 7.13.1.2 Sodium chlorate uses

Sodium chlorate ( $\text{NaClO}_3$ ) is an efficient oxidising agent. The largest use for sodium chlorate is at paper pulp mills in the generation of chlorine dioxide, which is used for ECF-bleaching of chemical pulp. In 2001, this application represented 89 % of the total consumption in Western Europe (EU-15 Members States plus Norway). This compares to 99 % in North America and 76 % in Japan [66, CEFIC-Sodium Chlorate, 2004]. Other minor uses include weed control, production of potassium chlorate and sodium chlorite and several other smaller applications [66, CEFIC-Sodium Chlorate, 2004], based on [109, SRI International, 2002]. According to the EU classification (April 2004), sodium chlorate is oxidising (O), harmful (Xn) when swallowed and dangerous for the environment (N). Thermal decomposition can give toxic products and sodium chlorate can be explosive when mixed with combustible material. These properties necessitate special arrangements for storage and handling [66, CEFIC-Sodium Chlorate, 2004].

### 7.13.1.3 Production capacity

As illustrated in Table 7.78, the total production capacity of sodium chlorate in Western Europe is about 700 kt/year (2002 data), with nine companies and 15 production sites. North America, with 25 sites, has a production capacity of about 2000 kt/year (2002 data), while Eastern Europe, with three sites, has a production capacity of less than 100 kt/year (2002 data).

Country	Number of companies	Number of sites	Capacity kt/year
Finland	2	4	275
France	2	2	155
Italy	2	2	17
Norway	2	2	55
Portugal	1	1	21
Spain	2	2	49
Sweden	1	2	115
<b>TOTAL</b>	9 (*)	15	687
(*) In total nine companies. Some companies operate in several countries			

**Table 7.78: Western Europe sodium chlorate production sites (2002 data)**  
[66, CEFIC-Sodium Chlorate, 2004], based on [109, SRI International, 2002]

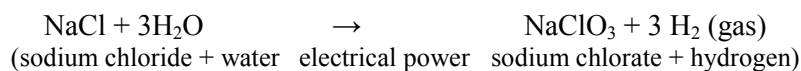
### 7.13.1.4 Economic factors

Sodium chlorate is considered a commodity product. Sodium chlorate plants are capital intensive. Producers deliver similar qualities of product. The price and quality of logistic services are the first criteria to consider for selecting the sodium chlorate supplier. In 2003, the ranges of prices for the crystal product are: for North America, USD 450 – 400 per tonne and for Europe, EUR 500 – 450 per tonne [66, CEFIC-Sodium Chlorate, 2004], based on [110, Harriman Chemsult Limited, 2004]. No new plant has been started in Western Europe in the last ten years. In 2004, new sodium chlorate plants were being built in South America, while projects were being studied in other parts of the world [66, CEFIC-Sodium Chlorate, 2004].

## 7.13.2 Applied processes and techniques

Sodium chlorate is produced by the electrolysis of an aqueous solution of sodium chloride. The raw materials are sodium chloride (solid or brine), water and electrical power. The process is continuous and is carried out in specially designed cells. It has a high degree of closure from an environmental point of view. Hydrogen is a by-product of the electrolysis and can be used as fuel or as a raw material for other processes.

Sodium chlorate and hydrogen are formed in the process according to the following equation:



A typical process is given in the flow diagram in Figure 7.39 below:

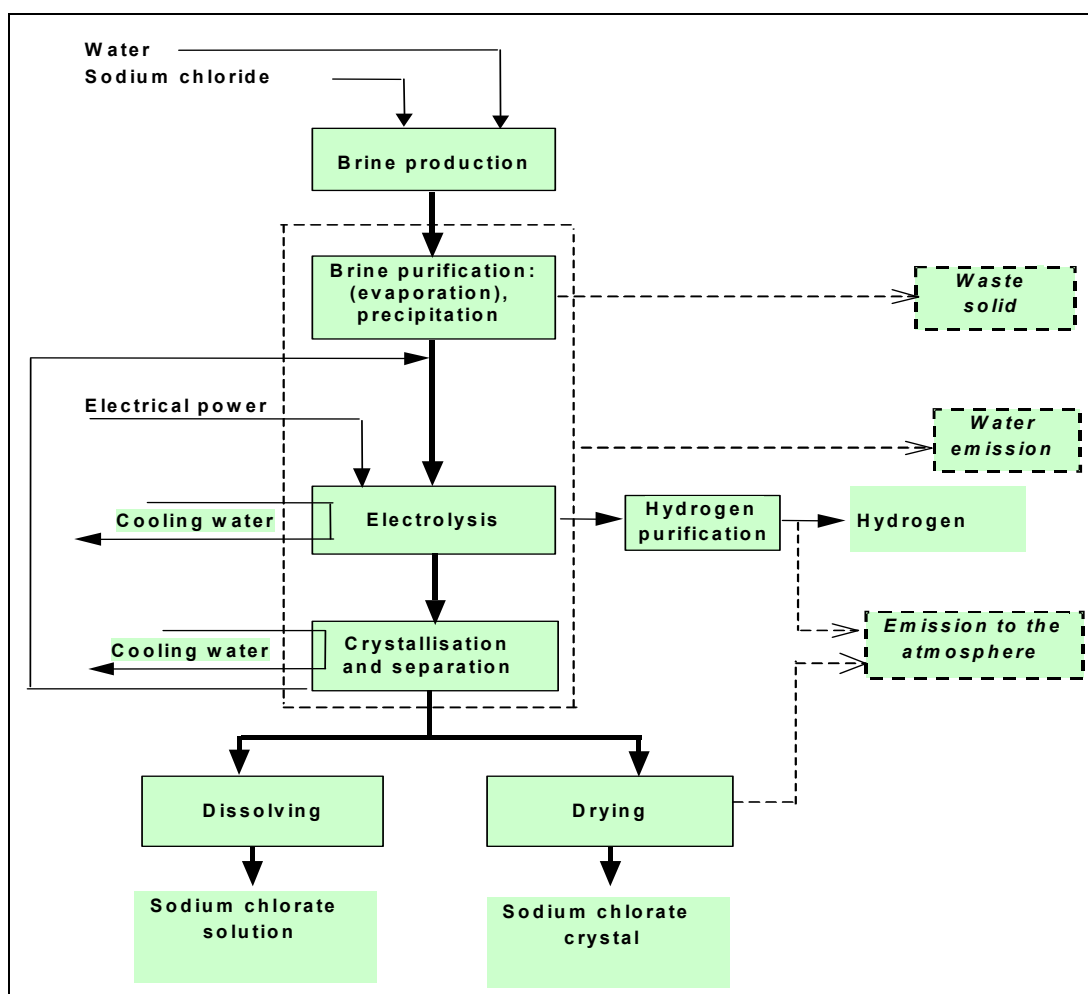


Figure 7.39: Sodium chlorate production – flow diagram  
[66, CEFIC-Sodium Chlorate, 2004]

The process is composed of the following steps as described in Section 7.13.2.1 through to Section 7.13.2.6.

### 7.13.2.1 Brine production

Saturated sodium chloride brine is prepared by dissolving the solid sodium chloride salt in hot water in a saturation tank. Process water or softened water is used. The quality of the sodium chloride depends on its origin and availability: vacuum salt, rock salt or sea salt is used. In some plants purified sodium chloride brine can be directly received as the feedstock.

It should be noted that for the manufacture of potassium chlorate, part of the sodium chloride salt is replaced by potassium chloride – refer to Section 7.13.1.1 above.



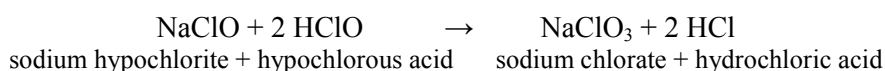
### 7.13.2.2 Brine purification

The electrolytic process requires high purity brine. The impurities of salt, like calcium, magnesium and sulphate, are precipitated with chemicals (sodium hydroxide, sodium carbonate and calcium chloride), and removed together with the salt insolubles by filtration. This results in a formation of solid waste (refer also to Section 2.2.1.2.1). Brine evaporation is also practised in some plants. A secondary purification of the brine may be achieved by ion exchange.

For the manufacture of potassium chlorate, the purification of potassium chloride is carried out using the same methods as for sodium chloride.

### 7.13.2.3 Electrolysis

Hydrochloric acid and sodium dichromate are added to the purified brine in order to get proper conditions for promoting sodium chlorate formation and to avoid side reactions during electrolysis. Then the brine is led into a set of electrolysis cells and reaction tanks. As a whole, electrolysis is carried out in a controlled range of temperature between 60 – 80 °C and pH 6.0 - 6.5. The electrolytic cells have anodes, made of titanium covered with a noble metal coating and cathodes generally made of steel. The formation of hydrogen gas takes place at the cathode and at the anode chlorine is formed. The hydrogen gas is separated from the liquid phase and chlorine, due to the pH conditions, remains in solution forming hypochlorous acid and hypochlorite ions. The liquor (the solution from cells) is continuously circulated between the cells and the reaction tanks. In the cells and in the reaction tanks, sodium chlorate is formed according to the following overall reaction:



The hydrogen coming from the electrolysis cells contains impurities like chlorine and oxygen. For safety reasons the oxygen content must be controlled. Chlorine must be removed from hydrogen before any use or emission to the atmosphere. This is carried out in scrubbers with sodium hydroxide or reducing agents. For special uses, it could be necessary to remove the oxygen by using a catalytic reactor. The heat energy generated in the cells is taken away by cooling the circulated liquor. The liquors coming from electrolysis are stored in tanks for finishing the transformation of hypochlorite into chlorate. Sodium hydroxide solution is added for pH control. After this stage, small quantities of sodium hypochlorite remain in the liquor. To avoid corrosion problems before the next steps, the hypochlorite can be reduced to chloride by addition of a reducing agent.

### 7.13.2.4 Crystallisation

Sodium chlorate is recovered from the liquors by concentration in a crystallisation unit using heat and vacuum or by lowering the temperature of liquors using refrigerating systems after an intermediate step of concentration by vacuum evaporation. Sodium chlorate crystals are separated and washed by filtration or centrifugation. The mother liquid and the washing liquid, containing sodium chloride, sodium chlorate and sodium dichromate, are recycled back to the main loop. The water purged from barometric condensers contains aerosols and condensate from the crystallising unit. A demister and other systems are used to minimise this emission.

### 7.13.2.5 Drying

The sodium chlorate crystals are dried with warm air in a dryer. Fluidised bed dryers are commonly used with an air temperature of around 150 °C. The drying process generates an emission of sodium chlorate particles. This emission is reduced by using filters, scrubbers and other clean-up systems.

### 7.13.2.6 Storage

Sodium chlorate can be stored and delivered as crystals in bulk or in bags, or upon requirements as a water solution.

### 7.13.3 Present consumption and emission levels

In this section consumption and emission levels are given for the sodium chlorate manufacturing process.

#### 7.13.3.1 Overall consumption and emission levels

The chlorate process needs large amounts of electricity and electrical energy is the major input. Other inputs are primarily salt and water (as feedstock), chemical precipitants to remove impurities in the brine and other auxiliary chemicals. Hydrogen gas is generated as a co-product. The main pollutant output common to all chlorate processes is the (solid) waste material formed when removing impurities from the input salt or brine. The volume of this waste material depends on the purity of the incoming salt.

Sodium dichromate is used as a necessary additive in the process. Due to the process characteristics, sodium dichromate can be emitted from the process through water, solid waste and in the product. Sodium dichromate contains hexavalent Cr(VI), part of which is converted to trivalent Cr(III) during the manufacturing process.

Table 7.79 gives an overview of the major inputs and outputs of the sodium chlorate manufacturing process. These figures are from different available sources and refer to sodium chlorate plants in Europe. The table does not claim to be complete.

Inputs, per tonne of sodium chlorate produced	Range	Comments
<b>Raw materials, energy and utilities</b>		
Salt (NaCl)	550 – 580 kg	In theory 549 kg (pure NaCl, no losses)
Process water	0.4 – 2.7 m <sup>3</sup>	Demineralised water or condensate
Cooling water	70 – 400 m <sup>3</sup>	
Steam	100 – 1000 kg	
Electricity	5000 – 6000 kWh AC	Typical use, depends on the current density
<b>Auxiliaries</b>		
Sodium dichromate	0.01 – 0.15 kg	
<b>Emissions, per tonne of chlorate produced</b>		
<b>To air</b>		
Hydrogen	9 – 28 kg	Based on utilisation rate of 53 – 85 %
Chlorine	0.05 – 1 g	
Chlorate dust	0.3 – 10 g	As NaClO <sub>3</sub>
<b>To water</b>		
Sodium chloride	200 – 400 g	Higher figure when salt evaporator is used
Chlorate	10 – 300 g	As NaClO <sub>3</sub>
Sodium dichromate	0.1 – 3 g	
<b>Wastes (amount depending on water content)</b>		
Process sludge with chromium	0.1 – 1 kg	Cr(VI) and Cr(III) content varies
Process sludge without chromium	0.05 – 2 kg	

**Table 7.79: Overview of inputs and outputs in the sodium chlorate manufacturing processes [66, CEFIC-Sodium Chlorate, 2004]**

### 7.13.3.2 Inputs, raw material and energy consumption

#### 7.13.3.2.1 Sodium chloride

Different types of salt like vacuum-crystallised partially purified salt, rock salt and sea salt are used to produce the brine for electrolysis. The consumption figures given in Table 7.79 vary depending on the content of impurities in salt.

#### 7.13.3.2.2 Water

Water is used in the process for:

- cooling – depending on the availability of water a single pass cooling system or a cooling tower system is used
- processing – process water is purified by filtration and by passing through ion exchange filters.

#### 7.13.3.2.3 Energy

Electrical energy and thermal energy, normally steam, is used in the manufacturing process. A large part of the electrical energy is converted into the enthalpy of the products. The rest is converted into heat transferred to the cooling water and to the air in the building. The heat can be partly recovered by transferring it from the electrolyte to a hot water or brine system and then utilised in the crystalliser and the salt evaporator (if this exists). Externally produced heat (steam) is required as a driving force for steam ejectors and, to some extent, as a heat source for the crystallisation and the drying of sodium chlorate. The hydrogen produced in the sodium chlorate plant can be used as a fuel or as a raw material in the synthesis of chemicals.

Direct current (DC) electric power needed for electrolysis is obtained by using transformers and rectifiers. Increased current density reduces the capital costs of a plant, as the production per unit cell capacity is then higher. However, there are trade-offs here. Higher current densities mean higher power consumption, also the unit cost of electricity is a factor when determining the appropriate trade-off between capital cost and power consumption.

Typical electrical energy use is given in Table 7.80.

	Typical figures
Current density (kA/m <sup>2</sup> )	1.0 – 3.0
Cell voltage (V)	2.6 – 3.6
Electrical energy use for electrolysis (AC kWh per tonne of sodium chlorate)	4700 – 5200 (depends on current density)
Electrical energy use by other electrical equipment: pumps, compressors, etc (AC kWh per tonne of sodium chlorate)	100 – 500
<b>Total energy use (AC kWh per tonne of sodium chlorate)</b>	<b>5000 – 6000 (typical use, depends on the current density)</b>

**Table 7.80: Electrical energy use in the electrolysis of sodium chlorate**  
[66, CEFIC-Sodium Chlorate, 2004]

### 7.13.3.2.4 Auxiliary substances

The typical use of auxiliary substances is described in Table 7.81.

Substance	Use	Consumption kg per tonne of NaClO <sub>3</sub> produced
Sodium carbonate Na <sub>2</sub> CO <sub>3</sub>	Precipitation of calcium ions as calcium carbonate (CaCO <sub>3</sub> ). Magnesium and iron are also precipitated	0.04 – 2
Calcium chloride (CaCl <sub>2</sub> )	Precipitation and elimination of sulphate in the case of its high levels in brine (or as an anti-caking agent used in cold crystallisation processes)	0 – 0.46
Barium salts (BaCl <sub>2</sub> )	Precipitation of sulphate in the case of its high level in brine	Sometimes used instead of calcium chloride
Filter aid	For assisting with the filtration of treated brine	Sometimes used
Sodium dichromate (Na <sub>2</sub> Cr <sub>2</sub> O <sub>7</sub> )	Added to electrolyte to minimise undesirable reactions, buffering to maintain the pH and reducing the corrosion of steel	0.01 – 0.15
Sodium hydroxide (NaOH)	Removal of magnesium and heavy metals (iron mainly if an anticaking agent is used for salt transportation). Used for pH control in the brine circuit. Neutralisation of acid wash. Regeneration of ion exchange resins.	15 – 30
Hydrochloric acid (HCl)	Used for pH adjustment of cells. Regeneration of ion exchange resins. Cell acid wash.	15 – 30
Hydrogen peroxide H <sub>2</sub> O <sub>2</sub> (or ammonium hydroxide NH <sub>4</sub> OH or sodium sulphite Na <sub>2</sub> SO <sub>3</sub> or urea CO(NH <sub>2</sub> ) <sub>2</sub> )	For reducing hypochlorite in the cell liquor before crystallisation.	1 – 3 (*)
Nitrogen gas N <sub>2</sub>	For purging of the installation (safety)	0.4 – 6
(*) Alternatively consumption of 3.25 kg of NH <sub>4</sub> OH per tonne of NaClO <sub>3</sub> both for reducing hypochlorite and for the refrigeration system used in the crystallisation unit.		

**Table 7.81: Consumption and use of chemical auxiliaries in sodium chlorate plants [66, CEFIC-Sodium Chlorate, 2004]**

### 7.13.3.3 Products and by-products

The products are obtained more or less in a fixed ratio, independent of the technology used: per 1000 kg of sodium chlorate produced, 60 kg of hydrogen is produced [66, CEFIC-Sodium Chlorate, 2004].

### 7.13.3.4 Emissions from the sodium chlorate process

#### 7.13.3.4.1 Emissionsto air

#### Hydrogen

The amount of hydrogen emitted to the atmosphere depends on the possibilities to utilise it as fuel or raw material. Some hydrogen is always discharged during plant start-ups and shutdowns.

#### Chlorine

The hydrogen produced contains chlorine. Excess chlorine is recovered in alkaline scrubbers sometimes using a reducing agent. Chlorine containing gases from electrolyte tanks and hydrochloric acid tanks are vented through a scrubber to recover excess chlorine.

#### Dust

The sodium chlorate dryer and transportation equipment are connected to a scrubber or filter for dust removal.

### 7.13.3.4.2 Emissions to water

#### Cooling water

The amount of non-contaminated cooling water depends on the temperature rise that is applied (normally 10 – 40 °C).

#### Process waste water

Process condensate and other process effluents containing chlorate, chloride and dichromate are largely recovered and returned to the brine circuit.

### 7.13.3.4.3 Solid wastes

Solid wastes can arise at several points in the sodium chlorate manufacturing process. Wastes can be divided in several categories depending on the source and on the presence or absence of chromium derived from sodium dichromate used in the process.

#### Process sludges without chromium

In the brine preparation and storage section, the solid impurities of salt are accumulated at the bottom of the dissolving tanks and removed periodically. In brine treatment, salt impurities are precipitated using sodium carbonate and sometimes calcium chloride (barium chloride) and a filter aid. The precipitated material is filtered from the brine. Solid sludge mainly contains calcium carbonate, magnesium hydroxide and calcium sulphate (barium sulphate). The quantity of brine filtration sludge mainly depends on the purity of the incoming salt.

#### Process sludges with chromium (hazardous waste)

The waste material described in Section 3.4.3.1 contains chromium, in case chromate containing process water is used in salt dissolving. Solids accumulate at the bottom of the electrolytic cells and the process tanks as a sludge. The sludge is removed from the cells during scheduled maintenance. Electrolytic cells are periodically washed using hydrochloric acid. The waste acid is filtered and the sludge containing iron and chromium is filtered off. The mother liquor is sometimes filtered before the crystallisation stage. This adds to the sludge which contains chromium.

#### Other waste material with chromium (hazardous waste)

Disposable filter cartridges and sock filters when the mother liquor is filtered in various stages of the process. Empty paper bags for sodium dichromate.

#### Other waste material without chromium

Disposable filter cartridges and sock filters from the treatment of brine that does not contain dichromate. Miscellaneous packing materials.

## 7.13.4 Techniques to consider in the determination of BAT

### Introduction: Techniques to consider in the determination of BAT – refer to Section 7.1.4

There are several aspects to consider when determining the Best Available Techniques for the production of sodium chlorate. The focus shall be on: low energy consumption, high hydrogen utilisation, high heat utilisation, closed loop system, low emissions to air, surface and groundwater, and a low amount of hazardous solid waste [66, CEFIC-Sodium Chlorate, 2004].

### 7.13.4.1 Low energy consumption

#### Description

The historical perspective is that the energy consumption decreased to one third during a little more than a 100 years. The first sodium chlorate plant started 1886 and the energy consumption was 15000 kWh per tonne of crystal product.

With modern technology, the consumption of electrical energy is 5000 – 6000 kWh per tonne of crystal product. In a production plant, the chlorate cells are operated in the cell voltage range 2.75 – 3.6 V at an average current efficiency of 95 %. The energy consumption is directly proportional to the voltage.

Activated anodes type DSA are used. When DSA replaced graphite as the anode material, the anodic overvoltage was drastically reduced. To keep a low overvoltage during operation, it is important to have control of impurities. Impurities can blind both the anode and cathode surface or deactivate the anode. Efficient brine purification is, therefore, important even if it generates an increased amount of solid waste. The energy consumption is inversely proportional to the current efficiency. The most important reason for lowering the current efficiency is oxygen production that will normally result in 2 – 2.5 % oxygen content in hydrogen. By control and optimisation of the process parameters, the production of oxygen can be minimised.

Another reason for the low current efficiency is the reduction of  $\text{ClO}^-$  and  $\text{ClO}_3^-$  on the cathode. These reactions are suppressed by the addition of sodium dichromate to the electrolyte. The  $\text{Na}_2\text{Cr}_2\text{O}_7$  concentration in the electrolyte is typically in the range of 3 – 5 g/l. Since sodium dichromate is undesirable for environmental reasons, an alternative for the addition of sodium dichromate is of high interest, but in spite of extensive research it has not been possible to find an alternative yet. Instead, the trend has been to minimise the output from the process and work towards a closed loop system to minimise the output of chromium (VI) to the environment.

#### Achieved environmental benefits

Low electrical energy consumption, possible with modern technology in which activated anodes type DSA are used, substantially reduces the amount of the fossil fuels required for the production of the electricity outside of the sodium chlorate plant, and thus contributes to decreasing the emissions of combustion products ( $\text{CO}_2$ ,  $\text{NO}_x$ ,  $\text{SO}_x$ ) to the atmosphere.

#### Cross-media effects

Efficient brine purification is very important for the efficient use of electrical energy, however, it generates an increased amount of solid waste. There are no other reported disadvantages caused by the implementation of this technique.

#### Operational data

Refer to data included in Section 7.13.3, and in particular to data on the consumption of electrical energy included in Table 7.79 and in Table 7.80. Also, the use of corrosion-resistant materials in the electrolysis section, such as titanium and fluoroplastics, that are able to operate at a higher temperature, results in the reduction of power consumption.

#### Applicability

To a varying degree, this technique is applicable to the plants producing sodium chlorate (both in form of the sodium chlorate solution and the sodium chlorate crystal).

#### Economics

No information submitted.

#### Driving force for implementation

High energy efficiency in the production process and low manufacturing cost of  $\text{NaClO}_3$  production.

### Example plants

No information submitted.

### Reference literature

[66, CEFIC-Sodium Chlorate, 2004], [111, B.V. Tilak and C-P Chen, 1999].

Refer also to the BREF on the Chlor-Alkali Manufacturing Industry.

### **7.13.4.2 High hydrogen utilisation**

#### Description

Hydrogen is produced in the process together with sodium chlorate (refer to Section 7.13.2.3). For overall energy efficiency, it is important to utilise hydrogen to a high degree. This depends on local conditions and the possibility of finding an outlet for using the hydrogen, which can be used as a source of energy or as a raw material for the chemical industry.

#### Achieved environmental benefits

A high degree of the utilisation of hydrogen results in the overall increased energy efficiency of the process, thus lessening the impact of the production of  $\text{NaClO}_3$  on the environment. In particular, the possibility of utilising hydrogen outside of the sodium chlorate plant substantially reduces the amount of the fossil fuels required either for the production of the equivalent amount of energy or hydrogen used in chemical syntheses. This, in turn, contributes to decreasing the emissions of combustion products ( $\text{CO}_2$ ,  $\text{NO}_x$ ,  $\text{SO}_x$ ) to the atmosphere.

#### Cross-media effects

There are discharges of some hydrogen during plant start-ups and shutdowns, and hydrogen is an extremely flammable and explosive gas (having a very broad range of explosion limits in mixtures with air). Hydrogen is contaminated with chlorine species and oxygen, and, therefore, it has to be purified before use.

#### Operational data

Refer to data included in Section 7.13.3 and to Figure 7.39. For all hydrogen uses, as well as its release into the atmosphere, scrubbing is essential to ensure the efficient removal of chlorine species from the gas. For other uses, it may be necessary to remove oxygen in a catalytic reactor.

#### Applicability

To a varying degree, this technique is applicable to the plants producing sodium chlorate, and in particular to the  $\text{NaClO}_3$  plants that supply hydrogen to other users located nearby.

#### Economics

No detailed data submitted, in particular with the costs of purifying gaseous hydrogen.

#### Driving force for implementation

High efficiency in the production process and low manufacturing cost of  $\text{NaClO}_3$  production, among others achieved through sales of the hydrogen by-product generated at the sodium chlorate plant site.

### Example plants

No information submitted regarding the  $\text{NaClO}_3$  plant (in particular the plant supplying hydrogen to other users).

### Reference literature

[66, CEFIC-Sodium Chlorate, 2004].

Refer also to the BREF on the Chlor-Alkali Manufacturing Industry.

### 7.13.4.3 High secondary heat utilisation

#### Description

The heat generated in the process corresponds to about 50 % of the energy consumption. For an efficient sodium chlorate process, it is important to efficiently recover secondary energy. The heat is transferred to a hot water or brine system and the heat can be used either internally in the process for crystallisation and for salt evaporation, or externally.

#### Achieved environmental benefits

High secondary heat utilisation improves the overall efficiency of the process, thus directly and indirectly contributing to reducing the impact on the environment.

#### Cross-media effects

There are no reported disadvantages caused by the implementation of this technique.

#### Operational data

No detailed data submitted apart from the information included in the 'Description' paragraph above.

#### Applicability

To a varying degree, this technique is applicable to the plants producing sodium chlorate (both in form of the sodium chlorate solution and the sodium chlorate crystal).

#### Economics

No data submitted.

#### Driving force for implementation

High overall energy efficiency in the production process and low manufacturing cost of NaClO<sub>3</sub> production.

#### Example plants

No information submitted.

#### Reference literature

[66, CEFIC-Sodium Chlorate, 2004].

Refer also to the BREF on the Chlor-Alkali Manufacturing Industry (CAK).

### 7.13.4.4 High degree of recycling

#### Description

To minimise the output of chlorate and chromium (VI) to the environment, the trend has been to work towards a closed loop system. Historically, the degree of recirculation increased dramatically by using sodium chlorate crystallisation instead of electrolyte shipments. Currently, it is possible to reach a high degree of recirculation.

It is important to monitor the consumption of dichromate, as it is a measure of the degree of recirculation in the closed loop process system. Sodium dichromate is used as a necessary additive in the process. Due to the process characteristics, sodium dichromate can be emitted from the process through water, solid waste and in the product. Sodium dichromate contains hexavalent Cr(VI), part of which is converted to trivalent Cr(III) during the manufacturing process. For a system with a high degree of recirculation, it is also important to control the build-up of concentrations of impurities in the electrolyte by having both a low intake and a controlled output of impurities from the system.

One example is filtration of the electrolyte to remove solids from the process. Efficient dewatering and washing of sodium chlorate crystals is important to keep the output of chromium with the product low. In a closed loop system, the target is to recycle chlorate and chromium(VI) containing liquids back to the sodium chlorate process. It is also important to recover caustic scrubber liquids.



### Achieved environmental benefits

To minimise the output of chlorate and chromium (VI) to the environment,

### Cross-media effects

No detailed information submitted.

### Operational data

Refer to Section 7.13.3, and to the information included in the 'Description' paragraph above.

### Applicability

This technique is applicable to the plants producing sodium chlorate (both in form of the sodium chlorate solution and the sodium chlorate crystal).

### Economics

No detailed data submitted, in particular with regard to the cost benefits resulting from applying a high degree of recirculation of the electrolyte.

### Driving force for implementation

High overall material and energy efficiency in the production process, the decreased manufacturing cost of NaClO<sub>3</sub> production, and the protection of the environment.

### Example plants

No information submitted.

### Reference literature

[66, CEFIC-Sodium Chlorate, 2004].

Refer also to the BREF on the Chlor-Alkali Manufacturing Industry (CAK).

## **7.13.4.5 Low emissions to air, surface water and groundwater**

### **7.13.4.5.1 Low emissions to air**

#### Description

As mentioned in Section 7.13.4.2, in order to keep the emissions of hydrogen to the air low, it is important to maintain a high degree of hydrogen utilisation. This depends on local conditions and the possibility of finding an outlet for using the hydrogen. Both the hydrogen and the gases from ventilated tanks contain chlorine species. The emission of chlorine species is kept low by applying caustic scrubbers and possibly using reducing agents.

Sodium chlorate dust is generated from handling the crystal product, for example from the dryer, from transportation equipment and from silos. It is important to ensure efficient collection and removal of sodium chlorate dust from the air as, if emitted, it will have a negative effect on vegetation. Sodium chlorate dust is removed from air using scrubbers and filters.

#### Achieved environmental benefits

The reduction of emissions of hydrogen, chlorine and dust from the production of NaClO<sub>3</sub>, in particular by efficient scrubbing of gases containing chlorine and efficient dust removal from chlorate crystal handling.

#### Cross-media effects

No data submitted.

#### Operational data

Refer to Section 7.13.3, and to the information included in the 'Description' paragraph above.

#### Applicability

This technique is applicable to the plants producing sodium chlorate (both in form of the sodium chlorate solution and the sodium chlorate crystal).

Economics

No detailed data submitted, in particular with regard to the cost benefits resulting from applying chlorine scrubbing with the solution of caustic soda.

Driving force for implementation

The protection of the environment.

Example plants

No information submitted.

Reference literature

[66, CEFIC-Sodium Chlorate, 2004].

Refer also to the BREF on the Chlor-Alkali Manufacturing Industry (CAK), and to the BREF on Common Waste Water and Waste gas Treatment/Management Systems in the Chemical Sector (CWW).

**7.13.4.5.2 Low emissions to surface water and groundwater**Description

The condensate from the chlorate crystalliser vacuum system can be a source of emissions to water. This is solved with indirect condensers and the recycling of condensate to the process. Another source of emissions to water can be leakage from the process coolers. Emissions can be avoided when using a hot water recirculation system with a high degree of recirculation and an efficient control programme for indicating leakages.

To keep the emissions of chlorate and chromium (VI) to water low, it is essential to apply the systems of collecting and recycling liquids containing chlorate and chromium (VI) to the sodium chlorate process. Sealed floors and trench systems are important for recycling liquids but also to avoid groundwater contamination.

Achieved environmental benefits

The reduction of emissions of sodium chlorate and chromium (VI) to water.

Cross-media effects

No data submitted.

Operational data

Process condensate and other process effluents containing chlorate, chloride and dichromate are largely recovered and returned to the brine circuit. Refer to Section 7.13.3, and to the information included in the 'Description' paragraph above.

Applicability

This technique is applicable to the plants producing sodium chlorate (both in form of the sodium chlorate solution and the sodium chlorate crystal).

Economics

No data submitted.

Driving force for implementation

The protection of the environment.

Example plants

No information submitted.

Reference literature

[66, CEFIC-Sodium Chlorate, 2004].

Refer also to the BREF on the Chlor-Alkali Manufacturing Industry (CAK), and to the BREF on Common Waste Water and Waste gas Treatment/Management Systems in the Chemical Sector (CWW).

#### 7.13.4.6 Low amount of hazardous waste

##### Description

The main pollutant output common to all chlorate processes is the (solid) waste material formed when removing impurities from the input salt or brine. The volume of this waste material depends on the purity of the incoming salt. It is important to ensure a low intake of impurities through a well functioning brine purification system. In order to reduce the amount of hazardous waste, it is particularly beneficial to reduce impurities in the brine before mixing it with liquids that contain dichromate. The amount of waste depends on the salt quality. Vacuum salt generates a minor amount of solids, mainly consisting of precipitated impurities like calcium and magnesium and, in some cases, also sulphate. Rock salt and sea salt generate more waste.

However, in addition to dealing with the intake of impurities, it is necessary to remove some solids resulting from the corrosion and formation of chromium (III). Also, filter cartridges and sock filters when the mother liquor is filtered in various stages of the process, and empty paper bags for sodium dichromate, need to be treated as hazardous wastes. It is important to dispose of the hazardous waste in a responsible way according to local rules and possibilities. It may include treatment of the waste before disposal.

##### Achieved environmental benefits

The minimisation of the disposal of wastes (process sludges without chromium), and hazardous wastes (process sludges with chromium) and other materials contaminated with chromium.

##### Cross-media effects

No detailed data submitted.

##### Operational data

Refer to Section 7.13.3, and to the information included in the 'Description' paragraph above.

##### Applicability

This technique is applicable to the plants producing sodium chlorate (both in form of the sodium chlorate solution and the sodium chlorate crystal).

##### Economics

No data submitted.

##### Driving force for implementation

The protection of the environment.

##### Example plants

No information submitted.

##### Reference literature

[66, CEFIC-Sodium Chlorate, 2004].

Refer also to the BREF on the Chlor-Alkali Manufacturing Industry (CAK), and to the BREF on Common Waste Water and Waste gas Treatment/Management Systems in the Chemical Sector (CWW).

#### 7.13.5 Best Available Techniques for the manufacture of sodium chlorate

For general information on understanding a BAT section and its contents, see Section 7.1.5.

Sodium chlorate is produced in the EU by the electrolysis of an aqueous solution of sodium chloride using direct current. The continuous process is energy intensive but offers some possibilities for the utilisation of secondary heat. By-produced hydrogen can be used as fuel or raw material for other processes.

Apart from dedicated management systems applied to reduce environmental, health and safety risks in the operation of sodium chlorate plants, the following measures are BAT for the manufacture of sodium chlorate.

**For the production of sodium chlorate, BAT is to:**

1. Use the most modern anodes, control the process of brine purification and optimise other key process parameters to maintain a high overall energy efficiency of the process, resulting in electrical energy consumption in the range of 5 – 6 MWh per tonne of crystal  $\text{NaClO}_3$  product (see Sections 7.13.2, 7.13.3.2.3 and 7.13.4.1).
2. Use corrosion-resistant materials (e.g. titanium and fluoroplastics) in the electrolysis section to allow the operating process to be carried out at higher temperatures, which results in reduced power consumption for the production of  $\text{NaClO}_3$  (see Section 7.13.4.1).
3. Purify and utilise the hydrogen by-product to a high degree, preferably at a higher level of the overall operational utilisation rate of 53 – 85 % (see Sections 7.13.3.1, 7.13.3.3, 7.13.3.4.1 and 7.13.4.2).
4. Efficiently utilise secondary energy available in the process by transferring the heat to a hot water or brine system and by its further usage either internally in sodium chlorate crystallisation and evaporation steps or externally in other activities (see Section 7.13.4.3).
5. Reduce emissions of chlorine to air to 0.05 – 1 g  $\text{Cl}_2$  per tonne of  $\text{NaClO}_3$  produced by using efficient alkaline scrubbing of gases containing chlorine (by-produced hydrogen and the off-gases from ventilated electrolyte and hydrochloric acid tanks) – see Sections 7.13.3.1 and 7.13.4.5.1.
6. Reduce chlorate dust emissions from sodium chlorate crystal drying and handling to 0.3 – 10 g  $\text{NaClO}_3$  per tonne of sodium chlorate produced by using a combination of dust abatement techniques (filters, scrubbers) – see Section 7.13.4.5.1.
7. Maintain a high degree of recycling of chlorate and liquors containing chromate within the process by using a closed loop system to minimise the output of chlorate and hexavalent chromium (VI) to the aquatic environment. Efficient dewatering and washing of sodium chlorate crystals enables maintaining low the output of chromium with the product (see Section 7.13.4.4).
8. Reduce emissions of chlorate and chromate to surface water by using indirect condensers allowing the recycling of condensates to the process, as well as sealed floors and trench systems to avoid groundwater contamination (see Section 7.13.4.5.2).
9. Minimise the disposal of hazardous wastes (process sludges containing chromium and other materials contaminated with chromium) and, if required locally, treat hazardous wastes prior to their disposal to the land (see Section 7.13.4.6).

## 7.14 Sodium perborate

### 7.14.1 General information

#### 7.14.1.1 Introduction

Sodium perborate, more correctly sodium peroxoborate, exists in hexahydrate, tetrahydrate and anhydrous forms, of which the most important is the hexahydrate – commercially known as sodium perborate tetrahydrate  $\text{Na}_2\text{B}_2\text{O}_4(\text{OH})_4 \cdot 6 \text{H}_2\text{O}$  [48, W. Buchner et al, 1989].

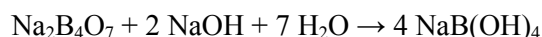
Sodium perborate became industrially significant in Germany in 1907, when it was employed in a laundry powder, making obsolete the very laborious process of sun bleaching that had been common up until that time [13, EIPPCB, 2000]. Sodium perborate is the most important bleaching agent used in the solid detergent powders. It is a solid salt available mainly in the tetrahydrate form, although the monohydrate can also be used [6, CEFIC, 2002].

Anhydrous sodium perborate (oxoborate) is not a bleaching agent, but its ability to liberate gaseous oxygen immediately on contact with water makes it suitable for use as a disintegrating agent in the form of a tablet.

The production capacity of sodium perborate in 1992 was 900000 tonnes per year (as the tetrahydrate). Because over 80 % of the world's perborate is consumed in Europe, most of the manufacturers are located there as well [13, EIPPCB, 2000].

Since hydrogen peroxide became available on an industrial scale, the product has been obtained primarily by a continuous crystallisation process.

The boron ore (today, essentially tincal or borax) is first dissolved by a reaction with sodium hydroxide at temperatures of 60 – 90 °C, leading to a sodium metaborate ( $\text{NaBO}_2$ ) solution. [6, CEFIC, 2002], [13, EIPPCB, 2000]. During this step, the hydroxides of heavy metals are precipitated:



The metaborate solution, once clarified by e.g. centrifugation, is then put into contact with an aqueous solution of hydrogen peroxide, leading to the precipitation of sodium perborate tetrahydrate crystals ( $\text{NaBO}_3 \cdot 4 \text{H}_2\text{O}$ ):



The crystals are separated from the mother liquor, dried with air at a moderate temperature and shipped. The perborate tetrahydrate crystals can also be sent to an air dryer operated at a higher temperature, where the tetrahydrate is dehydrated into perborate monohydrate ( $\text{NaBO}_3 \cdot \text{H}_2\text{O}$ ), which is also a commercial product. After solid/liquid separation the mother liquor is usually sent back to the metaborate make-up vessel.

Dust emissions to air are essentially from the drying, and to a lesser extent from the handling of solids. Emissions to water include the bleeding of excess mother liquor water from the crystallisation of perborate. The generation of waste is minor with ores like borax, but very noticeable with ores rich in inert materials like tincal [6, CEFIC, 2002].

Sodium perborate monohydrate is obtained by the dehydration of sodium perborate tetrahydrate:



This reaction is usually carried out by continuous contact with warm air in fluid-bed or vibrating-conveyors dryers.

To prevent agglomeration of the product bed, the temperature of feed air is raised from 80 to 160 °C zone by zone. Before it exits the drying zone, the monohydrate is cooled with cold air.

In turn, anhydrous sodium perborate (oxoborate) is produced by removing all the crystallisation water from either sodium perborate monohydrate or tetrahydrate. Dehydration is performed in fluid-bed equipment at air temperatures of 120 – 160 °C [13, EIPPCB, 2000].

#### 7.14.1.2 History of production

The first industrial production of sodium perborate in the early years of the 20th century also marks the beginning of production of the so-called 'heavy duty' powder detergents for consumer use [63, CEFIC-PEROXYGENES PERBORATE Sub Group, 2004].

Starting from a wet chemical process with boron concentrates, hydrogen peroxide and sodium hydroxide being used as raw materials, part of the industry soon changed to an electrolytic process because of the limited availability of hydrogen peroxide. In the 1950s when H<sub>2</sub>O<sub>2</sub> became sufficiently available from the 'anthraquinone process', all producers of sodium perborate successively turned to the wet chemical process, which, by all relevant parameters (technical, economic and environmental), had clear advantages.

#### 7.14.1.3 Production process

The wet chemical process starts with the formation of a metaborate solution from borax pentahydrate and sodium hydroxide. In a second step, the metaborate solution reacts with hydrogen peroxide to form sodium perborate. The sodium perborate forms crystals which are separated from the mother liquor and dried to the basic end-product of sodium perborate tetrahydrate. Sodium perborate tetrahydrate can be converted by further drying into monohydrate.

#### 7.14.1.4 Uses in industrial sectors

Sodium perborate is used as a bleach component in detergent and dishwashing powders and tablets, as well as in dental cleaners and cosmetics. Based on the draft perborate risk assessment report the usage percentages of sodium perborate are as listed in Table 7.82. These percentages have not changed significantly over the last few years.

Use	Percentage used
Processing (polymerisation aid in polysulphide sealants)	<1
Laundry detergents (heavy duty powders)	approx. 96
Dishwashing agents (automatic dishwashers)	approx. 3
Bleaching agents (denture cleansers, stain removers, buffer salts for textile bleaching)	<1

**Table 7.82: Sodium perborate uses in industrial sectors**  
[63, CEFIC-PEROXYGENES PERBORATE Sub Group, 2004]

#### 7.14.1.5 Production capacity

The production capacity in the European Union including new Member States was close to 400 kt PBS4 for the year 2003.

In 2006, there was one production site in each of the following countries: Austria, Belgium, Germany, Poland, Slovenia and Spain.

As the sodium perborate plants in Rheinfelden, Germany [44, UBA - Germany, 2001], and in Torrelavega, Spain [53, EIPPCB, 2004] have been closed, the example plants referred to in Section 7.14.4 are the sodium perborate plant in Hönningen, Germany and the sodium perborate plant in Althofen, Austria [85, EIPPCB, 2004-2005].

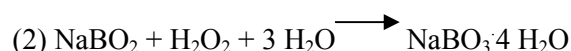
### 7.14.1.6 Socio-economic aspects

Sodium perborate, having been the bleach component of choice for the detergent industry for decades, is now facing an accelerating downturn in consumption due to the change in formulation trends of the detergent industry.

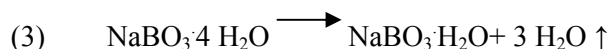
## 7.14.2 Industrial processes used

### 7.14.2.1 Process chemistry

Sodium perborate tetrahydrate is produced in a two step process: first the formation of sodium metaborate from borax pentahydrate and sodium hydroxide followed by the reaction of sodium metaborate with hydrogen peroxide forming sodium perborate according to the reaction equations (1) and (2):



The dehydration of the sodium perborate tetrahydrate, formed according to equation (2), and the generation of sodium perborate monohydrate, takes place following reaction equation (3):



### 7.14.2.2 Production process

#### 7.14.2.2.1 Manufacture of sodium perborate tetrahydrate

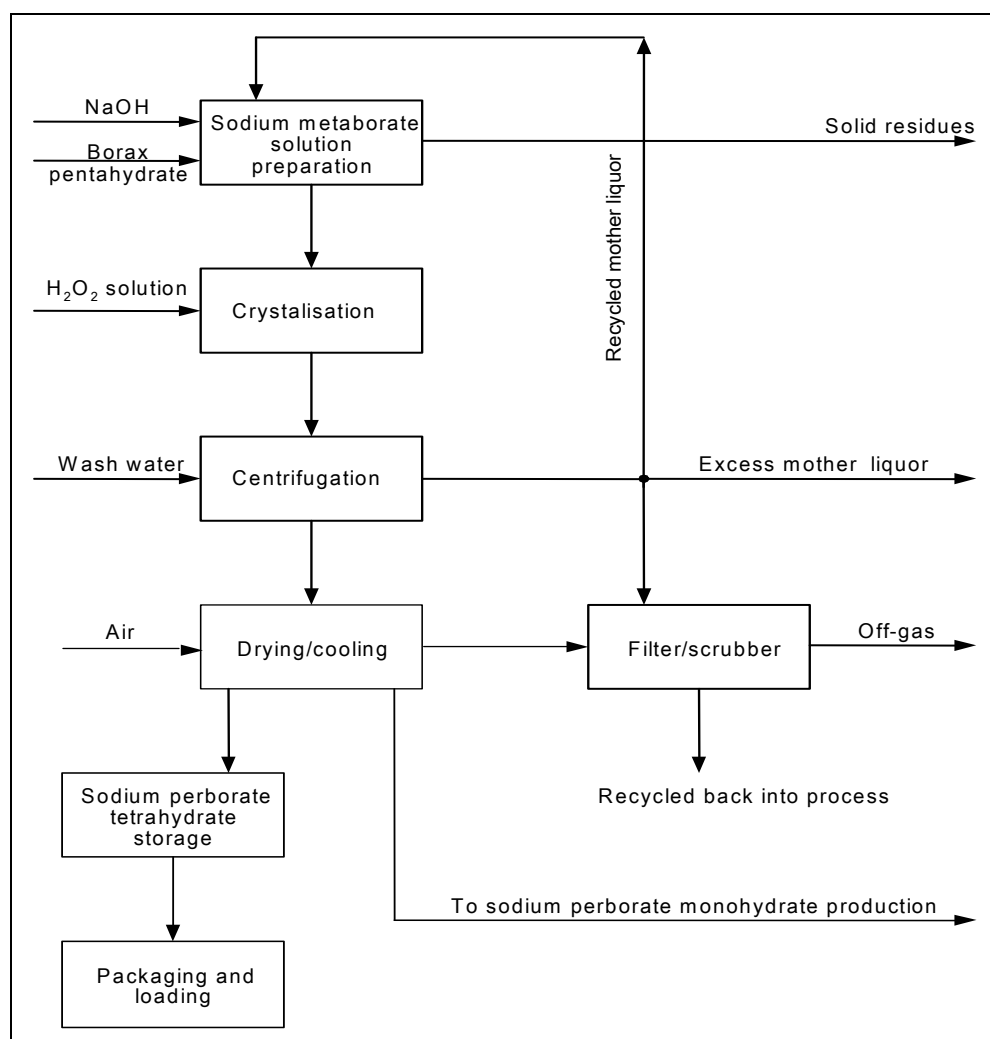
The typical production process of perborate tetrahydrate is shown in Figure 7.40.

The boron containing raw material borax pentahydrate is fed from the storage silo into the sodium metaborate solution preparation vessel. After the addition of sodium hydroxide, the borax pentahydrate is dissolved in the recovered mother liquor coming from the crystal separation sector, and a concentrated sodium metaborate solution is produced (see reaction equation 1). This process step can be operated continuously or batch wise. If required, sodium hydroxide or borax pentahydrate can again be added, in order to increase the conversion rate.

The metaborate solution can contain a low amount of insolubles which, in some cases, are partially removed by decantation or filtration. In some cases, flocculation aids are used to improve the separation of insolubles. Due to the high quality of the raw material currently used, the volume of filtration residues is close to zero in this process step.

The sodium metaborate solution is brought to a temperature of 30 to 60 °C by different techniques such as vacuum or indirect cooling with a coolant.

In the subsequent vacuum crystalliser or cooling crystalliser, the sodium metaborate solution is converted into sodium perborate tetrahydrate by the addition of hydrogen peroxide solution of approximately 40 % at reaction temperatures of between 5 and 40 °C.



**Figure 7.40: Flow diagram showing sodium perborate tetrahydrate production [63, CEFIC-PEROXYGENES PERBORATE Sub Group, 2004]**

In addition to the major raw materials, there are a number of miscellaneous auxiliary materials which may be added to the process for their various attributes such as stabilisation of the sodium perborate produced. All of these are expected to have minimal potential environmental impacts.

The vacuum required for the vacuum cooler and the crystalliser is generated in a vacuum installation, consisting of vacuum pumps and/or steam jets and condenser(s). In the case of using the cooling crystallisation technique, different coolants are being applied.

The precipitated sodium perborate tetrahydrate crystals are separated from the mother liquor in centrifuges. The mother liquor is collected in storage vessels and recycled back into the process. Excess mother liquor is discharged into the sewerage system. A partial stream of the mother liquor is used for the off-gas scrubbers for dust abatement in the air coming from the drying and cooling sections.

The separated sodium perborate, with a residual moisture of approximately 4–8 %, is transported to the drying section for the removal of residual moisture. The dryers used are of the rotary or the fluid bed type. The drying air can be heated with steam, electrical energy or gas.

Before being discharged into the atmosphere, the off-gas from the dryer is led through a wet scrubber or bag filter. The wet scrubber is operated with the mother liquor which is recycled back into the process. The fines collected from the bag filter are also recycled back into the process.

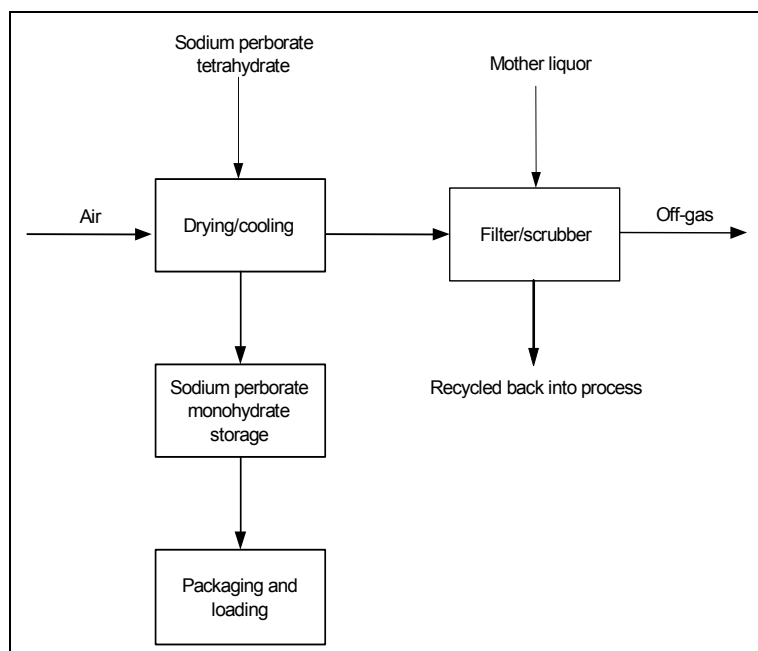


If required, the dry sodium perborate tetrahydrate is cooled down with filtered cooled air in a fluidised bed cooler. The off-gas from the cooler is cleaned by an off-gas scrubber or bag filter.

If required, the sodium perborate tetrahydrate is sieved to remove fine and coarse particles before being stored.

#### 7.14.2.2.2 Manufacture of sodium perborate monohydrate

The manufacture of sodium perborate monohydrate, on the basis of sodium perborate tetrahydrate, is shown in a flow diagram in Figure 7.41. The sodium perborate tetrahydrate is fed into fluid bed dryers in which the hydration water is removed to form sodium perborate monohydrate (see reaction equation 3).



**Figure 7.41: Flow diagram showing sodium perborate monohydrate production [63, CEFIC-PEROXYGENES PERBORATE Sub Group, 2004]**

This process can be operated continuously or batch wise. The required hot drying air can be generated in air heaters which are heated by steam or gas.

Afterwards the warm product is cooled down to approximately 25 – 35 °C in fluid bed coolers. The required cool air is generated in a cooler by means of a coolant.

If required, the sodium perborate monohydrate is sieved to remove fine and coarse particles before being stored.

The dust containing off-gas from the sodium perborate monohydrate dryers and coolers is led through wet-scrubbers or bag filters before being discharged to the air. The wet scrubber is operated with mother liquor and the used mother liquor is recycled back to the process. In case a bag filter is used, the collected fines are also recycled back to the process.

### 7.14.3 Present consumption and emission levels

#### 7.14.3.1 Raw materials

The following list gives the main raw materials used in the production of sodium perborate tetrahydrate/monohydrate:

- borax pentahydrate
- sodium hydroxide
- hydrogen peroxide.

Borax pentahydrate and sodium hydroxide are used for the preparation of sodium metaborate solution. In the crystallisation step, the obtained solution is mixed with hydrogen peroxide to form a suspension of sodium perborate tetrahydrate.

The ore from which borax pentahydrate is produced is excavated primarily in the US and Turkey. The ore is purified and crystallised to obtain the borax pentahydrate which contains a minimum level of impurities.

Sodium hydroxide solution (typically 50 % concentration) is produced by electrolytic processes.

Hydrogen peroxide is produced by the anthraquinone process.

The Table 7.83 shows the consumption of the main raw materials per tonne of sodium perborate tetrahydrate (PBS4):

PBS4	Units	Consumption min/max
Borax pentahydrate (as is)	kg/t PBS4	470/520
Hydrogen peroxide (as 100 % H <sub>2</sub> O <sub>2</sub> )	kg/t PBS4	220/250
Sodium hydroxide (as 100 % NaOH)	kg/t PBS4	130/150

**Table 7.83: Main raw materials used in the production of sodium perborate tetrahydrate [63, CEFIC-PEROXYGENES PERBORATE Sub Group, 2004]**

#### 7.14.3.2 Utilities

##### 7.14.3.2.1 Steam

For the production of sodium perborate, steam is an important energy transfer medium and is generated in boilers.

Steam is used to heat up the mother liquor in the preparation of sodium metaborate, in order to boil out crystallisers (to clean the cooling coils), to generate a vacuum and to heat up the air that is used in the drying of sodium perborate tetrahydrate and monohydrate.

##### 7.14.3.2.2 Cooling media

Some steps in the production of sodium perborate tetrahydrate require cooling. Cooling is needed predominantly in the crystallisation process (to remove the heat of the reaction) and, to a lesser degree, to cool the solution of sodium metaborate and the air in the drying/cooling process. Water is normally used as a cooling medium. In a closed cooling system, other cooling media can be used such as a mixture of glycol and water or a brine solution. The closed cooling system requires the use of either cooling towers or cooling aggregates. With open cooling systems, fresh water from different sources is used and then discharged to the sewerage system.

### 7.14.3.2.3 Electric energy

Electric energy is needed to operate the different process steps such as cooling aggregates, pumps, centrifuges, blowers, heating, etc.

### 7.14.3.2.4 Natural gas

Natural gas can also be used to heat up the air that is used in the drying of sodium perborate tetrahydrate and monohydrate.

### 7.14.3.2.5 Total energy consumption

The total energy consumption in the production of sodium perborate tetrahydrate is up to 3.7 GJ/t and in the production of sodium perborate monohydrate up to 9.4 GJ/t PBS4 equivalent.

It should be noted, however [85, EIPPCB, 2004-2005], that these maximum levels of energy consumption are linked to much lower boron emissions than the maximum level of boron emission to water of up to 5 kg B/t sodium perborate tetrahydrate produced, as reported in Section 7.14.3.3.2 below.

A relationship exists between boron emissions to water and energy consumption and, therefore, two alternative options for PBS4 and PBS1 production are available:

- option A (high energy consumption – low boron emission to water). In this option, illustrative for boron emissions of below 0.35 kg B/t PBS4, the plant can be operated for the production of PBS4 with a total energy consumption of less than 3.7 GJ/t PBS4, and for the production of PBS1 with a total energy consumption of less than 9.4 GJ/t PBS4 equivalent
- option B (low energy consumption – high boron emission to water). In this option, illustrative for boron emissions of below 5 kg B/t PBS4, the plant can be operated for the production of PBS4 with a total energy consumption of less than 1.5 GJ/t PBS4 and for the production of PBS1 with a total energy consumption of less than 4 GJ/t PBS4 equivalent.

Thus, when starting from the boron ore, and assuming boron emissions to water as in the options analysed above, the overall energy consumption in the production of sodium perborate tetrahydrate can be within the range of <1.5 – 3.7 GJ/t PBS4, and when followed by the production of sodium perborate monohydrate, within a range of <4.0 – 9.4 GJ/t PBS4 equivalent. The lower ends in these ranges relate to higher boron emissions to water (<5 kg B/t PBS4) and the higher ends relate to lower boron emissions to water (<0.35 kg B/t PBS4).

Consequently, it should be also noted, that in the above-mentioned extreme options (boron emissions to water of either <5 kg B/t PBS4 or <0.35 kg B/t PBS4), energy consumption to convert PBS4 to PBS1 is within the range <2.5 – 5.7 GJ/t PBS4 equivalent, which translates to energy consumption within the range <4.0 – 9.1 GJ/t PBS1 product.

Depending on the local situation, a choice can be made between these two alternative options for PBS4 and PBS1 production. Options A and B are extreme ones, and there are several operational possibilities between them.

### 7.14.3.3 Emissions

#### 7.14.3.3.1 Dust emissions

Dust emissions occur mainly in the process of drying sodium perborate tetrahydrate and monohydrate. The exhaust air from the dryers is cleaned by means of bag filters or wet scrubbers. In this way, the dust content in the air that is discharged into the atmosphere is greatly reduced. In addition, filters or scrubbers are used for dust abatement during conveying, packing and loading.

The level of dust emissions is up to 0.2 kg of dust/t of sodium perborate tetrahydrate (based upon full conversion to sodium perborate monohydrate). However, emissions of dust as low as 0.03 – 0.1 kg of dust/t of sodium perborate tetrahydrate have been reported [44, UBA - Germany, 2001], with the average half hourly values of dust concentrations in the outlet air of 5 – 20 mg/m<sup>3</sup> from drying and cooling of sodium perborate tetrahydrate and monohydrate.

It is reported that in the Austrian plant, applying a combination of cyclones and a scrubber for the production of PBS4, and a combination of cyclones and bag filters for the production of PBS1, sodium perborate dust emissions far below 5 mg/Nm<sup>3</sup> are achieved [85, EIPPCB, 2004-2005].

However, the PBS industry considers that with techniques such as bag filters or wet scrubbers, the achievable dust emission value is below 20 mg/Nm<sup>3</sup> air [85, EIPPCB, 2004-2005].

#### 7.14.3.3.2 Water emissions

The source of water emissions is the excess mother liquor from the centrifugation step and cleaning water. A major part of the mother liquor is recycled while a part of it is neutralised and discharged to the sewerage system. The mother liquor contains small amounts of sodium metaborate.

Cooling water from an open or closed system is discharged together with the neutralised mother liquor.

The emissions of boron to water are up to 5 kg boron/t sodium perborate tetrahydrate produced, however, emissions of boron to water as low as 13 – 17 g/t sodium perborate tetrahydrate have been reported in the sodium perborate plant in Rheinfelden, Germany [44, UBA - Germany, 2001]. As mentioned above, this plant is closed.

It should be also noted, that according to the Austrian Ministerial Order on inorganic chemicals (pertaining also to the example sodium perborate plant in Althofen, Austria), the limit of boron emissions to water is set at 0.35 kg B/t installed capacity calculated as PBS4 [85, EIPPCB, 2004-2005].

## 7.14.4 Techniques to consider in the determination of BAT

### Introduction: Techniques to consider in the determination of BAT – refer to Section 7.1.4

The use of pure raw materials as specified in Section 7.14.3.1 and the techniques described in Section 7.14.4.1 and used in the process steps for dissolution, crystallisation, centrifugation and drying, are the main techniques to consider in the determination of BAT for the production of sodium perborate. The industry has selected and developed the techniques over many years in multiple locations which has resulted in mature processes with similar performances. Further improvements, especially with regard to the environment, are mainly in the fine tuning of the processes and are expected to result in marginal changes of emissions [63, CEFIC-PEROXYGENES PERBORATE Sub Group, 2004].

#### 7.14.4.1 Pure raw materials used for the production of sodium perborate

##### Description

The type and the purity of the boron raw material used has a major influence on the environmental performance of the production of sodium perborate tetrahydrate (PBS4).

Today, the boron raw material used is borax pentahydrate. The use of borax pentahydrate has, in comparison to other raw materials containing boron (e.g. calcium borates), the advantage of good water solubility, thus avoiding large quantities of by-products, which occur in the breaking down of boron minerals containing calcium.

The industry-wide change to use borax pentahydrate as a boron mineral has reduced the quantity of solid waste originating from the boron mineral to very low levels and has also reduced the use of energy for this process step.

The use of borax pentahydrate, which has a high B<sub>2</sub>O<sub>3</sub> content of >46 % and, correspondingly, a low content of crystallisation water, helps to minimise the production of excess mother liquor from the sodium perborate process. In the last few decades, the use of increasingly purer raw materials containing boron with a high active matter content has led to an increasingly reduced environmental impact caused by the perborate production process. Other raw materials, hydrogen peroxide and sodium hydroxide, are of standardised technical grades.

##### Achieved environmental benefits

The use of pure raw materials, and particularly borax pentahydrate, in the production of sodium perborate helps to reduce the quantity of solid waste coming from the boron mineral, to minimise the amount of mother liquor and to reduce the amount of energy used in the process.

##### Cross-media effects

There are no reported disadvantages caused by the implementation of this technique.

##### Operational data

No detailed data submitted. The production of sodium perborate is carried out according to the wet process route in which borax pentahydrate, hydrogen peroxide and sodium hydroxide are the main raw materials used – refer to Table 7.83 and to Figure 7.40.

##### Applicability

Applicable to the plants producing sodium perborate by the wet process route (PBS4).

##### Economics

No data submitted.

##### Driving force for implementation

High material and energy efficiency in the process, leading to the minimisation of the impact of the production of sodium perborate on the environment and to the reduced manufacturing cost.

##### Example plants

The sodium perborate plant in plant in Hönningen, Germany.  
The sodium perborate plant in Althofen, Austria.

##### Reference literature

[44, UBA - Germany, 2001], [63, CEFIC-PEROXYGENES PERBORATE Sub Group, 2004], [53, EIPPCB, 2004], [48, W. Buchner et al, 1989], [6, CEFIC, 2002].

#### 7.14.4.2 Manufacture of the intermediate product (metaborate solution)

##### Description

The manufacture of the intermediate product, metaborate solution from borax pentahydrate and sodium hydroxide occurs in the temperature range of 60 – 95 °C, after which it is cooled to 30 - 60 °C. This process step can be operated continuously or batch wise.

In order to set the temperature of the metaborate solution, the heat can either be transferred directly by the use of steam or indirectly using a heat carrier. Carrying out this process step in the lower temperature of approx. 60 °C saves energy.

##### Achieved environmental benefits

Energy savings in the process, indirectly resulting in the protection of the environment.

##### Cross-media effects

It is reported that the influence of the reaction temperature on the required reaction time for sodium metaborate production is very limited.

##### Operational data

By keeping a lower level of the temperatures in the process, the excessive losses of energy are avoided. No detailed data submitted – refer to Table 7.83 and to Figure 7.40.

##### Applicability

Applicable to the plants producing sodium perborate by the wet process route.

##### Economics

No data submitted.

##### Driving force for implementation

Lower energy losses in the process.

##### Example plants

The sodium perborate plant in plant in Hönningen, Germany.  
The sodium perborate plant in Althofen, Austria.

##### Reference literature

[44, UBA - Germany, 2001], [63, CEFIC-PEROXYGENES PERBORATE Sub Group, 2004], [85, EIPPCB, 2004-2005].

#### 7.14.4.3 Purifying the metaborate solution/waste aspect

##### Description

The metaborate solution is usually purified before the crystallisation step, i.e. through decanting or through filtration of the insoluble impurities.

The waste quantities resulting from the separation step can be kept to a minimum, if the boron raw material used was selected under the conditions mentioned in section.

##### Achieved environmental benefits

The use of borax pentahydrate in the production of sodium perborate helps to reduce the quantity of solid waste coming from the boron mineral – refer to Section 7.14.4.1.

##### Cross-media effects

There are no reported disadvantages caused by the implementation of this technique.

### Operational data

No detailed data submitted – refer to Table 7.83 and to Figure 7.40. The purification of the metaborate solution results in better performance of the crystallisation and centrifugation steps, and in the reduction of the volume of the mother liquor produced, and this, in turn, allows for achieving a higher performance of the whole process.

### Applicability

Applicable to the plants producing sodium perborate by the wet process route.

### Economics

No data submitted.

### Driving force for implementation

High material and energy efficiency in the process, leading to the minimisation of the impact of the production of sodium perborate on the environment.

### Example plants

The sodium perborate plant in plant in Hönningen, Germany.

The sodium perborate plant in Althofen, Austria.

### Reference literature

[44, UBA - Germany, 2001], [63, CEFIC-PEROXYGENES PERBORATE Sub Group, 2004].

## **7.14.4.4 Crystallisation of perborate tetrahydrate**

### Description

The reaction of sodium metaborate and hydrogen peroxide, as well as the crystallisation of perborate tetrahydrate, are exothermic, i.e. energy for cooling is required. In practice, in order to remove the heat of crystallisation, either a cooling or a vacuum system is used.

In the first method, an additional cooling system is required to provide cold (e.g. an ammonia cooling system, or a salt brine cooling system).

In the second method, water is removed from the mother liquor by evaporation, thus reducing the quantity of excess mother liquor produced. In this system, steam ejectors are typically used in combination with water condensers, however vacuum systems in which only high efficiency vacuum pumps are used, are also applied in the chemical industry sector.

### Achieved environmental benefits

High material efficiency of the PBS4 process is achieved by the decreased volume of excess mother liquor circulating within the process (by water evaporation) and by the reduced borate concentration in the mother liquor (by a lower temperature in the case of cooling crystallisation) – refer to to Figure 7.40, indirectly resulting in the protection of the environment.

### Cross-media effects

No information submitted, in particular regarding the possible emissions of PBS4 droplets/mist to water in the barometric condensers used in the vacuum system, however, when liquid ring vacuum pumps operating with water are used in the vacuum system, apart from the process water droplets, no mother liquor droplets leave the pumps.

### Operational data

Refer to Table 7.83 and to Figure 7.40.

When a vacuum system is used in the crystallisation step, the evaporation of water from the mother liquor takes place, leading to the reduction of the volume of the mother liquor recirculated in the plant, and this, in turn, allows for achieving a higher performance of the whole PBS4 process.

The energy requirement for the operation of the cooling system has been estimated at 0.2 GJ/t PBS4, while the energy consumption for the vacuum crystallisation at 0.05 GJ/t PBS4. This is a small part of the total energy requirement which can reach 3.7 GJ/t in the production of sodium perborate tetrahydrate and 9.4 GJ/t in the production of sodium perborate monohydrate. Additionally, crystallisation at lower temperatures also results in a product with improved attrition resistance.

#### Applicability

To a varying degree, applicable to the plants producing sodium perborate by the wet process route, depending on the cooling system used in the crystallisation step (PBS4 crystallisation by cooling vs. PBS4 crystallisation by evaporation).

#### Economics

No data submitted.

#### Driving force for implementation

High material efficiency of the PBS4 plant.

#### Example plants

The sodium perborate plant in plant in Hönningen, Germany.

The sodium perborate plant in Althofen, Austria.

#### Reference literature

[44, UBA - Germany, 2001], [63, CEFIC-PEROXYGENES PERBORATE Sub Group, 2004], [85, EIPPCB, 2004-2005].

### **7.14.4.5 Separation of the crystals from the mother liquor**

#### Description

For energy saving reasons, it is especially advantageous to achieve a low surface moisture in the centrifuge wet cake which is obtained after the separation of the mother liquor. A low moisture content of the wet cake reduces the energy input for the final drying step. In order to achieve this, discontinuous centrifuges or multiple step continuous centrifuges are used for the separation of the crystallised perborate tetrahydrate today. Depending on the crystal structure of the product and the type of centrifuge used, it is possible to reach residual moistures of 3 – 10 % in the centrifuged wet cake.

#### Achieved environmental benefits

Energy savings in the process, in particular in the subsequent drying section, indirectly and directly resulting in the protection of the environment.

#### Cross-media effects

No information submitted, in particular with regard to using one of the mutually excluding options in the crystallisation system, for the size and the structure of PBS4 crystals obtained.

#### Operational data

No detailed data submitted. The lower the moisture in the wet PBS4 cake, the less energy required for its drying in the subsequent drying section.

#### Applicability

To a varying degree, applicable to the plants producing sodium perborate by the wet process route, also depending on the cooling system used in the crystallisation step (PBS4 crystallisation by cooling vs. PBS4 crystallisation by evaporation).

#### Economics

No data submitted.

#### Driving force for implementation

High energy efficiency of the PBS4 plant.



### Example plants

The sodium perborate plant in plant in Hönningen, Germany.

The sodium perborate plant in Althofen, Austria.

### Reference literature

[44, UBA - Germany, 2001], [63, CEFIC-PEROXYGENES PERBORATE Sub Group, 2004].

### **7.14.4.6 Drying sodium perborate and the purification of the exhaust air**

#### Description

To dry the sodium perborate products, i.e. sodium perborate tetrahydrate (PBS4) and sodium perborate monohydrate (PBS1), both rotary or fluidised bed dryers are used. In particular, for drying PBS1, fluid bed dryers are more suitable. In both cases, large quantities of drying air are required, which, before being released into the environment, have to be scrubbed or filtered to remove dust particles. Both techniques allow the complete return of the separated dust to the process.

#### Achieved environmental benefits

Complex dedusting of the air used for drying the sodium perborate products (PBS4 and PBS1), has a direct positive impact on the environment.

#### Cross-media effects

There are no reported disadvantages caused by the implementation of this technique.

#### Operational data

The sodium perborate monohydrate product (PBS1) is preferred in some applications where a lesser amount of crystallisation water in the product is required. PBS1 is produced using PBS4 as a raw material. The major unit operation in the PBS1 process is the drying/cooling step of the final product. For the illustration of the PBS4 process and the PBS1 process, refer to Figure 7.40 and Figure 7.41 respectively.

The exhaust air from the dryers is cleaned by means of bag filters or wet scrubbers. In addition, filters or scrubbers are used for dust abatement during conveying, packing and loading. The PBS4 or PBS1 dust is recycled back to the process. If a wet scrubbing system is used, the mother liquor, which is a scrubbing medium, is also returned back to the process. The level of dust emission is up to 0.2 kg of dust/t of sodium perborate tetrahydrate (based upon full conversion to sodium perborate monohydrate). However, emissions of dust as low as 0.03 - 0.1 kg of dust/t of sodium perborate tetrahydrate have been reported, with the average half hourly values of dust concentrations in the outlet air of 5 – 20 mg/m<sup>3</sup> from drying and cooling of sodium perborate tetrahydrate and monohydrate. It is reported that in the Austrian plant, applying a combination of cyclones and a scrubber for the production of PBS4, and a combination of cyclones and bag filters for the production of PBS1, sodium perborate dust emissions far below 5 mg/Nm<sup>3</sup> are achieved.

However, the PBS industry considers that with techniques such as bag filters or wet scrubbers, the achievable dust emission value is below 20 mg/Nm<sup>3</sup> air.

#### Applicability

Applicable to the plants producing both PBS4 and PBS1, and using either the rotary or the fluid bed dryers.

#### Economics

No data submitted.

#### Driving force for implementation

The protection of the environment and energy efficiency in the drying operations.

#### Example plants

The sodium perborate plant in plant in Hönningen, Germany.

The sodium perborate plant in Althofen, Austria.

#### Reference literature

[44, UBA - Germany, 2001], [63, CEFIC-PEROXYGENES PERBORATE Sub Group, 2004], [85, EIPPCB, 2004-2005].

### **7.14.4.7 Optimum water balance in the process/minimum waste water**

#### Description

The perborate process is an almost closed loop process, i.e. with little waste water being generated. The quantity of water introduced into the process (with raw materials or as cleaning water) is not much greater than the quantity, which is removed from the process with the product (as crystallisation water) or through evaporation. On the basis of the above objectives, it is advantageous to add raw materials in a concentrated form or as concentrated solutions and to limit the introduction of water into the process as much as possible.

Also, as illustrated in Section 7.14.3.2.5 above, a relation exists between boron emissions to water and energy consumption and, therefore, two alternative options for PBS4 and PBS1 production are available: option A – high energy consumption and lower boron emission to water, and option B – low energy consumption and higher boron emission to water.

Depending on the local situation, a choice can be made between the two alternative options for PBS4 and PBS1 production.

#### Achieved environmental benefits

Substantially reduces the amount of waste waters generated in the production of PBS4, and in the case of a higher consumption of energy, boron emissions to water can also be substantially reduced.

#### Cross-media effects

There are no reported disadvantages caused by the implementation of this technique. However, the consumption of a higher amount of energy results in associated emissions of SO<sub>x</sub>, NO<sub>x</sub> and dust.

#### Operational data

The source of water emissions is the excess mother liquor from the centrifugation step and cleaning water. The use of vacuum crystallisation, or any other means applied to eliminate water from the process, reduces the amount of excess mother liquor. A major part of the mother liquor is recycled, while a part of it is neutralised and discharged to the sewerage system. The mother liquor contains small amounts of sodium metaborate.

The emissions of boron to water are up to 5 kg boron/t sodium perborate tetrahydrate produced, however, emissions of boron to water as low as 13 – 17 g/t sodium perborate tetrahydrate have been reported. It should be also noted, that according to the Austrian Ministerial Order on inorganic chemicals (pertaining also to the example sodium perborate plant in Althofen, Austria), the limit of boron emissions to water is set at 0.35 kg B/t installed capacity calculated as PBS4.

In the case of cooling crystallisation, the amount of excess mother liquor is higher than in the case of vacuum crystallisation. In the case of cooling crystallisation, the concentration of borate (expressed as B) in the excess mother liquor is reduced, as the crystallisation is carried out at lower temperatures of 5 to 10 °C, thus making it possible to decrease the emission of boron to less than 5 kg/t sodium perborate tetrahydrate produced. In turn, as illustrated in Section 7.14.3.2.5 above, two alternative options for PBS4 and PBS1 production are available: high energy consumption with lower boron emissions to water, and low energy consumption with higher boron emissions to water.

### Applicability

This technique is applicable to the plants producing sodium perborate.

### Economics

No data submitted.

### Driving force for implementation

High material and energy efficiency in the process, leading to the minimisation of the impact of the production of sodium perborate on the environment.

### Example plants

The sodium perborate plant in plant in Hönningen, Germany.

The sodium perborate plant in Althofen, Austria.

### Reference literature

[44, UBA - Germany, 2001], [63, CEFIC-PEROXYGENES PERBORATE Sub Group, 2004], [85, EIPPCB, 2004-2005].

## **7.14.5 Best Available Techniques for the manufacture of sodium perborate**

For general information on understanding a BAT section and its contents, see Section 7.1.5.

Sodium perborate is currently produced in the EU by the wet chemical process in which the boron ore is reacted with sodium hydroxide to yield sodium metaborate solution which is then reacted with hydrogen peroxide to obtain sodium perborate tetrahydrate  $\text{NaBO}_3 \cdot 4 \text{H}_2\text{O}$  (PBS4). The other product of lesser importance is sodium perborate monohydrate  $\text{NaBO}_3 \cdot \text{H}_2\text{O}$  (PBS1) obtained by drying sodium perborate tetrahydrate (PBS4).

The use of the pure raw materials and techniques developed in multiple locations resulted in mature processes with similar performance and represent BAT for the production of sodium perborate.

### **For the production of sodium perborate tetrahydrate, BAT is to:**

1. Reduce the amount of discharged solid waste to land by using a high purity, high boron content raw material, preferably borax pentahydrate in the range of 470 - 520 kg borax pentahydrate (of at least 46 %  $\text{B}_2\text{O}_3$  content) per tonne of sodium perborate tetrahydrate (PBS4) produced (see Sections 7.14.3.1 and 7.14.4.1).
2. Save energy in the manufacture of sodium metaborate solution by carrying out the process at the lower level end of temperatures in the operational range of 60 – 95 °C (see Section 7.14.4.2).
3. Minimise emissions of boron compounds to water to the level below 0.35 – 5 kg B per tonne of sodium perborate tetrahydrate (PBS4) produced, by purifying the sodium metaborate solution, reducing the amount of excess mother liquor and optimising water balance in the process – see Sections 7.14.3.2.5, 7.14.3.3.2, 7.14.4.3 and 7.14.4.7.

#### Note:

Low emissions of boron to water (13 – 17 g B/tonne PBS4) have been reported – see Sections 7.14.3.3.2 and 7.14.4.7. However, the lower the boron emissions to water, the higher the total energy consumption in the process – refer to Section 7.14.3.2.5.

4. Reduce the concentration or the volume of the mother liquor originating from the crystallisation of sodium perborate tetrahydrate (PBS4) by using either a cooling system or a vacuum evaporation system to improve overall material and energy efficiency of the process (see Sections 7.14.3.3.2, 7.14.4.4 and 7.14.4.7).
5. Reduce residual moisture in the wet cake to 3 – 10 % by using an efficient centrifugation system fit to the characteristics of the PBS4 crystals to save energy in the subsequent PBS4 drying stage (see Sections 7.14.2.2.1 and 7.14.4.5).
6. Maintain the overall energy usage in the process within the range of 1.5 – 3.7 GJ per tonne of sodium perborate tetrahydrate (PBS4) produced by optimising process parameters, in particular in the wet process stage and in the PBS4 drying stage (see Section 7.14.3.2.5, and Sections 7.14.4.1 through to 7.14.4.7).

Note:

The lower the total energy consumption in the process, the higher the boron emissions to water and vice versa – refer to Section 7.14.3.2.5 and 7.14.4.7.

7. Reduce dust emissions to air from drying and cooling sodium perborate tetrahydrate (PBS4) to below 5 – 20 mg/Nm<sup>3</sup> of the outlet air by using bag filters or wet scrubbers, as appropriate. Wet scrubbers operate at the upper end of the range (see Sections 7.14.3.3.1 and 7.14.4.6).

**For the production of sodium perborate monohydrate, BAT is to:**

1. Maintain the overall energy usage in the process within the range of 4.0 – 9.4 GJ/t PBS4 equivalent for one tonne of sodium perborate monohydrate (PBS1) produced (when starting from the boron ore) or within the range of 2.5 – 5.7 GJ/t PBS4 equivalent for one tonne of PBS1 produced (when starting from the PBS4), by optimising process parameters, in particular in the sodium perborate monohydrate (PBS1) fluid-bed drying stage – see Sections 7.14.3.2.5, 7.14.4.6 and 7.14.4.7.

Note:

The energy consumption to convert PBS4 to PBS1 is within the range 2.5 – 5.7 GJ/t PBS4 equivalent, which translates to energy consumption within the range 4.0 – 9.1 GJ/t PBS1 product.

2. Reduce dust emissions to air from the steps of drying and cooling sodium perborate monohydrate (PBS1) to below 5 – 20 mg/Nm<sup>3</sup> of the outlet air by using bag filters or wet scrubbers, as appropriate. Wet scrubbers operate in the upper end of the range (see Sections 7.14.3.3.1 and 7.14.4.6).

## 7.15 Sodium percarbonate

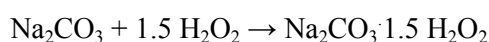
### 7.15.1 General information

#### 7.15.1.1 Introduction

In contrast with sodium perborate, which is a genuine peroxy compound, sodium percarbonate is only a perhydrate ( $\text{Na}_2\text{CO}_3 \cdot 1.5 \text{H}_2\text{O}_2$ ). It can be manufactured using a 'dry' process in a fluidised bed and a 'wet' process carried out in a solution with the end-product separated by cooling [48, W. Buchner et al, 1989].

Called sodium percarbonate by analogy with sodium perborate, sodium carbonate perhydrate [48, W. Buchner et al, 1989] finds usages as a bleaching agent in dry household detergents, in competition with sodium perborate [6, CEFIC, 2002].

Sodium percarbonate is obtained by the reaction of sodium carbonate with hydrogen peroxide:



This reaction is carried out using two principal types of process:

- the crystallisation process, where a sodium carbonate solution and hydrogen peroxide are reacted at a low temperature leading to the precipitation of sodium percarbonate crystals, which are further separated from the mother liquor, washed and dried. The mother liquor may be recycled to the dissolution and purification of soda ash, resulting in an almost waste water-free process
- the spraying process where the reactants are sprayed onto a renewed bed of sodium percarbonate crystals. Hot air fluidisation is a way of keeping the solid bed moving while evaporating the water. The process is virtually free of waste water.

In any case, stabilisation of sodium percarbonate is necessary before storage and shipment.

Air emissions include the air from the dryer (crystallisation process) or from the spray granulator (spraying process), as well as losses during handling. The major contaminant is the dust of sodium carbonate/percarbonate. Very small water emissions are met, especially with the spraying process.

Very small amounts of solid wastes are generated: wastes include metal (e.g. iron) hydroxides, which, in the case of the spray granulation process, need to be removed from soda ash in order to enhance the stability of sodium percarbonate.

#### 7.15.1.2 History of production

Sodium percarbonate was originally described in 1899 but it has not been produced industrially for more than 15 years because the related but more stable carrier of active oxygen, sodium perborate had become the bleaching component of choice in the new 'heavy duty' powder detergents at the beginning of the 20th century.

However, during the first world war, when Germany was cut-off from the supply of boron minerals, the first industrial production of sodium percarbonate was started there to replace sodium perborate. The same happened during the second world war but thereafter, for decades, sodium percarbonate became a niche product used mainly for dental cleansers and stain removers.

In the early 1990s, driven by performance and environmental considerations, the industry intensified the efforts to increase the stability of sodium percarbonate (especially by means of coating techniques) to make it also suitable for use in detergent and cleanser applications.

In 2004, a transition period started in which sodium percarbonate was continuously gaining a market share from sodium perborate. Substantial production capacities were installed in various European countries [57, CEFIC-PEROXYGENES, 2004].

### 7.15.1.3 Production processes

There are two main processes used to produce sodium percarbonate, the ‘crystallisation’ process and the ‘spray-granulation’ process, both of which use sodium carbonate and hydrogen peroxide as the raw materials [57, CEFIC-PEROXYGENES, 2004]. These are described in more detail in Section 7.15.2. For most applications, the basic sodium percarbonate resulting from either process has to go through a second production step, the ‘coating’ process, to achieve the required stability.

### 7.15.1.4 Uses in industrial sectors

Sodium percarbonate is used as a bleach component in detergent powders, dishwashing powders and tablets as well as in dental cleansers and cosmetics.

The estimated usage percentages for the year 2003 are given in Table 7.84.

Use	Percentage used
Laundry detergents (heavy duty powders), bleach boosters, stain removers	>90
Dishwashing agents (automatic dishwashing powders)	>5
Bleaching agents (denture cleansers, cosmetics)	<1

**Table 7.84: Sodium percarbonate usage for the year 2003**  
[57, CEFIC-PEROXYGENES, 2004]

### 7.15.1.5 Production capacity

The production capacity in the European Union (including the capacities of new Member States) was close to 500 kt in the year 2003.

In 2006, there was one production site in each of the following countries: Austria, Belgium, Germany, Poland, Slovenia and Spain. The most characteristic example sodium percarbonate plants are the plant in Hönningen, Germany, the plant in Treibach-Althofen, Austria, and the plant in Bussi, Italy.

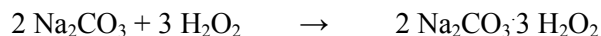
### 7.15.1.6 Socio-economic aspects

Sodium percarbonate is considered to be an outstanding environmentally-friendly bleach component for heavy duty powder detergents and dishwashing agents for consumer use.

## 7.15.2 Industrial processes used

### 7.15.2.1 Process chemistry

Sodium percarbonate is produced by reacting sodium carbonate with hydrogen peroxide to form the additional product sodium carbonate perhydrate according to the reaction equation:



Depending on the application, sodium percarbonate can be optionally coated with auxiliary agents to improve the stability of the product.

### 7.15.2.2 Production processes

In this section two main technologies for the production of sodium percarbonate: the crystallisation process and the spray-granulation process are described as state-of-the-art processes [57, CEFIC-PEROXYGENES, 2004].

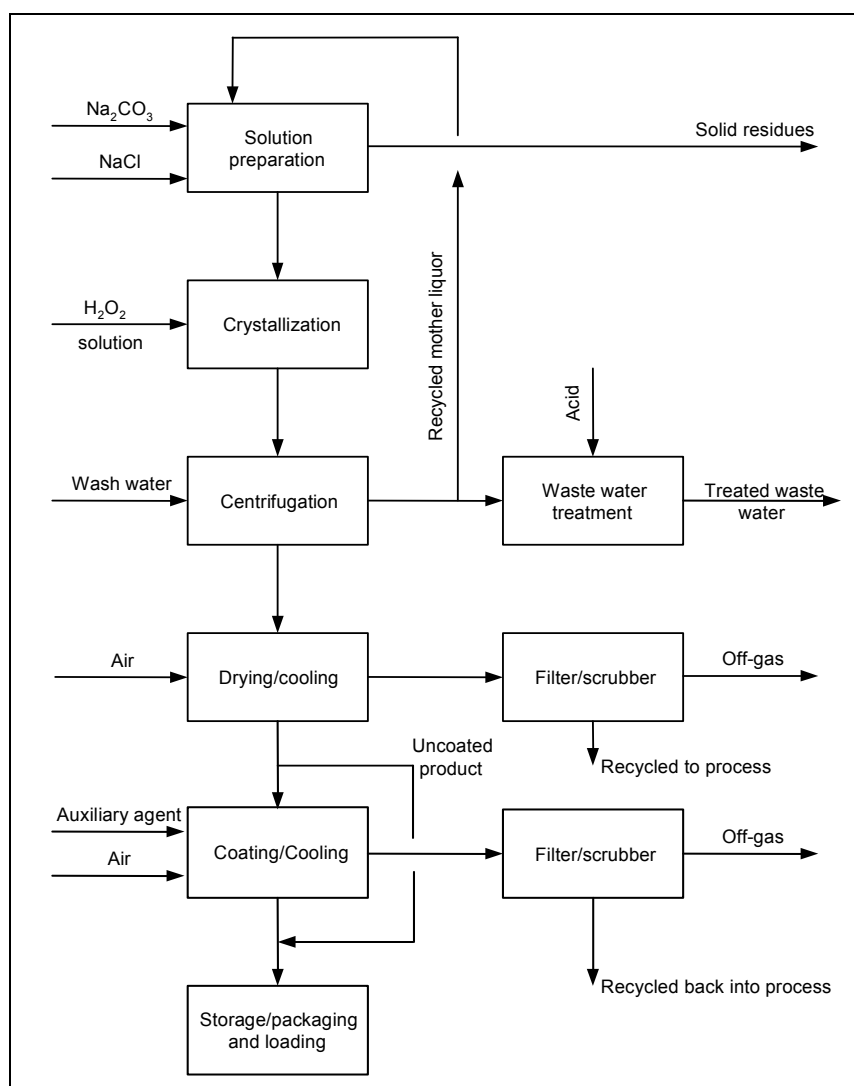
Although the processes are environmentally comparable, they are fundamentally different in the technology used to produce basic sodium percarbonate. For this reason, the production processes used for either route are described separately in the following sections.

The coating process of sodium percarbonate does not depend on the way the basic sodium percarbonate is produced and has, therefore, been described in a separate section.

#### 7.15.2.2.1 The crystallisation process

This process is the classical wet chemical method where a solution of sodium carbonate is put into a reaction with hydrogen peroxide to form crystals of sodium carbonate perhydrate which are separated from the mother liquor by centrifugation [57, CEFIC-PEROXYGENES, 2004].

The typical production process of sodium percarbonate by the crystallisation process is shown in a flow diagram in Figure 7.42.



**Figure 7.42: Sodium percarbonate production by the crystallisation process**  
[57, CEFIC-PEROXYGENES, 2004]

The first step of this process is the solution preparation in which sodium carbonate and salt (sodium chloride or other sodium salts) are added to the recycled mother liquor coming from the crystal separation step. This process step can be operated continuously or batch wise. The carbonate/salt solution can contain a low amount of insolubles, which, in some cases, are partially removed by decantation or filtration. In some cases, flocculation aids may be used to improve the separation of the insolubles. Due to the high quality of the sodium carbonate currently used, the volume of filtration residues is very low.

This solution is fed to the crystalliser in which the sodium carbonate is reacted with the hydrogen peroxide solution to form the sodium percarbonate crystals (see the reaction equation). The hydrogen peroxide concentration is typically between 40 and 70 %. The crystalliser has to be cooled to remove the heat of the reaction and to reduce the solubility of the sodium percarbonate.

In addition to the major raw materials, there are a number of miscellaneous auxiliary materials which may be added to the process for their various attributes such as stabilisation of the product sodium percarbonate. All of these are regarded to have minimal environmental impact.



The sodium percarbonate crystals are separated from the mother liquor in centrifuges. The mother liquor is collected in storage vessels and recycled back into the process. Excess mother liquor can be used to remove from the process small amounts of contaminants, present in the raw materials. After treatment, the excess mother liquor is discharged into the sewerage system. The centrifugation step can include a washing step to improve the centrifugability of the sodium percarbonate crystals.

The separated sodium percarbonate crystals have a residual moisture content of approximately 5 – 15 %. This moisture is removed in the drying section. The dryers used are typically of the fluid bed type. The drying air can be heated with steam, gas or electric energy.

Before being discharged into the atmosphere, the off-gas from the dryer is led through a wet scrubber or bag filter. The wet scrubber is operated with the mother liquor which is recycled into the process. The fines collected from the bag filter are also recycled back into the process.

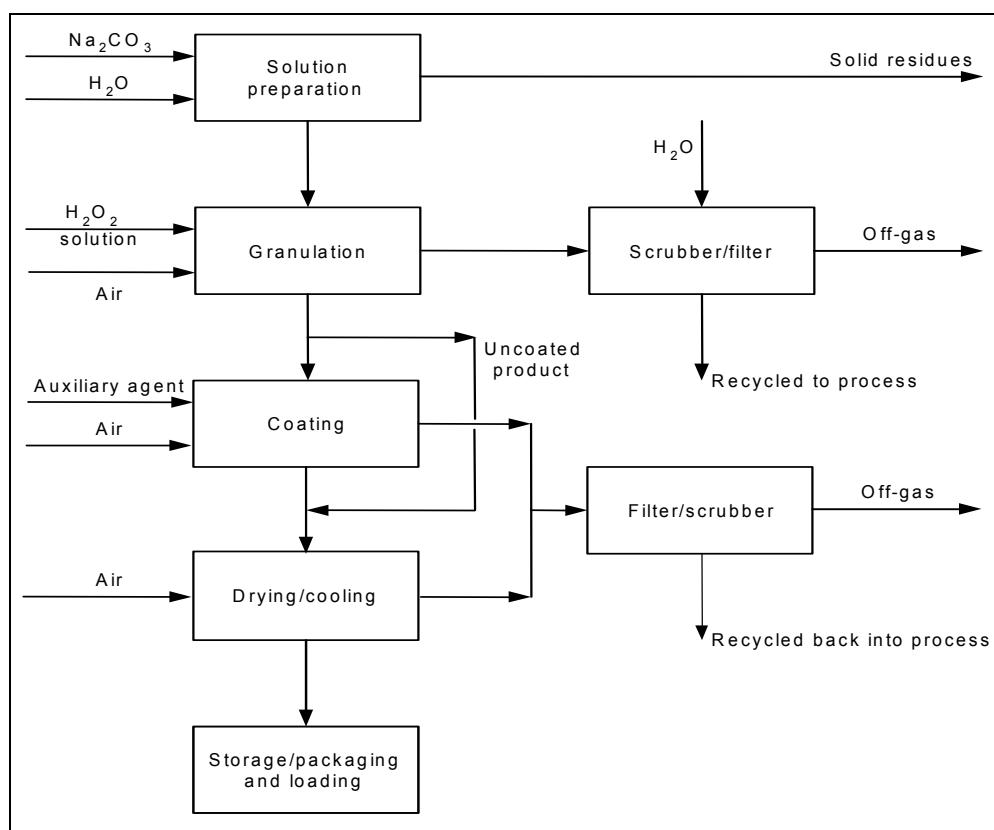
If required, the dry sodium percarbonate is cooled. The off-gas from the cooler is cleaned by an off-gas scrubber or bag filter, and if necessary, the sodium percarbonate is sieved to remove fine and coarse particles before being stored.

### 7.15.2.2.2 The spray-granulation process

In this process, fine nuclei of sodium carbonate are brought into a hot fluid bed into which hydrogen peroxide and a solution of sodium carbonate are sprayed. By continuous evaporation of water and reaction of the components, the nuclei grow until they reach the required size and they are then removed from the process [57, CEFIC-PEROXYGENES, 2004].

The production of sodium percarbonate by the spray-granulation process is a single-step process according to the reaction equation above. In a fluid bed reactor, a sodium carbonate solution is sprayed with  $\text{H}_2\text{O}_2$  solution on seed crystals, thus forming sodium percarbonate granules. In a subsequent, optional process step, the percarbonate granules can be coated by special auxiliary materials.

The typical spray-granulation production process is shown in the flow diagram in Figure 7.43.



**Figure 7.43: Sodium percarbonate production by the spray-granulation process**  
[57, CEFIC-PEROXYGENES, 2004]

The sodium carbonate is fed from the storage silo into the sodium carbonate solution preparation vessel. By adding water, sodium carbonate is dissolved together with recovered material from the scrubber or filter sections. This process step can be operated continuously or batch wise.

Sodium carbonate solution can contain a low amount of insolubles which, in some cases, are partially removed by decantation or filtration. In some cases, flocculation aids may be used to improve the separation of the insolubles. Due to the high quality of the raw material, the volume of the filtration residues is very low.

The preparation of the sodium carbonate solution is an exothermic process. Due to the rise in temperature, there is no need to heat this solution for the subsequent process step.

In a fluid bed granulator, the sodium carbonate solution and a  $\text{H}_2\text{O}_2$  solution are sprayed simultaneously onto small percarbonate seed crystals which grow to granules of the desired size. The water coming from the raw material solutions is removed by means of hot air. The drying air can be heated with steam, electrical energy or gas.

In addition to the major raw materials, there are a number of miscellaneous auxiliary materials which may be added to the process for their various attributes such as stabilisation of the sodium percarbonate product. All of these are regarded to have minimal environmental impact.

Before being discharged into the atmosphere, the off-gas from the fluid bed granulator is led through a wet scrubber or bag filter. The wet scrubber is operated with water, forming the scrubber solution, which is recycled back into the sodium carbonate solution preparation. The fines from the bag filter are also recycled back into the process.

If required, the dry sodium percarbonate is cooled down. The off-gas from the cooler is cleaned by an off-gas scrubber or bag filter, and if necessary, the sodium percarbonate granules are sieved to remove the fine and the coarse particles which are fed back into the process.

### 7.15.2.2.3 The coating process

Here, the crystals or granules are sprayed with an aqueous solution of auxiliary agents, and dried in a fluid bed dryer. By the continuous evaporation of water, a layer is built to a certain thickness and thereafter the particles are dried to form the final coated product.

The storage stability of sodium percarbonate is usually improved by the addition of stabilisers in the crystallisation and spray-granulation processes. An additional form of stabilisation consists of coating the sodium percarbonate granules with different auxiliary agents (see flow diagrams in Figure 7.42 and Figure 7.43).

Normally, the coating process takes place in a fluid-bed coater. The drying air can be heated with steam, gas or electric energy.

Before being discharged into the atmosphere, the off-gas from the dryer is led through a wet scrubber or bag filter. The wet scrubber is operated with mother liquor which is recycled back into the process. The fines collected from the bag filter are also recycled back into the process.

If required, the dry coated sodium percarbonate is cooled down. The off-gas from the cooler is cleaned by an off-gas scrubber or bag filter, and if necessary, the coated sodium percarbonate is sieved to remove fine and coarse particles before being stored.

## 7.15.3 Present consumption and emission levels

### 7.15.3.1 Raw materials

The following list gives the main raw materials used in the production of sodium percarbonate:

- sodium carbonate
- hydrogen peroxide
- sodium salt (e.g. sodium chloride, sodium sulphate).

Sodium carbonate can be natural soda ash or produced by the Solvay process.

Hydrogen peroxide is produced by the anthraquinone process.

The Table 7.85 shows the consumption of the main raw materials per one tonne of sodium percarbonate. These are comparable for the two processes, except for the consumption of salt, which is only used in the crystallisation process.

The main raw materials of sodium percarbonate	Units	Consumption min/max
Sodium carbonate	kg/t sodium percarbonate final product	573/720
Hydrogen peroxide	kg 100 %/t sodium percarbonate final product	310/485
Salt	kg/t sodium percarbonate final product	29/150

**Table 7.85: Consumption of the main raw materials in the production of sodium percarbonate [57, CEFIC-PEROXYGENES, 2004]**

### 7.15.3.2 Utilities

#### 7.15.3.2.1 Thermal media (steam and natural gas)

In the production process of sodium percarbonate, steam and/or natural gas are important energy transfer media. Thermal energy is used to heat up the mother liquor, to boil out reagents from crystallisers and to heat the air used in the spray-granulation process. It is also used in the drying of sodium percarbonate and in the coating process.

### 7.15.3.2.2 Cooling media

Some steps in the production of sodium percarbonate require cooling. Cooling is needed predominantly in the crystallisation process (to remove the heat of the reaction). Water is normally used as a cooling medium. In a closed cooling system, other cooling media such as a mixture of glycol and water or a brine solution can be used. The closed cooling system requires the use of either cooling towers or cooling equipment. With open cooling systems, fresh water from different sources is used.

### 7.15.3.2.3 Electric energy

Electric energy is needed to operate machinery for the different process steps such as cooling equipment, pumps, centrifuges, blowers, heating, etc.

### 7.15.3.2.4 Total energy consumption

The total energy consumption in the production of sodium percarbonate is between 2 GJ/t and 12.6 GJ/t sodium percarbonate final product for the crystallisation process route, and up to 12.6 GJ/t sodium percarbonate final product for the spray-granulation process route.

In the production of sodium percarbonate by the crystallisation route the energy consumption is linked to the emission of sodium salts discharged with excess mother liquor to water and, therefore, can vary in a broad range, between 2 GJ/t and 12.6 GJ/t sodium percarbonate final product [85, EIPPCB, 2004-2005].

In this route, in the case of a low energy consumption in the range of 2 – 4 GJ/t PCS product, the emission of sodium salts is below 80 kg Na/t PCS product, while in the case of a high consumption of energy of up to 12.6 GJ/t PCS product, the emission of sodium salts can be reduced to below 10 kg Na/t PCS product [85, EIPPCB, 2004-2005].

In turn, in the production of sodium percarbonate by the spray-granulation route (an almost water-free process), with the consumption of energy of up to 12.6 GJ/t PCS product, the emission of sodium salts can be maintained at a level below 10 kg Na/t PCS product [85, EIPPCB, 2004-2005].

## 7.15.3.3 Emissions

### 7.15.3.3.1 Dust emissions

Dust emissions occur mainly in the spray-granulation, drying and coating sectors of sodium percarbonate production. The exhaust air from the dryers is cleaned by means of bag filters or wet scrubbers. In this way, the dust content in the air that is discharged into the atmosphere is greatly reduced. In addition, filters or scrubbers are used for dust abatement during conveying, packing and loading. The level of dust emission is up to 0.62 kg of dust/t sodium percarbonate final product [57, CEFIC-PEROXYGENES, 2004].

It is reported that in the Austrian plant, when applying bag filters, the sodium percarbonate dust emissions of far below 5 mg/Nm<sup>3</sup> are achieved. In turn, the CEFIC PCS Subgroup considers that with techniques such as bag filters or wet scrubbers, the achievable dust emission value is below 20 mg/Nm<sup>3</sup> air [85, EIPPCB, 2004-2005].

### 7.15.3.3.2 Water emissions

Water emission sources are the excess mother liquor from the centrifugation step and cleaning water. A major part of mother liquor is recycled while a minor part of it is treated and discharged. The mother liquor contains sodium salts. Cooling water from an open system can also be discharged together with the treated mother liquor. The emission of sodium salts into the water varies up to 80 kg sodium/t sodium percarbonate final product and depends on the process route and the amount of water being added and evaporated in the process [57, CEFIC-PEROXYGENES, 2004].

In the production of sodium percarbonate by the crystallisation route, the emission of sodium salts into water varies in the range <10 – 80 kg Na/t sodium percarbonate product, and depends on the amount of mother liquor directed to the waste water treatment unit, and then discharged to water [85, EIPPCB, 2004-2005]. The lower the excess of mother liquor discharged to water, the lower the emissions of sodium salts to water, but at the same time, the higher the energy required for the evaporation of water from the mother liquor – refer to Section 7.15.3.2.4 above.

In the production of sodium percarbonate by the spray-granulation process route, the emission of sodium salts into the water is below 10 kg Na/t sodium percarbonate product [85, EIPPCB, 2004-2005].

## 7.15.4 Techniques to consider in the determination of BAT

**Introduction: Techniques to consider in the determination of BAT – refer to Section 7.1.4**

The use of the pure raw materials as specified in Section 7.15.3.1, as well as the process steps described in Section 7.15.2, for dissolution, crystallisation and centrifugation, granulation, drying and cooling respectively, have been taken into account in analysing techniques to consider in the determination of BAT for the production of sodium percarbonate [57, CEFIC-PEROXYGENES, 2004]. Industry has selected and developed the applied techniques over many years in multiple locations which have resulted in the application of mature processes on an industrial scale. In 2004, more than 90 % of the equipment installed was less than 10 years old which means that the processes reflect up-to-date environmental practices [57, CEFIC-PEROXYGENES, 2004]. Further improvements, especially with regard to the environment, are mainly in the fine tuning of the current processes and are expected to result in marginal changes with regard to emissions.

### 7.15.4.1 Raw materials used for the production of sodium percarbonate

#### Description

The purity of the technical sodium carbonate grades has improved over the last few decades and has resulted in very low emissions of solid residues from the solution preparation step. However, sodium carbonate contains very low amounts of insolubles, and sodium carbonate solution can still be purified to improve the stability of the sodium percarbonate produced. A purification step can make use of small amounts of additives which result in precipitates that can be removed by decantation or filtration together with the insolubles present in the sodium carbonate. The waste quantities resulting from the separation step are kept to a minimum as the sodium carbonate used is of high purity.

For hydrogen peroxide, the most important aspect is its concentration which can typically vary between 40 and 70 %. The higher the H<sub>2</sub>O<sub>2</sub> concentration, the less water is added to the process, which results in a reduction of excess mother liquor and also a reduced loss of sodium salt with the mother liquor.

#### Achieved environmental benefits

The use of pure raw materials in the production of sodium percarbonate, in particular purified sodium carbonate solution and concentrated H<sub>2</sub>O<sub>2</sub>, helps to minimise the amount of mother liquor and to reduce the amount of energy used in the process. The use of pure raw materials also reduces the quantity of solid residues.

#### Cross-media effects

The production of a high concentration hydrogen peroxide requires more energy. The insolubles, introduced with the raw materials, are removed from the process as solid residues.

#### Operational data

The production of sodium percarbonate is carried out according to the crystallisation and the spray-granulation process routes in which soda ash and hydrogen peroxide are the main raw materials used – refer to Table 7.85, as well as to Figure 7.42 and Figure 7.43. The insolubles contained in the sodium carbonate solution, sodium chloride, and the recycled mother liquor, are removed from the process by decantation/filtration as solid residues. The concentration of the input H<sub>2</sub>O<sub>2</sub> is typically between 40 and 70 %.

#### Applicability

Applicable to the plants producing sodium percarbonate by the crystallisation and the spray-granulation process routes.

#### Economics

No data submitted.

#### Driving force for implementation

High material and energy efficiency in the process, leading to the minimisation of the impact of the production of sodium percarbonate on the environment. Improved stability of the product.

#### Example plants

The sodium percarbonate plant in Hönningen, Germany.

The sodium percarbonate plant in Bussi, Italy.

The sodium percarbonate plant in Althofen, Austria.

#### Reference literature

[57, CEFIC-PEROXYGENES, 2004].

### **7.15.4.2 Energy consumption in the production of sodium percarbonate**

#### Description

In the crystallisation process, the crystalliser is cooled to remove the heat of the reaction and to decrease the temperature to reduce the solubility of the sodium percarbonate. The crystals are then separated in a centrifuge and it is advantageous to achieve low surface moisture in the centrifuge wet cake. A low moisture content of the wet cake reduces the energy input for the sodium percarbonate drying step.

It should be noted, however, that in the crystallisation route, for a low energy consumption in the range of 2 – 4 GJ/t PCS product, the emission of sodium salts is at a higher level of up to 80 kg Na/t PCS product. In order to achieve the level of the emission of sodium salts to water of <10 kg Na/t PCS product, a much higher consumption of energy of up to 12.6 GJ/t PCS product is required.

In the spray-granulation process, water coming from both the sodium carbonate and hydrogen peroxide solutions has to be evaporated in the granulator, which results in a higher use of energy for the granulation and drying steps. The total energy consumption in this process route is up to 12.6 GJ/t PCS product.

### Achieved environmental benefits

The crystallisation process route is typically characterised by lower energy requirements and, therefore, by lower direct/indirect impact of combustion products on the environment. In turn, the spray-granulation process, characterised by much higher energy usage, is almost a waste water free process.

### Cross-media effects

In the crystallisation process route, in which the centrifugation step is used, a waste water treatment unit is required, so a relationship between energy consumption and emissions of sodium salts to water exists (the lower the energy usage, the higher the emission of sodium salts to water, and vice versa) – refer to Sections 7.15.3.2.4 and 7.15.3.3.2 above.

In the spray-granulation process, depending on the thermal medium used (steam or natural gas), there is an indirect or a direct impact of combustion products on the environment.

### Operational data

The production of sodium percarbonate is carried out according to the crystallisation and the spray-granulation process routes – refer to Figure 7.42 and Figure 7.43. Depending on the process used, the total energy consumption in the production of sodium percarbonate is between 2 GJ/t and 12.6 GJ/t sodium percarbonate final product (crystallisation route) or up to 12.6 GJ/t (spray-granulation route) – refer to Sections 7.15.3.2.4 and 7.15.3.3.2 above.

### Economics

No data submitted.

### Driving force for implementation

High energy efficiency in the process, leading to the minimisation of the impact of the production of sodium percarbonate on the environment.

### Example plants

The sodium percarbonate plant in Hönningen, Germany.

The sodium percarbonate plant in Bussi, Italy.

The sodium percarbonate plant in Althofen, Austria.

### Reference literature

[57, CEFIC-PEROXYGENES, 2004], [85, EIPPCB, 2004-2005].

## **7.15.4.3 Purification of the exhaust air**

### Description

The required drying air has to be scrubbed or filtered to remove dust particles, before being released into the environment. Both techniques allow the return of the separated dust to the process.

### Achieved environmental benefits

The dedusting of the air used for drying the sodium percarbonate product has a direct positive impact on the environment, as the outlet air is cleaned and dust is recycled back into the process.

### Cross-media effects

There are no reported disadvantages caused by the implementation of this technique.

### Operational data

The exhaust air from the dryers is cleaned by means of bag filters or wet scrubbers. In addition, filters or scrubbers are used for dust abatement during conveying, packing and loading. The dust is recycled back to the process. The level of dust emission is up to 0.62 kg of dust/t of sodium percarbonate final product. It is reported that in the Austrian plant, when applying bag filters, sodium percarbonate dust emissions of far below 5 mg/Nm<sup>3</sup> are achieved.

In turn, the CEFIC PCS Subgroup considers that with techniques such as bag filters or wet scrubbers, the achievable dust emission value is below 20 mg/Nm<sup>3</sup> air.

#### Applicability

Applicable to the plants producing sodium percarbonate and using fluid bed dryers.

#### Economics

No data submitted.

#### Driving force for implementation

The protection of the environment.

#### Example plants

The sodium percarbonate plant in Hönningen, Germany.

The sodium percarbonate plant in Bussi, Italy.

The sodium percarbonate plant in Althofen, Austria.

#### Reference literature

[57, CEFIC-PEROXYGENES, 2004], [85, EIPPCB, 2004-2005].

### **7.15.4.4 Minimisation of waste water discharged from the process**

#### Description

In the crystallisation process, the quantity of excess mother liquor from the centrifugation step depends, amongst others, on the concentration of the hydrogen peroxide and the wash-water used.

The quantity of excess mother liquor and the related sodium salt emission can be reduced by a reduction in the quantity of water introduced into the process or by an increase of the water removed from the process.

Some possibilities are: the use of concentrated hydrogen peroxide solution, the reduction of the wash-water quantity used in the centrifugation step and the evaporation of water from the excess mother liquor. All these methods, however, will result in a higher consumption of energy as more water needs to be evaporated – refer to Sections 7.15.3.2.4 and 7.15.3.3.2 above.

The spray-granulation process generates a low waste water flow, as the excess mother liquor flow is negligible and water is only generated during washing and cleaning.

#### Achieved environmental benefits

Optimum water balance in the process results in a reduced amount of waste water generated in the production of sodium percarbonate.

#### Cross-media effects

As the mother liquor can contain relatively high amounts of sodium salts, the discharge of the treated waste water could cause some environmental impact depending on the location of the sodium percarbonate plant.

However, the lower the amount of excess mother liquor discharged from the plant, the higher the consumption of energy – refer to Sections 7.15.3.2.4 and 7.15.3.3.2.

#### Operational data

It is advantageous to reduce the amount of water added to the process, as this reduces the amount of excess mother liquor or the quantity of water that needs to be evaporated. The emission of sodium salts into the water varies in the range below 10 – 80 kg sodium/t sodium percarbonate final product, and depends on the process route and the amount of water being added and evaporated in the process.



### Applicability

This technique is applicable to the plants producing sodium percarbonate, in particular to the plants based on the crystallisation process route.

### Economics

No data submitted.

### Driving force for implementation

The protection of the environment.

### Example plants

The sodium percarbonate plant in Hönningen, Germany.

The sodium percarbonate plant in Bussi, Italy.

The sodium percarbonate plant in Althofen, Austria.

### Reference literature

[57, CEFIC-PEROXYGENES, 2004].

## **7.15.5 Best Available Techniques for the manufacture of sodium percarbonate**

For general information on understanding a BAT section and its contents, see Section 7.1.5.

Sodium percarbonate ( $\text{Na}_2\text{CO}_3 \cdot 1.5 \text{H}_2\text{O}_2$ ), obtained by the reaction of sodium carbonate solution with 40 – 70 % hydrogen peroxide solution is currently manufactured in the EU using the wet crystallisation process and by the dry fluidised-bed process.

More than 90 % of the installations are less than 10 years old and use up-to-date environmental practices.

In both process routes, the raw sodium percarbonate product is coated to improve its stability. Accordingly, for each of these process routes, BAT conclusions are drawn separately, as follows.

### **For the production of sodium percarbonate by the crystallisation route, BAT is to:**

1. Reduce emissions of sodium salts to water to <10 – 80 kg Na per tonne of sodium percarbonate product by purifying sodium carbonate solution, using as concentrated as possible (40 – 70 %) hydrogen peroxide solution and adding low amounts of wash-water, which aim to decrease the volume of both the recycled and the excess mother liquor in the process and the resulting discharges to water (see Sections 7.15.2.2.1, 7.15.3.1, 7.15.3.2.4, 7.15.3.3.2, 7.15.4.1 and 7.15.4.4).

Note:

The emissions of sodium salts to water depend on the energy consumption in the process; the lower the emission of sodium salts to water, the higher the energy usage.

2. Minimise the consumption of energy in the process within the maximum operational range of 2 – 12.6 GJ per tonne of sodium percarbonate final product, by reducing the volume of both the recycled and the excess mother liquor in the process, and by optimising the operations of crystallisation by cooling, centrifugation (to a moisture content of 5 – 15 %) and subsequent fluid-bed drying (see Sections 7.15.2.2.1, 7.15.3.2.4, 7.15.3.3.2 and 7.15.4.2).
3. Reduce dust emissions to air to below 5 – 20 mg/Nm<sup>3</sup> of the outlet air by using bag filters or wet scrubbers, as appropriate. Wet scrubbers operate at the upper end of the range (see Sections 7.15.3.3.1 and 7.15.4.3).

---

**For the production of sodium percarbonate by the spray-granulation route, BAT is to:**

1. Minimise the consumption of energy in the process within the range of 2 – 12.6 GJ per tonne of sodium percarbonate final product by optimising the process parameters. In particular, in the fluid-bed spray-granulation step, the upper end of the range is more likely to be achieved – see Sections 7.15.2.2.2, 7.15.3.2.4 and 7.15.4.2.

**Note:**

The emissions of sodium salts to water in the spray-granulation process can be maintained at the low level of <10 kg Na per tonne of sodium percarbonate product.

2. Reduce dust emissions to air to below 5 – 20 mg/Nm<sup>3</sup> of the outlet air by using bag filters or wet scrubbers, as appropriate. Wet scrubbers operate at the upper end of the range (see Sections 7.15.3.3.1 and 7.15.4.3).

## 7.16 Sodium sulphite and related products

### 7.16.1 General Information

#### 7.16.1.1 Introduction

A general review of associated 'sulphite' production is presented, driven by the practical arrangement of the larger industrial manufacturing plants, where a range of related sulphites, bisulphites, metabisulphites and thiosulphates are produced on integrated processing plants. These plants produce not only the sodium salts, but also the equivalent potassium and ammonium compounds, in solution, crystal and anhydrous forms.

This section on sodium sulphite and related products, including sodium hydrogen sulphite (i.e. sodium bisulphite) and sodium thiosulphate, deals with activities within a sector of the inorganic chemicals industry, specifically the production of solids and solutions typified by sodium sulphite. These are materials generally formed by the reaction of sulphur dioxide with a strong base solution, or by an analogous sub-process. Throughout this section, this family of products are referred to generically as 'sulphites' [61, Entec UK Limited, 2004].

The total production of the sulphites described herein is over 300 kt/year within Europe.

#### 7.16.1.2 Chemicals

The chemicals described within this section are characterised as being formed from a cation, such as sodium, potassium or ammonium, derived from a strong base solution, and an anion such as a sulphite, derived from an aqueous-phase reaction with sulphur dioxide. Associated processes produce equivalent bisulphites, metabisulphites and thiosulphates. These materials are sensibly grouped within this section, as they are made by a limited number of manufacturers across Europe, using bespoke and integrated facilities to produce a range of these materials. Typical chemicals included in the 'sulphite' group are shown in Table 7.86.

Chemical	Formula	Common uses
Sodium sulphite (anhydrous, crystalline, and 20 % solution)	$\text{Na}_2\text{SO}_3$	Water treatment, food manufacture, photography
Sodium/Ammonium bisulphite	$\text{NaHSO}_3/\text{NH}_4\text{HSO}_3$	Water treatment, oil industry, food manufacture
Sodium/Ammonium thiosulphate	$\text{Na}_2\text{S}_2\text{O}_3/(\text{NH}_4)_2\text{S}_2\text{O}_3$	Photography
Potassium sulphite	$\text{K}_2\text{SO}_3$	Photography
Sodium metabisulphite	$\text{Na}_2\text{S}_2\text{O}_5$	Miscellaneous chemical manufacture, water treatment

Table 7.86: The chemicals included in this section on sodium sulphite and related products [61, Entec UK Limited, 2004]

#### 7.16.1.3 Background information

##### 7.16.1.3.1 European manufacturing locations

Table 7.87 gives the European manufacturing locations of sodium sulphite and related products.

Location	Main Products	Total kt/year
Germany	Sodium sulphite, bisulphite and metabisulphite	157
	Potassium sulphite and other salts (in solution)	10
	Sodium dithionite (hydrosulphite)	50
Belgium	Sodium bisulphite	25*
Germany	Sodium bisulphite	Not known
France	Sodium bisulphite	Not known
United Kingdom	Sodium sulphite, bisulphite and metabisulphite	65
	Ammonium bisulphite, thiosulphate	
Italy	Sodium sulphite, bisulphite and metabisulphite. Ammonium bisulphite, thiosulphate	65?
Germany	Thiosulphates	Not known
Germany	Ammonium bisulphite, thiosulphate	Not known

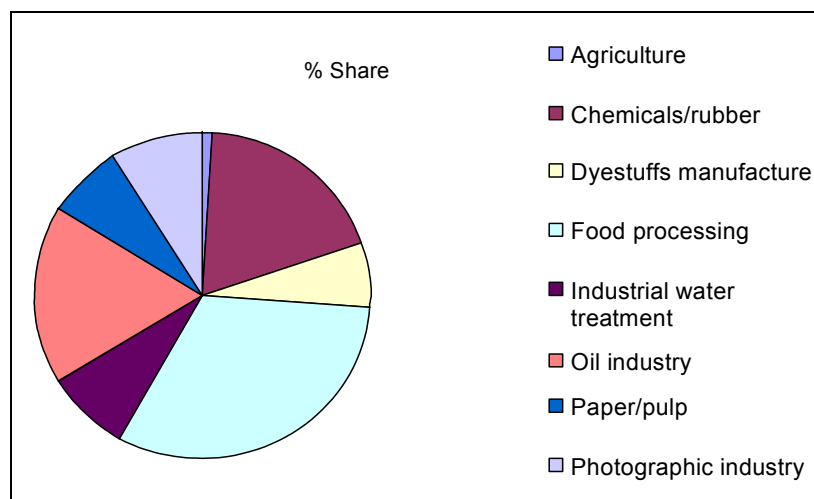
\* Capacity 36 kt/year

**Table 7.87: European manufacturing locations of sodium sulphite and related products [61, Entec UK Limited, 2004]**

### 7.16.1.3.2 Sulphite markets

Sulphite materials are mainly classed as commodity products, sold through intercompany trading, both direct to customers and via agents, with some specialised formulations made for particular customers or market needs. Markets are generally long established and represent traditional operations, such as the food industry, general chemicals and the oil industry. These are mature markets and track general GDP growth, with no significant new market areas in recent years. Use of all of the sulphite materials considered here is widespread across Europe, although the major manufacture is concentrated in Germany, Italy and the United Kingdom. A significant reduction has been seen in sales of chemicals for traditional photographic processing, through recent moves to digital photography, a trend expected to continue for some time.

Figure 7.44 shows a typical split of sulphite products by market sector, demonstrating the breadth of market distribution for this range of materials.



**Figure 7.44: Market sector distribution for sulphite chemicals in Europe [61, Entec UK Limited, 2004]**

### 7.16.1.3.3 EU-15 trade

Sulphite materials are extensively traded across the EU-15. For statistical purposes, the market is divided into three categories; sodium sulphite, other sulphites and thiosulphates.

### **Sodium sulphite**

Over 100 kt of sodium sulphite are traded within the EU-15, with all the major EU economies active in this market, reflecting the widespread use of this particular material. Exports of almost 40 kt are made to over eighty non-EU-15 countries, mainly from the major manufacturing locations. Some 10 kt of sodium sulphite was reported to be imported from outside of the EU-15 in 2002.

### **Other sulphites and thiosulphates**

By comparison, overall trade in 'other sulphites' (potassium sulphite, sodium bisulphite, etc.) is below 120 kt per year. Trade in thiosulphates is around 40 kt per year, with over 90 % being inter-EU-15 trade. The EU-15 is therefore largely self-sufficient in the manufacture of the sulphite family group of products. Turkey, the US, China and Thailand are significant sources of imports for some materials into the EU-15.

## **7.16.2 Industrial processes used**

### **7.16.2.1 Introduction**

The basis of the production of this family of sulphite chemicals is the reaction of sulphur dioxide with an alkali, in either batch or continuous processes. The major producers also manufacture sulphur dioxide on site, and for them this stage is a fully integrated part of the sulphite production, as sulphur dioxide is usually created for this purpose. In some cases, sulphite production may also be undertaken in facilities which are located on part of a much larger facility, allowing sulphur dioxide generated from other chemical manufacturing processes, to be used for sulphite production, and process gas from sulphite production to be recycled into other chemical manufacturing processes (e.g. the sodium bisulphite plant in Belgium integrated with the regeneration of spent sulphuric acid and the production of sulphuric acid) [85, EIPPCB, 2004-2005]. Smaller producers purchase and store sulphur dioxide on-site as a liquefied gas, under pressure.

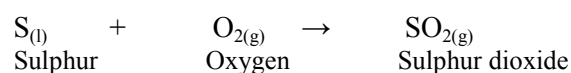
The production of sulphur dioxide is achieved by the burning of liquid sulphur, which may be delivered to the site as a liquid, or as solid sulphur that is subsequently melted prior to combustion. Sulphur dioxide is normally made and consumed continuously, giving a low or zero inventory of sulphur dioxide on site. This stage is further described in Section 7.16.2.2.1.

Absorption and reaction of the sulphur dioxide in alkali solutions create the sulphites, either in continuous/campaign processes, or in batches. Manufacturing facilities are typically integrated to allow centrifuge liquors from one process to be recycled or used as the raw material for associated processes. The reaction of the acid gas and alkali is generally a rapid reaction, and good design allows high yields to be achieved, minimising losses to the environment. Typical sulphite reactions are described in Section 7.16.2.2.2, below, and the environmental releases in Section 7.16.3.

### **7.16.2.2 Primary processes**

#### **7.16.2.2.1 Sulphur burning**

Solid sulphur is melted, or liquid sulphur at approx. 145 °C is used directly, and burned in a proprietary burner to produce a sulphur dioxide (SO<sub>2</sub>) stream in air, typically at 16 – 17 vol-% with less than 0.1 % sulphur trioxide (SO<sub>3</sub>). The gas stream from the burner is at a high temperature and the surplus heat is typically recovered to produce steam – see energy and waste heat (Section 7.16.2.3.6 below). The gas is further cooled and scrubbed to remove the sulphur trioxide. Water/weak sulphuric acid is typically used as the scrubbing and cooling medium in the process, and strong commercial grade sulphuric acid is created for sale as a by-product. The SO<sub>2</sub> rich gas stream is fed forward and further reacted, as described below. Sulphur burning is advantageously carried out at slightly negative pressure in order to eliminate emissions from this stage of the process:



A flow diagram for sulphur burning to produce sulphur dioxide is given in Figure 7.45.

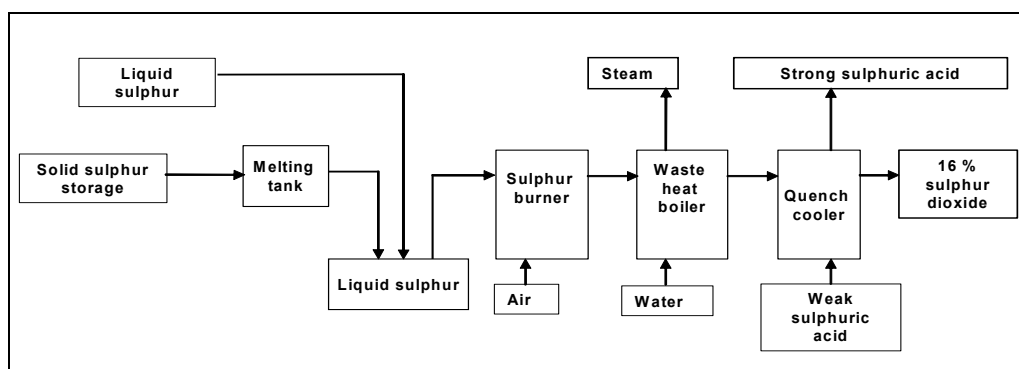
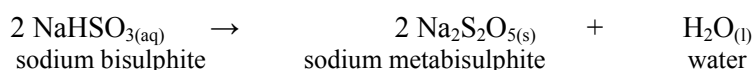
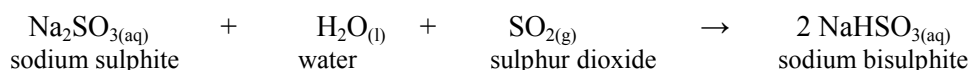
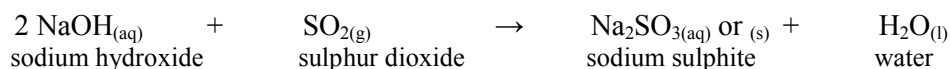


Figure 7.45: Flow diagram for sulphur burning to produce sulphur dioxide [61, Entec UK Limited, 2004]

#### 7.16.2.2.2 Reaction of sulphur dioxide and alkalis

##### Continuous reactions

Where sulphur dioxide is produced on site, it is absorbed continuously into an alkali associated with the primary product. Most typically, this is sodium hydroxide solution as a precursor to producing materials such as sodium sulphite, sodium bisulphite, or sodium metabisulphite, although potassium and ammonium equivalents could be similarly produced. The final product is determined by the presence of other reactants, or pH control:



Reactions of gases and liquids are normally done in continuous contacting equipment such as absorption towers, or in continuous-batch reactors providing a countercurrent flow of the reagents. Final scrubbing of sulphur dioxide to minimise sulphur dioxide losses is also made by a strong alkaline solution, which further contributes to a countercurrent absorption train. A plant made of non-corrosive materials, such as stainless steel or glass reinforced plastics (GRP) is required for these duties, both to maintain the quality of the returned liquors and plant integrity.

For solid products, the liquors containing the suspended crystals are subsequently thickened, centrifuged and dried – see Section 7.16.2.2.3 below. Centrifuge liquors from these processes are weak bisulphite or sulphite solutions, which in turn can be sold, further reacted into thiosulphates for example, or re-crystallised and dried to recover the solid product.

##### Batch reactions

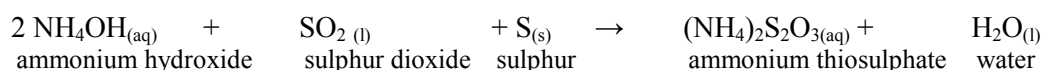
All of the above continuous processes can also be carried out in conventional agitated batch reactors, using an interruptible supply of sulphur dioxide, although for large volume products economic pressures normally dictate some form of continuous production. Some products are made in a batch plant because these do not require a direct reaction with sulphur dioxide, or because the volume requirements and production patterns lend themselves to batch processes, albeit normally in campaigns.

Operators using liquefied sulphur dioxide can more readily adopt this route, as the supply of sulphur dioxide can be sensibly interrupted, whereas making sulphur dioxide from sulphur burning is a continuous process that generally requires continuous consumption.

Processes requiring the additions of solids are also often less problematic to operate in batches. An example of this is the production of thiosulphates, where free sulphur addition is required:



The sodium salt can be produced as crystals or anhydrous by subsequent crystallisation or drying. Other forms, such as ammonium thiosulphate, can be made similarly, or by direct use of sulphur dioxide:



For reactions using pure sulphur dioxide, a very high fraction is absorbed in the primary process, often close to 100 %. The remainder is then absorbed in a conventional alkaline scrubber and the liquor is used in subsequent batches.

### 7.16.2.2.3 Centrifuging, drying and packaging

Many of the sulphite family of products are sold as crystalline or anhydrous materials, and these are made from solutions using conventional chemical processing techniques, such as thickeners and centrifuges; direct, indirect and vacuum dryers, and the packaging unit. Liquors separated from crystallisation/centrifuging operations are recycled back into process to reclaim the chemical constituents, either directly or via intermediate storage in the case of batch production. Releases to air from the solids handling operations, containing particulate matter and acid gas, may also be scrubbed and the weak liquors reclaimed into subsequent processes.

## 7.16.2.3 Associated processes

### 7.16.2.3.1 Raw materials storage and use

Most raw materials used in these processes require quite standard chemical industry storage and handling (e.g. bunded tanks, pumps, and standard warehouse facilities) and are not discussed further. However, the storage of the following materials may be of note:

- solid sulphur is typically stored in loose heaps and moved by mechanical shovels to the melting plant. Fire is always a risk and great care needs to be taken to minimise friction and to control sulphur dust during delivery and use
- molten sulphur is delivered by road tanker with blown discharge. Consideration needs to be given to the potential for hydrogen sulphide (H<sub>2</sub>S) displacement during off-loading, and abated if required. Molten sulphur will readily block process equipment or drains if heating is not maintained
- sulphur dioxide and anhydrous ammonia are stored as liquefied gases, under pressure, and such storage is subject to stringent safety measures under other legislation. Venting of any part of these systems requires comprehensive measures to absorb the gases, and high integrity systems should also be in place to minimise accident hazards.

The various end uses of these products, including the food and photographic industries, dictate that high quality raw materials are used. An excessive iron content in sulphur can be a particular quality concern for photographic chemicals.

### 7.16.2.3.2 Process control techniques

As acid-alkali reactions, most of the continuous sulphite-family processes are controlled by pH, which has a key influence on the product quality, yields and impact on the environment. The reliability and longevity of pH electrodes is not high under some conditions, however, and this control is frequently reinforced by measurement and control of flowrates, spot-sampling and external testing. For batch processes, raw materials are measured into reactors as the primary process control.

### 7.16.2.3.3 Air abatement techniques

Process acid gas releases are typically ducted under negative pressure, and abated by an alkaline reagent, packed bed scrubbers, 'rotoclones', or similar devices, with the absorption liquor then returned into the main production process. The flows of sulphur dioxide and the alkali reagents create multistage, countercurrent contacting, for both continuous and batch processes, with devices such as mist eliminators being used after any wet scrubbers. Using combined systems such as these, high overall absorption efficiencies, in excess of 99.8 % of the sulphur dioxide used, can be achieved. See Table 7.90 for typical release concentrations.

Abatement of particulate matter from dryer vents can create blockages in packed-bed systems, and fluid bed scrubbers may be the preferred absorption technique where high particulate loading and acid gases occur together. High specific energy use precludes the more general use of fluidised-bed dryers in non-dusty gas streams. Fugitive releases are primarily controlled by plant maintenance and good operating techniques to minimise gas and dust levels in the workplace, with capture hoods, etc. used to collect localised releases from vessel manholes, packaging areas and so on. These should also be directed to a scrubber before release. Final product distribution, transfers and packaging may also lead to displacement losses of air containing sulphur dioxide. Particular care needs to be taken with low pH products, where the high sulphur dioxide vapour-pressure may require abatement, which often takes the form of back venting to scrubbers at the reaction stage.

### 7.16.2.3.4 Other waste treatment

Aqueous wastes from these processes mainly come from cleaning of the plant or transport containers, and may be acid or alkaline, and can be reducing agents. Materials are, therefore, typically oxidised to the sulphate forms, to prevent decomposition and release of sulphur dioxide, and then corrected for pH before release. Settling or filtration, generally producing a stable sludge or cake for landfill, removes insoluble materials, most particularly excess sulphur, thiosulphate and sulphate, filter media and de-colourising carbon, and metals rendered insoluble in the process. These wastes are mainly generated from thiosulphate processes and typically constitute 2 – 3 % of the product weight. Impurities and potential pollutants are preferentially removed in the filter cake rather than discharged in the effluent and further recovery is usually uneconomic.

### 7.16.2.3.5 Emissions measurement and use of data

The most significant potential emission is of sulphur dioxide, and this can be measured continuously at process release points by infrared, or by other electronic techniques, spot sampling and wet chemistry methods, adsorption tubes, and so on. Other air releases such as hydrogen sulphide, ammonia and particulate matter, or fugitive release, can be measured by continuous or spot monitoring, depending upon the potential environmental significance. Supporting information is also available from other process monitoring, such as scrubber flows and reagent strength.



Aqueous release parameters, pH, solids, sulphite/sulphate levels, can be monitored by conventional sampling and testing methods. Comprehensive collection and analysis of these data should allow production of an overall site mass balance and hence an estimate of loss, expressed as sulphur [61, Entec UK Limited, 2004].

### 7.16.2.3.6 Energy and heat recovery

For sites with sulphur-burning facilities, heat can be recovered from the product gas to produce high pressure steam for process and heating use. There may be surplus steam produced from this source if the only significant process heating demand is for product drying, so combined heat and power (CHP) facilities should be considered. Although the final product reactions are typically exothermic, energy recovery is not normally viable from these sources as the reaction and coolant temperatures are low – normally using conventional ambient temperature water systems. All other power demand is for conventional chemical process equipment, agitators, pumps, fans, and so on.

The net energy input per tonne of product is a complex relationship between energy created (by sulphur burning) and that consumed in manufacture, where liquid products have a much lower specific energy content than dry materials. See Section 7.16.3.1 below.

### 7.16.2.3.7 Odour

Odour is a potentially significant issue from sulphur dioxide and hydrogen sulphide releases, both from process and fugitive sources. Good abatement of the main process streams should achieve very low release levels, and more attention may be required for fugitive emissions from ancillary processes, such as maintenance, cleaning and accidental release. Bulk deliveries of anhydrous ammonia or sulphur dioxide are also potential sources of odour, although the standards pertaining to the safe handling of these materials should ensure that there are no significant problems.

### 7.16.2.3.8 Decommissioning

Few significant issues are likely to be presented beyond plans to clean and decommission any sulphur facilities. Once sulphur dioxide is produced, the downstream sulphite production facilities correspond to standard chemical plants, and can be easily cleaned and decommissioned.

### 7.16.2.3.9 Management, design and training

The bespoke nature of these processes may often produce operational teams with considerable site experience, typically backed up with industry standard quality, safety and environmental management systems. Operators will normally be multi-skilled and trained on a variety of plants and processes. Similarly, significant plant design and development expertise may be found in-house, although the core manufacturing techniques for these products are well established.

### 7.16.2.3.10 Process-integrated techniques

The most significant process-integrated techniques are the concurrent manufacture and use of sulphur dioxide, which minimises inventory, and the cross-contacting of tail-gas in the abatement equipment which provides low-strength feeds for the upstream processes as well as minimising losses to the environment. Good design and operation of these facilities is fundamental in achieving a high yield, low emission production process [61, Entec UK Limited, 2004].

### 7.16.3 Present consumption and emission levels

#### 7.16.3.1 Raw material and energy consumption

##### 7.16.3.1.1 Raw materials

Sulphur, sulphur dioxide and the relevant alkali are the three main raw materials in the manufacture of all sulphite chemicals. The overall inputs for each raw material are close to the final product requirements, and the yield based on both sulphur dioxide and the alkali should approach 100 %. Some sulphur is lost to sulphuric acid (when burning sulphur) and some is lost to waste from thiosulphate reactions. Table 7.88 below shows a mass balance for products made using continuous gas feeds, typified by weak exit gas streams, which are further scrubbed in the downstream processes, and recycled liquors. Processes using pure sulphur dioxide are more intensive, and typified by very low volume vent or side-streams, as the raw materials react directly and completely to the product, with losses occurring only in filtration operations. This is typified by the entry for potassium sulphite solution.

Raw material usage in the production of sulphite chemicals is given in Table 7.88.

Product	Raw material kg input/tonne product				Loss as by-product/ environment kg/tonne product
	Sulphur	Sulphur dioxide	Alkali as solution	Other	
<b>Sulphur dioxide</b>	501	0	0	3042 (oxygen + inert gas)	2543 (gas)
<b>Sodium sulphite anhydrous</b>	0	616	542	3542 (inert gas)	3700 (gas, purge liquors)
<b>Sodium bisulphite solution</b>	0	166	216	6194 (inert gas, liquors)	5576 (inert gas)
<b>Sodium metabisulphite</b>	0	1025	1012	4290 (gas)	5327 (gas, liquors)
<b>Sodium thiosulphate 70 % solution</b>	120	0	216	1029 (liquors, water)	365 (filter cake, water)
<b>Potassium sulphite solution</b>	0	180	640	180 (water)	Negligible

**Table 7.88: Raw materials usage in the production of sodium sulphite and related products [61, Entec UK Limited, 2004]**

##### 7.16.3.1.2 Water

For plants making sulphur dioxide, water is used as a gas coolant, and in the process produces steam in the boiler, and concentrated sulphuric acid in the quench cooler. Steam is used extensively in sulphite processes where dry products are manufactured, whilst sulphuric acid is sold as a by-product. High quality or treated water will be required for some of these uses. Water is also present as a raw material in the hydroxide solutions, which are used as nominally 30 % (for ammonia) to 50 % solutions, and as a make-up stream in some sulphite processes.

Water is also created in some reactions, and the input as a raw material is balanced to achieve the desired final product specification. For crystalline products, surplus water also appears in the centrifuge liquors, which mainly return to the process. For dry products, slurry concentrations are maximised contingent with other handling criteria, and water is lost to the air in the anhydrous product dryers. Water inputs, by-product flows and losses are, therefore, highly variable and dependent upon the particular product and process.

Water is also used as a coolant, as the main sulphite reactions are exothermic. Cooling water circuits are either closed circuit (to an on-site cooling tower, etc.) or open circuit from surface water abstraction. Evaporative and blow-down water losses occur in the closed system, whereas the open system should have close to 100 % return to the source. Water is also used for process and general plant cleaning. Where sulphite production is in batches, water use can be minimised through product campaigns and the use of clean-in-place systems. Overall, water consumption is unlikely to be a significant issue for the manufacture of sulphite.

## 7.16.3.1.3 Energy

The energy balance can be highly complex, as there are two opposing drivers that need to be assessed for any particular site. Where sulphur dioxide is manufactured from sulphur burning, the surplus heat can be used to raise steam and electrical power through a CHP plant turbine. This can make plants largely self-sufficient in steam and create a worthwhile percentage of their electrical power demand. For the manufacture of the main product, making sulphite solutions requires little process heating, whereas making dried products uses significant heat energy whilst making anhydrous products is even more energy intensive per tonne of product. Electrical power is used in conventional motor drives, and is unlikely to be a significant environmental issue. Energy balance by process is given in Table 7.89.

Process used to make the following	Tonne steam/tonne of product		GJ power/tonne product	
	Produced	Used	Produced	Used
Sulphur dioxide from sulphur burning	1 – 1.2		0.02 – 0.04	
Sulphite solutions		0.1 – 0.3		0.05 – 0.1
Anhydrous sulphites		2 – 4		0.1 – 0.2

**Table 7.89: Energy balance by process – production of ‘sulphites’ [61, Entec UK Limited, 2004]**

## 7.16.3.2 Primary environmental releases

The summary of process emissions is given in Table 7.90.

Process	Main abatement techniques	Emissions			Specific Emission (kg/t material handled) (**)
		Emissions from the process	Typical range of emissions (*) (**)	Lowest emission levels (***)	
Dry sulphur handling	Covered storage, mechanical handling	Sulphur dust (s)	Negligible	1 mg/m <sup>3</sup>	N/a
Molten sulphur storage	Alkaline scrubber	H <sub>2</sub> S (g)	1 – 5 mg/m <sup>3</sup>	1 mg/m <sup>3</sup>	Negligible
Liquid SO <sub>2</sub> storage	Alkaline scrubber	Vented SO <sub>2</sub> (g)	<50 mg/m <sup>3</sup>	<20 mg/m <sup>3</sup>	<1
Anhydrous NH <sub>3</sub> storage and ammonia solution production/storage	Water scrubber	Ammonia (g)	<20 mg/m <sup>3</sup>	5 mg/m <sup>3</sup>	<1
Sulphite reactions High load/inert carrier gas Low load/almost pure gas	Alkaline scrubbers	SO <sub>2</sub> (g)	100 – 500 mg/m <sup>3</sup>	<150 mg/m <sup>3</sup>	<2
			3 – 40 mg/m <sup>3</sup>	<20 mg/m <sup>3</sup>	
Thiosulphate reactions	Alkaline scrubbers	H <sub>2</sub> S (g)	1 – 5 mg/m <sup>3</sup>	1 mg/m <sup>3</sup>	<0.004
		SO <sub>2</sub> (g)	3 – 40 mg/m <sup>3</sup>	<20 mg/m <sup>3</sup>	<1
	Filters/presses	Solid waste/product (s)	N/a	N/a	30 – 40
Product storage vent	Alkaline scrubbers	SO <sub>2</sub> (g)	3 – 40 mg/m <sup>3</sup>	<20 mg/m <sup>3</sup>	<0.1
Dry product handling	Wet scrubbers	Particulate matter (s)	5 – 30 mg/m <sup>3</sup>	<20 mg/m <sup>3</sup>	<0.2
Effluent treatment	Settling/pH control	pH	7 – 10		N/a
		SO <sub>4</sub>	2000 – 3000 mg/l	<2000 mg/l	<0.5
		Susp. solids	100 – 300 mg/l	<500 mg/l	

Notes: (\*) As 24 hour averages; (\*\*) If the production of sulphites is integrated with other chemical manufacturing processes, other emission values may be applicable; (\*\*\*) Best performance emission levels quoted in [61, Entec UK Limited, 2004].

**Table 7.90: Summary of process emissions in ‘sulphite’ chemicals production [61, Entec UK Limited, 2004]**

### 7.16.3.3 Key environmental issues

#### 7.16.3.3.1 Emissions to air

The most significant issue for sites manufacturing sulphite chemical products is the release of sulphur dioxide to air, and to a lesser extent, the associated release of particulate matter from dry product handling, hydrogen sulphide from thiosulphates, and ammonia from ammonium salt production [61, Entec UK Limited, 2004].

#### 7.16.3.3.2 Emissions to water

Releases to water will be of sulphites, sulphates and small traces of sulphur and other particulate matter. None of these materials have environmental benchmarks in the UK and are unlikely to cause concern, although high sulphate levels can damage concrete in drainage systems and may be limited by sewage undertakers, along with sulphur compounds that could release SO<sub>2</sub> on acidification. In general, aqueous releases should be neutral – alkaline, with low solids and COD levels.

Releases to sewerage/water systems will normally derive from cleaning the process plant, back-washing of filters or drum cleaning. Heavy solids in the wash streams are mainly settled by primary treatment on site and disposed of to land (see Section 7.16.3.3.3 below).

#### 7.16.3.3.3 Solid wastes

Releases to land are generated from the filtration of products and the settling of waste streams, and primarily constitute sulphur, product thiosulphates/sulphates, filter media and contaminants or impurities such as iron, and waste packaging. The manufacture of thiosulphates generates the largest releases to land, at about 3 % of product by weight.

## 7.16.4 Techniques to consider in the determination of BAT

**Introduction: Techniques to consider in the determination of BAT – refer to Section 7.1.4**

### 7.16.4.1 Minimisation of the releases of sulphur compounds to the air

#### Description

#### **Process**

Sulphur dioxide is the major raw material for these products and is either manufactured on site from sulphur burning, or bought in as a liquefied gas. In some cases, where sulphite production is undertaken in facilities which are part of a much larger chemical industrial complex, sulphur dioxide generated at the site in other chemical processes can be used. Making sulphur dioxide at the site of sodium sulphite production, creates a low inventory/low pressure regime, but with the added complication of the manufacturing process and the disadvantages of requiring large equipment and producing large vent flows. It can, however, provide a net input of energy.

#### **Abatement**

The key driver in improving environmental performance is the successful retention of sulphur (as sulphur dioxide and hydrogen sulphide) in the process by good design and operation of the abatement systems.

#### Achieved environmental benefits

Proper design and operation of both the ‘sulphites’ plant and the abatement systems, results in the minimisation of discharges of sulphur compounds (SO<sub>2</sub> and H<sub>2</sub>S) to the atmosphere. The released sulphur compounds are recycled back into the process.

In chemical industrial complexes where sulphite production is integrated with other chemical plants, process emissions from the sulphite production can be recycled into other chemical manufacturing processes.

### Cross-media effects

Purchasing sulphur dioxide in a liquefied form creates a more significant inventory hazard, but if designed, managed and operated properly tends to lead to lower emissions to air.

### Operational data

Refer to Section 7.16.2 and Figure 7.45 above. Detailed data on emission levels are included in Section 7.16.3. In particular, specific emissions from the sulphite reactions step should not exceed 2 kg SO<sub>2</sub> per tonne of 'sulphites' produced [61, Entec UK Limited, 2004].

Reactions of sulphur dioxide with alkaline solutions are quite rapid and most material will be reacted at this stage. Manufactured sulphur dioxide carried in an air stream, will tend to bypass primary reactions more than when using the pure gas, where reactions can mainly be undertaken in closed vessels.

Both sulphur dioxide and hydrogen sulphide are highly reactive species where very high absorption efficiencies are possible using alkaline washing, which allows the sulphur compounds to be recycled back into the process. Pressurised discharges through vent pipes, or collection by negative pressure duct systems from low pressure equipment, are both used to direct vented gas to abatement equipment. Opportunities to collect and abate all process streams should be taken, and the treatment of fugitive and other gas streams should be considered in the assessment of 'BAT'.

### Applicability

This technique is applicable to the plants producing sodium sulphite and related products.

### Economics

No data submitted.

### Driving force for implementation

High level of the environmental performance, primarily aimed at mitigating the reasons of the possible SO<sub>2</sub> and H<sub>2</sub>S emissions originating from the 'sulphites' processes.

### Example plants

The 'sulphites' plant in Accrington, United Kingdom – see information included in Table 7.87.

### Reference literature

[61, Entec UK Limited, 2004].

## **7.16.4.2 Abatement technologies to reduce the emissions of SO<sub>2</sub> and H<sub>2</sub>S**

### Description

The primary abatement technology for both sulphur dioxide and hydrogen sulphide is absorption scrubbers, with alkaline reagents. These would normally be towers using conventional packing materials, using a recirculated alkaline reagent, although in some very low volume, low risk situations absorption in a single 'pot' scrubber may be adequate. Other devices such as spray towers or 'rotoclones' may be equally effective, as reaction rates are very rapid. Monitoring of the flows, strength and/or pH of the reagent, and optimisation of reagent temperature, will be the key requirements in ensuring high absorption efficiencies, and some duplication of key components such as scrubber pumps and flow indicators should be considered. Non-contaminating construction materials, such as GRP and stainless steel, are most commonly used as the products can then be reintroduced back into the process.

Achieved environmental benefits

The minimisation of discharges of sulphur compounds (SO<sub>2</sub> and H<sub>2</sub>S) to the atmosphere. The released sulphur compounds are recycled back into the 'sulphites' processes.

Cross-media effects

There are no reported disadvantages caused by the implementation of this technique.

Operational data

Refer to Section 7.16.2 and Figure 7.45 above. Data on achievable emission levels to the atmosphere, from each of the 'sulphites' process, are included in Section 7.16.3. The reagent pH should be maintained above 8.5, ideally by automated dosing, although higher pH values may cause precipitation of sodium sulphite. Scrubber sizing needs to take account of any inert carrier gas, normally air, and variations in sulphur dioxide load, which can lead to average release levels of 300 mg/m<sup>3</sup>. SO<sub>2</sub> releases from modern, smaller scrubbers with low loads are typically less than 20 mg/m<sup>3</sup>, and for hydrogen sulphide scrubbing even lower levels are achieved.

Applicability

This technique is applicable to the plants producing sodium sulphite and related products.

Economics

No data submitted.

Driving force for implementation

High efficiency level of the techniques applied for the abatement of SO<sub>2</sub> and H<sub>2</sub>S.

Example plants

The 'sulphite' plant in Accrington, United Kingdom – see information included in Table 7.87.

Reference literature

[61, Entec UK Limited, 2004].

**7.16.4.3 Dedusting systems used in the production of sodium sulphite**Description

Other losses to air can occur through raw material and dry-product handling, and conventional equipment and good operating techniques can significantly reduce the impact of these. For releases containing particulate matter, well designed primary devices to retain the product in the process should be the first consideration. Cyclone collectors and bag filters must be well operated and maintained to minimise the losses from the abatement plant. For abatement of 'dusty' gas streams, avoiding blockages will be a key consideration, and agitated absorption beds, such as fluidised bed scrubbers, may be required. If required, wet scrubbers are also applied for reducing the emissions of the dust from the dry product handling.

Achieved environmental benefits

Substantial reduction of dust emissions into the atmosphere.

Cross-media effects

There are no reported disadvantages caused by the implementation of this technique.

Operational data

Refer to Section 7.16.2 and Figure 7.45 above. Data on dust emission levels to the atmosphere, from the 'sulphites' processes, are included in Section 7.16.3. In particular, the achievable emission levels of sulphur dust are 1 mg/m<sup>3</sup>, while those relating to the dry product handling are below 20 mg/m<sup>3</sup> of the outlet air.

Applicability

This technique is applicable to the plants producing sodium sulphite and related products.

### Economics

No data submitted.

### Driving force for implementation

High level of the efficiency in the techniques used for dedusting the 'sulphites' site.

### Example plants

The 'sulphite' plant in Accrington, United Kingdom – see information included in Table 7.87.

### Reference literature

[61, Entec UK Limited, 2004]. Refer also to the BREF on Common Waste Water and Waste Gas Treatment/Management Systems in the Chemical Sector.

## **7.16.4.4 Techniques to minimise the releases to water**

### Description

#### **Process**

Releases to water are primarily generated through filter operations and plant washing. Continuous processes, dedicated plant or campaign operations reduce product changes and cleaning loads, and are encouraged, along with techniques to retain materials in the process such as self-draining pipe systems. Most sulphite products considered in this section are highly soluble and cannot sensibly be recovered once in the water streams, so prevention is essential. Techniques to optimise wash-water use and minimise the discharged volumes should also be considered. Primary monitoring/treatment for pH and sulphite levels should be undertaken, both to prevent damage to infrastructures and to minimise the potential for SO<sub>2</sub> and H<sub>2</sub>S release.

#### **Abatement**

Good settlement of wash-water and filter backwash streams will readily reduce the solid contaminant load in water discharges, and further filtration should be considered if discharging to sensitive receptors.

### Achieved environmental benefits

Control of the pH, as well as the reduction of the content of sulphates and suspended solids in the waste waters released to the environment.

### Cross-media effects

There are no reported disadvantages caused by the implementation of this technique.

### Operational data

Refer to Section 7.16.2 and Figure 7.45 above. Data on emission levels of liquid effluents to water are included in Section 7.16.3. In particular, the achievable emission levels of sulphates and suspended solids released to water are <2000 mg of SO<sub>4</sub><sup>-</sup> per litre and 500 mg SS per litre of waste water respectively. Releases to water/sewerage systems require basic control of sulphite content, pH, and solids content. Good operation of the production facilities may even reduce the need for abatement of all of these parameters.

Sulphite and thiosulphate wastes are readily treated by the addition of hypochlorite, which oxidises both species to sulphates, and pH by acid/alkali treatment, typically in a combined plant using in-line or continuous batch mixers and automatic controls on reagent additions through redox and pH probes. The level of control required will depend upon the required emission limit values and the sensitivity of the receiving waters to accidental release, but conventional treatment techniques, well maintained and operated, will normally be sufficient. Techniques for receiving, storing and using reagents should match those on the main production facilities.

### Applicability

This technique is applicable to the plants producing sodium sulphite and related products.

Economics

No data submitted.

Driving force for implementation

High level of the efficiency in the abatement techniques applied for the reduction of the releases to the aquatic environment.

Example plants

The 'sulphite' plant in Accrington, United Kingdom – see information included in Table 7.87.

Reference literature

[61, Entec UK Limited, 2004].

**7.16.4.5 Low releases to land from the production of sodium sulphite**Description

Solid product waste is minimised through good process design to reduce 'off-specification' material, and through a well designed recovery and packaging plant. Excess sulphur in thiosulphate reactions is minimised, or retained as a remainder ('heel'), as this may be lost to the filter systems. Releases to land are normally the preferred environmental options, as most wastes are stable and low hazard, and solid materials in aqueous streams are preferably recovered and discharged via this route.

Achieved environmental benefits

Minimal solid waste levels in the discharge to land.

Cross-media effects

There are no reported disadvantages caused by the implementation of this technique.

Operational data

Refer to Section 7.16.2 and Figure 7.45 above. Data on specific emission levels to the land, from the thiosulphate process, are included in Section 7.16.3. In particular, specific emissions from the sulphite filtration steps should not exceed 30 – 40 kg of solid wastes per tonne of 'sulphites' produced. Waste solids are created in some processes such as the manufacture of thiosulphate, and these can be settled (settling tank) or preferably filtered (filter press), to achieve minimal solid levels in the discharge, with the resultant sludge or cake forming the main component of the releases to land.

Applicability

This technique is applicable to the plants producing sodium sulphite and related products.

Economics

No data submitted.

Driving force for implementation

High level of the efficiency in the methods applied for the reduction of releases of solid wastes to landfill.

Example plants

The 'sulphite' plant in Accrington, United Kingdom – see information included in Table 7.87.

Reference literature

[61, Entec UK Limited, 2004].



### 7.16.5 Best Available Techniques for the manufacture of sodium sulphite and related products

For general information on understanding a BAT section and its contents, see Section 7.1.5.

The group of LVIC-S chemicals covered in this section include: sodium sulphite ( $\text{Na}_2\text{SO}_3$ ), sodium bisulphite ( $\text{NaHSO}_3$ ), sodium thiosulphate ( $\text{Na}_2\text{S}_2\text{O}_3$ ) and metabisulphite ( $\text{Na}_2\text{S}_2\text{O}_5$ ), as well as the corresponding inorganic compounds, in which the relevant sodium ion is substituted by ammonium ( $\text{NH}_4^+$ ) or potassium ( $\text{K}^+$ ) ions.

Depending on whether sulphur dioxide is produced at the site (or neighbouring site) or bought in as a liquefied gas, sodium sulphite and related products are manufactured in the EU by either continuous or batch processes in which  $\text{SO}_2$  is absorbed into an alkali associated with the primary product. The most significant environmental issue in the production of sulphites is the release of gaseous  $\text{SO}_2$  to air.

#### For the manufacture of sodium sulphite with the production of $\text{SO}_2$ at the site, BAT is to:

1. Recover the surplus heat to raise at least 1 – 1.2 tonnes of medium pressure steam per tonne of  $\text{SO}_2$  produced during the production of gaseous sulphur dioxide by sulphur burning (see Sections 7.16.2.2.1, 7.16.2.3.6 and 7.16.3.1.3).
2. Reduce the emissions of hydrogen sulphide from the storage of liquid sulphur to air to 1 mg  $\text{H}_2\text{S}/\text{Nm}^3$  by using alkaline scrubbing (see Sections 7.16.3.2 and 7.16.4.2).
3. In order to achieve a high yield, low emission production of sodium sulphite and related products (see Sections 7.16.2.3.10 and 7.16.4.1):
  - apply available process-integrated techniques, such as the concurrent manufacture and use of sulphur dioxide, which allow the minimisation of the  $\text{SO}_2$  inventory in the sodium sulphite plant
  - apply good design and integrated operation of the plant to handle larger flows of gaseous  $\text{SO}_2$  and vent flows involved in the low pressure process regime.

#### For the manufacture of sodium sulphite with $\text{SO}_2$ delivery to the site, BAT is to:

1. Design and properly operate the sodium sulphite plant, equipping the storage of liquid  $\text{SO}_2$  under pressure with high integrity systems, to eliminate significant inventory hazards resulting from storing larger volumes of liquefied  $\text{SO}_2$  and to minimise fugitive emissions and odour resulting from downloading and handling liquid  $\text{SO}_2$  (see Sections 7.16.2.3.1, 7.16.2.3.7, 7.16.2.3.10 and 7.16.4.1).
2. Reduce the emissions of  $\text{SO}_2$  to air from the storage of liquid  $\text{SO}_2$  to below 20 mg  $\text{SO}_2/\text{Nm}^3$  by using alkaline scrubbing (see Sections 7.16.3.2 and 7.16.4.2).

#### For the main stage production process of sodium sulphite and related products, BAT is to:

1. Reduce the emissions of  $\text{NH}_3$  to air from the ammonia handling and processing sections to 5 mg  $\text{NH}_3/\text{Nm}^3$  by using water scrubbing (see Sections 7.16.2.3.1, 7.16.3.2 and 7.16.3.3.1).
2. Reduce the emissions of  $\text{SO}_2$  to air from the sulphite reactors handling low load/almost pure gas to  $<20$  mg  $\text{SO}_2/\text{Nm}^3$  by using alkaline scrubbing (see Sections 7.16.3.2 and 7.16.4.2).
3. Reduce the emissions of  $\text{SO}_2$  to air from the sulphite reactors handling high load/inert carrier gas to  $<150$  mg  $\text{SO}_2/\text{Nm}^3$  by using alkaline scrubbing, which allows the sulphur compounds to be recycled into the process (see Sections 7.16.3.2, 7.16.4.1 and 7.16.4.2).

4. Recycle process off-gas streams from the sulphite production, in particular originating from the sulphite reactors handling high load/inert carrier gas, into other chemical manufacturing processes, as appropriate. This is carried out so as to achieve by synergy low emission production of sodium sulphite and related products in chemical industrial complexes, where sulphite production is integrated with other chemical plants (see Sections 7.16.3.2, 7.16.4.1 and 7.16.4.2).
5. Reduce the emissions of hydrogen sulphide and sulphur dioxide from the thiosulphate reactors to air to  $1 \text{ mg H}_2\text{S/Nm}^3$  and to  $<20 \text{ mg SO}_2/\text{Nm}^3$  respectively by using alkaline scrubbing (see Sections 7.16.3.2 and 7.16.4.2).
6. Reduce the emissions of  $\text{SO}_2$  to air from the sulphite product storage vent to  $<20 \text{ mg SO}_2/\text{Nm}^3$  by using alkaline scrubbing (see Sections 7.16.3.2 and 7.16.4.2).
7. Reduce the emissions of dust to air from the production of sodium sulphite and related products and from the dry product handling to  $<20 \text{ mg/Nm}^3$  by using wet scrubbers (see Sections 7.16.3.2 and 7.16.4.3).
8. Reduce the content of sulphates and suspended solids in the waste waters to  $<2 \text{ g SO}_4^-$  per litre of waste water and to  $0.1 - 0.3 \text{ g}$  of suspended solids per litre of waste water released to the aquatic environment respectively, applying both process-integrated measures (continuous processes, dedicated plant or campaign operations to reduce product changes) and preventive measures (settling of wash-water, filter backwash operations, treatment with the addition of sodium hypochlorite, etc.) – see Sections 7.16.3.2 and 7.16.4.4.
9. Reduce solid waste from sulphites production, in particular from the manufacture of thiosulphates to  $30 - 40 \text{ kg}$  of solid wastes per tonne of sulphites produced, by using settling tanks or, preferably, filter press systems to achieve minimal solid levels in the discharge (see Sections 7.16.3.2 and 7.16.4.5).

## 7.17 Zinc oxide

### 7.17.1 General information

#### 7.17.1.1 Introduction

Zinc oxide is mainly used in the rubber industry in which it serves as an activator in the vulcanisation process. ZnO is also used as an active agent in pharmaceutical and cosmetic products as well as in paints [48, W. Buchner et al, 1989], [6, CEFIC, 2002], [113, G. Buxbaum, 1993], [85, EIPPCB, 2004-2005].

Zinc oxide is an important rubber compounding material [6, CEFIC, 2002]. It is used in all types of rubber, which are crossed-linked with sulphur. A further major use of zinc oxide is in glass and ceramic products. Zinc oxide absorbs ultraviolet light and is used as a sunscreen in pharmaceutical and cosmetic products. It is also used in healing wounds as a bacteriostat in medical plasters and in baby creams and calamine lotion. In paints, zinc oxide is mainly used as a corrosion inhibitor. Zinc is a trace element, essential to life and zinc oxide is one of the main additives of zinc to fertilisers, animal feed and human vitamin supplements. It is also used in dental cement. Finally zinc oxide acts as a catalyst in alkylation, oxidation, hydrogenation and desulphurisation reactions.

Zinc oxide is produced by direct and indirect processes and, in smaller quantities, also by a wet chemical process [6, CEFIC, 2002], [48, W. Buchner et al, 1989], [62, CEFIC-ZOPA, 2004].

#### The direct or American process

In this process, oxidised zinc bearers, such as skimming, ashes from hot dip galvanising or residues from the indirect process, are used as a starting material. In this process, the starting material (oxidic zinc compounds) is first reduced by carbon, and then the metal vapours are oxidised by air combustion to produce zinc oxide. The purity of the zinc oxide from the American process is normally somewhat less than that from the French process. Grades of various purities can be produced by fractionation [6, CEFIC, 2002], [62, CEFIC-ZOPA, 2004], [113, G. Buxbaum, 1993], [85, EIPPCB, 2004-2005] – see also Section 7.17.2.1.

#### The indirect or French process

In this process, the starting material is zinc metal (with a purity of 92 – 99.995 %), refined metal metallic residues and scrap. In this process, the zinc metal is melted, vaporised by boiling and oxidised in the vapour state to zinc oxide with air. The first stage of the process is carried out in directly heated reaction vessels like retorts, or in vertical refining columns with a very effective rectification. Afterwards, the zinc vapour is burned (oxidised) to produce zinc oxide, which is precipitated from the ZnO/air mixture in settling chambers, in which the fractionation of the zinc oxide particles takes place according to their size [6, CEFIC, 2002], [48, W. Buchner et al, 1989] – see also Section 7.17.2.2.

#### Wet chemical process

This is carried out by precipitating zinc carbonate, basic carbonate or the zinc hydroxide, which is washed, filtered and dried. The ZnO product is then obtained by a follow-up calcination process. At low calcination temperatures particularly fine particles are produced, so-called transparent zinc oxide, this making it possible, depending on the calcinations process, to obtain small amounts of zinc carbonate or zinc hydroxide [6, CEFIC, 2002], [113, G. Buxbaum, 1993], [85, EIPPCB, 2004-2005] – see Section 7.17.4.3.

#### 7.17.1.2 Basic data on zinc oxide production

The three major uses of zinc oxide are in rubber compounding, where it is used in all types of rubber which are cross-linked with sulphur, and in glass and ceramic products. Other applications have already been mentioned in Section 7.17.1.1 [6, CEFIC, 2002], [62, CEFIC-ZOPA, 2004].

In the EU-15, a total of 20 producers of zinc oxide can be identified operating a total of 25 production sites with a total production capacity of 265000 tonnes per year – see Table 7.91.

Country	Production site
Italy	IT-1
Spain	ES-1
Spain	ES-2
Germany	DE-1
Germany	DE-2
Italy	IT-2
Italy	IT-3
Belgium	BE-1
United Kingdom	UK-1
Portugal	PT-1
Spain	ES-3
United Kingdom	UK-2
Germany	DE-3
Italy	IT-4
United Kingdom	UK-3
United Kingdom	UK-4
Spain	ES-4
France	FR-1
Germany	DE-4
Spain	ES-5
Belgium	BE-2
Spain	ES-6
Netherlands	NL-1
Belgium	BE-3
Austria	AT-1
<b>Total annual EU-15 capacity*</b>	<b>265 kt per year</b>
* Poland's site was mentioned in the CEFIC-ZOPA data, however, it was not indicated in this Table	

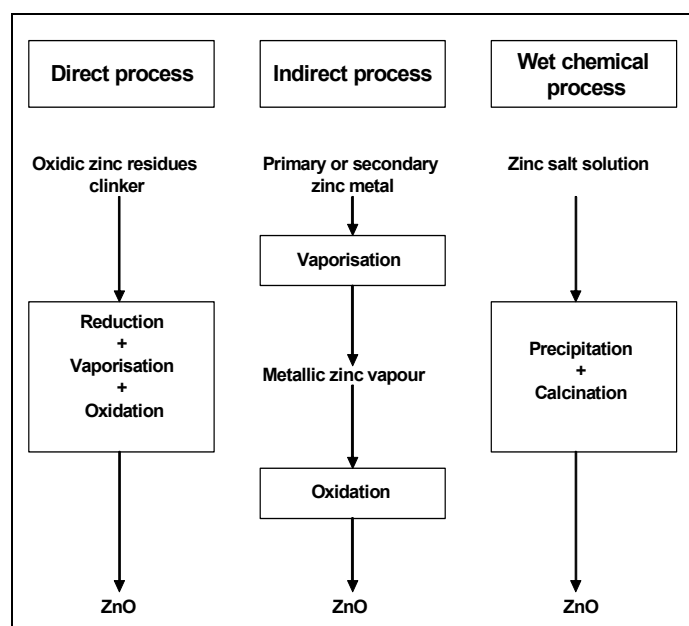
**Table 7.91: Production sites of zinc oxide in the EU-15**  
[62, CEFIC-ZOPA, 2004]

A yearly market demand of 260000 t of zinc oxide can be assumed for the EU. The export volume is around 19000 tonnes per year to non-EU-15 countries. Total volume of imports into the EU-15 was over 68000 tonnes in 2002. Imports into the EU-15 mainly come from China, and the Spanish market is mainly affected by these (approximately 22000 tonnes per year is consumed by the Spanish ceramic industry). As seen in Table 7.91, the yearly capacities of the plants are confidential and, therefore, typical size of the EU-15 zinc oxide plant cannot be disclosed. The capacity of facilities producing zinc oxide in the EU-15 may range from 2000 up to 40000 tonnes per year. In recent years, the capital investment in zinc oxide production in the EU-15 has decreased. Whereas five plants have been closed, no new plants have been built since 1999 [6, CEFIC, 2002].

### 7.17.2 Industrial processes used

Zinc oxide is produced by the direct (11 % of the total EU-15 zinc oxide production capacity) and indirect (83 %) process route, as well as by the wet chemical process (6 %).

Figure 7.46 contains simplified flow charts of these process routes.



**Figure 7.46: Main process routes for zinc oxide production**  
[62, CEFIC-ZOPA, 2004]

The direct or American process, the indirect or French process, and the wet chemical process have been characterised in Section 7.17.1.1, and there is no need to repeat this information.

The different processes, as well as various options for the manufacturing processes and raw materials used, result in a variety of zinc oxide type, each with different particle sizes and contents of impurities.

It should be noted that outside of the EU-15, zinc oxide is also produced by a pyrogenic process in a specially designed, so-called Larvik furnace. Process details for that process are not given in this section due to lack of information.

In the direct and indirect process, the oxide is collected in bag houses and finally packed in big bags or paper sacks in powder form or as granulated material, while material from the wet process is collected in hoppers after calcinations and then directly packed. Air emissions are essentially due to the flue-gas from the various types of furnaces and include mainly  $\text{NO}_x$  and  $\text{SO}_x$ , depending on the quality of coal, fuel oil or gas used [85, EIPPCB, 2004-2005].

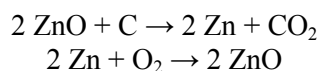
Also, dust emissions from the handling of coal, zinc bearing raw materials and zinc oxide are likely. For the thermal, direct and indirect processes, there are no emissions to water, as there is no process water used. The generation of waste is dependent upon the process used and upon the quality of the feedstock, e.g. coal and zinc raw material. All residues containing zinc are recycled except the slag coming from the American process. This slag goes for landfill, or is used in other applications, such as in road construction materials.

Industrial processes used in the production of zinc oxide are characterised below in more detail.

### 7.17.2.1 Direct process

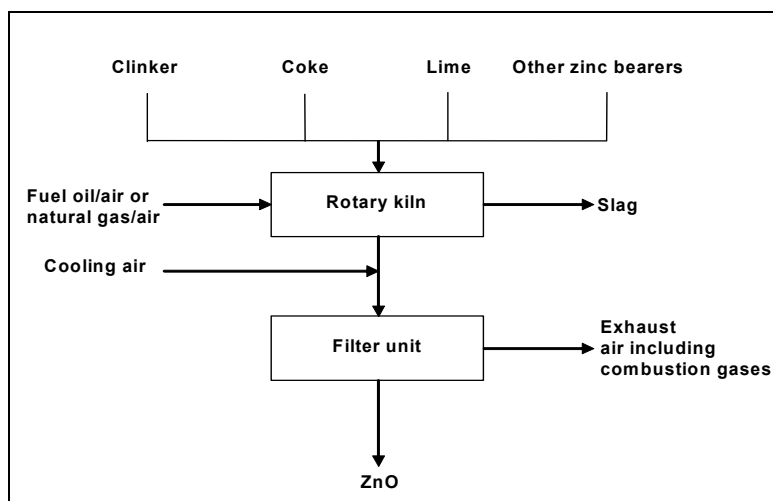
For the direct (American) process, different oxidic materials containing zinc (low in lead and chlorine contents, for example clinker oxide resulting from the treatment of galvanising ashes), as well as oxidic residues from the indirect process can be used as starting materials. These are reduced in a rotary kiln at a temperature of 1000 °C by coke, under the addition of lime. Zinc is volatilised, and the zinc vapour is then directly oxidised.

The basic chemical equations governing this process are:



The resulting zinc oxide is subsequently collected in bag filters after cooling the exhaust air, and then packed into paper sacks or big bags.

A flow diagram showing the production of ZnO by the direct process is given in Figure 7.47.



**Figure 7.47:** Flow diagram showing the production of ZnO by the direct process [62, CEFIC-ZOPA, 2004]

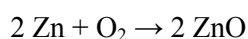
### 7.17.2.2 Indirect process

The group of technological routes covered by the indirect (French) process embraces five options, depending either on the type of a process variant or main reactor used. These are as follows:

- electro-thermal
- muffle
- rectification
- retort
- rotary kiln.

#### 7.17.2.2.1 Electro-thermal

High purity zinc is first melted and then fed into the electro-thermal furnace, which consists of a column of metallurgical coke contained in a refractory shaft, fitted with lower and upper electrodes. When an electrical current flows between the electrodes, the electrical resistance of the coke causes the temperature to rise sufficiently to vaporise the molten zinc. The zinc vapour is then directed into a brick-lined combustion chamber where it is allowed to react (burn) with oxygen (air). The basic chemical equation governing this process is:



The resulting zinc oxide is subsequently collected in bag filters after cooling the exhaust air, and is then packed into paper sacks or big bags.

Process flow diagram showing the electro-thermal production of ZnO is given in Figure 7.48.

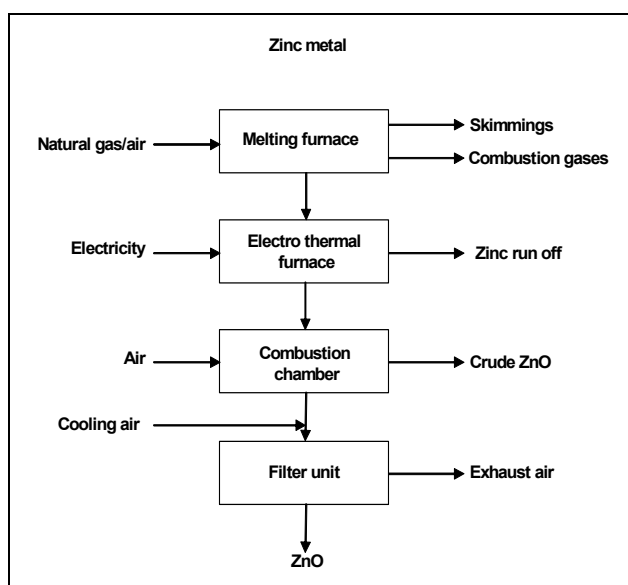
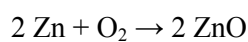


Figure 7.48: Process flow diagram showing the electro-thermal production of ZnO [62, CEFIC-ZOPA, 2004]

#### 7.17.2.2.2 Muffle

In the muffle process, special high grade (SHG) zinc is placed into a melting furnace, where it is melted and then transferred as liquid zinc into the vaporiser (muffle arch furnace). The zinc vapour is then externally oxidised in a combustion chamber. The basic chemical equation governing this process is:



The resulting zinc oxide is subsequently collected in bag filters after cooling the exhaust air, and is then packed into paper sacks or big bags.

A process flow diagram showing the production of ZnO in muffle furnaces is given in Figure 7.49.

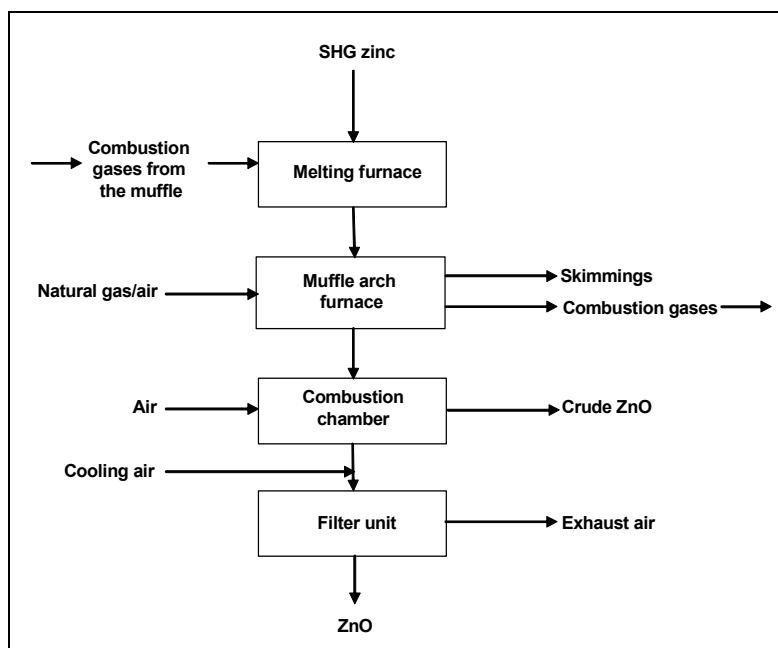
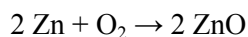


Figure 7.49: Process flow diagram of the production of ZnO in muffle furnaces [62, CEFIC-ZOPA, 2004]

### 7.17.2.2.3 Rectification

It is also possible to produce zinc oxide using secondary zinc or primary zinc, provided that cadmium has previously been separated, and rectification is used for vaporisation. For this purpose, the New Jersey distillation method is applied. While primary zinc is used directly for this type of distillation, secondary zinc needs to be molten and segregated (Seiger process) before it is distilled. In the rectification process, zinc vapour of a very high purity is generated which is then either condensated with nitrogen to zinc dust or burned with air to zinc oxide. The basic chemical equation governing this process is:



The resulting zinc oxide is subsequently collected in bag filters after cooling the exhaust air, and is then packed into paper sacks or big bags.

A process flow diagram showing the production of ZnO by the rectification process is given in Figure 7.50.

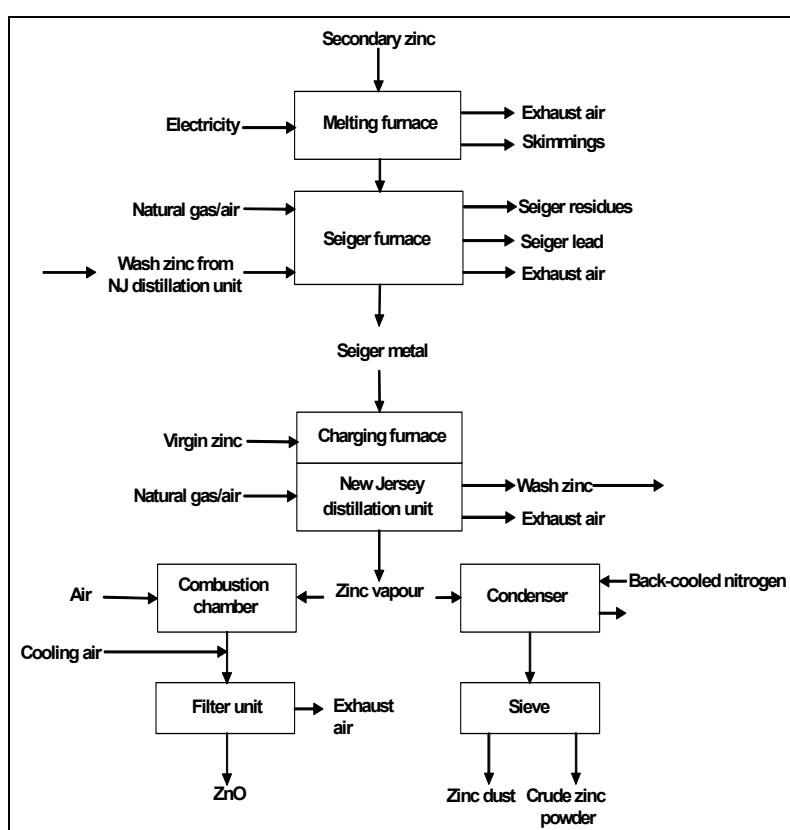
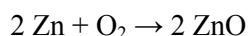


Figure 7.50: Process flow diagram showing the production of ZnO by the rectification process [62, CEFIC-ZOPA, 2004]

### 7.17.2.2.4 Retort

In the retort process (crucible process) secondary or primary zinc metal is initially placed into a retort furnace, and then melted and vaporised. Zinc metal can also first be melted in a separate melting furnace, and then be transferred to the retort for vaporisation. The zinc vapour is then externally oxidised. The basic chemical equation governing this process is:



The resulting zinc oxide is subsequently collected in bag filters after cooling the exhaust air, and is then packed into paper sacks or big bags.

A process flow diagram showing the production of ZnO in retorts is given in Figure 7.51.



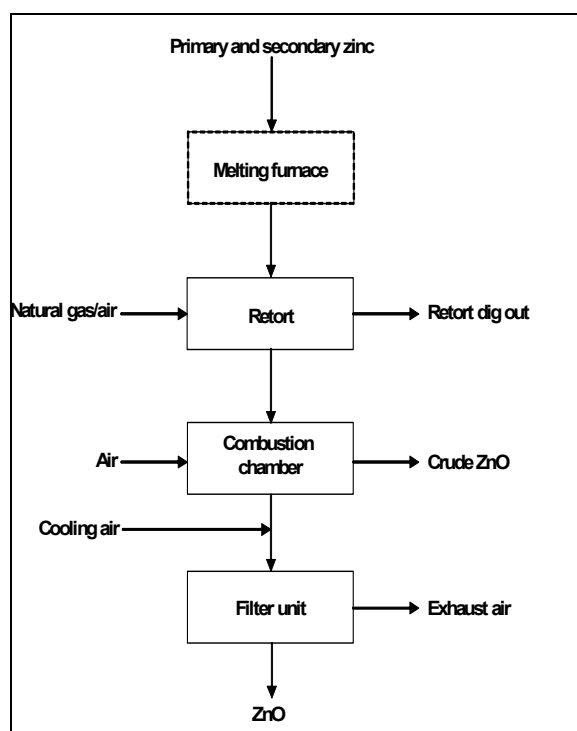
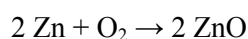


Figure 7.51: Process flow diagram showing the production of ZnO in retorts [62, CEFIC-ZOPA, 2004]

#### 7.17.2.2.5 Rotary kiln

Ingots of secondary zinc are placed into a rotating drum furnace. Inside the furnace, zinc is then partly oxidised to zinc oxide under a controlled atmosphere. The exothermal reaction of zinc with oxygen gives sufficient heat for melting and vaporising the metallic input material. Subsequently, the zinc vapour is completely oxidised outside the furnace in a combustion chamber. The basic chemical equation governing this process is:



The resulting zinc oxide is subsequently collected in bag filters after cooling the exhaust air, and is then packed into paper sacks or big bags.

A process flow diagram showing the production of ZnO in rotary kilns is given in Figure 7.52.

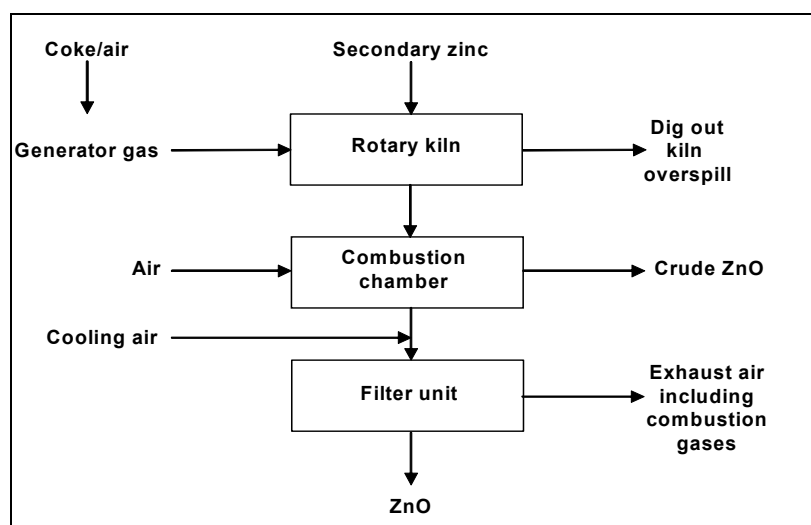
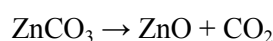
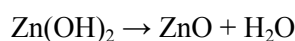


Figure 7.52: Process flow diagram showing the production ZnO in rotary kilns [62, CEFIC-ZOPA, 2004]

### 7.17.2.3 Wet chemical process

In the wet chemical process, the starting material is usually a solution containing zinc which is obtained as a coupled product from dithionite or dithionite derivative synthesis. Further, purified zinc salt solutions (predominantly sulphate or chloride) are used in order to synthesise very pure zinc oxide grades. Zinc hydroxide and/or carbonate are subsequently precipitated from the solutions by the addition of alkalines. Finally, zinc oxide is generated by calcination (dehydration, decarboxylation). Thermal decomposition of zinc acetate also leads to zinc oxide. The simplified chemical equations governing the main wet processes are:



A process flow diagram showing the production of ZnO by the wet chemical process is given in Figure 7.53.

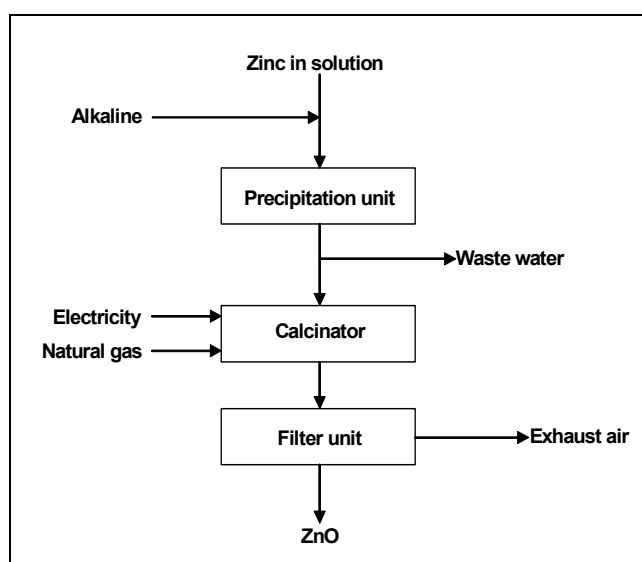


Figure 7.53: Process flow diagram showing the production of ZnO by the wet chemical process [62, CEFIC-ZOPA, 2004]

### 7.17.3 Present consumption and emission levels

In this section, the present consumption and emission levels are briefly summarised, and aspects of key environmental issues are addressed. For more in-depth information on consumption and emissions, please refer to the specific process-related sections above.

While emissions to soil can be assumed to be zero for all zinc oxide production processes, the rate and extent of discharge to air and water differ among these processes. The pyrometallurgical (direct and indirect) processes (refer to Sections 7.17.2.1 and 7.17.2.2) only involve emissions to air, whereas in the wet chemical process (Section 7.17.2.3), emissions to water need to be considered, depending on the starting material used.

More than 85 % of zinc oxide is produced from secondary raw materials (i.e. remelted zinc, top or bottom drosses, zinc ashes, skimmings, by-product zinc solutions, etc.). For the production of pharmaceutical grade zinc oxide, special high grade zinc (99.995 % zinc) is commonly used. All of the generated by-products can be fully recycled.

External energy input for the production of zinc oxide is only required during the phase of vaporising the zinc. For direct or indirect heating, gas or gasoil is used. Auxiliary machinery like bag house ventilators are run by electricity.

In the draft of 29<sup>th</sup> ATP of EU Directive 67/548/EEC, zinc oxide is listed as a substance that is hazardous for the environment. Zinc and zinc compounds have been the subject of a comprehensive risk assessment conducted according to regulation 793/93/EEC.

The emissions to air for the different processes as reported for the year 2002 by zinc oxide producers are presented in Table 7.92. Whereas dust emissions are relevant for product filter systems only, emissions of SO<sub>2</sub>, NO<sub>x</sub> and CO<sub>2</sub> are related to combustion gases resulting from heating systems. However, in the case of the direct and rotary kiln processes, these exhaust streams are combined.

Specific emissions to air per one tonne of ZnO produced are given in Table 7.92.

Process	Volume of exhaust air	Dust	SO <sub>2</sub>	NO <sub>x</sub>	CO <sub>2</sub>
	m <sup>3</sup> /t ZnO	g/t	g/t	g/t	kg/t
	(product filter systems)		(combustion gases)		
<b>Electro-thermal</b>	<97000	690	<150	<125	<130
<b>Muffle</b>	100000	250	200	300	450
<b>Rectification</b>	36300	250	64	830	950
<b>Retort</b>	85000	<50	200	<500	418
<b>Wet chemical 1/2</b>	34000	725	200	nd	nd
	(exhaust air and combustion gases combined)				
<b>Direct</b>	60000	<50	625	<750	875
<b>Rotary kiln</b>	66000	165	200	300	330

Notes:  
 SO<sub>2</sub>: estimated values, NO<sub>x</sub>: estimated and measured values, CO<sub>2</sub>: calculated values based on coal, gas or oil consumption, dust: measured values, nd: no data; wet chemical process: one producer reported zero emissions to air as typical for this very special process with a limited small production capacity and the data were from two different plants

**Table 7.92: Emissions to air per one tonne of ZnO produced by various process routes [62, CEFIC-ZOPA, 2004]**

The various pyro-metallurgical process routes do not result in any emissions to water. In contrast, it is evident that the wet chemical process has no emissions to air. However, emissions to water may occur in wet chemical process routes, as given in Table 7.93.

Process	Volume of waste water	Cl <sup>-</sup>	SO <sub>4</sub> <sup>+</sup>	Zn <sup>2+</sup>	NO <sub>3</sub> <sup>-</sup>	NH <sub>4</sub> <sup>+</sup>	COD
	m <sup>3</sup> /t ZnO	kg/t	kg/t	kg/t	kg/t	kg/t	kg/t
<b>Direct</b>	0	0	0	0	0	0	0
<b>Electro-thermal</b>	0	0	0	0	0	0	0
<b>Muffle</b>	0	0	0	0	0	0	0
<b>Rectification</b>	0	0	0	0	0	0	0
<b>Retort</b>	0	0	0	0	0	0	0
<b>Rotary kiln</b>	0	0	0	0	0	0	0
<b>Wet chemical 1</b>	25	875 <sup>a</sup>	1000 <sup>b</sup>	0	0	0	0
<b>Wet chemical 2</b>	0	0	0	0	0	0	0

Notes: Wet chemical process 1: a: if starting up with zinc chloride solution; b: if starting up with zinc sulphate solution; Wet chemical process 2: full recycling of waste water, when zinc oxide is produced as a by-product

**Table 7.93: Specific emissions to water per one tonne of ZnO produced by various process routes [62, CEFIC-ZOPA, 2004]**

Emissions of solid residues per one tonne of ZnO produced are given in Table 7.94. Only the direct process yields waste in the form of a slag which is either directed to landfill, or is used in road construction. In all other processes, no solid residues are emitted since all by-products are completely re-used.

Process	Raw material	Waste	Nature of residue	Destination of residue	Proportion re-used
	kg/tonne	kg/tonne	-	-	%
<b>Direct</b>	1110	200	slag	road construction/landfill	0
<b>Indirect</b>					
<b>Electro-thermal</b>	903	106	dross	recycling	100
<b>Muffle</b>	830	30 (*)	dross	recycling	100
<b>Rectification</b>	938	134	dross	recycling	100
<b>Retort</b>	900	98	dross	recycling	100
<b>Rotary kiln</b>	1105	360	dross	recycling	100
<b>Wet chemical 1/2</b>	1700	20	sludge	recycling	100

Notes: Calculated average process data, nature of residues: dross and other zinc bearing by-products for complete recycling; (\*) Data from 'Sachbilanz Zink, published 2001, RWTH Aachen.

**Table 7.94: Emissions of solid residues per one tonne of ZnO produced [62, CEFIC-ZOPA, 2004]**

As shown in Table 7.95, the energy consumption per one tonne of ZnO produced varies somewhat between the different process routes.

Process	Electricity	Coke	Fuel oil	Gas	Total energy consumption
	kWh/tonne	kg/tonne	kg/tonne	m <sup>3</sup> /tonne	GJ/tonne
<b>Direct</b>	155	250	120*	150*	13.0
<b>Indirect</b>					
<b>Electro-thermal</b>	919	0	0	54	5.2
<b>Muffle</b>	120	0	0	230	8.6
<b>Rectification</b>	501	0	0	355	14.4
<b>Retort</b>	247	0	0	224	9.3
<b>Rotary kiln</b>	198	100	0	7	3.8
<b>Wet chemical 1/2</b>	220	0	0	332	14.0

Notes: Energy consumption and total energy consumption: calculated mean values; \* as the energy source for this process type, alternatively either gas or fuel oil is used

**Table 7.95: Energy consumption per tonne of ZnO [62, CEFIC-ZOPA, 2004]**

### 7.17.4 Techniques to consider in the determination of BAT

#### Introduction: Techniques to consider in the determination of BAT – refer to Section 7.1.4

As mentioned before, three main processes are common for the production of zinc oxide. For the direct and the wet chemical processes, no further breakdown into sub-processes has been made in the preceding sections. For the indirect process, five relevant distinctive process routes have been described: the electro-thermal, muffle, rectification, retort and rotary kiln processes.

The three main production processes described above (direct, indirect – jointly with its five process routes, and wet chemical), should be taken into consideration when determining BAT for the production of zinc oxide, as all of them are processes applied in industrial practice across the European Union with the aim of saving energy and reducing the impact on the environment [62, CEFIC-ZOPA, 2004].

The various techniques to produce zinc oxide are part of the recycling chain of zinc. Starting from different secondary zinc bearing residues, all processes are comparable regarding energy consumption and emissions. All residues coming from the different techniques can be used as raw materials for other processes. Only in the direct process, an inert slag is generated, but this process is specially determined for the recycling of oxidic zinc residues [85, EIPPCB, 2004-2005].

It should be stressed that recent developments in the zinc oxide industry sector mainly aim at improving the reliability of existing abatement technologies [62, CEFIC-ZOPA, 2004]:

- emergency power supplies will keep air dedusting filters in operation even in the case of electrical power outages
- for wet chemical processes which produce waste water, continuous monitoring of effluents released to water helps to protect the environment and to initiate counteractive measures whenever malfunctions may occur.

In addition to the above, most of the existing production plants will fall under the Seveso II Directive. This Directive [23, The Council of the EU, 1996], on the control of major accident hazards involving dangerous substances, aims at the prevention of major accidents and the limitation of their consequences for man and for the environment.

### 7.17.4.1 Direct process for the production of zinc oxide

#### Description

In the direct, or American process, oxidised zinc bearers, such as skimmings, ashes from hot dip galvanising or residues from the indirect process are used as a starting material. In this process, the starting material (oxidic zinc compounds) is first reduced by carbon, and then the metal vapours are oxidised by air combustion to produce zinc oxide.

For more detailed information refer to Sections 7.17.1.1, 7.17.2, and in particular, 7.17.2.1. Refer also to Figure 7.46 and Figure 7.47 above.

#### Achieved environmental benefits

Reduction of the impact on the environment (air emissions and solid releases). More than 85 % of zinc oxide is produced from secondary raw materials, i.e. remelted zinc, top or bottom drosses, zinc ashes, skimmings, by-product zinc solutions, etc.

#### Cross-media effects

As shown in Table 7.94, the direct process yields waste in the form of a slag which is preferably used in road construction or, when this encounters limitations, sent to landfill.

#### Operational data

The following are specific emissions to air and energy consumption data from the direct process:

- dust: 220 g/t
- SO<sub>2</sub>: 625 g/t
- NO<sub>x</sub>: 300 g/t
- CO<sub>2</sub>: 875 kg/t
- total energy consumption: 13 GJ/t.

#### Applicability

Applicable to the plants producing zinc oxide by the direct process.

#### Economics

No data submitted.

Driving force for implementation

The protection of the environment by using oxidic zinc residues, improving process efficiency, saving energy and reducing the emissions to air.

Example plants

Zinc oxide plant (NL-1), the Netherlands.

Reference literature

[62, CEFIC-ZOPA, 2004], [6, CEFIC, 2002], [48, W. Buchner et al, 1989], [85, EIPPCB, 2004-2005].

**7.17.4.2 Indirect processes used for the production of zinc oxide****7.17.4.2.1 Electro-thermal process**Description

As described in Sections 7.17.1.1, 7.17.2, and in particular, 7.17.2.2.1. Refer also to Figure 7.46 and Figure 7.48 above.

Achieved environmental benefits

Reduction of the impact on the environment (air emissions). Except from an installation in the UK that manufactures pharmaceutical-grade product from special high purity primary metal, a substantial part of zinc oxide is produced from secondary raw materials. There are no emissions to water or to land. All residues containing zinc are recycled.

Cross-media effects

There are no reported disadvantages caused by the implementation of this technique.

Operational data

The following are specific emissions to air and energy consumption data from the electro-thermal indirect process:

- dust: 690 g/t
- SO<sub>2</sub>: <150 g/t
- NO<sub>x</sub>: <125 g/t
- CO<sub>2</sub>: <130 kg/t
- total energy consumption: 5.2 GJ/t.

Applicability

Applicable to the plants producing zinc oxide by the indirect process using the electro-thermal process route.

Economics

No data submitted.

Driving force for implementation

The protection of the environment by using oxidic zinc residues, improving process efficiency, saving energy and reducing the emissions to air.

Example plants

Zinc oxide plant (UK-4), United Kingdom.

Reference literature

[62, CEFIC-ZOPA, 2004], [6, CEFIC, 2002], [48, W. Buchner et al, 1989], [85, EIPPCB, 2004-2005].

### 7.17.4.2.2 Muffle process

#### Description

As described in Sections 7.17.1.1, 7.17.2, and in particular, 7.17.2.2.2. Refer also to Figure 7.46 and Figure 7.49 above.

#### Achieved environmental benefits

Reduction of the impact on the environment (air emissions). A substantial part of zinc oxide is produced from secondary raw materials. There are no emissions to water or to land. All residues containing zinc are recycled.

#### Cross-media effects

There are no reported disadvantages caused by the implementation of this technique.

#### Operational data

The following are specific emissions to air and energy consumption data from the direct process:

- dust – 250 g/t
- SO<sub>2</sub> – 200 g/t
- NO<sub>x</sub> – 300 g/t
- CO<sub>2</sub> – 450 kg/t
- total energy consumption – 8.6 GJ/t.

#### Applicability

Applicable to the plants producing zinc oxide by the indirect process using the muffle process route.

#### Economics

No data submitted.

#### Driving force for implementation

The protection of the environment by using oxidic zinc residues, improving process efficiency, saving energy and reducing the emissions to air.

#### Example plants

Zinc oxide plant (UK-2), the United Kingdom.

#### Reference literature

[62, CEFIC-ZOPA, 2004], [6, CEFIC, 2002], [48, W. Buchner et al, 1989], [85, EIPPCB, 2004-2005].

### 7.17.4.2.3 Rectification process

#### Description

As described in Sections 7.17.1.1, 7.17.2, and in particular, 7.17.2.2.3. Refer also to Figure 7.46 and Figure 7.50 above.

#### Achieved environmental benefits

Reduction of the impact on the environment (air emissions). A substantial part of zinc oxide is produced from secondary raw materials. There are no emissions to water or to land. All residues containing zinc are recycled.

#### Cross-media effects

There are no reported disadvantages caused by the implementation of this technique.

Operational data

The following are specific emissions to air and energy consumption data from the direct process:

- dust – 250 g/t
- SO<sub>2</sub> – 64 g/t
- NO<sub>x</sub> – 830 g/t
- CO<sub>2</sub> – 950 kg/t
- total energy consumption – 14.4 GJ/t.

Applicability

Applicable to the plants producing zinc oxide by the indirect process using the rectification process route.

Economics

No data submitted.

Driving force for implementation

The protection of the environment by using oxidic zinc residues, improving process efficiency, saving energy and reducing the emissions to air.

Example plants

Zinc oxide plant (DE-4), Germany.

Reference literature

[62, CEFIC-ZOPA, 2004], [6, CEFIC, 2002], [48, W. Buchner et al, 1989], [85, EIPPCB, 2004-2005].

**7.17.4.2.4 Retort process**Description

As described in Sections 7.17.1.1, 7.17.2, and in particular, 7.17.2.2.4. Refer also to Figure 7.46 and Figure 7.51 above.

Achieved environmental benefits

Reduction of the impact on the environment (air emissions). A substantial part of zinc oxide is produced from secondary raw materials. There are no emissions to water or to land. All residues containing zinc are recycled.

Cross-media effects

There are no reported disadvantages caused by the implementation of this technique.

Operational data

The following are specific emissions to air and energy consumption data from the direct process:

- dust – 500 g/t
- SO<sub>2</sub> – 200 g/t
- NO<sub>x</sub> – 300 g/t
- CO<sub>2</sub> – 418 kg/t
- total energy consumption – 9.3 GJ/t.

Applicability

Applicable to the plants producing zinc oxide by the indirect process using the retort process route.



### Economics

No data submitted.

### Driving force for implementation

The protection of the environment by using oxidic zinc residues, improving process efficiency, saving energy and reducing the emissions to air.

### Example plants

Zinc oxide plant (ES-3), Spain.

### Reference literature

[62, CEFIC-ZOPA, 2004], [6, CEFIC, 2002], [48, W. Buchner et al, 1989], [85, EIPPCB, 2004-2005].

#### **7.17.4.2.5 Rotary kiln process**

### Description

As described in Sections 7.17.1.1, 7.17.2, and in particular, 7.17.2.2.5. Refer also to Figure 7.46 and Figure 7.52 above.

### Achieved environmental benefits

Reduction of the impact on the environment (air emissions). A substantial part of zinc oxide is produced from secondary raw materials. There are no emissions to water or to land. All residues containing zinc are recycled.

### Cross-media effects

There are no reported disadvantages caused by the implementation of this technique.

### Operational data

The following are specific emissions to air and energy consumption data from the direct process:

- dust – 165 g/t
- SO<sub>2</sub> – 200 g/t
- NO<sub>x</sub> – 300 g/t
- CO<sub>2</sub> – 330 kg/t
- total energy consumption – 3.8 GJ/t.

### Applicability

Applicable to the plants producing ZnO by the indirect process using the rotary kiln process route.

### Economics

No data submitted.

### Driving force for implementation

The protection of the environment by using oxidic zinc residues, improving process efficiency, saving energy and reducing the emissions to air.

### Example plants

Zinc oxide plant (DE-3), Germany.

### Reference literature

[62, CEFIC-ZOPA, 2004], [6, CEFIC, 2002], [48, W. Buchner et al, 1989], [85, EIPPCB, 2004-2005].

### 7.17.4.3 Wet chemical process of the production of zinc oxide

#### Description

In the wet chemical process, the starting material is usually a solution containing zinc. Further, purified zinc salt solutions, predominantly sulphate ( $\text{ZnSO}_4$ ) or chloride ( $\text{ZnCl}_2$ ), are used in order to synthesise very pure zinc oxide grades. Zinc hydroxide and/or carbonate are subsequently precipitated from the solutions by the addition of alkalines. Finally, zinc oxide is generated by calcination.

Refer to Sections 7.17.1.1, 7.17.2, and in particular, 7.17.2.3. Refer also to Figure 7.46 and Figure 7.53 above.

#### Achieved environmental benefits

Reduction of the impact on the environment (emissions to air and water). A substantial part of zinc oxide is produced from the solution containing zinc which is obtained as a coupled product from the synthesis of the salts of hyposulphurous acid ( $\text{H}_2\text{S}_2\text{O}_4$ ). There are no emissions to land. All residues containing zinc are recycled.

#### Cross-media effects

There are no reported disadvantages caused by the implementation of this technique.

However, apart from the emissions to air, as in all other ZnO processes, in the wet chemical process there are also emissions to water.

#### Operational data

The following are specific emissions to air and energy consumption data from the direct process:

- dust – 725 g/t
- $\text{SO}_2$  – 200 g/t
- $\text{NO}_x$  – no data submitted
- $\text{CO}_2$  – no data submitted
- total energy consumption – 14 GJ/t.

The following are specific emissions to water from the direct process:

- chlorides – 875 kg/t ZnO when starting from the  $\text{ZnCl}_2$  solution
- sulphates – 1000 kg/t ZnO when starting from the  $\text{ZnSO}_4$  solution.

It should be noted, however, that when zinc oxide is produced as a by-product, it is possible to achieve complete recycling of waste water.

#### Applicability

Applicable to the plants producing zinc oxide by the wet chemical process.

#### Economics

No data submitted.

#### Driving force for implementation

The protection of the environment by using zinc solutions from other processes, improving process efficiency of ZnO production, saving energy and reducing the emissions to water.

#### Example plants

Zinc oxide plant (DE-2), Germany.

#### Reference literature

[62, CEFIC-ZOPA, 2004], [6, CEFIC, 2002], [48, W. Buchner et al, 1989], [85, EIPPCB, 2004-2005].

### 7.17.5 Best Available Techniques for the manufacture of zinc oxide

For general information on understanding a BAT section and its contents, see Section 7.1.5.

Zinc oxide is currently produced in the EU using three main processes and several technological routes, including: the direct process, the indirect process (covering five technological routes), and partly by the wet chemical process.

Although within the group of the five indirect processes, some routes can offer distinct advantages in terms of specific emissions or energy requirements. It is likely that any new ZnO plant based on the indirect process will adopt one of these five routes, also taking into account other factors, in particular relating to the specific location, energy source available, investment necessary for the construction of the new plant, life-time of plants and the onstream factor of plants on an annual basis.

Given the complexity of such a choice, none of the process routes is de facto selected as BAT, and BAT conclusions in the group of the five indirect ZnO process routes are presented here in parallel.

Given some common, as well as distinct and differentiated features of the above-mentioned seven ZnO processes, BAT conclusions are drawn partly jointly and partly in parallel, as follows.

#### **For the production of zinc oxide by the pyro-metallurgical direct and indirect process routes, BAT is to:**

1. Install and properly maintain the emergency power supply system, in order to keep product bag filters in operation even in the case of electrical power outages (see Section 7.17.4).

#### **For the production of zinc oxide by the direct process, BAT is to:**

1. Maximise the usage of secondary raw materials containing zinc, to generally reduce the impact on the environment from the zinc and zinc oxide producing sectors (saving energy, reducing air emissions and releases to landfill) – see Sections 7.17.2.1, 7.17.3 and 7.17.4.1.
2. Maintain the optimum ratio of the mixture of raw materials fed into the rotary kiln (secondary oxidic zinc compounds, coke and lime), and improve process efficiency in the reduction and oxidation steps by advanced control of process parameters, to achieve the following environmental benefits and performance targets (see Sections 7.17.2.1, 7.17.3 and 7.17.4.1):
  - emissions of dust to air from the ZnO product filter reduced to a level of below 0.05 kg dust/tonne ZnO product
  - emissions to air from combustion gases resulting from heating systems, reduced to: SO<sub>2</sub> <0.6 kg/tonne ZnO product, NO<sub>x</sub> <0.75 kg/tonne ZnO product, CO<sub>2</sub> <875 kg/tonne ZnO product
  - total energy consumption of less than 13 GJ/tonne ZnO product
  - the total quantity of slag generated in the process reduced to below 200 kg/tonne ZnO product.

#### **For the production of zinc oxide by the indirect process routes, BAT is to:**

1. Improve process efficiency in the production of zinc oxide via the indirect electro-thermal route by advanced control of process parameters, to achieve the following environmental benefits and performance targets (see Sections 7.17.2.2, 7.17.3 and 7.17.4.2):

- emissions of dust to air from the ZnO product filter reduced to a level of below 0.7 kg dust/tonne ZnO product
  - emissions to air from combustion gases resulting from heating systems, reduced to: SO<sub>2</sub> <0.15 kg/tonne ZnO product, NO<sub>x</sub> <0.125 kg/tonne ZnO product, CO<sub>2</sub> <130 kg/tonne ZnO product
  - total energy consumption of less than 5.2 GJ/tonne ZnO product.
2. Improve process efficiency in the production of zinc oxide via the indirect muffle route by advanced control of process parameters, to achieve the following environmental benefits and performance targets (see Sections 7.17.2.2, 7.17.3 and 7.17.4.2):
- emissions of dust to air from the ZnO product filter reduced to a level of below 0.25 kg dust/tonne ZnO product
  - emissions to air from combustion gases resulting from heating systems, reduced to: SO<sub>2</sub> <0.2 kg/tonne ZnO product, NO<sub>x</sub> <0.3 kg/tonne ZnO product, CO<sub>2</sub> <450 kg/tonne ZnO product
  - total energy consumption of less than 8.6 GJ/tonne ZnO product.
3. Improve process efficiency in the production of zinc oxide via the indirect rectification route by advanced control of process parameters, to achieve the following environmental benefits and performance targets (see Sections 7.17.2.2, 7.17.3 and 7.17.4.2):
- emissions of dust to air from ZnO product filter reduced to a level of below 0.25 kg dust/tonne ZnO product
  - emissions to air from combustion gases resulting from heating systems, reduced to: SO<sub>2</sub> <0.1 kg/tonne ZnO product, NO<sub>x</sub> <0.8 kg/tonne ZnO product, CO<sub>2</sub> <950 kg/tonne ZnO product
  - total energy consumption of less than 14.4 GJ/tonne ZnO product.
4. Improve process efficiency in the production of zinc oxide via the indirect retort route by advanced control of process parameters, to achieve the following environmental benefits and performance targets (see Sections 7.17.2.2, 7.17.3 and 7.17.4.2):
- emissions of dust to air from ZnO product filter reduced to a level of below 0.05 kg dust/tonne ZnO product
  - emissions to air from combustion gases resulting from heating systems, reduced to: SO<sub>2</sub> <0.2 kg/tonne ZnO product, NO<sub>x</sub> <0.5 kg/tonne ZnO product, CO<sub>2</sub> <420 kg/tonne ZnO product
  - total energy consumption of less than 9.3 GJ/tonne ZnO product.
5. Improve process efficiency in the production of zinc oxide via the indirect rotary kiln route by advanced control of process parameters, to achieve the following environmental benefits and performance targets (see Sections 7.17.2.2, 7.17.3 and 7.17.4.2):
- emissions of dust to air from ZnO product filter reduced to a level of below 0.17 kg dust/tonne ZnO product
  - emissions to air from combustion gases resulting from heating systems, reduced to: SO<sub>2</sub> <0.2 kg/tonne ZnO product, NO<sub>x</sub> <0.3 kg/tonne ZnO product, CO<sub>2</sub> <330 kg/tonne ZnO product
  - total energy consumption of less than 3.8 GJ/tonne ZnO product.

**For the production of zinc oxide by the wet chemical process route, BAT is to:**

1. Install and properly maintain the continuous monitoring of effluents to water to protect the aquatic environment and to initiate counteractive measures whenever malfunctions may occur (see Section 7.17.4).
2. Improve process efficiency in the production of zinc oxide via the wet chemical process route by advanced control of process parameters, to achieve the following environmental benefits and performance targets (see Sections 7.17.2.3, 7.17.3 and 7.17.4.3):
  - emissions of dust to air from ZnO product filter reduced to a level of below 0.7 kg dust/tonne ZnO product
  - emissions of SO<sub>2</sub> to air from combustion gases resulting from heating systems, reduced to below 0.2 kg/tonne ZnO product
  - total energy consumption of less than 14 GJ/tonne ZnO product.
3. Maintain the optimum water balance in the ZnO plant, not exceeding the discharge of 25 m<sup>3</sup> of waste water per tonne of ZnO produced when starting the production of ZnO with either ZnCl<sub>2</sub> or ZnSO<sub>4</sub> solution. This reduces the impact of waste waters containing chloride or sulphate ions on the aquatic environment (see Sections 7.17.3 and 7.17.4.3).

Note:

When zinc oxide is produced as a by-product, it is possible to achieve complete recycling of waste water (see Sections 7.17.3 and 7.17.4.3).

## 8 COMMON ABATEMENT MEASURES APPLIED IN THE LVIC-S INDUSTRY

### 8.1 General remarks

In the preceding Chapters 2 through to 7 of this document, an attempt has been made to set out techniques considered to have potential for achieving a high level of environmental protection in the cornerstone and selected illustrative LVIC-S industry installations.

Sections 4 of the preceding Chapters 2 through to 7 of this document focused on analysing and defining techniques that are considered to be most relevant for determining BAT in the LVIC-S industry. In several instances, this information includes the consumption and emission levels considered achievable by using the technique in question, and illustrates other issues relevant to the application of a technique in the LVIC-S plants requiring IPPC permits.

It should also be mentioned, that in the preceding chapters, techniques to consider in the determination of BAT have been analysed broadly according to Article 2(11) and Annex IV of the Directive. Annex IV lists a number of general considerations to be taken into account when determining BAT. These are outlined below [11, The Council of the EU, 1996]:

- the use of low waste technology
- the use of less hazardous substances
- the furthering of recovery and recycling of substances generated and used in the process and of waste, where appropriate
- comparable processes, facilities or methods of operation that have been tried with success on an industrial scale
- technological advances and changes in scientific knowledge and understanding
- the nature, effects and volume of the emissions concerned
- the commissioning dates for new or existing installations
- the length of time needed to introduce the best available technique
- the consumption and nature of raw materials (including water) used in the process and their energy efficiency
- the need to prevent or reduce to a minimum the overall impact of the emissions on the environment and the risks to it
- the need to prevent accidents and to minimise the consequences for the environment
- the information published by the Commission pursuant to Article 16 (2) or by international organisations.

Apart from the considerations included in Annex IV to the Directive, it is also necessary to highlight the importance of the purity of the raw materials used in the production of LVIC-S, as the use of appropriately purified raw materials influences the scale of waste generation, and waste treatment and abatement techniques (refer to Section 1.3.6 above, and see Sections 8.4.2 and 8.4.3 below).

In this context, it is necessary to stress that where inorganic ores are used, their impurities end up either as an emission, as treatable or untreatable wastes, or as part of the product.

It is, therefore, important to prepare for each of the analysed processes a basic mass balance, in order to illustrate main relations between the amount of raw materials used and the output of LVIC-S products. Even a simplified mass balance will be helpful for drawing conclusions on the material efficiency in a given process, as well as on the correctness of specific consumption figures quoted and their distance to the stoichiometric figures which, in many cases, can be a clear indication on the room for possible improvements in a given LVIC-S process.

The techniques and emission levels presented in Sections 4 of the preceding Chapters 2 through to 7 of this document, are not necessarily appropriate for all analysed installations. This stems from the fact that in the LVIC-S industry many technological processes are applied, in several cases using quite different process routes and specific plant configurations.

These are either chosen because of local availability of raw materials and market demand, or because of other constraints, including locally available industrial infrastructure and skilled manpower.

In some cases, apart from process-integrated techniques and end-of-pipe measures, management systems have also been analysed. Reference is made here in particular to Section 8.9, providing key information on Environmental Management System (EMS) which is a tool for IPPC installations that operators can use to address the design, construction, maintenance, operation and decommissioning issues in a systematic, demonstrable way.

Some environmental aspects are not specifically related to the LVIC-S industry alone. These horizontal and local aspects are relevant to most industrial production processes, and are dealt with in the BREFs on: the General Principles of Monitoring (MON), Industrial Cooling Systems (CV), Waste Water and Waste Gas Treatment/Management Systems in the Chemical Sector (CWW), and Emissions from Storage (ESB).

On the other hand, there are several pollutants and available techniques applied in the LVIC-S industry across the EU-25, that may be regarded as common in this sector as a whole and in many cases reflect current performance of some installations within the sector. These are discussed in the following sections.

## 8.2 Emissions to air applicable to the LVIC-S industry

### 8.2.1 Common air pollutants met in LVIC-S processes

When comparing the lists of main air polluting substances to be taken into account if they are relevant for fixing emission limit values (ELV), the following nine pollutants emitted to air can be considered generic of the production of LVIC-S:

- Sulphur dioxide and other sulphur compounds (e.g. hydrogen sulphide)
- Oxides of nitrogen and other nitrogen compounds (e.g. ammonia)
- Carbon monoxide
- Carbon dioxide
- Volatile organic compounds
- Metals and their compounds
- Dust (particulate matter)
- Chlorine and its compounds (e.g. hydrogen chloride)
- Fluorine and its compounds (e.g. hydrogen fluoride).

These pollutants stem from Annex III to the IPPC Directive [11, The Council of the EU, 1996], the list of air pollutants identified in EPER, most likely to be met in the LVIC-S industry [12, European Environment Agency, 2004] and pollutants commonly met in many LVIC-S production processes [6, CEFIC, 2002].

Apart from the process-related CO<sub>2</sub> releases to air originating from the production of soda ash, carbon black, pyrogenic synthetic silica, sodium silicate, magnesium oxide by burning magnesium carbonate, calcium chloride by burning dolomite, and zinc oxide by the direct process route, the emissions of CO<sub>2</sub> are in most cases linked to the energy generation – (power plants, boiler plants, which are part of sites, where LVIC-S are produced) – and, in many cases, these are not directly related to the LVIC-S industry (refer to the BREF on LCP).

## 8.2.2 The sources of emissions to air in the LVIC-S industry

Table 8.1 below shows the main sources of emissions to air in the LVIC-S industry [6, CEFIC, 2002].

It is to be read in conjunction with the process descriptions given in Sections 2 of the Chapters 2 through to 7 of this BREF.

Substance	Process	Volume of exhaust gas Nm <sup>3</sup> /t	Cl <sub>2</sub>	HCl	SO <sub>x</sub>	NO <sub>x</sub>	NH <sub>3</sub>	HF	Dust	Others
Aluminium fluoride	From hydrogen fluoride, Chapter 7	Small			R*	R*		R	R	CO
Aluminium fluoride	From fluosilicic acid, Chapter 7	Large			R*	R*		R	R	CO
Calcium carbide	Lime reduction in an electric furnace, Chapter 7	Medium			R*	R*			R	CO
Carbon black	See Chapter 4 on carbon Black	Large			R*	R*			R	
Lead oxide	Direct lead oxidation, Chapter 7	Medium							R	Lead
Magnesium oxide	From hydroxide or chloride, Chapter 7	Large		R	R*	R*			R	
Phosphate (feed)	From rock, purified acid, Chapter 6	Medium		R		R	R <sup>(2)</sup>	R	R	P <sub>2</sub> O <sub>5</sub>
Synthetic amorph. silica	See Chapter 5 on SA Silica	Medium	R	R		R*			R	CO, VOC
Silicon carbide	Reaction of sand and coal, Chapter 7	Large /Medium			R				R	CO
Sodium bicarbonate	See Chapter 2 on soda Ash	Medium			R*	R*	R		R	CO <sub>2</sub>
Sodium carbonate	See Chapter 2 on soda Ash	Large			R*	R*	R		R	CO <sub>2</sub> , CO
Sodium chlorate	Sodium chloride electrolysis, Ch. 7	Medium	R						R	H <sub>2</sub>
Sodium perborates	From boron ores, Chapter 7	Large							R	
Sodium percarbonate	Crystallisation or spraying process, Chapter 7	Medium							R	
STPP <sup>(1)</sup>	Reaction and calcination, Ch. 6	Large			R*	R*		R	R	CO <sub>2</sub> , P <sub>2</sub> O <sub>5</sub>
Sodium silicates	Waterglass process, Chapter 7	Large			R*	R*			R	CO
Zeolites	See Chapter 7	Large							R	
Titanium dioxide	See Chapter 3 on TiO <sub>2</sub>	Large		R	R*	R*			R	
Zinc oxide	From secondary or primary zinc, Ch. 7	Large			R*	R*			R	CO

R = probable presence  
R\* = the amount of pollutant emitted depends on the quality of an auxiliary product used in the process  
Notes: <sup>(1)</sup> STPP – Sodium tripolyphosphate (Na<sub>5</sub>P<sub>3</sub>O<sub>10</sub>); <sup>(2)</sup> For feed phosphates, NH<sub>3</sub> emissions are only applicable to the process producing mono-ammonium phosphate (MAP), which is less than 1 % of the total feed phosphates production.

**Table 8.1: The sources of emissions to air in the LVIC-S industry [6, CEFIC, 2002], [85, EIPPCB, 2004-2005]**

Table 8.1 is far from describing all the processes used on an industrial scale to produce the compounds covered by this document, but gives an additional insight to the production of a given LVIC-S. The volume of exhaust gas denotes the total volume of the gaseous emissions leaving the production unit and released to the air after treatment, regardless of whether those emissions have been treated or not.



It excludes, however, the volume of the emissions from the shared utilities producers (e.g. flue-gas from power or boiler plants). Expert judgement has been used to supply qualitative information in the form of an index with three ranges where ‘Small’, ‘Medium’ and ‘Large’ mean  $<100$ ,  $>100$  and  $<1000$ , and  $>1000$   $\text{Nm}^3/\text{tonne}$  end-product respectively.

The probable presence of a given pollutant is usually noted ‘R’ (for relevant). Index ‘R\*’ means that the amount of pollutant emitted depends on the quality of an auxiliary product used in the process (e.g. a combustible).

### 8.2.3 Abatement of generic pollutants emitted to air

The following list emphasises the limitations of using generic concentration based emissions as an indication of what any particular BAT can achieve:

- firstly there is the need to define, in each case, the duration of the measurement period. Obviously a short duration measurement can give values that misrepresent the true ongoing performance of any emission control process – refer to the MON BREF
- similarly, the load or throughput will influence the performance of the technique and, therefore, the conditions of measurement should be at the design throughput. This is particularly relevant for some downstream and batch processes where the unavoidable load variation can limit the efficiency of the emitted gas concentration – see the example of  $\text{SO}_2$  emission levels in Section 8.2.3.3
- the process chemistry and physics must be taken into account. A particular technique applied to a simple chemical system may perform quite differently if used in a complex system where the cross chemical interactions may control the performance of the technique. Similarly, if the emission control technique involves the catalytic breakdown of any particular pollutant, then a simple system, with no components that may poison the catalyst, will almost certainly perform better in a simple system than in a complex one
- the potential for cross-media effects needs to be taken into account, in particular in removing pollutants from air, as additional energy usage for the abatement or a shift of the pollution to another environmental medium (water pollution, solid waste generation) may be involved
- finally, it must be said that costs and economic viability to some extent play a part here. If, due to the reasons described above, the application of a particular technique to a simple system is cost effective, it does not necessarily mean that the application of such a technique to a complex system leads to the same conclusion. The application of a given technique to a complex system may require an excessive number of emission control units and/or unrealistic process offline time to maintain the equipment performances at the required level.

General information and specific process-related information on associated air emission ranges and BAT AELs are both included in Chapters 2 through to 7.

More information can also be found in the CWW and LCP BREFs.

#### 8.2.3.1 Chlorine

The usual abatement technique consists of alkaline scrubbing, leading to a hypochlorite solution, which is further destroyed when it cannot be recovered for sale [6, CEFIC, 2002]. Achievable chlorine emission levels below  $10 \text{ mg Cl}_2/\text{Nm}^3$  of the outlet gas are reported, as based on [49, CEFIC-ASASP, 2002].

For example, for synthetic amorphous pyrogenic silica production, chlorine emission levels of  $3 - 10 \text{ mg Cl}_2/\text{Nm}^3$  of the outlet gas are achieved (see Section 5.5.1). Also, in the production of sodium chlorate, emissions of chlorine of  $0.05 - 1 \text{ g/t NaClO}_3$  are achieved (see Section 7.13.5).

### 8.2.3.2 Hydrogen chloride

The usual abatement techniques consist of water scrubbing, or alkaline scrubbing, or the combination of both. When water scrubbing is carried out, the resulting hydrochloric acid solution is further destroyed when it cannot be recovered for sale or re-use [6, CEFIC, 2002].

Some examples of achievable hydrogen chloride emissions in the LVIC-S industry include:

- 0.03 – 0.1 kg/t TiO<sub>2</sub> pigment in the production of titanium dioxide by the chloride process route (see Section 3.5.1)
- <10 mg/Nm<sup>3</sup> in the production of synthetic amorphous pyrogenic silica (see Section 5.5.1)
- 10 – 30 mg/Nm<sup>3</sup> in the production of feed phosphates manufactured by the hydrochloric acid route (see Section 6.5.3.2)
- <0.1 kg/t CaCl<sub>2</sub> 100 % as 36 wt-% CaCl<sub>2</sub> liquor produced via the acid-limestone route (see Section 7.11.5).

### 8.2.3.3 Sulphur dioxide

Sulphur dioxide often results from the combustion of fuel in the LVIC-S processes (except for natural gas which is virtually free of sulphur components). When possible, avoidance measures i.e. the use of fuel with a lower sulphur content is preferred (according to the Directive 1999/32/EC, relating to the reduction of sulphur content of certain liquid fuels: heavy fuel oil <1 % S, gasoil <0.1 % S). When necessary, sulphur dioxide can be abated by alkaline scrubbing [6, CEFIC, 2002] or catalytic conversion to sulphuric acid [85, EIPPCB, 2004-2005].

To better illustrate a very broad spread of the ranges of SO<sub>2</sub> emission values in the LVIC-S industry, refer to the following examples:

- 1.3 – 1.7 kg/t TiO<sub>2</sub> pigment in the production of titanium dioxide by the chloride process route (see Section 3.5.1)
- 1 – 6 kg/t TiO<sub>2</sub> pigment in the production of titanium dioxide by the sulphate process route (see Section 3.5.2)
- 10 – 50 kg/t rubber grade carbon black produced, as a yearly average. These levels are achieved assuming that the secondary feedstock is natural gas (see Section 4.5)
- <32 kg/t iron oxide pigment produced (equivalent to 1200 mg/Nm<sup>3</sup>) (see Section 7.5.6.5)
- <0.6 kg/t for the dry stage sections applied in the production of dead-burned magnesia, starting from MgCl<sub>2</sub> brine and dolomite (see Section 7.7.5)
- 100 – 200 mg/Nm<sup>3</sup> (average ½ hourly values) in the production of sodium silicate via the melting route, for both the continuous and batch furnaces (see Section 7.8.5)
- 6.4 – 11 kg/t 100 % silicon carbide, based on the freiland furnace set-up (see Section 7.9.5)
- for the manufacture of sodium sulphite with SO<sub>2</sub> delivery to the site, levels of <20 mg/Nm<sup>3</sup> are achieved (emissions of SO<sub>2</sub> to air from the storage of liquid SO<sub>2</sub>) (see Section 7.16.5)
- for the main stage production process of sodium sulphite and related products, levels of <20 mg/Nm<sup>3</sup> (emissions of SO<sub>2</sub> to air from the sulphite reactors handling low load/almost pure gas) and <150 mg/Nm<sup>3</sup> (emissions of SO<sub>2</sub> to air from the sulphite reactors handling high load/inert carrier gas), are achieved (see Section 7.16.5)
- <0.6 kg/t zinc oxide produced by the direct process (see Section 7.17.5)
- in the production of zinc oxide by the indirect process (see Section 7.17.5):
  - <0.15 kg/t via the indirect electrothermal route
  - <0.2 kg/t via the indirect muffle retort route
  - <0.1 kg/t via the indirect rectification route
  - <0.2 kg/t via the indirect retort route
  - <0.2 kg/t via the indirect rotary kiln route
- <0.2 kg/t zinc oxide produced by the wet chemical process (see Section 7.17.5).

**8.2.3.4 Nitrogen oxides**

Nitrogen oxides often result from the combustion of fuel in the LVIC-S process (refer to the LCP BREF). In some cases, control measures are taken to minimise their production, and no further abatement is provided [6, CEFIC, 2002]. The NO<sub>x</sub> emissions can be reduced applying both primary and secondary end-of-pipe measures (for a better illustration refer to Sections 4.4.1 (primary measures) and 4.4.4 and 4.4.5 (secondary measures, respectively SNCR and SCR).

For an illustration of the complexity in the ranges of NO<sub>2</sub> emission values in the LVIC-S industry, refer to the following examples:

- 0.6 – 1 g/Nm<sup>3</sup> in the carbon black industry (hourly average) (see Section 4.5)
- in the copperas dehydration kiln, levels to <2.6 kg/t iron oxide pigment produced are achieved (equivalent to 150 mg/Nm<sup>3</sup>) (see Section 7.5.6.5)
- <2.1 – 4.4 kg/t for the dry stage sections applied in the production of dead-burned magnesia, starting from MgCl<sub>2</sub> brine and dolomite (see Section 7.7.5)
- 400 – 640 mg/Nm<sup>3</sup> of the outlet gas (tank furnace, the lower range is for liquid fuel, and the upper range is for gaseous fuel used), in the sodium silicate industry (average ½ hourly values) (see Section 7.8.5)
- <0.75 kg/t zinc oxide produced by the direct process (see Section 7.17.5)
- in the production of zinc oxide by the indirect process (see Section 7.17.5):
  - <0.125 kg/t via the indirect electrothermal route
  - <0.3 kg/t via the indirect muffle retort route
  - <0.8 kg/t via the indirect rectification route
  - <0.5 kg/t via the indirect retort route
  - <0.3 kg/t via the indirect rotary kiln route.

**8.2.3.5 Ammonia**

NH<sub>3</sub> emissions are generally reduced by wet scrubbing (e.g. water, brine and acidic water), and the resulting solution is further treated, or when possible recovered for re-use or sale [6, CEFIC, 2002].

The treatment of effluent containing ammonia is a typical case where the cross-media effects particularly (removal of ammonia from the gaseous phase may lead to an emission in the liquid phase) have to be taken into consideration. The appropriate treatments are generally production- or process-specific and their applicability requires special assessment [85, EIPPCB, 2004-2005].

Different ranges of final concentrations may be observed depending on the characteristics of the gas stream to be treated, on the processes where the treatment is applied and the further techniques that enable NH<sub>3</sub> recovery. For example, for the main stage production process of sodium sulphite and related products, emissions of 5 mg NH<sub>3</sub>/Nm<sup>3</sup> from the ammonia handling and processing sections can be achieved by using water scrubbing (see Section 7.16.5).

**8.2.3.6 VOC**

VOC emissions may arise in certain processes where natural substances are submitted to high temperatures. Many abatement techniques (e.g. thermal/catalytic oxidation and absorption, adsorption) can be used [6, CEFIC, 2002].

For VOC emissions, the CWW BREF quotes achievable performance (% pollutant removal) which varies depending on the technique applied: 50 – 99 % for wet scrubbing, 80 – 95 % for adsorption, 75 – 99 % for biological treatment, 90 – 99 % for catalytic oxidation, 95 – 99 % for thermal oxidation, and up to 99.9 % for membrane separation.

### 8.2.3.7 Dust

Dust emissions arise from all LVIC-S processes. They originate either from the process itself – e.g. vent from a product dryer or reactor, or from the handling of the substance, or from product finishing such as milling or powdering – a typical example is the air which has been used for air-conveyors. Many techniques (e.g. cyclones, bag filters and scrubbers) can be used to treat ducted streams [6, CEFIC, 2002], but the treatment which is appropriate will depend on the type of stream: flow of air to be treated, type of dust (e.g. fine and chemical nature) temperature, humidity, pH conditions. This section addresses ‘dry’ ducted air streams, that is where – as a function of temperature – the humidity is below the dew point.

The following major constraints and cross-media effects need to be considered for dust abatement [85, EIPPCB, 2004-2005]:

- dust emissions and the feasibility of their abatement will depend on the process considered, but also on the quality and characteristics of the required finished product (e.g. milling for particle size, handling for packaging and drying)
- dust removed from air streams may be transferred to either water (e.g. scrubber water) or waste (used filter material). Where the dust consists essentially of inorganic chemicals, and where these cannot be recovered for recycling in the process, then it should be assessed whether it is worthwhile (economic costs, cross-media effects) transferring the chemical out of air into water or solid waste
- all dust abatement systems will have cross-media effects, including energy consumption, raw materials consumption (new filter materials, installation), waste production (e.g. used filters), as well as economic costs, and all of these will increase exponentially if lower emissions levels are required
- cross-media effects and economic costs will be higher for certain process air streams with characteristics such as high temperature, high airflow rates, humidity, and certain physico-chemical dust characteristics (e.g. sub-micron particles)
- the cross-media effects, energy consumption and economic feasibility for dust abatement should be compared with the environmental benefits of reducing dust emission levels, as a function of the characteristics (physico-chemical properties) of the dust in a given LVIC-S process, and of its local impact on the environment and human beings
- dust emission values coming from only one source, cannot be treated as a ‘universal’ figure appropriate to define emission ranges that are most representative of the LVIC-S family.

As an illustration, different ranges of dust emission concentrations encountered in the LVIC-S industry are shown below:

- <5 – 50 mg/Nm<sup>3</sup> in the production of soda ash (see Section 2.5)
- 0.1 – 0.2 kg/t TiO<sub>2</sub> pigment in the production of titanium dioxide by the chloride process route (see Section 3.5.1)
- 0.004 – 0.45 kg/t TiO<sub>2</sub> pigment or <5 – 20 mg/Nm<sup>3</sup> in the production of titanium dioxide by the sulphate process route (see Section 3.5.2)
- 10 – 30 mg/Nm<sup>3</sup> (at 10 % O<sub>2</sub>) in the production of carbon black (half hourly average). This range is only representative for carbon black plants with a single stack [85, EIPPCB, 2004-2005] (see Section 4.5)
- <20 – 50 mg/Nm<sup>3</sup> in the production of synthetic amorphous pyrogenic silica (see Section 5.5.1)
- <10 – 20 mg/Nm<sup>3</sup> in the production of synthetic amorphous precipitated silica. For certain product grades, values of up to 40 mg/m<sup>3</sup> are expected (see Section 5.5.2)
- in the production of inorganic phosphates:
  - <20 mg/Nm<sup>3</sup> (dry airstreams) for the production of detergent-grade STPP based on green phosphoric acid (see Section 6.5.1), food and detergent-grade STPP based on purified wet phosphoric acid (see Section 6.5.2) and feed phosphate DCP manufactured by the phosphoric acid route (see Section 6.5.3.1)

- 10 – 50 mg/Nm<sup>3</sup> (dry airstreams) in the production of feed phosphate DCP manufactured by the hydrochloric acid route (see Section 6.5.3.2)
- 0.05 kg/t AlF<sub>3</sub> in the production of aluminium fluoride via the dry fluorspar process and 0.1 kg/t AlF<sub>3</sub> in the production of aluminium fluoride via the wet fluosilicic acid process (see Section 7.1.5)
- 1 – 5 mg/Nm<sup>3</sup> in the production of calcium carbide (see Section 7.2.5)
- 0.004 – 0.08 kg/t dried ferrous sulphate heptahydrate and monohydrate produced (see Section 7.5.3.5)
- 0.03 – 0.5 kg/t solid ferric sulphate produced (see Section 7.5.4.5)
- 1.3 kg/t iron oxide pigment produced (see Section 7.5.6.5)
- <0.1 – 0.2 mg/Nm<sup>3</sup> in the production of lead oxide (see Section 7.6.5)
- <0.3 kg/t for the dry stage sections applied in the production of dead-burned magnesia, starting from MgCl<sub>2</sub> brine and dolomite (equivalent to <35 mg/Nm<sup>3</sup>) (see Section 7.7.5)
- in the production of sodium silicate via the melting route, concentrations of 10 - 20 mg/Nm<sup>3</sup> (average ½ hourly values) using a continuous tank furnace and of 30 - 60 mg/Nm<sup>3</sup> (average ½ hourly values) using a revolving hearth furnace, are achieved (see Section 7.8.5)
- 13 kg/t 100 % SiC in the production of silicon carbide using a traditional furnace set-up (see Section 7.9.5)
- <0.8 kg/t zeolites produced and <1.5 kg/t speciality zeolites produced, both manufactured via the dry stage process (see Section 7.10.5)
- <5 – 20 mg/Nm<sup>3</sup> in the production of sodium perborate tetrahydrate and sodium perborate monohydrate (see Section 7.14.5)
- <5 – 20 mg/Nm<sup>3</sup> in the production of sodium percarbonate (see Section 7.15.5)
- <20 mg/Nm<sup>3</sup> in the main stage production process of sodium sulphite and related products (see Section 7.16.5)
- <0.05 kg/t zinc oxide produced by the direct process (see Section 7.17.5)
- in the production of zinc oxide by the indirect process (see Section 7.17.5):
  - <0.7 kg/t via the indirect electrothermal route
  - <0.25 kg/t via the indirect muffle retort route
  - <0.25 kg/t via the indirect rectification route
  - <0.05 kg/t via the indirect retort route
  - <0.17 kg/t via the indirect rotary kiln route
- <0.7 kg/t zinc oxide produced by the wet chemical process (see Section 7.17.5).

### 8.2.3.8 Carbon monoxide

Carbon monoxide emissions result from the combustion of fuels, and the emission level depends on both the process in which combustion takes place and the fuel quality. Where process conditions allow, control of the combustion conditions, e.g. by means of an advanced control system, is the most usual way to reduce the carbon monoxide emissions [6, CEFIC, 2002].

For the dry stage sections applied in the production of dead-burned magnesia starting from MgCl<sub>2</sub> brine and dolomite, CO emissions of 3.5 – 14.5 kg/t are achieved (see Section 7.7.5).

### 8.2.3.9 Carbon dioxide

In the LVIC-S industry sector, CO<sub>2</sub> emissions predominantly result from the combustion of fuels, used to supply energy in different forms required in the production processes. Therefore, the potential for increasing energy efficiency in the LVIC-S industry, on both the energy supply side and the energy demand side, is of a primary importance for reducing emissions of CO<sub>2</sub> to air in this industry. Carbon dioxide emissions are one of the key indicators of sustainable development in the EU chemical industry sector – refer to Section 1.1.1.8.

On a process side in the LVIC-S industry, carbon dioxide emissions are encountered in many analysed processes but, because of the CO<sub>2</sub> volumes involved, they are mostly characteristic to soda ash plants, where limestone and coke are used to produce process CO<sub>2</sub> gas for soda ash production – refer to Section 2.4.3. Emissions of CO<sub>2</sub> from the soda ash process are in the range of 0.2 – 0.4 tonne of 100 % CO<sub>2</sub> per tonne of soda ash produced.

Apart from the control of limestone burning conditions to minimise the CO<sub>2</sub> losses to the atmosphere, process optimisation and re-use of CO<sub>2</sub> gas from the calcination section within the process, an additional possibility to reduce CO<sub>2</sub> emissions in the soda ash industrial complex is to integrate a soda ash plant with a sodium bicarbonate plant, which is a net consumer of carbon dioxide [33, CEFIC-ESAPA, 2004], [53, EIPPCB, 2004], [39, S. Leszczynski et al, 1978].

CO<sub>2</sub> achieved emission values are also reported for the production of zinc oxide (see Section 7.17.5), which are:

- <875 kg/t zinc oxide produced by the direct process
- in the production of zinc oxide by the indirect process:
  - <130 kg/t via the indirect electrothermal route
  - <450 kg/t via the indirect muffle retort route
  - <950 kg/t via the indirect rectification route
  - <420 kg/t via the indirect retort route
  - <330 kg/t via the indirect rotary kiln route.

It should be also noted, that many CO<sub>2</sub> emissions covered in this document are under the scope of national and EU carbon dioxide emission trading programmes – refer to Article 9 of the IPPC Directive.

#### 8.2.4 Measures to reduce or prevent releases into air

Significant air pollution results from energy generation in power plants and from LVIC-S production plants. Emissions from power plants usually consist of typical air pollutants SO<sub>2</sub>, NO<sub>x</sub>, dust and of the greenhouse gas CO<sub>2</sub>, which is all detailed in the BREF on Large Combustion Plants.

Air pollutants from the production plants themselves can be emitted from:

- process off-gas streams, which have to be released. According to the process used, they may include combustion gases (e.g. CO, CO<sub>2</sub>, SO<sub>x</sub>, NO<sub>x</sub>), visible water vapour clouds, reaction gas like CO<sub>2</sub>, residual gases not totally removed by the abatement systems (e.g. acid gases, ammonia), mists and dust particulates
- solid material handling systems (e.g. air from pneumatic conveyors)
- venting of vessels and pipes (e.g. displaced air of vessels during filling up)
- incidental emissions into the atmosphere (e.g. pressure release through safety valves)
- diffuse sources (e.g. flanges, valves, etc.).

These emissions can result from normal operations, disturbances of the process, start up and shut down operations.

Many processes producing LVIC-S compounds use corrosive and/or toxic materials, and special attention has to be paid to incidental and fugitive emissions of gases contained in the vessels and pipes. Even tiny leaks should not be tolerated. The strong odour, the visible dust emissions or the aggressive character of these compounds make them readily detectable.

Action to reduce emissions of hazardous substances should be taken considering safety requirements, properties and concentration of substances, legal requirements and costs of material losses. The following issues can be particularly relevant:

- recording, rating and permanent emission control of relevant sources
- reducing the effluent flows
- a gas phase connection between the different vessels containing compatible substances if one is emptied at the same time as another one is filled up
- using a closed sampling system
- using blind flanges as far as practicable to ensure tightness (e.g. on emptying valves only used for maintenance)
- where appropriate and practicable, reduction of diffuse emissions by means of process measures (e.g. plant operation slightly below atmospheric pressure), of prevention measures (e.g. flanges replaced by welded connections, usage of seal-less pumps, and bellow valves) and of minimisation measures (e.g. high performance sealing systems like effective gaskets and flanges, valves and pumps with high integrity packing) – refer also to the LVOC BREF (illustrating the principle that the more the emissions from the stack are reduced, the more important diffuse emissions become at a given site)
- having periodic leak detection programmes and carrying out result based maintenance (e.g. valve monitoring)
- discharging off-gases into appropriate treatment units (e.g. a catalytic or thermal oxidiser for waste gas, or waste gas scrubber)
- using special dedusting systems.

The impact and effectiveness of the environmental preventive measures have to be considered and assessed, taking into account possible cross-media effects.

Generic techniques of waste water or off-gas cleaning are specified in the Common Waste Water and Waste Gas Treatment/Management Systems in the Chemical Sector BREF (CWW), while specific techniques, where relevant, are described in Chapters 2 through 7 of this document.

### **8.2.4.1 Techniques available for reducing emissions to air**

Techniques for reducing emissions to air in relation to the inorganic chemical component to be removed (dry matter, wet matter, inorganic particulates, inorganic gaseous or vaporous components, and odour), and in relation to the waste gas flowrate are listed in the BREF on the Waste Water and Waste Gas Treatment/Management Systems in the Chemical Sector (CWW).

A simplified list of techniques for reducing emissions to air in relation to the inorganic chemical component to be removed is given below in Table 8.2. Refer also to the CWW BREF.

Technique	Dry matter	Wet matter	Particulate inorganic components	Inorganic components in gas and vapour form	Odour
<b>Dust separation</b>					
Separator	x	x	x		
Cyclone	x	x	x		
Self-induced spray scrubber	x	x	x		
Dust scrubber	x	x	x		
Electrostatic precipitator	x	x	x	(x)	
<b>Dust filtration</b>					
Fabric filter	x		x		
Compact filter	x		x		
Improved compact filter	x		x		
Ceramic filter	x		x		
HEAF filter		x			
Mist filter		x			
<b>Condensation</b>					
Condenser				(x)	x
<b>Adsorption</b>					
Activated carbon				x	x
Regenerative adsorption					x
Zeolite filter	(x)	(x)	(x)		x
<b>Absorption</b>					
Scrubber	(x)	(x)	(x)	x	x
Scrubber (alkaline)	(x)	(x)	(x)	x	
Scrubber (alkaline-oxidation)	(x)	(x)	(x)		x
Scrubber (acid)	(x)	(x)	(x)	x	
<b>Biological</b>					
Biofiltration					x
Biotrickling				x	x
Bioscrubber				x	x
<b>Oxidation</b>					
Active oxygen injection					x
Thermal incinerator					x
Catalytic incinerator					x
Recuperative incinerator					x
Regenerative incinerator					x
<b>Miscellaneous</b>					
Dry lime injection				x	
Semi dry lime injection				x	
SNCR				x	
SCR				x	
NO <sub>x</sub> scrubber				x	
Membrane filtration					
x – primary application; (x) – secondary application Note: these techniques may not be applicable to all LVIC-S processes					

**Table 8.2: Techniques for reducing emissions of inorganic chemical components to air [13, EIPPCB, 2000]**



In turn, techniques for reducing emissions to air in relation to the waste gas flowrate are listed below in Table 8.3. Refer also to the CWW BREF.

Technique	100 (m <sup>3</sup> /h)	1000 (m <sup>3</sup> /h)	10000 (m <sup>3</sup> /h)	100000 (m <sup>3</sup> /h)
<b>Dust separation</b>				
Separator	x	x	xx	xx
Cyclone	x	xx	xx	x
Self-induced spray scrubber		x	x	
Dust scrubber		x	xx	x
Electrostatic precipitator 1-stage			x	x
Electrostatic precipitator 2-stage	xx	xx	x	
<b>Dust filtration</b>				
Fabric filter	x	x	xx	xx
Compact filter		xx	x	x
Improved compact filter		xx	x	x
Ceramic filter		xx	x	x
HEAF filter	x	xx	xx	
Mist filter		x	xx	x
<b>Condensation</b>				
Condenser	x	x	xx	x
<b>Adsorption</b>				
Activated carbon	x	xx	xx	x
Regenerative adsorption	x	xx	xx	x
Zeolite filter	x	x	x	x
<b>Absorption</b>				
Scrubber	x	x	xx	xx
Scrubber (alkaline)	x	x	xx	xx
Scrubber (alkaline-oxidation)	x	x	xx	x
Scrubber (acid)	x	x	xx	xx
<b>Biological</b>				
Biofiltration	x	xx	x	x
Biotrickling	x	x	xx	x
Bioscrubber	x	x	xx	xx
<b>Oxidation</b>				
Active oxygen injection		x	xx	x
Thermal incinerator		x	x	
Catalytic incinerator		x	x	
Recuperative incinerator		x	x	
Regenerative incinerator		x	x	
<b>Miscellaneous</b>				
Dry lime injection			x	
Semi dry lime injection			x	x
SNCR	x	x	x	x
SCR		x	xx	xx
NO <sub>x</sub> scrubber		x	xx	xx
Membrane filtration	x	x		
x application; xx most common application				
Note: these techniques may not be applicable to all LVIC-S processes				

**Table 8.3: Techniques for reducing emissions to air in relation to waste gas flowrate [13, EIPPCB, 2000]**

## 8.3 Emissions to water applicable to the LVIC-S industry

### 8.3.1 Common water pollutants met in LVIC-S processes

When comparing the lists of main water polluting substances to be taken into account if they are relevant for fixing emission limit values (ELV), the following eight pollutants emitted to water can be considered generic of the LVIC-S industry:

- chlorides
- sulphates
- phosphates
- ammonia
- fluorides
- metals and heavy metals (including Zn, Cr, and Pb and their compounds)
- inorganic substances
- suspended matters.

These pollutants stem from Annex III to the IPPC Directive [11, The Council of the EU, 1996], the list of water pollutants identified in EPER, most likely to be met in the LVIC-S industry [12, European Environment Agency, 2004] and pollutants commonly met in many LVIC-S production processes [6, CEFIC, 2002].

Apart from the above-mentioned common water pollutants met in LVIC-S processes, also (however to a lesser degree) other water polluting substances which may have an unfavourable influence on the oxygen balance or which are toxic, as well as cyanides and arsenic and its compounds can be found in some cases in the LVIC-S industry.

### 8.3.2 The sources of emissions to water in the LVIC-S industry

Table 8.4 below shows the sources of emissions to water in the LVIC-S industry.

It is to be read in conjunction with the process descriptions given in Sections 2 of the Chapters 2 through to 7 of this document [6, CEFIC, 2002].

Table 8.4 is far from describing all the processes used on an industrial scale to produce the compounds covered by this document, but gives an additional insight to the production of an LVIC-S in question.

Waste water volume denotes the total volume of the aqueous emissions leaving the production unit and released after treatment. However, the cooling water circuit bleed, the rainwater and the emissions from the shared utilities producers are not included.

Due to the variety of situations, it is often not possible to give even rough figures for the volume of waste water. Expert judgement has been used to supply qualitative information in the form of an index with three ranges where 'Small', 'Medium' and 'Large' mean  $<0.3$ ,  $>0.3$  and  $<3$ , and  $>3$  m<sup>3</sup>/tonne end-product respectively.

The probable presence of a given pollutant is denoted by 'R' (for relevant).

Table 8.4 illustrates potential emissions from the LVIC-S industry to water.

Substance	Process	Waste water volume m <sup>3</sup> /t	Cl <sup>-</sup>	SO <sub>4</sub> <sup>2-</sup>	NH <sub>4</sub> <sup>+</sup>	F <sup>-</sup>	Susp. Mat.	Other
Aluminium fluoride	From hydrogen fluoride, Chapter 7	Small				R	R	
Aluminium fluoride	From fluosilicic acid, Chapter 7	Large				R	R	
Carbon black	See Chapter 4 on carbon black	Small						
Lead oxides	Direct lead oxidation, Chapter 7	Small						
Magnesium oxide	From hydroxide or chloride, Chapter 7	Small	R				R	
Phosphate (feed)	From rock, purified acid, Chapter 7	Medium/ Large	R		R	R	R	P <sub>2</sub> O <sub>5</sub>
Silica (amorphous synthetic)	Chapter 5 on SA silica	Large		R			R	
Silicon carbide	Reaction of sand and coal, Chapter 7	Small					R	
Sodium bicarbonate	Chapter 2 on soda ash	Medium	R					Na <sup>+</sup> , CO <sub>3</sub> <sup>=</sup>
Sodium carbonate	Chapter 2 on soda ash	Large	R	R	R		R	Ca <sup>++</sup> , Na <sup>+</sup> H. metals
Sodium chlorate	Sodium chloride electrolysis, Chapter 7	Small	R					ClO <sub>2</sub> <sup>-</sup> , ClO <sub>3</sub> <sup>3-</sup> , Cr <sup>6+</sup>
Sodium perborates	From boron ores, Chapter 7	Medium/ Large					R	Boron, H <sub>2</sub> O <sub>2</sub>
Sodium percarbonate	Crystallisation or spraying process, Chapter 7	Medium/ Large						H <sub>2</sub> O <sub>2</sub> , Na <sup>+</sup>
STPP	Reaction and calcinations, Ch. 6	Small				R	R	P <sub>2</sub> O <sub>5</sub>
Sodium silicates	Waterglass process, Chapter 7	Small					R	
Zeolites	See Chapter 7	Large					R	
Titanium dioxide	See Chapter 3 on TiO <sub>2</sub>	Large	R	R			R	Fe, H. metals
Zinc oxide	From secondary/ primary zinc, Ch. 7	Small					R	

<sup>(1)</sup> STPP – Sodium tripolyphosphate (Na<sub>5</sub>P<sub>3</sub>O<sub>10</sub>);

**Table 8.4: The sources of emissions to water in the LVIC-S industry**  
Based on [6, CEFIC, 2002], [85, EIPPCB, 2004-2005]

### 8.3.3 Abatement of generic pollutants emitted to water

Unless other indications are given in Chapters 2 through to 7 of this document (refer also to the CWW BREF), the following common techniques for the abatement of pollutants emitted to water are to be considered appropriate for the LVIC-S industry [6, CEFIC, 2002], [69, Environment Agency, 1999], [70, Environment Agency, 1999], [13, EIPPCB, 2000], [100, Environment Agency, 2004].

In this context, it is necessary to further emphasise the limitations of using generic concentration based emissions as an indication of what any particular BAT can achieve. Major limitations have been listed in Section 8.2.3 above and, as most of them also apply to the abatement of generic pollutants emitted to water, it would be unreasonable to repeat them here. It should be added, however, that abatement techniques designed to reduce emissions to air may have certain implications on the volume, concentration and physico-chemical characteristics of the aqueous effluent.

### 8.3.3.1 Chlorides

Inorganic chlorides contained in a waste water stream are generally not abated, but released into the environment [6, CEFIC, 2002]. However, this is strongly dependent on the receiving environment and the compound emitted [85, EIPPCB, 2004-2005].

### 8.3.3.2 Sulphates

When emitting sulphates into the aqueous environment is not possible due to local considerations, part of the sulphates can be removed by, e.g. precipitation with lime (or limestone to form gypsum which can be sold as a co-product).

An excess of lime allows a reduction in the release of sulphates, but this obviously leads to an increased usage of lime [6, CEFIC, 2002].

### 8.3.3.3 Phosphates

Soluble phosphates can be removed in the form of insoluble calcium/iron phosphates by means of precipitation (e.g. with lime or  $\text{FeCl}_3$ ), similarly as is the case of dephosphating water in municipal waste water treatment systems [85, EIPPCB, 2004-2005].

### 8.3.3.4 Ammonia

When large amounts of ammonia are at stake, this can be recovered by steam stripping under controlled pH conditions [6, CEFIC, 2002].

### 8.3.3.5 Fluorides

Soluble fluorides can be removed under the form of insoluble calcium fluoride by means of precipitation with, e.g. lime [6, CEFIC, 2002].

### 8.3.3.6 Metals and heavy metals

Metals are usual contaminants of the LVIC-S feedstock (e.g. ores) and they end up with the product, as solid waste, or dissolved in waste water streams. In this latter case, and when it is necessary to avoid rejecting them into the water body, the conventional process consists of precipitating and separating insoluble metal hydroxides, sulphides or phosphates.

The metal release depends on many factors, such as the metal itself; the nature of the precipitating agent and the presence of other metals or organics. Also an excess of reactant allows the reduction in the release of metal, but this then leads to an increased release of the reactant itself [6, CEFIC, 2002].

### 8.3.3.7 Inorganic substances

Abatement techniques are, in most cases, typical for each individual LVIC-S process, and have been described in Chapters 2 through to 7 of this document.

### 8.3.3.8 Suspended matters

Suspended matters are of a major concern in the production of LVIC-S. There are many ways, used individually or in combination, to eliminate suspended matters from waste water streams: flocculation, natural or mechanical-aided decantation, air-flotation, filtration, etc. are the most widely used techniques [6, CEFIC, 2002].

### 8.3.4 Measures available to control water pollutants

#### 8.3.4.1 Measures to reduce or prevent releases into water

Waste water mainly comes from:

- process water
- cleansing procedures
- cooling systems (see the BREF on Industrial Cooling Systems).

It is usually collected in separate sewerage systems where waste water and unpolluted rainwater are drained off separately, without diluting effects, into waste water treatment plants. Depending on the site and the nature of the pollutants, a waste water treatment system may be a central system for several units or a dedicated system for the given plant, or a combination of both.

Some characteristics of a waste water treatment system:

- a common treatment can offer the advantage of smoothing flows, equalising pH, mitigating temperature and reducing treatment cost by the economy of scale effect
- the drawback of a common treatment system could be increased volume that needs to be treated, when a specific pollutant – typically for LVIC-S a low solubility inorganic substance – is present in only certain flows, and to dilute certain pollutants to concentrations close to, or below, their detection limits, which creates problems for efficiency monitoring
- in the case of the LVIC-S industry, common waste water treatment systems are less popular than for other processes like production of organic chemicals (see the CWW and LVOC BREFs).

There are different reduction techniques to avoid waste water emissions:

- water-saving techniques, e. g. countercurrent processes
- multiple use and closed cooling water cycles, e.g. water circulation for washing and cleaning
- indirect condensers instead of mix condensers, e.g. based on steam jet vacuum pumps
- water-free techniques for vacuum generation and for waste gas cleaning, e.g. product as a sealing liquid in vacuum pumps, and replacement of a scrubber by a dust filter
- retaining or reclaiming substances by refining the mother liquor and optimising processes
- use of pure raw materials and auxiliary materials.

In the evaluation of measures to minimise waste water emissions, the environmental cross-media effects of each reduction measure are to be considered.

Generic techniques for the purification of polluted waste water are described in the CWW BREF, while specific techniques, where relevant, are described in this section and in Chapters 2 through to 7 of this document.

### 8.3.4.2 Minimisation of waste water discharges

Waste water can arise from the process, from storm-water, from cooling water, from accidental releases of raw materials, products of waste materials, and from fire fighting.

Aqueous wastes generated from processes in this sector may contain a wide range of species such as chlorides, fluorides, sulphates, sulphides, other inorganic and dissolved heavy-metal compounds, including sulphates and fluorides as well as suspended solids.

The characteristics of releases to water from a chemical plant largely depend upon the type of process involved, the standards of housekeeping, the degree of recycling achieved, and whether or not potential releases to air are transferred into an aqueous medium, e.g. by gas scrubbing.

Streamlined with the provisions of Directive Annex IV, the following techniques should be considered for reducing or preventing the discharges of waste water [69, Environment Agency, 1999]:

- minimise the presence of water in the process including water used in product purification and equipment cleaning
- use dry techniques where appropriate to abate particulate and gaseous exhaust streams
- seek to minimise water consumption in rinsing processes by reducing process drag-out and using appropriate techniques to maximise water conservation and re-use
- recycle or re-use waters back to the processes or to secondary uses such as for cleaning equipment where possible
- where possible, rinse-water consumption should be metered
- where possible, intermittent discharges or extreme variations in flow, concentration or other characteristics should be balanced before treatment
- employ indirect-contact heat exchange devices
- segregate process water, rainwater and indirect cooling water streams to reduce the hydraulic loading to waste water treatment equipment or sewers
- develop spill contingency procedures to minimise the risk of accidental releases of raw materials, products and waste materials and to control such spillages to prevent their entry into water
- eliminate equipment cleaning between batches of the same product unless essential. Where this not possible, such as at weekend shutdown, a reduced level of cleaning should be considered
- use dry cleaning methods wherever practicable for solids. Vacuum extraction reduces the loss of product to water and, in many cases, allows the recovery of these products. In some cases, dry pre-cleaning is an option as well.
- wipe down equipment that is accessible rather than washing and rinsing it.

Treatment chemicals, such as corrosion inhibitors, coagulants, flocculants, descaling agents, NaOH and biocides, should be chosen so that they minimise substances prescribed for water.

### 8.3.4.3 Water collection

#### 8.3.4.3.1 Process waters

Process waters are those obtained as a result of the processes carried out in the chemical works and arise from specific plant items. Examples include process filtrates, distillation condensates, liquors from wet dust-arrestment devices, vacuum pump sealing fluids and wash down/drainage from process, handling and storage areas.

The quantity and nature of contamination will be largely site-specific but for the LVIC-S industry can generally be categorised as follows:

- waste water streams contaminated with inorganic chemical salts (chlorides, fluorides, sulphates, etc)
- acidic and alkaline waste water streams
- waste water streams contaminated with heavy metals.

### 8.3.4.3.2 Site drainage waters

These are essentially rainwater running off hard surfaced plant areas and roofs or collected by purpose-designed drains. Site drainage should be designed such that spillages of chemicals, etc, should be routed to the effluent system with provisions to contain surges and storm-water flows. The collection system should also take account of the additional firewater flows, or fire-fighting foams. Emergency storage lagoons may be needed to prevent contaminated firewater reaching controlled waters.

### 8.3.4.3.3 Cooling waters

Discharges from once-through cooling water systems or other similar sources must not be used to achieve, by dilution, BAT associated emissions for substances prescribed for water being discharged from treatment plants. Refer also to the BREF on Cooling Systems (CV).

### 8.3.4.4 Treatment systems

Treatment methods should be applied as appropriate. Generally the larger the site effluent volume, the more complex the treatment system. Smaller sites (less than 40 m<sup>3</sup>/day effluent) are liable to carry out basic treatment before discharging the effluent to a sewerage system. Generic performance data will be found in the horizontal CWW BREF.

#### 8.3.4.4.1 In plant treatment

The following are applied:

- for sulphides and cyanides – combination of air or wet oxidation, ion exchange, stripping and granular activated carbon
- for heavy metals – combination of oxidation/reduction, precipitation, filtration, ion exchange, reverse osmosis and electromechanical techniques
- for organics – combination of wet oxidation, ion exchange, reverse osmosis and electro dialysis.

#### 8.3.4.4.2 Primary treatment

Primary treatment prepares the waste waters for further treatment. Large solids are removed by screening, and grit is allowed to settle. The following methods and techniques are available:

##### Stripping

Steam stripping techniques are used to remove volatile components dissolved in aqueous effluent streams. Very often gaseous effluent streams requiring further treatment can be formed.

##### Neutralisation

If possible, the first step of neutralisation should be to merge the acidic and alkaline waste water streams, in order to avoid additional salt load.

Effluents should be dosed with an appropriate acid or alkali to achieve a neutral solution. As dosing systems cannot cope with effluents of extreme pH, an intermediate facility capable of storing strongly acidic or alkaline effluents should be installed with automatic control.

### **Oxidation**

Oxidation of contaminants can be achieved by the addition of a variety of reagents. For example, ozone, hydrogen peroxide, and sodium hypochlorite can be used. Other schemes involve pure oxygen, and proprietary catalyst systems.

### **Solids removal**

The removal of particulate matter from effluents can be hindered by flow fluctuations. The removal of finely divided suspended solids can be enhanced by the addition of chemical coagulants/flocculants. These substances can also aid the removal of emulsions and grease. Techniques for the removal of solids include: settlement, flotation, precipitation, dewatering and filtration.

#### **8.3.4.4.3 Secondary/tertiary systems**

The following methods and techniques are available:

##### **Activated carbon adsorption**

Activated carbon columns can be used for the removal of low concentrations of metal species and to polish a final effluent to provide recyclable water. In order to avoid reduced capacity after regeneration, the carbon should be acid-washed prior to re-use. TOC (total organic carbon) can often be reduced by up to 99 % [69, Environment Agency, 1999].

##### **Ion exchange resins**

Ion exchange can be employed for the removal of undesirable anions and cations from waste water. Cations are exchanged for hydrogen or sodium, and anions for hydroxyl ions. Removal of the fine particles containing metal prior to ion exchange may be necessary. Ion exchange can remove cyanide and sulphide from the effluent; however, it does not destroy the cyanide and a subsequent treatment of the regeneration solutions would be required.

##### **Membrane processes**

Membrane processes include: ultrafiltration, reverse osmosis, and membrane filtration. These systems concentrate solutions by selective filtration and usually produce a purified filtrate stream and a concentrate stream. These types of processes can be used either to clean up the waste water for re-use, or to recover material for recycling.

##### **Biological treatment**

In specific conditions, biological treatment can be used to remove the compounds of nitrogen, phosphorus and sulphur from waste waters (refer to the BREF on CWW). Treatment by microbial activity requires detailed consideration of the nature of the waste in order to design an appropriate biological treatment system. Potential problems of process inhibition due to the presence of toxins need to be identified by treatability tests. Biological systems may be aerobic or anaerobic. Typical types include: trickle filter beds (biological filtration); rotating biological contactors; fluidised-bed systems; activated sludge; deep shaft and polishing filters.

##### **Electromechanical techniques**

Metals can be extracted from aqueous streams by sacrificial exchange. This process would result in the release of another metal into the aqueous stream.



## 8.4 Solid wastes applicable to the LVIC-S industry

### 8.4.1 Soil pollutants

Soil pollution can come from:

- leakage (liquid or solid)
- overfilling of fixed or mobile tanks
- equipment opening (for maintenance, control, etc.)
- disconnecting mobile tanks
- dust emissions
- abnormal operations (e.g. start up and shut down)
- uncontrolled landfill of waste products.

Due to their intrinsic characteristics, LVIC-S compounds are potentially less soil-damaging than compounds such as organic chemicals. Nevertheless, provisions have to be taken to avoid soil pollution, considering toxic and eco-toxic properties of the emitted substances, the legal requirements and the cost of different pollution prevention measures.

Examples of different pollution prevention measures are:

- tight soil protection and bounding systems
- leak detection systems
- overfilling detection and source control systems
- evaluation on the risks of leakages
- watertight plant or tank tubs
- collecting facilities for liquids and/or solids
- layout of pipes on racks preferably to buried pipes
- minimisation of the number of flanges per pipe or piece of equipment
- correct labelling of the pipes
- organisational measures (e.g. training of the staff).

Depending on the environmental impact, suitable measures to minimise soil pollution should be selected after cost-benefit considerations have been looked into – see also the BREF on Emissions from Storage (ESB).

### 8.4.2 Measures to reduce or prevent releases of waste

The aim should be to prevent the creation of waste, especially hazardous wastes, and to re-use, recycle or sell any by-products generated in a process as a raw material for another process. Total, or at least partial re-use of unwanted by-products, whose presence or formation cannot be avoided, is often a key issue, as this allows a reduction in the amount of waste to dispose of. The feasibility of by-product re-use processes, the market situation, the plant location and other technical possibilities to dispose of the excess of by-product have to be thoroughly assessed prior to a decision.

Positive examples are: the recovery of fluorine from the phosphate rock reactions, and its further re-use to produce aluminium fluoride, and re-use of the calcium sulphate from the production of titanium dioxide to manufacture plasterboards.

Conversely, some LVIC-S processes use feedstock which are by-products of other processes. Examples are the production of zinc derivatives from metal scraps, of aluminium salts from pickling solutions, and of iron oxides from copperas which is a by-product from the titanium dioxide manufacturing process by the sulphate route.

Where waste generation is unavoidable, where possible releases should be rendered harmless and/or minimised by paying attention to the quality and composition of raw materials, process routes and operating conditions.

The key pollutants likely to be present in wastes can be identified from the knowledge of the chemical reaction, feedstock impurities, construction materials, corrosion and/or erosion mechanisms, and validated by the appropriate analytical techniques. The presence of substances created by abnormal operation should be identified, as process abnormalities can carry through substances into the solid waste that are not normally present.

Whether recycling is possible depends on site-specific factors such as the particular fuels and raw materials used, manufactured products, technological methods and the capacities of facilities.

### 8.4.3 Waste control in the LVIC-S industry

Solid wastes may be a very important environmental issue for some LVIC-S processes, and those mentioned here are only the production of soda ash by Solvay process (refer to Chapter 2) and the production of titanium dioxide by the sulphate route (refer to Chapter 3). For a more detailed description and examples pertaining to the LVIC-S industry, refer also to Section 1.3.6, and to Section 8.4.2.

The most characteristic for the LVIC-S industry are wastes from such processes as:

- soda ash waste streams ( $\text{CaCl}_2$  and other salts) – refer to Chapter 2
- $\text{TiO}_2$  waste streams from the sulphate process route ( $\text{CaSO}_4$ ) – refer to Chapter 3
- waste containing phosphate – refer to Chapter 6
- waste streams from various inorganic salts and compounds – refer to Chapter 7
- waste containing halogen (chlorides and fluorides) – refer to Chapter 7.

These wastes mainly contain inert material from the feedstock (e.g. calcium ions from limestone and chloride ions from salt brine in soda ash production), impurities from the feedstock (e.g. titanium or chromium ores), insoluble precipitated salts, wastes generated during the neutralisation of process streams (e.g. neutralisation of spent sulphuric acid in the production of titanium dioxide by sulphate process route), losses of solids during handling, etc.

Waste control procedures need to be established and agreed on a case by case basis with reference to best practice. Waste should be recovered and recycled, unless it is technically or economically not practicable to do so. On a generic level, where waste must be disposed of, the operator should carry out a detailed assessment identifying the best environmental options for waste disposal. In the case, when the re-use of a solid waste is not feasible, it is either disposed of on ground, landfilled, or dispersed into a river or into the sea [6, CEFIC, 2002].

## 8.5 Other environmental issues of concern

### 8.5.1 Vibration

The following primary and secondary measures should be considered to reduce vibrations:

- prevention by selection of low vibration constructions (e.g. steadily running machines instead of pulsating machines; screw instead of reciprocating compressors)
- anti-vibration mounting (e.g. pump basements on rubber foundation)
- disconnection of vibration sources and surroundings (e.g. compensators and separate foundations between reciprocating compressors and connected pipes)
- distance from housing areas.

### 8.5.2 Noise emissions

The following techniques should be considered to reduce noise emissions:

- noise prevention by suitable construction (e.g. prevention of resonant vibration)
- sound absorbers (e.g. for safety valves, combustion machines)
- noise control booth/encapsulation of the noise sources (e.g. compactors, compressors and other machines)
- noise reducing layout of buildings
- when other measures are not sufficient, consider noise protection facilities and/or distance (e.g. noise absorption of open-air plants, etc.).

### 8.5.3 Heat emissions

The following techniques should be considered to use most of the available heat energy and to minimise the heat output into the environment:

- minimisation of heat loss by insulation
- heat integration in the installation and at site level
- use of energy from exothermic reactions, which is economic only if the energy level is high enough and energy consumers are locally available.

Low level energy, which cannot be used, will be transferred into the environment by applying air cooling or water cooling systems. Refer also to Section 8.8.3.1 on Pinch Technology.

## 8.6 Start-up, shut-down and abnormal operating conditions

### 8.6.1 Start-up and shut-down

The start-up and shut-down of plants often leads to higher emission rates and higher consumption levels. This should be considered in the design of the plants and the environmental protection systems. Start-ups and shut-downs should be part of the staff training and should be described in Operation Procedures. To reduce the number of start-up and shut-down operations, the production planning should be optimised and the staff involved in the planning should be aware of their environmental impact.

### 8.6.2 Abnormal operating conditions

Abnormal operating conditions are conditions that are not planned to happen. Examples are:

- loss of energy supply
- activation of safety valves as a consequence of high pressure
- disturbances in production plants or environmental protection systems
- incorrect operation.

To maintain process safety under abnormal operating conditions, it is useful and necessary to have each unit of the process analysed. This analysis can be an investigation on physico-chemical conditions that could occur in the process without having countermeasures installed, e.g. high pressure caused by a running pump against a closed valve, high temperature by energy input into the medium by running a compressor against a closed valve for a certain time.

If the result of the investigation is that critical ranges can be reached in some units of the installation, safety procedures are to be provided in every detected case. These procedures can – depending on local conditions – consist of technical measures, e.g. safety valves, or management procedures, e.g. shut down procedures. These investigations and procedures are part of the safety report (according to the SEVESO II Directive) which has to be established for installations in which large amounts of dangerous substances are being handled.

The systems available to reduce the environmental impact of abnormal operating conditions include:

- as far as feasible, safety valves on hazardous fluids should be connected to adapted effluent treatments such as flares, knock out vessels, scrubbers
- waste water pipes should be connected to emergency basins to protect the waste water treatment plant from too high amounts of toxic substances
- production units holding dangerous substances should be equipped with containment systems.

The staff should be trained for these situations and should be aware of their environmental implications. Learning by experience is also a key element of process safety: any incident should be documented and analysed to avoid reoccurrence.

In the case of abnormal operating conditions, safety of the process should not be compromised to reduce the environmental impact. In the case of any doubt, accident prevention should have a higher priority compared to the control of emissions to the environment.

## 8.7 Improvement of environmental performance

The overall environmental performance of the processes should be monitored and the results should be considered on a regular basis. This can be done as part of a management system, refer to Sections 8.8 and 8.9 below.

The first step is a compilation of the relevant data, taking into account, for example:

- consumption of raw material and energy
- regeneration and dissipation of by-products and energy
- emissions to air and to water
- amount of waste.

To get this information, the processes have to be monitored and a sufficient amount of data have to be made available. Additionally, the production rates should be considered to derive specific consumption and emission factors. The second step should be an analysis of the data to find out the most important environmental effects, e.g. by performing a PARETO analysis (the Pareto Principle states that only a ‘vital few’ factors are responsible for producing most of the problems).

Therefore, the data for all the processes on site should be available in a computer database, preferably covering several years to show the most characteristic trends. As part of a management system, an environmental controlling system could be introduced covering the tasks of data gathering, analysis and co-ordination between several units.

On integrated sites, the optimisation will automatically focus on the total site and not on distinct processes. This enables co-ordination between several units, e.g. with regard to waste water reduction in a LVIC-S industrial complex.

Environment reporting systems (e.g. as defined in the Responsible Care Initiative) is also to be considered as a useful communication tool of the environmental management system.

## 8.8 Measures for reducing the environmental impact of the LVIC-S industry

Apart from the information on EMS included in Section 8.9 and the list of GEP for the LVIC-S industry included in Annex 3 (see Section 11.3), this section gives more specific information about techniques for reducing environmental impact of the chemical industry, which to a large extent are applicable to processes used in the LVIC-S industry across the EU-25 [6, CEFIC, 2002].

Streamlined with the BAT definition, the techniques described cover the whole range of planning, designing, building, operating, and decommissioning of plants, as well as techniques for start-up, shut-down procedures and incident prevention measures.

If alternative processes or product qualities are applicable, an investigation should be made to give information about the difference of environmental effects (product substitution). As a principle (refer to the provisions of Annex IV to the IPPC Directive), processes with lower risks to the environment and using less hazardous substances are preferred, provided that the cost benefit analysis leads to a favourable conclusion. Care must be taken, however, that the environmental benefits of the new process are not only based on the change of location of a highly polluting process step, as the favourable conclusions of the cost benefit analysis would not then be sustainable. Examples include [6, CEFIC, 2002]:

- some of the LVIC-S products are manufactured starting from ores, the purity of which may greatly differ depending on the nature of the ore, the location of the mine, the quality of the pretreatments carried out at the mine location, etc. Therefore, the performance of a given plant with regard to its consumption and release figures may look very poor compared to another unit, when for any reason the said plant includes a feedstock pretreatment, which is usually part of the mining activity. The performance of examined plants have thus to be compared on an integrated basis to include external releases
- some LVIC-S processes give rise to large quantities of solid residual materials. A typical case of this is residual calcium sulphate from the production of titanium dioxide. Though, in many cases, this can be re-used (e.g. for the manufacture of plasterboards) this is only possible in some locations, and in several others total or partial re-use of the by-product may be difficult for many reasons, such as: distance to re-use, quality, competition with existing sources, compatibility of volumes with market requirements, costs, etc. Also there is often an issue of security of the continuation of the main process: it may not make business sense to be entirely dependent on a volatile market of a low-cost co-product, unless a long term strategy towards re-using the by-product is not confirmed first in practice. Dumping into a river or a sea, or landfilling is often the only practical way to eliminate the residual material, and has to be taken into consideration
- similarly some LVIC-S processes release large quantities of salts dissolved in water. A typical case of this is residual calcium chloride solutions from the production of soda ash. Given the limited market, only part of the  $\text{CaCl}_2$  can be re-used in favourable conditions.

### 8.8.1 Management techniques to implement integrated environmental protection

Effective management is central to environmental performance and is an important component of the BAT. It requires an actual commitment to establishing objectives, setting targets, measurement and revision according to results. This systematic approach may be aided by the achievement of independently certified management standards such as ISO 14001 and EMAS.

The following sections provide information on the main types of management techniques, which can be applied at all management levels. The basis for decisions are concrete criteria of economic and environmental performance.

### 8.8.1.1 Senior management commitment

The commitment of companies, which signed up to the 'Responsible Care' initiative, provides a good framework for the implementation of management techniques. The key aspects of this initiative, which companies should be committed to through their senior management, and which they should be able to demonstrate they are applying, are:

- that all health, safety and environmental impacts of activities, products and processes have been identified and considered
- that there is a commitment to conform with statutory regulations as a minimum, and to work with authorities to develop and implement other measures where needed
- that employees and contractors are aware of the commitment made by the company and are involved in its delivery
- that there is an open dialogue both inside and outside the organisation.

A company might not be a formal signatory to the initiative, but could still be expected to be aspiring to its principles, particularly if the company regularly publishes its HSE reports.

### 8.8.1.2 Organisation and responsibility

There should be a clear structure for managing environmental issues in general and ensuring compliance with the IPPC authorisation in particular. This should be fully integrated with wider company and site decision-making systems addressed to the process operators. Many sites have a management committee, and it would be expected that the environmental issues are on its agenda and are discussed at regular intervals.

There should be a clear contact point at company level for IPPC authorisation. This should be seen as clarifying the interface between authorities and the process operator. However, it should not reduce the responsibilities of other members of the staff for ensuring compliance with the IPPC authorisation.

The environmental performance of the process is also dependent on the attention and awareness of the staff of a process operator. The staff should be aware of this and its role in keeping the high environmental performance of the company made clear. The company should reinforce the message that environmental protection is a key issue for the company. One way to do this is to have environmental performance as a part of the annual personal performance assessments.

Responsibility for the planning and execution of the maintenance of process equipment should be clear. Where applicable, the planning and scheduling of batches should be taken into account in order to minimise the generation of waste.

The overall environmental performance of the process should be monitored and the results should be considered on a regular basis and form part of the management assessment process. Environmental Performance Indicators (EPIs) could be used for this purpose. A commitment to continual environmental improvement as required by the management standards (ISO 14001, EMAS) is of obvious relevance here.

A contingency plan should be in place which identifies the potential types of incident that could occur and provides clear guidance on how they will be managed and who is responsible. In some circumstances, this information will need to be notified to the authorities as a condition of the process of authorisation and these must be clearly defined. Procedures should be in place to identify, respond to and learn from all complaints and incidents.

### **8.8.1.3 Maintenance**

Where appropriate, a programme of preventive maintenance, coupled with diagnostic testing if helpful, should be in place and recorded. All staff should be aware of the role they can play by maintaining vigilance, for example, in relation to process upsets and leaks, and appropriate procedures should be in place to encourage staff involvement. A procedure should be in place to authorise modifications and to undertake checks after modifications, before process start up.

### **8.8.1.4 Process control**

The operator should be able to demonstrate that the process is being adequately controlled, and in many cases, this will involve the use of a computer-based system with abilities to ensure control in emergency situations. As noted above, there should be production records and a procedure in place to ensure that they are subject to periodic review.

### **8.8.1.5 Waste minimisation**

Waste minimisation should be evaluated periodically according to a defined programme. The active participation of staff should be encouraged in these initiatives.

### **8.8.1.6 Design**

The environmental implications of a new process or product should be considered at the earliest stages of the project and should continue to be reviewed at regular intervals thereafter. This is the most cost-effective way of introducing improvements in overall environmental performance. When significant process decisions affecting the environmental performances of the unit are taken, there should be evidence that alternative process options were considered and assessed and it should be possible to maintain an audit trail of the design and decision making process.

### **8.8.1.7 Training**

All staff should be aware of the regulatory and statutory implications of the authorisation for the process and their work activities. Training should be given to all staff involved in process operation and this should include the environmental implications of their work and the procedures for dealing with incidents. There should be records of the training being delivered to staff.

### **8.8.1.8 Finance and accounting**

There should be a good understanding in each LVIC-S company of the costs associated with waste generation within the process. This can be achieved by having accounting practices in place which ensure that waste disposal and other significant environmental costs are attributed to the processes involved. The process operator should be able to demonstrate that adequate resources are being committed to keep the process operating in compliance with the environmental authorisation.

## 8.8.2 Careful use of resources

### 8.8.2.1 Raw materials

Expenditures of raw materials usually are the most costly share of producing large volume inorganic chemicals – solids and others.

The consequence of this is that yield maximisation by applying effective processes and well designed reactors are, in most cases, strategic targets. At the same time, emissions to air and water and the generation of avoidable wastes are minimised, because losses of material in consecutive or secondary reactions are suppressed. On the other hand yield improvement towards technically achievable limits may, in some cases, lead to higher specific energy consumption and emissions from energy generation, this translating to additional production costs.

Thus, besides the integrated view on the environmental and economic effects of a plant itself, other aspects have to be taken into consideration, such as:

- safety parameters may oblige the process to be operated in less efficient conditions
- co-products or secondary products which unavoidably arise in some processes can be:
  - recycled within the process
  - used as feedstock in other production units on site
  - sold after or without further treatment (variability of the market for co-products and the potential effect on the security of the main production process should be taken into account here).

Only the remaining residues have to be treated as effluent or disposed of as solid waste.

### 8.8.2.2 Handling valuable products on integrated sites or in a single installation

Particularly at larger, complex sites with interconnected plants and piping systems (integrated chemical complexes within the LVIC-S industry), it may be sensible to allow the formation of by-products if these can be used economically in other installations at the same site. Smaller sites with single installations should be optimised referring to closed recycling loops.

Because of the share of the raw material and product flow via piping systems between different installations at larger sites of integrated chemical complexes, risks of transportation, filling and unloading procedures are avoided, as are the emissions from these procedures.

### 8.8.2.3 Relation between costs and location

When designing new installations, the results of an evaluation on performance indicators (cost benefit analysis) are decisive for finding out the optimal operating conditions of the new plant. For that reason an investigation on available techniques and required expenditure has to be made. Additionally, running costs of feedstock, energy, products, residues, etc. are estimated as well as the development of the future market. The amount of feedstock and the treatment of residues have cost increasing influence. As a consequence of economic optimisation, the effective handling and processing of the feedstock lead to increased environmental performance.

Subsidies, taxes or other expense, e.g. transport charges influence the decision of selecting the plant location. Limitation of investment resources results from restrictions of available financial resources and from risk assessments (estimated development of the market, political and currency risks, etc.).



### 8.8.2.4 Process agents and auxiliary products

Process agents and auxiliary inputs are needed for certain process steps in the reaction or recovery units. Some of them are used in closed circulation loops (e.g. a heat transfer medium circuit). Others serve as: additives, stabilisers, binding agents for picking up liquid products after small leakages or maintenance works, etc.

Prior to their selection and use considered should be their chemical and physical properties, especially dangerous effects on man and the environment. Suitable process agents and auxiliary products with lower toxic or eco-toxic potential should be preferred after cost-benefit analysis considerations. Requirements of waste recovery or waste disposal should also be considered.

### 8.8.3 Energy and utilities

LVIC-S plants are often located at integrated sites. In most cases, on these industrial sites, power plants with a high overall efficiency of 70 to 90 % are available because of the power and heat integration in CHP systems [86, The Council of the EU, 2004]. Compared to this, the overall efficiency of conventional power stations (without CHP systems), which provide power for the public, reaches only 35 to 40 % [6, CEFIC, 2002].

Alongside the generation of heat and power at the production site by a power plant, energy can be recovered from certain plants producing LVIC-S and can be used in other plants on the site. To make it possible, it is necessary to provide networks of several piping systems for different energy streams. Examples are:

- steam piping for different pressure/temperature levels
- condensate piping for different pressure/temperature levels
- piping systems for warm water
- piping systems for waste gas with a calorific value.

A systematic data recording and interpretation of all energy flows – generation and consumption – need to be applied for decisive steering regarding the use of energy and the generation of energy in the power plants. A method for data assessment is, for example, ‘pinch method’ (see Section 8.8.3.1 below and refer to the CWW BREF).

If the energy management and distribution is successful, the maximum amount of generated energy can be used and minimum of energy has to be generated in the power plants. As a consequence, the emissions from the generation of energy in the power plants will be minimised. The initial precondition for applying the described energy-saving system, is the installation of expensive automatic control technology. Investigations on costs and environmental effects should be made.

As far as technically possible and economically sensible, energy generated in the process plants should be used by direct or indirect methods, e.g. direct steam input, heat transfer or expansion turbine for supplementation of an electric motor. The optimisation of energy consumption in the process units should be supported by automatic control technology and process computers and should be supervised by the operator staff.

Besides the energy networks, further piping systems are usually provided, which supply all the installations at the site with, e.g. compressed air; compressed nitrogen; and cooling water (see the BREF on the Industrial Cooling Systems). Producing and conveying these fluids also requires energy, and therefore optimising their production/distribution/recovery is economically and environmentally sensible. Considerations similar to energy optimisation are justified.

### 8.8.3.1 Pinch Technology

Pinch Technology is a widespread and well known tool used to optimise production processes, to save energy and water consumption, and to decrease the impact of waste discharges.

Pinch Technology is one of the available methodologies for optimising the usage of consumables in processes and on sites by introducing process integration techniques. It was primarily used as an energy saving tool to improve thermal efficiency in the chemical and processing industries.

Recently this method has been transferred to water and waste water minimisation. Its concept is to define and find water saving potentials, and to minimise waste water discharges by process modifications.

Regarding the LVIC-S industry, there are many constraints which can make the application of Pinch Technology difficult, e.g.

- the availability of computer based heat and mass balance of the plant is a prerequisite. Such simulation models are not always available. One of the reasons is the difficulty to simulate processes including ionic reactions and solids
- crossing streams containing solids is under many constraints.

A preliminary analysis of the usefulness and practicability of pinch technology should be made.

## 8.9 Environmental management tools

### Description

The best environmental performance is usually achieved by the installation of the best technology and its operation in the most effective and efficient manner. This is recognised by the IPPC Directive definition of ‘techniques’ as *‘both the technology used and the way in which the installation is designed, built, maintained, operated and decommissioned’*.

For IPPC installations an Environmental Management System (EMS) is a tool that operators can use to address these design, construction, maintenance, operation and decommissioning issues in a systematic, demonstrable way. An EMS includes the organisational structure, responsibilities, practices, procedures, processes and resources for developing, implementing, maintaining, reviewing and monitoring the environmental policy. Environmental Management Systems are most effective and efficient where they form an inherent part of the overall management and operation of an installation.

Within the European Union, many organisations have decided on a voluntary basis to implement environmental management systems based on EN ISO 14001:1996 or the EU Eco-management and audit scheme EMAS. EMAS includes the management system requirements of EN ISO 14001, but places additional emphasis on legal compliance, environmental performance and employee involvement; it also requires external verification of the management system and validation of a public environmental statement (in EN ISO 14001 self-declaration is an alternative to external verification). There are also many organisations that have decided to put in place non-standardised EMSs.

While both standardised systems (EN ISO 14001:1996 and EMAS) and non-standardised (‘customised’) systems in principle take the *organisation* as the entity, this document takes a more narrow approach, not including all activities of the organisation e.g. with regard to their products and services, due to the fact that the regulated entity under the IPPC Directive is the *installation* (as defined in Article 2).

An environmental management system (EMS) for an IPPC installation can contain the following components:

- (a) definition of an environmental policy
- (b) planning and establishing objectives and targets
- (c) implementation and operation of procedures
- (d) checking and corrective action
- (e) management review
- (f) preparation of a regular environmental statement
- (g) validation by certification body or external EMS verifier
- (h) design considerations for end-of-life plant decommissioning
- (i) development of cleaner technologies
- (j) benchmarking.

These features are explained in somewhat greater detail below. For detailed information on components (a) to (g), which are all included in EMAS, the reader is referred to the reference literature indicated below.

### (a) Definition of an environmental policy

Top management are responsible for defining an environmental policy for an installation and ensuring that it:

- is appropriate to the nature, scale and environmental impacts of the activities
- includes a commitment to pollution prevention and control
- includes a commitment to comply with all relevant applicable environmental legislation and regulations, and with other requirements to which the organisation subscribes
- provides the framework for setting and reviewing environmental objectives and targets
- is documented and communicated to all employees
- is available to the public and all interested parties.

### (b) Planning, i.e.:

- procedures to identify the environmental aspects of the installation, in order to determine those activities which have or can have significant impacts on the environment, and to keep this information up-to-date
- procedures to identify and have access to legal and other requirements to which the organisation subscribes and that are applicable to the environmental aspects of its activities
- establishing and reviewing documented environmental objectives and targets, taking into consideration the legal and other requirements and the views of interested parties
- establishing and regularly updating an environmental management programme, including designation of responsibility for achieving objectives and targets at each relevant function and level as well as the means and timeframe by which they are to be achieved.

### (c) Implementation and operation of procedures

It is important to have systems in place to ensure that procedures are known, understood and complied with, therefore effective environmental management includes:

- (i) Structure and responsibility
  - defining, documenting and communicating roles, responsibilities and authorities, which includes appointing one specific management representative
  - providing resources essential to the implementation and control of the environmental management system, including human resources and specialised skills, technology and financial resources.

- (ii) Training, awareness and competence
    - identifying training needs to ensure that all personnel whose work may significantly affect the environmental impacts of the activity have received appropriate training.
  - (iii) Communication
    - establishing and maintaining procedures for internal communication between the various levels and functions of the installation, as well as procedures that foster a dialogue with external interested parties and procedures for receiving, documenting and, where reasonable, responding to relevant communication from external interested parties.
  - (iv) Employee involvement
    - involving employees in the process aimed at achieving a high level of environmental performance by applying appropriate forms of participation such as the suggestion-book system or project-based group works or environmental committees.
  - (v) Documentation
    - establishing and maintaining up-to-date information, in paper or electronic form, to describe the core elements of the management system and their interaction and to provide direction to related documentation.
  - (vi) Efficient process control
    - adequate control of processes under all modes of operation, i.e. preparation, start-up, routine operation, shutdown and abnormal conditions
    - identifying the key performance indicators and methods for measuring and controlling these parameters (e.g. flow, pressure, temperature, composition and quantity)
    - documenting and analysing abnormal operating conditions to identify the root causes and then addressing these to ensure that events do not recur (this can be facilitated by a ‘no-blame’ culture where the identification of causes is more important than apportioning blame to individuals).
  - (vii) Maintenance programme
    - establishing a structured programme for maintenance based on technical descriptions of the equipment, norms etc. as well as any equipment failures and consequences
    - supporting the maintenance programme by appropriate record keeping systems and diagnostic testing
    - clearly allocating responsibility for the planning and execution of maintenance.
  - (viii) Emergency preparedness and response
    - establishing and maintaining procedures to identify the potential for and response to accidents and emergency situations, and for preventing and mitigating the environmental impacts that may be associated with them.
- (d) Checking and corrective action, i.e.:
- (i) Monitoring and measurement
    - establishing and maintaining documented procedures to monitor and measure, on a regular basis, the key characteristics of operations and activities that can have a significant impact on the environment, including the recording of information for tracking performance, relevant operational controls and conformance with the installation's environmental objectives and targets (*see also the Reference document on Monitoring of Emissions*)
    - establishing and maintaining a documented procedure for periodically evaluating compliance with relevant environmental legislation and regulations.

(ii) Corrective and preventive action

- establishing and maintaining procedures for defining responsibility and authority for handling and investigating non-conformance with permit conditions, other legal requirements as well as objectives and targets, taking action to mitigate any impacts caused and for initiating and completing corrective and preventive action that are appropriate to the magnitude of the problem and commensurate with the environmental impact encountered.

(iii) Records

- establishing and maintaining procedures for the identification, maintenance and disposition of legible, identifiable and traceable environmental records, including training records and the results of audits and reviews.

(iv) Audit

- establishing and maintaining (a) programme(s) and procedures for periodic environmental management system audits that include discussions with personnel, inspection of operating conditions and equipment and reviewing of records and documentation and that results in a written report, to be carried out impartially and objectively by employees (internal audits) or external parties (external audits), covering the audit scope, frequency and methodologies, as well as the responsibilities and requirements for conducting audits and reporting results, in order to determine whether or not the environmental management system conforms to planned arrangements and has been properly implemented and maintained
- completing the audit or audit cycle, as appropriate, at intervals of no longer than three years, depending on the nature, scale and complexity of the activities, the significance of associated environmental impacts, the importance and urgency of the problems detected by previous audits and the history of environmental problems – more complex activities with a more significant environmental impact are audited more frequently
- having appropriate mechanisms in place to ensure that the audit results are followed up.

(v) Periodic evaluation of legal compliance

- reviewing compliance with the applicable environmental legislation and the conditions of the environmental permit(s) held by the installation
- documentation of the evaluation.

(e) Management review, i.e.:

- reviewing, by top management, at intervals that it determines, the environmental management system, to ensure its continuing suitability, adequacy and effectiveness
- ensuring that the necessary information is collected to allow management to carry out this evaluation
- documentation of the review.

(f) Preparation of a regular environmental statement:

- preparing an environmental statement that pays particular attention to the results achieved by the installation against its environmental objectives and targets. It is regularly produced – from once a year to less frequently depending on the significance of emissions, waste generation etc. It considers the information needs of relevant interested parties and it is publicly available (e.g. in electronic publications, libraries etc.).

When producing a statement, the operator may use relevant existing environmental performance indicators, making sure that the indicators chosen:

- i. give an accurate appraisal of the installation's performance
- ii. are understandable and unambiguous
- iii. allow for year on year comparison to assess the development of the environmental performance of the installation
- iv. allow for comparison with sector, national or regional benchmarks as appropriate
- v. allow for comparison with regulatory requirements as appropriate.

(g) Validation by certification body or external EMS verifier:

- having the management system, audit procedure and environmental statement examined and validated by an accredited certification body or an external EMS verifier can, if carried out properly, enhance the credibility of the system.

(h) Design considerations for end-of-life plant decommissioning

- giving consideration to the environmental impact from the eventual decommissioning of the unit at the stage of designing a new plant, as forethought makes decommissioning easier, cleaner and cheaper
- decommissioning poses environmental risks for the contamination of land (and groundwater) and generates large quantities of solid waste. Preventive techniques are process-specific but general considerations may include:
  - i. avoiding underground structures
  - ii. incorporating features that facilitate dismantling
  - iii. choosing surface finishes that are easily decontaminated
  - iv. using an equipment configuration that minimises trapped chemicals and facilitates drain-down or washing
  - v. designing flexible, self-contained units that enable phased closure
  - vi. using biodegradable and recyclable materials where possible.

(i) Development of cleaner technologies:

- environmental protection should be an inherent feature of any process design activities carried out by the operator, since techniques incorporated at the earliest possible design stage are both more effective and cheaper. Giving consideration to the development of cleaner technologies can for instance occur through R&D activities or studies. As an alternative to internal activities, arrangements can be made to keep abreast with – and where appropriate – commission work by other operators or research institutes active in the relevant field.

(j) Benchmarking, i.e.:

- carrying out systematic and regular comparisons with sector, national or regional benchmarks, including for energy efficiency and energy conservation activities, choice of input materials, emissions to air and discharges to water (using for example the European Pollutant Emission Register, EPER), consumption of water and generation of waste.

#### **Standardised and non-standardised EMSs**

An EMS can take the form of a standardised or non-standardised ('customised') system. Implementation and adherence to an internationally accepted standardised system such as EN ISO 14001:1996 can give higher credibility to the EMS, especially when subject to a properly performed external verification. EMAS provides additional credibility due to the interaction with the public through the environmental statement and the mechanism to ensure compliance with the applicable environmental legislation. However, non-standardised systems can in principle be equally effective provided that they are properly designed and implemented.

### **Achieved environmental benefits**

Implementation of and adherence to an EMS focuses the attention of the operator on the environmental performance of the installation. In particular, the maintenance of and compliance with clear operating procedures for both normal and abnormal situations and the associated lines of responsibility should ensure that the installation's permit conditions and other environmental targets and objectives are met at all times.

Environmental management systems typically ensure the continuous improvement of the environmental performance of the installation. The poorer the starting point is, the more significant short-term improvements can be expected. If the installation already has a good overall environmental performance, the system helps the operator to maintain the high performance level.

### **Cross-media effects**

Environmental management techniques are designed to address the overall environmental impact, which is consistent with the integrated approach of the IPPC Directive.

### **Operational data**

No specific information reported.

### **Applicability**

The components described above can typically be applied to all IPPC installations. The scope (e.g. level of detail) and nature of the EMS (e.g. standardised or non-standardised) will generally be related to the nature, scale and complexity of the installation, and the range of environmental impacts it may have.

### **Economics**

It is difficult to accurately determine the costs and economic benefits of introducing and maintaining a good EMS. A number of studies are presented below.

However, these are just examples and their results are not entirely coherent. They might not be representative for all sectors across the EU and should thus be treated with caution.

A Swedish study carried out in 1999 surveyed all 360 ISO-certified and EMAS-registered companies in Sweden. With a response rate of 50 %, it concluded among other things that:

- the expenses for introducing and operating EMS are high but not unreasonably so, save in the case of very small companies. Expenses are expected to decrease in the future
- a higher degree of co-ordination and integration of EMS with other management systems is seen as a possible way to decrease costs
- half of all the environmental objectives and targets give payback within one year through cost savings and/or increased revenue
- the largest cost savings were made through decreased expenditure on energy, waste treatment and raw materials
- most of the companies think that their position on the market has been strengthened through the EMS. One-third of the companies report increasing revenue due to EMS.

In some Member States reduced supervision fees are charged if the installation has a certification.

A number of studies<sup>3</sup> show that there is an inverse relationship between company size and the cost of implementing an EMS. A similar inverse relationship exists for the payback period of invested capital. Both elements imply a less favourable cost-benefit relationship for implementing an EMS in SMEs compared to larger companies.

---

<sup>3</sup> E.g. Dyllick and Hamschmidt (2000, 73) quoted in Klemisch H. and R. Holger, *Umweltmanagementsysteme in kleinen und mittleren Unternehmen – Befunde bisheriger Umsetzung*, KNI Papers 01/02, January 2002, p 15; Clausen J., M. Keil and M. Jungwirth, *The State of EMAS in the EU. Eco-Management as a Tool for Sustainable Development – Literature Study*, Institute for Ecological Economy Research (Berlin) and Ecologic – Institute for International and European Environmental Policy (Berlin), 2002, p 15.

According to a Swiss study, the average cost for building and operating ISO 14001 can vary:

- for a company with between 1 and 49 employees: CHF 64000 (EUR 44000) for building the EMS and CHF 16000 (EUR 11000) per year for operating it
- for an industrial site with more than 250 employees: CHF 367000 (EUR 252000) for building the EMS and CHF 155000 (EUR 106000) per year for operating it.

These average figures do not necessarily represent the actual cost for a given industrial site because this cost is also highly dependent on the number of significant items (pollutants, energy consumption, ...) and on the complexity of the problems to be studied.

A recent German study (Schaltegger, Stefan and Wagner, Marcus, *Umweltmanagement in deutschen Unternehmen - der aktuelle Stand der Praxis*, February 2002, p. 106) shows the following costs for EMAS for different branches. It can be noted that these figures are much lower than those of the Swiss study quoted above. This is a confirmation of the difficulty to determine the costs of an EMS.

Costs for building (EUR):

minimum - 18750  
maximum - 75000  
average - 50000

Costs for validation (EUR):

minimum - 5000  
maximum - 12500  
average - 6000

A study by the German Institute of Entrepreneurs (Unternehmerinstitut/Arbeitsgemeinschaft Selbständiger Unternehmer UNI/ASU, 1997, *Umweltmanagementbefragung - Öko-Audit in der mittelständischen Praxis - Evaluierung und Ansätze für eine Effizienzsteigerung von Umweltmanagementsystemen in der Praxis*, Bonn.) gives information about the average savings achieved for EMAS per year and the average payback time. For example, for implementation costs of EUR 80000 they found average savings of EUR 50000 per year, corresponding to a payback time of about one and a half years.

External costs relating to verification of the system can be estimated from guidance issued by the International Accreditation Forum (<http://www.iaf.nu>).

### **Driving forces for implementation**

Environmental management systems can provide a number of advantages, for example:

- improved insight into the environmental aspects of the company
- improved basis for decision-making
- improved motivation of personnel
- additional opportunities for operational cost reduction and product quality improvement
- improved environmental performance
- improved company image
- reduced liability, insurance and non-compliance costs
- increased attractiveness for employees, customers and investors
- increased trust of regulators, which could lead to reduced regulatory oversight
- improved relationship with environmental groups.



### Example plants

The features described under (a) to (e) above are elements of EN ISO 14001:1996 and the European Community Eco-Management and Audit Scheme (EMAS), whereas the features (f) and (g) are specific to EMAS. These two standardised systems are applied in a number of IPPC installations. As an example, 357 organisations within the EU chemical and chemical products industry (NACE code 24) were EMAS registered in July 2002, most of which operate IPPC installations.

In the UK, the Environment Agency of England and Wales carried out a survey among IPC (the precursor to IPPC) regulated installations in 2001. It showed that 32 % of respondents were certified to ISO 14001 (corresponding to 21 % of all IPC installations) and 7 % were EMAS registered. All cement works in the UK (around 20) are certified to ISO 14001 and the majority are EMAS registered. In Ireland, where the establishment of an EMS (not necessarily of a standardised nature) is required in IPC licenses, an estimated 100 out of approximately 500 licensed installations have established an EMS according to ISO 14001, with the other 400 installations having opted for a non-standardised EMS.

### Reference literature

(Regulation (EC) No 761/2001 of the European parliament and of the council allowing voluntary participation by organisations in a Community eco-management and audit scheme (EMAS), OJ L 114, 24/4/2001, [http://europa.eu.int/comm/environment/emas/index\\_en.htm](http://europa.eu.int/comm/environment/emas/index_en.htm))  
(EN ISO 14001:1996, <http://www.iso.ch/iso/en/iso9000-14000/iso14000/iso14000index.html>;  
<http://www.tc207.org>)

## 8.10 Best Available Techniques for environmental management

**A number of environmental management techniques are determined as BAT.** The scope (e.g. level of detail) and nature of the EMS (e.g. standardised or non-standardised) will generally be related to the nature, scale and complexity of the installation, and the range of environmental impacts it may have.

BAT is to implement and adhere to an Environmental Management System (EMS) that incorporates, as appropriate to individual circumstances, the following features:

- definition of an environmental policy for the installation by top management (commitment of the top management is regarded as a precondition for a successful application of other features of the EMS)
- planning and establishing the necessary procedures
- implementation of the procedures, paying particular attention to
  - structure and responsibility
  - training, awareness and competence
  - communication
  - employee involvement
  - documentation
  - efficient process control
  - maintenance programme
  - emergency preparedness and response
  - safeguarding compliance with environmental legislation.
- checking performance and taking corrective action, paying particular attention to
  - monitoring and measurement (see also the Reference document on Monitoring of Emissions)
  - corrective and preventive action
  - maintenance of records
  - independent (where practicable) internal auditing in order to determine whether or not the environmental management system conforms to planned arrangements and has been properly implemented and maintained.
- review by top management.

Three further features, which can complement the above stepwise, are considered as supporting measures. However, their absence is generally not inconsistent with BAT. These three additional steps are:

- having the management system and audit procedure examined and validated by an accredited certification body or an external EMS verifier
- preparation and publication (and possibly external validation) of a regular environmental statement describing all the significant environmental aspects of the installation, allowing for year-by-year comparison against environmental objectives and targets as well as with sector benchmarks as appropriate
- implementation and adherence to an internationally accepted voluntary system such as EMAS and EN ISO 14001:1996. This voluntary step could give higher credibility to the EMS. In particular EMAS, which embodies all the above-mentioned features, gives higher credibility. However, non-standardised systems can in principle be equally effective provided that they are properly designed and implemented.

Specifically for the LVIC-S industry sector, it is also important to consider the following potential features of the EMS:

- the environmental impact from the eventual decommissioning of the unit at the stage of designing a new plant
- the development of cleaner technologies
- where practicable, the application of sectoral benchmarking on a regular basis, including energy efficiency and energy conservation activities, choice of input materials, emissions to air, discharges to water, consumption of water and generation of waste.

For information on good environmental practices (GEP) in the LVIC-S industry, to some extent related to this BAT, see Annex 3 (Section 11.3).



## 9 EMERGING TECHNIQUES IN THE LVIC-S INDUSTRY

### 9.1 Introduction

In the majority of cases, the LVIC-S industry is characterised by relatively mature processes and older installations with limited possibilities for changes in well known technologies, but still however with some degree of freedom for changes in unit operations applied and used for environmental protection. This is somewhat proven by the fact that in the process-related materials submitted for the writing of this document by the TWG is typically little information on Emerging Techniques in the LVIC-S industry.

Additional information on the different European research activities, which may be relevant to this document to a various degree, can be found in particular through website links to CORDIS Project Database <http://www.cordis.lu/fp5/projects.htm>, which illustrates EU level research activities and can be searched by each programme (e.g. 'Growth', 'Energy and Environment' programme, etc.).

Although it is impossible to quote all the EU research programmes and website links to potential developments pertaining to the LVIC-S industry in this document, the link quoted above is considered to be of value for the BREF user, as it provides additional access to information on the research activities carried out under EU research Framework Programme 5, technical progress made and potential new techniques emerging in the LVIC-S industry sector in the EU-25.

### 9.2 Soda ash

No emerging techniques in the soda ash production based on the Solvay process have been reported, however, given improvements introduced in the production of soda ash worldwide [76, Union of Inorganic Industry, 1977], [91, Takuji Miyata, 1983], two potentially emerging techniques for the EU-25 are outlined here.

Apart from limestone, sodium chloride brine is the main raw material for the production of soda ash, however the utilisation of raw salt, due to the chemical equilibrium of the reactions, is relatively low (Na utilisation rate ~ 70 per cent), and the water content from the salt brine is mostly disposed as a waste water from the distillation unit. Approximately 10 m<sup>3</sup> waste water per tonne of soda, containing several salts and suspended solids, is released from the distillation unit to the environment [33, CEFIC-ESAPA, 2004].

Several improvements in the Solvay process, focused on higher process efficiency and plant operability, have already been tested and successfully implemented on the industrial scale in the European soda ash industry [53, EIPPCB, 2004].

The two potential improvements in the Solvay soda ash process are discussed below, namely:

- the utilisation of excess CO<sub>2</sub> from the ammonia process for the production of soda ash
- innovations in the carbonation section in the soda ash plant.

#### 9.2.1 Integration of a soda ash plant with an ammonia plant

Approximately 1.25 tonnes of pure 99 % CO<sub>2</sub> per 1 tonne of ammonia produced is released to the atmosphere in those nitrogen fertiliser complexes, where the ammonia plant is not integrated with the downstream urea plant (this latter one consuming CO<sub>2</sub> otherwise released to the atmosphere). The utilisation of excess CO<sub>2</sub> from the ammonia process for the production of soda ash would be, therefore, a potentially available option, but only for these European locations in which both ammonia (without downstream urea) and soda ash are produced in close proximity, and where an additional cheap source of lime would be available, to make up the balance of lime necessary for distillation in a soda ash plant.

This innovation might have only a very limited impact on the soda ash production in the EU-25 area, if at all, through an improvement of the material and energy efficiency in the European soda ash industry and, at the same time, decreasing the emissions of carbon dioxide into the atmosphere.

Example plants: the soda ash plant in Haldia, India [76, Union of Inorganic Industry, 1977]. Refer also to Section 9.2.2 below.

### 9.2.2 Innovations in the carbonation section of the soda ash plant

The carbonation section, where CO<sub>2</sub> gas is absorbed in the ammoniated brine, yielding sodium bicarbonate is one of the core sections, directly influencing the overall performance of the soda ash process. This operation is carried out in carbonation columns (towers). The precipitation of sodium bicarbonate also generates scale on the cooling surfaces inside the column on the liquor side, substantially reducing the heat transfer. Consequently, a group of several carbonation towers is required for use in rotation to allow descaling – refer also to Section 2.4.1.

It is worth noting that the descaling of the cooling surfaces by ammoniacal brine is an integral part of the process, acting as a pre-carbonation step, before the process liquor enters the precipitation columns.

Asahi Glass reported in 1983 that a new type of carbonator, with a production capacity of 250 tonnes of soda ash per day per one carbonation tower, was operational in their soda ash plants in Kitakyushu and Chiba, Japan [91, Takuji Miyata, 1983].

Compared with the conventional Solvay carbonation tower, the following improvements are claimed to have been realised in the Japanese soda ash plants, in the so called ‘New Asahi mono-production process route’, in which soda ash is the only product:

- it is possible to operate the tower continuously for more than 8 months
- performance of the coolers has been stabilised and the operation of the tower is controlled by an automatic system
- the U (overall heat transfer coefficient) value of the coolers is claimed to be as high as five times that found with the Solvay tower. It is claimed that with other improvements, the heat transfer area of the coolers has been decreased to about one-tenth
- the tower structure has been simplified and carbon steel with resin lining is used – refer also to improvements introduced in the Torrelavega soda ash plant [53, EIPPCB, 2004]
- remarkable enlargements of the tower have been achieved and equipment cost is considerably reduced. Also, the possibility of increasing the capacity to 500 tonnes of soda ash per day per one carbonation tower has been claimed.

Implementation of this technique may have the following implications:

- due to the increase in the productivity of the carbonation section (better mass and heat transfer in both the CO<sub>2</sub> absorption and crude NaHCO<sub>3</sub> precipitation zones, higher CO<sub>2</sub> absorption rate, and an optimum temperature profile in the carbonation column), the performance of the whole soda ash plant would also increase, thus reducing the impact of the production of soda ash on the environment
- the characteristics of the crystals of precipitated crude sodium bicarbonate would be more predictable, with the size and shape of the crystals more uniform, this allowing for a possible application of the energy saving technique, namely this of the centrifugation of crude sodium bicarbonate – refer to Section 2.4.5
- the equipment layout in a soda ash plant would be simplified and, at the same time, the soda ash plant would be characterised by a higher operational flexibility, this again contributing to lessening the impact of the production of soda ash on the environment
- decreased manufacturing cost of soda ash.

In contrast to the currently used carbonation columns, requiring frequent rotation and cleaning, no side-effects, disadvantages or environmental problems are expected to be encountered with this emerging technique. It would be applicable for all European producers, provided that space is available for the new carbonation columns to be tied-in to the layout of the existing soda ash plants. The overall CO<sub>2</sub> balance would need to be re-adjusted, also taking into account the requirements for lime.

Example plants:

The soda ash plants at Chiba and Kitakyushu, Japan [91, Takuji Miyata, 1983], but the two plants were closed subsequently [85, EIPPCB, 2004-2005].

Reference literature:

[33, CEFIC-ESAPA, 2004], [41, Solvay S.A., 2003], [39, S. Leszczynski et al, 1978], [53, EIPPCB, 2004], [91, Takuji Miyata, 1983].

## 9.3 Titanium dioxide

Even though the LCA study has indicated that optimum future environmental cost benefits are likely to be achieved in the areas of: energy and water consumption, steady state plant operation, and co-product development, the current view held by the titanium dioxide industry in Europe is that in general terms there are no substantive novel pollution prevention and control techniques that are reported to be under development for either the chloride or the sulphate process [20, CEFIC-TDMA, 2004].

Apart from the chloride and sulphate processes described in Chapter 3, there is no other process used in the world for the manufacture of titanium dioxide on a large industrial scale [20, CEFIC-TDMA, 2004]. There is a US patent, which describes an alternative process tried on a pilot scale, which will be discussed below.

The main development, which was carried over the last 40 years of the mature TiO<sub>2</sub> industry, was on specific process equipment with the aim of improving onstream time, energy usage, material efficiency and to reduce environmental burden. Because of the highly competitive nature of the TiO<sub>2</sub> industry, very little know-how has been shared between producers. Also, because of the high capital costs and the risk of affecting the quality of the product, the lead-time between the pilot and the realisation of an industrial plant can be substantially long.

### 9.3.1 Chloride process

The basic process has not changed significantly over the last 20 years; the development has been focusing on optimising every stage of the process to improve the reliability of the equipment, as well as to optimise the energy usage and the throughput of a given plant. Pressure oxidation has eliminated the step of absorption-desorption of chlorine on tetrachloride prior to the recycling, this having a positive impact on reducing tetrachloride inventory and resulting in a drastic reduction of energy usage (20 %).

### 9.3.2 Sulphate process

The sulphate process is mainly a batch operation and alternative techniques and equipment have been tried over the years in order to simplify the process in order to eliminate manual tasks, increase plant throughput, and reduce both energy requirements and environmental impact.

### 9.3.2.1 Continuous digestion

The continuous digestion process works with ilmenite but there is a penalty in efficiency of 3 to 4 % due to a much lower residence time and a lower temperature of reaction. It is not applicable to ores with a high TiO<sub>2</sub> content (slag), which require higher temperatures and longer residence times to react.

### 9.3.2.2 Fluid bed calcination

This technique, developed for alumina, makes the process more energy efficient and can also significantly increase the throughput. Trials were carried on a pilot scale (5 kg/h) by Huntsman Tiioxide in the late 1980s with manufacturers. During the trials, it has never been possible to obtain the right crystal size distribution, which is a fundamental quality requirement.

### 9.3.2.3 Osmosis of strong and weak acid filtrates from pre-leach and post-leach

Among the difficulties of the sulphuric acid reconcentration process are the separation of the metal sulphates from the 70 % acid and the partial solubility of some metals, like magnesium and chromium, which can build up in the recycle loop. In the 1980s, the technique of osmosis was tried (Millenium Rhone Poulenc), with the aim of removing the metal salts prior to reconcentrating the acid. Problems were encountered with the fouling of the membranes with the fine TiO<sub>2</sub> particles present in the acid. The metal salts were still in a liquid solution which required further neutralisation. The strength of the purified acid was still too low for direct recycling in the TiO<sub>2</sub> process. This process did not offer any advantage over the processes currently used by the European TiO<sub>2</sub> industry and was not developed on an industrial scale.

### 9.3.2.4 Solvent extraction of sulphate metals from strong and weak acid filtrates

There are patents and developments carried out to extract metal salts with organic solvents and to regenerate both clean ferrous or ferric sulphate solutions and clean sulphuric acid. This generally leads to large solvent inventories, as the acid is too weak to be recycled to the TiO<sub>2</sub> process and an acid reconcentration stage is required. None of these techniques have been developed on an industrial scale.

### 9.3.2.5 Solvent extraction of TiOSO<sub>4</sub> and TiCl<sub>4</sub> from aqueous solution

Numerous patents have been elaborated on this subject. The principle is to remove the metal impurities prior to hydrolysis; the ore is reacted with sulphuric acid or hydrochloric acid. The first part of the process from digestion to crystallisation is similar to the sulphate process, then there are two or three stages of organic extraction to remove Fe<sup>2/3+</sup> and other metal ions. The extractant can be an organic phosphorus compound dissolved in aromatic hydrocarbons. The extraction of other metals can be carried out with amines. From hydrolysis to calcination, the sulphate process technology can be used. The extraction ratios are better using chloride ions. The concentration of liquors used in the process are similar to the ones used in the sulphate process, however, the regenerated acid still needs further reconcentration.

Because of the organic to aqueous ratios being around 4, there is little scope to reduce the size of the equipment and hence the capital costs of a new plant. The co-products: coppers and metal salts, are identical in quantity to those obtained in the sulphate process. The full development of this process to the size of a commodity TiO<sub>2</sub> plant (50 kt per year) will require some years of work and represents a major financial risk.

### 9.3.2.6 Hydrometallurgical process - hydrolysis of $\text{TiOSO}_4$ and $\text{TiCl}_4$ solutions

This process, which is covered in the literature by a patent, is conducted by total evaporation of the solution, the dry product is then sent to the calcination stage. The main claim is to produce a product with a better crystal size distribution. Since the metal impurities (Fe, Cr, V) have to be removed from the feed liquor prior to hydrolysis, then presumably this technology cannot be applied using liquors from the existing sulphate process. The alternative could be to combine it with the solvent extraction process described in Section 9.3.2.5 above. It is also possible to use pure tetrachloride from the chloride process, but it would imply a need to dilute the tetrachloride in water and then substitute the oxidation unit with the evaporation unit and a calciner. There are no clear economic or environmental advantages, to justify the inclusion of this technology in the group of Emerging Techniques applicable to the chloride and the sulphate processes for manufacturing commodity  $\text{TiO}_2$ . However, this technology might be used for manufacturing  $\text{TiO}_2$  grades for specific applications.

### 9.3.3 Finishing plants for the chloride and sulphate process

The  $\text{TiO}_2$  finishing technology is common to both processes. The main environmental impact is dust from dry milling and solids in the post coating filtrates. Depending on the type of grade manufactured, the energy usage for milling can be relatively high.

A large part of this energy is used at the last stage of the process, in fluid energy mill powered with medium pressure steam. The latent heat is not used, which results in a poor efficiency of the operation, although, improvement is made by recovering some of the heat for preheating liquors in the process [20, CEFIC-TDMA, 2004]. Equipment is available on the market using air instead of steam for milling the titanium dioxide pigment.

Air micronising: trials have been carried with different suppliers using cold and hot air. Due primarily to the lower gas velocities, all mills fail to achieve the level of  $\text{TiO}_2$  pigment quality required, even when a high air/pigment ratio is used.

### 9.3.4 New products and co-products

The development of products and co-products is an area which is very important in sustaining environmental improvement in the  $\text{TiO}_2$  manufacturing process, particularly when new products and co-products are designed to bring environmental benefits.

#### 9.3.4.1 The intermediate titanium oxyhydrate

The intermediate titanium oxyhydrate can be used in environmental applications, such as catalysts for the removal of  $\text{NO}_x$  from power plant off-gases and as a photocatalyst to split the persistent organic polychlorinated hydrocarbons into less poisonous compounds.

#### 9.3.4.2 Ferrous sulphate

Ferrous sulphate [59, CEFIC-TDMA, 2004] is used in increasingly often for the removal of phosphorus at municipal waste water treatment plants. New iron-based products have been launched to the market to widen the use of ferrous sulphate based products in the purification of drinking water. There is a new very fast growing ferrous sulphate application area in the cement industry, based on the recently adopted 26<sup>th</sup> amendment of Council Directive 76/769/EEC, concerning restrictions on the marketing and use of certain dangerous substances and preparations.



## 9.4 Carbon black

### 9.4.1 General outlook – emerging techniques/future developments

Today's carbon black industry depends heavily on the availability of petrochemical and carbochemical feedstocks with a high carbon to hydrogen ratio and a high aromatic content. This feedstock results in the highest yields and has a positive influence on product characteristics. Common feedstock types used are FCC (Fluid Catalytic Cracker) residues from refineries, naphtha cracker oil from steam crackers and coal tar distillates from coal tar processing plants. These feedstocks are the 'heavy-ends' from the above-mentioned processes and are associated with accumulated levels of sulphur and/or nitrogen, if compared with virgin carbo- or petrochemical feedstocks. By processing this feedstock, the carbon black industry inevitably emits significant quantities of SO<sub>x</sub> and NO<sub>x</sub> [47, InfoMil, 2002].

From a macro-economic point of view, it might be attractive to remove the impurities already upstream of the carbon black industry. The most interesting option is the hydrotreating of heavy oil fractions in the refinery. The current trend for low sulphur automotive fuels (auto oil programme) already leads itself to increased hydrotreating in the European refineries, including hydrotreating of FCC feedstock. Possibly, this trend will result in a lower sulphur and nitrogen content of the common petrochemical carbon black feedstock [47, InfoMil, 2002].

A disadvantage of hydrotreated fuels, from the point of view of the carbon black producers, is the decrease of the aromatic content with increasing hydrotreating severity. Furthermore, hydrotreating is a costly and energy intensive process due to the consumption of pure hydrogen. This will probably be reflected in feedstock prices. Nevertheless, due to the larger scale of refinery operation and the autonomous development in low sulphur fuels, it may in future be economically justified to purchase hydrotreated feedstock, when compared to the on-site end-of-pipe treatment of tail-gases.

The carbon black industry operates on a worldwide market for most carbon black grades. The European producers face competition from outside Europe not only for standard grades, but also more and more for the high quality grades. Companies deal with this growing competition with cost cutting programmes, relocating the businesses to low cost countries, reducing carbon black capacities in Europe and further by concentrating on the 'high quality' segment (e.g. pigments and other 'specialities').

The carbon black industry is also sensitive to the fluctuations in oil prices. Although the carbon black industry often has long term contracts with feedstock suppliers, these however, do not protect the carbon black industry from price fluctuations on the spot market, as, in most cases, the prices of feedstocks are based on so-called 'platts quotations', related to the prices of crude oil. The carbon black industry claims that high oil prices have a negative impact on their economics, and the ability to incorporate the increased fuel costs in the product price is limited.

An interesting speculation for the future may be that the carbon black industry embraces the plasma process as the main production technology [47, InfoMil, 2002]. However, until now the carbon black produced by this technique has a quality that is far from the required specifications used in the carbon black industry. According to the carbon black industry, the perspective of this technology for the carbon black industry is very low [47, InfoMil, 2002]. Additional information submitted by the carbon black industry indicates that this process is not a viable option for the production of carbon black [85, EIPPCB, 2004-2005].

Part of the market of virgin carbon black will probably be 'consumed' by two developments. The first and most likely one is the development of the 'green tyre', where a significant part of the carbon black in car tyres is substituted by precipitated silica.

The second one could be the substitution of virgin carbon black by 'recycled' carbon black from the waste tyre reclamation processes. With respect to the second development, the carbon black industry has strong doubts. Again, product quality is the main bottleneck. Waste tyre reclamation generates a quality that is far from the required specifications by the carbon black industry [47, InfoMil, 2002].

#### **9.4.2 Low NO<sub>x</sub> in dryers**

A carbon black plant in the Netherlands has also recently installed low NO<sub>x</sub> burners on two tail-gas fired furnaces of the pellet drying section. This is unique insofar as the only experience with Low NO<sub>x</sub> in the CB industry was with the boiler. As already mentioned in Section 4.4.1, low NO<sub>x</sub> technology in the carbon black industry needs adaptation to a typical composition and calorific value of the tail-gas. The company has only just started its operating experience with low NO<sub>x</sub> technology on dryer section burners. Therefore, no results are available at the moment. Specific fields of attention are the presence of NO<sub>x</sub> precursors in the tail-gas and the variation in tail-gas flow and calorific value [47, InfoMil, 2002].

### **9.5 Synthetic amorphous silica**

No emerging techniques reported.

### **9.6 Inorganic phosphates**

No emerging techniques reported.

### **9.7 Selected illustrative LVIC-S industry products**

No emerging techniques reported, apart from silicon carbide (Section 7.9).

#### **9.7.1 Silicon carbide**

##### **9.7.1.1 Emerging techniques**

A plasma reactor used for the production of silicon carbide has been patented by Saint-Gobain. However, the process has not been developed to a stage where it can be regarded as a technically and economically viable alternative for the production of silicon carbide [67, InfoMil - Dutch Authorities, 2004].

##### **9.7.1.2 Potential new developments in operation**

###### **9.7.1.2.1 Traditional furnace**

With respect to the traditional furnace set-up, the possibilities of applying process/flue-gas treatment should be investigated [67, InfoMil - Dutch Authorities, 2004].

###### **9.7.1.2.2 Freiland furnace**

In order to increase the removal efficiency of desulphurisation, the possibility of applying a second SO<sub>2</sub> removal step could be considered regarding the freiland furnace operation. Further investigation should be made to find possible de-NO<sub>x</sub> techniques to be applied in connection with the operation of the energy recovery plant [67, InfoMil - Dutch Authorities, 2004].



## 10 CONCLUDING REMARKS

### 10.1 Background information

The work for this document started in 2000 with preparatory work by industry and Member States and was officially launched in May 2003. The background paper (10 June 2003) for the kick-off meeting referred to Section 4.2 of Annex I to the IPPC Directive, 'Chemical installations for the production of basic inorganic chemicals', and to the decisions of the CITEPA Paris Workshop 1997, and focused on:

- criteria to be taken into account when selecting inorganic chemical products to be included in this document
- boundaries between the inorganic chemical industry BREFs on LVIC-S, CAK, LVIC-AAF and SIC
- an indicative long list of inorganic chemicals that would either fit into this document or into other BREFs.

Regarding the scope of this document, the initial TWG decisions are noted below:

- include in this document – at the so-called 'cornerstone' level – five products: soda ash, titanium dioxide, carbon black, synthetic amorphous silica, and inorganic phosphates
- include in this document (initially 33) products or groups of products at the 'selected illustrative' level, mainly based on the new data planned to be compiled in 2003 by the TWG in the form of so-called 'mini-BREFs' for each LVIC-S product or groups of products in question
- develop this document based also on the generic issues characteristic to the LVIC-S industry (such as energy efficiency of the plant, the wastes and degree of their utilisation, plant decommissioning and land decontamination).

The kick-off meeting report (MR), which has been available in the TWG Members Workspace since July 2003, reflects the initial TWG decisions on the organisation of work, and the scope and structure of this document (refer also to the Scope section, which gives the description of the final structure of this document on the LVIC-S industry).

### 10.2 Milestones

In total it took the TWG almost three years to exchange information to develop and prepare the final draft of this document. The time-schedule is noted below:

- |                              |            |
|------------------------------|------------|
| • kick-off meeting           | July 2003  |
| • first draft (D1)           | Aug. 2004  |
| • D1 comments                | Nov. 2004  |
| • two experts meetings       | Feb. 2005  |
| • second draft (D2)          | June 2005  |
| • D2 comments                | Sept. 2005 |
| • updated second draft (D2*) | Dec. 2005  |
| • final meeting              | Feb. 2006  |
| • final draft                | June 2006. |

#### The first draft of this document

The structure of the first draft was as guided by the TWG. Some 'selected illustrative' LVIC-S products were located outside of the 'cornerstone' chapters, although there was some relevance between these groups of products.

### **The second draft of this document**

The second draft contained BAT sections and, apart from some changes to the scope of Chapter 8 and Annexes, its content was, in principle, the same as that of the final draft of this document (refer to the Scope section). It also covered 17 ‘selected illustrative’ LVIC-S products, as listed in the Scope section.

### **Site visits and experts meetings**

The site visits to the titanium dioxide industry, carbon black industry and to the soda ash industry, as well as the Experts meetings on soda ash and titanium dioxide and the Task Force on silicon carbide, were of great importance for developing this document. In particular, several ‘Techniques to consider in the determination of BAT’ and the BAT proposals, have reference to the visited plants and are based on the notes prepared for the Experts meetings.

### **Information exchanged during the work on the first and second drafts of this document**

Many reports from MS and industry were used as sources of information in the drafting of this document. Information was also gathered during site visits made before the second draft was completed. Most of the TWG members from industry are part of the CEFIC delegation.

As it would be difficult to list here all the valuable sources of information on which this document was based (see the References section of this document), only a summary of the number of reports and files used in each step and the key sources of information which contributed to drawing BAT for the ‘cornerstone’ products, are mentioned below.

Summary of reports and files used:

TWG kick-off meeting	33 reports and files
Information gaps and BREF structure	2 reports
Mission reports	3 reports
LVIC-S submitted information	43 reports and files
First draft for consultation	50 reports and files
Second draft for consultation	34 reports and files
-----	
In total for the D2 BREF on LVIC-S	165 reports and files

Key sources of information which contributed to drawing BAT:

- Chapter 2 on soda ash – reports from the CEFIC-ESAPA group and information from the site visit in Torrelavega, Spain
- Chapter 3 on titanium dioxide – reports from the CEFIC-TDMA group and UBA-Germany. The mission reports from the visits to the two sites in the UK for the production of TiO<sub>2</sub> according to the chloride and the sulphate route were also important for the development of this chapter
- Chapter 4 on carbon black – reports from InfoMil and information from the visits to the two sites in Botlek and Rozenburg, the Netherlands
- Chapter 5 on synthetic amorphous silica – reports from the CEFIC-ASASP group
- Chapter 6 on inorganic phosphates – reports from the CEFIC-CEEP and CEFIC-IFP groups.

It should also be mentioned here that the low representation of the 10 new Member States in the TWG led to an imbalance of data and information included in this document in favour of the EU-15, and resulted in some gaps of information from the 10 new Member States of the EU-25.

### **The updated second draft of this document**

Following the second draft, an updated version of the document, based on the TWG comments and the EIPPCB assessment of all those comments, was prepared.

The updated second draft was written with the aim of advancing this document and facilitating the TWG decisions on BAT proposals at the final TWG meeting. Such an advanced approach in the exchange of information, proved to be very helpful in achieving the consensus on several BAT proposals within a very tight agenda for the final meeting.

### 10.3 The final meeting on the LVIC-S industry

The agenda for the final meeting was streamlined with the BREF structure, and reflected all the key issues to be covered at the meeting. The most important discussion points requiring TWG expert judgement, guidance and decisions were:

- the structure of this document (seven discussion items, including raw materials purity check, the location of BAT sections in Chapter 7, and techniques for reducing emissions to air)
- Chapter 2 on soda ash (16 discussion items, including material efficiency in the Solvay process, consumption of raw materials, carbon dioxide emissions, quantity of suspended solids and heavy metals in waste waters, waste water discharge, and dust emissions)
- Chapter 3 on titanium dioxide (15 discussion items for both the chloride and sulphate process, including feedstock selection, sulphur content in the coke, acid neutralisation, acid reconcentration, energy consumption, and emissions to air and water)
- Chapter 4 on carbon black (six discussion items, including sulphur content in the feedstock, carbon black content in the filtered tail-gas, flaring, and dust emissions)
- Chapter 5 on synthetic amorphous silica (four discussion items for pyrogenic silica, including chlorine and hydrogen chloride removal, and three discussion items for precipitated silica and silica gel, including drying silica and dust emissions)
- Chapter 6 on inorganic phosphates (seven discussion items for detergent, food and feed-grade phosphates based on various process routes, including the reduction of fluorine and dust emissions, consumption of raw materials and energy)
- Chapter 7 on 17 'selected illustrative' LVIC-S products (19 discussion items respectively for: copperas and related products, lead oxide, magnesium compounds, sodium silicate, silicon carbide, calcium chloride, precipitated calcium carbonate, sodium perborate, sodium percarbonate, sodium sulphite and related products, and zinc oxide)
- Chapter 8 – generic issues relevant to dust emissions (the treatment applied, based on the type of stream to be treated. The dust emission benchmark values and AELs to be defined for a product; processes and plants as functions of the identified constraints and cross-media effects)
- Chapter 8 with generic BAT proposals for the LVIC-S industry (one BAT proposal for environmental management, and six groups of BAT proposals for the use of technology, plant design, maintenance, operation, environmental protection, and plant decommissioning in the LVIC-S industry).

## 10.4 Degree of consensus reached at the final meeting

At the final meeting, out of the total number of 212 process-related BAT proposals, 209 were agreed and three, regarding soda ash, were rejected. No split views were recorded. It can, therefore, be concluded that a very high degree of consensus was achieved at the meeting in relation to the BAT proposals.

Regarding the three rejected BAT proposals on soda ash, the following information gives the rationale of the TWG:

- heavy metals content in the coke – given, on the one side, substantial quantities of heavy metals (HM) entering with the raw materials and leaving in the waste waters from the production of soda ash and, on the other side, restrictions in the availability of coke at the international markets (decline of the coke production in Europe and coke imports from other regions), the proposed BAT for the use of low HM coke would have an unsustainable impact on the increase of the manufacturing costs of soda ash. It was decided that this issue needs to be explored in more detail at both the sector and local levels
- high yield to reactive lime – as there are insufficient data regarding this parameter, the TWG concluded that this issue needs to be analysed in more detail within the soda ash industry
- NO<sub>x</sub> and SO<sub>2</sub> emission levels – although the TWG was aware that such emissions exist, they reported that these emissions are not deliberately measured, as they depend on the raw materials used and kiln parameters, and there are no data available to substantiate emission levels and no means of controlling them (i.e. available techniques demonstrated in the sector). Also, because of the autopurification reactions in the lime kilns, quantifying SO<sub>2</sub> emissions would be very difficult.

### Generic proposals for the LVIC-S industry

At the kick-off meeting the TWG decided that this document should be developed based on the LVIC-S ‘cornerstone’ and ‘selected illustrative’ tiers, while also taking into consideration the most important environmental issues at the generic LVIC-S industry level. In this sense, and based on TWG comments, generic BAT proposals for the LVIC-S industry were drafted at the post-consultation stage of the work on this document (updated second draft).

The generic proposal included a section on ‘Best Available Techniques for environmental management’ (one BAT proposal) and a section on ‘Best Available Techniques for the use of technology, plant design, maintenance, operation, environmental protection, and plant decommissioning in the LVIC-S industry’ (23 BAT proposals, in six groups).

The TWG agreed that only the section on ‘Best Available Techniques for environmental management’ should remain, while the other should be transferred to the annexes as ‘Good Environmental Practices (GEP) for the use of technology, plant design, maintenance, operation environmental protection, and plant decommissioning in the LVIC-S industry’ (see Annex 3).

The lack of a generic BAT Section at the LVIC-S industry level is an important gap that needs to be looked at in the future.

## 10.5 Recommendations for future work

Given the overall structure, integrity, cross-referencing and the large size of this document, covering many processes and process routes, it is feared that any substantial expansion of this document would only result in losing its user-friendliness. Therefore, it is recommended to consider if the nine inorganic chemical products, included in the ‘additional information’ document (as listed in the Scope section), could be covered in either a new ‘inorganic chemical industry BREF’ or in the BREF on Speciality Inorganic Chemicals (SIC).

This document is recommended to be updated in line with the planned review of all the chemical industry BREFs and, in particular, streamlined with the review of the other inorganic chemical industry BREFs: CAK, LVIC-AAF, and SIC.

## **Recommendations for further research and information gathering on LVIC-S**

### Chapter 1 – General information on the LVIC-S industry

- survey, at both the ‘cornerstone’ and ‘selected illustrative’ plant levels in the LVIC-S industry sector, the degree of application of ‘good environmental practices’ (GEP), included in Annex 3 of this document, in particular plant decommissioning in the LVIC-S industry sector, including land and groundwater decontamination.

### Chapter 2 – Soda ash

- reduce the impact of waste waters (discharged from the production of soda ash) on the environment, by identifying an optimum mix of upstream measures (limestone, coke, brine) and downstream techniques (deposition, underground disposal), available for reducing the emissions of suspended solids and heavy metals to the aquatic environment
- survey, search and pursue techniques and technologies for the extraction of heavy metals from the waste waters
- optimise the processes and plant operation to reduce the usage of limestone and coke, so as to minimise both the input of heavy metals into the plant and the excess emissions of CO<sub>2</sub> to air from the production of soda ash, towards the lower end of the BAT range of 200 – 400 kg CO<sub>2</sub>/t soda ash, in line with the EU programmes to mitigate the global climate change.

### Chapter 3 – Titanium dioxide

- identify, for both the chloride and sulphate processes, an optimum mix of feedstock to minimise the impact the titanium dioxide industry has on the environment as a whole
- identify in detail, and disseminate information at sector level, on the main measures and techniques available for reducing the emissions of heavy metals to water in both the chloride and sulphate process routes
- assess the conversion of the TiO<sub>2</sub> sulphate process into the chloride process, taking into account technical feasibility, economic viability, feedstock availability, environmental impact and energy savings.

### Chapter 4 – Carbon black

- pursue the most promising possibilities on the optimum measures applicable for reducing NO<sub>x</sub> and SO<sub>x</sub> emissions in the CB industry sector, taking into account both the available primary and end-of-pipe techniques and measures.

### Chapter 5 – Synthetic amorphous silica

- evaluate the advantages and disadvantages of applying one of the available primary, process-related chlorine reduction techniques, followed by final scrubbing of chlorine with caustic soda solution to minimise the emissions of Cl<sub>2</sub> from the process off-gas to air. Following this, disseminate the results and findings of such an analysis within the sector, with the recommendations of the most efficient process options and information on costs and constraints in their implementation at a plant level
- analyse the key process factors leading to optimised design and operation of liquid-solid separation techniques, followed by drying and dust collection systems, with the aim of achieving desired product properties, saving energy and reducing dust emissions.



### Chapter 6 – Inorganic phosphates

- analyse and disseminate within the sector, the findings on the main process options, techniques and systems available for the most efficient collecting of the dust from both the wet and dry airstreams encountered in the inorganic phosphates industry, with the aim of minimising the emissions of fine dust particles (as well as fluorine and acid mists) to air.

The EC is launching and supporting, through its RTD programmes, a series of projects dealing with clean technologies and management strategies. Potentially these projects could provide a useful contribution to future BREF reviews. Readers are therefore invited to inform the EIPPCB of any research results which are relevant to the scope of this document (see also the preface of this document).

---

**REFERENCES**

- 6 CEFIC (2002). "IPPC BAT Reference Document, Best Available Techniques for Producing Large Volume Solid Inorganic Chemicals - Generic Part".
- 8 CEFIC (2004). "CEFIC Chemistry Sectors".
- 9 CEFIC (2004). "The European chemical industry in a worldwide perspective - Facts and Figures 2004".
- 11 The Council of the EU (1996). "Council Directive 96/61/EC of 24 September 1996 concerning integrated pollution prevention and control".
- 12 European Environment Agency (2004). "The European Pollutant Emission Register EPER".
- 13 EIPPCB (2000). "Inorganic Chemical Sector", Version 1.
- 14 EIPPCB, S., Spain (2003). "Meeting Report of 23 September 2003 - Record of the Kick-off Meeting held in Sevilla on 7-8 July 2003, TWG on BAT for the manufacture of LVIC-S".
- 20 CEFIC-TDMA (2004). "Process BREF Titanium Dioxide Background Document".
- 21 The Council of the EU (1992). "Council Directive 92/112/EEC on procedures for harmonising the programmes for the reduction and eventual elimination of pollution caused by waste from the titanium dioxide industry".
- 22 Euratom (1996). "European Directive 96/29/EEC".
- 23 The Council of the EU (1996). "Council Directive 96/82/EC of 9 December 1996 on the control of major accident hazards involving dangerous substances".
- 24 Tioxide Group Ltd (1995). "Synopsis "Making Better Choices - How Tioxide uses Life Cycle Assessment"".
- 25 D.G. Heath (1996). "A Life Cycle inventory comparison of process and feed stock options for the production of TiO<sub>2</sub>" by D.G Heath and M.J. Richards".
- 26 EIPPCB (2003). "Mission Report - Visits of two sites in the UK for the production of TiO<sub>2</sub> according to chloride route - Greatham and sulphate route - Grimsby".
- 27 N.L. Glinka (1981). "Problems and Exercises in General Chemistry".
- 28 UNIDO (1982). "A Programme for the Industrial Development Decade for Africa".
- 31 R. N. Shreve (1945). "The Chemical Process Industries", Chemical Engineering Series.
- 33 CEFIC-ESAPA (2004). "IPPCB BAT Reference Document Large Volume Solid Inorganic Chemicals Family, Process BREF for Soda Ash", Issue No: 3.
- 39 S. Leszczynski et al (1978). "Soda i produkty towarzyszące".
- 40 CEFIC-ESAPA (2003). "IPPCB BAT Reference Document Large Volume Solid Inorganic Chemicals Family, Process BREF for Soda Ash", Issue No. 2.
- 41 Solvay S.A. (2003). "Process BREF for Soda Ash - Presentation".

## References

---

- 42 UBA-Germany (2001). "German Notes on BAT for the production of LVSIC - Titanium Dioxide".
- 43 UBA - Germany (2001). "German Notes on BAT for the production of LVSIC - Sodium Silicate".
- 44 UBA - Germany (2001). "German Notes on BAT for the production of LVSIC - Sodium Perborate".
- 45 UBA - Germany (2001). "German Notes on BAT for the production of LVSIC - Soda".
- 46 CEFIC-TDMA (2001). "Process BREF Titanium Dioxide Background Document".
- 47 InfoMil (2002). "Dutch Notes on BAT for the Carbon Black industry", ISBN 90-76323-07-0.
- 48 W. Buchner et al (1989). "Industrial Inorganic Chemistry", 3-527-26629-1.
- 49 CEFIC-ASASP (2002). "BREF Working Group - Synthetic Amorphous Silica".
- 53 EIPPCB (2004). "Mission Report - Visit of Soda Ash production plant site in Torrelavega, Santander, Cantabria, Spain".
- 54 EIPPCB (2004). "Mission Report - Carbon Black - Visits of two sites in Botlek and Rozenburg, Rotterdam area, the Netherlands".
- 56 InfoMil (2004). "Dutch Fact sheet on Magnesium compounds".
- 57 CEFIC-PEROXYGENES (2004). "Process BREF - Sodium Percarbonate".
- 58 CEFIC ZEAD-ZEODET (2004). "Mini-BREF Synthetic Zeolites for LVIC-S".
- 59 CEFIC-TDMA (2004). "Mini-Process BREF for Copperas and Related Products".
- 60 UBA-Austria (2004). "Mini BREF Calcium Carbide".
- 61 Entec UK Limited (2004). "Mini-BREF for Sodium Sulphite and related products".
- 62 CEFIC-ZOPA (2004). "Mini-BREF Zinc Oxide Production".
- 63 CEFIC-PEROXYGENES PERBORATE Sub Group (2004). "Process BREF Sodium Perborate".
- 65 CEFIC-IFP (2004). "BRF LVIC-S Inorganic Feed Phosphates".
- 66 CEFIC-Sodium Chlorate (2004). "Mini-process BREF for Sodium Chlorate".
- 67 InfoMil - Dutch Authorities (2004). "Factsheet on Production of Silicon Carbide".
- 68 Norwegian Pollution Control Authority (2003). "BAT for Al fluoride production".
- 69 Environment Agency (1999). "Processes Subject to Integrated Pollution Control - Inorganic Chemicals", S2 4.04.
- 70 Environment Agency (1999). "Processes Subject to Integrated Pollution Control - Inorganic Acids and Halogens", S2 4.03.

- 71 CITEPA (1997). "Best Available Techniques for the Chemical industry in Europe - Workshop on 14-16 May 1997 in Paris".
- 73 G.V. Ellis (1979). "Energy Conservation in a Large Chemical Company", Proceedings No. 183.
- 75 J. A. Lee (1985). "The Environment, Public Health and Human Ecology - a World Bank Publication", 0-8018-2911-9.
- 76 Union of Inorganic Industry (1977). "Soda Industry in Poland - Guidebook".
- 78 World Bank (1991). "Environmental Assessment Sourcebook - Volume III", World Bank Technical Paper Number 154.
- 79 BIPROKWAS (1985-1995). "Bid Letters for Inorganic Chemicals", 511.171-TR-XYZ.
- 82 UNIDO (1988). "Study on the Manufacture of Industrial Chemicals in the Member States of SADCC - Part II Inorganic Industry", DP/RAF/86/013.
- 84 A. Davister, G. M. (1981). "From Wet Crude Phosphoric Acid to High Purity Products", Proceedings No. 201.
- 85 EIPPCB, C., MS, (2004-2005). "Process BREFs, Mini-BREFs, Presentations, Papers, Notes and Documents, as well as Comments concerning the BREF on LVIC-S".
- 86 The Council of the EU (2004). "Council Directive 2004/8/EC of 11 February 2004 on the promotion of cogeneration based on a useful heat demand in the internal energy market".
- 87 Ullmann's (2001). "Ullmann's Encyclopedia of Industrial Chemistry".
- 88 UBA - Germany (2004). "Mini-BREF on the Production of Carbon Disulphide".
- 90 CEFIC-INCOPA (2004). "Mini-Process BREF Ferrous Chloride".
- 91 Takuji Miyata (1983). "Soda ash production in Japan and the new Asahi process", Chemistry and Industry, pp. 4.
- 92 EU DG Environment (2002). "Phosphates and Alternative Detergent Builders", WRc Ref: UC 4011.
- 93 CEFIC-CEEP (2004). "CEEP STPP BREF (BAT)".
- 94 CEFIC-SOLVAY S.A. (2004). "Process BREF for Precipitated Calcium Carbonate".
- 95 CEFIC-Brunner Mond (2004). "Process BREF for Calcium Chloride".
- 96 CEFIC-ELOA (2004). "BAT Notes for the Production of Lead Oxide".
- 97 The Council of the EU (2004). "Regulation (EC) No 648/2004 of the European Parliament and the Council of 31 March 2004 on detergents".
- 98 CEFIC (2003). "CEFIC Note No. 295 - Criteria for the selection between LVIC and SIC industries".
- 100 Environment Agency (2004). "Guidance for the Inorganic Chemicals sector IPPC S4.03", Draft 1.1.

## References

---

- 101 RIZA (2000). "Dutch notes on BAT for the phosphoric acid industry".
- 102 UNIDO (1980). "Fertilizer Manual", Development and Transfer of Technology Series No. 13.
- 103 CEFIC (2004). "Horizon 2015 - Is the European chemical industry losing its global leadership?".
- 104 CEFIC (2004). "Horizon 2015: Perspectives for the European Chemical Industry".
- 105 Mineral Information Institute (2004). "Soda Ash or Trona".
- 106 Sodawerk Stassfurt GmbH &Co. KG (2002). "Environmental Report (Umwelterklärung) 2002".
- 107 CEFIC-ESAPA (2005). "Heavy Metals in Raw Materials for Soda Ash Production, Report I".
- 108 CEFIC-ESAPA (2005). "BREF LVIC-S Soda Ash Heavy Metals Meeting, Report II".
- 109 SRI International (2002). "Chemical Economic Handbook".
- 110 Harriman Chemsult Limited (2004). "Bleaching Chemicals".
- 111 B.V. Tilak and C-P Chen (1999). "Electrolytic Sodium Chlorate Technology: Current Status", .
- 113 G. Buxbaum (1993). "Industrial Inorganic pigments".
- 114 CEFIC (2005). "CEFIC BREF Calcium Chloride".
- 115 CAA-Europe (2004). "Revised Section 7.19 on PCC".
- 116 M. Fawer (1996). "Life Cycle Inventories for the Production of Sodium Silicates".

## GLOSSARY OF TERMS AND ABBREVIATIONS

### Abbreviations commonly used in this document

AEL	Achieved Environmental Level
BAT	Best Available Techniques
BL	Battery Limits
BMCI	Bureau of Mines Correlation Index
BOD	Biochemical oxygen demand: the quantity of dissolved oxygen required by micro-organisms in order to decompose organic matter. The unit of measurement is mg O <sub>2</sub> /l. In Europe, BOD is usually measured after 3 (BOD <sub>3</sub> ), 5 (BOD <sub>5</sub> ) or 7 (BOD <sub>7</sub> ) days.
BREF	BAT reference document
CAS	Chemical Abstract Service
CB	Carbon Black
CFC	Chlorofluorocarbon
CHP	Cogeneration of Heat and Power
COD	Chemical oxygen demand: the amount of potassium dichromate, expressed as oxygen, required to chemically oxidise at c. 150 °C substances contained in waste water.
CTD	Coal Tar Distillates
DBM	Dead Burned Magnesia
DC	Direct Current
DCP	Dicalcium Phosphate
DSP	Disodium Phosphate
ECF	Elemental Chlorine Free (bleaching)
EIA	Environmental Impact Assessment
ELV	Emission limit values: the mass, expressed in terms of certain specific parameters, concentration and/or level of an emission, which may not be exceeded during one or more periods of time.
EMS	Environmental Management System
EOP	End-of-pipe
EPER	European Pollutant Emission Register
ESP	Electrostatic precipitator
EURO	European currency unit
EWC	European Waste Catalogue
FCCR	Fluid Catalytic Cracker Residue
FCCR	Fluid Catalytic Cracker Residues
FSA	Fluosilicic Acid
GCC	Ground Calcium Carbonate
GDP	Gross Domestic Product
GEP	Good Environmental Practices
GHG	Greenhouse gases
GRP	Glass Reinforced Plastic
HEPA	High-efficiency Particulate Arresters
HHV	High Heating Value
HM	Heavy Metals
HP	High Pressure
IPPC	Integrated Pollution Prevention and Control
LCA	Life Cycle Assessment
LHV	Low Heating Value
LP	Low Pressure
LPG	Liquefied Petroleum Gas
LRSR	Liquid Redox Sulphur Recovery
LVIC-S	Large Volume Inorganic Chemicals – Solids and Others
MAP	Monoammonium Phosphate

## Glossary

---

MCP	Monocalcium Phosphate
MDCP	Monodicalcium Phosphate
MGA	Merchant Grade Acid
MSP	Monosodium Phosphate
NA	New Asahi soda ash process
NeR	Netherlands emission Regulations
NPK	Compound fertiliser containing nitrogen, phosphate and potash
P	Pressure
PAHs	Polyaromatic hydrocarbons
PBS1	Sodium Perborate Monohydrate
PBS4	Sodium Perborate Tetrahydrate
PE	Polyethylene
PI	Process-integrated
PCC	Precipitated Calcium Carbonate
ROI	Return on Investment
R&D	Research and Development
RTD	Research and Technical Development
SCR	Selective Catalytic Reduction
SHG	Special High Grade
SNCR	Selective Non-Catalytic Reduction
SS	Suspended Solids (content) (in water)
STPP	Sodium Tripolyphosphate
T	Temperature
TOC	Total Organic Carbon
TOE	Tonne of Oil Equivalent
VOC	Volatile Organic Compounds
WR	Weight Ratio
WWTP	Waste Water Treatment Plant

<b>Abbreviations used for the organisations and countries quoted in this document</b>
---

ASASP	Association of Synthetic Amorphous Silica Producers
BSI	British Standard Institute
CCA-Europe	European Calcium Carbonate Producers Association
CEEP	Centre Européen d'Etudes des Polyphosphates
CEES	Centre Européen d'Etudes des Silicates
CEFIC	European Chemical Industry Council
CITEPA	Centre Interprofessionnel Technique D'Etudes de la Pollution Atmosphérique
EA	Environment Agency
EC	European Commission
EIPPCB	European Integrated Pollution Prevention and Control Bureau
EFMA	European Fertilisers Manufacturers Association
EFPA	European Food Phosphate Producers Association
ELOA	European Lead Oxide Association
ENTEC	Entec UK Limited
EPPAA	European Pure Phosphoric Acid Producers Association
ESAPA	European Soda Ash Producers Association
EU	European Union
EU-15	European Union (15 Member States)
EU-25	European Union (25 Member States, including 10 new Member States)
HT	Huntsman Tioxide
ICBA	International Carbon Black Association
INCOPA	Inorganic Coagulants Producers Association
IEF	Information Exchange Forum (informal consultation body in the framework of the IPPC Directive)

InfoMil	The Dutch Information Centre for Environmental Licensing
IFP	Inorganic Feed Phosphates
IPTS	Institute for Prospective Technological Studies
ISO	International Standards Organisation
NGOs	Non-Governmental Organisations
SFT	Norwegian Pollution Control Authority
SSPA	Sodium Sulphate Producers Association
TDMA	Titanium Dioxide Manufacturers Association
TWG	Technical Working Groups
UNIDO	United Nations Industrial Development Organization
US EPA	U.S. Environmental Protection Agency
UBA	Umweltbundesamt (Federal Environmental Agency - Germany)
UBA-Austria	Umweltbundesamt (Federal Environment Agency - Austria)
US	United States of America
VDI	Technical regulations set by the Association of German Engineers
VRM	Dutch Ministry of Housing, Spatial Planning and Environment
ZEAD	Zeolite Adsorbents
ZEODET	Association of Detergent Zeolite Producers
ZOPA	Zinc Oxide Producers Association

<b>Abbreviations of units of measure</b>
--

bar	bar (1 bar = 100 kPa, 1.013 bar = 1 atm)
bar abs	bars absolute – measuring the total pressure including the pressure of the atmosphere
bbbl	barrels of oil
°C	degree Celsius
g	gram
GJ	giga Joule
h	hour
J	Joule
K	Kelvin (0 °C = 273.15 K)
kA	kiloampere
kg	kilogram (1 kg = 1000 g)
kPa	kilo Pascal
kt	thousand tonnes
kWh	kilowatt-hour (1 kWh = 3600 kJ = 3.6 MJ)
l	litre
m	metre
m <sup>2</sup>	square metre
m <sup>3</sup>	cubic metre
mg	milligram (1 mg = 10 <sup>-3</sup> gram)
Nm <sup>3</sup>	Normalised m <sup>3</sup> (gas, 273 K, 101.3 kPa)
pH	scale for measuring acidity or alkalinity
ppb	parts per billion
ppm	parts per million
ppmv	parts per million (by weight)
rpm	revolutions per minute
s	second
t	metric tonne (1000 kg or 10 <sup>6</sup> gram)
% w/w	percentage by weight (also wt-%)
vol-%	percentage by volume (also %v/v)
W	Watt (1 W = 1 J/s)



<b>Prefixes</b>
-----------------

n	nano $10^{-9}$
$\mu$	micro $10^{-6}$
m	milli $10^{-3}$
c	centi $10^{-2}$
k	kilo $10^3$
M	mega $10^6$
G	giga $10^9$

<b>Chemical formulae commonly used in this document</b>
---

(refer also to Annex 1 – Basic classes of inorganic compounds)

Al	Aluminium
$\text{AlCl}_3$	Aluminium chloride
$\text{AlF}_3$	Aluminium fluoride
$\text{AlNaO}_2$	Sodium aluminate
$\text{Al}_2\text{O}_3$	Aluminium oxide
$\text{Al}(\text{OH})_3$	Aluminium hydroxide
$\text{Al}_2(\text{SO}_4)_3$	Aluminium sulphate
$\text{Al}_x(\text{OH})_y\text{Cl}_z$	Aluminium hydroxy chloride
$\text{Al}_x(\text{OH})_y\text{Cl}_z(\text{SO}_4)_q$	Aluminium hydroxy chloride sulphate
As	Arsenic
Ba	Barium
$\text{BaCl}_2$	Barium chloride
B	Boron
C	Carbon
Ca	Calcium
$\text{Ca}^{2+}$	Calcium ion
$\text{CaC}_2$	Calcium carbide
$\text{CaCl}_2$	Calcium chloride
$\text{CaF}_2$	Calcium fluoride (flourspar)
$\text{CaCO}_3$	Calcium carbonate (limestone)
$\text{CaCO}_3 \cdot \text{MgCO}_3$	Dolomite
CaO	Calcium oxide
$\text{Ca}(\text{OH})_2$	Calcium hydroxide
$\text{CaHPO}_4$	Dicalcium phosphate
$\text{Ca}_3(\text{PO}_4)_2$	Calcium phosphate
$\text{CaSO}_3$	Calcium sulphite
$\text{CaSO}_4$	Calcium sulphate
Cd	Cadmium
$\text{CH}_4$	Methane
$\text{C}_x\text{H}_y$	Hydrocarbons
$\text{C}_2\text{H}_6$	Ethane
$\text{C}_2\text{H}_4$	Ethene
$\text{C}_2\text{H}_2$	Acetylene
$\text{Cl}^-$	Chloride
$\text{Cl}_2$	Chlorine
$\text{ClO}^-$	Hypochlorite
$\text{ClO}_3^-$	Chlorate
$\text{CN}^-$	Cyanide
Co	Cobalt
CO	Carbon monoxide
$\text{CO}_2$	Carbon dioxide
$\text{CO}_3^{2-}$	Carbonate
COS	Carbonyl sulphide

Cr	Chromium
Cr <sup>3+</sup> /Cr <sup>6+</sup>	Chromic ions
CrO	Chromium oxide
CS <sub>2</sub>	Carbon disulphide
Cu	Copper
CuO	Copper oxide
CuSO <sub>4</sub>	Copper sulphate
F	Fluorine
F <sup>-</sup>	Fluoride
Fe	Iron
Fe <sup>2+</sup>	Ferrous ion
Fe <sup>3+</sup>	Ferric ion
FeCl <sub>2</sub>	Ferrous chloride
FeCl <sub>3</sub>	Ferric chloride
FeClSO <sub>4</sub>	Iron chloro sulphate
FeO	Iron (II) oxide
Fe <sub>2</sub> O <sub>3</sub>	Iron (III) oxide
FeO·TiO <sub>2</sub>	Ilmenite
FeSO <sub>4</sub>	Ferrous sulphate
FeSO <sub>4</sub> ·H <sub>2</sub> O	Ferrous sulphate monohydrate
FeSO <sub>4</sub> ·7H <sub>2</sub> O	Ferrous sulphate heptahydrate (copperas)
Fe <sub>2</sub> (SO <sub>4</sub> ) <sub>3</sub>	Ferric sulphate
H <sub>2</sub>	Hydrogen
HCl	Hydrogen chloride
HClO	Hypochlorous acid
HCN	Hydrogen cyanide
HCOOH	Formic acid
HCO <sub>3</sub> <sup>-</sup>	Bicarbonate
Hg	Mercury
HF	Hydrogen fluoride
H <sub>2</sub> O	Water
H <sub>2</sub> O <sub>2</sub>	Hydrogen peroxide
HNO <sub>2</sub>	Nitrous acid
HNO <sub>3</sub>	Nitric acid
H <sub>3</sub> PO <sub>4</sub>	Phosphoric acid
H <sub>2</sub> S	Hydrogen sulphide
H <sub>2</sub> SO <sub>4</sub>	Sulphuric acid
H <sub>2</sub> SiF <sub>6</sub>	Fluosilicic acid
K	Potassium
KCl	Potassium chloride
KClO <sub>3</sub>	Potassium chlorate
K <sub>2</sub> CO <sub>3</sub>	Potassium carbonate
KOH	Potassium hydroxide
Mg	Magnesium
Mg <sup>2+</sup>	Magnesium ion
MgCl <sub>2</sub>	Magnesium chloride
MgCO <sub>3</sub>	Magnesium carbonate
MgO	Magnesium oxide
Mg(OH) <sub>2</sub>	Magnesium hydroxide
MgSO <sub>4</sub>	Magnesium sulphate
Mn	Manganese
Na	Sodium
Na <sup>+</sup>	Sodium ion
NaBO <sub>3</sub> ·H <sub>2</sub> O	Sodium perborate monohydrate
Na <sub>2</sub> B <sub>4</sub> O <sub>7</sub> ·5H <sub>2</sub> O	Borax
NaCl	Sodium chloride
NaClO	Sodium hypochlorite

$\text{NaClO}_3$	Sodium chlorate
$\text{Na}_2\text{CO}_3$	Sodium carbonate
$\text{Na}_2\text{CO}_3 \cdot 1.5\text{H}_2\text{O}$	Sodium percarbonate
$\text{Na}_2\text{Cr}_2\text{O}_7$	Sodium dichromate
$\text{NaHCO}_3$	Sodium bicarbonate
$\text{NaH}_2\text{PO}_4$	Monosodium phosphate
$\text{Na}_2\text{HPO}_4$	Disodium phosphate
$\text{NaNO}_2$	Sodium nitrite
$\text{NaNO}_3$	Sodium nitrate
$\text{Na}_2\text{O}$	Sodium oxide
$\text{NaOH}$	Sodium hydroxide
$\text{NaHSO}_3$	Sodium hydrogensulphite (sodium bisulphite)
$\text{Na}_2\text{SO}_3$	Sodium sulphite
$\text{NaHSO}_4$	Sodium hydrogensulphate (sodium bisulphate)
$\text{Na}_2\text{SO}_4$	Sodium sulphate
$\text{Na}_2\text{SO}_4 \cdot 10\text{H}_2\text{O}$	Sodium sulphate decahydrate (Glauber's salt)
$\text{Na}_2\text{S}_2\text{O}_3$	Sodium thiosulphate
$\text{Na}_2\text{S}_2\text{O}_5$	Sodium metabisulphite
$\text{Na}_5\text{P}_3\text{O}_{10}$	Sodium tripolyphosphate
$\text{Na}_2\text{S}$	Sodium sulphide
$\text{Na}_x(\text{AlO}_2)_y(\text{SiO}_2)_z$	Zeolite
$\text{N}_2$	Nitrogen
$\text{NH}_3$	Ammonia
$\text{NH}_4^+$	Ammonium ion
$\text{NH}_4\text{OH}$	Ammonium hydroxide
$\text{NH}_4\text{Cl}$	Ammonium chloride
$\text{NH}_4\text{HCO}_3$	Ammonium bicarbonate
$(\text{NH}_4)_2\text{CO}_3$	Ammonium carbonate
$\text{NH}_4\text{HSO}_4$	Ammonium bisulphate
$(\text{NH}_4)_2\text{SO}_4$	Ammonium sulphate
$\text{Ni}$	Nickel
$\text{NO}$	Nitrogen monoxide
$\text{NO}_2$	Nitrogen dioxide
$\text{NO}_3^-$	Nitrate
$\text{NO}_x$	Nitrogen oxides
$\text{O}_2$	Oxygen
$\text{OCl}^-$	Hypochlorite
$\text{OH}^-$	Hydroxide
$\text{P}$	Phosphorus
$\text{P}_2\text{O}_5$	Phosphorus pentoxide
$\text{Pb}$	Lead
$\text{PbO}$	Lead oxide (litharge)
$\text{Pb}_3\text{O}_4$	Lead oxide (red lead)
$\text{R-NH}_2$	Amine
$\text{S}$	Sulphur
$\text{S}^{2-}$	Sulphide
$\text{SO}_2$	Sulphur dioxide
$\text{SO}_3$	Sulphur trioxide
$\text{S}_2\text{O}_3^{2-}$	Thiosulphate
$\text{SO}_3^{2-}$	Sulphite
$\text{SO}_4^{2-}$	Sulphate
$\text{SO}_x$	Sulphur oxides
$\text{Si}$	Silicon
$\text{SiC}$	Silicon carbide
$\text{SiO}_2$	Silica
$n(\text{SiO}_2)_m\text{Na}_2\text{O}$	Sodium silicate
$\text{Ti}$	Titanium

---

TiO <sub>2</sub>	Titanium dioxide
TiO(OH) <sub>2</sub>	Titanyl hydroxide
TiOSO <sub>4</sub>	Titanyl sulphate
TiCl <sub>4</sub>	Titanium tetrachloride
V	Vanadium
VOCl	Vanadium oxychloride
W	Tungsten
Zn	Zinc
ZnCl <sub>2</sub>	Zinc chloride
ZnCO <sub>3</sub>	Zinc carbonate
ZnO	Zinc oxide
ZnS	Zinc sulphide
ZnSO <sub>4</sub>	Zinc sulphate



## 11 ANNEXES

### 11.1 Annex 1 – Basic classes of inorganic compounds

Inorganic compounds can be classified with respect to either their composition or properties (the functional features) [27, N.L. Glinka, 1981]. With respect to composition, they are subdivided into binary compounds and compounds containing three and more elements. Binary compounds include compounds with oxygen (oxides), halogens (e.g. chlorides), sulphur (sulphides), and carbon (carbides). Inorganic compounds are subdivided into classes depending on the characteristic functions they perform in chemical reactions. For instance, oxides are grouped into non-salt-forming and salt-forming. The latter, in turn, are divided into basic, acidic, and amphoteric oxides. The name basic is applied to oxides that form salts when they react with acids or acid oxide. Bases correspond to basic oxide: e.g.  $\text{Ca}(\text{OH})_2$  corresponds to calcium oxide  $\text{CaO}$ . The name acidic (acid) is applied to oxides that form salts when they react with bases or basic oxides. By attaching water directly or indirectly, acidic oxides form acids. For instance, silicon dioxide  $\text{SiO}_2$  forms silicic acid  $\text{H}_2\text{SiO}_3$ . Acids include substances capable of dissociating in a solution with the formation of hydrogen ions. Acids can be donors of protons, i.e. that can give up a hydrogen ion. Salts can be considered as the products of the complete or partial replacement of the hydrogen atoms in an acid molecule by metal atoms or as the products of the complete or partial replacement of the hydroxyl groups in a basic hydroxide molecule by acid residues. Upon complete replacement of the hydrogen atoms in an acid molecule, neutral (normal) salts are obtained, and upon incomplete replacement, acid salts. The names of the most important acids and their salts applicable to this document, are given below [27, N.L. Glinka, 1981]:

Acid	Acid name	Name of salt
$\text{HAlO}_2$	Meta-aluminic	Meta-aluminate
$\text{HBO}_2$	Metaboric	Metaborate
$\text{H}_3\text{BO}_3$	Orthoboric	Orthoborate
$\text{H}_2\text{B}_4\text{O}_7$	Tetraboric	Tetraborate
$\text{H}_2\text{CO}_3$	Carbonic	Carbonate
$\text{HCl}$	Hydrogen chloride (hydrochloric)	Chloride
$\text{HClO}$	Hypochlorous	Hypochlorite
$\text{HClO}_2$	Chlorous	Chlorite
$\text{HClO}_3$	Chloric	Chlorate
$\text{HClO}_4$	Perchloric	Perchlorate
$\text{HCN}$	Hydrogen cyanide (hydrocyanic)	Cyanide
$\text{HCrO}_2$	Metachromous	Metachromite
$\text{H}_2\text{CrO}_4$	Chromic	Chromate
$\text{H}_2\text{Cr}_2\text{O}_7$	Dichromic	Dichromate
$\text{HF}$	Hydrogen fluoride (hydrofluoric)	Fluoride
$\text{HNO}_2$	Nitrous	Nitrite
$\text{HNO}_3$	Nitric	Nitrate
$\text{HPO}_3$	Metaphosphoric	Metaphosphate
$\text{H}_3\text{PO}_4$	Orthophosphoric	Orthophosphate
$\text{H}_4\text{P}_2\text{O}_7$	Diphosphoric (pyrophosphoric)	Diphosphate (pyrophosphate)
$\text{H}_3\text{PO}_3$	Phosphorus	Phosphite
$\text{H}_3\text{PO}_2$	Hypophosphorus	Hypophosphite
$\text{H}_2\text{S}$	Hydrogen sulphide	Sulphide
$\text{H}_2\text{SO}_3$	Sulphurous	Sulphite
$\text{H}_2\text{SO}_4$	Sulphuric	Sulphate
$\text{H}_2\text{S}_2\text{O}_3$	Thiosulphuric	Thiosulphate
$\text{H}_2\text{S}_2\text{O}_7$	Disulphuric (pyrosulphuric)	Disulphate (pyrosulphate)
$\text{H}_2\text{S}_2\text{O}_8$	Persulphuric	Persulphate
$\text{H}_2\text{SiO}_3$	Silicic	Silicate

## 11.2 Annex 2 – Selected unit operations in the LVIC-S industry

The production of LVIC-S utilises a number of unit operations that are characterised by common techniques and based on the same scientific principles. These are described in Section 1.4.1 of this document. In order to illustrate them a little bit more, the following four unit operations: size reduction, sedimentation, filtration, and drying, commonly applied in and characteristic of the LVIC-S industry, have been selected for more detailed description [13, EIPPCB, 2000].

### 11.2.1 Size reduction

Most reactions, whether chemical or physical, occur on surfaces and rates are nearly always expressed in relation to surface areas. Thus, when solids are processed, the first step is usually to disintegrate, crush or grind them to a powder so that the surface area per unit volume is very much increased. This then accelerates the rate at which the desired reaction will take place, be it a chemical reaction such as oxidation or a physical operation such as dissolution. To make a powder from a solid by mechanical means requires rather large amounts of energy and this energy is proportional to the amount of new surface that is produced.

Crushing is generally used to signify the reduction of material from very large pieces, such as those originating from large scale mining or quarrying operations, to fairly coarse material perhaps 5 to 10 cm in size (e.g. lumps of limestone used in the soda ash process). Grinding generally implies taking a feed of an already crushed material and producing a powder, which may vary from particles as small as a few microns to ones as large as 50 mm. The machines for crushing tend to be very large pieces of heavy engineering equipment, whilst those used for fine grinding often are pieces of precision engineering equipment. Dry powders are characterised by their particle size, or more properly by the particle size distribution since no powder is made up of particles of one uniform size. Size reduction is applied for instance in the soda ash industry (limestone crushing), the titanium dioxide industry (ilmenite grinding, titanium dioxide pigment micronising), as well as in crushing sodium tripolyphosphate and sodium silicate products.

### 11.2.2 Sedimentation

Many inorganic chemical products are obtained as precipitates, and these have to be settled-out before further treatment. It would be uneconomic to try to filter the whole reaction mass because of the very large volume of liquid that would have to pass through the filter, and so the mixture is concentrated with respect to its solid content. This is done by allowing the solid particles to fall to the bottom of a holding tank by gravity. The operation is known as sedimentation. The size of the tank is determined by the size and concentration of the solid particles in suspension, which in turn fix the length of time required for them to settle in a given depth. The particles, which settle to the bottom, form a sludge or slurry containing perhaps 20 to 50 % of solids. This is easily pumped out of the bottom of the tank and goes to a filter system as concentrated slurry. Sedimentation is applied, for instance, in the manufacturing of calcium chloride, precipitated calcium carbonate, sodium bicarbonate, and sodium perborate.

### 11.2.3 Filtration

In filtration the wet material, usually containing more than 50 % water is fed to a membrane in which the holes or pores are small enough for the water to pass through but too small for the solid particles to pass.

Filters vary enormously in type, and range from simple mesh belts moving in a continuous ribbon over rollers onto which the slurry is fed at one end and the drained material is scraped off the top of the belt at the other, two highly sophisticated automated machines operating at fairly high pressures and sequencing a series of complex operations to simulate continuous production (e.g. sophisticated filters in TiO<sub>2</sub> production).

Once a layer of material starts to build up at the core, any liquid that is being removed has to pass through this layer. To do this, a driving force must be applied. The driving force can simply be gravity but in general, a pressure has to be applied by a pump. Usually this pressure is applied through the slurry, but an important class of filters uses vacuum on the clear liquor side (e.g. sodium bicarbonate filters in the soda ash process).

The main factors are the viscosity of the fluid, the depth of filter cake, and its porosity. It is ideal to keep the depth or thickness small, the porosity high and the viscosity low. In practice there is a need to compromise between a small depth, which means frequent breaks in operation to remove the cake and a greater depth with greater resistance and hence a longer filtration time. The porosity is largely a function of the particle sizes of the solid. A solid with many small particles is going to have a much poorer porosity than a coarse granular material. The conditions of precipitation ought to be controlled carefully to try to obtain the best particle size for filtration. Finally, the viscosity is a factor that can be reduced by taking advantage of the fact that liquid viscosities are greatly reduced as the temperature is increased.

Filtration is applied across the LVIC-S industry, for instance in the manufacturing of aluminium sulphate, soda ash, zinc sulphate, zinc chloride, and silica gel.

#### 11.2.4 Drying

This is an important operation; especially in the inorganic chemical industry where many of the products are solids, which have to be dried before they can be stored, packed, or distributed.

Drying is generally understood to mean the removal of unwanted water from a solid. Many LVIC-S processes involve precipitation and subsequent filtration of a solid product. This will leave it with a water content of perhaps 10 to 30 % most of which will be necessary to remove. This is accomplished by heating the wet material in a relatively dry gas stream (usually air).

Drying is usually thought of as a two-stage process. In the first, the solid is assumed to be thoroughly wet on the surface and the drying is simply evaporation of water into a stream of gas. As the drying proceeds, the surface of the solid develops dry areas since the water held in the interstices of the solid cannot diffuse to the surface at as fast a rate as it is being removed by the stream of warm dry gas. During the first stage, the drying takes place at a constant rate, which depends upon the temperature and gas velocity. When the second stage is reached, the drying rate decreases steadily with time. Eventually a stage is reached where no further drying occurs (an 'equilibrium moisture content' is reached).

Many different types of industrial dryers are applied in the LVIC-S industry, such as spray dryers, or horizontal rotating drum dryers. Continuous dryers are usually large tubular rotating drums set at a slight angle to the horizontal. The wet material enters at the top and the hot gases at the bottom, thus achieving countercurrent flow. The slow rotation of the drum causes the material to shower down through the hot gases during its passage through the machine, thus exposing a large surface area to the drying action.

Drying is applied for instance in the manufacturing of aluminium fluoride, sodium bicarbonate, sodium tripolyphosphate, sodium perborate, and several other LVIC-S industry products.



### **11.3 Annex 3 – good environmental practice (GEP) for the use of technology, plant design, maintenance, operation, environmental protection and plant decommissioning in the LVIC-S industry**

In order to ensure transparency and clarity with respect to the basis upon which conclusions on good environmental practices (GEP) for the use of technology, plant design, maintenance, operation and decommissioning in the LVIC-S industry are drawn, it is suggested that, apart from the process Chapters 2 through to 7, the user of this document refers in particular to Chapter 1 and Chapter 8.

Additional information can also be found in the BREFs on:

- Common Waste Water and Waste Gas Treatment/Management Systems in the Chemical Sector (CWW)
- Emissions from Storage (ESB)
- Large Combustion Plants (LCP)
- Industrial Cooling Systems (CV)
- General Principles of Monitoring (MON)
- Energy Efficiency (ENE) – currently in preparation.

Finally, the user of this document is also referred to the European pollutant emission register (EPER), giving access to the information on the annual emissions of major industrial facilities in the Member States of the EU [12, European Environment Agency, 2004]. It should be noted, however, that the EPER that already exists will be replaced by the European PRTR, and reporting under the new regime will start reaching the public from 2009. Reporting in EPER and E-PRTR is only necessary if the emission levels are above a specified threshold.

The reader should note that some of the GEP conclusions are followed by the more detailed rationale, which can be considered as a note justifying the GEP conclusion in question.

#### **11.3.1 GEP for the use of technology in the LVIC-S industry**

Given the much diversified characteristics of the LVIC-S industry and a great number of processes and process routes involved, it is impossible to define only one universal generic GEP for the use of technology in the LVIC-S industry sector.

In turn, drawing detailed conclusions on GEP for the use of technology at sector level is considered not reasonable and, therefore, three GEP conclusions for the use of technology in the LVIC-S industry are presented below.

For the use of technology in the LVIC-S industry, under technically feasible and economically viable conditions, taking into consideration the costs and advantages, GEP is to:

1. Adopt the process or process route which offers better overall raw material and energy efficiency – see Sections 1.1.3, 1.1.4, 1.2, 1.3, 1.4, 8.1, 8.2, 8.3, 8.4, 8.7, 8.8 and 8.9.

Where the use of alternative processes (or process routes) for the production of the same LVIC-S product is technically feasible and economically viable, and where other basic selection criteria are comparable, the operators of the new or substantially changed LVIC-S plants are more likely to adopt the process (or process route) which offers better overall raw material and energy efficiency as, typically, this also results in reduced impact on the environment as a whole.

2. Survey the possibilities for development of cleaner technologies for use in the LVIC-S industry – see Sections 1.1.3, 1.1.4, 1.2, 1.3, 1.4, 8.1, 8.2, 8.3, 8.4, 8.7, 8.8 and 8.9.

In selecting criteria for the use of technology in the LVIC-S industry, the operators of the new, substantially changed, and existing plants should take into account, and pursue the possibilities for development of cleaner, environmentally friendly and economically viable technologies, streamlined with considerations included in Annex IV to the IPPC Directive.

Where the use of alternative raw materials for the manufacture of the same LVIC-S product is an option, the resulting changes in the process are possible, technically feasible and economically viable, and where other basic selection criteria relating to the whole chain of steps involved upstream of the LVIC-S plant site, with the impact on the environment as a whole are taken into consideration (e.g. life cycle assessment), the operators of the LVIC-S plants should consider selection of raw materials with such properties that material efficiency in the process is increased, final quality of the product is reached and emissions are reduced.

3. Carry out the comparisons of environmental performance of the processes used (or to be used) in LVIC-S plants, with sector, regional or national benchmarks – see Sections 1.1.3, 1.1.4, 1.2, 1.3, 1.4, 8.1, 8.2, 8.3, 8.4, 8.7, 8.8 and 8.9.

In selecting criteria for the use of technology for the LVIC-S industry, the operators of the new, substantially changed, and existing LVIC-S plants should take necessary steps to carry out the comparisons of environmental performance of the processes currently used or considered to be used in new LVIC-S plants, with sector, regional or national benchmarks, including economic viability, material and energy efficiency in the process, choice of input materials, emissions to air, discharges to water and generation of solid wastes.

### 11.3.2 GEP for plant design in the LVIC-S industry

The two GEP conclusions for plant design in the LVIC-S industry mentioned below, apply mainly to new or substantially changed plants operated by a continuous process. However, to a varying degree, they apply also to plants operated by a batch process, provided that a whole cycle of many batch operations, plant cleaning, and maintenance, is taken into consideration.

For plant design in the LVIC-S industry, GEP is to:

1. Require from, and ensure that, the plant contractor provides complete process- and plant-related information, to enable the assessment and reduction of the impact of the plant on the environment as a whole – see Sections 1.1.3, 1.3, 1.4.2, 1.4.3, 1.4.3.1, 1.4.3.2, 2.4.1, 8.1, 8.2, 8.3, 8.4, 8.5.3, 8.6.1, 8.7, 8.8.1.3, 8.8.1.4, 8.8.1.6, 8.8.2.1, 8.8.2.3, 8.8.3 and 8.8.3.1.

The operator of the new or substantially changed LVIC-S plant should require from the process licensor, engineering design company or plant contractor, as appropriate, the following process- and plant-related information, data and figures to enable the assessment and reduction of the impact the new or substantially changed plant can have on the environment as a whole:

- 1.1. material balance for the process showing reaction yields, stoichiometric and guaranteed consumption figures, assumed plant losses, and the quantitative and qualitative data for effluents discharged from the plant to air, water and land, to enable the operator to exploit the plant at a high level of material efficiency and to reduce the impact of the plant on the environment

- 1.2. energy balances for the process (both theoretical and actual), including the different forms and quantities of energy inputs and outputs, reaction heat, efficiency of energy transformation, and energy losses, in order to enable the operator to exploit the plant to a high level of energy efficiency, according to guaranteed energy consumption figures, save energy in the process, and also reduce the impact on the environment from energy generating facilities associated with the plant
- 1.3. figures on designed daily plant capacity, including the operational flexibility rate of the plant, as well as the assumed onstream factor of a plant and its nominal yearly capacity, to enable plant operation within an optimum capacity range, maintain a high level of material and energy efficiency in the process, save resources and reduce the impact of the plant on the environment
- 1.4. operational manuals, including process control procedures for plant start up, shut down, and abnormal operating conditions, in order to enable the operator to minimise peak consumption and emission rates during these periods of operation, maintain the safety of the process and reduce the impact of the plant on the environment.

Such documentation, as in 1.1 through to 1.4 above, should exist but in some cases may not be disclosed for confidentiality reasons.

2. Ensure that the plants are designed and constructed in accordance with the integrated plant design to enable high material and energy efficiency in the processes, reduce fugitive emissions and minimise the impact of the LVIC-S plants on the environment – see Sections 1.1.3, 1.3, 1.4.2, 1.4.3, 8.1, 8.2, 8.3, 8.4, 8.6.1, 8.7, 8.8.1.4, 8.8.1.6, 8.8.2.1, 8.8.2.3, 8.8.3, 8.8.3.1 and 8.9.

Operators of the new or substantially changed LVIC-S plants should take the necessary measures to ensure that the plants are designed and constructed in accordance with the integrated plant design, optimally fit to the layout of an inorganic chemical industry complex and interlinked with upstream and downstream process installations and infrastructure at the LVIC-S industry site, to enable efficient material and energy flows between the plants, reduce fugitive emissions and minimise the impact of the LVIC-S plants on the environment.

### 11.3.3 GEP for plant maintenance in the LVIC-S industry

Three GEP conclusions for plant maintenance in the LVIC-S industry are mentioned below, and apply to a varying degree to new or substantially changed plants, and to existing plants:

For plant maintenance in the LVIC-S industry, GEP is to:

1. Require and receive from the contractor complete plant- and plant-maintenance related information to enable the assessment and reduction of the impact the new or substantially changed plant can have on the environment – see Sections 1.1.3, 1.4.2, 1.4.3, 1.4.3.1, 2.4.1, 8.1, 8.6.1, 8.6.2, 8.7, 8.8.1.3, 8.8.1.4, 8.8.1.6, 8.8.2.1, 8.8.2.3 and 8.9.

The operator of the new or substantially changed LVIC-S plant should require from the process licensor, engineering design company or plant contractor, as appropriate, the following process- and plant-related information to enable the assessment and reduction of the impact the new or substantially changed plant can have on the environment as a whole:

- 1.1. information on assumed plant stoppages within the overall plant maintenance cycle (typically several years between planned main maintenance stoppages), including the number and frequency of plant stoppages for equipment cleaning, equipment exchange and plant maintenance, in order to enable assessment and control of the impact the plant can have on the environment as a whole within the planned cycle of its operation
  - 1.2 a programme of preventive maintenance, including diagnostic testing and checking of equipment before plant start up, as a necessary aid to decreasing the number of start-ups and shut-downs of the plant and for avoiding an excessive number of abnormal operation conditions in the plant, which are the key preconditions to reducing the impact of the plant on the environment.
2. Ensure that a plant is designed and constructed with the aim of having easy access for cleaning and maintenance, for minimising unplanned downtime and for avoiding uncontrolled emissions – see Sections 1.1.3, 1.4.2, 1.4.3, 2.4.1, 3.2.4.2, 8.1, 8.6.1, 8.7, 8.8.1.3, 8.8.1.4, 8.8.1.6, 8.8.2.1, 8.8.3.1, and 8.9

Operators of the LVIC-S plants should take the necessary measures to ensure that the plants are designed and constructed with the aim of having easy access for cleaning, maintenance and interchangeability of the critical items of process equipment for standby equipment, and for controlling the leakages of process media in the LVIC-S industry complex, plants, plant sections, piping and instrumentation, in order to minimise unplanned plant downtime and to avoid uncontrolled emissions.

3. Prepare and adhere to a programme of preventive maintenance for existing LVIC-S plants to reduce the impact of the plant on the environment – see Sections 1.1.3, 1.4.2, 1.4.3, 1.4.3.1, 2.4.1, 8.1, 8.6.1, 8.6.2, 8.7, 8.8.1.3, 8.8.1.4, 8.8.2.1, 8.8.3.1 and 8.9.

Operators of existing LVIC-S plants (typically older plants exploited within an inorganic chemical industry complex), should prepare and adhere to a programme of preventive maintenance, including diagnostic equipment testing and checking before plant start up, which is a necessary aid to reduce the number of start-ups and shut-downs of the plant, avoid the number of abnormal operation conditions in the plant and reduce the impact of the plant on the environment.

### 11.3.4 GEP for plant operation in the LVIC-S industry

Given the complexity of the LVIC-S industry, the number of processes applied, the large volumes of process media and effluents involved, and the impact of this industry on the environment requiring incorporation of both primary and end-of-pipe effluent treatment measures (refer to Sections 1.1.3 and 1.3, and process Chapters 2 through to 7), it was considered justified to include here only the GEP that are most characteristic for plant operation in the LVIC-S industry.

The following four GEP conclusions for plant operation in the LVIC-S industry, to a varying degree apply to existing LVIC-S plants, as well as to new or substantially changed plants:

For plant operation in the LVIC-S industry, GEP is to:

- 1 Check the quality of raw materials used in the manufacture of LVIC-S products to reduce the impact on the environment – see Sections 1.1.3, 1.1.4, 1.2, 1.3, 1.4, 8.1, 8.2, 8.3, 8.4, 8.7, 8.8 and 8.9.

The quality (both of chemical composition and of physical parameters) of raw materials used in the manufacture of LVIC-S products has a direct and/or an indirect impact on the environment. The quality of raw materials generally has an influence on the emissions from LVIC-S processes at the site. A quality check of raw materials should be performed in accordance with the operational procedures used in a given LVIC-S process and plant. Of particular importance in this context is the issue of by-products and wastes generated in the process, including wastes that are untreatable (directly related to the type and quality of processed feedstock) and wastes that are treatable (wastes that can be upgraded, reprocessed and utilised). Refer also to Section 1 (2) above on cleaner technologies.

- 2 Control consumption of raw materials and energy used in the operated LVIC-S process, as compared to consumption figures assumed in the process design package – see Sections 1.1.3, 1.1.4, 1.2, 1.3, 1.4, 8.1, 8.2, 8.3, 8.4, 8.7, 8.8 and 8.9.

Actual operational consumption figures of raw materials and energy used in the LVIC-S process, as compared to consumption figures assumed in the basic engineering design package, are very important indicators of the material and energy efficiency in the process. They can serve as process guidelines for improvement of a process operation, and as an important aid to process optimisation, to reduce the impact of the plant on the environment. Apart from the comparisons of process performance with similar plants operated in the LVIC-S industry sector, process trial tests done in an LVIC-S plant (e.g. within the programmes and procedures of Responsible Care and EMAS) are also a possibility for improvement.

- 3 Where it is technically feasible and economically viable, integrate an LVIC-S plant with a combined heat and power (CHP) system, to enable plant operation at a high level of energy efficiency and to reduce the impact on the environment – see Sections 1.1.3, 1.3, 1.4.2, 1.4.3, 1.4.3.1, 1.4.3.2, 2.3.7, 2.4.2, 8.1, 8.5.3, 8.8.1.6, 8.8.3 and 8.8.3.1.

Where it is technically feasible (e.g. sufficient space at the site) and economically viable, the operators of the new or substantially changed plants and of the existing LVIC-S plants, should take the necessary steps to ensure that the plants are integrated with the combined heat and power (CHP) systems at the site, in order to enable plant operation at a high level of energy efficiency, save energy in the process and reduce the impact on the environment from energy generating facilities associated with the plant.

- 4 Where technically feasible and economically viable, first apply primary process-related measures to reduce the impact of the LVIC-S plant on the environment – see Sections 1.1.3, 1.3, 1.4.2, 1.4.3, 8.1, 8.5.3, 8.8.3 and 8.8.3.1.

Where only possible, technically feasible and economically viable, the operators of the LVIC-S plants should first consider the application of primary process-related measures to reduce the impact of the LVIC-S plant on the environment, prior to the application of secondary end-of-pipe measures. Primary process-related measures treat the reasons, and not the causes, of process malfunctions or reduced process efficiency and, therefore, they are typically more effective than the secondary end-of-pipe measures, in particular in the case when primary measures are foreseen at the early stage of the process design for a given LVIC-S plant.

### 11.3.5 GEP for reducing environmental impact from the LVIC-S industry

As mentioned in Section 8.10 for LVIC-S plants, BAT is to implement and adhere to an environmental management system. Apart from this BAT and Best Available Techniques included in process Chapters 2 through to 7, the following eight GEP for reducing environmental impact from the LVIC-S industry, which apply to all LVIC-S plants, are included below:

For reducing environmental impact from the LVIC-S industry, GEP is to:

1. Reduce dust emissions, using proven dedusting systems and a combination of the available dedusting techniques – see Sections 1.3, 1.4, 8.1, 8.2, 8.2.3.7, 8.2.4, 8.2.4.1, 8.7, 8.8 and 8.9.
2. Reduce gaseous emissions to air, using a suitable combination of primary process-related preventive techniques and secondary end-of-pipe abatement techniques – see Sections 1.3, 1.4, 8.1, 8.2, 8.2.1, 8.2.2, 8.2.3, 8.2.4, 8.2.4.1, 8.6.1, 8.6.2, 8.7, 8.8 and 8.9.
3. Reduce diffuse emissions to air by using process, prevention and minimisation measures (plant operation below atmospheric pressure, plant monitoring and maintenance, enclosure of equipment, etc.) – see Sections 1.3, 1.4, 8.1, 8.2, 8.2.1, 8.2.2, 8.2.3, 8.2.4, 8.2.4.1, 8.6.1, 8.6.2, 8.7, 8.8 and 8.9.
4. Recover energy from process streams released into air, using available energy recovery and utilisation techniques (heat exchange within the process, energy recovery boilers, the generation of low pressure steam, etc.), to save energy and reduce emissions associated with the generation of energy – see Sections 1.1.3, 1.3, 1.4, 8.1, 8.5.3, 8.7, 8.8, 8.8.1.6, 8.8.3, 8.8.3.1, and 8.9.
5. Reduce emissions of inorganic compounds to water, using measures to prevent releases into water, minimise waste water discharges, and by using waste water collection and treatment, including in-plant treatment, primary treatment and secondary/tertiary systems – see Sections 1.1.3, 1.3, 1.4, 8.1, 8.3, 8.3.1, 8.3.2, 8.3.3, 8.3.4.1, 8.3.4.2, 8.3.4.3, 8.3.4.4, 8.7, 8.8, 8.8.1.6, 8.8.3.1 and 8.9.
6. Reduce discharges of suspended solids and heavy metals with waste waters to fresh water or to seawater, by selecting raw materials, using measures to reduce releases to water (e.g. deposition of solids), and by applying total dispersion of suspended solids and heavy metals in the receiving water body, in order to minimise the impact of discharged waste waters on the aquatic environment – see Sections 1.1.3, 1.3, 1.4, 8.1, 8.3.1, 8.3.2, 8.3.3, 8.3.4.1, 8.3.4.2, 8.3.4.3, 8.3.4.4, 8.4.1, 8.4.2, 8.4.3, 8.7, 8.8, 8.8.1.6, 8.8.3.1 and 8.9, as well as process Chapters 2 through to 7.
7. Reduce emissions of solid wastes to land by using a suitable combination of waste preventive and waste utilisation measures based on waste management, including the selection of raw materials, utilisation of treatable solid waste to saleable by-products, and the conversion of solid waste to forms less harmful for the environment – see Sections 1.1.3, 1.3, 8.1, 8.4.2, 8.4.3, 8.7, 8.8, 8.9, and process Chapters 2 through to 7.
8. Recycle the spill off, product waste or contained material back into the process – see Sections 1.1.3, 1.3, 8.1, 8.4.2, 8.4.3, 8.7, 8.8, 8.9, and process Chapters 2 through to 7.

### **11.3.6 GEP for plant decommissioning in the LVIC-S industry**

The two GEP conclusions for plant decommissioning in the LVIC-S industry mentioned below apply to a varying degree to new or substantially changed plants, and to existing LVIC-S plants:

1. Ensure that at the stage of designing a new plant, due considerations are given to the environmental impact from the eventual decommissioning of the plant, and that a plant is designed and constructed with the aim of achieving easier, cleaner and cheaper end-of-life plant decommissioning – see Sections 1.1.3, 1.4.2, 1.4.3, 8.1 and 8.9.
2. Ensure that after definitive cessation of production, LVIC-S plants are decommissioned with the aim of minimising environmental risks for the contamination of land and groundwater, and that the production site is returned to a satisfactory state. Any decision to undertake remediation actions should be preceded by a risk assessment study taking into account all aspects of the local situation (e.g. type of pollutant, pathway and receptors) – see Sections 1.1.3, 1.4.2, 1.4.3, 3.3.3.6, 8.1 and 8.9.