



EUROPEAN COMMISSION

Reference Document on
Best Available Techniques in the Production of

Polymers

August 2007

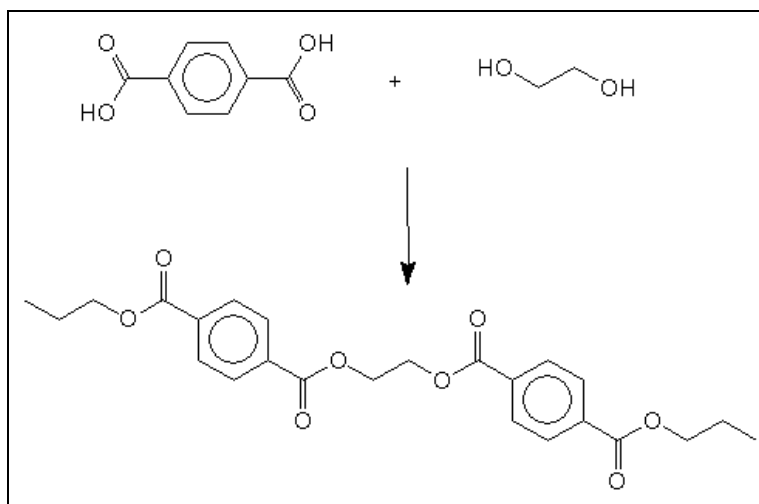

This document is one of a series of foreseen documents as below (at the time of writing, not all documents have been finalised):

Reference Document on Best Available Techniques . . .	Code
Large Combustion Plants	LCP
Mineral Oil and Gas Refineries	REF
Production of Iron and Steel	I&S
Ferrous Metals Processing Industry	FMP
Non Ferrous Metals Industries	NFM
Smitheries and Foundries Industry	SF
Surface Treatment of Metals and Plastics	STM
Cement and Lime Manufacturing Industries	CL
Glass Manufacturing Industry	GLS
Ceramic Manufacturing Industry	CER
Large Volume Organic Chemical Industry	LVOC
Manufacture of Organic Fine Chemicals	OFC
<i>Production of Polymers</i>	<i>POL</i>
Chlor – Alkali Manufacturing Industry	CAK
Large Volume Inorganic Chemicals - Ammonia, Acids and Fertilisers Industries	LVIC-AAF
Large Volume Inorganic Chemicals - Solid and Others industry	LVIC-S
Production of Speciality Inorganic Chemicals	SIC
Common Waste Water and Waste Gas Treatment/Management Systems in the Chemical Sector	CWW
Waste Treatments Industries	WT
Waste Incineration	WI
Management of Tailings and Waste-Rock in Mining Activities	MTWR
Pulp and Paper Industry	PP
Textiles Industry	TXT
Tanning of Hides and Skins	TAN
Slaughterhouses and Animals By-products Industries	SA
Food, Drink and Milk Industries	FDM
Intensive Rearing of Poultry and Pigs	ILF
Surface Treatment Using Organic Solvents	STS
Industrial Cooling Systems	CV
Emissions from Storage	ESB
Reference Document . . .	
General Principles of Monitoring	MON
Economics and Cross-Media Effects	ECM
Energy Efficiency Techniques	ENE

Electronic versions of draft and finalised documents are publically available and can be downloaded from <http://eippcb.jrc.es>.

EXECUTIVE SUMMARY

1) Introduction

The BAT (Best Available Techniques) Reference Document (BREF) entitled “Best Available Techniques for the Production of Polymers” (POL) reflects an information exchange carried out under Article 16(2) of Council Directive 96/61/EC (IPPC Directive). This executive summary describes the main findings, a summary of the principal BAT conclusions and the associated emission and consumption levels. It should be read in conjunction with the preface, which explains this document’s objectives; how it is intended to be used and legal terms. It can be read and understood as a standalone document but, as a summary, it does not present all the complexities of this full document. It is therefore not intended as a substitute for this full document as a tool in BAT decision making.

2) Scope of this document

This document focuses on the main products of the European polymer industry both in production figures and in environmental impact, mainly produced in dedicated installations for the production of one specific polymer. The list of products covered is not conclusive but includes polyolefins, polystyrene, polyvinyl chloride, unsaturated polyesters, emulsion polymerised styrene butadiene rubbers, solution polymerised rubbers containing butadiene, polyamides, polyethylene terephthalate fibres and viscose fibres.

For polymer production installations, no specific threshold was established in drawing a borderline between IPPC installations and non IPPC installations as this is not foreseen in the IPPC Directive.

3) The sector and environmental issues

Polymer companies produce a variety of basic products, which range from commodities to high added-value materials and are produced in both batch and continuous processes covering installations with a capacity of some 10000 tonnes per year up to some 300000 tonnes per year.

The basic polymers are sold to processing companies, serving an immense range of end-user markets.

The chemistry of polymer production consists of three basic reaction types, polymerisation, polycondensation and polyaddition, thus the number of operations/processes used remains reasonably small. These include preparation, the reaction itself and the separation of products. In many cases cooling, heating, or the application of vacuum or pressure is necessary. The unavoidable waste streams are treated in recovery and/or abatement systems or disposed of as waste.

The key environmental issues of the polymer sector are emissions of volatile organic compounds, in some cases waste waters with the potential for high loads of organic compounds, relatively large quantities of spent solvents and non-recyclable waste as well as the energy demand. Given the diversity of the sector and the wide range of polymers produced, this document does not provide a complete overview of the releases from the polymer sector. However, emission and consumption data are presented from a broad range of currently operational plants in the sector.

4) Techniques to consider in the determination of BAT

The techniques to consider in the determination of BAT are grouped in a generic section and product specific sections for certain polymers. The former includes environmental management tools, equipment design and maintenance, monitoring and some generic techniques related to energy and end-of-pipe measures.

5) Best available techniques

The summary presented below does not include background statements and cross referencing which is found in the full text. Additionally, the full text contains BAT on environmental management which is not mentioned in this executive summary.

The interface with the BREF on CWW

The BREF on “Common waste gas and waste water treatment/management systems in the chemical sector” describes techniques which are commonly applicable to the whole spectrum of the chemical industry. Detailed descriptions of recovery or abatement techniques can be found in the BREF on CWW.

The BAT associated emission levels of the end-of-pipe techniques described in the CWW BREF are BAT wherever these techniques are applied in the polymer sector.

Mass flow and concentration levels

This document mostly refers to production related BAT associated emission and consumption levels, and also refers to end-of-pipe techniques whose concentration related performance can be found in the CWW BREF. All BAT associated emission levels relate to total emissions including both point sources and fugitive emissions.

Understanding the application of the BAT

The BAT that are listed include generic BAT and specific BAT for the different polymers covered in this document. The generic BAT are those that are considered to be generally applicable to all types of polymer installations. The polymer specific BAT are those that are considered to be specifically BAT for installations dealing mainly or wholly with certain types of polymers.

Generic BAT is

- to reduce fugitive emissions by advanced equipment design including:
 - use of valves with bellow or double packing seals or equally efficient equipment. Bellow valves are especially recommended for highly toxic services
 - magnetically driven or canned pumps, or pumps with double seals and a liquid barrier
 - magnetically driven or canned compressors, or compressors using double seals and a liquid barrier
 - magnetically driven or canned agitators, or agitators with double seals and a liquid barrier
 - minimisation of the number of flanges (connectors)
 - effective gaskets
 - closed sampling systems
 - drainage of contaminated effluents in closed systems
 - collection of vents.
- to carry out a fugitive loss assessment and measurement to classify components in terms of type, service and process conditions to identify those elements with the highest potential for fugitive loss
- to establish and maintain an equipment monitoring and maintenance (M&M) and/or leak detection and repair (LDAR) programme based on a component and service database in combination with the fugitive loss assessment and measurement

- to reduce dust emissions with a combination of the following techniques:
 - dense phase conveying is more efficient to prevent dust emissions than dilute phase conveying
 - reduction of velocities in dilute phase conveying systems to values as low as possible
 - reduction of dust generation in conveying lines through surface treatment and proper alignment of pipes
 - use of cyclones and/or filters in the air exhausts of dedusting units. The use of fabric filter systems is more effective, especially for fine dust
 - use of wet scrubbers.
- to minimise plant start-ups and stops to avoid peak emissions and reduce overall consumption (e.g. energy, monomers per tonne of product)
- to secure the reactor contents in case of emergency stops (e.g. by using containment systems)
- to recycle the contained material or to use it as fuel
- to prevent water pollution by appropriate piping design and materials. To facilitate inspection and repair, effluent water collection systems at new plants and retrofitted systems are, e.g.:
 - pipes and pumps placed above ground
 - pipes placed in ducts accessible for inspection and repair.
- to use separate effluent collection systems for:
 - contaminated process effluent water
 - potentially contaminated water from leaks and other sources, including cooling water and surface run-off from process plant areas, etc.
 - uncontaminated water.
- to treat the air purge flows coming from degassing silos and reactor vents with one or more of the following techniques:
 - recycling
 - thermal oxidation
 - catalytic oxidation
 - adsorption
 - flaring (only discontinuous flows).
- to use flaring systems to treat discontinuous emissions from the reactor system. Flaring of discontinuous emissions from reactors is only BAT if these emissions cannot be recycled back into the process or used as fuel
- to use, where possible, power and steam from cogeneration plants. Cogeneration is normally installed when the plant uses the steam produced, or where an outlet for the steam produced is available. The electricity produced can either be used by the plant or exported
- to recover the reaction heat through the generation of low pressure steam in processes or plants where internal or external consumers of the low pressure steam are available
- to re-use the potential waste from a polymer plant
- to use pigging systems in multiproduct plants with liquid raw materials and products
- to use a buffer for waste water upstream of the waste water treatment plant to achieve a constant quality of the waste water. This applies to all processes producing waste water, such as PVC and ESBR
- to treat waste water efficiently. Waste water treatment can be carried out in a central plant or in a plant dedicated to a special activity. Depending on the waste water quality, additional dedicated pretreatment is required.

BAT for polyethylene is

- to recover monomers from reciprocating compressors in LDPE processes to:
 - recycle them back to the process and/or
 - send them to a thermal oxidiser.
- to collect off-gases from the extruders. Off-gases from the extruding section (extruder rear seal) in LDPE production are rich in VOC. By sucking off the fumes from the extrusion section, the emission of monomers is reduced
- to reduce the emissions from finishing and storage sections by treatment of purge air
- to operate the reactor at the highest possible polymer concentration. By increasing the concentration of the polymer in the reactor, the overall energy efficiency of the production process is optimised
- to use closed-loop cooling systems.

BAT for LDPE is

- operation of the low pressure separator (LPS) vessel at minimum pressure and/or
- solvent selection and
- devolatilisation extrusion or
- treatment of purge air from degassing silos.

BAT for suspension processes is

- application of closed-loop nitrogen purge systems and
- optimisation of the stripping process and
- recycling of monomers from the stripping process and
- condensation of the solvent and
- solvent selection.

BAT for gas phase processes is

- application of closed-loop nitrogen purge systems and
- solvent and comonomer selection.

BAT for solution LLDPE processes is

- condensation of the solvent and/or
- solvent selection and
- devolatilisation extrusion or
- treatment of purge air from degassing silos.

BAT for polystyrene is

- to reduce and control emissions from storage by one or more of the following techniques:
 - minimisation of level variation
 - gas balance lines
 - floating roofs (large tanks only)
 - installed condensers
 - vent recovery to treatment.

- to recover all purge streams and reactor vents
- to collect and treat the exhaust air from pelletising. Usually, the air sucked off the pelletising section is treated together with reactor vents and purge streams. This only applies to GPPS and HIPS processes
- to reduce emissions from the preparation in EPS processes by one or more of the following or equivalent techniques:
 - vapour balance lines
 - condensers
 - vent recovery to further treatment.
- to reduce emissions from the dissolving system in HIPS processes by one or more of the following techniques:
 - cyclones to separate conveying air
 - high concentration pumping systems
 - continuous dissolving systems
 - vapour balance lines
 - vent recovery to further treatment
 - condensers.

BAT for polyvinyl chloride is

- to use appropriate storage facilities for the VCM feedstock, designed and maintained to prevent leaks and resulting air, soil and water pollution:
 - to store VCM in refrigerated tanks at atmospheric pressure or
 - to store VCM in pressurised tanks at ambient temperature and
 - to avoid VCM emissions by providing tanks with refrigerated reflux condensers and/or
 - to avoid VCM emissions by providing tanks with connection to the VCM recovery system or to appropriate vent treatment equipment.
- to prevent emissions from connections when unloading VCM by
 - use of vapour balance lines and/or
 - evacuation and treatment of VCM from connections prior to decoupling
- to reduce residual VCM emissions from reactors by an appropriate combination of the following techniques:
 - reducing the frequency of reactor openings
 - depressurising the reactor by venting to VCM recovery
 - draining the liquid contents to closed vessels
 - rinsing and cleaning the reactor with water
 - draining of this water to the stripping system
 - steaming and/or flushing the reactor with inert gas to remove residual traces of VCM, with transfer of the gases to VCM recovery.
- to use stripping for the suspension or latex to obtain a low VCM content in the product
- to treat waste water with a combination of:
 - stripping
 - flocculation
 - biological waste water treatment.

Executive Summary

- to prevent dust emissions from drying process with cyclones for suspension PVC, bag filters for microsuspension and multiple bag filters for emulsion PVC
- to treat VCM emissions from the recovery system by one or more of the following techniques:
 - absorption
 - adsorption
 - catalytic oxidation
 - incineration.
- to prevent and control fugitive emissions of VCM arising from equipment connections and seals
- to prevent accidental emissions of VCM from polymerisation reactors by one or more of the following techniques:
 - specific control instrumentation for reactor feeds and operational conditions
 - chemical inhibitor systems to stop the reaction
 - emergency reactor cooling capacity
 - emergency power for agitation (water insoluble catalysts only)
 - controlled emergency vent capacity to the VCM recovery system.

BAT for unsaturated polyesters is

- to treat exhaust gases by one or more of the following techniques:
 - thermal oxidation
 - activated carbon
 - glycol scrubbers
 - sublimation boxes.
- to thermally treat waste water, arising mainly from the reaction (mostly together with waste gas).

BAT for ESBR is

- to design and maintain the plant storage tanks to prevent leaks and resulting air, soil and water pollution and to use one or more of the following techniques for storage:
 - minimise level variation (integrated plants only)
 - gas balance lines (nearby tanks only)
 - floating roofs (large tanks only)
 - vent condensers
 - improved styrene stripping
 - vent recovery to external treatment (usually incineration).
- to control and minimise diffuse (fugitive) emissions by the following or equivalent techniques:
 - monitoring of flanges, pumps, seals, etc.
 - preventive maintenance
 - closed-loop sampling
 - plant updates: tandem mechanical seals, leak proof valves, improved gaskets.

- to collect the vents from process equipment for treatment (usually incineration)
- to recycle water
- to treat waste water using biological treatment or equivalent techniques
- to minimise the volume of hazardous waste by good segregation and collect them to send for external treatment
- to minimise the volume of non-hazardous waste by good management and off-site recycling.

BAT for solution polymerised rubbers containing butadiene is

- to remove solvents from the product by using one or both of the following or an equivalent technique:
 - devolatilisation extrusion
 - steam stripping.

BAT for polyamides is

- to treat flue-gases from polyamide production processes by wet scrubbing.

BAT for polyethylene terephthalate fibres is

- to apply a waste water pretreatment such as one or more of the following techniques:
 - stripping
 - recycling
 - or equivalent

before sending waste water from PET production processes to a WWT plant

- to treat waste gas streams from PET production with catalytic oxidation or equivalent techniques.

BAT for viscose fibres is

- to operate spinning frames in houses
- to condense the exhaust air from spinning streets to recover CS₂ and recycle it back into the process
- to recover CS₂ from exhaust air streams through adsorption on activated carbon. Depending on the concentration of H₂S in the exhaust air, different technologies are available for the adsorptive recovery of CS₂
- to apply exhaust air desulphurisation processes based on catalytic oxidation with H₂SO₄ production. Depending on the mass flows and concentrations, there are a number of different processes available to oxidise exhaust gases containing sulphur
- to recover sulphate from spinning baths. BAT is to remove sulphate as Na₂SO₄ from the waste water. The by-product is economically valuable and sold
- to reduce Zn from the waste water by alkaline precipitation followed by sulphide precipitation
- to use anaerobic sulphate reduction techniques for sensitive waterbodies
- to use fluidised bed incinerators to burn non-hazardous wastes and recover the heat for the production of steam or energy.

6) BAT associated emission and consumption levels

Taking into account the generic and specific BAT, the following emission and consumption levels are associated with BAT (see the following table):

	VOC (g/t)	Dust (g/t)	COD (g/t)	Suspended solids (g/t)	Direct energy (GJ/t)	Hazardous waste (kg/t)
LDPE	New: 700 - 1100 Existing: 1100 - 2100	17	19 – 30		Tube: 2.88 – 3.24 * Autoclave: 3.24 – 3.60	1.8 – 3.0
LDPE copolymers	2000	20			4.50	5.0
HDPE	New: 300 - 500 Existing: 500 - 1800	56	17		New: 2.05 Existing: 2.05 – 2.52	3.1
LLDPE	New: 200 - 500 Existing: 500 - 700	11	39		New: 2.08 Existing: 2.08 – 2.45	0.8
GPPS	85	20	30	10	1.08	0.5
HIPS	85	20	30	10	1.48	0.5
EPS	450 - 700	30			1.80	3.0
S-PVC	VCM: 18 - 45 Splitview: 18 - 72	10 – 40	50 – 480	10**		0.01 – 0.055
E-PVC	100 - 500 Splitview: 160 - 700	50 – 200	50 – 480	10**		0.025 – 0.075
UP	40 - 100	5 – 30			2 – 3.50	7
ESBR	170 - 370		150 – 200			
* Excludes a potential positive credit of 0 to 0.72 GJ/t for low pressure steam (depending on export possibilities for low pressure steam)						
'New' and 'existing' refers to new or existing installations.						
** Alternatively, 1 – 12 g/t AOX are achieved for PVC production sites or combined sites with PVC production						
	S to air (kg/t)	SO ₄ ²⁻ to water (kg/t)	COD (g/t)	Zn to water (g/t)	Direct energy (GJ/t)	Hazardous waste (kg/t)
Viscose staple fibres	12 - 20	200 - 300	3000 - 5000	10 - 50	20 - 30	0.2 - 2.0

Three Member States wanted a split view recorded against the BAT AEL for VCM emissions to air in the production of PVC. The BAT AEL these Member States proposed are shown in the table. The rationale for their split view is given as follows: *The upper value of the range applies to the small production sites. The wide range of the BAT AEL does not belong to different BAT performance but to different product mix manufacturing. Any BAT AEL in this range is related to plants applying BAT throughout their processes.*

7) Concluding remarks

The information exchange on Best Available Techniques for the Production of Polymers was carried out from 2003 to 2005. The information exchange process was successful and a high degree of consensus was reached during and following the final meeting of the Technical Working Group. Only one split view was recorded and this was for the BAT associated emissions levels in PVC production.

The EC is launching and supporting, through its RTD programmes, a series of projects dealing with clean technologies, emerging effluent treatment and recycling technologies and management strategies. Potentially these projects could provide a useful contribution to future BREF reviews. Readers are therefore invited to inform the EIPPCB of any research results which are relevant to the scope of this document (see also the Preface of this document).

PREFACE

1. Status of this document

Unless otherwise stated, references to “the Directive” in this document means the Council Directive 96/61/EC on integrated pollution prevention and control. As the Directive applies without prejudice to Community provisions on health and safety at the workplace, so does this document.

This document forms part of a series presenting the results of an exchange of information between EU Member States and industries concerned on best available technique (BAT), associated monitoring, and developments in them. It is published by the European Commission pursuant to Article 16(2) of the Directive, and must therefore be taken into account in accordance with Annex IV of the Directive when determining “best available techniques”.

2. Relevant legal obligations of the IPPC Directive and the definition of BAT

In order to help the reader understand the legal context in which this document has been drafted, some of the most relevant provisions of the IPPC Directive, including the definition of the term “best available techniques”, are described in this preface. This description is inevitably incomplete and is given for information only. It has no legal value and does not in any way alter or prejudice the actual provisions of the Directive.

The purpose of the Directive is to achieve integrated prevention and control of pollution arising from the activities listed in its Annex I, leading to a high level of protection of the environment as a whole. The legal basis of the Directive relates to environmental protection. Its implementation should also take account of other Community objectives such as the competitiveness of the Community’s industry thereby contributing to sustainable development.

More specifically, it provides for a permitting system for certain categories of industrial installations requiring both operators and regulators to take an integrated, overall look at the polluting and consuming potential of the installation. The overall aim of such an integrated approach must be to improve the management and control of industrial processes so as to ensure a high level of protection for the environment as a whole. Central to this approach is the general principle given in Article 3 that operators should take all appropriate preventative measures against pollution, in particular through the application of best available techniques enabling them to improve their environmental performance.

The term “best available techniques” is defined in Article 2(11) of the Directive as “the most effective and advanced stage in the development of activities and their methods of operation which indicate the practical suitability of particular techniques for providing in principle the basis for emission limit values designed to prevent and, where that is not practicable, generally to reduce emissions and the impact on the environment as a whole.” Article 2(11) goes on to clarify further this definition as follows:

“techniques” includes both the technology used and the way in which the installation is designed, built, maintained, operated and decommissioned;

“available” techniques are those developed on a scale which allows implementation in the relevant industrial sector, under economically and technically viable conditions, taking into consideration the costs and advantages, whether or not the techniques are used or produced inside the Member State in question, as long as they are reasonably accessible to the operator;

“best” means most effective in achieving a high general level of protection of the environment as a whole.

Furthermore, Annex IV of the Directive contains a list of “considerations to be taken into account generally or in specific cases when determining best available techniques ... bearing in mind the likely costs and benefits of a measure and the principles of precaution and prevention”. These considerations include the information published by the Commission pursuant to Article 16(2).

Competent authorities responsible for issuing permits are required to take account of the general principles set out in Article 3 when determining the conditions of the permit. These conditions must include emission limit values, supplemented or replaced where appropriate by equivalent parameters or technical measures. According to Article 9(4) of the Directive, these emission limit values, equivalent parameters and technical measures must, without prejudice to compliance with environmental quality standards, be based on the best available techniques, without prescribing the use of any technique or specific technology, but taking into account the technical characteristics of the installation concerned, its geographical location and the local environmental conditions. In all circumstances, the conditions of the permit must include provisions on the minimisation of long-distance or transboundary pollution and must ensure a high level of protection for the environment as a whole.

Member States have the obligation, according to Article 11 of the Directive, to ensure that competent authorities follow or are informed of developments in best available techniques.

3. Objective of this document

Article 16(2) of the Directive requires the Commission to organise “an exchange of information between Member States and the industries concerned on best available techniques, associated monitoring and developments in them”, and to publish the results of the exchange.

The purpose of the information exchange is given in recital 25 of the Directive, which states that “the development and exchange of information at Community level about best available techniques will help to redress the technological imbalances in the Community, will promote the worldwide dissemination of limit values and techniques used in the Community and will help the Member States in the efficient implementation of this Directive.”

The Commission (Environment DG) established an information exchange forum (IEF) to assist the work under Article 16(2) and a number of technical working groups have been established under the umbrella of the IEF. Both IEF and the technical working groups include representation from Member States and industry as required in Article 16(2).

The aim of this series of documents is to reflect accurately the exchange of information which has taken place as required by Article 16(2) and to provide reference information for the permitting authority to take into account when determining permit conditions. By providing relevant information concerning best available techniques, these documents should act as valuable tools to drive environmental performance.

4. Information Sources

This document represents a summary of information collected from a number of sources, including in particular the expertise of the groups established to assist the Commission in its work, and verified by the Commission services. All contributions are gratefully acknowledged.

5. How to understand and use this document

The information provided in this document is intended to be used as an input to the determination of BAT in specific cases. When determining BAT and setting BAT-based permit conditions, account should always be taken of the overall goal to achieve a high level of protection for the environment as a whole.

The rest of this section describes the type of information that is provided in each section of this document.

Chapter 1 provides general information on the industrial sector concerned. Chapter 2 provides general information about processes and techniques used in the sector. Chapters 3 through to 11 provide general information, information on the industrial processes used and data and information concerning current emission and consumption levels reflecting the situation in existing installations at the time of writing for specific polymers and polymer groups.

Chapter 12 describes in more detail the emission reduction and other techniques that are considered to be most relevant for determining BAT and BAT-based permit conditions. This information includes the consumption and emission levels considered achievable by using the technique, some idea of the costs and the cross-media issues associated with the technique, and the extent to which the technique is applicable to the range of installations requiring IPPC permits, for example new, existing, large or small installations. Techniques that are generally seen as obsolete are not included.

Chapter 13 presents the techniques and the emission and consumption levels that are considered to be compatible with BAT in a general sense. The purpose is thus to provide general indications regarding the emission and consumption levels that can be considered as an appropriate reference point to assist in the determination of BAT-based permit conditions or for the establishment of general binding rules under Article 9(8). It should be stressed, however, that this document does not propose emission limit values. The determination of appropriate permit conditions will involve taking account of local, site-specific factors such as the technical characteristics of the installation concerned, its geographical location and the local environmental conditions. In the case of existing installations, the economic and technical viability of upgrading them also needs to be taken into account. Even the single objective of ensuring a high level of protection for the environment as a whole will often involve making trade-off judgements between different types of environmental impact, and these judgements will often be influenced by local considerations.

Although an attempt is made to address some of these issues, it is not possible for them to be considered fully in this document. The techniques and levels presented in Chapter 11 will therefore not necessarily be appropriate for all installations. On the other hand, the obligation to ensure a high level of environmental protection including the minimisation of long-distance or transboundary pollution implies that permit conditions cannot be set on the basis of purely local considerations. It is therefore of the utmost importance that the information contained in this document is fully taken into account by permitting authorities.

Since the best available techniques change over time, this document will be reviewed and updated as appropriate. All comments and suggestions should be made to the European IPPC Bureau at the Institute for Prospective Technological Studies at the following address:

Edificio Expo, c/ Inca Garcilaso, s/n, E-41092 Sevilla, Spain
Telephone: +34 95 4488 284
Fax: +34 95 4488 426
e-mail: JRC-IPTS-EIPPCB@ec.europa.eu
Internet: <http://eippcb.jrc.es>

Best Available Techniques Reference Document in the Production of Polymers

EXECUTIVE SUMMARY	I
PREFACE	XI
SCOPE	XXIII
1 GENERAL INFORMATION ON THE PRODUCTION OF POLYMERS	1
1.1 Definition	1
1.2 Structure	1
1.3 Properties	4
1.3.1 General properties	4
1.3.2 Thermal properties	4
1.4 Main uses	5
1.4.1 Fields of application	5
1.4.2 Processing technologies	6
1.5 Main products	6
1.5.1 Polymers based on crude oil	6
1.5.2 Polymers based on renewable resources	8
1.5.3 Biodegradable polymers	8
1.6 Production and market	9
1.6.1 General	9
1.6.2 Germany	14
1.6.3 France	16
1.6.4 Spain	18
1.6.5 Belgium	20
2 GENERAL PROCESSES AND TECHNIQUES APPLIED IN THE PRODUCTION OF POLYMERS	21
2.1 Raw materials and raw material requirements	21
2.2 Energy	22
2.3 Chemical reactions	22
2.3.1 Polymerisation (chain growth reaction)	23
2.3.2 Polycondensation (step growth reaction)	25
2.3.3 Polyaddition	26
2.4 Production processes	26
2.4.1 Suspension polymerisation	26
2.4.2 Bulk polymerisation	27
2.4.3 Emulsion polymerisation	28
2.4.4 Gas phase polymerisation	29
2.4.5 Solution polymerisation	29
2.4.6 Summary of processes	30
3 POLYOLEFINS	31
3.1 General information	31
3.1.1 Polyethylene	31
3.1.2 Polypropylene (PP)	34
3.2 Applied processes and techniques in the production of polyolefins	36
3.2.1 Alternative processes	36
3.2.2 Low density polyethylene	38
3.2.3 High density polyethylene	43
3.2.4 Linear low density polyethylene	50
3.2.5 Polypropylene	52
3.3 Current emission and consumption levels	61
3.3.1 Low density polyethylene (LDPE)	61
3.3.2 LDPE copolymers (ethylene-vinylacetate copolymer (EVA))	62
3.3.3 High density polyethylene (HDPE)	63
3.3.4 Linear low density polyethylene (LLDPE)	65
3.3.5 Polypropylene (PP)	66
3.3.6 Economic parameters for the production of polyethylene	67
4 POLYSTYRENE	69

4.1	General information	69
4.1.1	General purpose polystyrene (GPPS)	70
4.1.2	High impact polystyrene (HIPS)	70
4.1.3	Expandable polystyrene (EPS)	71
4.2	Applied processes and techniques in the production of polystyrene	72
4.2.1	Process overview	72
4.2.2	General purpose polystyrene (GPPS) process	75
4.2.3	High impact polystyrene (HIPS) process	78
4.2.4	Expandable polystyrene (EPS) process	81
4.3	Current emission and consumption levels	84
4.3.1	General purpose polystyrene (GPPS)	84
4.3.2	High impact polystyrene (HIPS)	86
4.3.3	Expandable polystyrene (EPS)	88
5	POLYVINYL CHLORIDE	91
5.1	General information	91
5.2	Applied processes and techniques in the production of polyvinyl chloride	94
5.2.1	Raw materials	94
5.2.2	VCM supply, storage and unloading	94
5.2.3	Polymerisation	95
5.2.4	Stripping	98
5.2.5	Drying	99
5.2.6	Sieving and grinding	99
5.2.7	VCM recovery	100
5.2.8	Water treatment	100
5.3	Current emission and consumption levels	101
5.3.1	Industry standards	101
5.3.2	Emissions	102
5.3.3	Energy consumption	103
5.3.4	Emission data from an example S-PVC plant	103
6	UNSATURATED POLYESTER	105
6.1	General information	105
6.2	Applied processes and techniques in the production of unsaturated polyesters	107
6.2.1	Raw materials	107
6.2.2	Process safety hazard issues	109
6.2.3	Plant layout and operation	109
6.2.4	Storage	110
6.2.5	Polycondensation	110
6.2.6	Curing	114
6.3	Current emission and consumption levels	115
6.3.1	Emission and consumption data from example plants	117
6.3.2	Sources of environmental impact	117
7	EMULSION POLYMERISED STYRENE BUTADIENE RUBBER.....	119
7.1	General information	119
7.2	Applied processes and techniques in the production of emulsion styrene butadiene rubber	122
7.2.1	Preparation of rubber bales	123
7.2.2	Oil extension	124
7.2.3	ESBR latex	124
7.2.4	Technical parameters	125
7.3	Current emission and consumption levels	126
8	SOLUTION POLYMERISED RUBBER CONTAINING BUTADIENE.....	127
8.1	General Information	127
8.1.1	Polybutadiene (butadiene rubber, BR)	128
8.1.2	Solution styrene butadiene rubber (SSBR)	129
8.1.3	Styrenic block copolymers (SBC)	130
8.2	Applied processes and techniques	131
8.2.1	Purification section	132
8.2.2	Polymerisation section	132
8.2.3	Hydrogenation section	132
8.2.4	Blending section	133
8.2.5	Solvent removal and recovery	133
8.2.6	Technical parameters for typical solution plants	135

8.3	Current emission and consumption levels.....	136
9	POLYAMIDES	137
9.1	General information	137
9.2	Applied processes and techniques in the production of polyamides	139
9.2.1	Polyamide 6	139
9.2.2	Polyamide 66	142
9.2.3	Spinning techniques	146
9.3	Current emission and consumption levels.....	151
9.3.1	Production of polyamides	151
9.3.2	Spinning of polyamides	151
9.3.3	Potential sources of pollution in polyamide processes.....	151
10	POLYETHYLENE TEREPHTHALATE FIBRES.....	159
10.1	General information	159
10.2	Applied processes and techniques in the production of PET fibres	161
10.2.1	Continuous polycondensation based on dimethyl terephthalic acid (DMT)	161
10.2.2	Continuous polycondensation based on terephthalic acid (TPA).....	162
10.2.3	Continuous solid state post condensation.....	163
10.2.4	Batch solid state post condensation.....	164
10.2.5	Batch polycondensation based on DMT	166
10.2.6	Production of spinning chips.....	167
10.2.7	Production of staple fibres	167
10.2.8	Production of filament yarns.....	168
10.3	Current emission and consumption levels.....	170
10.3.1	Continuous polycondensation based on DMT, TPA and batch DMT-BPU processes	170
10.3.2	Post condensation processes	171
10.3.3	PET processing	171
11	PRODUCTION OF VISCOSE FIBRES.....	173
11.1	General information	173
11.2	Applied processes and techniques in the production of viscose fibres.....	174
11.2.1	Processes and products.....	174
11.2.2	Production of staple fibres	176
11.2.3	Production of filament yarns.....	178
11.2.4	Lyocell fibres	179
11.3	Current emission and consumption levels.....	181
12	TECHNIQUES TO CONSIDER IN THE DETERMINATION OF BAT FOR THE PRODUCTION OF POLYMERS.....	183
12.1	Generic techniques	184
12.1.1	Environmental management tools.....	184
12.1.2	Equipment design.....	191
12.1.3	Fugitive loss assessment and measurement	193
12.1.4	Equipment monitoring and maintenance.....	194
12.1.5	Reduction of dust emissions.....	195
12.1.6	Minimisation of plant stops and start-ups	196
12.1.7	Containment systems	196
12.1.8	Water pollution prevention	197
12.1.9	Post treatment of air purge flows coming from the finishing section and reactor vents	198
12.1.10	Flaring systems and minimisation of flared streams.....	200
12.1.11	Use of power and steam from cogeneration plants	201
12.1.12	Recovery of exothermic reaction heat through generation of low pressure steam.....	202
12.1.13	Use of a gear pump instead of or in combination with an extruder.....	203
12.1.14	Compounding extrusion	204
12.1.15	Re-use of waste	205
12.1.16	Pigging systems	206
12.1.17	Waste water buffer	207
12.1.18	Waste water treatment.....	208
12.2	PE techniques	210
12.2.1	Recovery of monomers from reciprocating compressors.....	210
12.2.2	Collecting the off-gases from extruders.....	211
12.2.3	Emissions from finishing and product storage sections	211

12.2.4	Increase of the polymer concentration in the reactor system to the maximum possible	219
12.2.5	Delivery of the product in the original particle shape	220
12.2.6	Closed loop cooling water systems	221
12.3	PS techniques	222
12.3.1	GPPS	222
12.3.2	HIPS	223
12.3.3	EPS	224
12.4	PVC techniques	225
12.4.1	Prevention of emissions from storage facilities	225
12.4.2	Prevention of emissions from VCM unloading facilities	226
12.4.3	Prevention of emissions from polymerisation	227
12.4.4	Degassing	228
12.4.5	Prevention of dust emissions from drying	229
12.4.6	Treatment of exhaust gases from the recovery system	230
12.4.7	Prevention and control of fugitive VCM emissions	231
12.4.8	Prevention of accidental emissions of VCM	232
12.5	UP techniques	234
12.5.1	Technologies for the treatment of gaseous waste	234
12.5.2	Thermal treatment of waste water	235
12.5.3	Biological treatment of waste water	236
12.6	ESBR techniques	237
12.6.1	Storage	238
12.7	Viscose fibre techniques	239
12.7.1	Housing of spinning frames	239
12.7.2	Recovery of CS ₂ through condensation	240
12.7.3	Recovery of CS ₂ through adsorption on activated carbon	241
12.7.4	Desulphurisation with H ₂ SO ₄ – production	243
12.7.5	Recovery of sulphate from spinning baths	245
12.7.6	Treatment of waste water streams containing ZnSO ₄	246
12.7.7	Anaerobic sulphate reduction	247
12.7.8	Treatment of non-hazardous waste	248
12.7.9	Biological waste water treatment	249
13	BEST AVAILABLE TECHNIQUES	251
13.1	Generic BAT	254
13.2	BAT for the production of polyolefins	258
13.3	BAT for the production of polystyrene	262
13.4	BAT for the production of PVC	266
13.5	BAT for the production of unsaturated polyester	269
13.6	BAT for the production of ESBR	270
13.7	BAT for the production of solution polymerised rubbers containing butadiene	272
13.8	BAT for the production of polyamides	273
13.9	BAT for the production of polyethylene terephthalate fibres	274
13.10	BAT for the production of viscose fibres	275
14	EMERGING TECHNIQUES	277
14.1	Catalytic heat regenerative process for H ₂ SO ₄ recovery in viscose fibre production	277
15	CONCLUDING REMARKS	279
	REFERENCES	281
	GLOSSARY	283
	ANNEXES	289

List of figures

Figure 1.1: Basic structures of polymers.....	1
Figure 1.2: Chemical composition of linear AB copolymers.....	2
Figure 1.3: Composition of a graft copolymer.....	2
Figure 1.4: Normalised molar mass distribution curves of two different polyethylene samples.....	3
Figure 1.5: Main uses for polymers in 2003.....	5
Figure 1.6: Classification of thermoplastic polymers.....	7
Figure 1.7: Growth of polymer production compared with steel and aluminium.....	9
Figure 1.8: Yearly polymer consumption per capita in the EU-15.....	9
Figure 1.9: Development and tendency of margins for commodity polymers (e.g. polypropylene).....	12
Figure 1.10: Development of margins for engineering plastics (e.g. PBT, POM, and PA).....	13
Figure 1.11: Share from the GDP of the Spanish chemical industry.....	18
Figure 2.1: General production scheme.....	21
Figure 2.2: Polymerisation by the opening of a double bond (e.g. ethylene).....	23
Figure 2.3: Energy curve of homopolymerisation.....	24
Figure 2.4: Schematic view of a polycondensation reaction.....	25
Figure 2.5: Schematic view of a polyaddition reaction.....	26
Figure 3.1: Molecular structure of LDPE.....	32
Figure 3.2: Molecular structure of HDPE.....	33
Figure 3.3: Molar mass distributions of HDPE.....	33
Figure 3.4: Molecular structure of LLDPE.....	34
Figure 3.5: Base unit of polypropylene.....	34
Figure 3.6: Molecular structures of polypropylene.....	35
Figure 3.7: Flow diagram showing LDPE production.....	40
Figure 3.8: Flow diagram of an HDPE STR.....	45
Figure 3.9: Flow diagram of an HDPE loop.....	47
Figure 3.10: Flow diagram showing the HDPE gas phase process.....	48
Figure 3.11: Flow diagram showing the HDPE suspension/gas phase process.....	49
Figure 3.12: Flow diagram showing the LLDPE solution process.....	51
Figure 3.13: Generic flow diagram showing the traditional suspension ('slurry') process.....	54
Figure 3.14: Flow diagram of the Spheripol polypropylene process.....	55
Figure 3.15: Flow diagram of the polypropylene fluidised bed gas phase process.....	58
Figure 3.16: Flow diagram of the polypropylene vertical reactor gas phase process.....	59
Figure 3.17: Flow diagram of the polypropylene horizontal reactor gas phase process.....	60
Figure 3.18: Interpretation scheme for emission and consumption data in this section.....	61
Figure 4.1: Molecular structure of polystyrene.....	69
Figure 4.2: Molecular structure of high impact polystyrene.....	70
Figure 4.3: Chain propagation in the polystyrene process.....	73
Figure 4.4: Flow diagram showing the GPPS process.....	75
Figure 4.5: Flow diagram showing the HIPS process.....	79
Figure 4.6: Flow diagram showing the EPS process.....	81
Figure 5.1: Flow diagram of an S-PVC process.....	96
Figure 5.2: Flow diagram of an E-PVC process.....	97
Figure 6.1: Basic condensation reaction scheme for producing unsaturated polyester resins.....	105
Figure 6.2: Flow diagram of the UP production process.....	109
Figure 7.1: Production share of synthetic rubbers.....	119
Figure 7.2: Main applications of ESBR.....	121
Figure 7.3: Flow diagram of the ESBR production process.....	122
Figure 8.1: Principal flow scheme – solution polymerisation.....	131
Figure 9.1: Basic reaction of AB type polyamides.....	137
Figure 9.2: Basic reaction of AA-BB type polyamides.....	138
Figure 9.3: Main applications for polyamides.....	138
Figure 9.4: Flow diagram of the continuous PA 6 process.....	140
Figure 9.5: Flow diagram of discontinuous PA 6 process.....	141
Figure 9.6: Flow diagram of the salt concentration process for PA 66 production.....	143
Figure 9.7: Flow diagram of continuous PA 66 process.....	144
Figure 9.8: Flow diagram of the batch PA 66 polycondensation process.....	146
Figure 9.9: Flow diagram of the spinning process for textile yarns.....	148
Figure 9.10: Flow chart of the spinning process for technical yarns.....	149
Figure 9.11: Flow diagram of the processing of staple fibres.....	150
Figure 9.12: Flow chart of processing of BCF yarns.....	150
Figure 10.1: Basic reaction of ethylene glycol with terephthalic acid.....	159

Figure 10.2: Flow chart of the PET DMT process.....	162
Figure 10.3: Flow chart of the PET TPA process	162
Figure 10.4: Flow diagram of continuous solid state polymerisation	164
Figure 10.5: Schematic view of the batch solid state process.....	165
Figure 10.6: Flow diagram of the DMT-BPU process.....	166
Figure 10.7: Flow diagram of the production of spinning chips.....	167
Figure 10.8: Flow diagram of the spinning of staple fibres	168
Figure 10.9: Flow diagram of the finishing of staple fibres.....	168
Figure 10.10: Flow chart of the production of filament yarns	169
Figure 11.1: Flow diagram of viscose fibre production process	175
Figure 11.2: Flow diagram of the Lyocell process	180
Figure 12.1: Schematic view of a gear pump.....	203
Figure 12.2: Schematic view of the condensation of CS ₂ from viscose fibre production.....	240
Figure 12.3: Schematic view of biological waste water treatment	249
Figure 14.1: Desulphurisation and H ₂ SO ₄ production with double catalysis.....	277

List of tables

Table 1.1: Thermoplastics and thermosets consumption for Western Europe for 2001, 2002 and 2003 ...	10
Table 1.2: Plastic processors' consumption by country, new Member States and new accession countries, 2003	11
Table 1.3: Polymer consumption in New Member States and accession countries by type of plastic	11
Table 1.4: Raw material costs 1993 - 1999	12
Table 1.5: Commodity production for EU-25 + Norway + Switzerland	12
Table 1.6: Production capacity for commodity plastics in 2003 for Western Europe	13
Table 1.7: Structure of the German polymer industry in 1998	14
Table 1.8: German commodity polymer production in 2003	14
Table 1.9: Number of German producers for commodity polymers	15
Table 1.10: Key economic figures of the French polymer production industry in 2000	16
Table 1.11: Basic data from the French polymer industry in 2000	17
Table 1.12: Production data from the Spanish polymer industry in 2002	19
Table 1.13: Belgian main polymer production data (capacities in 2003)	20
Table 2.1: Dependency of the degree of polymerisation on the conversion rate in a step growth reaction	25
Table 2.2: Product – process matrix for some polymers	30
Table 3.1: Growth of polyethylene consumption	31
Table 3.2: Main Western European polyethylene production sites in 2001	32
Table 3.3: Western European polypropylene production 2000 – 2002	34
Table 3.4: Technical parameters of LDPE	42
Table 3.5: Process overview HDPE	43
Table 3.6: Technical parameters of HDPE	50
Table 3.7: Technical parameters of LLDPE	51
Table 3.8: Technical parameters of PP	60
Table 3.9: Emission and consumption data of LDPE plants	62
Table 3.10: Emission and consumption data per tonne of EVA copolymer	63
Table 3.11: Emission and consumption data of HDPE plants	64
Table 3.12: Emission data of HDPE plants in Germany	64
Table 3.13: Emission and consumption data of LLDPE plants	65
Table 3.14: Economic parameters of polyethylene production	67
Table 4.1: Development of worldwide polystyrene usage in Mt/yr	69
Table 4.2: PS (GPPS + HIPS) producers in EU-15 in 2000	71
Table 4.3: EPS producers in the EU-15 in 2000	71
Table 4.4: Technical parameters of GPPS	76
Table 4.5: Summary of the GPPS process	77
Table 4.6: Technical parameters of HIPS	79
Table 4.7: Summary of the HIPS process	80
Table 4.8: Technical parameters of EPS	82
Table 4.9: Summary of the EPS process	83
Table 4.10: Emission and consumption data per tonne of product from GPPS plants	84
Table 4.11: Sources of emissions in the GPPS process	85
Table 4.12: Emission and consumption data per tonne of product of HIPS plants	86
Table 4.13: Sources of emissions in the HIPS process	87
Table 4.14: Emission and consumption data per tonne of product from EPS plants	88
Table 4.15: Sources of emissions in the EPS process	89
Table 5.1: Western European PVC production	92
Table 5.2: European production sites and capacities in kilotonnes for the year 1999	93
Table 5.3: Typical features of E-PVC processes	98
Table 5.4: VCM emissions according to OSPAR and ECVM	101
Table 5.5: Emission data from S-PVC in g/tonne as submitted by ECVM	102
Table 5.6: Dust and VCM emissions from German S-PVC reference plants	102
Table 5.7: Emission data from E-PVC in g/tonne as submitted by ECVM	102
Table 5.8: Dust and VCM emissions from German E-PVC reference plants	103
Table 5.9: Typical energy consumption of PVC processes	103
Table 5.10: Consumption data from the S-PVC plant	103
Table 5.11: VCM emissions from different sources	103
Table 5.12: Emissions to water from the S-PVC plant	104
Table 6.1: Western European UP production 2000 - 2002	106
Table 6.2: UP producing sites in Europe	106
Table 6.3: Raw material overview of UP production processes	107
Table 6.4: Current maximum emission and consumption levels	115

Table 6.5: Good practice industry values for emission and consumption levels	116
Table 6.6: Energy and water consumption data for UP plants.....	117
Table 6.7: Emission data for UP plants	117
Table 7.1: European ESBR producers, locations and capacity	120
Table 7.2: Technical parameters of the ESBR process.....	125
Table 7.3: Emission and consumption data from ESBR plants (per tonne of product)	126
Table 8.1: production volume share of the major types of synthetic rubber.....	127
Table 8.2: Companies and capacities of the 15 plants in Europe producing solution rubber.....	128
Table 8.3 Technical parameters for typical solution plants	135
Table 8.4. Emission levels reported from 16 plants within the EU	136
Table 9.1: Western European polyamide production 2000 - 2002	138
Table 9.2: Waste water data from the manufacture of polyamide	152
Table 9.3: Emissions and consumptions from polyamide production processes	154
Table 9.4: Emissions and consumptions from polyamide processing	155
Table 9.5: Emission and consumption data from the continuous PA6 production process	156
Table 9.6: Emission and consumption data from the batch PA6 production process	156
Table 9.7: Emission and consumption data from the continuous PA66 production process	156
Table 9.8: Emission and consumption data from the batch PA66 production process	157
Table 9.9: Emission and consumption data from the textile yarn process.....	157
Table 9.10: Emission and consumption data from the BCF PA yarns and staple fibres processes.....	158
Table 10.1: European PET production 2000 - 2002	159
Table 10.2: Technical parameters of continuous solid state post condensation.....	164
Table 10.3: Technical parameters of batch solid state post condensation.....	165
Table 10.4: Emission and consumption data of PET producing processes.....	170
Table 10.5: Emission and consumption data of post condensation processes	171
Table 10.6: Emission and consumption data of PET processing techniques	171
Table 11.1: Emission and consumption data for viscose staple fibre production	181
Table 11.2: Emission and consumption data for viscose filament yarn production.....	182
Table 12.1: Information breakdown for each technique as described in this chapter	183
Table 12.2: Cost factors for equipment design	192
Table 12.3: Cost situation for the implementation of a new pump	192
Table 12.4: Efficiency and cross-media effects of VOC treatment techniques	198
Table 12.5: Energy efficiency of cogeneration systems of different size	202
Table 12.6: Comparison of costs for a conventional system and pigging pipeline system.....	207
Table 12.7: Monomer content in EVA copolymer with and without the use of devolatilisation equipment	217
Table 12.8: Operational costs per tonne of homopolymer product (2 MFI) with (B) and without (A) devolatilisation extrusion	217
Table 12.9: Rating scheme for emission reduction techniques in PS processes	222
Table 12.10: Techniques used in GPPS processes.....	222
Table 12.11: Techniques used in HIPS processes.....	223
Table 12.12: Techniques used in EPS processes	224
Table 12.13: Techniques used in ESBR processes	237
Table 13.1: How to combine the BAT described in this chapter for the different polymers	253
Table 13.2: BAT associated emission and consumption levels (BAT AEL) for the production of LDPE	259
Table 13.3: BAT associated emission and consumption levels (BAT AEL) for the production of LDPE copolymers.	260
Table 13.4: BAT associated emission and consumption levels (BAT AEL) for the production of HDPE	260
Table 13.5: BAT associated emission and consumption levels (BAT AEL) for the production of LLDPE	261
Table 13.6: BAT associated emission and consumption levels (BAT AEL) for the production of GPPS.....	263
Table 13.7: BAT associated emission and consumption levels (BAT AEL) for the production of HIPS	264
Table 13.8: BAT associated emission and consumption levels (BAT AEL) for the production of EPS	265
Table 13.9: BAT associated emission and consumption levels for the production of PVC.....	268
Table 13.10: Split view – VCM emissions related to BAT techniques	268
Table 13.11: BAT associated emission and consumption levels for the production of UP	269
Table 13.12: BAT associated emission and consumption levels for the production of ESBR per tonne of product	271
Table 13.13: BAT associated emission and consumption levels for the production of viscose staple fibres	276
Table 15.1: Timing of the work for this document.....	279

SCOPE

In Annex I to the IPPC Directive, the categories of industrial activities referred to in Article 1 of the Directive are defined. Section 4 of Annex I addresses the chemical industry. This document focuses on the production of polymeric materials in plants on an industrial scale. Specifically, this document addresses parts of the following sections from Annex 1 to the IPPC Directive:

- 4.1. Chemical installations for the production of basic organic chemicals, such as:
- (a) basic plastic materials (polymers, synthetic fibres and cellulose-based fibres)
 - (b) synthetic rubbers
 - (c) oxygen-containing hydrocarbons such as alcohols, aldehydes, ketones, carboxylic acids, esters, acetates, ethers, peroxides, epoxy resins.

The scope covers an enormous variety of produced substances. Therefore, this document describes the production of polymers selected according to production volume and potential environmental impact of their manufacture as well as availability of data, and deals with environmentally relevant unit processes and unit operations, along with the usual infrastructure found at a typical site. The present document cannot, and is not intended to replace the chemical textbooks on ‘green chemistry’ and indeed it gives only general guidance for the early stages of process design – but deals mainly with process modifications, plant operation and maintenance and especially with the management of unavoidable waste streams.

The further processing of polymers to produce final products is not included in the scope of this document. However, processing techniques such as the production of fibres or compounding are included when they are technically connected to the production of the polymer and carried out on the same site, and when they have an effect on environmental impact of the installation.

The treatment of waste gas and waste water is also a subject included in this document, where sector specific conditions require this – but more in terms of applicability and performance in the polymer sectors than in terms of the technical description of individual treatment techniques. On this subject, the reader may find useful information in the BREF on ‘Common waste gas and waste water treatment/management systems in the chemical sector’.

1 GENERAL INFORMATION ON THE PRODUCTION OF POLYMERS

[1, APME, 2002, 16, Stuttgart-University, 2000]

The most important specific terms and abbreviations used in this document can be found in the glossary at the end.

1.1 Definition

Polymers – from Greek ‘poly’ (many) and ‘meros’ (parts) – are a group of chemical products which have a common building principle. They consist of so-called macromolecules which are long chain molecules, containing large numbers of smaller constitutional repeating units. Molecules consisting of a small number of monomers often are called ‘oligomers’ which means ‘some parts’.

There are different types of polymers: natural polymers (for example wool, silk, wood, cotton), half synthetic polymers (natural polymers which are chemically modified, for example casein plastics, cellulose plastics) and synthetic polymers [27, TWGComments, 2004].

Monomers which mostly belong to the group of large volume organic products are nowadays usually produced from petrochemical feedstock (crude oil or gas). Exemptions are the cellulosic materials which are produced from cotton or wood fibres or biodegradable products produced from renewable raw materials.

1.2 Structure

Macromolecules can be linear or branched (containing sidechains) and may be cross-linked, linking one chain with another. Examples of these three types of macromolecules are shown in Figure 1.1.

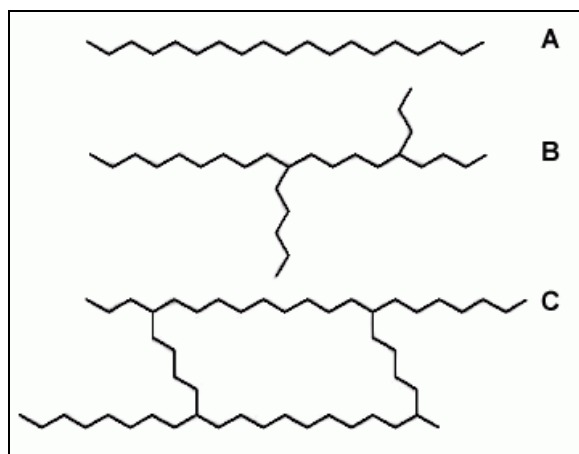

Figure 1.1: Basic structures of polymers

- A) linear polymer
- B) branched polymer
- C) cross-linked polymer

Polymers can be composed from just one type of monomer (homopolymer) or from different types (copolymer). In the case of a linear copolymer consisting of two different monomers (e.g. A and B), the different monomers can basically be arranged in three different ways:

- random copolymer: there is no regularity in the arrangement of the two different monomers in the polymer
- block copolymer: blocks of pure A oligomer alternate with blocks of pure B oligomer
- alternating copolymer: the monomers A and B alternate within the composition of the polymer.

The composition and arrangement of the different monomers in a copolymer strongly influences its physico-chemical properties. Figure 1.2 shows the structure of a linear homopolymer and the three types of linear copolymer mentioned above.

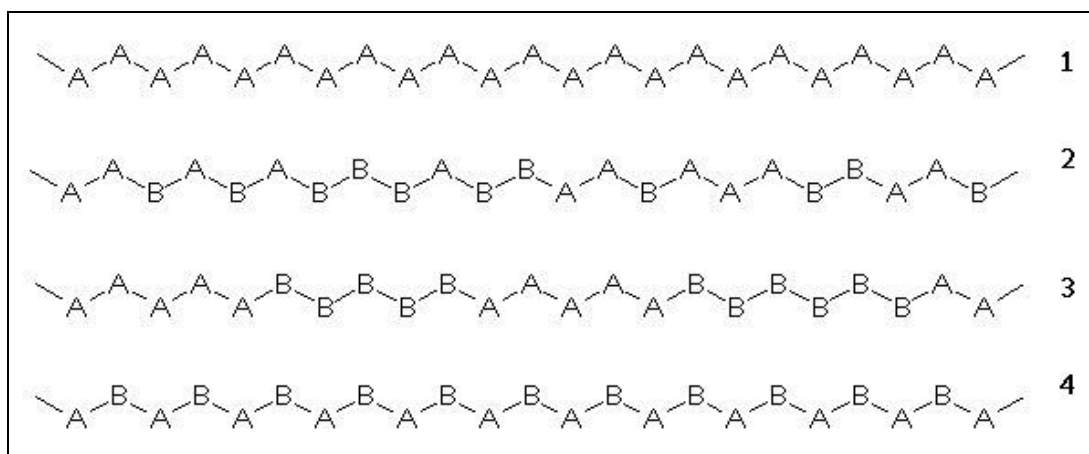

Figure 1.2: Chemical composition of linear AB copolymers.

- 1) homopolymer
- 2) random copolymer
- 3) block copolymer
- 4) alternating copolymer

Apart from the linear copolymers, branched copolymers can be produced by grafting sidechains (consisting of monomer B) onto an existing homopolymeric mainchain (consisting of monomer A) (Figure 1.3).

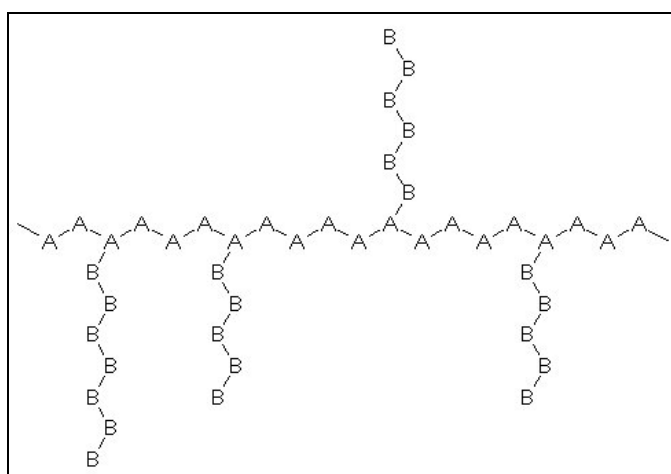

Figure 1.3: Composition of a graft copolymer

The polymerisation reactions are statistically driven processes. Therefore, unlike some natural polymers such as DNA, synthetic polymers always show, due to the reaction mechanisms involved in the production processes, a certain distribution of molar mass and not a distinct molecular weight. The molar mass of synthetic polymers can range from some thousand g/mol up to some million g/mol. As an example, Figure 1.4 shows the normalised molar mass distribution (MMD) curves of two different polyethylene samples.

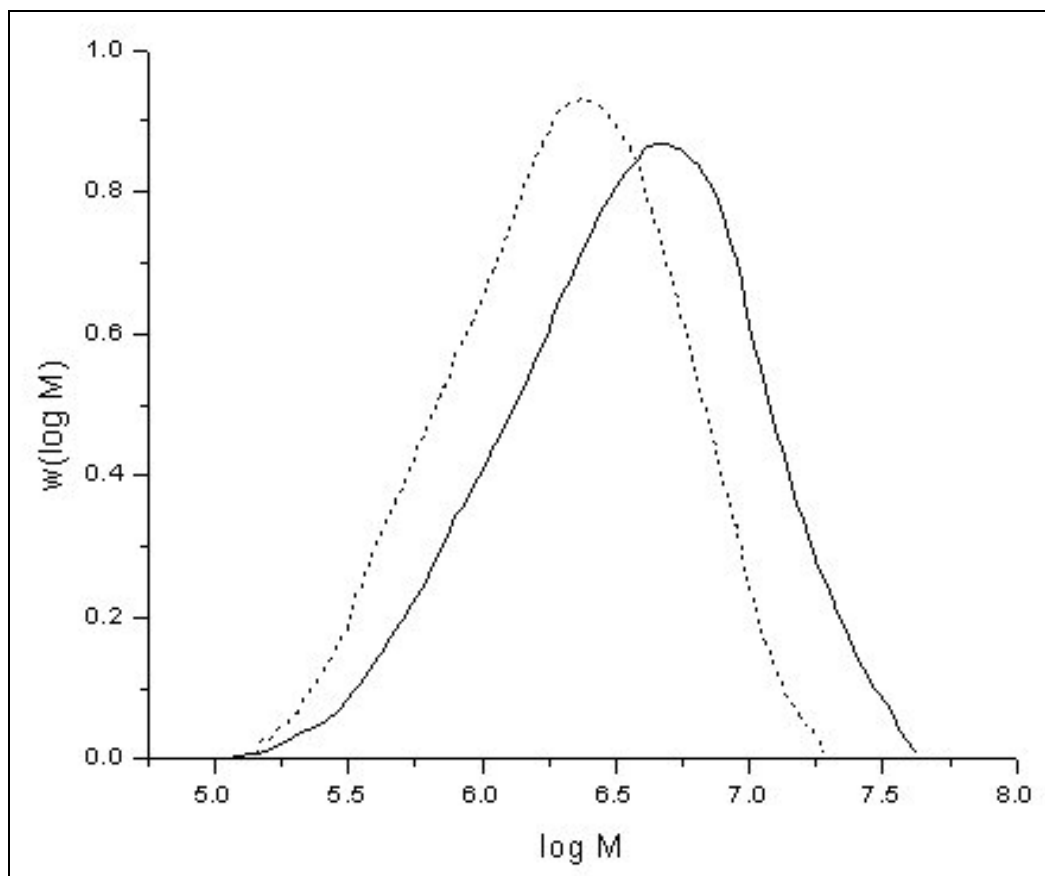

Figure 1.4: Normalised molar mass distribution curves of two different polyethylene samples [29, M. Parth, et al., 2003]

Apart from molar mass and chemical composition, the properties of a polymeric material can be influenced by the shape of the MMD. The samples shown in Figure 1.4 both show a unimodal MMD, but to achieve some special mechanical properties, in some cases it is necessary to produce polymers with bimodal or multimodal MMD, as in natural polymers such as natural rubber (NR). This can be achieved by two subsequent polymerisation steps.

1.3 Properties

1.3.1 General properties

The underlying building principle is very flexible so that polymers with an extensive range of properties and property combinations can be produced. Polymers in the shape of objects, fibres or films may be:

- rigid or flexible
- transparent, translucent or opaque
- hard or soft
- weather resistant or degradable
- resistant to either high or low temperature.

In addition, they may be compounded with fillers, blended with other products (e.g. glass fibres) forming so-called composites or with other polymers yielding polymer blends.

A certain polymer is usually not the only material which can be used in any given field of application. Alternative materials exist and polymers have to be successful in a competitive market. Polymers often bring advantages to numerous applications, for example:

- weight reductions and consequent transport and fuel savings
- electrical insulating properties suitable for wiring, switches, plugs, power tools and electronics
- optical transparency suitable for packaging, lighting and lens applications
- corrosion resistance which is important for plumbing, irrigation, rainwear and sports articles
- resistance to chemicals, fungi and mildew
- ease of processing making complicated shapes possible
- cost savings over alternative solutions.

1.3.2 Thermal properties

Usually, substances can exist in three possible physical states: solid, liquid and gas. In polymeric materials, things are not so straightforward. For example, most polymers will decompose before they boil, and cross-linked polymers decompose before they melt.

According to their basic thermal properties, four different types of polymers are distinguished.

1.3.2.1 Thermoplastics

Thermoplastics are polymeric materials, which are more or less rigid at room temperature and can be melted by heat.

1.3.2.2 Thermosets

Thermosets are also rigid at room temperature, but due to the cross-links in their molecular structure, they cannot be melted.

1.3.2.3 Rubbers or elastomers

Rubbers are flexible at room temperature. Most of them are amorphous materials and do not show a melting point. They have a glass transition point instead which is well below room temperature. Below this glass transition temperature they are rigid.

1.3.2.4 Thermoplastic elastomers

Thermoplastic elastomers are block copolymers or polymer blends that are flexible and show properties similar to vulcanised rubbers at room temperature, but which can be softened or melted by heat. This process is reversible, so the products can be reprocessed and remoulded.

1.4 Main uses

1.4.1 Fields of application

Polymeric materials are used in simple household items like plastic bags as well as in advanced optical or electronic components or in medical applications. The main fields of application for Western Europe are shown in Figure 1.5, which does not include data about elastomers and cellulosic fibres. For 2003, the total amount of consumed thermoplastics and thermosets in Western Europe was 48788 kilotonnes.

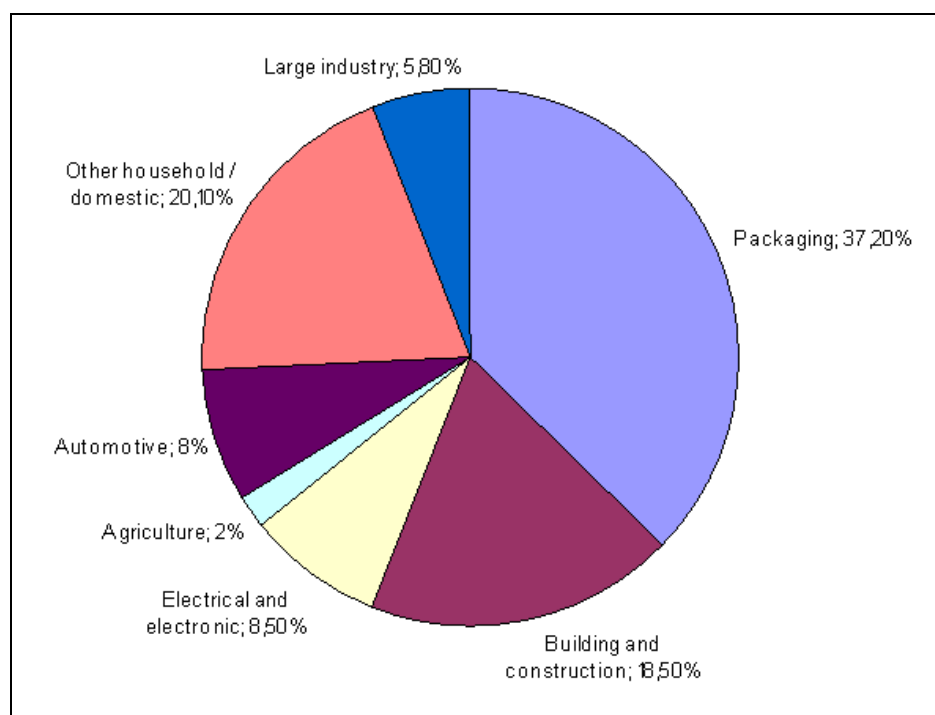

Figure 1.5: Main uses for polymers in 2003

1.4.2 Processing technologies

A range of processing technologies are used to convert raw polymers into the required shape of the final product. This conversion step is normally entirely separate from the manufacturing site of polymer pellets. The processing step itself is mainly a physical transformation step using different technologies such as:

- extrusion for pipes, profiles, sheets and cable insulation
- injection moulding for products of different, often very complex shapes like machine parts, electrical plugs and medical equipment such as syringes; thermoplastics and thermosets
- blow moulding for bottles, containers and films
- calendering for films and sheeting
- rotomoulding for large shapes
- pultrusion for rods, tubes, etc.
- blown film for thermoplastics
- cast film for thermoplastics
- coating for thin layers on different substrates
- pressing for resins
- spinning for fibres
- transfer moulding for thermosets
- compression moulding for thermosets
- vulcanisation for rubbers
- blending generally applicable technique.

Usually, chemical reactions do not occur during these processing steps, except during the vulcanisation of rubber, during the in-process cross-linking of certain types of cable insulations made from polyethylene and when processing certain resins with in-situ polymerisations. Such special processing steps are described in literature [14, Winnacker-Kuechler, 1982].

1.5 Main products

1.5.1 Polymers based on crude oil

Different market requirements have resulted in a wide range of polymeric materials which are grouped into:

structural materials where the polymer is the main and most visible structural component with the subgroups:

- commodity polymers (polyethylene, polypropylene, polystyrene, polyvinyl chloride, ESBR, etc.). Such polymers are used in large quantities at relatively low costs for major applications like tubes, films, profiles, containers, bottles, sheets, tyres, etc.
- engineering polymers and speciality rubbers (ABS, polyamides, polyesters, polyacetals, polymethyl methacrylates, EPDM, NBR, etc.). Such polymers are used for special requirements at an intermediate cost level often for very small parts (clips, valves, special machine parts, etc.)
- high performance products (polyimide, polytetrafluoroethylene, polysulfone, polyetherketone, fluorinated and silicone rubbers, etc.). Such low volume, high priced materials are used to meet extreme requirements like high temperature, weather or solvent resistance, special wear or optical properties, extreme purity for critical medical applications, etc.)

- thermosetting polymers (polyesters, epoxies, phenolics and alkyd resins) often used as coating resins and binders for fibrous reinforcements in a range of applications from boats to brake linings.

and **functional materials** where polymers are used as an aid to achieve a special function. They mostly constitute a small and often invisible part of the total system only with the following subgroups:

- commodity applications like dispersants, detergents, flocculants, thickeners, superabsorbers or adhesives and glues. Here, large volume polymers based on polyvinyl acetate, polyacrylic acid and its derivatives, and polyvinyl alcohol are used
- special technical applications like membranes, optical fibres, products with electrical conductivity, and light emitting products. Here, high priced materials are used in small amounts where the functionality, and not predominantly the mechanical properties, is important.

A classification of thermoplastic products (not including elastomers and thermosetting resins) is shown in Figure 1.6.

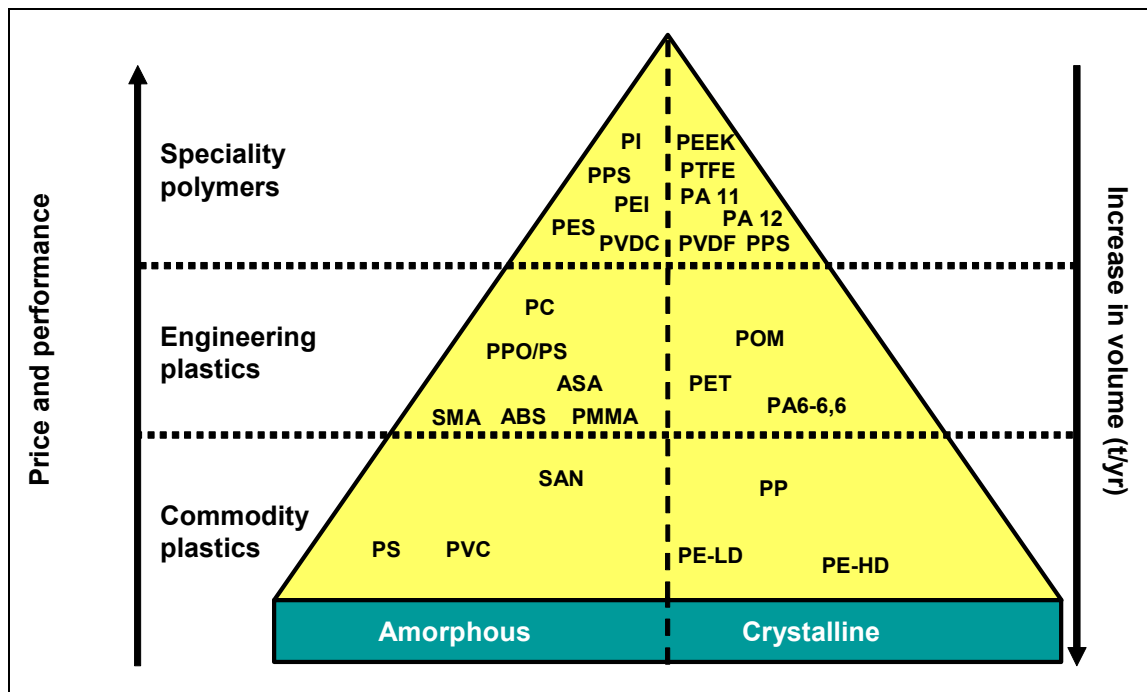

Figure 1.6: Classification of thermoplastic polymers

Generally, amorphous polymers have a disordered structure, have a softening point and are very often transparent, while crystalline polymers have an ordered structure, have a softening and a melting point and are mostly opaque.

Amongst the polymers based on crude oil, seven groups of polymers – polyolefins (PE and PP), polystyrene (PS), polyvinyl chloride (PVC), polyethylene terephthalate (PET), emulsion polymerised styrene butadiene rubber (ESBR), polyamides (PA) and unsaturated polyester resins (UP) constitute approximately 80 % of the total consumption of polymers.

Within each product group, there exists a wide variety of individual product grades optimised for the specific application (tailor-made).

For example:

- PE with good flow properties for injection moulding or, for instance, boxes or containers
- PE with excellent long-term stability for pipes
- PE with good blow moulding properties for petrol tanks in automobiles.

They are not interchangeable for these specific applications. Some have a low molecular weight; some have a high molecular weight, and while some have a narrow molecular weight distribution, others offer an extremely wide molecular weight distribution. The final mechanical, rheological and other physical properties depend on these parameters.

1.5.2 Polymers based on renewable resources

Historically, the first polymers were produced from renewable resources:

- fibres from cellulose (cotton) or derivatives (cellulose acetate)
- fibres from polypeptides (wool)
- plastics from cellulose acetate
- rubber from tree resin (polyisoprene).

While some of these products stayed competitive (rubbers, viscose fibres), others – especially in the field of thermoplastic material applications – did not, mainly for economic reasons or insufficient properties but sometimes also due to high environmental costs.

Newer attempts to develop wood-based plastics ('synthetic wood') remained limited to niche applications (laminates for flooring, boats, musical instruments).

Corn derived products (e.g. polylactic acid) and blend systems of starch and petrochemically produced polymers present new opportunities to use renewable resources as raw materials for plastics.

Generally, renewable raw materials can be used to produce either long-term living products like construction materials for automobiles, ships and for the building and construction sector, or short-term living products like compostable packaging or biodegradable mulch films.

1.5.3 Biodegradable polymers

The market for biodegradable materials is limited to niche applications. General politically motivated goals in the past, like substituting commodity products for environmental reasons, provoked several costly industrial developments over many years. Finally, some of them proved unrealistic since the alternatives failed in properties as well as in processability and economics and sometimes also due to an undefined environmental outcome.

This class of polymers is not described in this document because their production in the European Union currently does not represent a significant environmental impact.

Today, biodegradable products are developed for markets where biodegradability is considered a technical advantage like for instance:

- mulch film in agriculture
- garbage bags for composting which can provide easier handling and eco-efficient benefits for waste management
- paper coating
- hygiene films including funeral applications, sanitary towels.

Biodegradability does not depend on the origin of the raw materials but on the chemical structure. Thus, materials from renewable as well as from synthetic resources are on the market. While cellophane, starch and polyhydroxybutyrate have existed on the market for many years, newer developments include poly (L-lactide) as well as numerous fossil based biodegradable polymers, e.g. copolyesters.

A legal situation recognising organised composting as one means of recycling and a standardised testing of the degradation behaviour are important preconditions for their successful development.

The total market segment requiring biodegradability is currently estimated to be about 50 - 200 kt/yr in Western Europe. The actual consumption is around 8 kt/yr according to CEH Marketing Research Report in the Chemical Economics Handbook – SRI International 2000.

1.6 Production and market

1.6.1 General

In 2003, approximately 169 million tonnes of plastics are produced worldwide. Figure 1.7 shows the growth of plastic versus steel and aluminium.

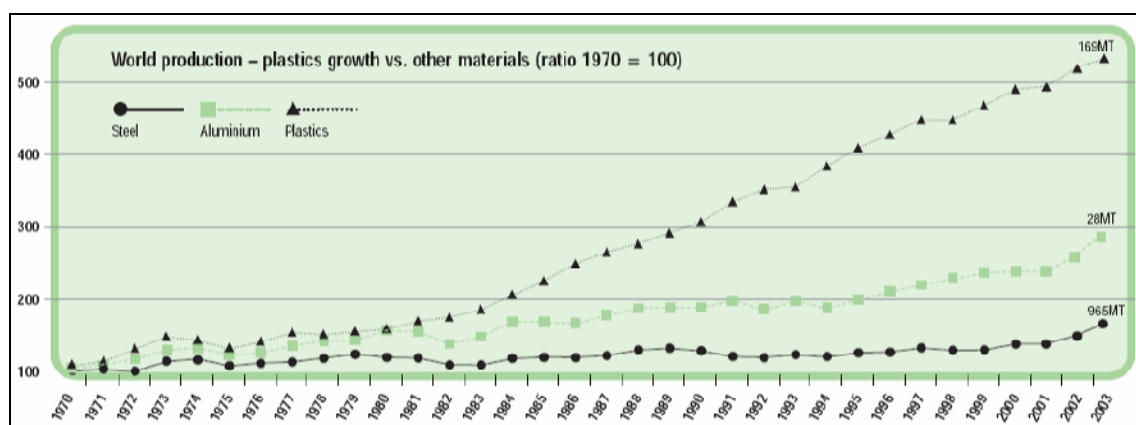

Figure 1.7: Growth of polymer production compared with steel and aluminium

The regional differences of structural polymers consumption within Western Europe (EU-15) are still quite high if the consumption/capita/year total is taken as a yardstick, and this is shown in Figure 1.8.

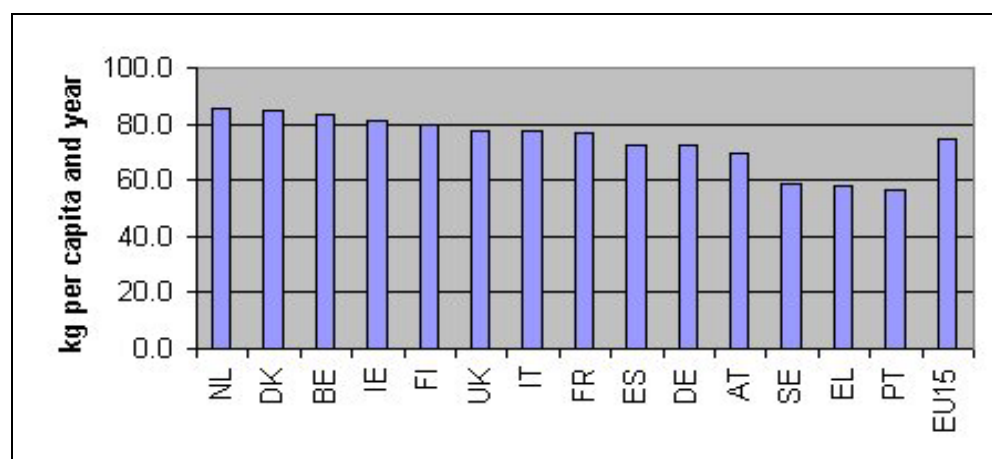

Figure 1.8: Yearly polymer consumption per capita in the EU-15

Generally, the polymer industry consists of polymer manufacturers, converters and machine manufacturers. Around 71200 people in EU-15 are employed in polymer manufacturing while the wider industry chain including machine manufacturers and converters, employs approximately 1.4 million people (2003).

Around 45 companies in EU-15 – mainly multinationals – produce the large volume thermoplastic materials which are sold to around 30000 small and medium sized companies which process the polymers into products for end use.

Table 1.1 shows the EU-15 consumption data for thermoplastics and thermosets and their relative share. The products discussed in this document cover about 80 % of the overall consumption of thermoplastics and thermosets.

Product/kilotonnes per year	2001	2002	2003	Share 2003
LDPE/LLDPE	7758	7996	8062	16.5 %
HDPE	5047	5348	5430	11.1 %
Subtotal PE	12805	13344	13492	27.6 %
PP	7247	7707	7879	16.1 %
PVC	5725	5748	5832	11.9 %
PET	3424	3678	3802	7.8 %
PS/EPS	3083	3118	3136	6.4 %
Polyamides	1305	1330	1328	2.7 %
Other thermoplastics	530	556	594	1.2 %
ABS/SAN	792	788	803	1.6 %
Acrylics	368	363	298	0.6 %
PMMA	302	317	327	0.7 %
Polycarbonates	411	446	471	1.0 %
Acetals	176	181	186	0.4 %
Subtotal thermoplastics	36168	37576	38148	78.2 %
Amino	2664	2615	2630	5.4 %
Polyurethanes	2493	2575	2672	5.5 %
Phenolics	1001	976	980	2.0 %
Unsaturated polyester	484	480	490	1.0 %
Alkyd	357	360	370	0.8 %
Epoxy	400	397	398	0.8 %
Other thermosets	3120	3100	3100	6.3 %
Subtotal thermosets	10519	10503	10640	21.8 %
Total	46648	48079	48788	100 %

Table 1.1: Thermoplastics and thermosets consumption for Western Europe for 2001, 2002 and 2003
[38, Plastics_Europe, 2004]

Table 1.2 shows the consumption data for new the Member States and the new accession countries for thermoplastics and thermosets in 2003.

Country	Consumption in 2003 (kilotonnes)
Cyprus	40
Czech Republic	710
Estonia	70
Hungary	580
Latvia	50
Lithuania	90
Malta	20
Poland	1730
Slovakia	250
Slovenia	180
Bulgaria	260
Romania	280
Total	4260

Table 1.2: Plastic processors' consumption by country, new Member States and new accession countries, 2003
[38, Plastics_Europe, 2004].

Table 1.3 shows the share of the total European consumption of new Member States and accession countries by the type of plastic:

Product	Amount (kilotonnes)	Share
HDPE	550	13 %
LDPE	760	18 %
PP	780	18 %
PVC	800	19 %
EPS	140	3 %
PET	300	7 %
PS	390	9 %
Others	540	13 %

Table 1.3: Polymer consumption in New Member States and accession countries by type of plastic
[38, Plastics_Europe, 2004]

The growth of polymers is expected to continue, albeit at slower rates than in the past in Europe, with stronger growth in other areas, especially in Asia. Driving forces are the growth of population and the increase in the standard of living in these regions. New applications and further substitution of other materials will contribute to further growth in Europe.

The following trends for **commodity polymers** are observed:

- the increased quality and availability of commodity plastics widens the field of applications resulting in larger markets and also increased market shares. Thus, special plastics or special grades may often no longer be necessary. This opens the way for standardisation. Products from different producers become exchangeable with a corresponding effect on the price
- the unit margins from polymer manufacture are decreasing due to the continuing availability (over-supply) and an increasing scale of operation (average plant size). The situation for a typical commodity plastic (polypropylene) is shown in Figure 1.9.

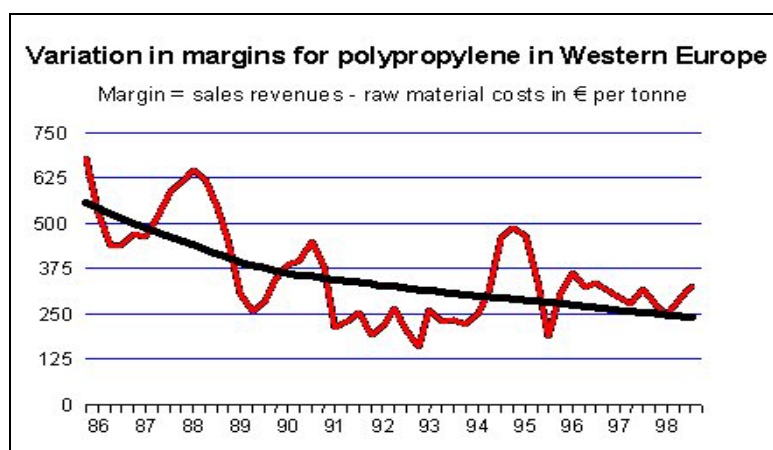

Figure 1.9: Development and tendency of margins for commodity polymers (e.g. polypropylene)

- raw material costs are the major share of the total cost. Their price is international. The prices for feedstock are highly cyclical. Table 1.4 gives price information for the period 1993 – 1999 for lowest, highest and 3rd quarter of 1999 cost figures.

Prices EUR/t	Highest 93/99 EUR/t/date	Lowest 93/99 EUR/t/date	3 rd quarter 1999 EUR/t/date
Naphtha	182 /1 st quarter 97	94 /1 st quarter 99	178 /3 rd quarter 99
Ethylene	521 /2 nd quarter 97	321 /2 nd quarter 93	360 /3 rd quarter 99
Propylene	453 /2 nd quarter 95	222 /1 st quarter 93	320 /3 rd quarter 99
Benzene	289 /4 th quarter 94	186 /1 st quarter 99	240 /3 rd quarter 99

Table 1.4: Raw material costs 1993 - 1999

- the decrease in unit margins is partially compensated by an increase in plant size leading to the so-called ‘world scale capacities’ of between 100000 – 450000 t/yr for commodity plastics depending on the product and 50000 – 100000 t/yr for engineering resins. These large units essentially allow a very significant reduction of fixed costs, while the variable costs are unchanged or only slightly modified. This is the driving force for producers to co-operate, to form joint ventures or to sell their business. Therefore, the numbers of producers has decreased significantly in Western Europe in recent years while the overall capacity has grown
- the increased competitive pressure on plants located in Western Europe can only be compensated by rationalisation, building of highly efficient world scale plants and the continuing development of high quality products and innovative new applications.

The situation for the years 2001, 2002, and 2003 for these commodity plastics, which represent 75 % of the total amount of polymers sold, is shown in Table 1.5.

Commodity plastic/kilotonnes per year	2001	2002	2003
LDPE	4681	4727	4681
LLDPE	2236	2187	2493
HDPE	4570	4685	4845
PP	7526	8113	8638
PVC	5681	6531	6694
PET	1770	1760	1854
PS	2410	2550	2540

Table 1.5: Commodity production for EU-25 + Norway + Switzerland [39, APME, 2003]

Compared to the production data shown in Table 1.5, there is a significant overcapacity available in Europe. Table 1.6 shows the capacity figures for Western European commodity production in 2003.

	Capacity in kilotonnes
LDPE	5900
LLDPE	3400
HDPE	7300
PP	9300
PVC	600
PS	2800
EPS	1000
PET	2300

Table 1.6: Production capacity for commodity plastics in 2003 for Western Europe

In principle, **engineering plastics** and **high performance polymers** are affected by these trends in the same way, as the margin development for polyesters and polyacetal shows (see Figure 1.10.)

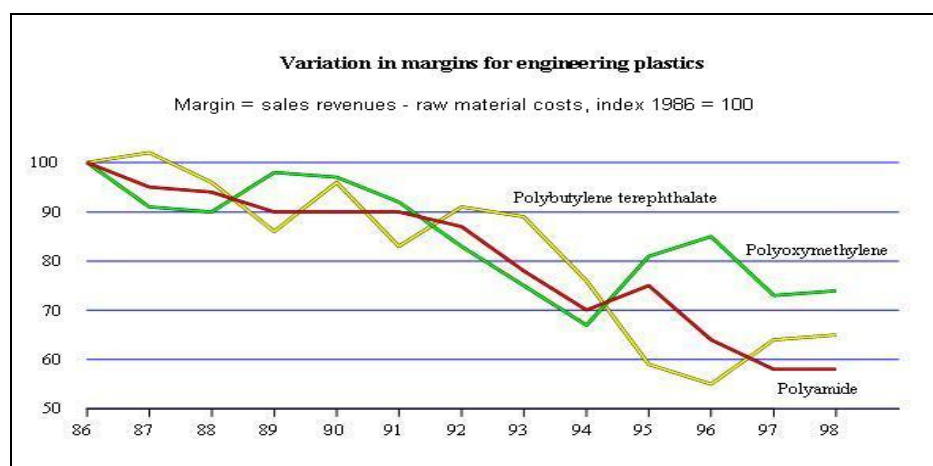

Figure 1.10: Development of margins for engineering plastics (e.g. PBT, POM, and PA)

However, certain technical services and new product developments, for instance product modification, blends, composites, etc. still have a higher influence in this market sector.

Engineering resins very often are used to start a new application and later when the development seems secure, 'over-engineering' will be reduced. This sometimes causes a change to more economic commodity plastics.

1.6.2 Germany

[16, Stuttgart-University, 2000]

The German plastics industry has an important place in the world market. In 1998, 7.9 % of the world's plastic production came from Germany. This makes Germany the world's third largest producer of plastics after the US (27.2 %) and Japan (8.9 %).

The importance of the plastics industry in Germany for the national economy is also significant. In 1998, the plastics industry accounted for 6.4 % of total industrial production; the chemical industry 8.1 %.

The plastics industry includes production, processing and mechanical engineering for plastics. However, only the plastics producing industry can be seen as part of the chemical industry. The share of industrial production (chemical industry including plastics) is thus 14.5 %. The chemical industry takes third place behind mechanical engineering (19.6 %) and automotive construction (17 %).

The overall branch can be split into three parts; plastics production, plastics processing and mechanical engineering for plastics. The structure of these three partial sectors differs significantly. Whereas plastics production is dominated by only a few firms with high turnovers, plastics processing and mechanical engineering for plastics are characterised by a large number of smaller and very small companies (see Table 1.7).

	Number of companies	Employees	Turnover (EUR million)
Production	55	60600	16100
Processing	6000	280000	36400
Mech. Engineering	180	27500	5600

Table 1.7: Structure of the German polymer industry in 1998

The plastics production industry is export oriented, like the majority of the German economy. A foreign-trade surplus of EUR 3360 million was made in 1998, which is around 20 % of the total turnover of the sector. The EU-15 is the largest trading partner in the plastics field; 72 % of exports and 82 % of imports are to or from EU-15 countries.

Although a wide variety of products are manufactured in the plastics sector, the majority of the market is accounted for by only a few commodities or 'bulk plastics'. The thermoplastics group is the largest plastics group and the bulk plastics amongst thermoplastics are PE, PP, PVC, PS and PA. These five materials alone account for 54.5 % of total plastics production. Table 1.8 shows production related data concerning the polymers mentioned above for 1998.

Product	Production (million tonnes)	Share (%)
PE	2.875	30
PVC	1.915	20
PP	1.785	18.6
PA	0.565	5.9
Diverse (including PS/EPS)	2.420	25.5
Total production	9.560	100

Table 1.8: German commodity polymer production in 2003

The commodity plastics are only manufactured by a few producers in plants with a high product output. Table 1.9, showing the number of manufacturers for some plastics, is based on a VKE survey, though only 40 % of the companies were included.

Product	Number of producers
LDPE	3
HDPE	4
PP	5
PS/EPS	2
PVC	4
PA	9
ABS/SAN	2

Table 1.9: Number of German producers for commodity polymers

1.6.3 France

[21, G. Verrhiest, 2003]

France produces 15 % of total European plastics, and ranks second in the European scale behind Germany. On the world scale, France ranks in fourth position, behind the US, Japan, and Germany.

With a production of 6.56 million tonnes in 2001, the French production of plastics has increased by 0.9 % from 2000 to 2001. However, regarding the turnover, there has been a downturn in the plastics production sector in France, of 3 % between 2000 and 2001, representing EUR 7700 million. This downturn was partly caused by the decrease in oil prices during this period.

The increasing globalisation of markets and the diminishing importance of tariff walls have led to an intensification of worldwide competition on which the companies responded with a consolidation strategy.

In 2001, the French national consumption of plastics was 5.35 million tonnes. The plasturgy is responsible for 85 % of the consumption, with 40 % being absorbed by the packaging industry, 25 % by construction activities, and 13 % for the automotive industry. The key economic figures from the plastics production sector in France in 2000 are given in Table 1.10¹.

Number of companies	46
Number of employees	9300
Turnover tax-free (TO)	EUR 62700 million
Investments and leasing	EUR 235 million
Added value per person	EUR 94000
Personal expenses per person	EUR 52000
Exports/TO	62.7 %
Added value (tax-free)/TO	13.8 %
EBITDA*/TO	35.6 %
Net income/added value (tax-free)	6.9 %
*Earnings before interests, taxes, depreciation and amortisation	

Table 1.10: Key economic figures of the French polymer production industry in 2000

The French situation concerning production, imports, exports and consumption of polymers is summarised in Table 1.11 (all data are from 2001).

¹ Service des Etudes et des Statistiques Industrielles, Ministère de l'Economie, des Finances, et de l'Industrie.

Polymer	Production (kt/yr)	Imports (kt/yr)	Exports (kt/yr)	Consumption (kt/yr)
PP	1388	274	646	840
PVC	1213	312	851	745
PUR	(capacity = 320)			
Phenoplasts	75	49	55	70
Aminoplasts	220	163	27	380
Alkyds resins	35	22	11	48
Unsaturated polyesters	154	27	97	83
LDPE	788	358	450	549
LLDPE	504	130	55	314
HDPE	500	432	352	614
Polyethylene terephthalate	96	347	18	345
Polystyrene	387	118	293	274
Expandable polystyrene	180	68	102	119
Vinyl polymers (others than PVC)	37	55	29	66
Acrylic based polymers	200	193	350	118
PMMA	30			

Table 1.11: Basic data from the French polymer industry in 2000

In 2001, the mean price of plastic materials was about EUR 1270 per tonne for import, and EUR 1110 per tonne for export. The production of plastic materials varies with time and with different patterns from one plastic to another. In 2001, the development in French production, compared to 2000, was for some basic plastic materials as follows:

- polyethylene (PE) + 6.2 %
- polypropylene (PP) – 0.1 %
- polyvinyl chloride (PVC) – 3.7 %
- styrene polymers (PS-PSE) – 1.0 %
- polyethylene terephthalate (PET) + 6.7 %
- coatings polymers – 0.4 %
- performance polymers + 2.6 %
- unsaturated polyesters – 2.3 %.

1.6.4 Spain

[22, Ministerio de Medio Ambiente, 2003]

In 2002, the chemical industry contributed about 4.5 % to the Spanish gross domestic product (GDP). About 47 % of the turnover of the whole chemical industry was achieved by the polymer producing industry (not including elastomers) as is shown in Figure 1.11.

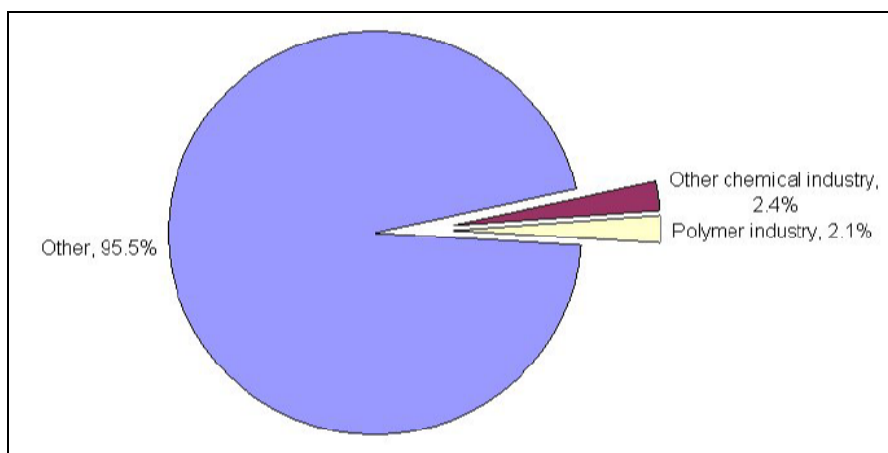

Figure 1.11: Share from the GDP of the Spanish chemical industry

In 2002, the capacity of the Spanish polymer industry was 4800 kilotonnes of which 3780 kilotonnes were actually produced. This gives a capacity utilisation of 85 %. Table 1.12 summarises the production data and the annual development.

Product	Production in kilotonnes	% difference to previous year
Polyethylene LD	390	+ 3.6
Polyethylene HD	345	- 3.5
Polypropylene	680	+ 3.6
Polystyrene	240	+ 13.1
PVC	415	+ 4.8
PET	348	+ 6.3
Subtotal commodities	2418	+ 4.0
Alkydic resins(1)	39	+ 3.7
Aminoplastics: Urea resins (2)	264	- 12.3
Moulding powder/liquid resins	46	+ 26.3
Phenoplastics: Moulding powder + 42.7	5	+ 42.7
Liquid and solid resins + 8.4	60	+ 8.4
Unsaturated polyesters	86	+ 8.5
Subtotal thermosets	500	- 2.5
ABS/SAN	128	+ 32.0
PMMA (3)	17	- 1.7
Epoxy resins	19	+ 0.3
Polycarbonate (4)	-	-
Polyamide	5	- 32.7
Subtotal engineering plastics	169	
Vinyls (5)	87	+ 3.3
Polyurethanes	206	+ 12.3
Regenerated cellulose	-	-
Others (6)	412	+ 9.3
Subtotal other plastics	705	+ 9.1
Total	3792	+ 4.6
(1) not including self consumption of large paint manufacturers (2) 100 % solid (3) estimated figures (4) production included in others, production started in 1999 (5) polyvinyl acetate and polyvinyl alcohol (6) including PC, LLDPE and others.		

Table 1.12: Production data from the Spanish polymer industry in 2002

1.6.5 Belgium

[40, Fechiplast_Belgian_Plastics_Converters'_Association]

Belgium has an unusually high concentration of plants manufacturing plastics. In addition, the port of Antwerp has attracted a large number of petrochemical industries.

In 2003, Belgium produced over 8070 kilotonnes of plastics worth EUR 6883 million.

Table 1.13 shows the production capacity data for major types of plastics in Belgium in 2003.

Product	kilotonnes
PP	2000
HPDE	1485
LDPE	905
PUR	700
PS & EPS	705
PVC	645
PC	200

Table 1.13: Belgian main polymer production data (capacities in 2003)

2 GENERAL PROCESSES AND TECHNIQUES APPLIED IN THE PRODUCTION OF POLYMERS

[1, APME, 2002, 15, Ullmann, 2001, 16, Stuttgart-University, 2000]

The production of polymers follows the scheme given in Figure 2.1 with monomers, comonomers, catalysts, solvents as well as energy and water on the input side and the product, off-gases, waste water and wastes on the output side.

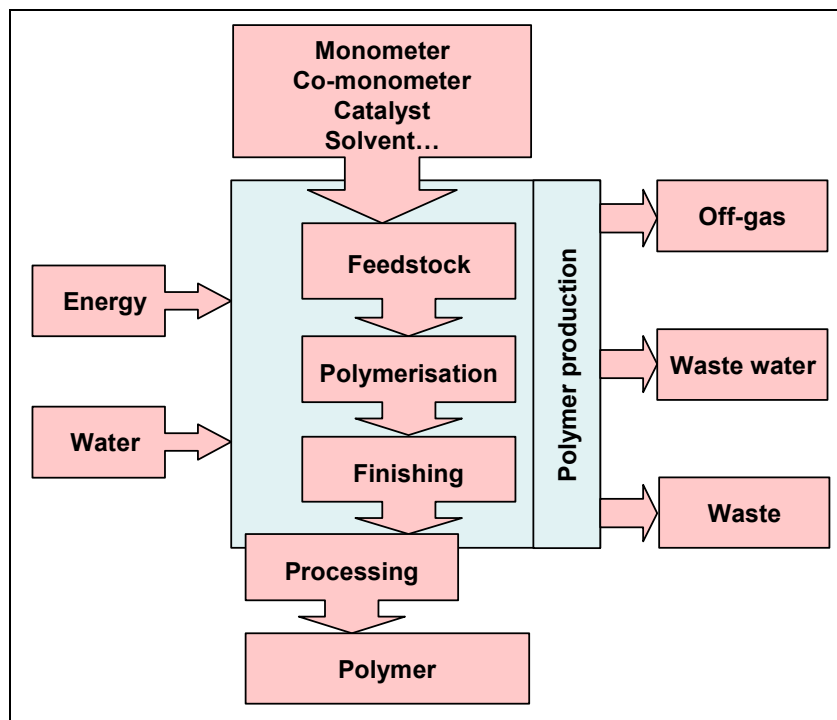

Figure 2.1: General production scheme

2.1 Raw materials and raw material requirements

The actual polymer production process needs – due to the nature of the process – extremely pure raw materials. Thus, side products from monomer synthesis, impurities from storage containers, oxygen, degradation products or stabilisers added for transport, have to be removed before use. A general purity of 99.99 % is often not sufficient if extremely high molecular weight products should be obtained. In these cases, a purity of 99.9999 % is required, as it is in the case of polytetrafluoroethylene. Special precautions are taken for impurities which interfere in the process and for oxygen due to safety concerns. Inerts, like nitrogen or nonreactive gases, are sometimes permissible up to a certain ppm level.

General purification units like distillation, extraction or fractionated crystallisation are usually part of the monomer supply; the most common monomers are described in the BREF Document dealing with large volume organic chemicals (LVOC). If the polymerisation unit needs a special monomer quality and the required additional purification is part of the polymer plant, it is included in this document.

Important monomer groups are:

- ethylene, propylene, butadiene, isoprene, styrene
- vinyl chloride, vinyl esters, vinyl ethers, chloroprene
- acrylic and methacrylic esters, -amides and -nitriles
- adipic acid, hexamethylene diamine, caprolactam
- terephthalic acid, ethylene glycol
- formaldehyde
- aromatics, like phenol, cresol, bisphenol A
- maleic anhydride.

2.2 Energy

Energy is needed for the production of polymers, even in the case of polymerisation systems where the process itself is exothermic, i.e. generates energy. The demand for energy also depends on the local situation if the polymerisation unit is integrated into a larger complex with, for example, the need for low pressure steam or not. Thus, the swap of energy between different plant sites has to be taken into account.

2.3 Chemical reactions

[1, APME, 2002, 15, Ullmann, 2001, 16, Stuttgart-University, 2000, 23, Roempp, 1992, 25, J. Brandrup and E. Immergut, 1998]

The production of polymers consists essentially of three parts:

- preparation
- reaction step
- separation of products.

Preparation means – starting with monomers of a specified quality – usually the mixing of the individual required components. It may mean homogenisation, emulsification or mixing gases and liquids. This may occur before entering the reactor or just inside the reactor. Sometimes, an additional distillation of the delivered monomer prior to the preparation is required.

The **actual reaction step** may be a polymerisation, a polycondensation or a polyaddition step which are of fundamentally different natures.

After the actual **reaction**, a **separation** process to obtain a polymer of a certain purity and state follows. Usually, thermal and mechanical unit operations are applied. Polymers may include residual monomer and solvents which are often difficult to remove. Special consideration has to be given to this subject in the polymers industry in a perspective of life-cycle impact of the products. In the context of the IPPC Directive, the focus is on the minimisation of the emissions of monomers at the industrial site [27, TWGComments, 2004]. Separated monomers, mostly as gases, can be directly returned to the process, returned to the monomer unit to be prepared for purification, transmitted to a special purification unit, or flared off. Other separated liquids and solids are sent to a centralised clean-up or recycling unit. Additives needed for processing or for protection may be added to the polymer at this point.

In most cases, polymers need stabilisation or additives in order to meet the requirements of the intended application. Thus, antioxidants, UV-stabilisers, processing aids, etc. may be added after the actual reaction but before forming the pellets.

2.3.1 Polymerisation (chain growth reaction)

2.3.1.1 General reactions

[27, TWGComments, 2004]

Polymerisation is the most important reaction process and produces amongst others the plastics polyethylene (PE), polypropylene (PP), polyvinyl chloride (PVC) and polystyrene (PS). The reaction principle includes the opening of the double bond of a monomer (Figure 2.2) and linking many monomeric molecules together forming a saturated long chain macromolecule.

These reactions are usually exothermic, thus producing energy.

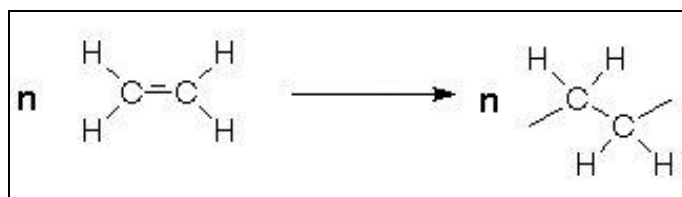

Figure 2.2: Polymerisation by the opening of a double bond (e.g. ethylene)

The number of molecules combined, n , may vary at the low end between 10 – 20. The products are then called telomers or oligomers. For polymers, n is between 1000 and 100000 or more. The polymer growth occurs very rapidly, in seconds or minutes. Thus, fully formed macromolecules exist almost from the beginning of the reaction. However, the overall time required for a high conversion of monomer to polymer is often several hours.

Depending on the activation (type of reaction initiation), a differentiation is made between radical and ionic polymerisation:

- radical initiators may be oxygen, or for higher process temperatures, organic peroxides or azocompounds or simply heat as in the case of polystyrene, and for lower processing temperatures redox systems such as persulphate/bisulphite
- ionic (including organo-metallic) catalysts are mostly of a very complex nature and often require a separate production process within the plant. Modern ionic catalysts are so effective that removal of the catalyst after polymerisation is not required for most of the applications. Only one gram of transition metal, for instance, produces more than 200 tonnes of final products. Thus, the residual concentration of the transition metal is no more than a few parts per million.

Initiators very often need special care since they are either potentially explosive like peroxides or react vigorously with water and are flammable such as metal alkyls. Usually, initiator concentrations vary and are between 0.1 – 0.5 wt-%. Dissociation products of the radical initiator are removed from the polymer or built-in, while decomposed metal alkyl residues of the initiator remain in the product and sometimes have an influence on end use properties.

Since the concentration of the active growing chain is very low (10^{-5} mol/l) utmost purity of the monomer is required to avoid termination of the catalyst. This effect is used to modify the molecular weight by adding a defined amount of a specified ‘impurity’ called a chain transfer agent. Hydrogen is an example often used for such chain transfer reactions. Oxygen needs to be kept at very low levels since it acts as a poison for transition metal catalysts. Oxygen can act as an inhibitor at low temperatures in free radical polymerisation, while at high temperatures it will accelerate the reaction. Therefore, polymerisations are carried out in inert atmospheres.

The actual polymerisation may be carried out in bulk, in water or in organic solvents or dispersants.

The course of the reaction process can be generally described as:

- start reaction
- growth reaction
- termination reaction.

Figure 2.3 shows the energy curve over the reaction time of homopolymerisation from ethylene to polyethylene.

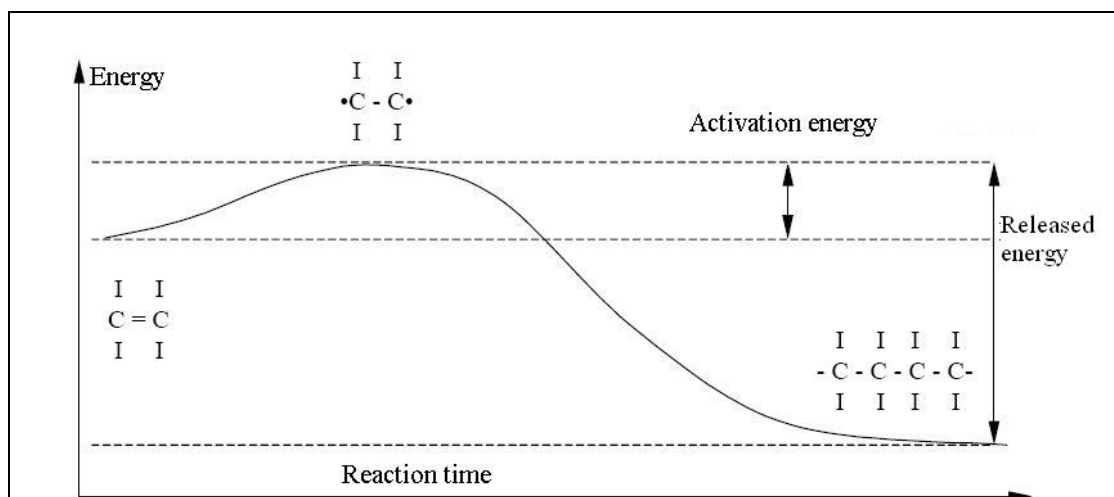

Figure 2.3: Energy curve of homopolymerisation

2.3.1.2 Typical features

The main concern for safety is the control of the reaction temperature and of oxygen due to the exothermic nature of the process and the resulting danger of a runaway reaction. The rate of polymerisation increases with temperature while the rate of heat transfer decreases with increasing conversion due to increased viscosity. An effective process control is essential for keeping the reaction under control.

Residual monomers constitute one of the major by-products at the end of the reaction. They are usually not emitted but either separated or returned into the process in a closed loop or sent to a separate treatment unit or burnt, if possible with energy recovery. Residual monomers may also be dissolved in the final product. The reduction to legally specified or lower levels requires additional treatment during the work-up phase.

Auxiliaries such as initiators, chain transfer agents or sometimes emulsifiers or colloidal stabilisers either become part of the product or are separated.

Some of the monomers, dispersants and additives used can be dangerous for human health and/or the environment, and available information on the reduction of their emissions or their substitution has to be taken into account when selecting BAT [27, TWGComments, 2004].

Polymerisation reactors tend to build up solid layers of product along the inside walls of the reactor or the heat exchangers after extended periods of running. The exact conditions for this unwanted side-effect are different for each monomer and each process. This layer will interfere with the necessary removal of heat and may cause product impurities resulting, for instance, in so-called 'fish eyes' in film applications. Therefore, it is removed from time to time. The necessary opening of the reactor may cause emissions of unreacted monomers and/or solvents.

2.3.2 Polycondensation (step growth reaction)

2.3.2.1 General reactions

The reaction principle includes the reaction of a monomer with two distinctive reactive functional groups or the combining of two bifunctional monomers forming a polymer and generating a by-product which is, in many cases, water. A schematic view of the reaction is shown in Figure 2.4.

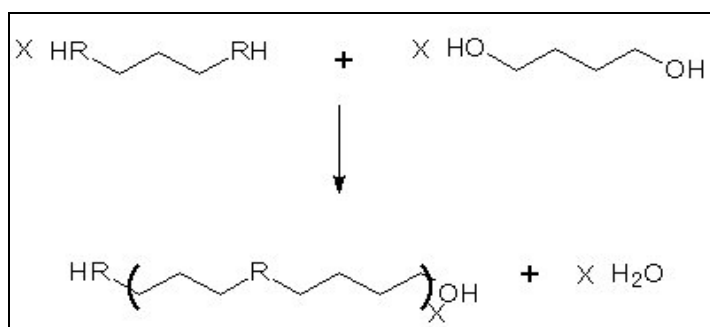

Figure 2.4: Schematic view of a polycondensation reaction

The reactive groups may be for instance:

- alcohol plus acid for polyesters
- amine plus acid for polyamides.

This process is, like most of the chemical reactions, an equilibrium process; it may be shifted in either direction depending on the conditions. High yields are achieved only by careful removal of the by-products (water or alcohols) which are formed. Otherwise, the by-product would interfere and reduce the molecular chain length. The by-product is removed by heat and by high vacuum towards the end of the reaction. This gets increasingly problematic as the viscosity of the reaction medium increases. Sometimes, a thermal after-treatment in the solid phase is used to increase the molecular weight even further. In any case, a special reactor design is needed for the last phase of the reaction.

Polycondensation is considered to be a 'step growth reaction'. The process often (but not always) needs a catalyst which is usually a metal salt or a combination of metal salts.

The degree of polymerisation is generally lower than in the case of chain polymerisation (between 1000 and 10000) due to inherent process characteristics. The molecule grows step by step at a relatively slow rate. The growth proceeds slowly from monomer to dimer, trimer, etc. until full sized macromolecules are formed only at very high conversion rates towards the end of the reaction time as illustrated by the Table 2.1:

Degree of polymerisation	Conversion needed
2	50 %
10	90 %
100	99 %
1000	99.9 %
10000	99.99 %

Table 2.1: Dependency of the degree of polymerisation on the conversion rate in a step growth reaction

Generally, polycondensation reactions are carried out either in bulk or in organic solvents.

2.3.2.2 Typical features

The control of oxygen is important not only for safety reasons, but also for product quality. Oxygen causes side reactions resulting in products which discolour the end-product and increase the concentration of low molecular weight products. These parts either remain in the product or have to be removed and sent for waste treatment, for instance incineration. The high reaction temperature at the end of the reaction may also lead to degradation products, which also cause discoloration. Localised heat spots have to be avoided.

The build-up of solid layers in the inside of the reactors or heat exchangers also occurs in these reactions (see Section 2.3.2.1).

2.3.3 Polyaddition

The reaction principle includes the opening of a reactive ring, or a reactive group forming a polymer (see Figure 2.5).

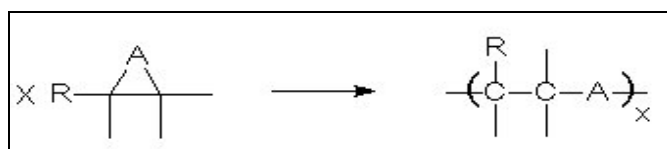

Figure 2.5: Schematic view of a polyaddition reaction

If A is an oxygen atom, polyepoxides are obtained; if the ring reacts with another bifunctional group like diols, diamines or carbonic acid anhydrides, epoxy resins are formed.

The characteristic of these processes closely follows those of polycondensation reactions; thus, a stepwise growth with all the limitations as described in Section 2.3.2 can be observed. An advantage – also from an environmental point of view – is that there are no low molecular weight products formed.

2.4 Production processes

Generally, the reaction of monomers to polymers may be carried out discontinuously or continuously by one of the following processes:

- suspension polymerisation
- bulk polymerisation
- emulsion polymerisation
- gas phase polymerisation
- solution polymerisation.

2.4.1 Suspension polymerisation

In suspension polymerisation, the chemical reaction takes place in droplets that are in suspension in a solvent. Suspension polymerisation is characterised by a good transfer of the reaction heat, a low dispersion viscosity and low separation costs on the one side but also by the fact that it is a discontinuous process, and there are relatively high amounts of waste water, significant reactor wall fouling and suspension agents remaining in the final product and in the waste streams.

Typical products made by suspension processes are:

- polyvinyl chloride
- polymethyl methacrylate
- polystyrene (HIPS and EPS)
- polytetrafluoroethylene
- polyolefins as slurry in mineral oil fractions.

Suspension polymerisation produces latex particles in the size range from 1 to 1000 μm . This process comprises monomer + initiator + solvent (usually water) + surfactant. The monomer and the initiator are both insoluble in the solvent (water), e.g. styrene and benzoyl peroxide; hence the monomer is dispersed as droplets (as in emulsion polymerisation), but the initiator is present in these droplets (and not in the aqueous phase). The role of the surfactant is purely to stabilise these droplets.

There are no micelles in the aqueous phase. The focus of polymerisation is now totally inside the monomer droplets. Hence, the polymerisation resembles a (micro-) bulk polymerisation, but confined to each monomer droplet separately.

Heat transfer problems are greatly diminished, compared to an actual bulk polymerisation, because the aqueous phase can conduct away most of the heat generated. The size distribution of the final particles should closely follow that of the initial monomer emulsion droplets (provided coalescence is avoided).

2.4.2 Bulk polymerisation

In bulk polymerisation, the polymer is produced in a reactor where only the monomer and a small amount of an initiator are present. Bulk polymerisation processes are characterised by high product purity, high reactor performances and low separation costs, but also by high viscosities in the reactors. Bulk processes cause reactor fouling, and in the case of polycondensation products, a high vacuum is required.

Typical products made by bulk processes are:

- polyolefins
- polystyrene
- polyvinyl chloride
- polymethyl methacrylate
- polyamides
- polyesters.

This is the usual method for step-growth (condensation) polymerisation. The reaction is often carried out at a high temperature, but there are no real problems with heat transfer out of the reaction vessel (i.e. temperature build-up). The degree of polymerisation increases linearly with time, so that the viscosity of the reaction mixture only increases relatively slowly; this allows for efficient gas (e.g. water vapour) bubble transfer out of the system as well.

This method can be used for chain-growth polymerisation, but only on a small scale, preferably at low temperature. Heat and bubble transfer may give problems, since the degree of polymerisation (and hence, also the viscosity of the reaction mixture) increases very rapidly from the beginning of the reaction.

For certain monomers (e.g. vinyl chloride), the polymer is insoluble in its own monomer (above some critical molar mass). Hence, in these cases, the polymer precipitates (as aggregated, swollen particles) from the monomer after a while. Eventually all the monomer is converted to polymer.

2.4.3 Emulsion polymerisation

In emulsion polymerisation, the chemical reaction takes place in droplets that are in suspension in a solvent – like in the case of suspension polymerisation – but also in emulsion structures called micelles, and in the solvent. Emulsion processes typically show a low dispersion viscosity, good heat transfer, high conversion rates and are suitable for the production of high molar mass polymers. They are also characterised by high separation costs, reactor wall fouling and emulsifiers remaining in the product and in the waste streams.

Typical products made by emulsion processes are:

- ABS
- polyvinyl chloride
- PTFE
- SBR
- NBR
- PVA
- PMMA
- polyacrylates for paints.

Emulsion polymerisation produces latex particles in the size range from 0.03 to 0.1 μm . The process comprises monomer + initiator + solvent (usually water) + surfactant (usually anionic, e.g. sodium dodecyl sulphate).

The monomer has only a very limited (but finite) solubility in the solvent (e.g. styrene in water). Most of it is present initially in dispersed droplets (hence the term emulsion polymerisation); one role of the (anionic) surfactant is to help stabilise these droplets, by adsorbing at the droplet/water interface. However, some of the monomer is present in the water phase.

Most of the surfactant is present as micelles, again in the water phase, and some of the monomer will be solubilised in the micelles.

Thus, the monomer is actually distributed in three locations: droplets, aqueous solution (small amount) and micelles. The initiator is soluble (and therefore present) in the water phase. The initial locus of polymerisation is, therefore, again in the aqueous solution (as in dispersion polymerisation), i.e. that is the first monomer to polymerise.

The growing, oligomeric free-radical chains will co-micellise in with the existing micelles from the added anionic surfactant. The primary locus of polymerisation now switches to the micelles, where the solubilised monomer can now begin to polymerise. As polymerisation (in the micelles) continues, particles form, as in dispersion polymerisation, and the distribution of monomer, is gradually pulled to the right. Polymerisation continues in the growing particles until all the monomer in the droplets and free solution is exhausted. The size of the final particles is controlled by the number of micelles present (i.e. the initial surfactant concentration).

2.4.4 Gas phase polymerisation

In gas phase polymerisation, the monomer is introduced in the gaseous phase and put in contact with a catalyst deposited on a solid structure. Gas phase processes allow an easy removal of the reaction heat, they are low in emissions and waste and no additional solvents are needed. Gas phase processes are not applicable for all end-products and the investment costs are relatively high, partially caused by the high pressure equipment needed for most of the processes.

Currently, gas phase processes are only applied to the polyolefins:

- polyethylene
- polypropylene.

This process is often used, e.g. in Ziegler-Natta type polymerisations of ethylene and propylene where the catalyst is supported on inert silica particles so the reaction therefore takes place at the surface. This helps control the stereochemistry (especially for isotactic polypropylene).

2.4.5 Solution polymerisation

In solution polymerisation, the chemical reaction takes place in a solution of the monomer in a solvent. Solution polymerisation processes are characterised by a good transfer of the reaction heat, a low dispersion viscosity and little reactor wall fouling, but also by the low reactor capacities, high separation costs, often the use of inflammable and/or toxic solvents and traces of solvent contaminating the final product.

Typical products made by solution processes are:

- polyacrylonitrile
- polyvinyl alcohol
- SBR
- BR
- EPDM
- polyethylene.

Solution polymerisation comprises monomer + initiator + solvent. This is the preferred method to use for chain-growth polymerisation. The solvent helps heat dispersal and reduces the rapid build-up in viscosity in the reaction mixture.

The polymer may or may not be soluble in the solvent; in the latter case (e.g. styrene + methanol) the polymer precipitates from solution (above some critical molar mass).

2.4.6 Summary of processes

Most of the commercial polymers are produced by the processes described in Sections 2.4.1 to 2.4.5 in one way or another, as some have to be produced by different processes in order to achieve products with different properties for different applications. Table 2.2 summarises the possible ways of production for some important polymers.

	PE	PP	PVC	PET	PS	PA
Suspension	X	X	X		X	
Bulk	X	X	(X)	X	X	X
Emulsion			X			
Gas phase	X	X				
Solution	X					

Table 2.2: Product – process matrix for some polymers

3 POLYOLEFINS

3.1 General information

[1, APME, 2002, 2, APME, 2002, 15, Ullmann, 2001]

3.1.1 Polyethylene

Polyethylene is the most widely produced polymer worldwide and everyone comes into contact with it daily. Right from the start, PE was seen as an addition to the world of materials, although initially, its value was established as insulation for electricity cables. Nowadays, the strength of polyethylene lies in its intrinsic properties, its broadly accepted usefulness, and its large application potential.

Polyethylene can be made into soft and flexible, as well as tough, hard and sturdy products. It is found in objects of all dimensions with simple and complicated designs. Among others, it can also be turned into everyday objects, packaging, pipes and toys.

The world consumption of polyethylene is growing at above the average economic growth figures. Total use in the world was estimated at 62 million tonnes in 2001; that gives an average of nearly 10 kg/person worldwide. In Western Europe, the volume of polyethylene used in 2001 was close to 11 million tonnes (about 35 kg/person). Table 3.1 shows the growth of polyethylene consumption over the years 1987 to 2001.

	1987	1996	2001
Western Europe (kt/yr)	6873	9755	11330
Eastern Europe (kt/yr)	2177	1720	3110
Rest of the world (kt/yr)	24713	38500	49100

Table 3.1: Growth of polyethylene consumption

Polyethylene products are still replacing traditional materials such as paper or metals. Three main types of polyethylene can be distinguished. The total of these types is used in more than 90 % of all polyethylene applications.

Polyethylene is produced all over Europe; the plants are usually in the vicinity of refineries which support them with the raw materials. The main production sites (in Western Europe) for polyethylene are shown in Table 3.2. Due to mergers and joint venture formations, the number of European producers has decreased over the last few years. Some of the European producers are part of worldwide polyethylene producing companies; others only focus on Europe. The largest PE producers in the world are Dow, ExxonMobil and Equistar, followed by Borealis and Basell. Equistar does not produce in Europe, but all the others do. Besides these four companies, Polimeri Europa, DSM, BP, Repsol, Atofina and Solvay, who formed a joint venture with BP, are the other important producers in Europe.

Country	Number of production sites	Products
Austria	1	LDPE, HDPE
Belgium	8	LDPE, HDPE
Finland	1	LDPE, LLDPE, HDPE
France	11	LDPE, LLDPE, HDPE
Germany	11	LDPE, LLDPE, HDPE
Italy	7	LDPE, LLDPE, HDPE
Netherlands	2	LDPE, LLDPE, HDPE
Norway	1	LDPE, HDPE
Portugal	1	LDPE, HDPE
Spain	5	LDPE, LLDPE, HDPE
Sweden	1	LDPE, LLDPE, HDPE
United Kingdom	3	LDPE, LLDPE, HDPE

Table 3.2: Main Western European polyethylene production sites in 2001

Depending on the physico-chemical properties of the product, different types of polyethylene are distinguished. The different product types require different production processes where the main distinction is the density of the final product.

3.1.1.1 Low density polyethylene (LDPE)

Low density polyethylene is the oldest type of polyethylene. It is produced in a high pressure process. It is a soft, tough and flexible kind of polyethylene due to its highly branched molecular structure. The typical density of LDPE lies between 915 and 935 kg/m³. When it is deformed, it can recover its original shape due to its natural elasticity. The ‘high pressure’ polyethylene shows a higher melt flow index (MFI) and therefore, processes easier than most other types of polyethylene.

It is used for strong, supple items like lids. It has been used as an insulation material for a long time. Nowadays, the most popular application is film, some examples being carrier bags, packaging material and agricultural film covers.

Figure 3.1 shows the highly branched molecular structure of low density polyethylene.

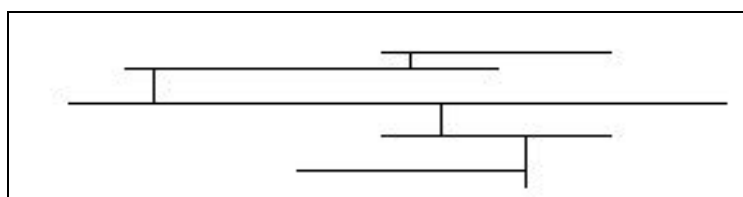

Figure 3.1: Molecular structure of LDPE

3.1.1.2 High density polyethylene (HDPE)

Caused by its high crystallinity, high density polyethylene is the most rigid and least bendable amongst the different types of polyethylene. HDPE has hardly any side branches. Therefore, the density is always higher than 940 kg/m^3 . The rigid and somewhat hard character is useful for a wide range of applications.

Figure 3.2 shows the almost linear molecular structure of high density polyethylene.

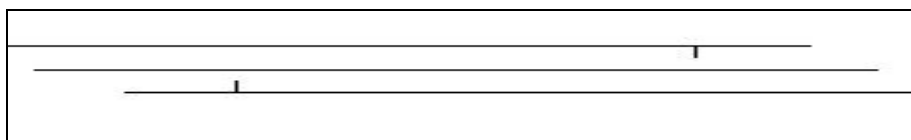

Figure 3.2: Molecular structure of HDPE

According to their molecular mass distribution, two main types of HDPE can be distinguished as shown in Figure 3.3. Type 1, which has a narrow molecular mass distribution, is used to make, for example, the crates for fruits, vegetables or drinks. Type 2, which has a broader molecular mass distribution, can be found in non transparent bottles, containers and pipes. Although HDPE is quite rigid, it also can be used to make very thin films from type 2, which are very light and can crackle.

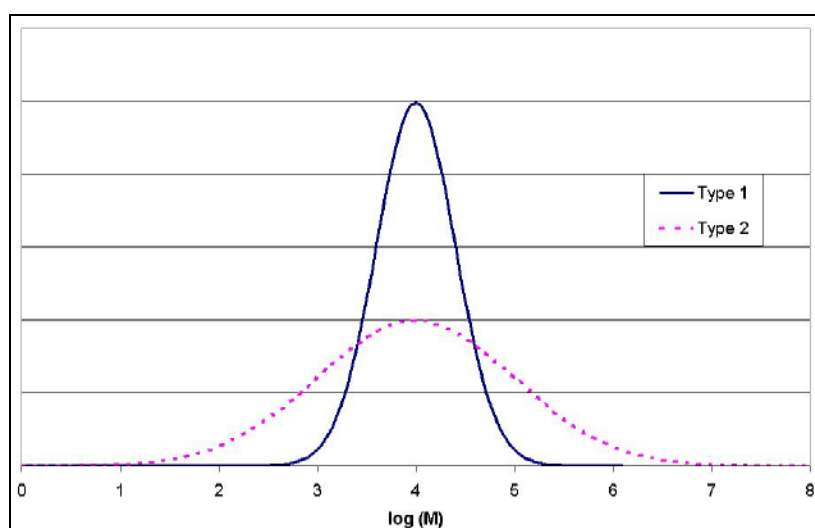

Figure 3.3: Molar mass distributions of HDPE

3.1.1.3 Linear low density polyethylene (LLDPE)

This is the youngest of all the PE types. It looks similar to HDPE but has lower crystallinity due to a larger number of short chain branches. Therefore, it also has a lower density (normally lower than 940 kg/m^3). However, PE with densities between 930 and 940 kg/m^3 is often called MDPE or medium density polyethylene.

LLDPE is used to make flexible as well as rigid products. LLDPE is often used in mixtures with one of the materials mentioned previously in order to make thinner films. It is also used in packaging made up of multilayer films. LLDPE is very tough and keeps its shape. These properties are useful for the manufacture of larger objects like lids.

Figure 3.4 shows the molecular structure of LLDPE with the typical short chain branches caused by specific comonomers.

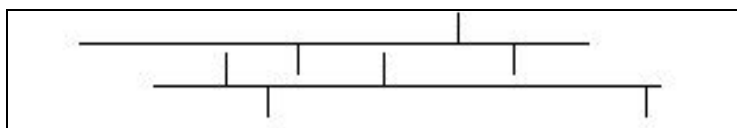

Figure 3.4: Molecular structure of LLDPE

3.1.2 Polypropylene (PP)

[15, Ullmann, 2001, 16, Stuttgart-University, 2000]

Polypropylene (PP) is one of the economically most important thermoplastic materials. The Western European production in 2002 reached approximately 8000 kt. The development of Western European polypropylene production for the years 2000 – 2002 is shown in Table 3.3. Polypropylene is found in an extremely wide range of applications whether transparent or pigmented, such as food packaging, textiles, automotive components, medical devices and consumer goods.

Year	2000	2001	2002
Production volume	7004 kt	7230 kt	7805 kt

Table 3.3: Western European polypropylene production 2000 – 2002

Similar to polyethylene, polypropylene is produced all over Europe; in many cases even on the same sites and by the same companies.

Polypropylene's properties are decisively determined by the applied polymerisation process and the catalysts used. As shown in Figure 3.5, the base unit of PP consists of three carbon and six hydrogen atoms.

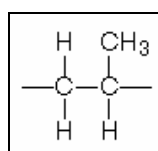

Figure 3.5: Base unit of polypropylene

PP is a linear polymer and is classified as a polyolefin. The methyl (CH₃) group is characteristic. Depending on the spatial arrangement of these groups to the main -CC-chain, one differentiates between atactic PP (aPP) with an irregular CH₃ arrangement, isotactic PP (iPP) with CH₃ groups on one side of the carbon chain and syndiotactic PP (sPP) with an alternating CH₃ arrangement as shown in Figure 3.6. Increasing the tacticity (regularity of the CH₃ arrangement) leads to an increase in the degree of crystallinity, fluxing temperature, tensile strength, rigidity and hardness.

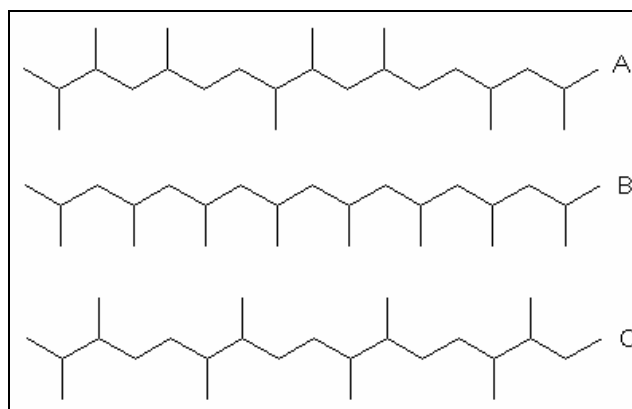

Figure 3.6: Molecular structures of polypropylene

- A) atactic polypropylene
- B) isotactic polypropylene
- C) syndiotactic polypropylene

Isotactic polypropylene is currently of great industrial interest (the degree of crystallisation is 40 to 60 %). Non-crystalline atactic PP is used as elastomer components in PP copolymers. The production of syndiotactic PP has only recently become possible through the progress made in catalyst research. It is characterised by a high flexibility, though it crystallises slower and to the same extent as iPP.

PP shows hardly any stress cracking, is brittle as a homopolymer (though it is impact resistant in polymer blends), has a higher dimensional stability under heat than PE and is not as resistant to oxidation. Parameters such as degree of crystallisation, melting range, tensile strength, rigidity and hardness rise with an increasing isotactic share. PP has a complex structure, and four different superstructures can be determined. Exposure to oxygen and high energy radiation lead to brittleness and the decomposition of PP. Natural PP is quite translucent (PP films, for example, are very transparent), is not resistant to UV without stabilisation, water-repellent, chemically resistant to acids (apart from oxidising acids), lyes, saline solutions, solvent, alcohol, water, fruit juices, milk as well as oils, greases and detergents. PP is not resistant to aromatic and chlorinated hydrocarbons, benzene, gasoline and strong oxidants.

Polypropylene has a rather high melting point, low density, good stiffness and toughness. These properties depend upon the degree of crystallinity and type and level of comonomer incorporated within the product. Polypropylene products may be compounded with rubber to modify their low temperature properties or with mineral fillers or glass fibres to increase stiffness and dimensional stability.

3.2 Applied processes and techniques in the production of polyolefins

[2, APME, 2002, 16, Stuttgart-University, 2000]

3.2.1 Alternative processes

3.2.1.1 Low density polyethylene processes

The high pressure LDPE process is very generic and the basic design does not change from company to company. The major variation is in reactor type, tubular versus autoclave. The choice between tubular or autoclave reactor is mainly dictated by the desired product. In principle, the tubular process is preferred to make resins with good optical properties, while only the autoclave process can make good extrusion coating resins and more homogeneous copolymer products. General purpose products can be manufactured from both technologies. The ethylene conversion level achieved in the tubular process is typically higher than for the autoclave process, however, due to the typical lower operating pressure level in the autoclave process, the final energy consumption per tonne polyethylene produced can be the same for both processes. Important factors which influence the conversion level and also the consumption of energy are:

- the molecular weight distribution (MWD) of the polyethylene resin to be produced: broader MWD products are produced at higher ethylene conversion levels than narrow MWD products
- heat transfer: for the tubular process, ethylene conversion can be further increased while maintaining the desired product quality (5 to 15 % conversion increase), through extending the heat transfer capability (increasing the heat exchange area through lengthening the reactor and/or improving the heat transfer coefficient)
- initiation system: optimisation of the initiation system can lead to a higher conversion level for the same product properties. The autoclave process is typically operated with organic initiators. The tubular plants can be operated with oxygen only, peroxides/oxygen or peroxide only as the initiation system. Tubular reactors operating with peroxides as the initiator typically reach a higher conversion level than reactors using an oxygen only initiation system. The introduction of an organic initiator will require the usage of hydrocarbon solvents as the peroxide carrier for the injection of the initiator.

Thus, reactor selection (tubular or autoclave) and the state of technology applied will influence the conversion level, the required operating pressure and also the energy consumption; however, product design and quality requirements for the application can have an even stronger impact on these parameters. The difference in target applications and MWD quality requirements could easily lead to a difference of 20 % in conversion level and also in energy requirements among produced resins. Differences in product mix and quality targets could easily explain a 10 % deviation in energy consumption for plants using the same technology and hardware.

3.2.1.2 Linear low density polyethylene processes

The main processes for manufacturing LLDPE are the gas phase and the solution processes. In Europe, the ratio between the gas phase and the solution processes for producing LLDPE is about 60 to 40. The process selection is based on the following factors:

- desired product properties
- α -olefin choice
- product density
- unimodal or bimodal molecular weight distribution
- access to technology
- overall economics.

The gas phase process is the preferred process to produce polymers made with butene-1 as the comonomer, while the solution process is preferred for manufacturing of products based on octene-1 as the comonomer. Hexene-1 can be easily applied in both processes. Hexene-1 and octene-1 resins have better mechanical properties than butene-1 based resins.

In the gas phase process, the polymer is kept in the solid phase, while the monomer and comonomer are used as a gaseous carrier to maintain the fluidised bed and to remove heat. The solid state requirement imposes a limit to the maximum operating temperature and lower polymer density capability. The newest generation of gas phase processes can be operated in the condensing mode, which greatly improves heat removal and reactor productivity. For this purpose, a comonomer (hexene-1) and/or a 'condensable' solvent (for instance hexane) is added to the process. By condensing these components in the recycling loop, the heat removal capacity is greatly enhanced. Gas phase LLDPE processes can also produce HDPE (Section 3.2.3.2).

In the solution process, the polymer is dissolved in the solvent/comonomer phase. Higher α -olefins form a good blend with the hydrocarbon solvent (typically in the range from C6 to C9); while the application of butene-1 as a comonomer might require a higher operating pressure to ensure single-phase conditions. The solution process is very versatile in polymer density capability. Typically, solution reactors are run adiabatically, although it is possible to include circulation coolers in the reactor system. The use of coolers will improve the polymer to solvent ratio in the reactor effluent and so will reduce the energy required for evaporating the solvent fraction. The achievable polymer to solvent ratio can be limited by a maximum operation temperature of the catalyst system, heat removal capability and maximum allowable process viscosity. The process viscosity should not negatively affect reactor mixing and/or heat transfer removal capability.

The required physical state of the polymer in the reactor system, solid or dissolved in solvent, imposes two completely different operating temperature regimes for the reactor systems; either below the polymer melting point for the gas phase process or above it for the solution process. This difference in reactor operating temperature translates to differences in reactor productivity, required volume and product change over time. The solution process has smaller reactor volumes and shorter product change over times.

Both processes can produce unimodal and bimodal molecular weight distributions. Currently, bimodal MWDs may have to be produced in dual reactor systems. They are energy intensive and require more capital and increase the control complexity. Some licensors claim now to achieve similar product quality with a single reactor by using a dual site catalyst with bimodal capability.

Gas phase process technology is widely available and is offered by several technology providers, namely Univation, BP, Basell, etc. The set up of gas phase processes is, in principle, generic and proprietary information on condensing mode, dual reactor operation, catalyst systems, etc. is protected through patents.

The solution process is less generic. The companies having a strong technology foothold in the solution process technology include Mitsui, Nova Chemicals (Sclairtech process), Dow and DSM (Stamicarbon Compact process). Differences in process set-up and operating conditions are considered as proprietary information.

3.2.1.3 High density polyethylene processes

The slurry suspension and the gas phase processes are the two main categories of processes to produce high density polyethylene. HDPE processes can be further sub-categorised into:

- a suspension process with stirred tank reactor(s) and C5 to C9 hydrocarbon as the diluent
- a suspension process with loop reactor(s) and hexane as the diluent
- a suspension process with loop reactor(s) and isobutane as the diluent
- a gas phase process with a fluidised bed reactor
- a suspension/gas phase process combination consisting of a loop reactor with propane as the diluent in series with a fluidised bed reactor.

The main differences between processes and products produced by these processes are related to:

- the cooling mode applied. Evaporation and condensation of solvent, external cooling of the loop, cooling of the gaseous recycle flow, the latter potentially combined with a condensable solvent
- mono or dual reactor systems
- the blend ratio of polymers produced in the primary and secondary reactor
- the capability of removing polymer waxes
- the catalyst systems applied: Ziegler-Natta, chromium or metallocene catalysts
- the type of solvent applied: ranges from supercritical propane to C9 solvent.

The choice of process for a new large-scale plant will depend on the best combination of process efficiency and product mix capability. This might vary from producer to producer.

There is an extensive choice of HDPE process technologies and include companies like Asahi, Basell, Borealis, BP, Chevron/Phillips, Solvay, Univation and others.

3.2.2 Low density polyethylene

Two types of reactors are used for the production of LDPE: either a stirred vessel (autoclave) or a tubular reactor. The autoclave reactor operates adiabatically. The tubular reactor is cooled with a jacket. The autoclave reactor has a length to diameter ratio (L/D) between 4 and 16. Tubular reactors have L/D ratios above 10000. The inner diameter of the high pressure tubes used for the tubular reactors range between 25 and 100 mm. The operating pressure ranges between 100 and 250 MPa (1000–2500 bars) for the autoclave reactor and between 200 - 350 MPa (2000 - 3500 bar) for the tubular reactor. A basic flow diagram for LDPE processes is shown in Figure 3.7.

Apart from the different types of reactors used, the autoclave and tubular reactor processes are very similar. The two types of reactors produce, however, products which have a different molecular structure and are, therefore, used in different product applications.

Modern crackers produce ethylene of sufficient purity to be used in the high pressure process without the need for additional purification. The fresh ethylene is normally delivered to the high pressure plant by a pipeline grid. If the high pressure plant is located on the same site as the cracker, the ethylene can be delivered directly from the cracker.

The supply pressure can range between 1 and 10 MPa. A first compressor (primary or medium pressure compressor) increases the ethylene pressure to 20–30 MPa. The number of compression steps depends on the pressure of the ethylene which is supplied to the plant. If this pressure is above 3 MPa, the primary compressor typically has two compression stages. Because the ethylene gas is used as a heat sink for the heat generated by the exothermic reaction, the ethylene gas is not totally converted to a polymer in the reactor. The unreacted gas is recycled back into the process. This recycled ethylene is combined with the fresh ethylene at the outlet discharge of the primary compressor. The combined gas streams are fed to the suction of the high pressure compressor. This compressor increases the pressure of the reactor up to 150–350 MPa in two steps. The process gas is cooled with cooling water and/or chilled water between the two compression steps.

To tailor the application properties of the polymer, different initiation systems and chain transfer agents (modifier) are used. Typical initiators are oxygen or organic peroxides. To control the molecular weight distribution of the polymer produced, polar modifiers (aldehydes, ketones or alcohols) or aliphatic hydrocarbons are fed into the monomer stream.

The reactor is protected by pressure relief devices which guarantee an immediate release of the reactor content in case a runaway reaction occurs. The runaway reaction of ethylene causes a sharp increase in pressure and temperature. These sharp increases cause the activation of the emergency relief system. Because of the fast response required, the emergency relief systems of the reactor vent the content of the reactor to the air.

The operating pressure is controlled by a valve at the reactor outlet. The pressure is reduced by this high pressure valve from the reactor pressure down to 15–30 MPa. Because the ethylene polymer mixture heats up due to the pressure reduction (the so-called Reverse Joule Thomson effect), the reaction mixture is cooled in a heat exchanger at the exit of the reactor. The polymer and unreacted gas are separated in a first separator (HPS or high pressure separator) operating at 15–30 MPa. The unreacted gas stream from the HPS is then cooled in a series of cooling water coolers. Part of the exothermic reaction heat can be recuperated in this section to generate low pressure steam. This steam can be consumed internally, thereby significantly improving the energy efficiency of the process. Typically, each cooler is followed by a smaller separator in which the waxy oligomers are removed from the recycled gas. Although most of the unreacted gas is removed from the polymer in the HPS, at least one additional separation step is necessary to remove the dissolved gas almost completely (<1 wt-%) from the melted polymer. This separation step is carried out in a low pressure separator (LPS, also called an extrusion hopper) at operating pressures down to 0.15 MPa. The pressure at this separation step is a compromise between a low level of residual ethylene monomer in the final product and compression energy savings. The gas separated from the polymer in this second separation step is also recycled back into the process. It is compressed in several stages up to the supply pressure of the fresh ethylene. A small side-stream is sent back to the cracker or to a dedicated purification unit to limit the build-up of impurities in the process.

The low pressure separator (LPS) is, in most cases, mounted directly onto a hot melt extruder. The polymer is fed directly into this hot melt extruder and pelletised in an underwater pelletiser. If required by the application of the product, additives can be added to the melted polymer in the extruder. After pelletising, the product is dried, temporarily stored and tested for quality. If required, the product is blended in specially designed silos to smoothen small quality variations which occurred during the polymerisation. During the intermediate storage, the product is degassed by air to remove the last residual ethylene from the product. If higher pressures are used in the LPS, degassing hot melt extruders can be used to remove the residual ethylene from the product. After quality control, degassing and blending, the product is pneumatically conveyed into storage silos or directly sent to the packaging or bulk loading areas.

Special equipment and technology is required because of the high operating pressure used. Key operating characteristics and design details are mostly treated as proprietary information. The design rules for the reactors are those of thick-walled vessels and tubes. The high pressure requires the use of reciprocating compressors and pumps. The most typical and important compressor used in the high pressure process is the high pressure compressor, sometimes also called the hyper compressor. The losses which occur in these compact machines by leaking gas across the piston rings in the cylinders, are normally recycled internally within the LDPE process.

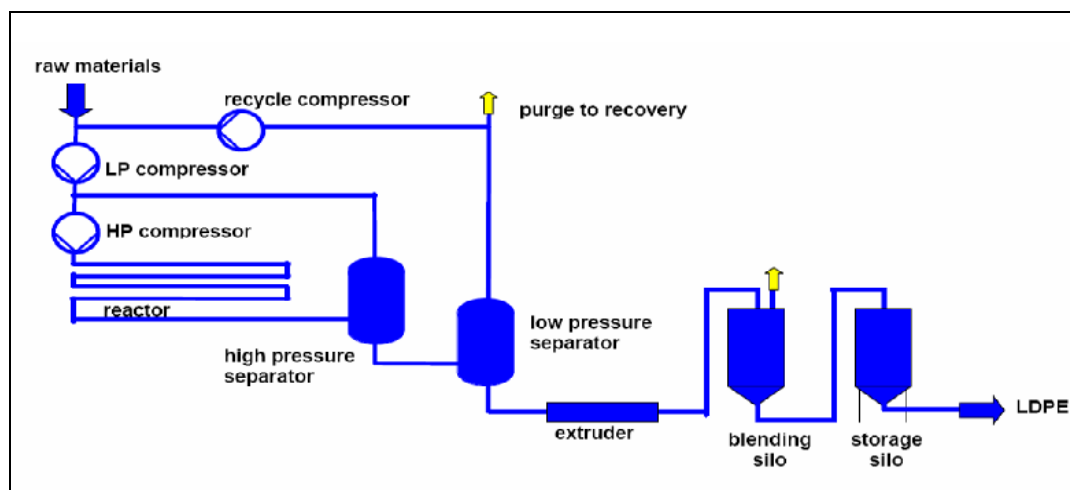

Figure 3.7: Flow diagram showing LDPE production

3.2.2.1 Autoclave reactor

The autoclave reactor has an agitator to obtain good quality mixing and performs as an adiabatic CSTR (continuous stirred tank reactor). The volumes of the autoclave reactors can vary between 250 litres (reactors of the 1960s) up to 1500 litres for the more recent reactors. The residence time can vary between 30 - 60 seconds depending upon the technology used. In most technologies, the electric motor driving the agitator is built inside the top zone of the reactor. The ethylene entering the reactor is used to cool the motor.

The elongated form of the reactor is due to the manufacturing requirements (it is fabricated from thick-walled forging). The length/diameter ratio (L/D) of the autoclave is also set by the product properties required. Longer autoclaves allow developing temperature profiles along the reactor length by dividing the reactor into multiple zones. The use of different temperature profiles allows tailoring of the product properties. The reaction temperature is controlled in each temperature zone by the injection of controlled amounts of organic peroxides which act as initiators. These initiators decompose under the influence of the temperature and generate the free radicals which start the polymerisation reaction. To maintain the temperature at a given set point, different types of initiators are used. It is important that the initiators are completely consumed before they exit the reactor with the gas stream. If an excessive amount of free radicals exit the reactor, the polymerisation reaction can continue outside the reactor. This causes upsets in the process and poor quality products. The initiators are dissolved into a hydrocarbon solvent. This solution is injected through side holes in the wall of the vessel. Some technologies also use these side holes to inject a controlled amount of ethylene gas. The cooling action of this gas is used to control the temperatures in the reactor. The operating temperatures of autoclave reactors vary between 180 and 300 °C. The reactor walls also have holes for the installation of thermo-elements and pressure relief devices.

In the high pressure polymerisation of ethylene, the fresh ethylene is used as the heat sink for the heat generated by the exothermic polymerisation reaction. The conversion to polymer, at adiabatic conditions, is calculated with the following formula:

$$\text{Conversion (\%)} = 0.075 * (\text{reaction temperature} - \text{ethylene inlet temperature}).$$

3.2.2.2 Tubular reactor

The commercial tubular reactors are typically between 1000 and 2500 metres long. They are built up of high pressure tubes each 10 to 15 metres long in a serpentine like structure within a concrete bay. In the 1960s, the internal diameter of the high pressure tubes was limited to 25 mm. Recent progress in the metallurgy of high strength materials has allowed the manufacture of high pressure tubes of up to 100 mm of internal diameter (ID). These high pressure tubes have $D_{\text{outside}}/D_{\text{inside}}$ ratios of 2.1 to 2.5. Thermo-elements are installed along the length of the reactor to follow the progress of the polymerisation reaction. As for the autoclave reactor, inlets for an initiator, fresh ethylene gas and pressure relief devices are installed at selected locations along the reactor.

The first section of the reactor is used as preheater. The ethylene temperature must be sufficiently high to start the reaction. While only organic peroxides are used as an initiator for the autoclave reactor, oxygen (air) is also used to generate the free radicals needed to initiate the polymerisation reaction in the tubular reactor. The initiation temperature can, therefore, range from 140 °C (peroxides) to 180 °C (oxygen). When oxygen is used as the initiator, the air is added to the ethylene gas in the lower pressure zones of the process. In the case of peroxide initiators, the amount added is controlled by adjusting the speed of high pressure pumps. The control of the polymer chain length by temperature does not give enough freedom to tailor the polymer properties. Therefore, a chain transfer agent (modifier) is necessary. Typically, polar modifiers (aldehydes, ketones or alcohols) are used. While at high polymerisation temperatures, even normally less active aliphatic hydrocarbons can be used.

The injection of an initiator or a mixture of ethylene/air at different points in the reactor generates a number of zones with higher temperatures (so-called peaks) followed by cooling zones in which the reaction heat is removed from the ethylene/polymer mixture. These temperature peaks/cooling cycles can be repeated several times along the length of the reactor. Because of the heat transfer through the walls of the reactor, the tubular reactor has a higher conversion rate to polymer than the autoclave. Conversion rates of up to 36 % are achieved (autoclave reactors achieve approximately 20 %). The conversion to polymer influences the properties of the product. At higher conversion rates, the degree of branching increases.

The exothermic heat can be recuperated from the reactor via the cooling jackets. In this way, low pressure steam can be produced. The generation of steam can make the tubular reactor a net producer of low pressure steam. Modern high pressure plants use closed cooling water systems to minimise the intake of fresh water for cooling purposes. At the same time, proper conditioning of the cooling water allows maximum protection of the high strength materials used in the process against corrosion.

3.2.2.3 Technical parameters

Product type	LDPE	LDPE
Reactor type	tubular reactor	autoclave reactor
Mechanical dimensions	inner diameter pipe: 25 - 100 mm L/D ~ 10000 - 50000	volume: 250 - 1500 litres
Operating pressure	200 - 350 MPa	100 - 250 MPa
Operating temperature	140 - 340 °C	180 - 300 °C
Initiators	oxygen and/or organic peroxides 0.2 - 0.5 g/kg PE	organic peroxides 0.2 - 1 g/kg PE
Conversion to polymer	up to 36 %	up to 20 %
Current maximum plant capacity	300000 t/yr	200000 t/yr

Table 3.4: Technical parameters of LDPE

3.2.2.4 Other ethylene based polymers made by the high pressure process

Besides LDPE, there are some more plastics produced using the same high pressure technology, such as:

- ethylene-vinyl acetate copolymers (EVA)
- ethylene-acrylic acid copolymers (EAA)
- ethylene methacrylic acid copolymers (EMA)
- most grades of linear low density polyethylene (LLDPE)
- very low density polyethylene (VLDPE)
- ultra low density polyethylene (ULDPE).

These families of resin are produced in commercial scale high pressure processes. To produce these types of polymers, additional investment is needed, e.g. in corrosion protection, refrigeration capacity, extrusion equipment and process units to recycle the comonomers after purification back into the process.

EVA copolymers are the most important on a volume basis. The total LDPE copolymer market for Europe is estimated at 720 kt/yr. The EVA copolymers volume is 655 kt/yr of which 450 kilotonnes are above 10 wt-% VA).

More information on copolymers can be found in Section 3.3.2

3.2.3 High density polyethylene

There are two main types of processes used for the production of high density polyethylene (HDPE) and both type 1 (narrow molecular weight distribution) and type 2 (broad molecular weight distribution) HDPE can be produced by these processes:

- the suspension (slurry) process
- the gas phase process.

Besides these two processes, HDPE type 1 can also be produced by a solution process.

The HDPE processes normally use either a Ziegler type (titanium-based) or a Philips type (chromium-based) supported catalyst. Recently, metallocene catalysts have also been introduced. In general, the Ziegler catalyst can be used in all these processes to produce type 1 HDPE. The loop reactor which uses isobutane as a diluent, and the gas phase reactor can be operated at higher temperatures than STR suspension processes using a higher boiling solvent and the first two processes are, therefore, more suitable for the production of type 2 HDPE by using chromium catalysts.

The loop reactor processes and the gas phase reactor processes normally have only one reactor, while the STR processes typically have two or more reactors to reach a reasonable plant capacity and to have the flexibility to produce type 2 HDPE (broad molecular weight distribution) using a Ziegler catalyst.

A comonomer (butene-1, hexene-1) is used to control the polymer density and hydrogen is used for molecular weight control. Compared to the gas phase process, the slurry processes are limited in their capability of producing lower density polyethylene, because the solubility of the polyethylene in the diluent increases with decreasing density of the polymer. Dissolved polymer in the diluent causes high viscosity and an increased risk of fouling of the reactor and downstream equipment. The solubility in hexane is higher than in isobutane. The gas phase process does not have the problem with dissolved polymers and can, therefore, produce both HDPE and LLDPE by applying different types of catalysts.

An overview of HDPE processes and parameters is shown in Table 3.5.

Process type	Reactor type	Number of reactors	Diluent	Catalyst	HDPE type 1	HDPE type 2
Suspension	STR	Single	C5 - C8	Ziegler	Yes	No
		Cascade	C5 - C8	Ziegler	(Yes)	Yes
	Loop	Single	C5 - C8	Ziegler	Yes	No
		Single	Isobutane	Philips	No	Yes
		Single	Isobutane	Ziegler	Yes	No
		Cascade	Isobutane	Ziegler	(Yes)	Yes
Gas phase	FBR	Single	–	Ziegler	Yes	No
		Single	–	Philips	No	Yes
		Cascade	–	Ziegler	(Yes)	(Yes)
	Combined suspension/ gas phase	Loop/FBR	Cascade	Propane	Ziegler	(Yes)
Solution	STR		C6 - C9		Yes	No

Table 3.5: Process overview HDPE

Traditionally, chromium catalysts have been used in single loop and gas phase reactor processes to produce type 2 HDPE products (broad molecular weight distribution), while Ziegler catalysts have been used for products with a narrow molecular weight distribution (type 1 HDPE).

However, in processes with at least two reactors in cascade, it is possible to control (broaden) the molecular weight distribution and the comonomer distribution of the final product by operating each reactor under different conditions. The products produced in this way are normally referred to as bimodal and are generally considered to have a better performance than unimodal products of the same density and molecular weight. Especially stirred tank reactors, but also loop reactors, are used for production of bimodal HDPE.

A dual reactor process consisting of a loop operated in supercritical propane followed by a fluidised bed gas phase reactor has been developed especially for the production of bimodal polyethylene. This reactor combination gives the flexibility to both broaden the molecular weight distribution and to produce low density PE thus expanding the feasible operating window in terms of density of the final bimodal product to cover the whole range from LLDPE to HDPE.

A disadvantage with the slurry processes is that the diluent contained in the slurry from the reactor has to be separated from the polymer powder and purified before it is recycled back into the reactor. This process step is more complicated and more expensive than the corresponding recycling system for the gas phase process. Using a light diluent (isobutane, propane) makes it possible to separate most of the diluent by a direct flash of the slurry from the reactor, which is not feasible with heavier diluents due to the higher boiling point.

3.2.3.1 Suspension processes

3.2.3.1.1 Stirred tank reactors

Over the years, several suspension process variants have been developed based on the use of Ziegler catalysts. In early plants, a cleaning stage was needed to remove the residues of the catalyst from the product. Owing to the increased activity of catalysts, it has, for quite a few years now, been possible to dispense with this. The modern stirred tank slurry plants usually use hexane as the diluent. Some old plants use heavier hydrocarbons, which often require steam stripping for removal of the diluent from the polymer.

Figure 3.8 shows a process flow diagram of a typical modern STR suspension process. Only one reactor is shown in the flow diagram, although a series connection of several reactors is possible. The pressure in the reactors is between 0.5 and 1 MPa, permitting the construction of large reactors with up to 100 m³ volume. The reaction temperature is between 80 and 90 °C, and hexane is used as the diluent.

The main feed to the reactor consists of recycled diluent. The ethylene and comonomer feed streams are run through purification beds to remove traces of catalyst poisons. A controlled amount of ethylene monomer, a comonomer and hydrogen as well as a suspension of a catalyst/cocatalyst (alkyl aluminium) mixture is fed to the reactor. In the subsequent 'run-down' reactor, the dissolved ethylene is almost completely consumed. The remaining ethylene can be recovered and sent back to a nearby cracker or used as fuel gas.

The polymer concentration in the slurry is an important process parameter. A high concentration permits a high production rate for a given reactor volume, but the heat transfer to the reactor cooling jacket and the operation of the stirrer in the reactor become more difficult. The maximum polymer slurry concentration is dependent on many factors, for example the type of solvent, grain size and shape, but basically on the cluster density of the polymer particles. The concentration of the polymer slurry may range between 15 and 45 % by weight, but is mostly between 30 and 35 % by weight.

After leaving the reactor, the polymer slurry is passed to a centrifuge which removes most of the solvent. The separated solvent is returned to the reactor. In a fluidised bed dryer, the polymer is dried in a stream of hot nitrogen and freed of the remaining solvent. The solvent can be condensed out of the outlet gas from the fluidised bed dryer for recycling. A small purge stream containing mainly nitrogen is taken out of the fluidised bed recycling stream to control the accumulation of light inert material and catalyst poisons. This purge gas is normally sent to a flare.

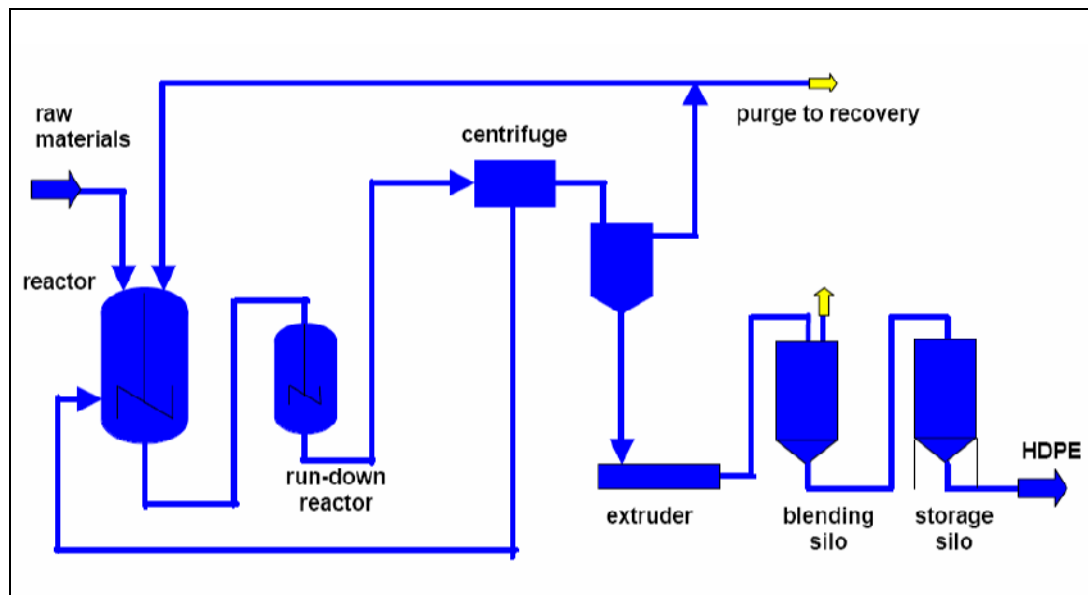

Figure 3.8: Flow diagram of an HDPE STR

3.2.3.1.2 Loop reactor processes

The loop reactor consists of a long pipe equipped with a cooling water jacket and arranged into a closed loop, in which the slurry is pumped around at a high velocity (6 - 10 m/s) with an in-line axial pump. The loop reactor was originally developed to avoid deposits which had proven troublesome in the stirred tank reactor. The reactor has a high surface to volume ratio, which facilitates heat transfer and permits short residence times. The loop reactor usually consists of four or six vertical pipes with a height of up to 50 metres. Some producers have chosen to arrange the loop pipe in a horizontal position.

Typical reaction conditions are 90 – 110 °C and 3 – 4.5 MPa. The diluent used is normally isobutane, which facilitates the separation by vaporisation in a low pressure flash tank and permits higher operating temperatures than longer chained organic solvents. After treatment in purification beds to remove catalyst poisons, the ethylene monomer, comonomer and recycled diluent are fed to the loop reactor. The catalyst is flushed out of the feed container into the loop reactor by the diluent. The polymer concentration in the reactor slurry may range from 30 to 50 wt-%. The slurry from the reactor is passed through a sedimentation zone, where the polymer concentration increases up to 55 – 65 wt-%, and the slurry is then fed to the flash tank, where the hydrocarbons evaporate at a low pressure of about 0.15 MPa.

The evaporated gases from the flash tank are filtered, compressed and fed to a distillation column, where the unreacted ethylene is separated from the diluent and comonomer. Due to the high conversion of ethylene in the loop reactor (96 – 98 %) the amount of separated ethylene rich stream is quite small and can be partly recycled back into the loop reactor, but a small purge stream is needed to control the accumulation of light inert material. The diluent and the comonomer from the distillation are recycled back into the reactor after having poisons such as water in an alumina or molecular sieve bed removed.

The polymer powder from the flash tank bottom falls by gravity into a heated rotary dryer and then to a purge column to remove a maximum amount of hydrocarbons in the polymer powder. After that, the powder can be sent either by gravity to a purge bin with nitrogen sweeping or directly transferred by a conveying system to a fluff silo. This pneumatic conveying system can be either a positive conveying system with nitrogen or a vacuum conveying system with air. In the purge column and in the purge bin, residual hydrocarbons are reduced to a very low level by nitrogen sweeping. The small amounts of hydrocarbons in the nitrogen rich purge gas can be recovered or the stream is sent to a flare.

From the purge bin, the powder, with a low residual hydrocarbon level, is fed to the extruder feed bins, from where the powder is fed to the extruder together with necessary stabilisers and additives. The powder is melted and homogenised and cut to pellets in an underwater pelletiser. The pelletiser water is recycled and a small side-stream has to be discharged. This waste water contains small amounts of hydrocarbons due to the direct contact with the pellets.

The wet pellets are then dried in an air dryer and pneumatically conveyed to intermediate storage silos. During the intermediate storage, the product can be further degassed by air to remove the last residual hydrocarbons. The air from the dryer, the air from the silos and the pneumatic conveying system are discharged directly to the air. After final degassing, quality control and blending, the product is pneumatically conveyed into storage silos or directly sent to the packaging or bulk loading areas.

In addition to the general type of slurry loop process described above, slightly different loop reactor processes also exist. A short summary of two of these processes is shown below.

3.2.3.1.2.1 *Slurry process with horizontal loop reactors*

A small number of producers in the world operate a suspension process with a horizontal loop reactor, instead of a vertical loop reactor, for the production of HDPE. The choice of a horizontal reactor has a historical reason and gives no specific advantages or disadvantages. The diluent is isobutane and both type 1 as well as type 2 HDPE can be produced. The reactor temperature is typically 100 °C and the pressure is 4–5 MPa. The reactor outlet is flashed removing most of the diluent. The PE product is transferred from isobutane to a water phase. The PE powder is recovered from this water phase through centrifuging and drying. The dry powder is fed to an extruder.

3.2.3.1.2.2 *Slurry process with loop reactors using hexane as the diluent*

The diluent used is hexane and the catalyst is of the Ziegler type. The pressure in the reactor is 3–4 MPa and the temperature is 80–90 °C. After leaving the polymerisation reactor, the polymer slurry is passed to a stripper where steam and hot water are injected for removing the solvent. The separated solvent still contains catalyst residues and water. The solvent is returned to a recovery unit where it is purified and dried before being reinjected into the reactor. The wet polymer is passed to a centrifuge which removes most of the water. In a fluidised bed dryer, the polymer is dried in a stream of hot air. The polymer is then passed to a rotating valve and sent to the extruder by pneumatic conveying transport (see Figure 3.9).

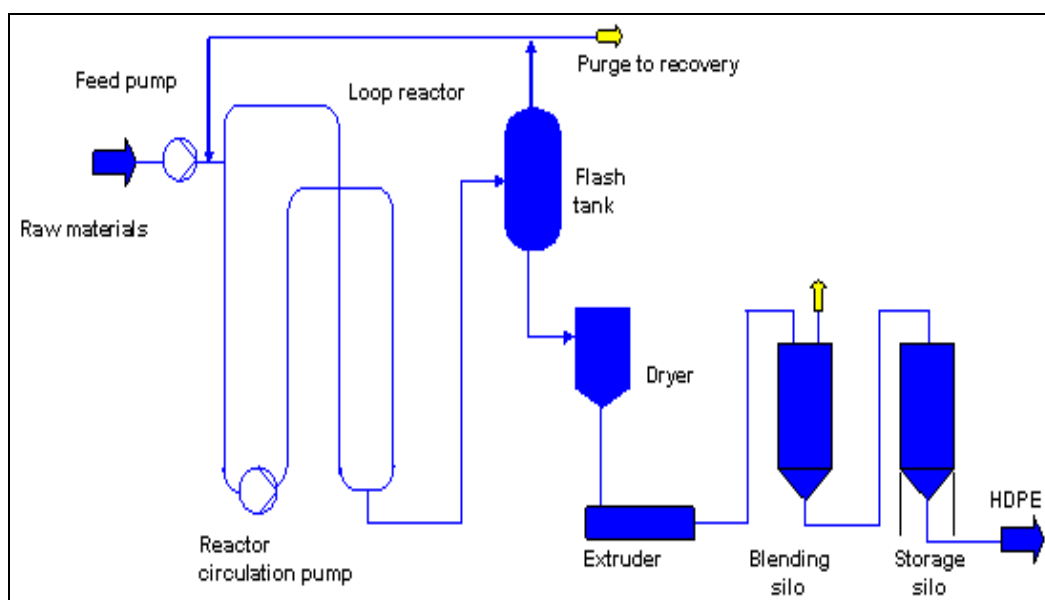

Figure 3.9: Flow diagram of an HDPE loop

3.2.3.2 Gas phase processes

The fluidised bed reactor is a vertical pressure vessel with a total height of up to 40 m. A fluidised bed of polymer particles in gaseous ethylene is maintained by a recycle compressor. The ethylene recycling gas enters the reactor through a distributor plate at the bottom to achieve an even gas flow over the entire cross-section and to hold the particles when the gas flow is turned off. In the characteristically conical upper part of the reactor, the gas velocity decreases with the increasing diameter of the reactor to keep the particles in the fluidised bed. The gas leaves the reactor at the top. It is cleaned from entrained particles by a cyclone, the reaction heat is removed by a recycle gas cooler and the gas is then routed back to the bottom reactor inlet.

Feed ethylene is normally delivered to the plant by a pipeline grid or directly from a cracker on the same site. As the process is highly sensitive to impurities, sulphur compounds, acetylene and other impurities are removed from the feed ethylene by purification beds. The cleaned feed ethylene is then compressed to the required reaction pressure and enters the reactor loop at the bottom of the reactor. A metal oxide catalyst, aluminium alkyl in hydrocarbon as a cocatalyst, lower olefins as comonomers and other auxiliary chemicals are fed directly into the reactor loop. Typically, different product types can be produced by selecting the catalyst system, the comonomers and the reaction conditions.

The reaction temperature is 80 to 105 °C and the reaction pressure of 0.7 to 2 MPa is controlled by the ethylene feed compressor. Polymer and gas are extracted from the fluidised bed by valves at the bottom section of the reactor and expanded to a lower pressure of approx. 0.15 MPa in a degassing vessel to separate polymer particles from monomers.

The gaseous monomers from the degassing vessel are filtered, cooled and recompressed by the monomer recovery compressor to the reaction pressure. The recovery gas is cooled by a series of heat exchangers and finally by a cooling medium from a cold box. Condensing liquid hydrocarbons are delivered back to the solvent supply system; the remaining gas is recycled to the reactor loop. A small side gas stream has to be separated from the recycling gas to limit the build-up of impurities. It mainly contains ethylene and can be used as fuel gas or can be fed back to a cracker. The technology is in continuous development with a number of processes cooling the recycling gas stream sufficiently to condense some of the comonomers (known as super condensing). The comonomer is recycled back into the reactor as combined feed and coolant. The latest development is the introduction of a solvent in the circulating stream to improve heat transfer through condensation.

The product granules are pneumatically conveyed to a purge hopper. By purging with a nitrogen steam mixture, monomers are further removed from the granules. The purge and conveyor gas streams are recycled. To limit the build-up of impurities, a side-stream is sent to a dedicated treatment unit to reduce its VOC content before being discharged into the air.

The degassed polymer granules are fed to a melting extruder and pelletised in an underwater pelletiser. If required, additives can be added to the melted polymer. The pelletiser water is recycled; a small side-stream has to be discharged. The resulting waste water contains a small amount of hydrocarbons due to the direct contact with the pellets.

The wet pellets are sent to an air dryer and pneumatically conveyed to intermediate storage silos. During intermediate storage, the product can be further conditioned by air to remove the last residual ethylene. The air from the dryer and the air from the silos and the pneumatic conveying system are discharged directly into the air. After final degassing, quality control and blending, the product is pneumatically conveyed into storage silos or directly sent to the packaging or bulk loading areas (see Figure 3.10).

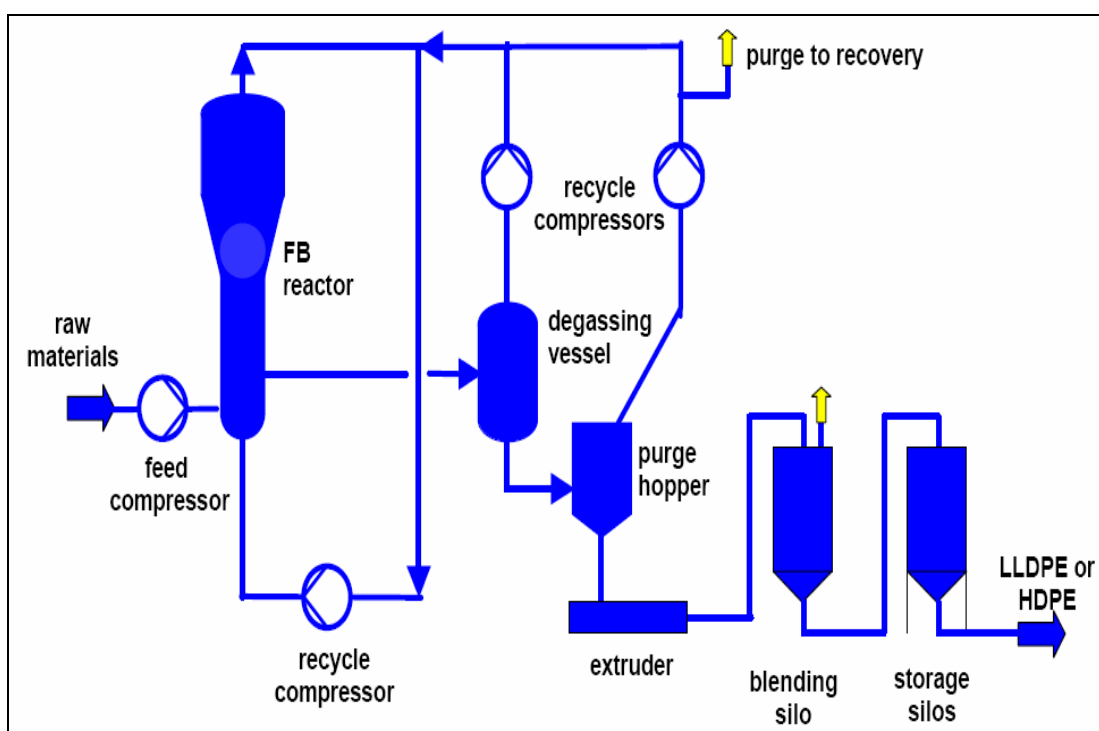

Figure 3.10: Flow diagram showing the HDPE gas phase process

3.2.3.3 Combined suspension/gas phase process

Borealis has developed a dual reactor polyethylene process (Borstar) consisting of a loop reactor operating in series with a gas phase reactor which needs a flash separation of the polymer powder between the reactors. The Borstar process is especially suited for bimodal HDPE and LLDPE but can also produce unimodal polyethylene. Special features of this dual reactor process are the use of supercritical propane as the diluent in the loop reactor and an independent control of the reactor conditions due to the flash step. The solubility of polyethylene in supercritical propane is lower than in traditional subcritical diluents. When producing bimodal polyethylene, this allows the loop to produce low molecular weight polyethylene with a lower density than in other slurry processes. In the gas phase reactor, the polymerisation is continued by producing a high molecular weight copolymer. By adjusting the polymerisation conditions in both reactors, it is possible to control the molecular weight distribution, comonomer distribution and density to give the desired properties to the final products.

The process, set up with a loop reactor part and a gas phase reactor part, is similar to corresponding single reactor processes. The catalyst is mixed with propane diluent and fed into a pre-polymerisation reactor. Cocatalyst, ethylene, comonomer and hydrogen are also fed into this reactor. The pre-polymerised slurry, together with the main feeds, is then fed into the slurry loop reactor, designed for supercritical conditions and typically operated at 85 – 100° C and 5.5 – 6.5 MPa. This reactor produces a low molecular weight, high density product. The reactor content is sent to a flash tank where diluent and unreacted components are separated from the polymer produced in the loop reactor. The diluent is condensed and recycled back into the loop reactor.

The polymer from the flash tank is fed to a fluidised bed reactor for further polymerisation. No additional new catalyst is needed; the polymer continues to grow on the same catalyst particles, resulting in a homogeneous polymer structure. The gas phase reactor operates at 75 – 100 °C and 2 MPa. Fresh ethylene, comonomer and hydrogen are fed into the reactor. In this step, a high molecular weight copolymer is produced.

Polymer and gas are extracted by a valve at the bottom section of the reactor and expanded at lower pressure in a degassing vessel to separate polymer particles from monomers. The gaseous monomers are recompressed by the monomer recovery compressor and routed back to the reactor cycle. The product granules are further degassed with nitrogen sweeping in a purge hopper. The degassed polymer granules are fed to an extruder. The product pellets are dried and transferred to blending silos. Finally, the product is conveyed into a storage silo or directly sent to packaging or bulk loading areas (see Figure 3.11).

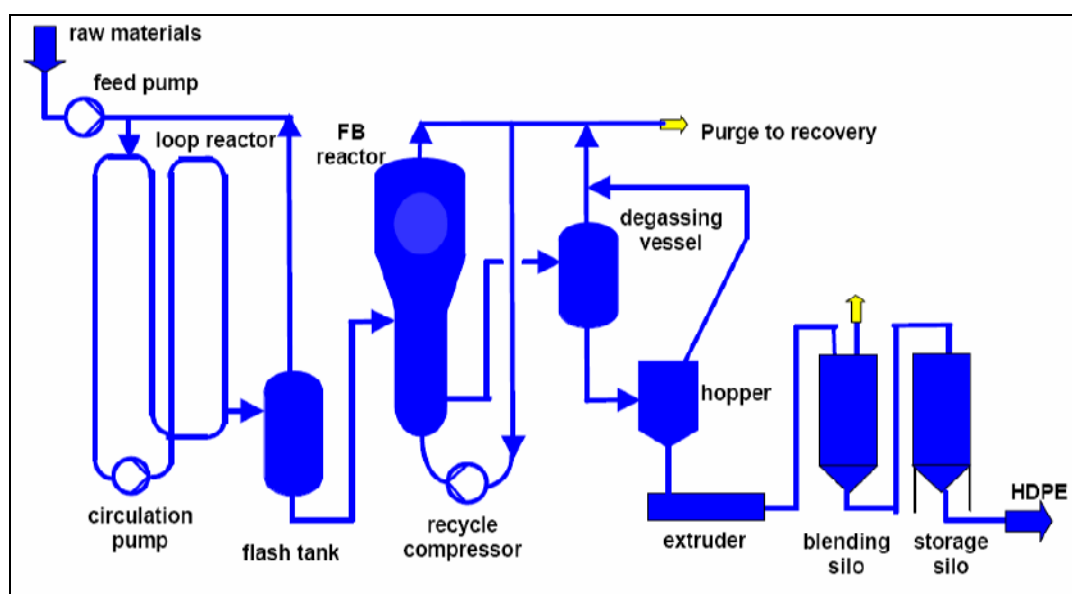

Figure 3.11: Flow diagram showing the HDPE suspension/gas phase process

3.2.3.4 Technical parameters

Reactor type	Fluidised bed	Stirred tank	Loop
Reactor volume	200 - 400 m ³	15 - 100 m ³	15 - 100 m ³
Polymerisation pressure	0.7 - 2 MPa	0.5 - 1 MPa	3 - 6.5 MPa
Polymerisation temperature	80 - 105 °C	70 - 90 °C	80 - 110 °C
Suspending agent	None	C5 - C8 hydrocarbons	Isobutane, hexane, propane
Catalyst/cocatalyst	Organometallic compound, Aluminium alkyl	Organometallic compound, Aluminium alkyl	Organometallic compound, Aluminium alkyl
Max. plant capacity	450 kt/yr	320 kt/yr	350 kt/yr

Table 3.6: Technical parameters of HDPE

3.2.4 Linear low density polyethylene

3.2.4.1 Solution process

In the solution reactor, the polymer is dissolved in a solvent/comonomer system. Typically, the polymer content in a solution reactor is controlled at between 10 and 30 wt-%. A hydrocarbon solvent in the range of C6 to C9 is typically used as the diluent in the solution process.

α -olefins in the range from propylene to decene-1 can be used as a comonomer. The solution process is very suitable for making copolymers based on higher α -olefins such as hexene-1 and octene-1, as these comonomers are very compatible with the solvent system. Furthermore, the solution process is the only process suitable to make copolymers with higher α -olefins such as octene-1. Companies having a technology foothold in the polyethylene solution process include Dow, DSM (Stamcarbon Compact process), Nova Chemicals (Sclairtech process) and Mitsui. Both Ziegler-Natta and metallocene coordination catalysts can be applied in the solution process.

Due to the fact that polar components will act as catalyst poison, all feed streams to the reactor, including recycling streams, have to pass purification through beds. After cleaning, all feed streams are pressurised to reactor pressure. Typically, the solution reactor pressure is controlled at between 3 and 20 MPa, while the reactor temperature is typically maintained above 100 °C. However, they can differentiate in respect of single and dual reactor configuration and whether the reactors are run adiabatically or with external cooling. Single or dual reactor systems are dictated by product mix requirements. The use of external cooling can increase the polymer content in the reactor. This is favourable for the consumption of energy as less solvent has to be evaporated, but will add to the construction cost of the reactor. The reactor effluent is sent to heaters and solvent evaporators.

The product is processed and granulated by means of an extruder and/or gear pump system. Additives are typically added by means of a side arm extruder. At this stage, the solution process has an energy advantage because it does not require a polymer melt step compared to the gas phase and slurry processes. The finishing and storage stages are identical to other polyethylene processes. The solvent evaporator overhead is condensed and sent forward for purification and mixing with other feed streams.

In the recycling stage, the following purge flows are taken away from the process:

- small liquid purge stream to remove excess solvent and inert impurities from the process. Typically, this stream is used as fuel for a steam boiler or sold as naphtha feedstock
- small gaseous purge stream to remove residual volatile inerts from the process. This stream is typically recycled back into a cracker or used as fuel in a furnace.

Figure 3.12 depicts a general flow diagram for the solution processes applied by the various producers. Although the process steps shown are generic, the actual design and operation conditions of unit operations in these process steps might differ significantly from producer to producer and are considered as proprietary knowledge.

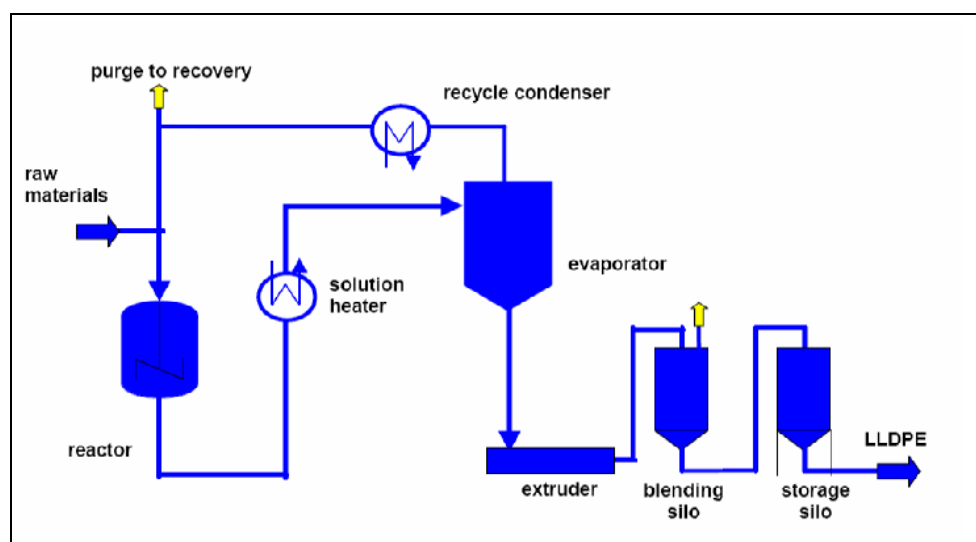

Figure 3.12: Flow diagram showing the LLDPE solution process

3.2.4.2 Fluidised bed reactor

The fluidised bed reactor used for the production of LLDPE is the same as for the production of HDPE described above in Section 3.2.3.2 and is not described again. A number of fluidised bed reactor plants are designed to produce both HDPE and LLDPE according to market requirements but, in general, plants tend to operate and produce one type only.

3.2.4.3 Technical parameters

Process	Gas phase	Solution
Reactor temperature	80 - 105 °C	>100 °C
Reactor pressure	0.7 - 2 MPa	2 - 20 MPa
Polymer content in reactor	Not applicable	10 - 30 wt-%
Residence time in reactor	1 - 3 hours	5 - 30 minutes
Solvent	C5 - C7 hydrocarbons	C6 - C9 hydrocarbons
Comonomer	butene-1, hexene-1	propylene, decene-1
Catalyst	Ziegler or metallocene	Ziegler-Natta or metallocene
Max. capacity	450 kt/yr	300 kt/yr

Table 3.7: Technical parameters of LLDPE

3.2.5 Polypropylene

Most of the processes applied for the production of polypropylene are very similar to the ones used to produce high density polyethylene. Nevertheless, this section describes the most important and most widely used processes for the production of polypropylene. Generally, two different types of processes are applied in the production of polypropylene:

- gas phase processes
- suspension processes.

The traditional suspension processes using an organic diluent, are known within the PP nomenclature as 'slurry' processes. Modern suspension processes use a liquid monomer instead of a solvent. And they are known in the PP world as 'bulk' processes.

3.2.5.1 Catalysts used for the production of polypropylene

The further development of the catalysts used for polypropylene synthesis had far-reaching consequences for process development. Due to the development of new processes based on the possibilities offered by the new catalysts and the changing range of properties of polymers, the development of catalysts for polypropylene synthesis will be briefly described:

3.2.5.1.1 1st generation catalysts

These catalysts were first introduced in the 1960s in slurry processes. The active centres of these catalysts are located at points of missing chlorine atoms in TiCl_3 crystals. These catalysts have low yields (1 t/kg catalyst), produce 5 to 10 % atactic polypropylene and require de-ashing and atactic removal from the final product

3.2.5.1.2 2nd generation catalysts

These have been in use since the 1970s in suspension and gas phase processes, and their yields are around 10 t/kg catalyst. De-ashing is still required and the content of atactic product is 3 - 5 %.

Solvay catalysts:

These catalysts were developed from the 1st generation. At low temperatures (below 100 °C) the active violet γ or δ form of the brown β - TiCl_3 is formed. Through the smaller size of the primary crystallites, the surface area and activity of the catalyst was increased. The 1st and 2nd generation catalysts (unsupported catalysts) were used in suspension processes with hexane as a solvent, in mass polymerisation processes (Rexene, Phillips), in the BASF gas phase process (vertical agitation) and in the solution process (Eastman).

First supported catalysts:

TiCl_3 was still used as active catalyst species. Solvay started using MgO and $\text{Mg}(\text{OH})_2$ as support (carrier) for the titanium components. Later on milled (activated) MgCl_2 with a special random crystal structure was used. Further improvement was achieved through Lewis bases (electron donors) by which the isotacticity of the product was increased with no significant reduction in the activity of the catalyst. All 1st and 2nd generation catalysts had to be removed from the polymer.

3.2.5.1.3 3rd generation catalysts

These have been in use since the 1980s in both suspension and gas phase technology, and their yields are 15 - 25 t/kg with a content of atactic product of around 5 %.

These catalysts consist of milled catalytic components on a support material (synthesis procedure: mill MgCl_2 with internal donor, titanate at a high temperature with TiCl_4 , wash with boiling heptanes, dry, polymerised with $\text{Al}(\text{C}_2\text{H}_5)_3$). A great increase in activity for 3rd generation catalysts was achieved through separate titanation. No removal of catalyst residues is needed. Still, the atactic polymer has to be removed. Thus, the production processes with 3rd generation catalysts do not differ too much from older processes. Only the 'simplified slurry' process of Montedison and Mitsui made cleaning of the polymer from the catalyst and atactic PP obsolete.

3.2.5.1.4 4th generation catalysts

4th generation catalysts are the current industry standard. Their yield is 30 – 50 t/kg and the content of atactic product is 2 – 5 %.

4th generation catalysts consists of phthalate/silicon donors and a spherical support which is used for a fluid monomer in a homopolymer reactor. This generation of catalysts made a cleaning of the polymer from catalyst and atactic shares obsolete. A wealth of processes and process variants were developed. The processes described in Sections 3.2.5.2 and 3.2.5.3 were introduced in this development phase.

3.2.5.1.5 5th generation catalysts

These catalysts extend the performance of 4th generation PP catalysts. They are based on, e.g. new diether and succinate donor technology leading to an increased activity and improved product performance. Higher yields result in lower catalyst residues and lower specific catalyst consumption per tonne of polymer. Furthermore, these catalysts extend the production capability and product range of single reactor plants.

3.2.5.1.6 Metallocene catalysts

Today, less than 5 % of polypropylene is produced using metallocene catalysts. Metallocene catalysts are mainly ZrCl_2 catalysts supported on silica in combination with co-catalysts like methylaluminoxane (MAO). These catalysts show very specific characteristics and may also be combined with Ziegler-Natta catalysts. These catalysts are mainly used to produce specific product ranges and they influence plant configurations.

3.2.5.2 Suspension processes

A flow diagram of the traditional polypropylene suspension ('slurry') process is shown in Figure 3.13. Propylene, diluent (C_6 to C_{12} saturated hydrocarbons), hydrogen, a catalyst and a cocatalyst are continuously fed to the polymerisation section, which normally consists of one or more stirred tank reactors in series. Polymerisation is carried out at 60 – 80 °C and at pressures below 2 MPa. The polymerised polypropylene forms small powder particles suspended in the diluent. A small amount of atactic polypropylene is formed as a by-product in the polymerisation step and is partly dissolved in the diluent. The slurry is continuously withdrawn from the last reactor after which unreacted propylene is removed from the slurry and recycled to the reactor.

Next the polymer slurry is either treated in an alcohol and water wash system or fed directly to a slurry concentrating device (centrifuges) from where the wet polymer powder is fed to a dryer. After the dryer, the polymer powder is transferred to the extruder, where additives are mixed in, the powder is melted, homogenised and cut into pellets in a similar way as in other polyolefin processes.

The treatment of the polymer slurry from the reactor depends on the type of catalyst used in the polymerisation. Originally the slurry PP processes were designed for use of low activity and low stereospecific catalysts (2nd generation). This meant that both catalyst residues and atactic PP had to be removed to get an acceptable final product. The polymer slurry was put in contact with alcohol and water in a sequence of washing steps to decompose and extract the catalyst residues from the polymer. The polymer powder was then removed from the liquid phase by, e.g. centrifuges, washed and dried. The alcohol/water solution, containing catalyst residues and the diluent/atactic PP solution, was purified in an extensive distillation unit to recover alcohol and diluent for re-use in the process. The catalyst residues were discharged from the process with the waste water stream. The atactic PP was separated and recovered as a by-product from the recycled diluent. Both the alcohol and diluent recovery systems were energy intensive (typical steam consumption ≥ 1 t steam/t PP).

Today this traditional slurry PP process, including alcohol/water wash, is used only for production of speciality products like capacitor films and medical applications, where it is necessary to remove all traces of the catalyst from the final product.

Some producers have converted their slurry plants to use high yield catalysts. In these plants the alcohol/water wash is by-passed or removed, which reduces the energy consumption and waste streams.

Some PP plants originally designed to use low activity/low stereospecific catalysts in bulk reactors (loop or CSTR reactors) have been converted to use 4th generation catalysts. These processes are similar to the ones described in Sections 3.2.5.2.1 and 3.2.5.2.2.

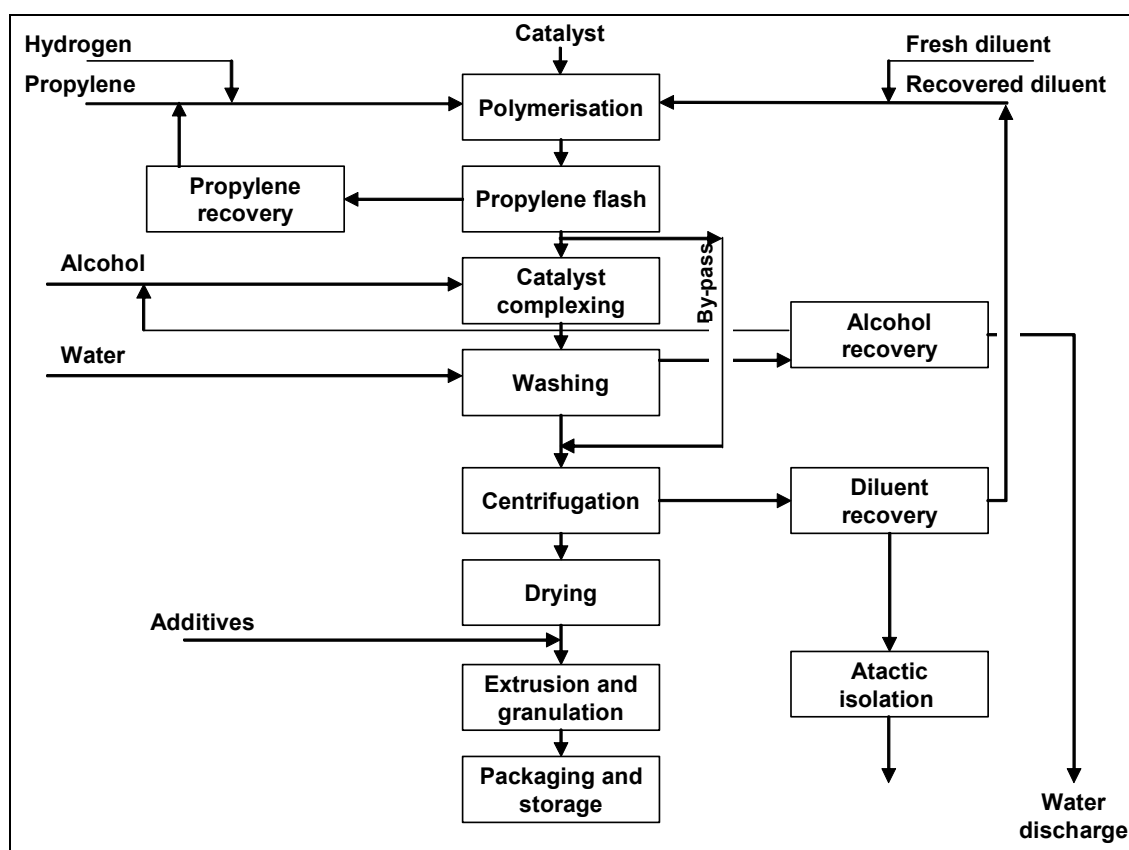

Figure 3.13: Generic flow diagram showing the traditional suspension ('slurry') process

The individual suspension PP processes of various manufacturers differ with respect to process conditions and equipment employed. In modern PP suspension processes the polymerisation of homopolymers and random copolymers takes place in liquid propylene (bulk polymerisation). The polymerisation can be continued in one or several gas phase reactors, especially when impact copolymer is produced. Examples of these types of processes are:

- the Spheripol process
- the Hypol process
- the Borstar process

These processes will be described in more detail in the following sections.

3.2.5.2.1 Spheripol process

Figure 3.14 shows the process flow diagram for a plant according to the Spheripol process. It can be used to produce homopolymers and impact resistant copolymers, depending on the catalyst used. The activity of the catalyst systems is high enough so that they do not need to be removed from the product. The concentration of the remaining catalyst is less than 100 g/t including all inert supporting material and depends on the process used. The high stereospecificity of the catalyst prevents the formation of atactic PP and thus, atactic PP does not have to be removed from the polymer.

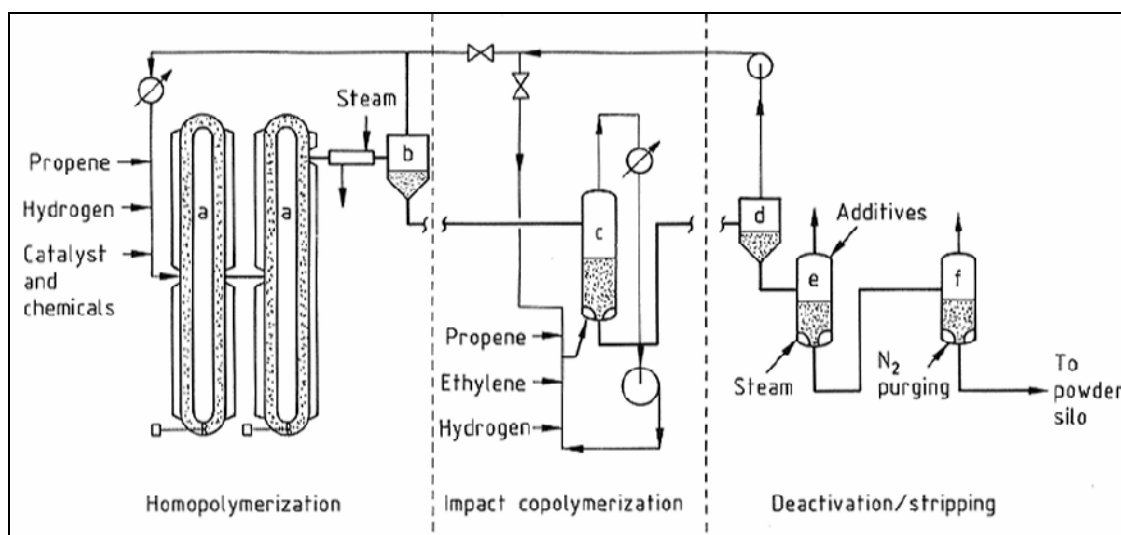

Figure 3.14: Flow diagram of the Spheripol polypropylene process
[15, Ullmann, 2001]

- A) loop reactors
 B) primary cyclone
 C) copolymer fluidised bed
 D) secondary and copolymer cyclone
 E) deactivation
 F) purging

Polymerisation is carried out at temperatures of approximately 70 °C and pressures of around 4 MPa in liquid propylene which circulates in one or more loop reactors. A single axial agitator in each loop ensures high volume flowrates and thus a good exchange of heat to the water-cooled reactor walls. This also prevents particles from precipitating out of the suspension. The typical polypropylene concentration is approximately 40 wt-%. The catalyst, cocatalyst and a stereoregulator on the basis of a Lewis base are continuously fed into the reactor. The first seconds of polymerisation with the fresh, highly active catalyst are decisive for the course of the reaction. This is why some plants have a pre-polymerisation stage in which the catalyst components react at a lower temperature and monomer concentration. This can take place in a stirred tank or loop reactor. The pre-polymerised material is then put into the loop reactor as normal. The mean residence time for a single reactor is one to two hours. Two loop reactors can be operated in series to even out the dwell time, modify the polymer and increase production.

A continuous flow of suspension runs through the heated zone into a cyclone. This cyclone is directly connected to the cyclone of the deactivation/stripping step during homopolymer production; the copolymerisation stage is hereby bypassed. Any propylene which does not react, is evaporated in the first cyclone, is condensed with cooling water and recycled back into the reactor. A compressor is required for the second cyclone. The polymer is then conveyed into tanks and the catalyst deactivated with steam. Residual moisture and volatile substances are removed with a flow of hot nitrogen before the polymer is conveyed to the storage tank and stabilised or extruded into granulate.

3.2.5.2.2 Hypol process

Mitsui developed an analogue suspension process using their own catalyst system. The process differs from the Spheripol process in a way that a pre-polymerisation takes place in a CSTR in connection with a washing step. Two autoclave reactors are used in series; the heat is dissipated to the reactors by evaporating liquid propylene. The suspension is then forwarded to a heated and agitated evaporation reactor in which polypropylene is removed from the polymer and returned to the production process, similar to the Spheripol process. The two processes thus only differ with respect to the reactors and catalysts used, allowing a common consideration of the data for emission and consumption values.

3.2.5.2.3 Borstar process

The Borstar PP process is based on the Borstar PE process described in Section 3.2.3.3. When homopolymers and random copolymers are produced, the reactor configuration consists of a propylene bulk loop reactor and a fluidised bed gas phase reactor operated in series. During heterophasic copolymer production, the polymer from the first gas phase reactor is transferred into a second smaller gas phase reactor where the rubbery copolymer is made.

The catalyst is continuously pre-polymerised before entering the main loop reactor, which is designed for supercritical conditions and typically operated in the temperature range of 80 to 100 °C and 5 to 6 MPa pressure with propylene as the diluent (bulk polymerisation). The slurry from the loop reactor is fed directly into the gas phase reactor without any flash separation step. The gas phase reactor is typically operated at 80 to 100 °C and 2.2 to 3 MPa.

The powder withdrawn from the gas phase reactor is separated from the associated gas and purged with nitrogen to remove residual hydrocarbon before it is transferred to extrusion. The recovered gas is compressed and returned to the gas phase reactor. Because most of the propylene from the loop reactor is consumed in the gas phase reactor, the recycle stream to the loop reactor is very small.

A second gas phase reactor is used to produce the rubber phase of a heterophasic copolymer. The powder is withdrawn, purged with nitrogen and sent to extrusion like in the homopolymer case. The gas associated with the powder is recovered and recycled back to the gas phase reactor.

The Borstar PP process concept combined with a special nucleation technology broadens the product flexibility in terms of MFI, molecular weight distribution, comonomer distribution, softness and rigidity. Due to the high operating temperature, the catalyst activity is typically 60 - 80 kg PP/g catalyst.

3.2.5.3 Gas phase processes

In gas phase processes, gaseous propylene comes into contact with the solid catalyst which is intimately dispersed in dry polymer powder. Industry uses two different methods of carrying out this reaction depending on the chosen method of heat removal. The Unipol PP process uses a modification of the Unipol polyethylene fluidised bed system. The Novolen PP process and Innovene PP process use mechanically agitated dry powder beds with evaporative cooling in vertical and horizontal reactors, respectively. Unipol PP was originally developed by Union Carbide and Shell, the Novolen PP process by BASF and the Innovene PP process by Amoco.

3.2.5.3.1 Gas phase process in a fluidised bed reactor

The typical feature of this process is the fluidised bed reactor which widens at its top to reduce the gas velocity and entrainment of particles. Continuously fed flows of catalyst, monomer and hydrogen are mixed thoroughly in the fluidised bed. A large cooler in the loop for gas recirculation draws off the reaction heat from the considerable gas volume flows. In this system, the fluidised bed reactor acts like a back-mixing autoclave reactor; there is no excessive separation of coarse particles. For copolymerisation, a second fluidised bed reactor is added (as shown in Figure 3.15). The reaction conditions are below 88 °C and 4 MPa.

The polymer and associated gases are discharged from the reactor directly above the distributor plate with time-controlled valves passing through a cyclone into a tank filled with nitrogen to remove residual monomers from the polymer. With modern catalysts, neither the catalysts nor the atactic polymers have to be extracted.

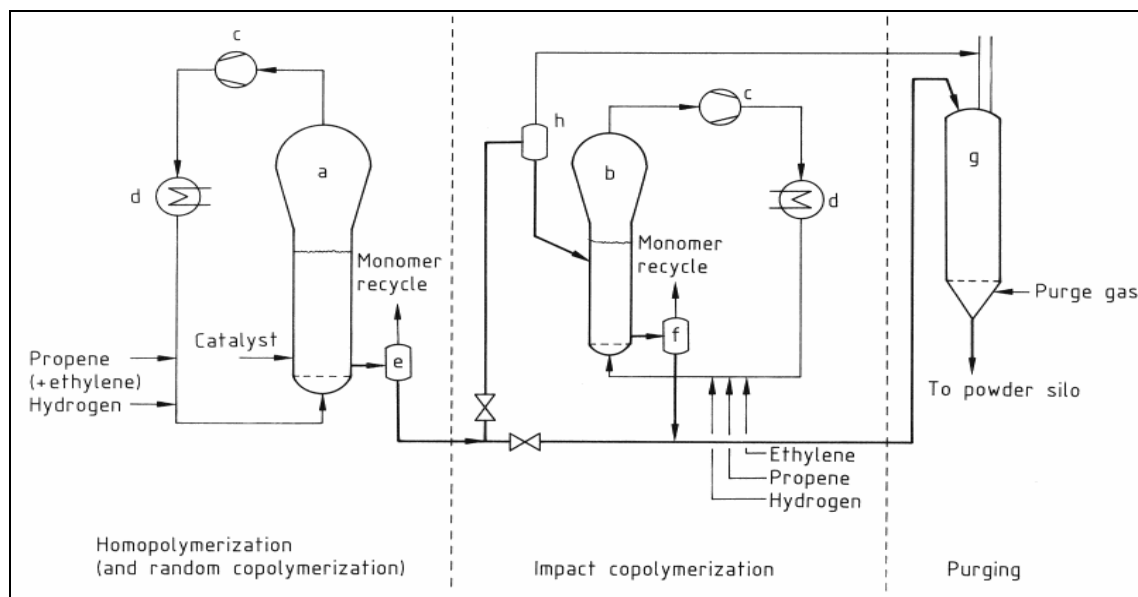

Figure 3.15: Flow diagram of the polypropylene fluidised bed gas phase process
[15, Ullmann, 2001]

A)	primary fluidised bed	B)	copolymer fluidised bed	C)	compressors
D)	coolers	E + F)	discharge cyclones	G)	purge

3.2.5.3.2 Gas phase process in a vertical reactor

Figure 3.16 shows the continuous process for making homopolymers, impact copolymers, and random ethylene-propylene copolymers using high activity, highly stereospecific catalysts. The reactor vessels with capacities of 25, 50, or 75 m³, are equipped with proprietary helical agitators, which give excellent agitation. Homopolymerisation only needs the primary reactor, into which the catalyst components are fed. These must be very well dispersed in the powder bed to avoid build-up. The reaction conditions of 70 – 80 °C and 3 – 4 MPa ensure that the monomer phase is gaseous in the reactor. Low concentrations of hydrogen are used to control the molecular mass over wide ranges. The temperature is controlled by removing gaseous propylene from the reactor head space, condensing it with cooling water, and then recycling it back into the reactor, where its evaporation provides the required cooling, as well as further aeration of the stirred powder bed. Each tonne of polymer made requires approximately six tonnes of liquid propylene to be evaporated as coolant.

Powder and associated gas discharge continuously from the primary reactor dip tube directly into a low pressure cyclone. Propylene carrier gas from this cyclone is recycled to the reactor after compression, liquefaction, and sometimes, distillation. The powder then passes to a purge vessel where a deactivator quenches all residual catalyst activity, and nitrogen strips out traces of propylene from the hot powder. From here, powder is conveyed into silos for stabilisation and extrusion into granules. This process also offers a post-granulation steam-stripping package to remove any oligomers and oxidised residues from the granules for demanding applications.

BASF pioneered their gas phase process with commercial production in 1969. The products made were based on high molecular mass polymers (i.e. containing atactic PP and catalyst residues) having reduced stereoregularity. At the beginning of the 21st century, such grades still find niche markets, although they are vulnerable to competition from random copolymers. Production is to be phased out shortly. This process is also carried out with cheaper 2nd generation catalysts like TiCl₃/Al(C₂H₅)₂Cl, which then requires an additional dry powder dechlorination stage.

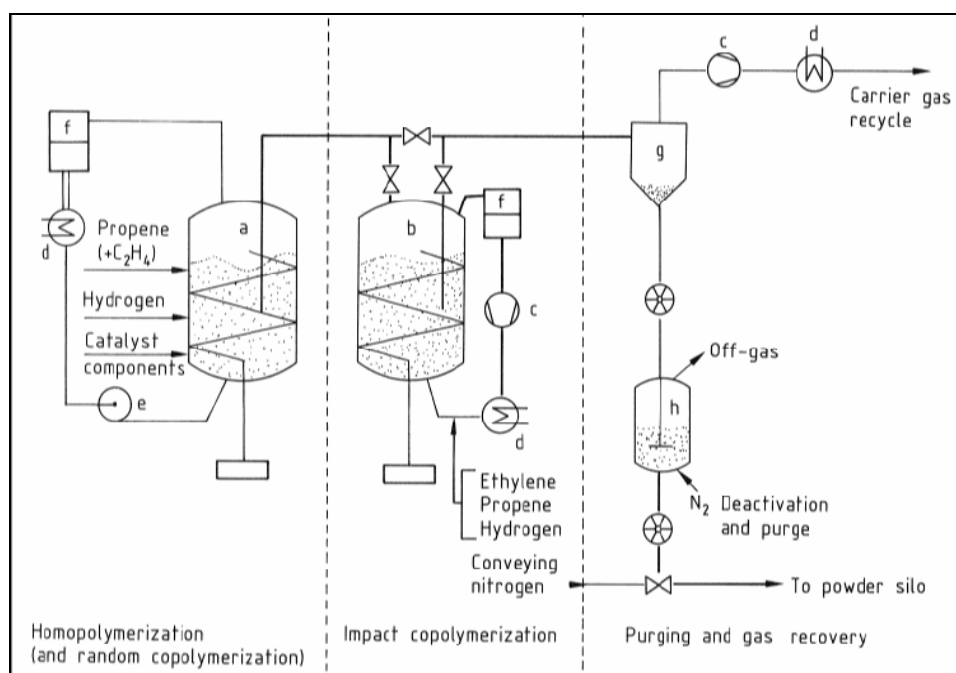

Figure 3.16: Flow diagram of the polypropylene vertical reactor gas phase process [15, Ullmann, 2001]

- A) primary reactor
- B) copolymeriser
- C) compressors
- D) condensers
- E) liquid pump
- F) filters
- G) primary cyclone
- H) deactivation/purge

3.2.5.3.3 Gas phase process in a horizontal reactor

This process uses a horizontally stirred reactor instead of the vertical helical agitator of the process described in Section 3.2.5.3.2. The condensed recycled monomers are sprayed into the top of the reactor provide cooling, while uncondensed monomers and hydrogen injected into the base maintain the gas composition. Figure 3.17 also includes a deactivation and purge step (b) similar to the previously described processes (Spheripol, Hypol, vertical reactor gas phase). All these processes, including the horizontal reactor gas phase, use 4th generation catalysts.

The inventors claim that their reactor achieves some degree of plug flow, roughly equivalent to that of two to three stirred tank reactors in series.

As with the vertical gas phase process, this process was also developed with a second reactor in series for impact copolymer production. In this case, ethylene is added to the second reactor.

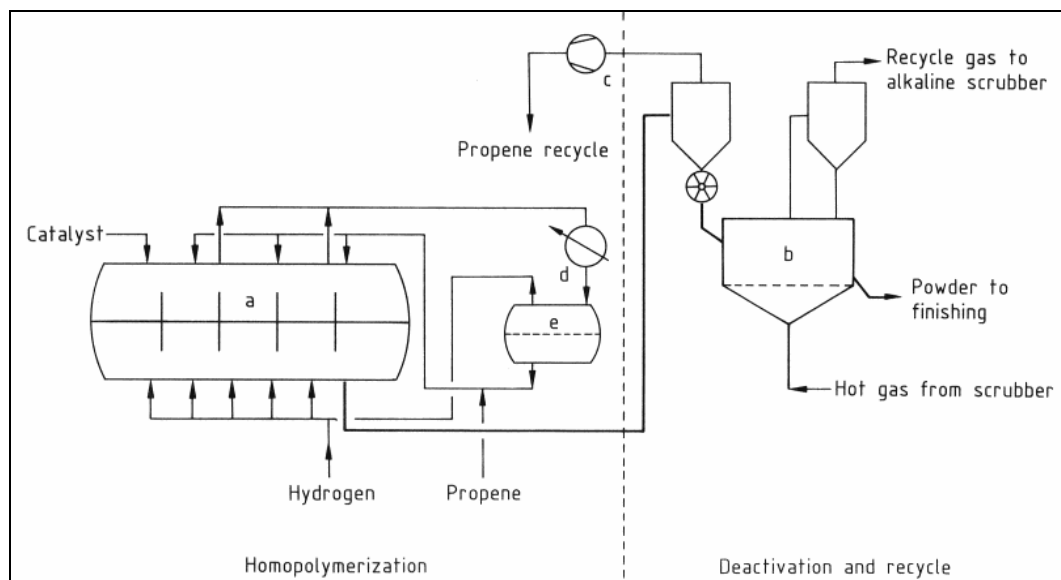

Figure 3.17: Flow diagram of the polypropylene horizontal reactor gas phase process [15, Ullmann, 2001]

- A) horizontal reactor
- B) fluidised bed deactivation
- C) compressor
- D) condenser
- E) hold/separators tank

3.2.5.3.4 Technical parameters

Process	Suspension	Gas phase
Reactor temperature	60 - 80 °C	70 - 90 °C
Reactor pressure	2 - 5 MPa	2 - 4 MPa
Residence time in reactor	2 h (Spheripol)	-
Diluent	Liquid monomer	-
Max. capacity	300 kt/yr	300 kt/yr

Table 3.8: Technical parameters of PP

3.3 Current emission and consumption levels

[2, APME, 2002]

In this section the emission and consumption levels for polyolefin plants show the total average of reporting plants, the average of the top 50 plants and the 3rd and 4th quartile and follows the scheme given in Figure 3.18.

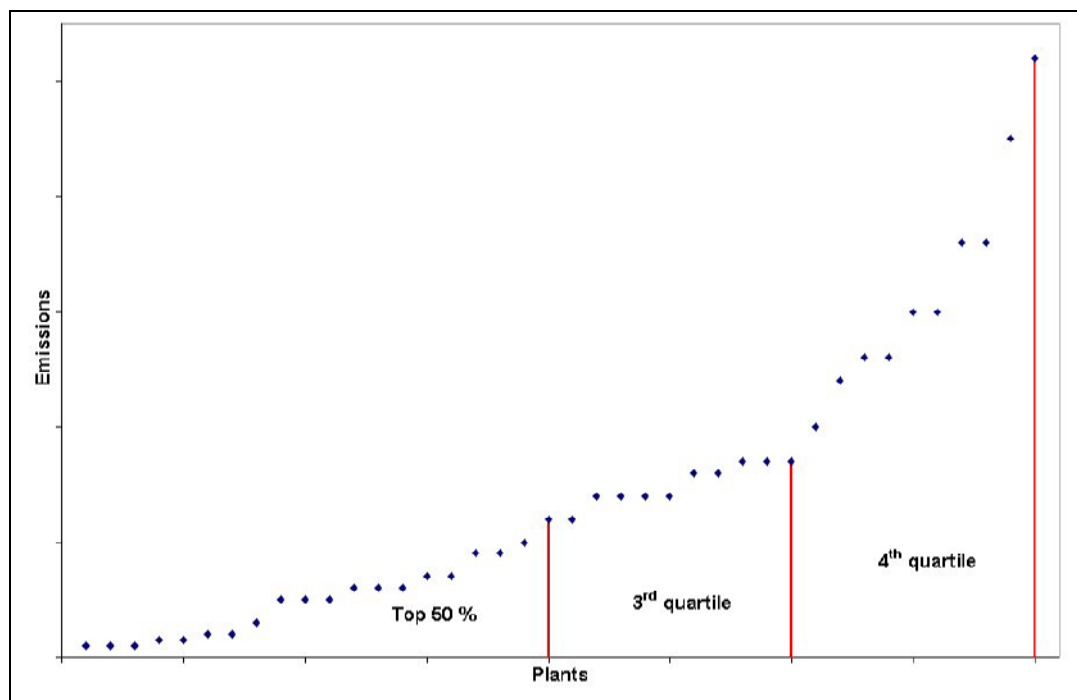

Figure 3.18: Interpretation scheme for emission and consumption data in this section

3.3.1 Low density polyethylene (LDPE)

The emission and consumption data shown in Table 3.9 represent the emission and consumption levels from 27 plants that reported their data. The average age of these plants is 25 years and their average capacity in 1999 was 166 kt per year.

The data for VOC emissions contain point sources as well as fugitive emissions which are calculated according to US EPA-21 method [48, EPA, 1989]. Other calculation standards, like from VDI, will lead to different results, and are therefore not comparable.

LDPE benchmark 1999	European average	Average top 50 %	Average 3rd quartile	Average 4th quartile
Monomer consumption ¹	1018	1005	1018	1044
Direct energy consumption ²	1075	720	1225	1650
Primary energy consumption ³	2600	2070	2750	3500
Water consumption ⁴	2.9	1.7	2.8	5.2
Dust emission ⁵	31	17	29	61
VOC emission ⁶	2400	1270	2570	4530
COD emission ⁷	62	19	60	150
Inert waste ⁸	1.1	0.5	1	2.2
Hazardous waste ⁹	4.6	1.8	5	9.8

1. Monomer consumption in kilograms per tonne of product (kg/t).
2. Direct energy in kWh per tonne of product (kWh/t). Direct energy is the energy consumption as delivered
3. Primary energy in kWh per tonne of product (kWh/t). Primary energy is energy calculated back to fossil fuel. For the primary energy calculation the following efficiencies were used: electricity: 40 %, and steam: 90 %. The large difference between direct energy consumption and primary energy consumption is due to the high share of electrical energy in LDPE processes
4. Water consumption in m³ per tonne of product (m³/t)
5. Dust to air emissions in grams per tonne of product (g/t). Dust includes all dust as reported by the participants
6. VOC to air emissions in grams per tonne of product (g/t). VOC includes all hydrocarbon and other organic compounds including fugitive emissions
7. COD to water emissions in grams per tonne of product (g/t)
8. Inert waste (to landfill) in kilograms per tonne of product (kg/t)
9. Hazardous waste (to treatment or incineration) in kilograms per tonne of product (kg/t)

Table 3.9: Emission and consumption data of LDPE plants

3.3.2 LDPE copolymers (ethylene-vinylacetate copolymer (EVA))

Because of the high concentration of vinylacetate (VA) required in the process gas to produce the required products, the EVA copolymers are of particular interest for the emissions to the air.

The EVA copolymers are generally produced in high pressure lines of smaller capacities, typically between about 20 – 100 kilotonnes per year, to supply the more fragmented and smaller market sizes compared to the LDPE homopolymers.

The VOC emission of EVA copolymer lines is usually higher than reactor lines producing homopolymers, due to the higher solubility of the VA monomer in the polymer. Removal of the VA monomer from the polymer is hampered by its slower diffusion out of the copolymer. During typical degassing times for ethylene homopolymers (8 - 10 hours), more than 90 % of the ethylene is removed from the polymer. In similar degassing times, the residual VA is only removed by 60 %, leaving a substantial amount of VA in the polymer which is comparable to the initial concentration of ethylene in the freshly pelletised product. The higher initial concentration of the VA in the polymer and the significantly slower diffusion out of the polymer require a substantially longer degassing time (three to four times longer). The net effect is a low concentration of the VA in the vent gas of the degassing silo, making thermal treatment of the vent gas unattractive due to the low calorific value of the off gas and thus the need to add fuel to the incinerator. Copolymers based on highly reactive comonomers (e.g. acrylic acid, acrylate) generally do not lead to high residual comonomer contents in the product.

The power and monomer consumption are higher compared to the figures for LDPE homopolymers because of limitations to the maximum conversion to polymer and the limit to the temperatures which can be used in the copolymerisation process. The other performance data for EVA copolymers production and the streams for water, waste water and solid waste are similar to the ones for the homopolymer process. Table 3.10 shows emission and consumption data per tonne of EVA copolymer.

	Unit	Emission/consumption
Monomer consumption	kg	1020
Direct power consumption	kWh	1250
Water consumption	m ³	2.8
Dust emission	g	29
VOC emission	g	4470*
COD emission	g	70
Inert waste	kg	1.3
Hazardous waste	kg	5
(*) depending on the concentration of VA. The value given reflects a copolymer containing 18 wt-% of VA.		

Table 3.10: Emission and consumption data per tonne of EVA copolymer

3.3.3 High density polyethylene (HDPE)

The emission and consumption data shown in Table 3.11 represent the emission and consumption levels of 24 plants that reported their data. The average age of these plants is 15 years and their average capacity in 1999 was 161 kt per year.

The data given in Table 3.11 do not take into account the different properties of the product, such as bimodal polyethylene or high molecular weight polymers, which can lead to a strong deviation in energy and water consumption.

HDPE benchmark 1999	European average	Average top 50 %	Average 3 rd quartile	Average 4 th quartile
Monomer consumption ¹	1027	1008	1024	1066
Direct energy consumption ²	700	570	720	940
Primary energy consumption ³	1420	1180	1490	1840
Water consumption ⁴	2.3	1.9	2.3	3.1
Dust emission ⁵	97	56	101	175
VOC emission ⁶	2300	650	2160	5750
COD emission ⁷	67	17	66	168
Inert waste ⁸	2.8	0.5	2.3	8.1
Hazardous waste ⁹	3.9	3.1	3.9	5.6

1. Monomer consumption in kilograms per tonne of product (kg/t). The high average value is caused by a small number of plants in the 4th quartile
2. Direct energy in kWh per tonne of product (kWh/t). Direct energy is the energy consumption as delivered
3. Primary energy in kWh per tonne of product (kWh/t). Primary energy is energy calculated back to fossil fuel. For the primary energy calculation the following efficiencies were used: electricity: 40 % and steam: 90 %
4. Water consumption in m³ per tonne of product (m³/t)
5. Dust to air emissions in grams per tonne of product (g/t). Dust includes all dust as reported by the participants. Dust emission mainly from drying powder prior to extrusion.
6. VOC to air emissions in grams per tonne of product (g/t). VOC includes all hydrocarbon and other organic compounds including fugitive emissions
7. COD to water emissions in grams per tonne of product (g/t)
8. Inert waste (to landfill) in kilograms per tonne of product (kg/t)
9. Hazardous waste (to treatment or incineration) in kilograms per tonne of product (kg/t)

Table 3.11: Emission and consumption data of HDPE plants

Additionally, the following data are reported by a Member State (Table 3.12):

	Unit	Emission
VOC	g/tonne	640 - 670
Dust	g/tonne	16 - 30
Waste	kg/tonne	5

Table 3.12. Emission data of HDPE plants in Germany
[27, TWGComments, 2004]

3.3.4 Linear low density polyethylene (LLDPE)

The emission and consumption data shown in Table 3.13 represent the emission and consumption levels from eight plants that reported their data. The average age of these plants is 10 years and their average capacity in 1999 was 200 kt per year.

LLDPE benchmark 1999	European average	Average top 50 %	Average 3 rd quartile	Average 4 th quartile
Monomer consumption ¹	1026	1015	1031	1043
Direct energy consumption ²	680	580	655	890
Primary energy consumption ³	1150	810	1250	1720
Water consumption ⁴	1.8	1.1	1.9	3.3
Dust emission ⁵	27	11	28	58
VOC emission ⁶	730	180 - 500	970	1580
COD emission ⁷	68	39	69	125
Inert waste ⁸	1.3	1.1	1.3	1.7
Hazardous waste ⁹	2.7	0.8	2.2	6.9

1. Monomer consumption in kilograms per tonne of product (kg/t)
2. Direct energy in kWh per tonne of product (kWh/t). Direct energy is the energy consumption as delivered
3. Primary energy in kWh per tonne of product (kWh/t). Primary energy is energy calculated back to fossil fuel. For the primary energy calculation the following efficiencies were used: electricity: 40 %, steam: 90 %
4. Water consumption in m³ per tonne of product (m³/t)
5. Dust to air emissions in grams per tonne of product (g/t). Dust includes all dust as reported by the participants
6. VOC to air emissions in grams per tonne of product (g/t). VOC includes all hydrocarbon and other organic compounds including fugitive emissions. VOC emissions depend on the type of comonomer (180 ppm for C4 and 500 ppm for C8)
7. COD to water emissions in grams per tonne of product (g/t)
8. Inert waste (to landfill) in kilograms per tonne of product (kg/t)
9. Hazardous waste (to treatment or incineration) in kilograms per tonne of product (kg/t)

Table 3.13: Emission and consumption data of LLDPE plants

3.3.5 Polypropylene (PP)

Emission and consumption levels for the production of PP have not been reported. In principle, they can be considered to be equivalent to comparable PE processes.

Comparable PP processes are:

- traditional PP suspension (slurry) process with the HDPE slurry process
- PP gas phase process with the production of LLDPE
- PP suspension (bulk) process with a modern PE gas phase process.

Concerning the energy efficiency of PP and PE processes, it should be noted that the energy consumption is strongly related to the nature of the polymers produced. For example, impact PP copolymers as well as bimodal PE often require two or more reactors resulting in a higher consumption for the reactor section. Also high molecular weight polymers require significantly more energy in the extrusion section. For a given process, type differences in polymer properties may cause up to 20 % difference in energy consumption between individual plants. The energy consumption of suspension PP (slurry (solvent) or bulk (liquefied monomer)) processes is comparable with the HDPE slurry process.

Energy and VOC levels are higher in the case of capacitor film production given the specific nature of the process and requirements of the product.

The monomer consumption data of the HDPE process is slightly different for the polypropylene process due to variable purity of the monomer raw material used by polypropylene plants.

In addition, the production of specialities influences the emissions and consumptions of a given process.

3.3.6 Economic parameters for the production of polyethylene

Table 3.14 shows an overview of the production costs for the processes described for the production of polyethylene. All data have been standardised for the different processes by using USD 600/t as the feedstock price for both ethylene and butene-1. As can be seen for all processes, the impact of the feedstock price is about 80 %. All data used are based on ChemSystem (1996/97 for LDPE and LLDPE, 1999/2000 for HDPE) data for new large scale plants.

Product	LDPE	LLDPE	LLDPE	HDPE	HDPE	HDPE
Technology	Tubular	Gas phase	Solution	Gas phase	Slurry loop	Slurry vessel
Comonomer	None	Butene-1	Butene-1	Butene-1	Butene-1	Butene-1
Catalyst/initiator	Peroxide	Ziegler-Natta	Ziegler-Natta	Ziegler-Natta	Ziegler-Natta	Ziegler-Natta
Capacity (kt/yr)	300	250	250	200	200	200
Total plant capital (USD million)	141	105 - 114	154	90 - 97	108	121 - 138
Production costs (USD/t)						
Monomer + comonomer	597	603	600	603	600	600
Other raw materials	18	36	36	30	30	30
Utilities	25	20	28	22	30	28
Variable costs	640	659	664	655	660	658
Direct costs	17	17	21	20	21	23
Allocated costs	17	17	22	19	21	24
Total Cash costs	674	693	707	694	702	705
Depreciation	59	55	77	59	68	81
Total production costs	733	748	784	753	770	786

Table 3.14: Economic parameters of polyethylene production

4 POLYSTYRENE

[3, APME, 2002, 15, Ullmann, 2001]

4.1 General information

Polystyrene belongs to the group of standard thermoplastics that also includes polyethylene, polypropylene, and polyvinyl chloride. Because of its special properties, polystyrene can be used in an extremely wide range of applications.

Styrene was first isolated in 1831 by Bonastre from the resin of the amber tree. In 1839, E. Simon, who also first described the polymer, gave the monomer its name. Around 1925, the development of an industrial production process for polystyrene (the molecular structure shown in Figure 4.1) began; this work achieved success in Germany in 1930. In the United States, polystyrene was first produced on a commercial scale in 1938.

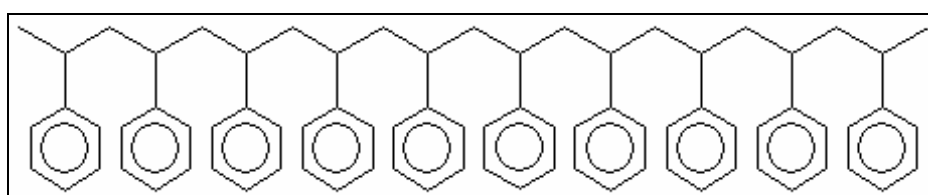

Figure 4.1: Molecular structure of polystyrene

Polystyrene is consumed at a rate of 16.7 Mt/yr worldwide, out of which 4.2 Mt/yr is used in Europe. The average growth rate of polystyrene consumption is 4 % worldwide and only 2.4 % in Europe. The annual polystyrene usage including the export demand of world regions in 2000 is listed in Table 4.1.

Region/year	1980	1990	2000
Western Europe	1.6	2.5	3.7
Eastern Europe	0.1	0.2	0.5
NAFTA	1.3	2.3	4.1
Asia Pacific	1.7	3.5	6.8
South America	0.5	0.5	0.6
Africa and Western and Middle Asia	0.1	0.3	1
World	5.3	9.3	16.7

Table 4.1: Development of worldwide polystyrene usage in Mt/yr

In practice, three different types of polystyrene are distinguished. The transparent and brittle polymer is called general purpose polystyrene (GPPS), the white, non-shiny but relatively flexible, rubber modified polystyrene is called (high) impact polystyrene (IPS or HIPS). Expandable or foam polystyrene (EPS) is the third group to distinguish here due to its different production techniques.

4.1.1 General purpose polystyrene (GPPS)

GPPS is a hard, transparent material with a high gloss. It is most commonly described as general purpose (GP) polystyrene but terms such as standard polystyrene, normal polystyrene, clear polystyrene, or styrene homopolymer are also in use. In this section, the definition polystyrene (PS) moulding material is used according to ISO 1622-2. Below 100 °C PS moulding materials solidify to give a glasslike material with adequate mechanical strength, good dielectric properties, and resistance towards a large number of chemicals for many areas of application. Above its softening point, clear polystyrene softens and allows the resin to be readily processed by common industrial techniques such as injection moulding or extrusion. PS moulding material may contain small quantities of lubricants (internally or externally) to help process the resin for end usage. The addition of antistatic agents, UV stabilisers, glass fibres, or colourants via compounding is also common.

GPPS offers excellent transparency, mouldability and heat stability with low specific gravity – which allows the injection moulding or extruding of very economic specimens. There are varieties of grades available with a wide range of choices to match the needs of the consumers. The main application areas are disposable cups, small containers, disposable kitchen utensils, cosmetic cases, dust covers for electronic equipment, coatings for gloss papers, refrigeration trays, CD and jewel boxes, medical pipettes, petri dishes and meat trays.

4.1.2 High impact polystyrene (HIPS)

The mechanical properties of the relatively brittle PS moulding materials can be considerably improved by adding rubbers, i.e. polybutadiene. High impact polystyrene is also known as toughened PS or rubber-modified PS; ISO 2897-2 defines it as impact resistant polystyrene (IPS). Early production processes for HIPS were based on mixing PS moulding materials with a rubber component. Polymerisation of styrene in the presence of polybutadiene is, however, much more effective. A two-phase system is formed due to the immiscibility of polystyrene and polybutadiene. Polystyrene forms the continuous phase (matrix) and polybutadiene does the disperse phase (rubber particle). The rubber particles contain small inclusions of polystyrene. The rubber particles in HIPS generally have a diameter of 0.5 – 10 µm. They, therefore, scatter visible light and the transparency of the PS moulding materials is lost. Figure 4.2 shows the structure of HIPS containing the polystyrene and polybutadiene chains. The additives commonly used with moulding PS grades can also be compounded into HIPS. In addition, antioxidants are used for rubber stabilisation and flame-retardants are added for special PS applications.

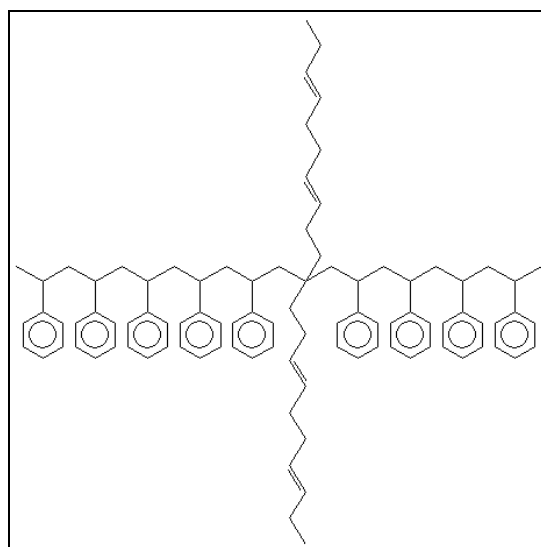

Figure 4.2: Molecular structure of high impact polystyrene

High impact polystyrene (HIPS) has many uses and applications because of its ease of processing, low cost and high performance. It is converted to products by injection moulding, extrusion and thermoforming. Major end uses include packaging, disposable containers and cups, consumer electronics, razors, audio and video cassettes, TV cabinets, refrigeration liners, computer housings, and toys. HIPS is also used to make engineering resin blends with polyphenylene oxide for the automotive industry.

Table 4.2 shows the main polystyrene production (GPPS and HIPS) in the EU-15 in 2000.

Producer	Capacity kt/yr	Locations
Company A	470	FR, UK, ES
Company B	602	BE, DE, ES
Company C	450	DE, FR, SE
Company D	630	BE, DE, ES, NL, EL, UK
Company E	390	IT, BE
Company F	280	UK, NL

Table 4.2: PS (GPPS + HIPS) producers in EU-15 in 2000

4.1.3 Expandable polystyrene (EPS)

The techniques used for the production of expandable polystyrene (EPS) beads and their processing to expanded polystyrene foams were developed at the end of the 1940s by BASF who marketed the new raw material under the trade name Styropor. Due to licensing and the expiry of patents, other raw material manufacturers and trade names have appeared. Expandable polystyrene is produced by suspension polymerisation of styrene with the addition of blowing agents; the resulting polymer beads are then sieved into various bead sizes. Depending on the end use, different coatings may be applied.

In their final form, EPS foams contain about 95 % air by volume. The most important product properties of EPS foams are their excellent thermal insulation, good strength and shock absorption even at low densities. The major applications of lightweight rigid EPS foam in Europe are in the construction industry, as thermal insulation for walls, cavities, roofs, floors, cellars and foundations. Boards, either cut to shape from blocks or contour-moulded at densities typically ranging from 10 – 50 kg/m³, are used either as such or in combinations with other building materials, to manufacture laminated elements, sandwich panels, etc. The success of EPS foam as a packaging material is based upon overall properties as well as its cost-effectiveness. Moulded boxes are equally suitable for packing highly sensitive instruments, fragile glass, ceramic products and heavy machine parts, as well as for perishable food such as fish, fruit and vegetables. EPS packaging has contributed to outstanding savings by reducing damage, shipping weight and labour costs.

Table 4.3 shows the main EPS producers in the EU-15 in 2000.

Producer	Capacity kt/yr	Locations
Company A	228	DE, ES
Company B	145	FR, DE
Company C	40	DE
Company D	90	IT, BE
Company E	295	FR, NL, UK
Company F	54	NL
Company G	50	NL
Company H	70	FI

Table 4.3: EPS producers in the EU-15 in 2000

4.2 Applied processes and techniques in the production of polystyrene

4.2.1 Process overview

The process of producing polystyrene requires one reactor or a series of reactors controlled by a set of parameters such as temperature, pressure, and conversion rate. The process requires the addition of several raw materials, i.e. solvent, initiator (optional), and chain transfer agents, into the reactors under well-defined conditions. The reaction heat is removed by transfer to the new incoming feed and/or by the evaporation of solvent and/or by heat transfer medium, i.e. circulating oil.

The crude product coming out of the reactor train has a solid content of between 60 and 90 %. To remove the unconverted monomer and solvent from the crude product, it is heated to about 220 – 260 °C and led through a high vacuum. This is called the devolatilisation step and can have one or two stages. Finally, the cleaned, high purity polymer is granulated. The monomer and solvent are stripped in the devolatilisation section and recycled within the process.

4.2.1.1 Chemistry of polystyrene production

When styrene is polymerised, polystyrene is formed. The polymerisation of styrene is a chain growth reaction and it is induced by any known initiation techniques such as heat, free radical, anionic or cationic addition. The product polystyrene is a white polymer with high clarity and good physical and electrical properties.

During polymerisation, the vinyl bond of the styrene molecule disappears and ~ 710 kJ/kg heat is released (equivalent to the heat of hydrogenation of the double bond). The density increases from 0.905 g/cm³ of the pure monomer to 1.045 g/cm³ of the pure polymer and is a linear function to the conversion. The molecular weight increases from 104 g/mole of the monomer to values between 200000 and 300000 g/mole of the polymer.

Five different chemical reactions are responsible for converting a monomer to a polymer. These steps are:

- initiation to form radicals
- initiation of chains
- propagation or chain growth
- chain transfer
- termination of the active chain ends.

4.2.1.1.1 Initiation

Styrene is able to undergo spontaneous polymerisation by heat. Styrene can generate enough free radicals when ample heat is applied. These radicals then participate in the propagation steps with an excess amount of styrene monomers to form high molecular weight polymers at high conversion rates.

An alternative method of initiating styrene polymerisation depends on the addition of free radical generators. Various catalysts are used at different temperatures depending on their rates of decomposition, but only peroxides are used extensively in industrial production processes. Other classes of initiators are usually either not readily available or not stable enough under the conditions of styrene polymerisation.

4.2.1.1.2 Propagation

Figure 4.3 shows the mechanism of propagation in a radical polystyrene polymerisation. When there is an excess of monomer, the addition of styrene to the chain ends is repeated and polymer chains are formed. The composition of the polymer chain mostly depends on temperature and time.

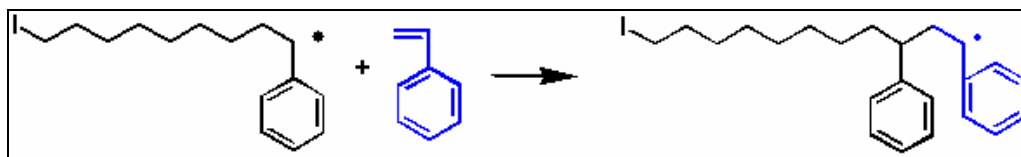

Figure 4.3: Chain propagation in the polystyrene process

4.2.1.1.3 Chain transfer

During the chain transfer, active radicals are exchanged between the growing chain and the chain transfer agent. This results in the deactivation of the growing chain. The radical is then carried forward by the now decomposed chain transfer agent and will start another polymer chain. Chain transfer agents are widely used in the production of polystyrene to regulate the length of the polymer chain and consequently the melt flow of the finished product. The most commonly used chain transfer agents are various mercaptan derivatives.

4.2.1.1.4 Termination

During termination, the active free radicals disappear by reacting with another radical and, therefore, they form either inactive entities or unsaturated bonds at the end of the chain. The termination of radicals is an extremely rapid reaction and requires little or no activation energy.

4.2.1.2 Raw materials

4.2.1.2.1 Styrene

Pure styrene is clear and any colour formation is normally caused by contamination, such as metal rust. Styrene has the outstanding capacities in order for it to be polymerised readily through a variety of methods and to be copolymerised with a large variety of other monomers (acrylates, methacrylates, acrylonitrile, butadiene and maleic anhydride). Therefore, the greatest concern during storage of styrene is the prevention of self-polymerisation which is a runaway reaction. The most important factors in maintaining a long shelf life for styrene are: low temperatures, adequate inhibitor levels, correct construction materials for storage and handling equipment, and good basic housekeeping.

To inhibit polymer formation and oxidative degradation during shipment and subsequent storage, an inhibitor TBC (4-tert-butylcatechol), is added. TBC prevents polymerisation by reacting with oxidation products (peroxides forming free radicals) in the presence of a small amount of oxygen. The inhibitor level must be maintained above a minimum concentration at all times which is 4 to 5 ppm. The standard level of TBC is 10 to 15 ppm.

4.2.1.2.2 Free radical initiators

Free radical initiators are used to either improve line productivity, by creation of radicals at a lower temperature than thermal initiation and/or to improve the quality of HIPS. During styrene polymerisation, organic peroxides are usually used at less than 1000 ppm of concentration.

4.2.1.2.3 Chain transfer agents

The chain transfer process is defined as one in which 'the active centre is transferred from one polymer molecule to another molecule, leaving the former inactive and endowing the latter with the ability to add monomers successively'. The molecule to which the activity is transferred is the chain transfer agent. The function of the chain transfer is to reduce ('regulate') the molecular weight of the polymer. The most common chain transfer agents are TDM (t-dodecyl mercaptan) or NDM (n-dodecyl mercaptan).

4.2.1.2.4 Stabilisers

Antioxidants are generally used to protect polymers against degradation (chain breakage) caused by a reaction with atmospheric oxygen. At continuous bulk polymerisation conditions, when rubber is not present, the use of stabilisers in GPPS synthesis is not necessary. When HIPS is produced, the lifetime of the incorporated rubber particles is extended by adding antioxidants.

4.2.1.2.5 Internal lubricants and mould release agents

Due to the high molecular weight of the polystyrene matrix, the flowability and processability of PS require the addition of either external or internal lubricants. The most commonly used internal lubricants, mineral oils, are added either during polymerisation or at the later phase of the finishing section of the production lines. The concentration of mineral oils is between 0 – 8 % in PS.

Mould release agents, up to 0.2 %, can also be added into the polymerisation process. Zinc stearate is the most widely used mould release agent. External lubricants can be added during or after the finishing process during PS production. The most common external lubricants are N-N' ethylene bis stearamide and polyethylene glycol 400.

4.2.1.2.6 Dyes

A few ppm of blue dye are added to GPPS to control the colour of the polymer. Dyes are generally dissolved in styrene during the feeding preparation and fed to the polymerisation train.

4.2.1.2.7 Rubber

The main difference between the GPPS and HIPS process is the addition of rubber to the feed system. Rubbers are solid like materials with colourless or with white/transparent colour. Most commonly, two different grades of polybutadiene-based rubbers are applied: low/medium and high cis rubbers. The dissolved rubber is added at the beginning of the polymerisation process. The final concentration of the rubber in finished HIPS is up to 15 %.

4.2.2 General purpose polystyrene (GPPS) process

4.2.2.1 Process description

Raw materials like styrene (potentially purified), and processing aid are fed into the reactor(s). The reactor train usually includes continuous stirred tank reactors (CSTR) and/or plug flow reactors (PFR).

Styrene itself acts as the solvent of the reaction. Moreover, up to 10 % ethyl benzene may be added to ensure better reaction control. The reactors' temperatures are controlled at between 110 and 180 °C. The reaction pressure is up to 1 MPa in the case of a PFR and at atmospheric or sub-atmospheric pressure in the case of a CSTR.

Additional chemicals are added into the feed stream or into the reactors. At the end of the reactor train, the styrene monomer conversion reaches 60 – 90 % of solid polystyrene product. The process flow then goes through a devolatilisation section where it faces one or two flashes (one or two devolatilisation vessels) to separate the polymer from the unreacted species. The devolatilisers are operated at high temperatures (220 – 260 °C) and under high vacuums (<40 mbar).

Between the two devolatilisation steps, an injection of water (stripping) can be added to improve monomer removal. After condensation, unreacted styrene and ethyl benzene are recycled to the feed line, either directly using a recycle loop or through a storage tank. A purge of undesirable components is carried out on this stream.

The melted polymer is then transferred through a dye head to obtain strands that are cut (dry or underwater) by pelletisers. After drying, the pellets are discharged in a pneumatic conveyor and then stored in silos for packaging and/or shipping in bulk.

A tabulated summary of the GPPS process is shown in Table 4.5.

A flow diagram of the GPPS process is shown in Figure 4.4.

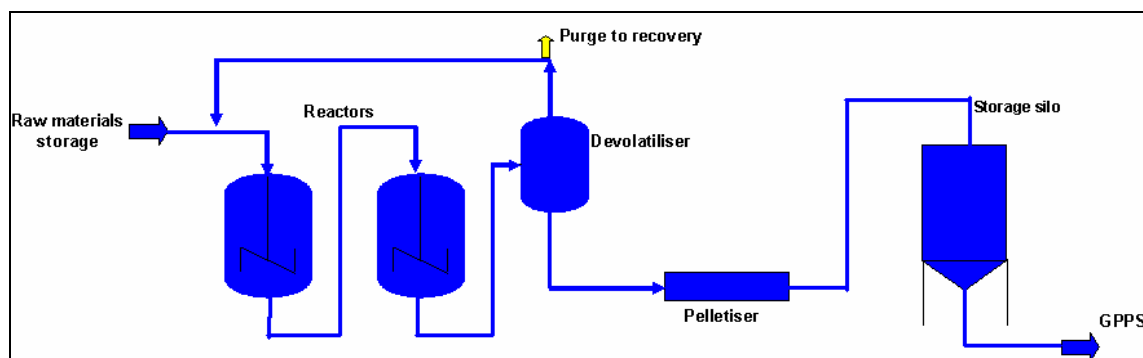

Figure 4.4: Flow diagram showing the GPPS process

4.2.2.2 Technical parameters

Product type	General purpose polystyrene
Reactor type	Continuous stirred tank reactors and/or plug flow reactors
Reactor dimensions	5 - 120 m ³
Polymerisation type	Radical polymerisation
Polymerisation pressure	Up to 1 MPa
Polymerisation temperature	110 - 180 °C
Diluents	Styrene, ethylbenzene
Catalyst	None or organic peroxides
Additives	White oil, chain-transfer agents, lubrication agents
Conversion	60 - 90 %

Table 4.4: Technical parameters of GPPS

	Preparation Step		Reaction Step	Final step			
	Storage	Purification (optional)	Reactors	Devolatilisation	Pelletiser	Storage	Packaging
Purpose	Raw materials storage	Removal of impurities	Polymerisation of styrene	Recovery of unreacted styrene and solvent	Formation of polystyrene pellets	Storage of bulk PS	Packaging of PS pellets
Inlet	Raw material	Styrene	Process feed solution	PS + unreacted species	Final PS	PS pellets	PS pellets
Outlet	Raw material	Styrene	PS + unreacted species	SM and diluent + PS	PS pellets	PS pellets	Packed PS pellets
Working	-	Continuous	Continuous	Continuous	Continuous	Batch/continuous	Batch/continuous
Capacity	From litres to tonnes	2 - 5 m ³	Up to 120 m ³	NR	NR	NR	NR
More details	NA	Exhausted absorbent removed or regenerated	CSTR and/or PFR in series. Possible addition of chemicals	Separation under vacuum. One or two vessels. Unreacted species are recycled	Pelletisers + dryers + classifiers + conveyors	NA	NA
Key parameters	Temperature	Colour of styrene	Temperature and/or pressure control	Temperature and pressure control. Water flow if stripping	Pellet size	Level control	Weight
Abbreviations							
GPPS	general purpose polystyrene	PFR	plug flow reactor	NR	not relevant		
CSTR	continuous stirred reactor	SM	styrene monomer	NA	not applicable		
		PS	polystyrene				

Table 4.5: Summary of the GPPS process

4.2.3 High impact polystyrene (HIPS) process

4.2.3.1 Process description

Generally, the process is very similar to the GPPS process. The main difference is the addition of the rubber component. Polybutadiene rubber received in the form of 35 kg bales is ground into small chips. These rubber chips are added to the dissolving tank by gravity or pneumatic conveyor. There, with strong agitation, the chips are dissolved in styrene to obtain a rubber solution that can contain up to 15 % of rubber.

The antioxidant is usually also added in the dissolving tank. In addition, other chemicals can be added there such as white oil, peroxides, recycled styrene, ethylbenzene or chain transfer agents. The dissolved mixture is then fed continuously to the reactor train where bulk polymerisation occurs. Chemicals not added in the dissolving tank are added into the feed stream or directly into the reactors.

The reactor train usually includes continuous stirred tank reactors (CSTR) and/or plug flow reactors (PFR). The styrene itself acts as the solvent of the reaction. Moreover, up to 10 % of ethylbenzene is added to ensure a better reaction control. The reactors' temperatures are between 110 and 180 °C. The pressure is up to 1 MPa in a PFR, whereas reactions in CSTR are carried out under atmospheric or sub-atmospheric pressure. At the end of the reactor train, the styrene monomer conversion reaches 60 - 90 % solid.

The process flow then goes through a devolatilisation section where it faces one or two flashes (one or two devolatilisation vessels) to separate the polymer from the unreacted monomers. The devolatilisers are operated at high temperature (220 – 260 °C) and under high vacuum (<40 mbar).

Between the two devolatilisation steps, an injection of water (stripping) can be added to improve monomer removal. After condensation, unreacted styrene and ethylbenzene are recycled to the feed line, either directly using a recycle loop or through a storage tank. A purge of undesirable components is carried out on this stream.

The melted polymer is then transferred through a dye head to obtain strands that are cut (dry or underwater) by pelletisers. After drying, the pellets are discharged in a pneumatic conveyor and afterwards stored in silos for packaging and/or shipping in bulk.

A tabulated summary of the HIPS process is shown in Table 4.7.

A flow diagram of the HIPS process is shown in Figure 4.5.

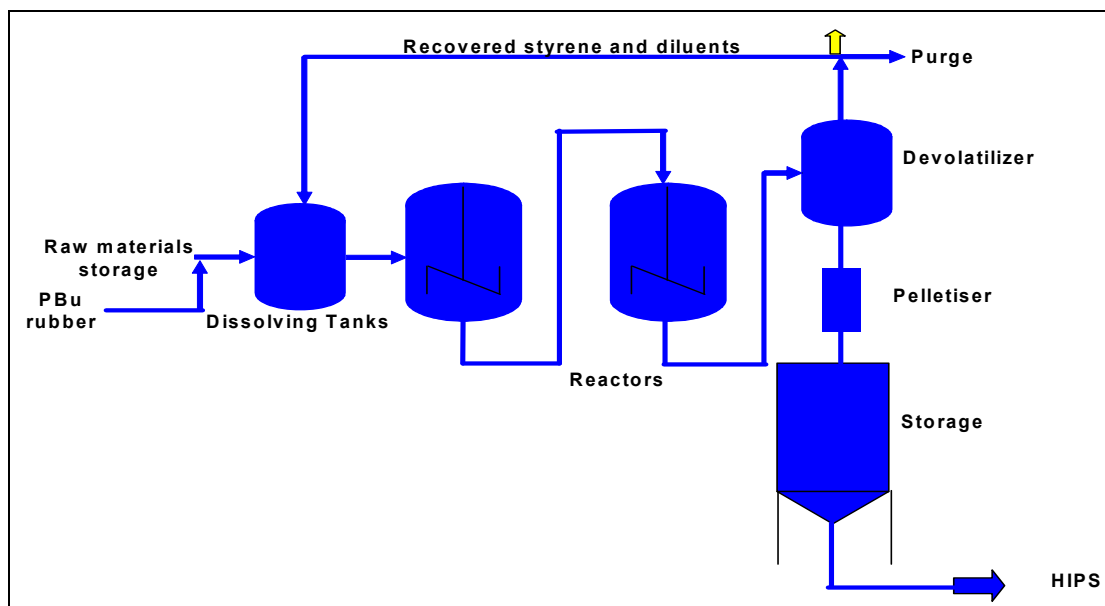

Figure 4.5: Flow diagram showing the HIPS process

4.2.3.2 Technical parameters

Product type	Medium and high impact polystyrene
Reactor type	Continuous stirred tank reactors and/or plug flow reactors
Reactor dimensions	3 - 50 m ³
Polymerisation type	Radical polymerisation
Polymerisation pressure	Up to 1 MPa
Polymerisation temperature	110 - 180 °C
Diluents	Styrene, ethylbenzene
Catalyst	None or organic peroxides
Additives	Polybutadiene, white oil, chain transfer agents, lubrication agents
Conversion	60 - 90 %

Table 4.6: Technical parameters of HIPS

	Preparation Step			Reaction Step	Final Step			
	Storage	Grinder	Dissolving system	Reactors	Devolatilisation	Pelletiser	Storage	Packaging
Purpose	Raw materials storage	PBu grinding for HIPS production	Dissolve PBu in styrene	Polymerisation of styrene	Recovery of unreacted styrene and solvent	Formation of polystyrene pellets	Storage of bulk PS	Packaging of PS pellets
Inlet	Raw material	Up to 35 kg bales	Raw materials + additives	Process feed solution	PS + unreacted species	Final PS	PS pellets	PS pellets
Outlet	Raw material	1 or 2 cm size chips	Process feed solution	PS + unreacted species	SM and diluent + PS	PS pellets	PS pellets	Packed PS pellets
Working	-	Batch/continuous	Batch/continuous	Continuous	Continuous	Continuous	Batch/continuous	Batch/continuous
Capacity	From litres to tonnes	NR	Up to 120 tonnes	Up to 50 m ³ per reactor	NR	NR	NR	NR
More details	NA	Storage of PBu + grinder + conveyor	Solution of PBu in styrene; addition of some chemicals	CSTR and/or PFR in series. Possible addition of chemicals	Separation under vacuum, one or two vessels. Unreacted species are recycled.	Pelletisers + dryers + classifiers + conveyors	NA	NA
Key Parameters	Temperature	Size of chips	Temperature, time, agitation	Temperature and/or pressure control	Temperature and pressure control. Water flow if stripping	Pellet size	Level control	Weight

Abbreviations							
PBu	polybutadiene rubber		PFR	plug flow reactor		NR	not relevant
HIPS	high impact polystyrene		SM	styrene, monomer		NA	not applicable
CSTR	continuous stirred reactor		PS	polystyrene			

Table 4.7: Summary of the HIPS process

4.2.4 Expandable polystyrene (EPS) process

4.2.4.1 Process description

Suspension polymerisation is still the mostly used process for large volume production of expandable polystyrene. It is a batch process that allows the conversion of styrene monomer into expandable polystyrene beads through radically initiated polymerisation. Typically, styrene is dispersed under agitation in the aqueous phase containing some suspension agents and/or protective colloids and some secondary ingredients such as electrolytes. Both organic and mineral suspension agent systems can be used. Organic peroxides are added to styrene prior to its dispersion into the water phase.

The polymerisation then follows a schedule that raises the temperature of the reaction mixture stepwise towards nearly total conversion of the monomer into the polymer. Pentane, a mixture of normal and isopentane, is added as a blowing agent during the course of the polymerisation.

The type and the quality of the suspension agent system and the reaction temperature profile are critical to ensure good suspension stability, bead size distribution and a high conversion rate. These parameters also influence the properties of the final product. An aliphatic brominated compound is specifically added for the production of flame-retardant grades.

At the end of the polymerisation, the suspension is cooled; the expandable polystyrene beads are separated by centrifugation, washed and then dried at a relatively low temperature of 35 °C.

Following this, the beads are then screened into several bead size fractions corresponding to the various commercial needs and applications. They are then coated to improve both processing characteristics and final performance of the product. Finally, these expandable polystyrene beads are packaged in containers or silos for shipment.

A tabulated summary of the EPS process is shown in Table 4.9.

A flow diagram of the EPS process is shown in Figure 4.6.

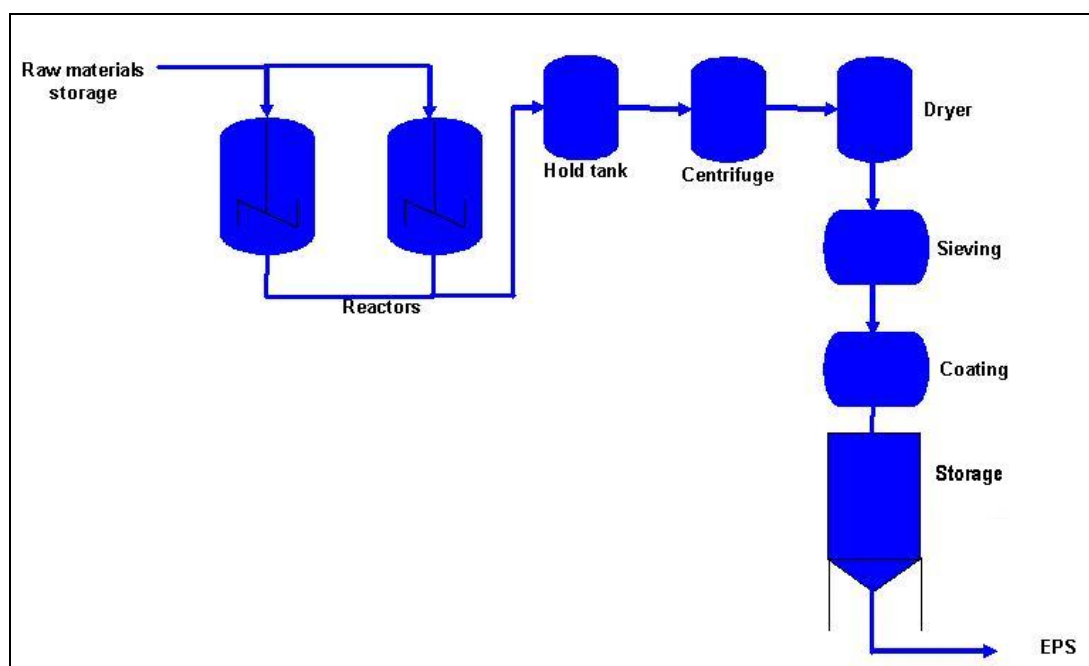

Figure 4.6: Flow diagram showing the EPS process

4.2.4.2 Technical parameters

Product type	Expandable polystyrene
Reactor type	Batch reactors
Reactor dimensions	20 - 100 m ³
Polymerisation type	Radical polymerisation in aqueous suspension
Polymerisation pressure	1 - 2 MPa
Polymerisation temperature	65 - 140 °C
Diluents	Styrene
Catalyst	Organic peroxides
Additives	Suspension agents, coating additives, brominated compounds
Conversion	>99 %

Table 4.8: Technical parameters of EPS

	Reaction Step		Final Step					
	Storage	Reactor	Centrifuge	Drying	Sieving	Coating	Storage	Packaging
Purpose	Raw materials storage	Polymerisation of styrene	Separation of slurry	Drying of beads	Size Separation of EPS beads	Coating surface of beads	Storage of bulk EPS	Packaging of EPS beads
Inlet	Raw material	Process feed solution	EPS + water + unreacted species	Moist EPS beads	Dry EPS beads	Dry and separated EPS beads	EPS beads	EPS beads
Outlet	Raw material	EPS + water	Moist EPS beads + water	Dry EPS beads	Dry and separated EPS beads	Dry, separated and coated EPS beads	EPS beads	Packed EPS beads
Working	Batch/continuous	Batch	Continuous	Continuous	Continuous	Batch/continuous	Batch/continuous	Batch/continuous
Capacity	From litres to tonnes	Up to 100 m ³ per reactor	1 to 30 m ³ /h	NR	NR	NR	NR	NR
More details	NA	CSTR, possible addition of chemicals	Separates water from slurry	Flash dryer, fluid dryer	Several layers of sieves	CSTR	NA	NA
Key Parameters	Temperature	Temperature and/or pressure	Capacity, speed	Temperature, capacity, and residence time	Mesh size	Temperature, mixing efficiency	Level control	Weight

Abbreviations								
SM	Styrene monomer							
EPS	Expandable polystyrene	NR	not relevant					
CSTR	Continuous stirred reactor	NA	not applicable					

Table 4.9: Summary of the EPS process

4.3 Current emission and consumption levels

[3, APME, 2002]

4.3.1 General purpose polystyrene (GPPS)

The values shown in Table 4.10 are not representative of one given technology. They are representative for the variety of technologies used for the manufacture of GPPS in Europe. The differences from one plant to the other are due to differences in technologies, real life scale equipment and industrial operation.

The values given refer to the emission and consumption levels for the production of one tonne of product.

	Unit	Average top 50 %	European average	Maximum value
Air Emissions				
Dust	g	2	4	7
VOC, total	g	85	120	300
Water emissions				
COD ¹	g	30	40	100
BOD ¹	g		20	40
Suspended solids ¹	g		10	20
Hydrocarbons total ¹	g	1.5	4	7
Waste water ²	t	0.8	1.1	6
Cooling tower purge water	t		0.5	0.6
Solid waste				
Hazardous	kg	0.5	0.6	1.3
Non-hazardous	kg	2	4	5
Inputs				
Total energy	GJ		1.08	1.80
Styrene	t		0.985	1.020
Ethyl benzene	t		-	0.102
Mineral oil	t		0.02	0.06
Cooling water (closed circuit)	t		50	100
Process water	t		0.596	0.600
Nitrogen	t		0.022	0.050
Diluent	t		0.001	0.001
Additives	t		0.005	0.010
1) The emission values in the water are measured after treatment. The waste water treatment facility can be inside the plant or at a centralised location. These values are not necessarily correlated as they all represent average emission values. Each plant emits according to local permits and site-specific treatment plant specifications. Water treatment may be required according to local regulations. 2) Not including cooling tower purge water.				

Table 4.10: Emission and consumption data per tonne of product from GPPS plants

Table 4.11 shows the source of emissions and waste during the production of GPPS.

	Preparation Step		Reaction Step	Final Step			
	Storage	Purification (optional)	Reactors	Devolatilisation	Pelletiser	Storage	Packaging
Gas	Nitrogen charged with VOC	Nitrogen charged with VOC	Nitrogen charged with VOC	Leaks	Fumes	PS dust	PS dust
Liquid	-	Styrene and water discharge	Traces of water	Traces of water. Recycle loop's purge (styrene + undesired species)	Water purge of pelletiser	-	-
Solid waste	Dust and packaging (of chemicals)	Exhausted absorbent (if not regenerated)	Samples		Scrap, dust from sweeping and PS	Dust from sweeping and PS	Packaging losses

Table 4.11: Sources of emissions in the GPPS process

4.3.2 High impact polystyrene (HIPS)

The values shown in Table 4.12 are not representative of one given technology. They are representative for the variety of technologies used for the manufacture of HIPS in Europe. The differences from one plant to the other are due to differences in technologies, real life scale equipment and industrial operation. The values given refer to the emission and consumption levels of the production of one tonne of product.

	Unit	Average top 50 %	European average	Maximum value
Air emissions				
Dust	g	2	4	7
VOC, total	g	85	120	1000
Water emissions				
COD ¹	g	30	40	100
BOD ¹	g		20	40
Suspended solids ¹	g		10	20
Hydrocarbons total ¹	g	1.5	4	7
Waste water ²	t	0.8	1.1	6
Cooling tower purge water	t		0.6	0.6
Solid Waste				
Hazardous	kg	0.5	0.6	1.3
Non-hazardous	kg	3	4	10
Inputs				
Total energy	GJ		1.48	1.80
Styrene	t		0.915	1.020
Ethyl benzene	t		-	0.102
Mineral oil	t		0.02	0.06
Rubber	t		0.07	0.12
Cooling water (closed circuit)	t		50	100
Process water	t		0.519	0.600
Nitrogen	t		0.010	0.050
Diluent	t		0.001	0.001
Additives	t		0.005	0.006
1) The emission values in the water are measured after treatment. The waste water treatment facility can be inside the plant or at a centralised location. These values are not necessarily correlated as they all represent average emission values. Each plant emits according to local permits and site-specific treatment plant specifications. Water treatment may be required according to local regulations. 2) Not including cooling tower purge water.				

Table 4.12: Emission and consumption data per tonne of product of HIPS plants

Table 4.13 shows the source of emissions and waste during the production of HIPS.

	Preparation Step			Reaction Step	Final Step			
	Storage	Grinder	Dissolving System	Reactors	Devolatilisation	Pelletiser	Storage	Packaging
Gas	Nitrogen charged with VOC	Nitrogen charged with VOC	Nitrogen charged with VOC	Nitrogen charged with VOC	Leaks	Fumes	PS dust	PS dust
Liquid	-	-	-	Traces of water	Traces of water. Recycle loop's purge (styrene + undesired species)	Water purge of pelletiser	-	-
Solid waste	Dust and packaging (of chemicals)	Packaging PBu and chemicals		Samples		Scrap, dust from sweeping and PS	Dust from sweeping and PS	Packaging losses

Table 4.13: Sources of emissions in the HIPS process

4.3.3 Expandable polystyrene (EPS)

The values shown in Table 4.14 are not representatives of one given technology. They are representative for the variety of technologies used for the manufacture of EPS in Europe. The differences from one plant to another are due to differences in technologies, real life scale equipment and industrial operation. The values given refer to the emission and consumption levels for the production of one tonne of product.

	Unit	Average top 50 %	European average	Maximum value
Air Emissions				
Dust	g	30	30	125
Pentane	g	1000	2500	8000
VOC ¹	g	600	700	3500
Water Emissions				
COD ²	g			4600
Total solids ²	g			8000
Hydrocarbons total ²	g			40
Dissolved solids	g		0.3	0.4
Waste water ²	t	5	6	9
Cooling tower purge water	t		1.7	2.5
Phosphate as P ₂ O ₅ ²	g			20
Solid Waste				
Hazardous	kg	3	3	12
Non-hazardous	kg	6	8	17
Inputs				
Total energy	GJ		1.8	2.5
Styrene	t		0.939	0.960
Ethyl benzene	t		-	0.096
Pentane	t		0.065	0.070
Cooling water (closed circuit)	t		17	70
Process water	t		2.1	6.0
Nitrogen	t		0.01	0.3
Additives	t		0.03	0.03
1) VOC emissions from point sources; but not including pentane				
2) The emission values in the water are measured after treatment. The waste water treatment facility can be inside the plant or at a centralised location. These values are not necessarily correlated as they all represent average emission values. Each plant emits according to local permits and site-specific treatment plant specifications. Water treatment may be required according to local regulations.				

Table 4.14: Emission and consumption data per tonne of product from EPS plants

Table 4.15 shows the source of emissions and waste during the production of EPS.

		Reaction Step	Final Step					
	Storage	Reactor	Centrifuge	Drying	Sieving	Coating	Storage	Packaging
Gas	Styrene	Pentane	Pentane	Pentane, dust	Pentane, dust	Pentane, dust	Pentane, dust	Pentane, dust
Liquid	-	-	Waste water including additives	-	-	-	-	-
Solid waste	Dust, packaging material	-	-	Dust	Dust	Dust	Dust	Dust and dust from sweeping

Table 4.15: Sources of emissions in the EPS process

5 POLYVINYL CHLORIDE

[11, EVCM, 2002, 15, Ullmann, 2001, 16, Stuttgart-University, 2000, 26, Italy, 2004]

5.1 General information

PVC, polyvinyl chloride, is one of the three highest volume polymers, slightly behind polyethylene and polypropylene. It is used in most industrial sectors (e.g. packaging, automotive, building, agriculture, medical care). The typical intrinsic properties of PVC are:

- strength/stiffness per unit cost when unplasticised
- lightness
- impermeability
- chemical and biological inertness
- ease of maintenance
- durability
- low natural flammability
- cost/performance ratio.

Generally, there are three different processes used in the manufacture of PVC:

- suspension process
- emulsion process
- mass (bulk) process.

The co-existence of the suspension and emulsion processes is mainly due to the very different morphological characteristics of the PVC particles. On the one hand, the specific characteristics of emulsion-PVC (E-PVC) are required for a number of specific applications and give an advantage in some others. On the other hand, the suspension process is better suited to the large volume production of a limited number of grades. It is, therefore, necessary to produce a significant proportion of PVC via the emulsion process in order to supply specific markets for which suspension PVC is technically unsuitable.

The mass (or bulk) process lost importance over the past years and will, therefore, not be discussed in this document.

In 1999, the total manufacturing capacity for polyvinyl chloride in Western Europe was 6.1 million tonnes. Of this, 800000 tonnes of capacity is for the emulsion process, the rest for the suspension or mass process; the suspension process is by far the most dominant.

These West European figures compare, for example, with the total production capacity for polyvinyl chloride in North America which is 7.9 million tonnes, but of this capacity, only 300000 tonnes of capacity is for emulsion-PVC. The reasons for this lower proportion are essentially historic, as the first manufacturing capacity in the world for PVC was established in Europe rather than North America, and was almost exclusively based on the emulsion process.

PVC is mainly produced as a homopolymer. In the PVC copolymers, the largest volumes are grafted copolymers for high impact applications and they are included in the scope of this document. The other PVC copolymers are low volume specialities and are, therefore, not discussed in this document.

The other main areas of PVC production are Asia (10.1 million tonnes, of which 2.6 are produced in Japan and 2.5 in mainland China), Eastern Europe (2.2 million), South America (1.3), the Middle East (0.9) and Africa (0.4). The total estimated world capacity in 1999 was 28.7 million tonnes.

Western European production data are shown in Table 5.1.

Year	2000	2001	2002
Production	5569 kt	5704 kt	5792 kt

Table 5.1: Western European PVC production

In Western Europe, the main manufacturing facilities for E-PVC are located in France, Germany, Italy, Norway, Portugal, Spain, Sweden and the United Kingdom. In addition, suspension polymer (S-PVC) is also made in Belgium, Finland, Greece and the Netherlands.

In the new EU Member States the main production facilities for S-PVC are located in the Czech Republic, Poland, Hungary and Slovakia [27, TWGComments, 2004].

Table 5.2 shows European production sites for PVC including their production capacities for 1999. All values shown are in kt/yr.

Country	Site	S-PVC	E-PVC	Mass PVC	Copolymer
Belgium	Antwerp	120			
	Jemeppe	300			
Finland	Porvoo	95			
France	St Auban	40	55		30
	Balan	180			
	Brignoud	90	30		
	St-Fons			200	
	Mazingarbe	220			
	Berre	220			
Germany	Tavaux	230	60		
	Ludwigshafen	170	15		
	Schkopau	90	45		
	Wilhelmshaven	330			
	Rheinberg	140	40		
	Marl	140	110	50	
	Burghausen	96	59		25
	Gendorf	10	88		25
	Hurth	114			
	Merkenich	110	43		
Italy	Porto Marghera	180			
	Porto Torres		55		
	Ravenna	205			
Netherlands	Beek	215			
	Pernis	300			
Norway	Porsgrunn	85	20		
Portugal	Estarreja	135	10		
Spain	Vilaseca + Monzon	199*	199*		
	Hernani	35*	35*		
	Martorell	240*	240*		
Sweden	Stenungsund	120	50		
UK	Barry	125			
	Hillhouse		40		
	Runcorn	105			
	Aycliffe	175			
Czech. Rep.	Neratovice	130			

Country	Site	S-PVC	E-PVC	Mass PVC	Copolymer
Hungary	Kazinbarcika	330			
Poland	Wloclavek	300			
	Oswiecim		37		
Slovakia	Novaky	30	55		
Total		5604	1286	250	80
Note: Production of PVC in Antwerp was stopped in 2001 * total production, E-PVC + S-PVC					

Table 5.2: European production sites and capacities in kilotonnes for the year 1999

The overwhelming majority of suspension polymers are used in melt processing applications, where the polymer is melted and then formed, for example by extrusion or injection moulding, to produce items such as pipes, rainwater goods, window frames and cable coverings. General purpose emulsion polymers are used in these same melt processes, in particular in rigid profiles where high surface gloss and smoothness are required, for example for window roller blinds and staircase hand rails. In contrast, paste polymers are dispersed before use in a plasticiser such as di-ethylhexylphthalate to produce a spreadable, sprayable mix known as a plastisol. This plastisol is spread or sprayed cold, before being heat cured. Typical applications are cushion flooring, wall coverings and car under-body sealants. A very small volume of speciality emulsion polymers are used for sintering into battery separators for lead cell batteries.

5.2 Applied processes and techniques in the production of polyvinyl chloride

5.2.1 Raw materials

5.2.1.1 Vinyl chloride monomer (VCM)

PVC is produced by the polymerisation of vinyl chloride monomer (VCM), which in turn is produced by the thermal cracking of ethylene dichloride (EDC). The chlorine used in the manufacture of EDC is derived from common salt (NaCl) by electrolysis, so 43 % by weight of PVC originates from crude oil.

Various trace impurities do occur in the vinyl chloride, a number of these such as 1,3-butadiene and monovinyl acetylene can have adverse effects upon the polymerisation kinetics even at very low levels (mg per kg) and thus must be stringently controlled. Any unreactive liquid having a significantly higher boiling point than vinyl chloride, such as EDC, and remaining in the VCM will be found in the aqueous effluent, as measures designed to remove VCM will fail to remove them.

5.2.1.2 Utilities in contact with the process fluids

- nitrogen: used for flushing and inerting
- steam: for water and latex/suspension stripping, for reaction preheating and for purging equipment
- air used for drying
- water.

5.2.1.3 Process chemicals

- process water used to disperse the VCM during polymerisation, to dilute the suspension or latex and to flush equipment where necessary
- surfactants, emulsifiers and protective colloids used to prepare and stabilise the dispersion of the monomer and PVC in process water, typically around 1 kg/t in suspension and around 10 kg/t in emulsion [27, TWGComments, 2004].
- polymerisation initiators such as organic peroxides or peresters, typically below 1 kg/tonne VCM
- chemicals to stop the reaction such as hindered phenols, typically below 1 kg/tonne VCM
- antifouling agents used to minimise polymer formation on reactor walls
- chemicals used to modify the characteristics of the final product, for example copolymers to improve impact performance.

5.2.2 VCM supply, storage and unloading

To supply standalone PVC plants, VCM gas can be transported by dedicated pipes when the distance is short. Ships, rail or road trucks are used over longer distances. Most PVC plants have storage and unloading facilities for VCM. VCM storage can either be under pressure or refrigerated at approximately atmospheric pressure. For unloading facilities, back balance arrangements will generally be provided between storage and transport, allowing the emissions to be reduced.

5.2.3 Polymerisation

5.2.3.1 Common features

For both emulsion and suspension processes, the VCM gas is polymerised in an aqueous medium.

At the beginning of any polymerisation, the reactor is charged with water and some other additives. If the gaseous phase contains atmospheric air, this has to be vented to the air. The need of venting can be reduced using certain technologies such as closed lid [27, TWGComments, 2004]. A vacuum pump is often used to ensure residual oxygen levels are low. The gas head space may also be purged with an inert gas (nitrogen). Thereafter the monomer is added to the reactor.

Polymerisation reactions are exothermic, thus the reactors must be equipped with cooling facilities. The pressure in the reactor is usually in the range of 0.4 – 1.2 MPa and the reaction temperature is in the range of 35 – 70 °C. At the end of the reaction, 85 – 95 % of the VCM is converted into PVC.

The unconverted VCM is vented-off to a gas-holder or straight to a VCM recovery unit, before stripping operations. The objective is to reduce the pressure close to atmospheric. Because of the surfactants or emulsifiers present in PVC water mixture, the reactor contents are liable to foam during this venting process, especially in the emulsion process. This removal of unconverted monomer can be performed either in the polymerisation vessel itself, or in a blow-down tank. Some types of vessel will be equipped to catch any carry over, should it occur.

5.2.3.2 Suspension PVC process

In the suspension PVC (S-PVC) process, a suspension of PVC particles having a mean particle size of between 50 and 200 µm is produced. Besides particle size, the essential differences between S-PVC grades result from the average length of polymer chains and from the porosity of the particles. Suspension PVC is always produced batch wise in a stirred vessel.

The monomer is dispersed in demineralised water by the combination of mechanical stirring and surfactants. Partially hydrolysed polyvinyl acetates are the most widely used type of suspension agent. The polymerisation takes place inside the VCM droplets under the influence of VCM soluble initiators such as peresters, percarbonates or peroxides. A phase of solid PVC primary particles builds up. The PVC particles present at the end of the polymerisation process, result from the complex aggregation of such primary particles, giving S-PVC its characteristic ‘cauliflower’ aspect under an optical microscope.

During polymerisation some polymer also tends to form on the reactor wall. Technological improvements now limit this formation, so that it is no longer necessary to open the reactor after every batch for visual inspection and mechanical cleaning if necessary. In this so-called ‘closed reactor’ technology, the frequency of reactor opening can be reduced down to levels below once in 100 batches, depending on the grade.

In the older ‘open reactor’ technology reactors are opened after every batch for inspection, cleaning if necessary, and also for loading additives.

A flow diagram of a suspension PVC process is shown in Figure 5.1.

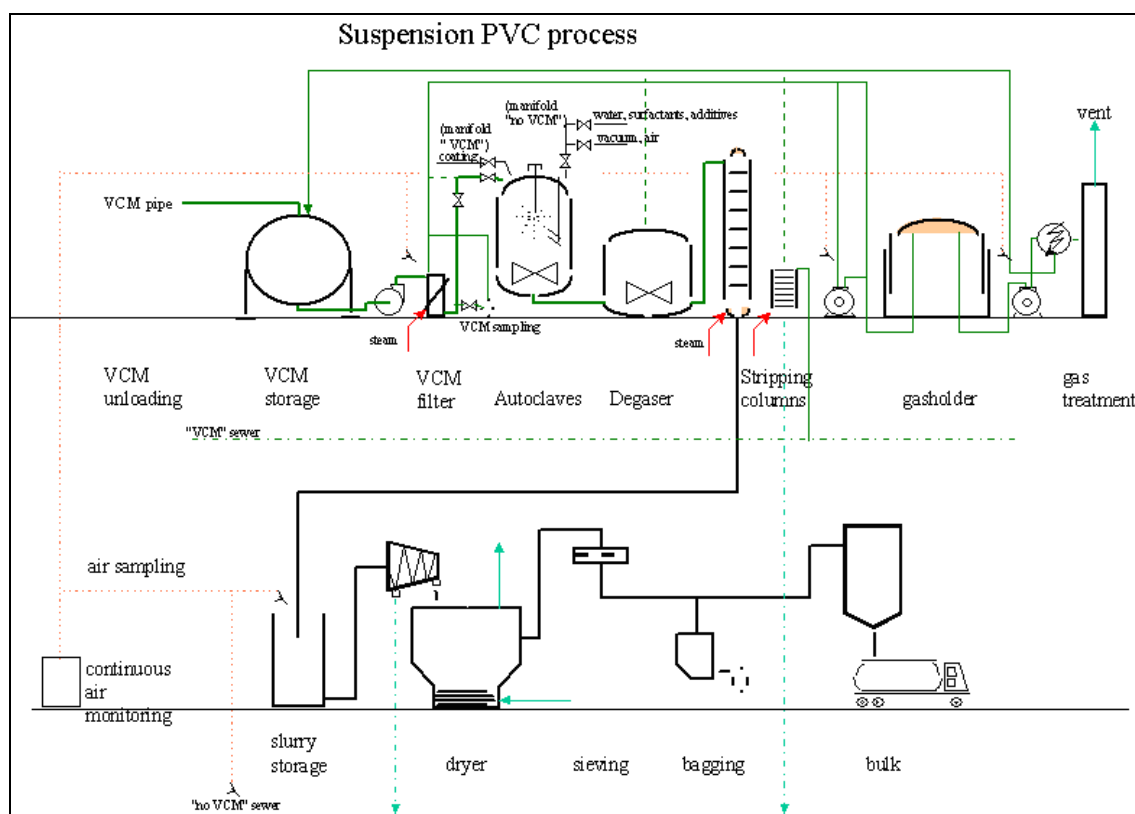

Figure 5.1: Flow diagram of an S-PVC process

5.2.3.3 Emulsion PVC process

In emulsion processes, aqueous latex with the PVC having a mean particle size (by weight) of between 0.1 and 3 micrometres is produced. For paste or plastisol polymer applications, the exact latex particle size distribution achieved during the polymerisation process will largely determine the rheology of the plastisol, when the polymer is redispersed in plasticiser. Very narrow distributions will give rise to pseudoplastic plastisols (viscosity reduces with shear rate), other distributions can give rheology profiles which range from dilatant (viscosity rises with shear) to Newtonian (viscosity is unaffected by shear).

E-PVC is manufactured essentially by three polymerisation processes: batch emulsion, continuous emulsion and microsuspension. All these processes are used to produce a range of latex particle size distributions and thus plastisol rheologies. Different paste applications demand different rheology profiles. The microsuspension process intentionally produces latexes with a significant content of coarser particles.

In the batch emulsion process, the VCM is dispersed using an emulsifier, usually a sodium alkyl or aryl sulphonate or alkyl sulphate. The polymerisation takes place at the VCM water interface using a water soluble initiator, such as an alkali metal persulphate. A redox system involving copper and a reducing agent is often used. This type of process produces narrow width unimodal latex of a small size (approximately 0.2 μm). Such latex, if dried close to its glass transition temperature to produce a hard free flowing powder, is excellent for general purpose use and battery separator polymers. However, when dried at lower temperatures to produce paste polymers, the resulting plastisols are high in viscosity and sharply pseudoplastic in nature, suitable notably for the spray coating of car underbodies and for fabric coating, but unsuitable for the majority of plastisol applications. These require low viscosity plastisols with Newtonian, or only mildly pseudoplastic, rheology. In batch emulsion polymerisation, these latter types of polymers are produced by charging seed latex produced in a previous batch to the reactor at the start of the process. During a second polymerisation process, this seed latex is allowed to grow, and new particles are also allowed to form, resulting in a bimodal particle size distribution. The rheology can be controlled by adjusting the relative quantity and sizes of the two families.

In a variation of emulsion polymerisation, the process can be operated continuously, in which fresh VCM, emulsifiers and an initiator are fed into the reactor and PVC latex is withdrawn continuously. Such processes tend to require greater quantities of emulsifiers than the batch process. They produce latexes with a wide particle size distribution and thus low plastisol viscosities suitable for a wide range of applications, but the higher levels of emulsifier will preclude them from applications where water absorption or clarity of the final coating is important.

An alternative approach for producing latex with a wide particle size distribution is microsuspension polymerisation. In this process, an initiator such as lauroyl peroxide is used, which is highly soluble in the VCM, but is essentially insoluble in water. Thus, polymerisation takes place within the dispersed VCM droplets. The water insolubility of the initiator also helps to stabilise the VCM droplet, and it may be possible to use lower levels of emulsifier compared with the batch emulsion and continuous emulsion processes. Lower levels of emulsifier can be advantageous, for example for applications coming into contact with food, where water absorption or clarity is important, and also for the environmental impact of the process. Such latexes produce polymers which give very low plastisol viscosities, but tend to be dilatant in nature. This can be overcome by modifying the process to have a secondary particle size distribution alongside the primary one.

The microsuspension process is not suitable for the production of polymers giving sharply pseudoplastic plastisols.

A flow diagram of an emulsion PVC process is shown in Figure 5.2.

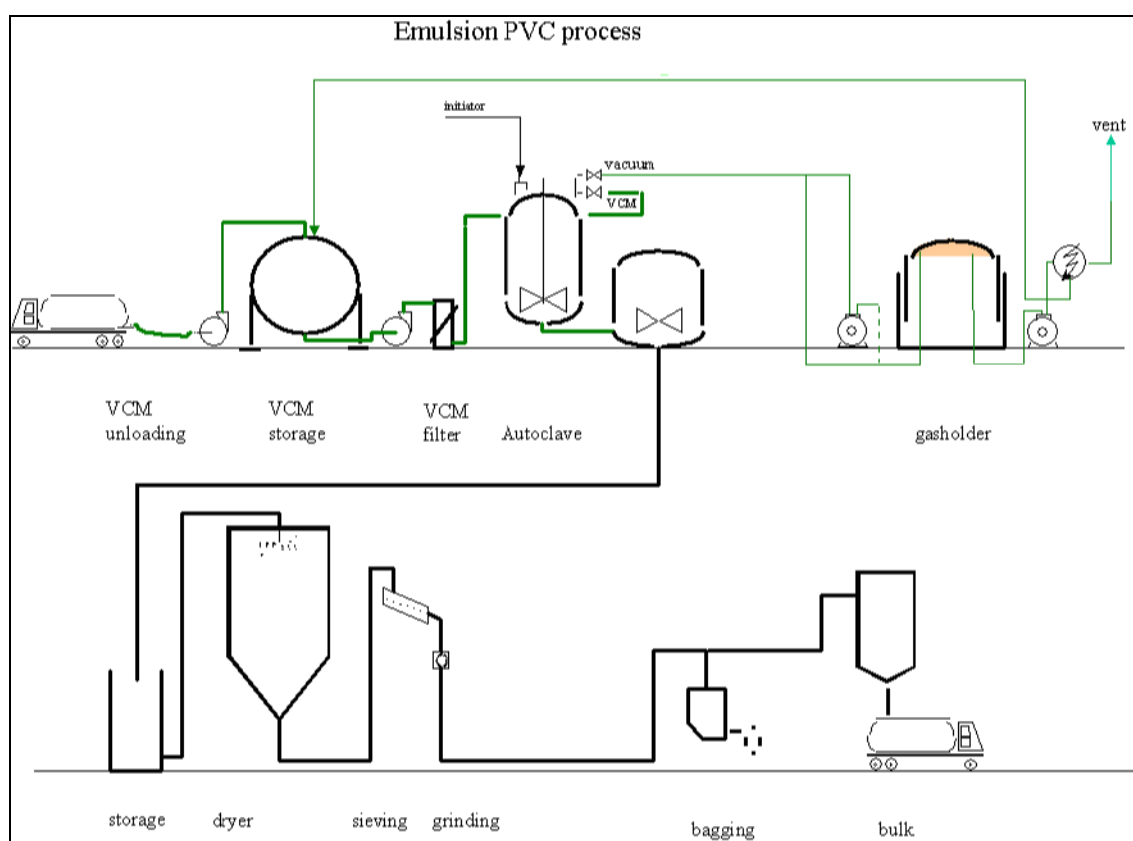

Figure 5.2: Flow diagram of an E-PVC process

Table 5.3 shows typical features of the different emulsion PVC processes.

Process	Advantages	Disadvantages
Batch emulsion	Ability to produce polymers giving high pseudoplasticity. Ability to give a range of other rheologies. Simplicity and flexibility.	Residual emulsifier levels too high to give coatings with very low water absorption and clarity.
Continuous emulsion	Ability to produce polymers giving low plastisol viscosities. Product consistency. High productivity.	Coatings with poor water absorption and clarity (high residual emulsifier). Cannot produce pseudoplastic polymers. Inflexibility. Emulsifier costs.
Microsuspension	Ability to produce polymers giving very low plastisol viscosities. Polymers can give coatings with very low water absorption and clarity and excellent organoleptic properties (low emulsifier levels). Product consistency. A lower consumption of emulsifier can also be an advantage regarding the environmental impact of the process.	Inability to produce pseudoplastic polymers. Greater complexity.

Table 5.3: Typical features of E-PVC processes

5.2.4 Stripping

Residual VCM is removed by stripping the polymer suspension or latex. This section includes unstripped suspension/latex storage tank(s). Usually the stripping uses the effects of steam, nitrogen, vacuum (alone or in combination), and temperature. The process can be performed in different ways:

- batch wise – either inside the reactor itself or in a separate vessel
- continuously – outside the reactor.

The stripping of latex must be operated in such a way that the latex remains stable, and neither coagulates nor flocculates. The latex is sensitive to temperature, to agitation and to time.

The VCM content of PVC suspension after stripping is normally very low. In the case of latex, stripping is more difficult and the residual VCM content depends on a variety of parameters, for instance: emulsifier content and type, latex particle size, latex stability, the recipe and the requirements of resin end properties. When steam is used for stripping, the overhead steam containing recovered VCM is condensed. The condensate can be returned to the stripping system, or can be transferred to the water stripper of the effluent treatment or other sections of the process, in order to recover contained VCM and thus to prevent VCM emissions from this effluent. In all cases, the non-condensed overhead gas containing stripped VCM is collected in a recovery unit.

The stripped suspension or latex is usually stored in buffer vessels that provide a continuous feed to the drying section. At this stage, it is possible to carry out latex management operations such as sieving of the latex, and storage of seeds. This section includes sieves, to remove coarse particles, filters pumps, etc. Many latexes will sediment if the tanks are not continually agitated or circulated through a pump. Although PVC latexes, once stripped, are much more stable than before stripping, care must be taken to ensure that flocculation does not occur.

Before drying, suspension or latexes can be concentrated. For suspension, this is usually carried out by dewatering in a centrifuge. For latex, it will depend on its stability and concentration on leaving the reactors. Concentration can be achieved by using a membrane or an evaporator. When using membranes, it can be necessary to add extra emulsifier to maintain both latex stability and resin properties, thus increasing the potential COD of the plant effluent. If the VCM concentration of the effluent from the centrifuge or membrane is below 1 mg/l, it does not need to be fed into the VCM waste water stripper.

5.2.5 Drying

Drying is achieved by a combination of temperature and airflow in dryers of various designs. The first drying for suspension PVC is often dewatering by centrifugation, yielding a wet cake. Final drying for suspension PVC is achieved by various methods such as using a fluidised bed dryer, cyclon dryer and flash dryer [27, TWGComments, 2004]. Regarding emulsion PVC, the small particle sizes of the latex, and the impossibility for most particles to be separated from the water phase, makes it necessary to evaporate the water, except in a few special processes where the latexes are coagulated and centrifuged. Thus latex is usually dried in a spray dryer. During the spray drying, water is evaporated and removed.

The spray drying causes the agglomeration of the latex particles into secondary particles with a mean particle size of approximately 30 micrometres. These may be subsequently broken down by the use of a mechanical grinding process, to recover some or all of the original latex particle size distribution.

Drying conditions have a profound impact on particle morphology and can be used to produce either paste or general emulsion polymers from the same reactor product. In the spray dryer, the latex particles of approximately 0.5 μm in size stick together into secondary particles with a mean diameter of approximately 30 μm .

5.2.6 Sieving and grinding

After drying, suspension PVC is usually sieved to remove coarse particles which could cause problems during transformation. Emulsion PVC is classified and ground if required for the end application. Polymers for 'paste applications' are normally ground; those for 'general emulsion' applications are not. The fracturing of the secondary particles formed in the dryer enables them to break down more easily in the plastisol and return to their original latex particle size distribution.

The grinding/powder mills may be of a hammer type, or consist of a classifier and rotating rotor fitted with pins or bars. The classifier may be separate or an integral part of the mill itself.

The end-product from suspension or emulsion PVC is bagged or transferred to storage silos for packaging or bulk transportation.

5.2.7 VCM recovery

The flows containing VCM vented from the autoclaves after the reaction, released during suspension or latex stripping, vented from unstripped suspension or latex stock tanks and released from the waste water stripper are transferred to the condensing section of a VCM recovery system. Any water reaching the recovery plant must be removed first. It is also important that the flows are kept free of oxygen to limit the formation of polyperoxides. The pH and the temperature of the recovered VCM are also controlled in order to prevent polyperoxide formation. The condensers in the recovery system can be cooled by a multistage combination of normal plant cooling water and refrigeration. The efficiency of VCM recovery is determined by the correct combination of low temperature and increased pressure. In batch polymerisation processes, the gas flow to the VCM recovery plant will fluctuate and a gas-holder to buffer these flows is often used.

To limit emissions, vents leaving the recovery plant pass through a VCM chemical absorption or adsorption unit, a molecular sieve, an incinerator or a catalytic treatment unit. In the case when an incinerator is used, it must be designed and operated so as to ensure that any dioxins formed in the incineration process are destroyed and do not reform.

After recovery, the VCM is held in a holding tank under pressure or refrigeration. A chemical inhibitor, such as a hindered phenol, is sometimes added to prevent polyperoxide formation. Normally any polyperoxide formed is kept dissolved in the VCM, where it will react slowly and safely to form PVC. However, if liquid VCM containing polyperoxides is evaporated, polyperoxides may precipitate. Such precipitated polyperoxides can decompose exothermically with the risk of explosion.

The recovered VCM is either returned to the plant from which it arose, or to a neighbouring plant, to be used in the polymerisation process together with virgin VCM. Where facilities for E-PVC and S-PVC polymerisation processes are located side by side, it is common for the recovered monomer to be used exclusively at the S-PVC plant, as this process is less sensitive to the quality of the VCM.

5.2.8 Water treatment

Where manufacturing plants for the polymerisation of E-PVC and S-PVC are located side by side, it is common for them to share the same water treatment facilities.

Any water which may be contaminated with VCM, for example water used for the cleaning of reactors containing VCM, transfer lines and suspension or latex stock tanks, must be passed through a water stripper to remove VCM. This may be either continuous, consisting of a packed column or a column equipped with trays, or be a batch process. The VCM removal is optimised by the correct combination of residence time and temperature. The removed VCM is sent to the recovery plant and the aqueous effluent to a water treatment facility.

The effluent containing solid PVC is sent to a water treatment plant for excessive solids removal. Such plants often use two step processes. In the first, the PVC in the water is flocculated by the use of proprietary coagulating agents. The clear water either goes to drain or for re-use at the plant, the coagulated solids are removed either by thickening and sedimentation in the second chamber, or by dissolved air flotation. The clear water leaving the second chamber is frequently returned to the first chamber for additional treatment. Such processes also have the effect of reducing the overall organic content (COD) of the effluent. Sedimentation of fine particles can be more difficult.

Some sites also use membrane filtration to recover the product and to recycle water. PVC separated from waste water is mostly sold, maybe as a lower quality product [27, TWGComments, 2004].

5.3 Current emission and consumption levels

[11, EVCM, 2002]

Fugitive emissions which are included in the total VCM to air emissions in this section are calculated according to the reference methods from ECVM:

- identification, measurement and control of fugitive emissions from process equipment leaks [9, ECVM, 2004]
- assesment of atmospheric emissions from gasholders (revision 2) [10, ECVM, 2001].

5.3.1 Industry standards

[9, EVCM, 2000, 10, EVCM, 2001]

The European Council of Vinyl Manufacturers (ECVM) has issued two industry charters:

- Industry Charter for the Production of VCM and PVC (suspension process), issued in 1994
- Industry Charter for the Production of Emulsion PVC, issued in 1998.

The Oslo and Paris Commission (OSPAR) has issued a 'Recommendation for emission and discharge limit values for E-PVC (2000/3)' and a 'Decision for emission and discharge limit values for S-PVC (98/5)'. This commission has also issued a 'Recommendation on BAT for the manufacture of E-PVC (99/1)'.

According to the charters mentioned, the following standards were published:

Criteria (maximum value)	Suspension PVC	Emulsion PVC only	Emulsion PVC sharing treatment with S-PVC
Total VCM emission to air	80 g/tonne PVC (OSPAR) 100 g/tonne PVC ; incl. fugitives (ECVM)	1000 g/tonne PVC; incl. fugitives (ECVM) 900 g/tonne PVC for existing plants (OSPAR) 500 g/tonne PVC for new plants (OSPAR)	
VCM emission in aqueous effluents	1 g/m ³ and 5 g/tonne PVC (OSPAR) 1 g/m ³ (ECVM)	1 g/m ³ and 10 g/tonne PVC (OSPAR)	1 g/m ³ or 5 g/tonne E+S-PVC (OSPAR)
VCM concentration in final regular product	5 g/tonne PVC for general purpose and 1 g/tonne PVC for food and medical purposes (ECVM)	1 g/tonne PVC (EVCM)	
Chemical oxygen demand	For single plants: 125 mg COD per litre For combined plants: 250 mg COD per litre (OSPAR)	250 mg COD per litre of water (OSPAR)	
Suspended solids	30 mg suspended solids per litre (OSPAR)	30 mg suspended solids per litre of water (OSPAR)	
Note: OSPAR VCM emissions to water refer to the outlet of the stripper before secondary treatment			

Table 5.4: VCM emissions according to OSPAR and ECVM

5.3.2 Emissions

5.3.2.1 Suspension PVC

Emissions in g/tonne	Top 25 % of plants	Median value	Production weighted average
Total VCM emissions including diffuse	18	43	45
PVC dust		40	82
VCM to water**		3.5	2.3
COD***		480	770
Hazardous waste*		55	120
* Hazardous waste means solid waste containing more than 0.1 % VCM. The data apply to hazardous waste leaving the plant ** After stripping before WWTP *** After final WWTP			

Table 5.5: Emission data from S-PVC in g/tonne as submitted by ECVI

Germany reported that for German plants waste water from the S-PVC process is 1 - 4 m³/t, cooling water is in the range of 100 – 200 m³/t and COD after pretreatment is 150 - 750 g/t PVC. However, these figures may be higher when the pretreatment is less effective.

Germany also reports the following emission data to air (see Table 5.6):

	Total VCM (g/t)	Dust (g/t)
Reference plant 1	6	0.01
Reference plant 2	4	15

Table 5.6: Dust and VCM emissions from German S-PVC reference plants

5.3.2.2 Emulsion PVC

Emissions in g/tonne	Top 25 % of plants	Median value	Production weighted average
Total VCM emissions including diffuse	245	813	1178
PVC dust		200	250
VCM to water**		10	80
COD***		340	1000
Hazardous waste*		74	1200
* Hazardous waste means solid waste containing more than 0.1 % VCM. The data apply to hazardous waste leaving the plant ** After stripping before WWTP *** After final WWTP			

Table 5.7: Emission data from E-PVC in g/tonne as submitted by ECVI

The difference in VCM emissions to air between suspension and emulsion PVC plants results from the stripping of suspension versus emulsion, due to the different physical properties of the mixture to be stripped.

Germany reports the following emission data to air (see Table 5.8):

	Total VCM (g/t)	Dust (g/t)
Reference plant 3	300	11
Reference plant 4 (microsuspension PVC)	170	2

Table 5.8: Dust and VCM emissions from German E-PVC reference plants

5.3.3 Energy consumption

Energy is mainly used in the form of steam (for heating dryers and reactors, for stripping, etc.) and electrical power (to drive refrigeration units, pumps, stirrers, compressors). In some processes, natural gas is used to heat up dryers, but the typical consumption data shown below (1999 data) assume that no natural gas is used. Typical energy consumption of both S-PVC and E-PVC processes is shown in Table 5.9.

	S-PVC	E-PVC
Thermal energy (GJ/t of PVC)	2 - 3	6 - 9
Electrical energy (GJ/t of PVC)	0.7 - 1.1	1.4 - 2.2

Table 5.9: Typical energy consumption of PVC processes

5.3.4 Emission data from an example S-PVC plant

For 2003, the following consumption data were reported (see Table 5.10):

Water (m ³ /t PVC)	Steam (t/t PVC)	Electricity (kWh/t PVC)
3.1	0.879	139
Note: Electricity does not include off-site and utilities		

Table 5.10: Consumption data from the S-PVC plant

VOC emissions were significantly reduced by optimising the stripping system and applying an oil layer on the gas-holder (VCM tank). For 2003, a total of 51 grams of VOC emission per tonne of PVC was reported, of which 37 g/t occurred in the stripping process, 8 g/t in the gas-holder and 6 g/t were fugitive emissions, as is shown in Table 5.11.

Total (g/t)	Stripping (g/t PVC)	Gas-holder (g/t PVC)	Fugitives (g/t PVC)
51	37	8	6

Table 5.11: VCM emissions from different sources

Due to the replacement of old filters by new ones at the storage silos and for the dryers, the average dust emissions were reduced to:

$$\text{dust} < 1 \text{ mg/Nm}^3.$$

The plant does not have a biological waste water treatment plant, it uses a lagoon. For 2003, the following emissions were reported (see Table 5.12). The emission levels fit within the (OSPAR) standards for S-PVC production.

COD (mg/l)	Suspended solids (mg/l)	VCM (mg/l)	VCM (g/t PVC)
222	23	0.66	0.15

Table 5.12: Emissions to water from the S-PVC plant

6 UNSATURATED POLYESTER

[5, CEFIC, 2003]

6.1 General information

Unsaturated polyester resins are classified as thermosets. The producer supplies a reactive, liquid intermediate to the customer. This is different from the market for thermoplastics where a ready made polymer is delivered. The liquid intermediate is transferred into the final product at the customer site by curing it with hardeners or catalysts.

Unsaturated polyester (UP) is the generic name for a variety of thermoset products, mainly prepared by polycondensation of an anhydride or a diacid (the monomer) with a diol (the reactant). Figure 6.1 shows, in principle, the reaction of a glycol with a dicarboxylic acid. These condensation products are dissolved in a reactive monomer which is usually styrene. When this mixture is cured by the customer, a three-dimensional network is formed. Curing of the resin is to be covered by the scope of the IPPC Directive whenever it fits into the criteria for inclusion as an associated activity.

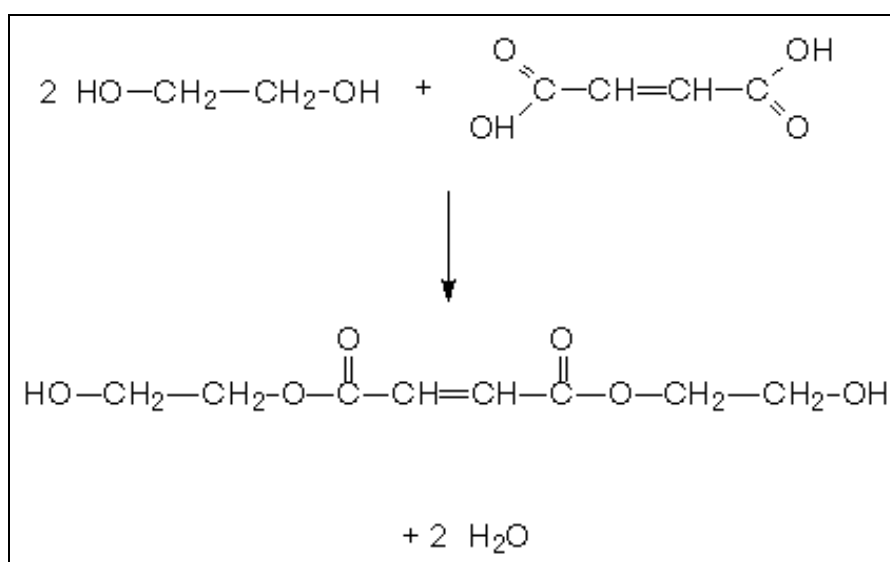

Figure 6.1: Basic condensation reaction scheme for producing unsaturated polyester resins

The properties of the cured UP resins can be varied within wide limits to meet specific requirements, by the choice of specific dicarboxylic (both unsaturated and saturated) acids and diols and by dissolving them in different reactive monomers. Using the appropriate combination of starting materials, it is possible to influence many properties of the resin, such as:

- heat resistance
- hydrolysis resistance
- impact strength
- flexibility
- electrical properties
- self-extinguishing properties.

Within the unsaturated polyester consumer market, a variety of formulations are used. The background to this is the large variety in end-use markets and the use of many different conversion technologies at the converter. Overall, hundreds of different formulations are brought to the market. Apart from differing in formulation (raw material composition), processes may differ to target desired specifications and product performance.

The Western European production of unsaturated polyester resins in 2002 was 471 kilotonnes. A summary of the production data for the years 2000 - 2002 is given in Table 6.1.

2000	2001	2002
484 kilotonnes	484 kilotonnes	471 kilotonnes

Table 6.1: Western European UP production 2000 - 2002

Overall, 43 installations were reported to produce UP all over Europe. Countries with the most unsaturated polyester plants are UK (8), Spain (6), Italy (5) and France (5). A summary of the plants is given in Table 6.2.

Producer	Number of production sites in Europe	Location(s)
Company A	1	Valdarno, Italy
Company B	3	Benicarlo, Spain Porvoo, Finland Sauveterre, France
Company C	1	Tarragona, Spain
Company D	1	Barcelona, Spain
Company E	1	Vathi, Greece
Company F	4	Drocourt, France Stallingborough, UK Sant Celoni, Spain Miranda de Ebro, Spain
Company G	1	Belvedere, UK
Company H	4	Schoonebeek, the Netherlands Ellesmere Port, UK Compiègne, France Filago, Italy
Company I	1	Harlow, UK
Company J	1	Zagreb, Croatia
Company K	1	Attikis, Greece
Company L	1	Rubezhnoye, Ukraine
Company M	1	Grodno, Belarus
Company N	1	Arezzo, Italy
Company O	1	Copenhagen, Denmark
Company P	1	Barreiro, Portugal
Company Q	6	Fredrikstad, Norway Micham, UK Etain, France Parma, Italy Vienna, Austria
Company R	1	Burgos, Spain
Company S	1	Lisbon, Portugal
Company T	1	Dunstan, UK
Company U	1	Como, Italy
Company V	1	Wellingborough, UK
Company W	1	Macherio, Italy
Company X	1	Neratovice, Czech Republic
Company Y	1	Brabant, the Netherlands
Company Z	1	Drogenbos, Belgium

Table 6.2: UP producing sites in Europe

6.2 Applied processes and techniques in the production of unsaturated polyesters

6.2.1 Raw materials

As there are a huge number of different products summarised under the name of unsaturated polyesters which are produced with a variety of different raw materials, an overview of the most important raw materials in UP production is given in Table 6.3.

Name	Functionality	CAS
1,1,1-Trimethylolpropane	glycol/alcohol	77-99-6
2-Ethylhexanol	glycol/alcohol	104-76-7
Diethylene glycol	glycol/alcohol	111-46-6
Dipropylene glycol	glycol/alcohol	110-98-5
Monoethylene glycol	glycol/alcohol	107-21-1
Isobutyl alcohol	glycol/alcohol	78-83-1
Propylene glycol	glycol/alcohol	57-55-6
Neopentyl glycol	glycol/alcohol	126-30-7
Adipic acid	anhydride/diacid	124-01-9
Fumaric acid	anhydride/diacid	110-17-8
Chlorendic acid	anhydride/diacid	115-28-6
Isophthalic acid	anhydride/diacid	121-91-5
Maleic anhydride melted/solid	anhydride/diacid	108-31-6
Phthalic anhydride	anhydride/diacid	85-44-9
Tetrahydrophthalic anhydride	anhydride/diacid	85-43-8
Tetrabromo phthalic anhydride	anhydride/diacid	632-79-1
2,4'/4,4' MDI	reactant	26447-40-5
Toluene diisocyanate	reactant	26471-62-5
Bisphenol epoxy novolac	reactant	1321-74-0/7525-62-4
Methacrylic acid	reactant	97-41-4
Dicyclopentadiene	reactant	77-73-6
Divinyl Benzene	reactive monomer	1321-74-0
α -methyl styrene	reactive monomer	98-83-9
Styrene	reactive monomer	100-42-05
Diallyl phthalate	reactive monomer	131-17-9
Methyl methacrylate	reactive monomer	80-62-6
Di butyl tin-oxide	catalyst	818-08-6
N,N dimethyl p-toluidine	additive/promotor	99-97-8
N,N-diethylaniline	additive/promotor	91-66-7
N,N-Bis-(2 hydroxypropyl)-p-toluidine	additive/promotor	38668-48-3
N,N-dimethylaniline	additive/promotor	121-69-70
Unsaturated polyester	raw material/intermediate	100-42-5
Epoxy resin	raw material/intermediate	25068-38-6
Orthoxylene	solvent	95-47-6
Acetone	solvent	67-64-1
Isododecane (2,2,4,6,6-pentamethylheptane)	solvent	13475-82-6
Methanol	solvent	67-56-1
p-Benzoquinone	inhibitor	106-51-4
2,6-di-terbutyl paracresol	inhibitor	128-37-0
Hydroquinone	inhibitor	123-31-9
Mono-terbutyl hydroquinone	inhibitor	1948-33-0/88-58-4
4-terbutyl pyrocatechol	inhibitor	98-29-3
Tri-methyl hydroquinone	inhibitor	700-13-00
Potassium nitrate	additive	7757-79-1
Aerosil/fumed silica	additive	7631-86-9

Table 6.3: Raw material overview of UP production processes

6.2.1.1 Monomers

The most commonly used unsaturated dicarboxylic acids are maleic anhydride and fumaric acid. The most commonly used saturated carboxylic acids are phthalic anhydride, orthophthalic acid, isophthalic acid and terephthalic acid. Commonly used types of diols are ethylene glycol, diethylene glycol, propylene glycol, butanediol, hexanediol, dipropylene glycol and neopentyl glycol.

Dicyclopentadiene is another important monomer used for unsaturated polyesters.

A special group of unsaturated resins are the vinyl esters, which are based on bisphenol A and methacrylic acid.

6.2.1.2 Reactive monomers

Most unsaturated polyesters are dissolved in a reactive monomer. The most widely used is styrene, for special applications monomers such as methyl methacrylate, tertiary butyl acetate or diallyl phthalate may be used.

6.2.1.3 Hardeners and accelerators

Resins need hardeners to cure. These hardeners (peroxides) start off the copolymerisation of the monomer and polyester or vinyl ester. This curing may occur at ambient temperature (cold curing), at elevated temperatures (heat curing) or by light. Depending on the curing mechanism, the resin formulation will be extended with accelerators such as cobalt salts, and amines for room temperature peroxide decomposition, or it may contain a light initiator.

6.2.1.4 Inhibitors

Polyesters dissolved in monomers must be protected against premature polymerisation. For this purpose inhibitors, such as hydroquinones or benzoquinones, are contained in the resins.

6.2.1.5 Additives and fillers

Additives and fillers can be incorporated into the resins prior to curing, to make them easier to process and to achieve specific end-product properties. By choosing the right combination of resins, reinforcing fibres, fillers and additives, a composite material can be formulated to suit practically any type of application.

The most important additives and fillers are:

- UV stabilisers, to delay yellowing
- skinning agents, e.g. to reduce the emission of uncured monomer during curing
- silica for influencing the processing behaviour (thixotropy)
- thickening agents (such as magnesium oxide), giving a leather-like consistency to the resin
- dyes or pigments
- self-extinguishing agents
- other fillers such as chalk and silicates to prevent shrinkage during curing.

6.2.2 Process safety hazard issues

In the resin industry, much attention has to be paid to process safety issues due to hazards related to the used raw materials. The most important potential hazardous scenarios are related to:

- flammable mixtures in storage and process vessels (like styrene and DCPD)
- dust explosions of raw materials (solid anhydrides, acids, bisphenol A, some inhibitors)
- decomposition reactions and runaway reactions of pure raw materials (DCPD) and reactive mixtures
- hazards of eye contact, skin contact or inhalation of raw materials (like acids), intermediates or finished products
- pressure, although pressure levels used are low (process) to moderate (steam).

6.2.3 Plant layout and operation

Resin production is performed in production plants that may be integrated in larger facilities or that are completely standalone units. In some cases, UPES resins are produced in multipurpose plants where other resins, like alkyds and saturated polyesters, are also produced. The market demands a large variety of resins in order to suit the wide variety of end market applications and conversion technologies applied. This is reflected in the resin production facilities being able to produce a variety of products on the basis of different raw materials (recipes), process conditions and to target final specifications. Order size and packaging demand (bulk, container, and drum) add to the complexity of the production facility.

Typically the core of a resin plant will consist of a number of batch reactors varying in size from 10 – 40 m³. Largely depending on the degree of specialisation of such a facility, a mix of 100 - 200 products based on 100 – 150 different raw materials may be produced. Bulk delivery versus drum/container may vary from 40:60 to 60:40 with order sizes ranging between less than 1 tonne and full tank truck loads.

Resin production shows a trend towards a higher level of automation, but still requires a lot of operator intervention. Apart from control of the process, this includes raw material weighing and preparation, metering of small raw materials, sampling and sample analyses, product filtration and then filling of drums, containers and tank trucks.

Figure 6.2 shows a schematic flow chart of the UP production process.

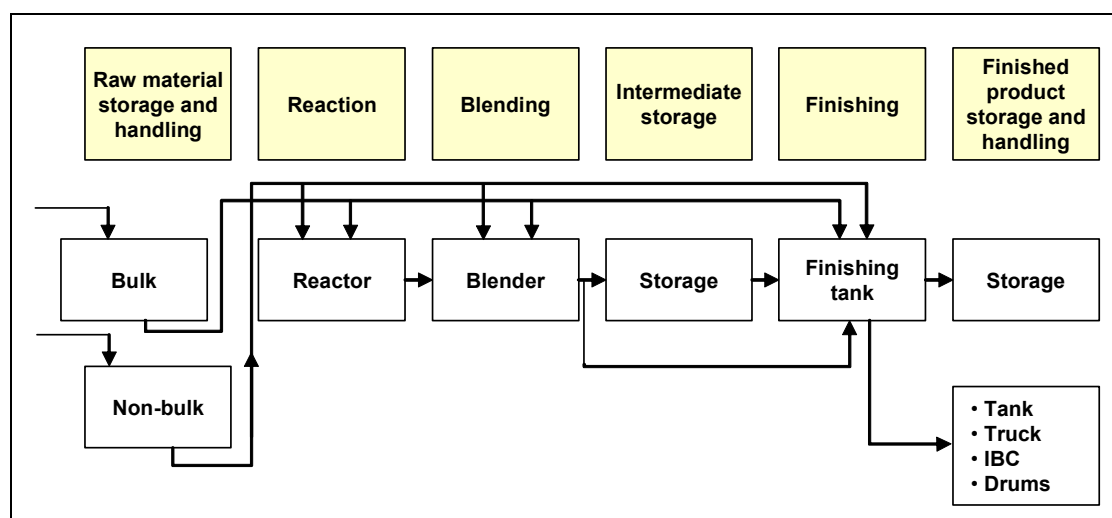

Figure 6.2: Flow diagram of the UP production process

6.2.4 Storage

The main raw materials are usually stored in bulk storage tanks or silos and automatically transferred and metered to the process vessels. Other raw materials, packed into bags, big bags (supersacks), drums and IBCs are stored on site in dedicated storage areas or warehouses. If necessary, conditioned storage facilities or specially designed facilities (peroxide storage) are available.

Prior to use in the process, certain raw materials need to be melted and preheated in ovens. Some installations have heated silos to keep raw materials liquid and ready to use and to avoid the emission of dust from the storage area.

6.2.5 Polycondensation

The polycondensation process is carried out in a batch reactor, which usually has a volume of between 15 and 50 m³, applying predetermined heating, cooling, and pressure (vacuum) profiles, water is split off during this reaction. This condensation water is separated from the reactive mixture through distillation and is collected as reaction water. This water-rich stream is treated prior to disposal to the environment, with possible energy or material recovery. Although production of reaction water is inherent to the process, technology can influence the composition (concentration of organic material).

After the reaction product meets the required specifications (viscosity and functionality), it is cooled and blended in a reactive monomer, usually styrene. This step is generally performed in dilution tanks, equipped with agitation. The base resin is finished, directly or after intermediate storage, to the end formulation and specification requirements, in finishing tanks.

Depending on the plant layout, storage facilities are available for intermediate storage and for finished product storage. Products will be filtered to specification using self cleaning filters and/or disposable cartridge and bag filters.

Although this generic process description is used for all UP, the process will show certain differences depending on the main chemistry applied. This is illustrated in the brief process descriptions relating to the main product groups ortho- and isophthalic polyester, dicyclopentadiene (DCPD) polyesters and vinyl esters.

6.2.5.1 Ortho- and isophthalic polyester production

6.2.5.1.1 Reaction

Glycols and diacids or anhydrides are dosed into a batch reactor at an ambient temperature and under inert atmosphere. When heated, an esterification reaction will take place:

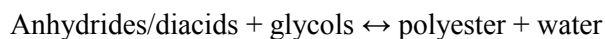

The reaction requires an initial heat-up. Typical heat-up rates are 70 – 90 °C per hour initially followed by a phase where water distillation starts and further heats up at rates of around 15 - 25 °C per hour. Heating is continued until a predetermined batch temperature above 200 °C is reached. The equilibrium is shifted to the right by reaction water removal. For this purpose, the reactor is equipped with a distillation column (for the purpose of separating glycols and reaction water), a condenser and a receiver to collect the reaction water. Water removal is facilitated by applying nitrogen as the inert gas or a vacuum. Alternatively, an azeotropic distillation process may be applied. A solvent is used for water removal, e.g. xylene. In a separator, the xylene-water mixture is separated, the xylene is recirculated back into the reactor and the reaction water is collected in the receiver.

The esterification process is controlled by monitoring the viscosity and the acid values. Usually these values are measured through sampling and the performing of laboratory analyses. If necessary, process conditions may be adapted to make sure the reaction can be stopped at the correct target values of viscosity and acid value. As soon as the product meets the required target specification, it is cooled and transferred to a blender. Typical batch times vary between 15 and 25 hours.

In the case of isophthalic polyesters, the esterification is carried out in two stages. In the first stage, the slow reacting isophthalic acid is heated and polycondensated in the presence of excess glycols. This is followed by a second stage where the other acids/anhydrides (maleic anhydride and phthalic anhydride) are metered to the reactor.

6.2.5.1.2 Blending

The polyester is cooled down below 200 °C and then discharged into a reactive monomer (usually styrene). During the blending, the temperature needs to be controlled at ± 70 °C to prevent a premature reaction. Adequate levels of inhibitors (also to prevent further polymerisation) and other additives are dosed in this stage of the process. Typical styrene levels in the finished product are 30 – 50 %. After filtration, the clear solution containing the polyester and the styrene monomer is ready for delivery to the customer or it is used for further finishing purposes.

The product may be stored in intermediate storage facilities.

6.2.5.1.3 Finishing

In this process step, the polyester is finished to meet the specific application requirements. The mixing steps are carried out at ambient temperatures. Typical operations at this stage are:

- mixing of various intermediate polyesters
- addition of silica to produce thixotropic resins
- addition of titanium dioxide for pigmented resins
- addition of mineral fillers for so-called filled resins.

A variety of test methods are used to finish the product to the desired specifications such as solid content, viscosity, reactivity, gel time.

6.2.5.2 Dicyclopentadiene (DCPD) polyester production process

DCPD is used as a raw material in the manufacture of the so-called DCPD-based unsaturated polyester (UP) resins, where both high purity grades and resin grades are used. This class of products shows special characteristics compared to standard UP resins based on orthophthalic anhydride, isophthalic acid, etc. and these include:

- lower molecular weight/reduced viscosity
- increased reactivity (increased state of cure after a given time)
- improved wetting properties
- increased heat resistance
- reduced shrinkage
- increased solvent resistance.

The process only differs from the ortho- and isophthalic polyester process as far as the production itself is concerned; blending and finishing are carried out in the same way for both processes.

6.2.5.2.1 Reaction

The production of DCPD-based UP resins follows various different routes using different recipes and process conditions. There are two main routes for the manufacture of DCPD resins. The first and most important route is end-capping of the polymer backbone with DCPD. This chemistry is based upon hydrolysis of maleic anhydride into maleic acid, and the addition of DCPD to maleic acid. This end-capping reaction results in lower molecular weight and lower viscosity resins.

The second method is based on the formation of nadic anhydride and a chain extension of the molecules. This reacts via a Diels-Alder reaction. The DCPD is split into two cyclopentadiene molecules which react with maleic anhydride to form nadic anhydride. The nadic anhydride reacts further in a condensation reaction as described for orthophthalic polyesters (see Section 6.2.5.1).

As strong acids react with DCPD much faster than weak ones, the conditions must favour the use of the strong acid from maleic anhydride or acid prior to the reaction in an esterification mode. The first step is to charge the reactor with maleic anhydride and water, into which the DCPD is gradually charged.

This *in situ* addition reaction step is exothermic. If the temperature exceeds 140 – 160 °C, the liquid DCPD molecule decomposes into two gaseous cyclopentadiene molecules, which subsequently lead to an increase of the pressure in the reaction vessel and if uncontrolled, to an explosion.

It is, therefore, essential to keep the temperature well below this maximum during production. Consequently, all involved parameters included in DCPD resin production (resin formulation, resin processing, reactor and processing systems) must be carefully designed, controlled and maintained to prevent ‘runaway reaction’ risks during production. This can be achieved through designing resin formulations and processing parameters to allow control of the exothermic reaction.

It is also essential that good safety systems are designed and installed, with:

- high integrity levels as to raw material charging and metering
- a high integrity level of temperature controls, both concerning reactor heating and cooling
- ample reactor cooling capacity, as well as a cooling capacity back-up.

When this first reaction step is terminated, the dicyclopentadiene maleate formed is esterified, blended and finished in the normal way, as described for orthophthalic polyesters. Inherent to a well managed and controlled process, polycondensation will generate reaction water containing unreacted raw materials and impurities from the used DCPD raw material. These are by-products with hazardous characteristics and have a very strong smell. The production of DCPD resins, therefore, normally takes place in a closed system and includes treatment of all gaseous and liquid emissions. To treat the off-gases, the following techniques are currently used:

- regenerative thermal oxidation (thermal oxidation with energy recovery)
- active carbon adsorption, in particular at smaller production sites.

Apart from the smell, the main environmental issues when producing DCPD resins are:

- correct and safe storage and handling of the raw material to maintain chemical stability (storage temperature $<30\text{ }^{\circ}\text{C}$), and avoiding acids and oxidising agents coming into contact with the raw materials
- the DCPD concentrate is considered harmful to the environment, and has low solubility in water. Storage must consequently be carried out in a safe way to prevent emissions to water, air and soil
- primarily due to the strong smell, but also due to the higher amount of organics in the reaction water, all gaseous products and reaction water from the reactors must be safely collected and treated, for example by means of a regenerative thermal oxidation unit.

A typical DCPD base resin consumes 20 – 35 wt-% DCPD raw material (the rest is normally maleic, glycols and styrene), creating 6 – 10 % reaction water and other by-products, which are collected and treated.

6.2.5.3 Vinyl ester resin production process

Vinyl ester resins are based on the reaction product of an epoxy resin and an ethylenically unsaturated carboxylic acid which results in a terminal unsaturation. Various epoxy resins are used, such as the diglycidyl ether of bisphenol A or higher homologues and epoxyated phenol-formaldehyde novolac. The most commonly used acids are acrylic and methacrylic acid.

The acid-epoxide reaction is straightforward and is catalysed by tertiary amines, phosphines or ammonium salts. Vinyl ester resins are diluted with a reactive monomer such as styrene, vinyl toluene or dicyclopentadiene acrylate. Similar to other unsaturated polyesters, the production of vinyl esters is carried out in batch reactors. The basic steps of the process are:

- reaction, epoxy groups saturation
- blending, dissolving in a reactive monomer.

6.2.5.3.1 Saturation of epoxy groups

The saturation of the epoxy groups takes place in a stirred batch reactor by the addition of methacrylic acid to the epoxy resin. Epoxy resin is fed into the reactor and the temperature is raised up to $115\text{ }^{\circ}\text{C}$. The catalyst and the inhibitor are added to the reaction mixture.

The methacrylic acid is progressively fed into the reactor. The reaction is exothermic and, during this phase, the temperature of the mass has to be maintained below $120\text{ }^{\circ}\text{C}$. The reaction heat is continuously removed by means of a cooling water circulation through the coils of the reactor vessel.

The process is controlled by monitoring the acid value of the reactive mixture. Unlike the UP processes discussed above, the vinyl ester process is an addition, not a condensation reaction. Therefore, no contaminated reaction water is formed as a by-product.

Lack of control may lead to excessive polyaddition and gel formation with process downtime with raw material losses being a consequence. With respect to the control of undesired exothermic reactions, the polymerisation of methacrylic acid is a particular risk.

6.2.5.3.2 Blending

After the reaction between the epoxy resin and the acid has been completed, styrene and additives are added to obtain the required characteristics of the finished product. After the dissolution in the styrene, the temperature of the mass has to be quickly lowered to below 30 °C to prevent the product curing.

6.2.5.4 Finishing

The finished product is a reactive intermediate which has a shelf life of normally around six months. Storage times and conditions at the production factory, during transportation and at the customer warehouse have to be controlled to avoid unwanted curing.

6.2.6 Curing

Curing of the resin is covered by the scope of the IPPC Directive whenever it fits into the criteria for inclusion as an associated activity.

6.3 Current emission and consumption levels

[5, CEFIC, 2003]

The present maximum emission and consumption levels are summarised in Table 6.4.

Item	Unit	Current maximum value	Definition
Energy	GJ/t	5.80	Energy in gigajoules per tonne of saleable product. Electricity is included for its direct energy value. Off-site efficiency losses are excluded.
Water	m ³ /t	13	Water in cubic metres per tonne of saleable product. Water consumption refers to almost 100 % cooling water.
VOC to air	g/t	1000	Volatile organic components in grams per tonne of saleable product. Includes fugitive losses.
CO to air	g/t	120	CO in grams per tonne of saleable product.
CO ₂ to air	kg/t	180	CO ₂ in kilograms per tonne of saleable product. Excludes any CO ₂ related to external electricity generation.
NO _x to air	g/t	250	NO _x in grams per tonne of saleable product.
SO ₂ to air	g/t	100	SO ₂ in grams per tonne of saleable product. Dependent on the sulphur content of the energy source.
Particles to air	g/t	40	Particles in gram per tonne of saleable product. Sources are fuels and dry blending processes/solid handling.
Waste water (COD) (After WWT)	g/t	140	
Hazardous solid waste to landfill	kg/t	13	
Hazardous waste for external treatment	kg/t	20	Hazardous solid waste in kilograms per tonne of saleable product. The figure includes routine production and excludes incidental, special causes resulting in maloperation and rejected material.

Table 6.4: Current maximum emission and consumption levels

Good industrial practice emission and consumption values are summarised in Table 6.5. For some parameters, there is a minimum and a maximum value given which show the range of data.

Item	Unit	Minimum value	Maximum value	Definition and background
Energy	GJ/t		3.5	Energy in gigajoules per tonne of saleable product. The maximum value typically applies to a standalone plant which generates its own steam/hot oil from a primary energy source (natural gas or oil). Electricity is included for its direct energy value. Off-site efficiency losses are excluded.
Water	m ³ /t	1	5	Water in cubic metres per tonne of saleable product from the water supply system.
Nitrogen	Nm ³ /t	30	60	Used for blanketing and water removal.
VOC to air	g/t	40	100	Volatile organic components in grams per tonne of saleable product. Includes fugitive losses. Referring to the use of thermal oxidation.
CO to air	g/t		50	CO in grams per tonne of saleable product. Very low CO emissions are only feasible if there is no on-site thermal oxidation and only natural gas is used as an energy source.
CO ₂ to air	kg/t	50	150	CO ₂ in kilograms per tonne of saleable product. Excludes any CO ₂ related to external electricity generation.
NO _x to air	g/t	60	150	NO _x in grams per tonne of saleable product
SO ₂ to air	g/t	~ 0	100	SO ₂ in grams per tonne of saleable product. The figure is essentially dependent on local fuel sources.
Particles to air	g/t	5	30	Particles in grams per tonne of saleable product. Sources are fuels and dry blending processes/solid handling
Waste water (COD) (after WWT)	g/t			Plants to comply with local regulations at all times.
Hazardous solid Waste to landfill	kg/t		0	
Hazardous waste for external treatment	kg/t		7	Hazardous solid waste in kilograms per tonne of saleable product. The figure includes routine production and excludes incidental, special causes resulting in maloperation and rejected material. Excludes aqueous stream sent off site for waste water treatment or incineration.

Table 6.5: Good practice industry values for emission and consumption levels

6.3.1 Emission and consumption data from example plants

The following consumption data were reported by three plants (Table 6.6):

Item	Unit	Plant 1	Plant 2	Plant 3
Energy	GJ/t	2.19	4.32	4.0 *
Water	m ³ /t	1	1	-

* Combined energy consumption for resin and an ancillary gel coat production operation. Resin energy usage is likely to be 3.2 - 3.6 GJ/tonne.

Table 6.6: Energy and water consumption data for UP plants

Table 6.7 shows the emission data regarding emissions to air.

Item	Unit	Plant 1	Plant 2	Plant 3
VOC to air	g/t	31****	144 **	<100
CO to air	g/t	27	45	22
CO ₂ to air	kg/t	80	55	76
NO _x to air	g/t	105	26 ***	80
SO ₂ to air	g/t	12	29	80
Particles to air	g/t	30 - 35	150***	30 - 35

** Includes fugitive emissions from pumps, valves, and sample points. Point source emissions were only 40 g/t.
 *** This plant has no boilers; steam is supplied from an adjacent industry. The only emission source is a catalytic oxidiser that has recently been upgraded to burn only vapours (it previously burned water and vapour) - so now the energy consumption is considerably lower.
 **** Actual values are likely to be higher because of a new product mix.

Table 6.7: Emission data for UP plants

6.3.2 Sources of environmental impact

For polyester producing processes, the following sources of environmental impact have been identified:

- spillages and losses of (environmentally hazardous) raw materials, intermediates and finished products from closed systems and secondary containments
- contaminated reaction water and its treatment (on-site treatment or external treatment)
- waste gas and its treatment
- fugitive emissions (gaskets, seals, valves)
- waste water from cleaning and rinsing and its treatment
- solid waste and its treatment. A certain percentage of products will not meet specification and will not be suitable for customer application; the majority of these products will be internally recycled back into the production process, however some minor quantities will have to be managed as hazardous waste. Other hazardous waste comes from packaging material, filtration cartridges and bags, samples
- energy consumption. The energy consumed to produce polyester is dependent on the product-mix and the economy of scale (both unit operations and overall plant size). The main energy use is thermal energy for conditioning of raw materials and buildings/installations, for the production process (heating, cooling, distillation) and, if applicable, for reaction water treatment; another main source of use is electricity driving numerous pumps, agitators, compressors and other electrical equipment.

7 EMULSION POLYMERISED STYRENE BUTADIENE RUBBER

[13, International Institute of Synthetic Rubber Producers, 2002]

7.1 General information

Styrene butadiene rubber (SBR) was developed in Germany in the 1930s and later in the 1940s in the US, as an alternative to natural rubber. Emulsion styrene butadiene rubber (ESBR) has advantages and disadvantages when compared with natural rubber and directly competes with it. However, in many applications the two are complementary, being used in blends to give superior properties. ESBR is often referred to as a general purpose synthetic rubber.

ESBR production plants rely on readily available monomers, styrene and butadiene, hence plants are often located as part of integrated refineries or chemical complexes, or as adjuncts to such complexes. A wide range of other chemicals such as emulsifiers, catalysts, modifiers, shortstops, antioxidants and extender oils, are also required.

ESBR is the largest volume synthetic rubber accounting for about 30 % of the overall total. Figure 7.1 indicates a value of 43 % for SBR. It should be noted that this is the combined share for both emulsion (ESBR) and solution polymerised (SSBR) types. Solution SBR is produced via a distinctly different process and has different technological properties and fields of application.

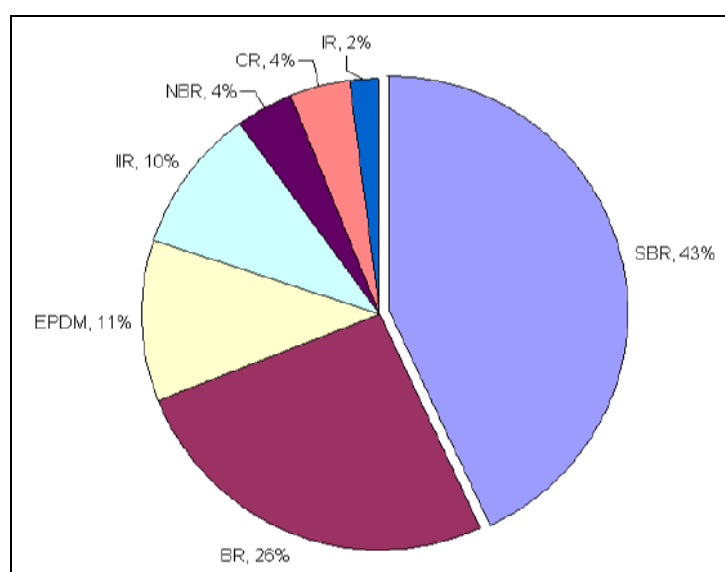

Figure 7.1: Production share of synthetic rubbers

With:

SBR	Styrene butadiene rubber
BR	Butadiene rubber
EPDM	Ethylene propylene diene monomer
IIR	Isobutylene-isoprene rubber
NBR	Acrylonitrile-butadiene rubber
CR	Chloroprene rubber
IR	Isoprene rubber

In total, there are ten plants that produce ESBR in Europe (excluding Russia) with a combined nameplate capacity of 820000 tonnes per year. Of these, five are located in the EU-15, with a combined nameplate capacity of 466000 tonnes per year. An overview of the European ESBR producers is given in Table 7.1. In the context of the European polymer industry, this amounts to 1.3 % of the total production of polymers.

Russia has a nameplate capacity of over 600000 tonnes, but it is not known how much of this is operational at present. Thus, with an overall consumption of approximately 470000 tonnes per year, or 610000 if Central Europe is included, there is a net over-capacity in Europe.

Location	Nameplate capacity tonnes/year
Ravenna, Italy	120000
Southampton, UK	90000
La Wantzenau, France	80000
Schkopau, Germany	91000
Pernis, Netherlands	85000
Oswiecim, Poland	104000
Kralupy, Czech Republic	90000
Zrenjanin, Serbia and Montenegro	40000
Burgas, Bulgaria	20000 *
Onesti, Romania	100000 *
Total	820000
* Estimated by IISRP, the International Institute of Synthetic Rubber Producers	

Table 7.1: European ESBR producers, locations and capacity

The ESBR industry in Europe has a turnover of approximately EUR 460 million. It is part of a worldwide industry with production plants in most industrialised and many developing countries. ESBR is a mature product with five major types being produced which are often traded as commodities.

The major cost in ESBR manufacture is the purchase of the monomers. The monomer price is dependent on the crude oil price, but can fluctuate quite widely due to other reasons. ESBR is a raw material (a raw rubber) which is sold to the rubber goods producers. There it is mixed with reinforcing fillers, oil and vulcanising chemicals to produce rubber compounds. The rubber compound is then shaped and vulcanised under heat and pressure to produce the finished rubber article. Often, the ESBR is blended with other types of raw rubber, such as natural rubber or polybutadiene, to modify the properties of the finished article.

About 70 % of ESBR is used for the manufacture of car tyres, in particular in the tread where it confers a good balance between wear resistance and wet grip. ESBR is also used to manufacture conveyor belts, flooring and carpet underlay, hoses, seals, sheeting, footwear and a large number of other rubber goods. The main applications of ESBR are shown in Figure 7.2.

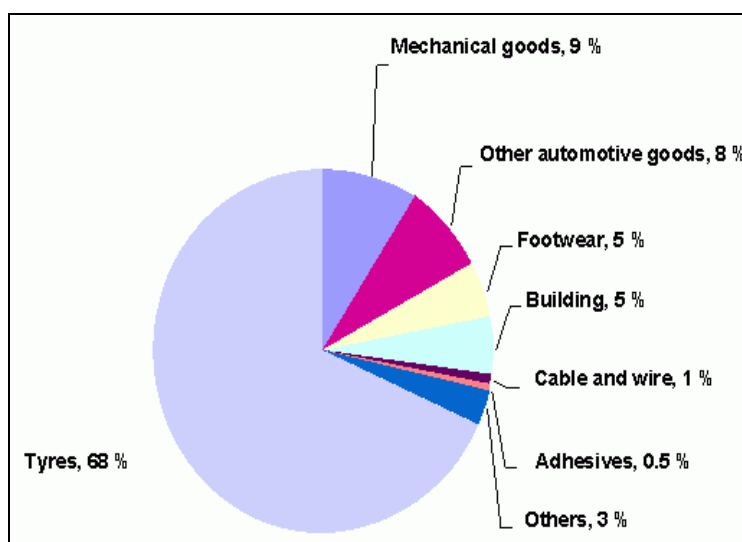

Figure 7.2: Main applications of ESBR

Despite being referred to as a commodity, ESBR is a high performance product. It is manufactured to a high quality level because of its principal application in safety critical products. In other application areas, such as conveyor belts, the products are expected to perform well for many years under demanding conditions. In order to achieve the required performance and to work with easy and consistent manufacturing processes, very tight specifications are applied by rubber goods manufacturers.

The production of ESBR is highly capital intensive, hence the industry in Europe only employs about 1200 people; however, a further 300000 are involved in the manufacture of tyres and industrial rubber goods.

7.2 Applied processes and techniques in the production of emulsion styrene butadiene rubber

An overview of the production process is given in the flow chart in Figure 7.3.

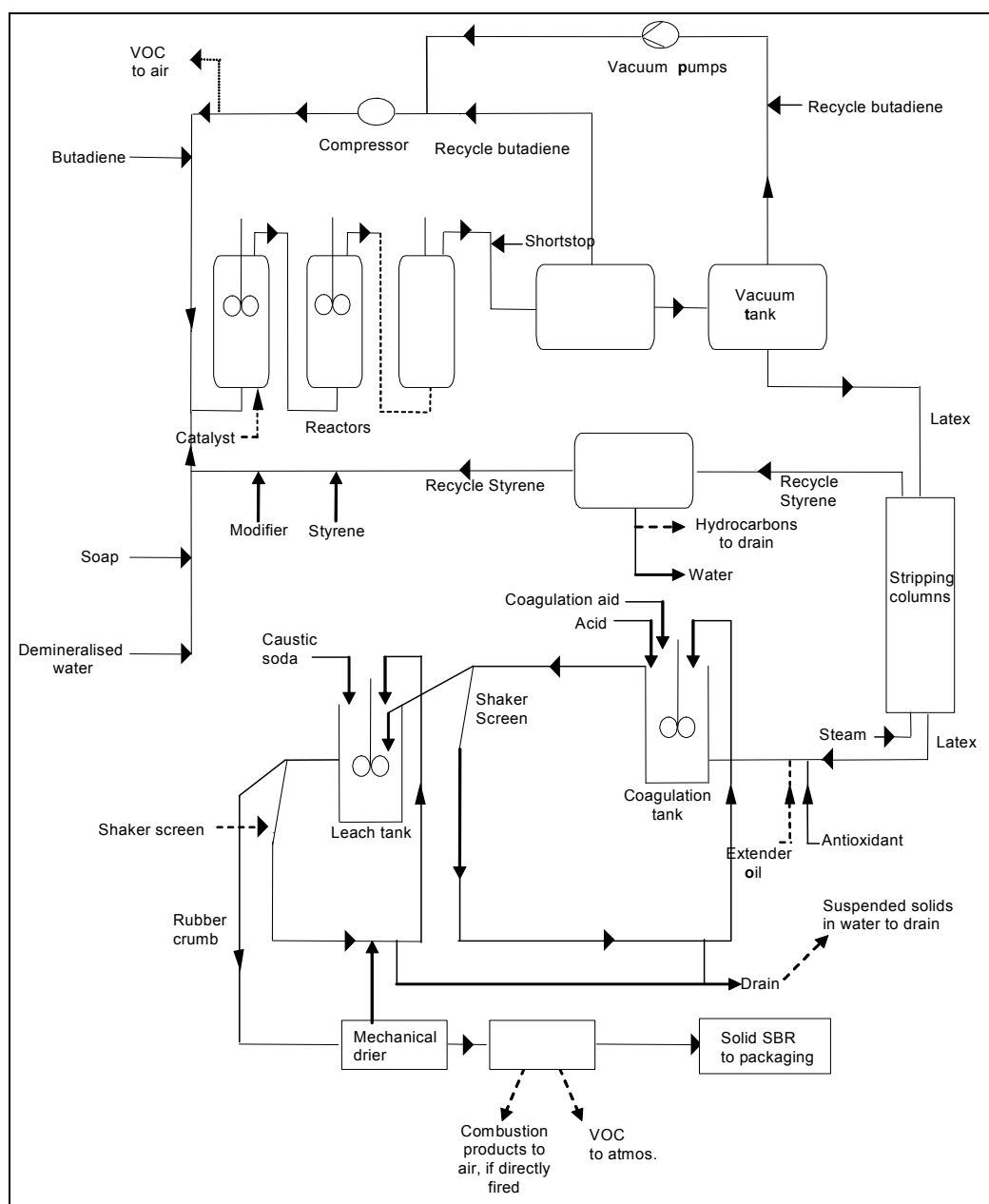

Figure 7.3: Flow diagram of the ESBR production process

Above a critical concentration, surfactant molecules form aggregates called micelles. One example of this phenomenon is a solution of the potassium or sodium salts of fatty or rosin acids. These are usually known as soaps. The addition of monomers which are insoluble in water, such as styrene or butadiene, to the stirred soap solution results in droplets of monomer stabilised by soap molecules being formed. These droplets are approximately 1000 nm in diameter.

Despite being highly insoluble, the monomer is able to diffuse through the water to the soap micelles where it enters the hydrocarbon rich interior of the micelle. The addition of a free radical catalyst results in a polymerisation reaction occurring within the micelle. A high molecular weight polymer is rapidly formed and terminated. The polymerisation is fuelled by more monomer diffusing from the droplets to, what now is called, the growing latex particle.

The latex particle is stabilised by soap molecules adsorbed on the surface. As the particle grows, more soap is required and this is taken from inactivated micelles. At between 10 and 20 % of conversion from monomer to polymer, no micelles are left, as the soap concentration has dropped below the critical micelle concentration. At about 60 % conversion, the monomer droplets disappear.

Polymerisation is terminated before total conversion in order to avoid unwanted effects such as long chain branching and the formation of gel. Termination is effected by the addition of chemical substances known as a short stop, which immediately kills all free radicals.

About ten years ago, all ESBR plants modified their processes to eliminate the presence of volatile nitrosamines. These potentially carcinogenic chemicals were present at concentrations in parts per billion. The changes made eliminated the use of sodium nitrite and one component of the short stop system, sodium dimethyl dithiocarbamate.

The molecular weight of the polymer molecules is regulated by the addition of a chain transfer agent or modifier. This has the effect of terminating one growing molecule and initiating another. The more modifier that is added, the lower the molecular weight of the final product.

The reaction is carried out continuously in a series of continuously stirred tank reactors (CSTR) under moderate pressure. The latex is then stripped of unreacted monomers. Butadiene is removed in flash tanks, the first at atmospheric pressure and an optional second under vacuum. The latex then passes to steam stripping columns, where styrene is removed.

The resultant latex contains about 10^{15} particles/cm³ and each particle is about 60 nm in diameter. The content of solids is typically between 20 and 25 %. The basic technology of emulsion polymerisation has remained more or less unchanged since the 1940s, when the introduction of the redox catalyst system saw the production of the so-called 'cold SBR'. The redox system allows the production of free radicals at a low temperature of 5 °C instead of 50 °C (hot SBR), resulting in a better controlled reaction and a rubber with improved mixing characteristics and better final properties.

7.2.1 Preparation of rubber bales

The stripped latex is blended with an antioxidant emulsion prior to coagulation. By changing the pH of the latex from alkaline to acidic, the soap is converted to organic acid whereupon the latex immediately coagulates. The organic acid remains in the rubber. The typical concentration of organic acid in the final product is about 5.5 %. The coagulation is caused by the addition of sulphuric acid and coagulation aids, and the rubber appears as small crumbs suspended in water.

After leaching to remove the acid, the rubber crumb suspension passes over screens where most of the water is removed and recycled back into the coagulation process. The wet crumbs pass to a dewaterer which reduces the water content to about 10 %. Then it is conveyed to a dryer where the water content is further reduced to <1.0 %. The dry crumbs are pressed into bales which are wrapped in polyethylene or ethylene vinyl acetate (EVA) film and packed automatically into crates.

The antioxidant is added to protect the rubber during the drying and baling process and to give it an adequate storage life. The typical antioxidant concentration lies in the range of 0.5 to 2.0 %. Under normal storage conditions (dry, mild temperature and indirect sunlight), ESRB will have a storage life of at least one year, providing that the packaging remains undisturbed.

7.2.2 Oil extension

Another important development was made in 1951 with the discovery of oil extension, where a very high molecular weight rubber has its viscosity significantly reduced by the addition of approximately 28 % of compatible oil. An oil emulsion is prepared which is coagulated with the rubber latex. At the moment the emulsion is broken, the oil transfers quantitatively to the rubber – no free oil being observed at any time. Oil extended rubber allows highly filled compounds to be mixed easily whilst maintaining final properties at a high level.

7.2.3 ESRB latex

Some ESRB plants also produce latex as a finished product. The polymerisation plants are used to produce basic latex which has a low solids content and a small particle size. For practical and economic reasons, it is necessary to increase the solids content of the latex. Straightforward evaporation of the base latex only allows a solids content of around 50 % to be reached before the viscosity becomes too high. This problem can be overcome by increasing the particle size in an agglomeration process. Subsequent evaporation of the agglomerated latex enables solids contents of more than 60 % to be achieved whilst maintaining a practical viscosity. These high solids latices are principally used to produce foam mattresses and pillows, foam-backed carpets, adhesives and sealants.

In the case of plants that produce ESRB latex as a finished product, it could be possible use different technical parameters and different processes in addition to those described in Table 7.2 and Figure 7.3 [27, TWGComments, 2004].

7.2.4 Technical parameters

Product type	ESBR
Reactor type	Continuously stirred tank reactors in series
Reactor size	10 - 40 m ³
Number of reactors in use	up to 15
Polymerisation pressure	up to 0.5 MPa
Polymerisation temperature	5 – 10 °C (50 °C is used to produce the so-called 'hot SBR')
Emulsifying agent	Various anionic surfactants, usually fatty or rosin acid soaps. Nonylphenols are used at some sites (see footnote)
Modifier	Tertiary dodecyl mercaptan
Shortstops	Sodium polysulphide
Catalyst/initiators	Isopropyl hydroxylamine, diethyl hydroxylamine Hydroperoxides/iron peroxide salts for hot SBR
% solids at end of reaction	15 - 30 %
Conversion of monomer to polymer	50 – 70 %
Antioxidant	p-phenylenediamine derivatives, phenolic types, phosphite types
Extender oil	Highly aromatic, naphthenic, treated distillate aromatic extract (TDAE), mild extract solvate (MES)
Capacity per reactor line	Typically 30000 - 60000 t/yr.
Note: Nonylphenol is harmful for aquatic ecosystems, and it has been declared as a 'hazardous priority substance' under the Water Framework Directive, meaning that discharge to all water bodies should be stopped by 2015.	

Table 7.2: Technical parameters of the ESBR process

7.3 Current emission and consumption levels

The data given in Table 7.3 have been reported from six plants within Europe. Each category of emission or consumption is expressed as a range which is derived by eliminating the lowest and highest reported values. All values refer to emission or consumption levels per tonne of product.

Item	Unit	Minimum value	Maximum value
Energy and water consumption:			
Steam	GJ	3	8
Electricity	GJ	1	2
Water	m ³	5	50
Emissions to air:			
Total VOC	g	170	540
Discharge from water treatment:			
Waste water volume	m ³	3	5
Site permit levels:			
COD	g/t	150	200
Industrial waste:			
Hazardous	kg	3.0	5.0
Non-hazardous	kg	0.24	3.6
Rubber waste	kg	1.5	5.2

Table 7.3: Emission and consumption data from ESR plants (per tonne of product)

8 SOLUTION POLYMERISED RUBBER CONTAINING BUTADIENE

[42, International Institute of Synthetic Rubber producers, 2004]

8.1 General Information

Solution polymerised rubbers are usually homopolymers of butadiene or copolymers of styrene and butadiene. They can have a variety of behaviours and properties depending on the molecular structure. However, they are classed as one family because of one common feature of the polymerisation process, i.e. the monomers, catalyst and other ingredients are all dissolved in an organic solvent

The family consists of, in order of market volume, polybutadiene (or butadiene rubber, BR), solution styrene butadiene rubber (SSBR) and styrenic block copolymers (SBC). A further sub-division may be made into those polymers that require vulcanisation (BR, SSBR) and those that do not (SBC). The latter are also known as thermoplastic rubbers as they have rubbery properties below a certain temperature when they soften and may be processed like thermoplastics.

Table 8.1 shows the production volume share of the major types of synthetic rubber, including ESBR.

ESBR	Emulsion styrene butadiene rubber	28 %
SSBR	Solution styrene butadiene rubber	12 %
BR	Butadiene rubber (polybutadiene)	24 %
SBC	Styrenic block copolymer	5 %
EPDM	Ethylene-propylene diene monomer	9 %
IIR	Isobutylene-isoprene rubber (butyl/halobutyl)	7 %
IR	Isoprene rubber (polyisoprene)	7 %
NBR	Acrylonitrile-butadiene rubber	5 %
CR	Chloroprene rubber (polychloroprene)	3 %
Source: Worldwide Rubber Statistics 2002, IISRP Houston		

Table 8.1: production volume share of the major types of synthetic rubber

These rubbers are used as follows:

- the principal use of BR is in the manufacture of car tyres, where it is used in blends with other synthetic rubbers to enhance abrasion resistance and to improve dynamic properties. It also finds use in conveyor belting, flooring, sheeting, hoses, seals and many other goods. BR has another large scale application outside the rubber manufacturing industry namely as an impact improver in thermoplastics such as polystyrene, to give the high impact types (HIPS), and ABS
- SSBR is used in tyre manufacture, particularly in the tread compound where it gives a good combination of grip, wear and low rolling resistance. It is also widely used in flooring, sheeting and shoe soles. Some types find application in the manufacture of adhesives
- SBC is a thermoplastic rubber and does not need to be vulcanised. It finds widespread use in footwear, adhesives, bitumen modification and sealants. Its thermoplastic nature allows it to be recycled. The modified bitumens have elastic properties and are used for roofing membranes and for roads.

Solution rubbers account for approximately 42 % of all synthetic rubber production. Worldwide about 5 million tonnes are produced yearly.

There are 15 plants in Europe (including Russia) producing solution rubber with a combined nameplate capacity of 1.3 million tonnes/year. Of these, 12 are located within the EU-15 producing nearly 1 million tonnes/year. In the context of the European polymer industry this production represents 2.3 % of the total production. An overview of the European producers is given in Table 8.2.

Company	Location	Country	Nameplate capacity kilotonnes/year
Company A	Ravenna	Italy	150
Company A	Grangemouth	UK	110
Company B	Dormagen	Germany	55
Company B	Port Jerome	France	120
Company C	Schkopau	Germany	110
Company C	Berre	France	65
Company D	Santander	Spain	110
Company E	Antwerp	Belgium	80
Company F	Berre	France	65
Company F	Wesseling	Germany	60
Company F	Pernis	the Netherlands	20
Company G	Bassens	France	75 ⁽¹⁾
Company H		Romania	60
Company I		Russia	126
Company J		Russia	120
Total			1326
(1) estimated by IISRP Source: Worldwide Rubber Statistics 2002, IISRP Houston			

Table 8.2. Companies and capacities of the 15 plants in Europe producing solution rubber

Solution polymerisation plants rely on the ready availability of butadiene and styrene and the reaction solvent, hence plants are often located as part of integrated refineries/chemical complexes, or as adjuncts to such complexes. A wide range of other chemicals such as catalysts, modifiers, shortstops, antioxidants and extender oils are also required.

Two types of catalyst systems are used, the so-called Ziegler-Natta types and those based on alkyl lithium. Plants using the latter are often multipurpose producing polybutadiene, solution SBR and styrenic block copolymers in quantities depending on market demands. This makes it difficult to estimate the capacities for each type with any accuracy. For this reason, the plant capacities are expressed in terms of solution rubber in general.

8.1.1 Polybutadiene (butadiene rubber, BR)

BR was first polymerised in Russia in 1910. It is the second largest volume synthetic rubber accounting for about 24 % of the total of all types. The consumption within the EU is approximately 340000 tonnes/year.

BR is a raw material (a raw rubber) which has two main markets: the rubber goods industry and the plastics producers. The former blend it with other types of rubber and mix it with reinforcing fillers, oil and vulcanising chemicals to produce rubber compounds. The rubber compound is then shaped and vulcanised under heat and pressure to produce the finished rubber article. The latter incorporate a small amount (5 to 8 %) during their polymerisation processes to enhance the impact strength of the finished plastic. The most widely produced material is high impact polystyrene, HIPS.

About 70 % of BR is used in the manufacture of car tyres, particularly in the sidewall where it improves flex and fatigue resistance and in the tread where it improves wear resistance, 10 % of BR is used to manufacture industrial goods such as conveyor belts, mill linings, flooring, hoses, seals, sheeting, footwear, golf balls and a large number of other rubber goods.

About 20 % is used by the plastics industry.

BR is a high performance product. It must be manufactured to the highest quality level because of its principal application in safety critical products. In other application areas, such as conveyor belts, the products are expected to perform well for many years under demanding conditions. In order to achieve the required performance and to give easy and consistent manufacturing processes, very tight specifications are applied by rubber goods manufacturers and the plastics industry.

The production of BR is highly capital intensive, hence the industry in Europe only employs about 650 people, however, a further 300000 are involved in the manufacture of tyres, industrial rubber goods and high impact plastics.

8.1.2 Solution styrene butadiene rubber (SSBR)

SSBR was first produced in the 1960s following the discovery of the alkyl lithium polymerisation catalyst. It is the third largest volume synthetic rubber accounting for about 12 % of the total of all types (see Table 8.1). Consumption within the EU is approximately 190000 tonnes/year.

SSBR may be divided into two categories:

- random copolymers (80 %) The market for the random copolymers is completely dominated by the tyre industry (95 %). These types are usually extended with compatible oil. They are blended with other types of rubber, including natural rubber, and mixed with reinforcing fillers (carbon black and/or silica), oil and vulcanising chemicals to produce the tread compound where they improve wet grip and decrease rolling resistance thus improving in fuel consumption
- partial block types (20 %). The partial block types are used in rubber flooring, carpet underlay, footwear and in many other applications. They also find widespread use in bitumen modification and in adhesives.

SSBR is a high performance product. It must be manufactured to the highest quality level because of its principal application in safety critical products. In order to achieve the required performance and to give easy and consistent manufacturing processes, very tight specifications are applied by rubber goods manufacturers and the other industries supplied.

The production of SSBR is highly capital intensive, hence the industry in Europe only employs about 500 people; however, a further 300000 are involved in the manufacture of goods containing SSBR.

8.1.3 Styrenic block copolymers (SBC)

SBCs were developed in the US in the mid sixties. They are the largest volume thermoplastic elastomers, being polymers with rubberlike properties but able to be processed as thermoplastics. As a result of these properties, they present two advantages over conventional types: vulcanisation is unnecessary and the scrap can be reprocessed. SBCs account for about 5 % of the total synthetic rubber production (see Table 8.1). The consumption within the EU is approximately 280000 tonnes/year.

SBCs are made using anionically catalysed polymerisation techniques. They are composed of well defined polystyrene and poly-diolefin blocks. Two basic types of configurations, linear and branched (or star) can be produced. The polystyrene and polydiene blocks are chemically incompatible and so a two phase system is formed. The hard polystyrene domains are linked to the rubbery polydiene phase and act as multifunctional cross-links. Below the glass transition temperature of polystyrene, SBCs act like vulcanised rubber whilst above it they act like thermoplastics.

There are three major types of SBC:

- styrene butadiene styrene (SBS) block copolymers (80 %)
- styrene isoprene styrene (SIS) block copolymers (11 %)
- hydrogenated versions of SBS and SIS (9 %), being styrene ethylene butylenes styrene (SEBS) or styrene ethylene propylene styrene (SEPS).

Usually the compounds of SBCs are mixed continuously in a single or twin screw extruder. The SBCs are delivered in pellet or crumb form. The dry compound is premixed and then introduced into the extruder where the complete mixing and homogenisation of the ingredients takes place. SBCs are blended with thermoplastics such as polystyrene and inorganic fillers like clays and whiting. If required, the compounds may be plasticised with paraffinic or naphthenic oils. Some SBC types are supplied in the oil extended form. The hydrogenated types are ozone resistant and more resistant to the environment in general.

SBCs are used to produce modified bitumen for roofing and roads (43 %), footwear (43 %), adhesives (11 %) and a wide variety of technical goods (3 %).

Thermoplastic elastomers, in general, cannot compete with vulcanised rubber compounds where the highest level of physical properties are required. SBC also suffers from having a relatively low maximum operating temperature of about 70 °C. Despite this, it has achieved considerable market penetration.

8.2 Applied processes and techniques

Solution rubber plants are generally integrated into larger production sites, which deliver the required feedstocks (solvent and monomers), electricity, steam, treated water, and take back the solvents for purification or combustion. However, some plants generate their own steam and treated water and import the monomers and solvent.

Typically, a solution diene rubber process can be subdivided into the following process steps:

- purification of monomers and solvent
- polymerisation
- hydrogenation (if applicable)
- blending section
- solvent removal and product isolation
- packaging.

The chemicals used are:

- the monomers (styrene, butadiene and isoprene)
- the catalyst (usually n- or s-butyl lithium or Ziegler-Natta catalysts based on transition metals such as neodymium, titanium and cobalt)
- the solvent (commonly cyclohexane, hexane, heptane, toluene, cyclopentane, isopentane or mixtures thereof)
- process additives like coupling agents, structure modifiers, extender oil, killing agents and product stabilisers.

Figure 8.1 shows the general flow scheme of a solution rubber plant. A general description of each process step is also presented below.

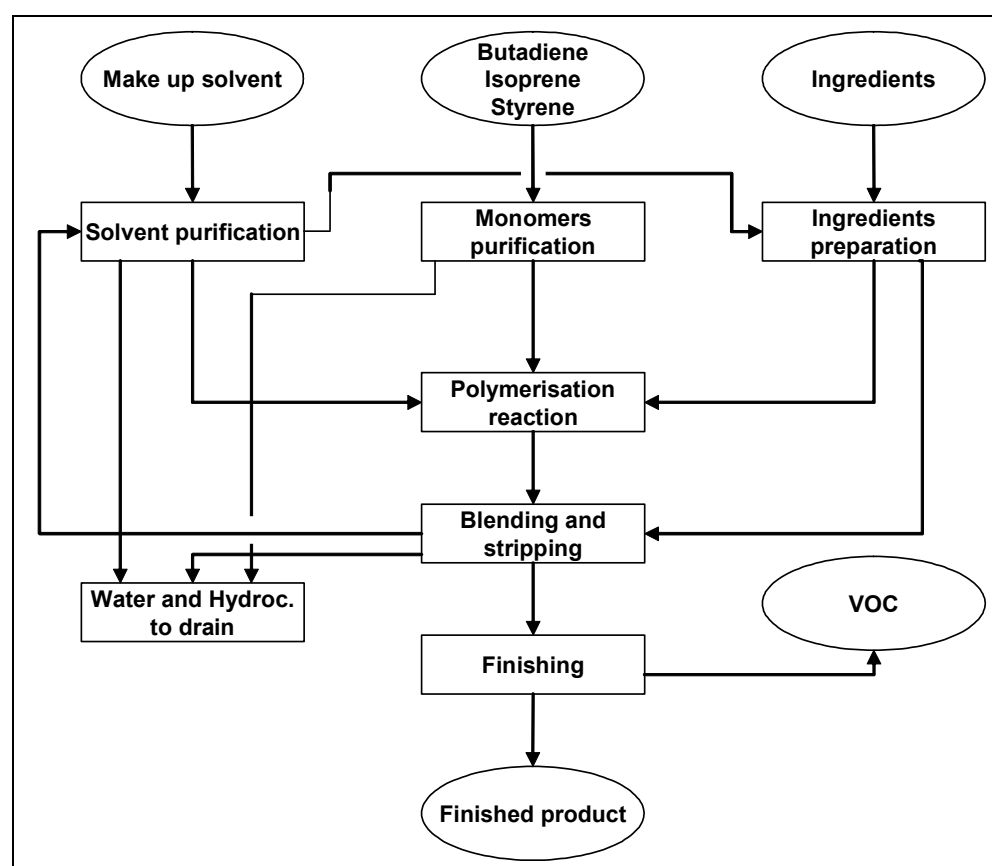

Figure 8.1. Principal flow scheme – solution polymerisation

The principle emission of VOC is from the finishing stage, but diffuse (fugitive) emissions can occur from all stages of the process. If applicable, hydrogenation would occur in a separate stage between polymerisation and blending.

8.2.1 Purification section

Solution processes often comprise an anionically catalysed polymerisation process. The catalyst is highly sensitive to the presence of polar impurities in the feedstream, particularly water. Therefore, it is essential that the solvent and monomers are free of such catalyst poisoning species. Even less sensitive catalysts, such as the Ziegler-Natta types, require a purification step on the feedstock prior to the reaction stage.

Purification is generally operated in a continuous mode. Recycled and make-up solvent are passed through a bed containing molecular sieves. Alternatively, packed alumina columns or distillation columns may be used.

Monomers are generally purified continuously to remove chain terminators such as water, oxygen, stabilisers like p-tert butyl catechol and polar compounds. This is generally done using alumina beds, or by using distillation columns.

8.2.2 Polymerisation section

The polymerisation reaction is carried out in a batch or in a continuous mode depending on the specific process (details in Section 8.2). The reactor is charged with solvent and catalyst. Depending on the targeted polymer, monomers are added simultaneously or sequentially. Where a random copolymer is required, a structure modifier, usually an ether, is added. These chemicals have the additional benefit of increasing the amount of 1,2 polymerisation of the butadiene, i.e. they increase the vinyl content.

The heat of reaction is partially removed via cooling coils or jackets, heat exchangers in a pump around loop or via overhead cooling by means of condensing the evaporated solvent. If heat removal is not applicable, the reaction is adiabatic. The reaction can be carried out in one reactor but mostly a series of reactors are used. Depending on the targeted molecule, a coupling agent is added. In the absence of a coupling agent, a polar compound is added to destroy any living species.

In order to produce the targeted polymer chain and for process safety reasons, it is essential to keep the monomer dosage (the ratio of monomer to solvent) in combination with temperature and pressure in a well controlled range. Very often polymerisation reactors are equipped with a so-called 'killing system' to prevent runaway situations. This constitutes the addition of a polar component, able to react with the active species, thereby stopping the reaction. In some cases, stabilisers are added during the reactor unloading to the blend tanks (not for hydrogenated grades of SBC).

8.2.3 Hydrogenation section

For the production of hydrogenated solution rubbers, the polymer solution is introduced into a reactor. The reactor is able to be operated at elevated temperatures and pressures in order to allow fast hydrogenation. Reactions are generally operated in a batch, semi-continuous or continuous mode. Commonly used catalysts are Ti and Ni species, sometimes in combination with aluminium alkyls.

8.2.4 Blending section

The polymeric solution subsequently goes to a blending section comprising storage vessels of different sizes. Batches are blended following plant specific blending rules. Obviously product analyses are essential in this process in order to check whether the batches are on specification. Product additives like stabilisers and extender oils can also be added in this section.

8.2.5 Solvent removal and recovery

There are two main techniques for removal of the solvent from the rubber solution:

- steam stripping
- devolatilising extrusion.

The criteria used for choosing either a steam stripping technique for solvent removal, or devolatilising extrusion, depends primarily on the properties of the rubber and the customer's process requirements. For example, some end applications require a porous expanded crumb form rubber particle (only produced via steam stripping and mechanical drying), while others request a solid pellet, or a baled product.

8.2.5.1 Steam stripping

On transferring the rubber solution from the blending tanks to the strippers, in some cases extender oil is added and mixed using in-line mixers. The stripping units usually consist of two to three steam distillation contacting vessels, equipped with mixers, operating in series. In the first stripper, the rubber solution is pumped in the agitated vessel through several nozzles, this is for generating small crumbs allowing for a good solvent removal. In order to control the size of the crumbs, and to prevent them from sticking to the vessel walls and to each other, an anionic surfactant may be added to the stripper water together with a soluble inorganic salt. For improving the drying ability in the rubber drying lines downstream, sometimes the pH is controlled by the injection of an acid (e.g. sulphuric acid) and/or a base (e.g. caustic soda).

In the first stripper, the solvent amount is reduced from typically 85 - 70 % weight down to <10 % weight. In order to optimise the energy consumption, the temperature in the first stripper is chosen in such a way that the solvent is boiling off with minimal entrainment of water. The steam injected in the first stripper is usually a mix of fresh steam and steam plus solvent vapours originating from the downstream stripper(s). The solvent evaporation process in the first stripper is thermodynamically controlled.

The vapour mixture of steam and solvent leaving the first stripper is condensed and recovered in decanter vessels, where water and solvent separate. The solvent is recycled into the wet solvent storage tanks for re-use and the water phase is recycled into the strippers. Decantation is controlled by an interface detector system based on the density difference between the water and the solvent.

In the second stripper, fresh steam is injected, thereby reducing the solvent content of the rubber crumbs further down to typically 0.3 - 0.5 % by weight. Solvent removal is diffusion controlled. The temperature in the second stripper is usually 20 °C higher than in the first stripper, for speeding up the diffusion process.

In some cases, a third stripper is operated in series of the two upstream stripper vessels, for further reduction of the residual solvent contents.

After the strippers, a crumb slurry tank is used as a buffer between the upstream (continuous) stripping operation, and the drying/packaging equipment, this for avoiding stripper shutdowns caused by short (<30 minutes) stops on the drying lines downstream. Crumb concentration in the crumb slurry tanks is typically 5 - 10 % by weight. The vapours generated in the crumb tanks by flashing of the crumb slurry coming from the second (or third) stripper is either condensed and recycled to the decanters, or ejected by means of a steam jet to the second (or third) stripper.

8.2.5.2 Devolatilising extrusion

An alternative technique to steam stripping is solvent removal by devolatilising extrusion. This technique is used for those rubber types which have a high melt index, with a high tendency to stick, or which can be easily pelletised. Pelletised products offer the advantage of being easily processed by pneumatic and/or automated solid materials handling systems, since they tend to be free flowing without effects like bridging in the client's process equipment.

After leaving the blend tanks, the rubber solution is first pre-concentrated from typically 15 - 30 % by weight to typically 50 – 85 % by weight using a pre-concentrator. This can be achieved by either preheating followed by flashing in a flash vessel, thereby condensing the flashed solvent vapours, or by using mechanical pre-concentrators (e.g. wiped film evaporators).

The concentrated rubber solution is then further processed by an extruder, equipped with vents, for eliminating the residual solvent. The extruder barrels are heated by means of hot oil or steam jackets. Some of the energy needed for evaporating the solvent is generated in so-called 'heating zones' in the extruder. These zones are equipped with counter rotating screw elements, creating additional friction locally. These zones are also used to separate the different extruder vents by means of a polymer seal, thereby facilitating a progressive decrease in vapour pressure. As the rubber moves down the extruder screw(s), pressure decreases, and solvent is removed gradually.

Some additives are added to the rubber melt in the extruder for avoiding the pellets to stick downstream during pelletisation, or storage (e.g. a wax).

At the end of the extruder, the rubber is extruded through a dieplate and pelletised. The pellets are cooled down by means of spray water, or by using underwater pelletisers. In this way, sticking of the pellets is avoided.

Typical residual solvent levels of the rubber pellets is <0.3 % by weight. The solvent vapours coming from the vent domes of the extruder are compressed and condensed. The vent domes operate between almost atmospheric (first vent) down to 60 mbar (last vent).

The pellets are dried using a spinaway dryer, and then either packaged, or temporarily stored in silos.

8.2.5.3 Elimination of water for steam stripped rubbers

After leaving the crumb slurry tanks, a variety of techniques are used for separating the water from the rubber crumbs. In general, a first treatment consists of press drying of the rubber slurry, using extruders with perforated barrels, followed by mechanical heating and flash drying in a second extruder, and finally hot air drying and cooling on a vibrating belt, or a spiral elevator.

Typical volatile matter content after the drying process is <1 % by weight. An antiblocking agent is added to the crumbs and pelletised products before packaging, to prevent the rubber from sticking on storage. This is achieved by means of mechanical blending. Baled rubbers are wrapped in a polyethylene film before packaging.

8.2.5.4 Packaging

The packaging options used depend on the final rubber product form and the handling facilities at the customer's site: some of those can be bales in boxes, crumbs in boxes, crumbs in paper bags on pallets, crumbs in big bags, pellets in boxes, pellets in bulk.

For this part of the process, again no single 'best' production technique can be identified – they are adapted to the specific rubber end application combination.

8.2.6 Technical parameters for typical solution plants

Table 8.3 shows technical parameters for typical solution plants:

Plant type	Polybutadiene plant	Solution SBR plant	Styrenic block copolymer plant
Product type	High cis polybutadiene, low cis polybutadiene	SSBR, batch or continuous depending on required characteristics	Styrene butadiene and styrene isoprene thermoplastic rubbers
Reactor type and size	Continuously stirred tank reactors in series, 10 - 100 m ³	Continuously stirred tank reactors in series or batch reactors, 10 - 100 m ³	Batch or continuously stirred tank reactors in series, 10 - 50 m ³
Monomer addition	Butadiene	Simultaneous addition of styrene and butadiene	Sequential
Number of reactors in use	Up to 10	Up to 10 depending on the processes	Up to 5
Polymerisation pressure	Up to 5 bar	Up to 5 bar	Up to 5 bar
Polymerisation temperature and temperature control system	30 - 100 °C; external evaporators, cooling coils, adiabatic	30 - 100 °C; control system based on external evaporators, cooling coils, adiabatic	30 - 120 °C, 40 - 90 °C external evaporators, cooling coils, adiabatic
Catalysts/initiators	Depending on different process, Ziegler-Natta catalysts based on titanium, neodymium, cobalt or anionic catalysts such as n-butyl lithium	Various anionic initiators (usually n-butyl lithium)	Usually anionic initiators such as n-butyl lithium or s-butyl lithium
Structure modifiers	No modifiers are used	Various ethers, e.g. THF, TMEDA	Various ethers such as THF, TMEDA
Shortstops	Water and/or fatty acids	Water and/or fatty acids	Water, fatty acids, alcohols, phenols
Conversion of monomer to polymer	95 - 99 %	95 - 99 %	95 - 99 %
Antioxidant	p-phenylenediamine derivatives, phenolic types, phosphite types	p-phenylenediamine derivatives, phenolic types, phosphite types	Phenolic types, phosphite types
Extender oil	Highly aromatic, treated distillate aromatic extract (TDAE), mild extract solvate (MES)	Highly aromatic, treated distillate aromatic extract (TDAE), mild extract solvate (MES)	Paraffinic and naphthenic oils
Capacity per reactor line	Typically 30000 t/yr	Typically 30000 t/yr	Typically 30000 t/yr

Table 8.3 Technical parameters for typical solution plants

8.3 Current emission and consumption levels

The data reported in Table 8.4 have been reported from 16 plants within the EU and give the actual emission levels. Each operating plant is subject to local permits.

Data per tonne of rubber production	Min	Max
Energy and water consumption:		
Steam, (GJ)	9.0	21.6
Electricity, (GJ)	1.3	2.7
Total discharge of water, (m ³)	5.8	21.3
Process water, (m ³)	0.05	7.0
Emissions to the air:		
Total VOC, (kg)	0.31	30.3
Discharge from water treatment:		
COD, (kg/t product)	0.43	1.25
Waste output:		
Rubber waste, kg	1.2	5.8

Table 8.4. Emission levels reported from 16 plants within the EU

9 POLYAMIDES

[4, APME, 2004, 16, Stuttgart-University, 2000]

9.1 General information

Polyamides are chemically characterised by a macromolecular structure having the amide group (-NH-CO-) which is formed by the reaction of a carboxylic group with an amino group as a recurring functional unit that gives the specific chemical properties to the final products. Linear polyamides, widely known as 'nylons', from the original DuPont trademark name, are the most common category of the family.

Generally, there are two different chemical ways to form the amide group. Therefore, linear polyamides are divided in two groups:

- AB type.

These are produced by polymerisation of lactams or ω -amino acids, where A indicates the amino group and B the carboxylic group and both are part of the same monomer molecule. The most important product of this group is polyamide 6 (PA 6) where '6' indicates the number of carbon atoms in the original monomer; in this case ϵ -caprolactam. Other polyamides of this group are polyamide 11 and polyamide 12. The basic reaction, ring opening and polyaddition of ϵ -caprolactam is shown in Figure 9.1.

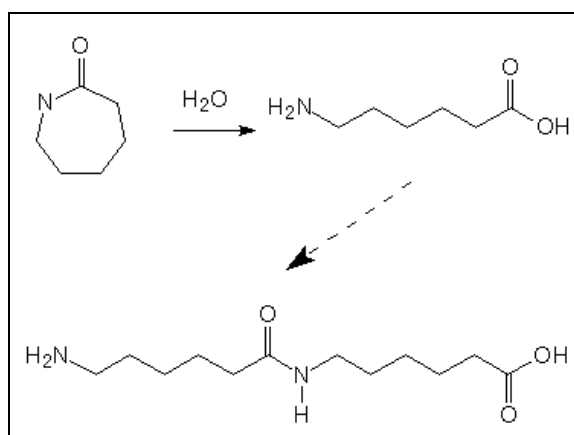

Figure 9.1: Basic reaction of AB type polyamides

- AA-BB type.

Polyamides of the AA-BB type are produced by the polymerisation of a diamine, indicated by AA, and dicarboxylic acid, indicated by BB. Polyamide 66 is the mostly produced product of this type. '66' in this case indicates 6 carbon atoms between the two amino groups of the diamine and 6 carbon atoms of the dicarboxylic acid. The basic reaction 1,6-hexanediamine and adipic acid is shown in Figure 9.2.

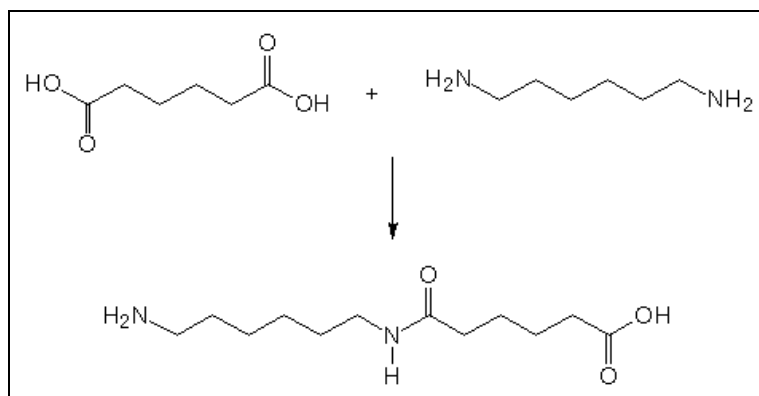

Figure 9.2: Basic reaction of AA-BB type polyamides

Nylons were the first synthetic semi-crystalline plastics, the first synthetic fibres and the first engineering plastics. Today, polyamides are used for various different applications; an overview of the most important ones is given in Figure 9.3.

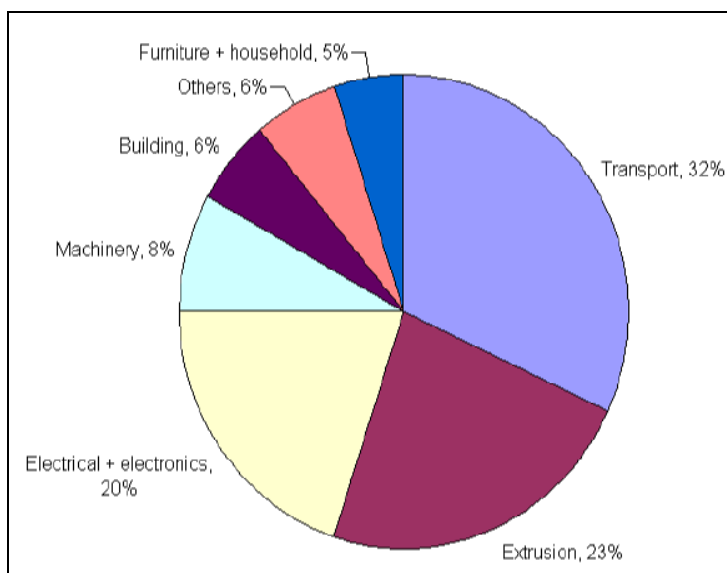

Figure 9.3: Main applications for polyamides

Polyamides can be easily moulded. They are hard and brittle and resistant to abrasion, shrinkage and heat. Certain polyamides are especially flexible and impervious to impact. Polyamides are resistant to deterioration by alkalis, petroleum products, and organic solvents. Hot phenol, formaldehydes, ultraviolet light and mineral acids destroy polyamides. Most polyamides are self-extinguishing in the event of fire.

Polyamide is reported to be produced by seven companies in Western Europe. Overall, the Western European polyamide industry produced 1399 kilotonnes in 2002. A summary of the production data for the years 2000 – 2002 is given in Table 9.1.

Year	2000	2001	2002
Production volume	1369 kt	1307 kt	1399 kt

Table 9.1: Western European polyamide production 2000 - 2002

9.2 Applied processes and techniques in the production of polyamides

9.2.1 Polyamide 6

Polyamide 6 is among the most used polyamides, due to the good availability of the raw material (caprolactam), to the wide range of applications and to the production, transformation and recycling of polyamide 6 being easy and economically viable.

9.2.1.1 General processes

Polyamide 6 can be produced both by batch or continuous polymerisation. Batch polymerisation is preferably used for changing polymer formulations with a wide range of molecular weight, mostly compounding grades. Continuous polymerisation reactors – VK columns (Vereinfacht Kontinuierlich) – have a lower range of product mix but higher productivity and are, i.e. used for the production of textile or industrial fibres. Continuous processes can be operated with one or two reactors in series.

The main process steps used for the production of polyamide 6 are the following:

9.2.1.1.1 Polymerisation

The caprolactam ring is opened in the presence of water (hydrolysis); the linear molecules join together (polyaddition) producing a macromolecular chain, whose length is determined by the presence of a chain terminator (e.g. acetic acid).

9.2.1.1.2 Cutting

The polymer melt is extruded through a plate with holes (spinneret), yielding cylindrical granules (chips).

9.2.1.1.3 Extraction

Due to the equilibrium situation of the polyaddition reaction, the conversion of the caprolactam to PA 6 is 89 – 90 %, the rest being monomer and cyclic oligomers. These oligomers must be removed by hot water extraction, in other words ‘washing’ the chips in a countercurrent demineralised water flow.

9.2.1.1.4 Drying

The moisture present in the chips at the end of the extraction (12 – 13 % of water) is removed by means of a hot nitrogen flow; the purity of the nitrogen has to be very high, as PA 6 is very sensitive to oxygen.

9.2.1.1.5 Extract water processing

The caprolactam and oligomers stripped by the washing water are usually re-used in the process, being concentrated by the evaporation of water in adequate heat exchangers (concentrating columns). The extract water can also be treated with the classical depolymerisation and lactam distillation technologies.

9.2.1.2 Continuous polymerisation of PA 6

The raw materials (caprolactam, demineralised water, viscosity regulator and opacifier) are mixed together and continuously fed into the top of a reactor, the polymerisation column.

The reaction takes 15 – 20 hours and is carried out at a temperature lower than 300 °C and kept constant using diathermic oil (heat transfer medium) to warm the reactor. Going downwards through the reactor to the lower parts and meeting zones at different temperatures, the caprolactam solution is heated and it polymerises to polyamide 6. The polyamide is taken out from the bottom of the column through a spinneret; it is immediately cooled and cut into granules with a cutting machine. The smoke generated during the cooling is collected and sent to a treatment plant.

As not all the caprolactam is polymerised to polyamide, the granules are washed countercurrently to demineralised water in an extractor. After washing, the demineralised water contains high concentrations of caprolactam and is, therefore, sent to a concentration line to recover both caprolactam and demineralised water to be re-used in the process.

The washed granules enter into a last reactor where they are dried in a flow of warm nitrogen. Finally, the dry granules are sent to the storage silos by pneumatic conveying.

Figure 9.4 shows a simplified flow diagram of the process.

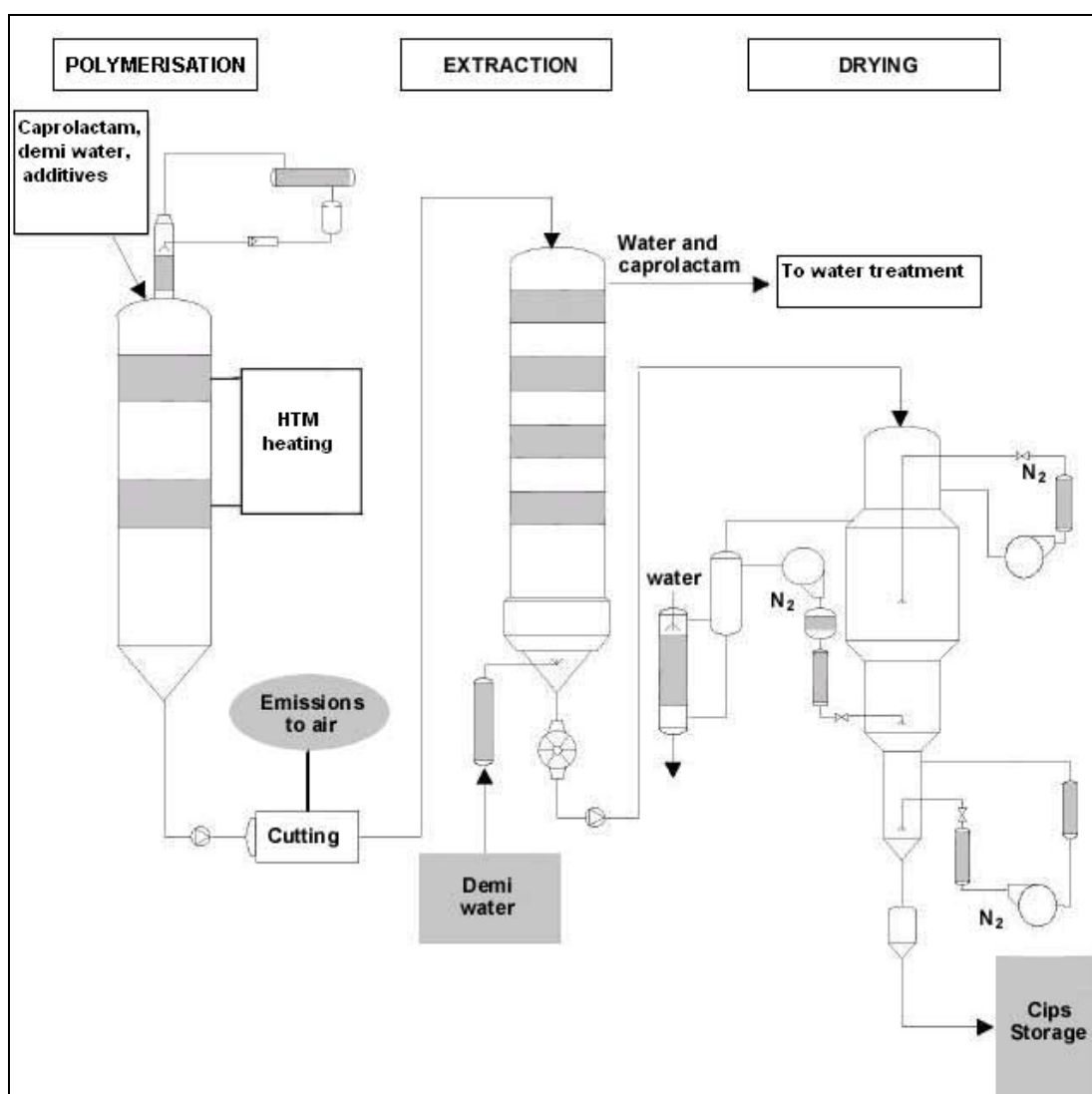

Figure 9.4: Flow diagram of the continuous PA 6 process

9.2.1.3 Discontinuous polymerisation of PA 6

The raw materials (caprolactam, demineralised water, etc.) are mixed in a homogeniser. The mixed batch is then transferred to an autoclave reactor where the temperature (250 - 270 °C) and the pressure are regulated to obtain a polymer with the required specifications.

When the product meets the required specification, the reaction is stopped, letting nitrogen into the reactor, and the polymer is transferred into an extrusion tank. The melted polymer is extruded in cords through a spinneret, cooled in a water bath and cut in chips.

The smoke generated at this stage is collected and sent to an adequate treatment plant.

As not all the caprolactam is polymerised to polyamide, the granules are washed in a countercurrent of demineralised water in an extractor. After washing, the demineralised water contains high concentrations of caprolactam and is, therefore, sent to a concentration line to recover both caprolactam and demineralised water to be re-used in the process.

The washed granules enter into a last reactor where they are dried in a flow of warm nitrogen. Finally, the dry granules are sent to the storage silos by pneumatic conveying.

Figure 9.5 shows a simplified flow diagram of the process.

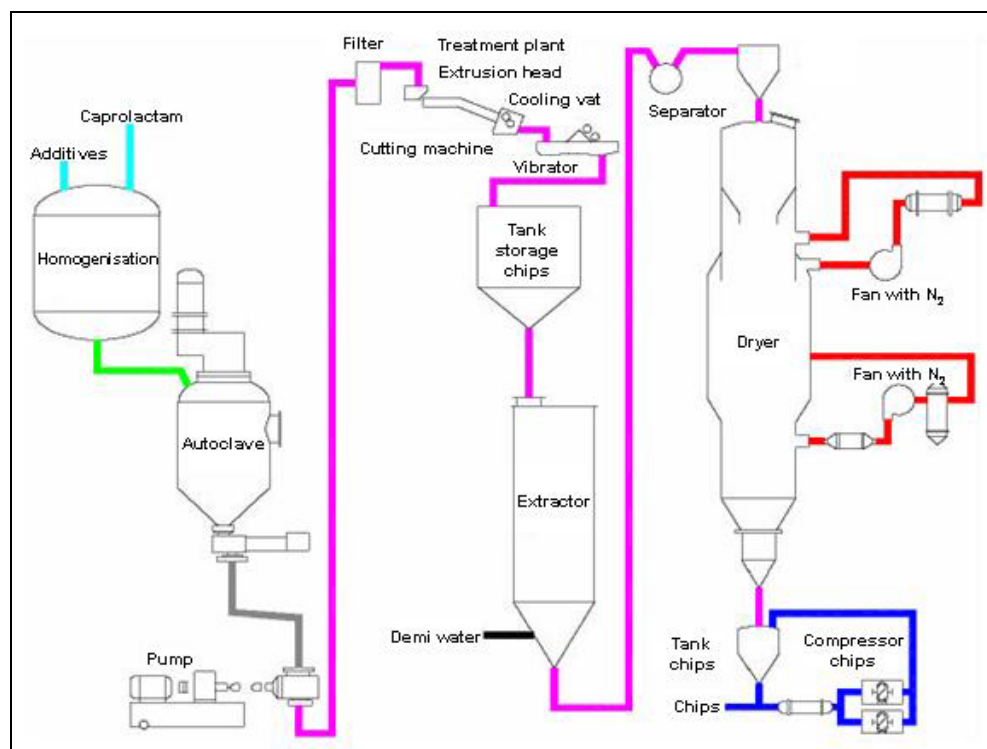

Figure 9.5: Flow diagram of discontinuous PA 6 process

9.2.2 Polyamide 66

9.2.2.1 General processes

Even if other types of polyamides have also gained a certain importance on the world market for particular applications, polyamide 6 and polyamide 66 still represent over 90 % of the world's production of polyamides.

The main raw material for the production of polyamide 66 is an aqueous solution of the organic salt obtained by the reaction of 1.6 hexamethylenediamine and 1.6 hexanedicarboxylic acid (adipic acid), also called AH salt, 66 salt or nylon salt.

Nylon salt is prepared as a homogeneous solution of 52 - 53 % concentration. The product is sensitive to oxygen and it is maintained in storage tanks under nitrogen atmosphere.

Polyamide 66 is manufactured by polymerisation of the nylon salt monomer in solution. Different grades of polymer can be produced, with characteristics which depend on the further processing required downstream (spinning, compounding, etc.), and on the specific application of the end-product, within the product groups in which polyamide 66 is involved (textiles, carpets, industrial fibres, engineering resins, etc.).

Generally, PA 66 can be produced by two different processes:

- continuous polymerisation
- batch polymerisation.

To obtain a polymer with a high molar mass an additional step is required:

- solid state post polymerisation.

9.2.2.2 Continuous polymerisation of PA 66

A solution of nylon salt is constantly fed into the reactor and continuously converted through the sequence of process steps into polyamide 66. The continuous process is more suitable for producing the same type of polymer in bulk quantities, e.g. polyamide 66 standard (medium viscosity type), or polyamide 66 for yarns. Polyamide filament can be obtained in a continuous melt spinning plant directly connected to the polymerisation plant.

Nylon salt from the storage tank at 52 % concentration and 65 °C is pumped to a first step of concentration where, by heating the solution to about 110 °C, part of the water is evaporated increasing the salt concentration to 72 %. The water vapour leaving the concentrator is condensed and the water condensate is collected into a tank.

The salt solution is then pumped through a sequence of preheaters, which increase the temperature of the solution to 212 °C before entering into the polymerisation reactor. This is a pipe, working at a pressure of about 18 bars, divided into different zones (usually three) heated to different levels of temperature, from 212 to 250 °C.

Passing through the reaction pipe, the condensation between the two monomer components starts and the nylon salt is gradually converted into polyamide 66 and water. In order to increase the conversion to the pre-polymer, the water is removed from the reactor as steam, causing some stripping of hexamethylenediamine which has to be compensated by a further addition.

The process of water release and the level of the polymerisation are under the control of set temperature and pressure value parameters. At the outlet of the reactor, the polymer stream is depressurised in a flasher. In this equipment, the temperature rises to 280 °C and the pressure drops to 1 bar. The steam produced is separated from the polymer in a cyclone or other appropriate device, and condensed by cooling water.

The desired final viscosity is obtained passing the flow of the melt polymer through a finisher where, at a temperature of 285 °C, the residual water is lost and the correct average molecular weight of the polyamide is reached.

Where no direct spinning into filaments is present, the polymer is extruded through a spinneret into strands that are immediately cooled in water and granulated using a cutting machine. The wet granules of polymer are collected into an intermediate storage and then sent to the drying units where the polyamide 66 is finally dried under nitrogen flow. The dried granules are conveyed by pneumatic conveyors to the storage silos.

All water condensate generated in the different steps of the polymerisation process is collected in a tank and transferred to the main waste water collecting tank. Vents of the process condensate tanks are all connected to a main vent collector, which breathes to the air through a scrubber and is further cleaned with water.

Figure 9.6 shows a simplified flow diagram of the salt concentration process prior to the polymerisation process which is shown in Figure 9.7.

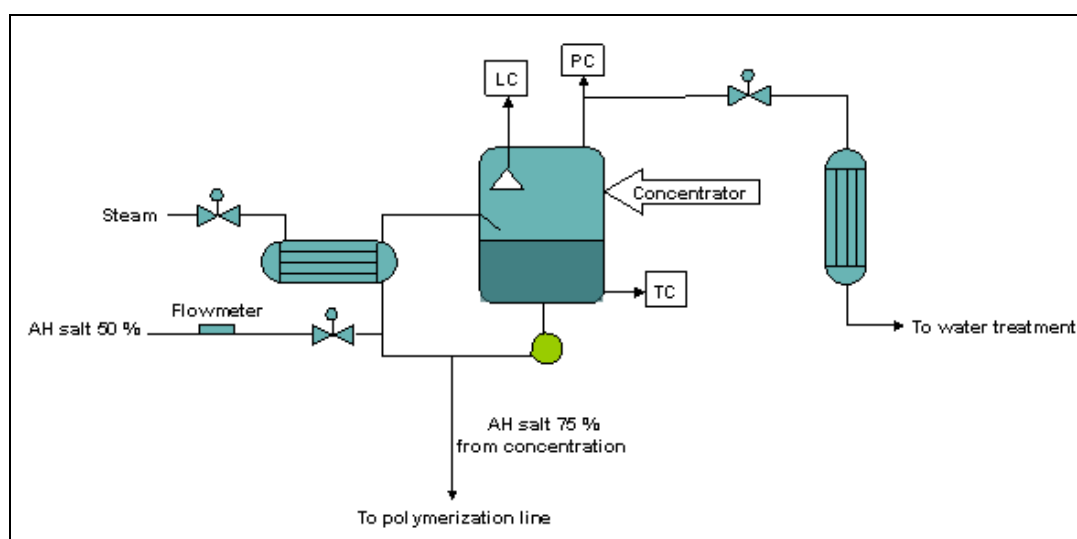

(LC = level control, PC = pressure control, TC = temperature control)

Figure 9.6: Flow diagram of the salt concentration process for PA 66 production

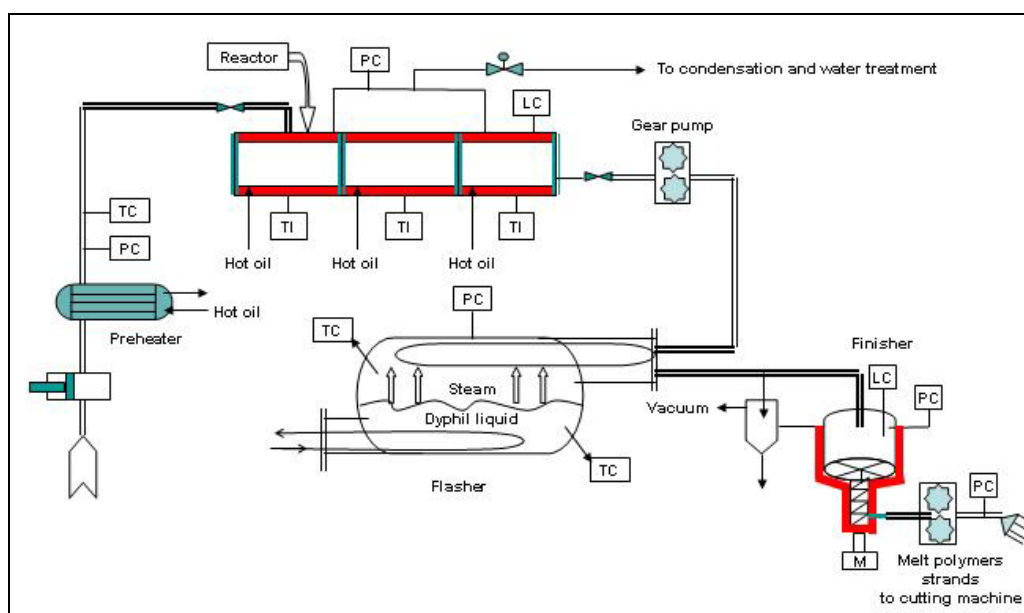

(LC = level control, PC = pressure control, TC = temperature control, TI = thermal insulation)

Figure 9.7: Flow diagram of continuous PA 66 process

9.2.2.3 Batch polymerisation of PA 66

Batch polymerisation is realised in autoclave reactors which operate on a cycle of phases at increased levels of temperature where the time and pressure parameters are carefully adjusted in order to gradually convert the monomer into polymer. The design of the plant is realised in order to optimise the sequences of different autoclaves, giving better continuity to production. The low quantity of product produced per each batch operation and the higher flexibility of the process, make the batch process suitable for the production of speciality polyamides. Batch polymerisation is also suitable for producing copolymers of polyamide 66 and polyamide 6, using partially caprolactam as the raw material together with nylon salt.

The water solution of nylon salt at 52 - 53 % concentration is the main raw material for the batch polymerisation of polyamide 66. Due to the type of process and to the characteristics of the final polymer, some other chemicals and additives (including antifoam agents, molecular weight regulators, lubricants, delustering agents, etc.) are introduced in controlled amounts before the polymerisation starts. The nature and quantity of some of these additives depends on the application of the final polyamide 66, especially for the molecular weight regulator (a monocarboxylic acid), which is responsible for the constancy of the final viscosity of the polymer.

Batch polymerisation is realised in autoclaves. There, the nylon salt solution, transferred from the storage tank, is processed at different temperatures and pressures. The sequence of the operating cycle is set at first to evaporate part of the excess water of the solution (e.g. to a concentration of 70 %). Then, as a consequence of the continuous heat supply, the temperature slowly rises causing the pressure to increase as well. Under these conditions the polycondensation starts. To allow the reaction to proceed, the water is bled off from the reactor in the form of steam, by a control valve that maintains a constant pressure. When the temperature of the mass has reached about 275 °C, the pressure is gradually decreased to atmospheric pressure. The depressurisation rate is a critical parameter and it is fully under the control of dedicated software.

At this stage, the desired viscosity of the polyamide is finally reached maintaining the polymer in a steady condition for a finishing time. The pressure during the finishing, is slightly over atmospheric or under vacuum, depending on the process and on the presence of catalysts. The autoclave is then pressurised and the melt product is extruded through a spinneret in cords, which are immediately cooled in water and cut into granules.

In a modern plant, all process parameters of the cycle and the full set of production lines are under the control and supervision of a DCS (distributed control system).

The granules separated from the water are temporarily stored and, depending on the type of polymer, sent via pneumatic conveyors to different post-treatments. These may include drying of the polyamide 66 to a specified value of final humidity, and post-polymerisation as solid state. This last process can be used to increase the average molecular weight to produce high viscosity polyamide 66 for special applications. Both these operations can be undertaken in batch or in continuous mode, but for all cases, oxygen has to be excluded to avoid degradation of the polymer. In the continuous process, a flow of nitrogen as a carrier for the small quantity of water generated, can substitute the use of a vacuum.

The granules of the final polyamide 66, of different grades, are sent to storage silos by means of pneumatic conveyors.

All water vapour blown off from the autoclave during the polymerisation cycle is condensed and collected in a service tank. This water is sent to the main waste water storage tank for proper homogenisation, before it is sent to a waste water system.

Gaseous emissions are justified during the filling, flushing with nitrogen and depressurisation of autoclaves. These emissions, together with the vents of the process water condensate system and other suctions in some specified points of the working place, are all jointly washed in a scrubber before being vented to the air by a stack.

The level of contaminants in the washing water is maintained at a controlled concentration, purging part of the water circuit with fresh water. The water purge is joined to the main flow of waste water.

Figure 9.8 shows a simplified flow diagram of the process.

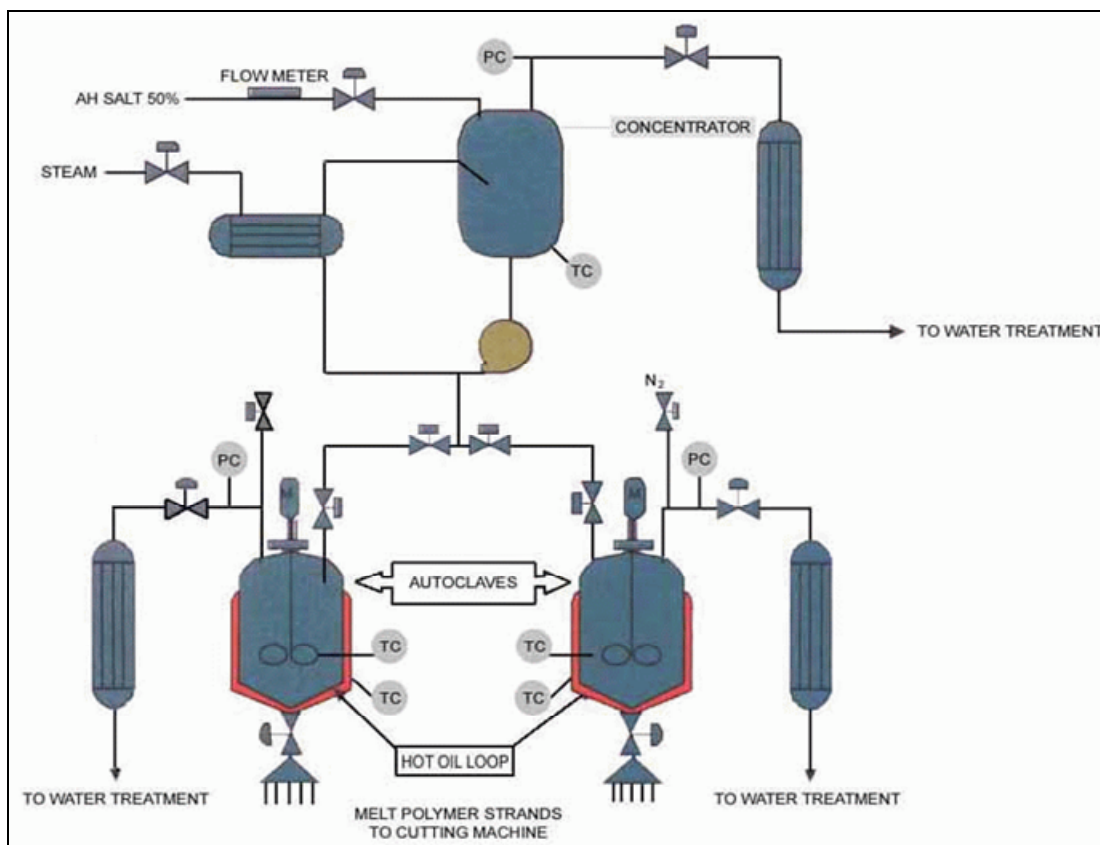

(PC = pressure control, TC = temperature control)

Figure 9.8: Flow diagram of the batch PA 66 polycondensation process

9.2.3 Spinning techniques

9.2.3.1 General processes

The most common use of the polyamides is for the production of yarns and fibres for different applications:

- textile fibres, continuous fibres used in the textile sector
- industrial fibres, continuous fibres used for technical applications
- staple fibres, used for textile flooring and clothing
- bulk continuous filament fibres (BCF fibres) for textile flooring.

The main steps in the spinning of polyamides are the following:

9.2.3.1.1 Storage and post-polymerisation

Polyamide granules have to be stored in an inert atmosphere, i.e. in silos inertised with high purity nitrogen. While polyamide 6 can be used in the spinning process as it comes out of the polymerisation process, polyamide 66 is normally dried, rising its viscosity by 10–20 % according to the requirement of the final product (a higher viscosity is required for high tenacity yarn).

9.2.3.1.2 Spinning

The polyamide chips are melted in special equipment at about 300 °C, and then sent through a heated pipe to the spinning heads, where the melt spins produce the yarn. Each yarn is made up of a different number of filaments coming from the same spinneret: this gives the final product specific properties.

The dimension of the yarn is usually determined in deniers (weight in grams of 9000 metres of yarn): lower deniers (<100) usually characterise textile yarns, higher deniers (up to some thousands) characterise BCF and technical yarns.

9.2.3.1.3 Drawing and winding

After being cooled with conditioned air, the yarn undergoes different treatments in order to reach the required specifications:

- intermingling with compressed air to entangle the filament of each single yarn
- finishing with chemicals to give antistatic and antibacterial properties
- thermal-mechanic drawing/texturing/thermal-fixing to reach the necessary mechanical properties.

The yarn is normally wound up onto bobbins, but can be also cut and baled (staple fibres).

9.2.3.2 Processing of textile yarns

The polyamide fibres are produced by melting and spinning the polymer, normally supplied in the form of pellets (chips).

The polyamide granules are fed into a mixer (extruder) where they are melted. In some processes, the polymer melt comes directly from polymerisation (direct-spinning) or, in the case of polyamide 66, from post-polymerisation.

The polyamide is pumped through heated pipes to the spinning heads, where it is spun through the spinnerets; the flow in each of the capillaries of the spinneret is regulated with metering pumps. The filaments are immediately cooled with air and brought together in order to produce one or more thread lines. The smoke generated during the cooling is collected and sent to a treatment plant.

The thread lines are entangled with compressed air and then lubricated with special chemicals (spin finish) that give the yarn the required physical properties. Some effluents and fumes are produced in this section and sent to a treatment facility.

Finally, the yarns are wound up at high speed (up to 6000 m/min) on special equipment (take-up), producing bobbins with a weight of 10 - 20 kg. Some special technologies (FOY, FDY) require a drawing stage on appropriate rolls before winding the yarn.

The bobbins are then sorted and packed into cartons or wrapped in rows on pallets.

All the process areas are air conditioned.

Figure 9.9 shows a simplified flow diagram of the process.

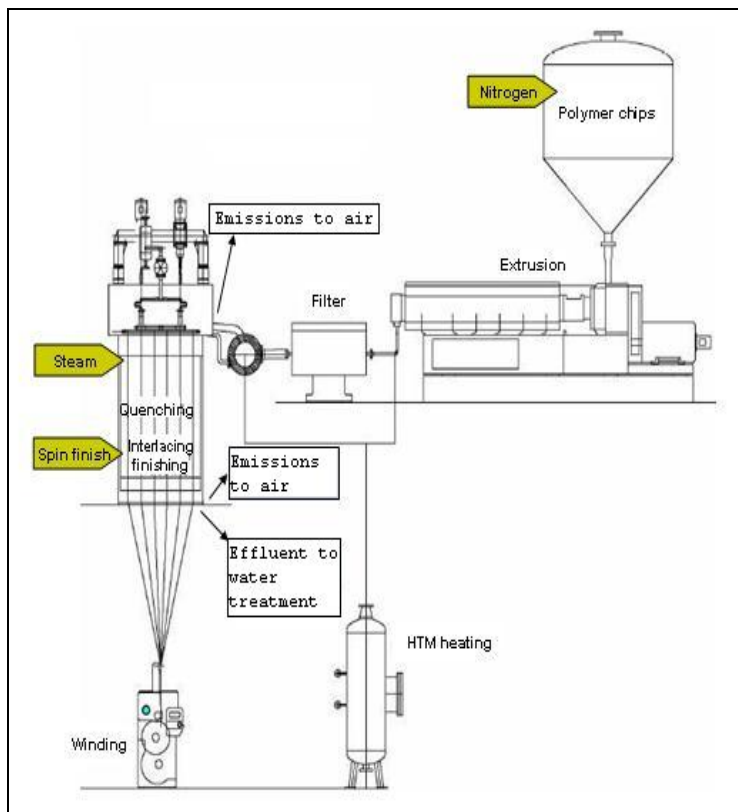

Figure 9.9: Flow diagram of the spinning process for textile yarns

9.2.3.3 Processing of technical yarns

The main difference in the production of technical yarns is the presence of a multiple drawing stage before winding, which is necessary to give the yarn a higher tenacity. The melting and spinning phases are described in the same way as for the textile yarns.

The yarn is then drawn on four rolling mills (godets); the hot godet causes some fumes that must be collected and sent to the treatment plant.

Finally, the yarns are wound up at high speed on special equipment (take-up), producing bobbins. The bobbins are then sorted and packed into cartons or wrapped in rows on pallets.

All the process areas are air conditioned.

Figure 9.10 shows a simplified flow diagram of the process.

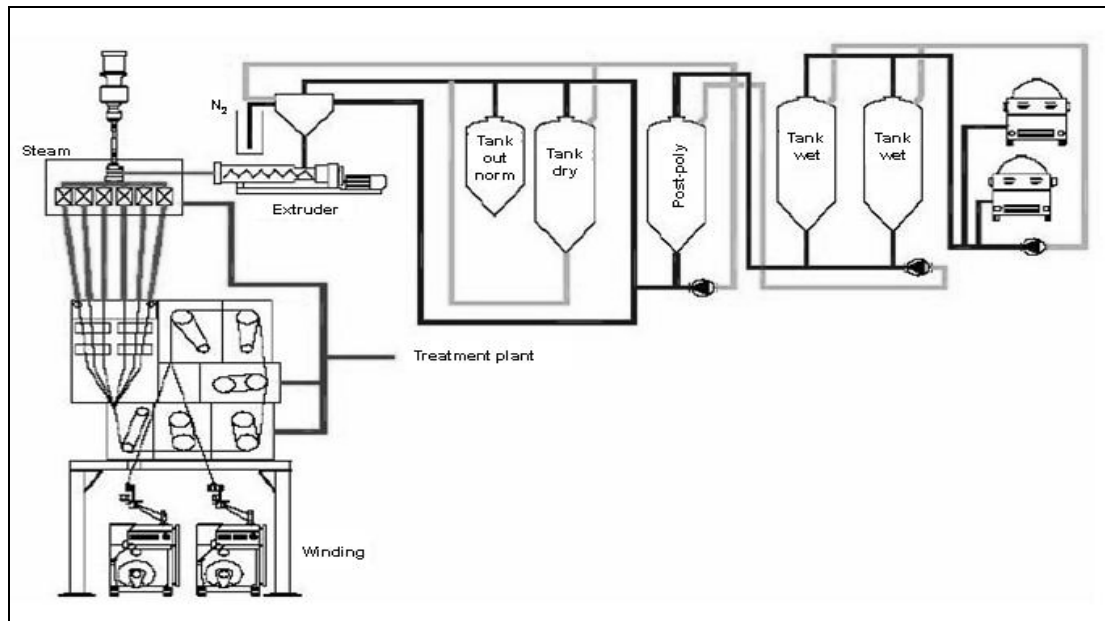

Figure 9.10: Flow chart of the spinning process for technical yarns

9.2.3.4 Processing of staple fibres

The melting and spinning phases can be practically described in the same way as the textile yarn.

The spin finish is carried out at the spin take-up wall, and then the filaments are passed over deflector rollers and combined into one tow. A haul-off unit conveys the tow to a sunflower unit that lays the tow into cans, then arranged under a creel.

The tows of a certain number of cans are combined and fed into a series of drawing stands, equipped with hot or cold godets. Between two drawing stands, the tow can be heated with steam.

Then the tow is mechanically crimped and heat-set. The fumes generated in the heat-setter are collected and sent to an adequate treatment plant.

Finally the tow is finished with oil and cut with a rotary cutting machine. The cut fibres fall into a collecting tunnel from where they are either mechanically or pneumatically conveyed to the baler.

Figure 9.11 shows a simplified flow diagram of the process.

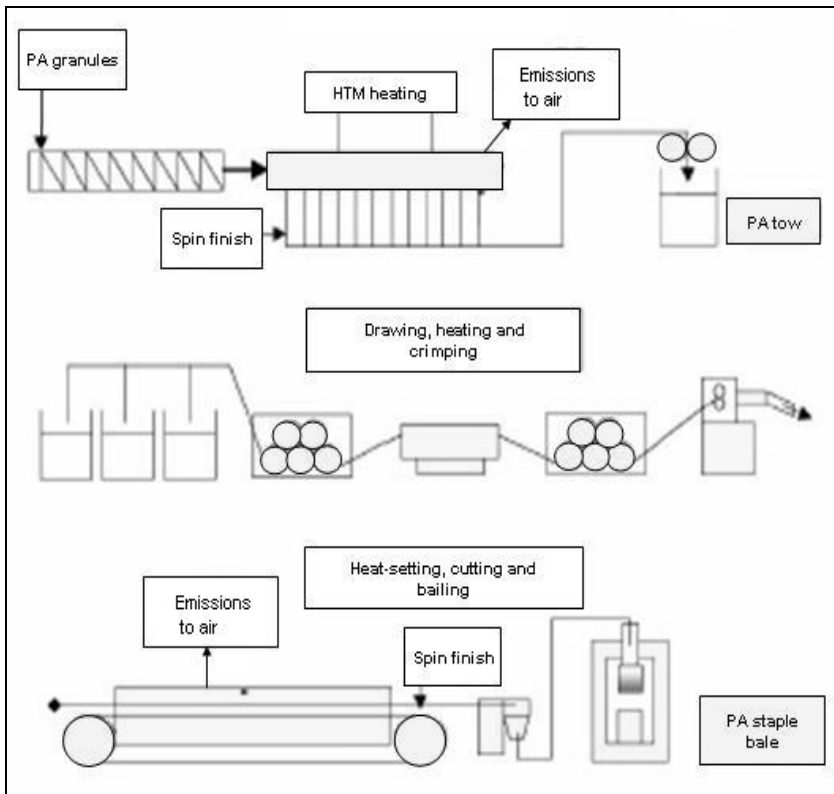

Figure 9.11: Flow diagram of the processing of staple fibres

9.2.3.5 Processing of BCF yarns

The initials BCF (bulked continuous filament) indicate a yarn obtained with a continuous process of spinning, drawing and texturing in only one step. The final product is characterised by a bulky appearance, from which the name derives.

The melting and spinning phases can be practically described in the same way as the textile yarn (Section 9.2.3.2).

Finally, the yarns are wound up at high speed on special equipment (take-up), producing bobbins. The bobbins are then sorted and packed into cartons or wrapped in rows on pallets.

All the process areas are air conditioned.

Figure 9.12 shows a simplified flow diagram of the process.

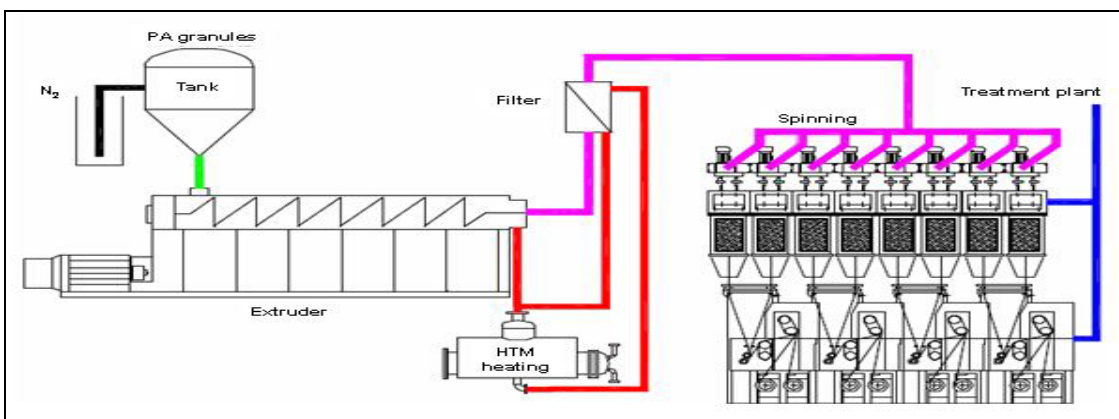

Figure 9.12: Flow chart of processing of BCF yarns

9.3 Current emission and consumption levels

[4, APME, 2004], [28, Italy, 2004]

9.3.1 Production of polyamides

Emissions and consumptions from the production processes are summarised in Table 9.3, Table 9.5, Table 9.6, Table 9.7 and Table 9.8.

9.3.2 Spinning of polyamides

Emissions and consumptions from the spinning processes are summarised in Table 9.4, Table 9.9 and Table 9.10.

9.3.3 Potential sources of pollution in polyamide processes

Usually, batch processes have a greater impact on the environment, due to the starting up and closing down procedures of each single production.

9.3.3.1 Energy

The processes require both electrical and thermal energy, steam and heat transfer media (HTM) as well as cold water for the heating, ventilation and air conditioning system (HVAC) in the case of spinning processes. The installation of a cogeneration plant can optimise the use of energy, but it affects the amount of gaseous emissions from the production site.

9.3.3.2 Water

Usually, large amounts of water are required for cooling purposes. Preferably, fresh water from rivers or wells is used, which is then discharged with a higher temperature; if not enough water is available, a closed circuit system (cooling towers) must be installed, which leads to a higher consumption of energy. Closed cooling circuit systems are also often required to reduce the heat transfer to the receiving surface water.

9.3.3.3 Waste water

In PA6 manufacturing, the water used in polymerisation is mostly recycled. Only small amounts are discharged and have to be reintegrated with fresh demineralised water. Pollutants are mainly caprolactam (<0.1 % of the water content), diamine, dicarboxylic acid, sodium hydroxide and hydrochloric acid, the last two coming from the demineralising equipment. Traces of additives are possible in the case of speciality polymers. Waste water also comes from the gaseous emission abatement equipment. In the case of spinning processes, this is the main source of contaminated water. The pollutants are suitable for a biological waste water treatment, but this process has to be fully integrated with both bionitrification and bionitrification.

In PA66 manufacturing, the reaction water generated in the polymerisation process and the solution water of the monomer (about 1.2 t/t of nylon salt), both released as steam, may carry over some organic (mainly hexamethylenediamine and cyclopentanone) and inorganic (mainly ammonia) components. In the case of speciality polymers or copolymer 66/6 the pollutants may include volatile additives. The quantity of contaminants depends on the process parameters, but also on the technology used and on the layout of the plant. Additionally, small quantities of waste water can be generated where water scrubbing of the emitted gas is present. Periodical cleaning operations of the equipment may generate additional discontinuous waste water [46, TWGComments, 2005].

In both cases, the pollutants are suitable for a biological waste water treatment, but this process has to be fully integrated with both bionitrification and bidenitrification.

Waste water can also be recycled after biological treatment and membrane filtration [www.dupont.zenit.de].

Table 9.2 shows waste water data from the manufacture of polyamides.

	Waste water m ³ /t PA
PA 66	1.5 – 3
PA 6	1 – 3

Table 9.2: Waste water data from the manufacture of polyamide
[36, Retzlaff, 1993]

9.3.3.4 Gaseous emissions

For PA6, the main emission occurs in the cutting section: the fumes contain caprolactam, which can be easily removed in washing towers. Other emissions to the air can be avoided by means of hydraulic seals. In spinning processes, fumes are generated at the outlet of the spinneret and during intermingling/drawing/texturing/thermal-fixing: the first emission contains mainly caprolactam, easily removable in washing towers, the second contains the mist of finishing oil, removable with mechanical filters, electrostatic precipitators or water scrubbers.

The emissions of HTM have to be filtered, normally with activated carbon. The combustion fumes emitted by the HTM and steam boilers also have to be considered.

For PA66, the main emission sources to air are [46, TWGComments, 2005]:

- all breathing to the air in the circuit of the process condensate
- nitrogen used in the drying of the polyamide and for inertisation of the equipment
- combustion fumes generated from the heaters of the diathermic oil circuit
- air used for pre-drying of the polyamide 66 after cutting and for the pneumatic conveying of the granules to the storage silos.

9.3.3.5 Waste

Scraps of polyamide 6 are usually recycled for compounding; only a small quantity (dirty) goes to landfill. Hazardous waste is mainly produced during scheduled maintenance (i.e. solvent used for cleaning the reactor before start up after long inactivity). Other wastes are used resins from the demineralising equipment and sludge from the biological waste water treatment plant. Packing materials are used in small quantities, as both the main raw material (caprolactam) and most of the polymer chips are transported by means of tank trucks.

9.3.3.6 Noise

The main sources of noise in the polymerisation process are the cutting of the polyamide chips, the nitrogen fans and the pneumatic conveying of polymer chips as well as the cooling tower and the power station. In the spinning processes, the HVAC equipment is the main cause of external noise, as the other sources (winding and extrusion machines) are usually installed in closed buildings.

		PA 6				PA 66			
		Continuous process		Batch process		Continuous process		Batch process	
		Min.	Max.	Min.	Max.	Min.	Max.	Min.	Max.
Consumption									
Total energy	MJ/tonne	6500	7000	9500	10000	5700	7500	5050	7250
Water	tonne/tonne	19	25	7	7	130	150	140	160
Caprolactam	tonne/tonne	1	1	1					
AH salt	tonne/tonne					1.162	1.163	1.165	1.167
Emissions									
Caprolactam to air	g/tonne	6	10	10	20				
VOC to air	g/tonne					10	30	15	40
HTM	g/tonne	30	35	0	0				
COD before WWT	g/tonne	4300	5700	5000	6000	4500	6000	5300	7300
Waste									
Polymer waste	kg/tonne	0	0	5	5	0	0.1	0	0.2
Hazardous waste	kg/tonne	0.2	0.5	0	0	0.2	0.5	0.2	0.5
Other waste	kg/tonne	3	3.5	15	20	3	3.5	15	20
Noise									
Noise at the plant	dB					60	65	60	65
Noise at the factory fence	dB		65	50	60	50	55	50	55

Table 9.3: Emissions and consumptions from polyamide production processes [28, Italy, 2004]

		Textile fibres				Industrial fibres			
		PA6		PA 66		PA 6 Staple		PA 6 BCF/technical	
		Min.	Max.	Min.	Max.	Min.	Max.	Min.	Max.
Consumption									
Total energy	MJ/tonne	8000	8500	20000	30000	12000	15000	9400	9700
Water	tonne/tonne	42	53	13	17	32	40	5	5
PA 6\PA 66	tonne/tonne	1.0	1.0	1.0	1.0	1.0	1.0	1.0	1.0
Spin finish	kg/tonne	13	15	9	10	17	19	10	11
Emissions									
Caprolactam to air	g/tonne	30	35	0	0	35	50	10	20
VOC to air	g/tonne	600	750	100	300	300	500	200	350
HTM	g/tonne	30	35	25	35	30	35	0	0
COD before WWT	g/tonne	2000	2600	2500	3700	5500	6800	5000	6000
Waste									
Polymer waste	kg/tonne	0	0	0	0	0	0	5	5
Hazardous waste	kg/tonne	6.0	7.0	0.0	0.5	5.0	6.5	0.0	0.0
Other waste	kg/tonne	26	32	15	20	6.5	9.5	15	20
Noise									
Noise at the factory fence	dB		65		65		65	50	60

Table 9.4: Emissions and consumptions from polyamide processing [28, Italy, 2004]

	Unit	Range	Comment
Consumption			
Total energy	MJ/t	6500 - 7000	
Water	m ³ /t	11.6 - 25	Mainly for cooling
Caprolactam	t/t	1 - 1.15	Low values due to direct recovery
Discharges to water			
COD	g/t	4300 - 9982	High values due to abatement of VOC
Caprolactam	g/t	6 - 10	Low values correspond with high COD values
Emissions to air			
HTM	g/t	30 - 35	Calculated from mass balance
Generation of waste			
Polymer waste	kg/t	0	Recycled in the process
Other waste	kg/t	3.0 - 3.5	
Hazardous waste	kg/t	0.2 - 0.55	From maintenance
Noise	dB	59.9 - 65	Outside the fence

Table 9.5: Emission and consumption data from the continuous PA6 production process [4, APME, 2004]

	Unit	Range	Comment
Consumption			
Total energy	MJ/t	4500 - 13500	Range due to specialised products and reactors
Water	m ³ /t	2.6 - 32.4	Mainly for cooling
Caprolactam	t/t	1 - 1.13	Low values due to direct recovery
Discharges to water			
COD	g/t	483 - 7600	High values due to abatement of VOC
Caprolactam	g/t	0.068 - 49.8	Low values correspond with high COD values
Emissions to air			
VOC	g/t	0.23 - 95.6	Low values correspond with high COD values
Dust and aerosols	g/t		Partly considered in VOC
HTM	g/t	0	Measured
Generation of waste			
Polymer waste	kg/t	5 - 6	To recycling
Other waste	kg/t	7 - 34.7	
Hazardous waste	kg/t	0 - 1.2	From maintenance
Noise	dB	50 - 70	Outside the fence

Table 9.6: Emission and consumption data from the batch PA6 production process [4, APME, 2004]

	Unit	Range	Comment
Consumption			
Total energy	MJ/t	5300 - 6600	
Water	m ³ /t	1.3 - 2.9	Mainly for cooling
Nylon AH salt	t/t	1.16	
Discharges to water			
COD	g/t	8000 - 11000	
Emissions to air			
VOC	g/t	200 - 412	
HTM	g/t		Included in VOC
Generation of waste			
Polymer waste	kg/t	0	
Other waste	kg/t	3.0	
Noise	dB	59.9 - 65	Outside the fence

Table 9.7: Emission and consumption data from the continuous PA66 production process [4, APME, 2004]

	Unit	Range	Comment
Consumption			
Total energy	MJ/t	3300 - 7700	Range due to specialised products and reactors
Water	m ³ /t	2.1 - 46	Mainly for cooling
Nylon AH salt	t/t	1.16 - 1.18	
Discharges to water			
COD	g/t	3045 - 14100	High values due to abatement of VOC
Emissions to air			
VOC	g/t	15 - 70	
Dust and aerosols	g/t	0.16 - 2	
HTM	g/t	0 - 2	
Generation of waste			
Polymer waste	kg/t	0 - 0.55	To landfill
Other waste	kg/t	1.8 - 7.3	
Hazardous waste	kg/t	0.03 - 1.2	From maintenance
Noise	dB	44 - 55	Outside the fence

Table 9.8: Emission and consumption data from the batch PA66 production process [4, APME, 2004]

	Unit	Range	Comment
Consumption			
Total energy	MJ/t	8000 - 40000	Due to special products and technologies
Water	m ³ /t	2.4 - 53	
Finish	kg/t	5 - 22.4	Due to special products and technologies
polymer	t/t	0.95 - 1.07	Depending on finishing, picking up and fibre technology
Discharges to water			
COD	g/t	500 - 6800	
Caprolactam	g/t	25 - 117	Low values correspond with high COD values
Emissions to air			
VOC	g/t	<1707	Depending on spin finish
Dust and aerosols	g/t	70 - 515	Overlapping with VOC
HTM	g/t	30 - 200	Overlapping with VOC
Generation of waste			
Polymer waste	kg/t	0 - 60	To recycling
Other waste	kg/t	4 - 32	
Hazardous waste	kg/t	0 - 10	
Noise	dB	50 - 70	Outside the fence

Table 9.9: Emission and consumption data from the textile yarn process [4, APME, 2004]

	Unit	Range	Comment
Consumption			
Total energy	MJ/t	3200 - 15000	Due to special products and technologies
Water	m ³ /t	0.15 - 40	Due to special products and technologies
Finish	kg/t	5 - 35	Due to special products and technologies
polymer	t/t	1 - 1.067	Depending on finishing, picking up and fibre technology
Discharges to water			
COD	g/t	<7126	
Caprolactam	g/t	10 - 200	Low values correspond with high COD values
Emissions to air			
VOC	g/t	<3100	Depending on spin finish
Dust and aerosols	g/t	24 - 3950	Overlapping with VOC
HTM	g/t	0 - 100	Overlapping with VOC
Generation of waste			
Polymer waste	kg/t	0 - 67.3	To recycling
Other waste	kg/t	6 - 43	
Hazardous waste	kg/t	0 - 10	
Noise	dB	40 - 72	Outside the fence

Table 9.10: Emission and consumption data from the BCF PA yarns and staple fibres processes [4, APME, 2004]

10 POLYETHYLENE TEREPHTHALATE FIBRES

[20, CIRFS, 2003]

10.1 General information

Polyester fibres were developed and patented during the 1940s and were marketed from the 1950s onwards. By 2000, they accounted for the largest share of manmade fibres with a global quantity in excess of 16 million tonnes per year. Based on similar polymer technologies, another seven million tonnes are produced for packaging (bottles) and film end uses.

The average growth for fibre end use over the past 10 years was 6.5 %, which mostly took place in areas outside of Europe, the US and Japan. In Europe, the growth rate for both years 2001 and 2002 was about 1.0 % with a total production of 3234 kt in 2002. Table 10.1 shows the European production volumes for 2000 – 2002.

Year	2000	2001	2002
Production volume	3100 kt	3182 kt	3234 kt

Table 10.1: European PET production 2000 - 2002

Polyester fibres, as described in this chapter, are based on terephthalic acid with different glycols like butane diol, propylene glycol, with the most common being ethylene glycol (EG) as shown in Figure 10.1. Polyesters based on other acids like naphthalene dicarboxylic acid (PEN fibres) or lactic acid (PLA fibres) are different products.

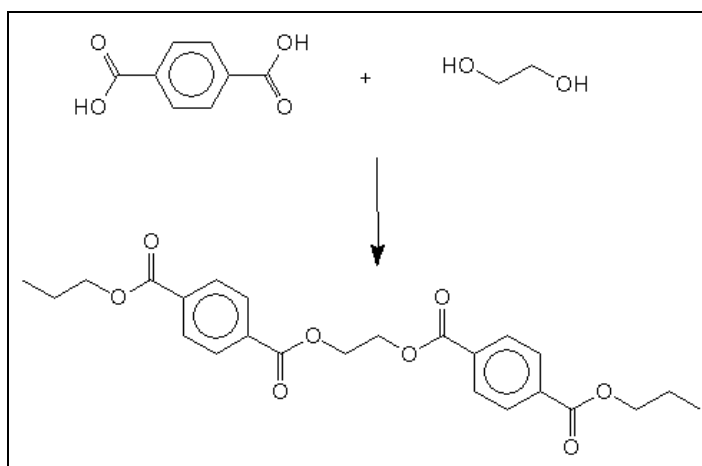

Figure 10.1: Basic reaction of ethylene glycol with terephthalic acid

The global development of polyester fibres during the last 25 years is characterised by the following tendencies:

- a shift of growth from the developed countries (Europe, US, Japan) towards emerging economic areas in Asia and South America, with a common trend of globally falling margins
- a transfer of technology by engineering companies, often linked with fibre producers, in that same direction
- a replacement of a growth scenario in the developed countries by a specialisation scenario resulting in many new fibre specifications and end uses like industrial applications and non-woven applications
- a continued growth scenario in the above-mentioned new economies with a focus on large-scale production.

As a result, the European polyester fibre situation is highly specialised and produces many specialities on a fairly low scale volume base. Investments, in terms of technology, rationalisation, safety and environment are also focused on existing equipment. It has been more than a decade (2003) since a new green field, polyester fibres plant was erected in Europe.

Within the technologies of polyethylene terephthalate production, this chapter focuses on non-polymer modifications. That means, that speciality products based on bicomponent systems (combinations with different polymers), and polymer additives (for anti-pilling, antistatic, flame-retardant, antibacterial and heat resistance properties) are not specifically described.

10.2 Applied processes and techniques in the production of PET fibres

In this section, the following production techniques are described:

Raw polymer production techniques:

- continuous polycondensation based on dimethyl terephthalic acid (DMT)
- continuous polycondensation based on terephthalic acid (TPA)
- batch polycondensation based on DMT.

Techniques to increase the molecular mass of the raw polymer:

- continuous solid state post condensation
- batch solid state post condensation.

On-site transformation of the raw polymer:

- production of spinning chips
- production of staple fibres
- production of filament yarns.

10.2.1 Continuous polycondensation based on dimethyl terephthalic acid (DMT)

The initial reaction of the DMT-based process exchanges a methyl ester group of the DMT for an ethylene glycol group thereby releasing methanol. This ester interchange reaction begins at temperatures of about 160 °C. Typically, an EG/DMT mole ratio of 3.8/1 is used in this process. The reaction is enabled by a catalyst containing manganese, which ends up as part of the product [27, TWGComments, 2004].

Chemically, slightly more than two moles of EG are required for each mole of DMT. Unless both DMT methyl esters undergo the ester interchange, high molecular weight PET will not be formed. Unreacted methyl ester groups act as polymerisation chain terminators and limit chain growth. The EG ester of terephthalic acid, produced by the ester interchange reaction, is bishydroxyethylene terephthalate (BHET).

When an adequate yield of this intermediate has been produced, excess EG is removed by distillation at atmospheric pressure and at a temperature of between 235 and 250 °C. A phosphorus compound, e.g. polyphosphoric acid is added at this stage as a processing stabiliser. Prior to further polymerisation, the manganese catalyst has to be deactivated. Otherwise, the manganese will not only continue to catalyse the polymerisation of PET, but also cause the formation of undesirable side reactions which will increase the yellowness of the final PET and result in poor thermal stability.

The polymer is produced by polycondensation (PC) reactions in which excess EG is removed. The temperature is raised to 285 – 300 °C at a vacuum of 1 – 2 torr of absolute pressure. Typically, antimony in the form of its trioxide, triglycolate, triacetate or other compounds (also without antimony) is added to catalyse the polycondensation reaction. Excess EG is removed by vacuum resulting in an increase of the molecular weight.

The molecular weight of the polymer is usually measured as solution viscosity (SV) or intrinsic viscosity (IV). The IV of a typical amorphous polymer is 0.64 (equivalent to an SV of 835). The melted polymer is extruded, cooled, and cut into chips, which are transported to silos before further processing.

Figure 10.2 shows a simplified flow diagram of the process.

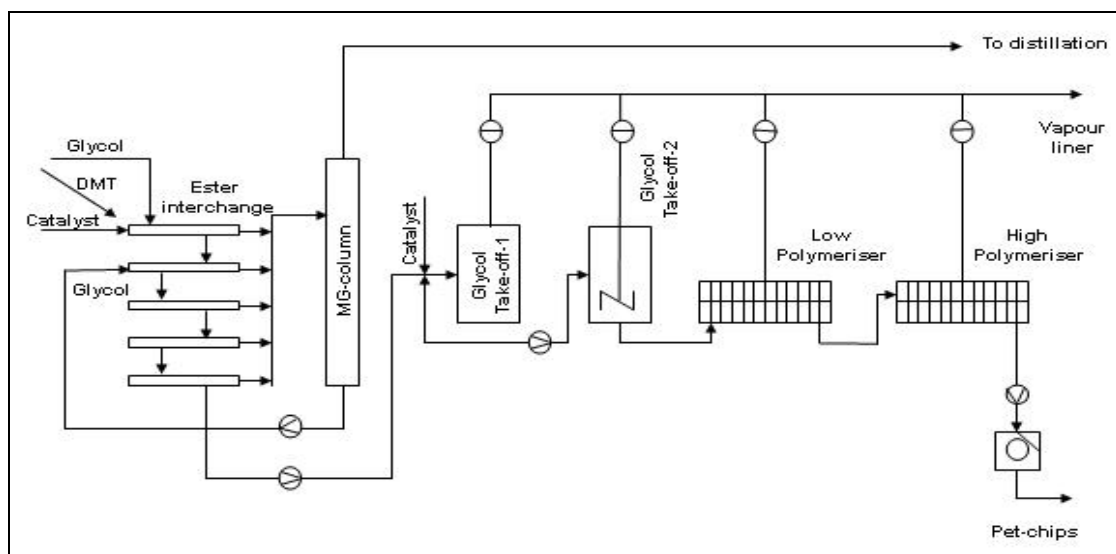

Figure 10.2: Flow chart of the PET DMT process

10.2.2 Continuous polycondensation based on terephthalic acid (TPA)

Polyester fibres are produced from a specific operation that combines polymerisation, spinning and drawing. This process is continuous and uses (as raw materials) terephthalic acid and ethylene glycol to produce polyester yarns. This process yields a high viscosity polymer. This is accomplished by the following process steps:

- mixing of TPA and EG
- pre-polycondensation
- polycondensation
- extrusion, spinning and drawing operations to produce polyester yarns.

Also the production of PET for food packaging is based on the same process (with the addition of di-ethyleneglycol and isophthalic acid as raw materials).

Figure 10.3 shows a simplified flow diagram of the process.

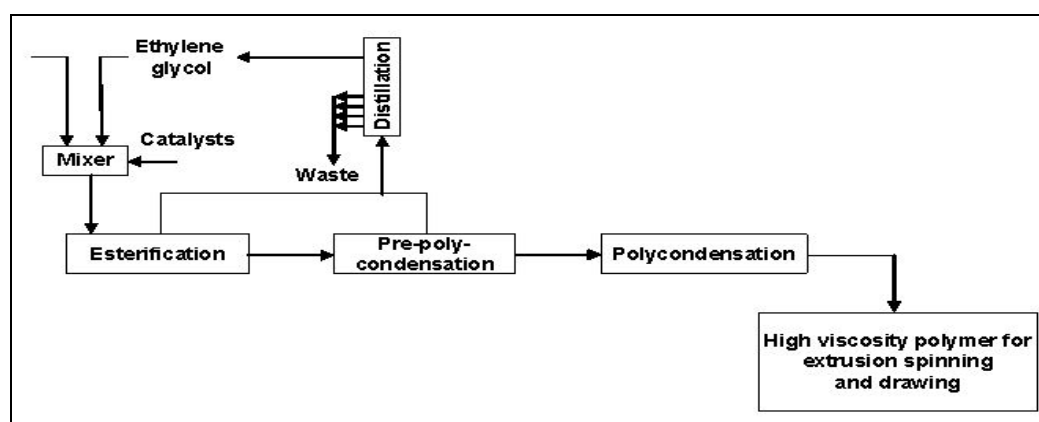

Figure 10.3: Flow chart of the PET TPA process

10.2.3 Continuous solid state post condensation

10.2.3.1 Process description

The amorphous, low viscosity PET chips are first crystallised to a crystallisation degree of approximately 40 % to reduce their tendency to stick. Besides crystallisation, the content of water and acetaldehyde is reduced as well. There are several configurations possible for this crystallisation phase:

- pulsed bed
- fluidised bed
- countercurrent flow stirred tube reactor.

For all configurations, temperatures range from 120 – 170 °C. The gas phase (nitrogen or air) is used to heat up the product and to remove the water, acetaldehyde and polymer dust.

In the next stage, the product is heated up to the desired temperature for solid state polymerisation (e.g. 215 – 240 °C), commonly with a large countercurrent nitrogen flow (fluidised bed or not) and the polymerisation is initiated.

Then the chips move slowly downwards through the reaction zone towards the outlet of the reactor. A countercurrent flow of nitrogen removes the reaction products, water and glycol from the chips; maintaining a driving force for the reaction. The reactor is intended to work as a plug flow reactor and the walls are actively insulated (heating oil) to get a narrow distribution of residence time for the chips and a homogeneous temperature distribution in the cross direction of the reactor. At the reactor outlet, the throughput of the polyester chips is controlled. The temperature is regulated to control the viscosity (degree of polymerisation) of the end-product at a given throughput. For the PET for food packaging production, an actively insulated wall is not necessary as the homogeneous temperature is maintained through the crystallisation process [46, TWGComments, 2005].

The nitrogen used in the reactor and the heating zone is recycled. Before entering into the low end of the reactor, the nitrogen is passed through a gas cleaning system. In this gas cleaning, polymer dust, oligomers, VOC, oxygen and water are removed from the nitrogen because they would otherwise destroy the reactor's performance and/or the product performance. Gas cleaning can consist of a series of steps:

- (electrostatic) filtration
- catalytic oxidation
- catalytic hydrogenation
- drying.

When the chips leave the solid state polymerisation (SSP) reactor they are cooled and stored in a silo. The product is usually stored under nitrogen or dried air, as the PET chips are very hygroscopic and the presence of small traces of water would decrease the degree of polymerisation, especially during subsequent processing at elevated temperatures.

Figure 10.4 shows a simplified flow diagram of the process.

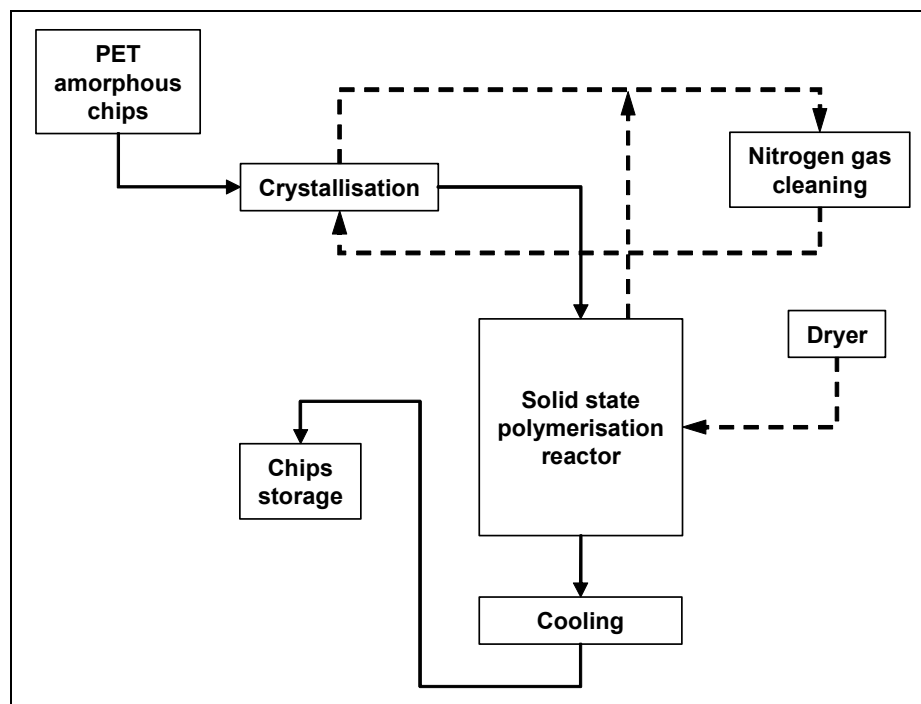

Figure 10.4: Flow diagram of continuous solid state polymerisation

10.2.3.2 Technical parameters

Product	High viscosity PET chips
Reactor type	Vertical tube reactor
Reactor volume	Variable
Reaction temperature	215 - 240 °C
Reaction pressure	Atmospheric – slight overpressure
Reactor capacity	20 - 400 t/day

Table 10.2: Technical parameters of continuous solid state post condensation

10.2.4 Batch solid state post condensation

10.2.4.1 Process description

The reactor is fed with amorphous low viscosity PET chips. The reactor starts rotating and is heated to 120 – 170 °C and maintained at this temperature long enough to allow the chips to become semi-crystalline and dry. When the chips are semi crystalline, their tendency to stick together at temperatures above the glass transition temperature (TG) of PET is much reduced. As an alternative, the chips can be crystallised prior to feeding it into the rotating reactor.

When the degree of crystallisation reaches the set value, the temperature is increased gradually and the polymerisation reaction starts. The reactor is heated with circulating heating oil. For the heating of the oil, several configurations are used, e.g. a central heating system (running on gas or fuel oil) or per reactor (steam and/or electrical power).

The temperature of the product and the reactor wall has to be kept about 20 °C below the melting temperature of the polyester to prevent sticking. The reaction products, glycol and water, are continuously removed from the reactor to keep the polycondensation going. Therefore, the reactor is equipped with a vacuum system, which reduces the pressure inside the reactor to <5 mbar. The vacuum systems used are either based on a series of steam ejectors (option: in combination with a watering pump) or dry vacuum pumps.

In addition to the vacuum, in some cases nitrogen is injected into the reactor to further reduce partial pressures of the reaction products. Some acetaldehyde will be liberated from the chips during the crystallisation and solid state polymerisation phase.

When the degree of polymerisation has reached the set value, the reactor is cooled down and pressurised with nitrogen. The product is then discharged, e.g. into a silo.

The product is normally stored under nitrogen or dried air as the PET chips are very hygroscopic and the presence of small traces of water would already decrease the degree of polymerisation, especially during subsequent processing at elevated temperatures (hydrolysis reaction).

Figure 10.5 shows a simplified flow diagram of the process.

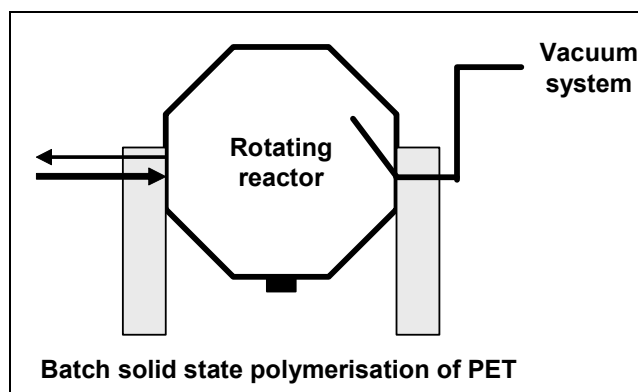

Figure 10.5: Schematic view of the batch solid state process

10.2.4.2 Technical parameters

Product	High viscosity PET chips
Reactor type	Vertical reactor, tumble dryer
Reactor volume	5 - 20 m ³
Reaction temperature	215 - 240 °C
Reaction pressure	Ambient temperature - 250 °C
Reactor capacity	1 - 4 kt/yr

Table 10.3: Technical parameters of batch solid state post condensation

10.2.5 Batch polycondensation based on DMT

The synthesis of PET in a DMT-BPU (batch polycondensation unit) process is a two step reaction:

- ester interchange process
- polycondensation process.

To start the ester interchange process, DMT (dimethyl terephthalate) and an excess of EG (ethylene glycol) from the storage tanks are fed together into the ester interchange vessel. After adding the EI catalyst and increasing the temperature to between 150 and 200 °C, the reaction starts by replacing the methyl groups by EG. The formed methanol is condensed and stored in the methanol storage tanks. Methanol is normally recycled (pipeline/road/railway) to the DMT-producer for cleaning. Excess EG is evaporated at temperatures of 200 – 260 °C, condensed, regenerated separately to the main process in a distillation column and stored in storage tanks.

After reaching the end temperature of the ester interchange process which depends on the type of PET (technical PET, textile PET), the catalyst for the polycondensation process is added.

The product of the ester interchange is transferred to the autoclave for further processing. In the autoclave, polycondensation takes place by increasing the temperature (typical temperature: 260 – 310 °C) and evacuation (<5 mbar, by using steam injectors and/or watering pumps and/or roots blowers). Displaced MEG is evaporated, condensed, regenerated separately to the main process in a distillation column and stored in storage tanks for further processing.

The polycondensation process is finished when the desired intrinsic viscosity, which depends on the type of product, is reached. The PET is pressed out by N₂, cooled with water (normal/deionised), cut, dried and sieved. The cut PET chips are then stored in storage silos for further processing.

Figure 10.6 shows a simplified flow diagram of the process.

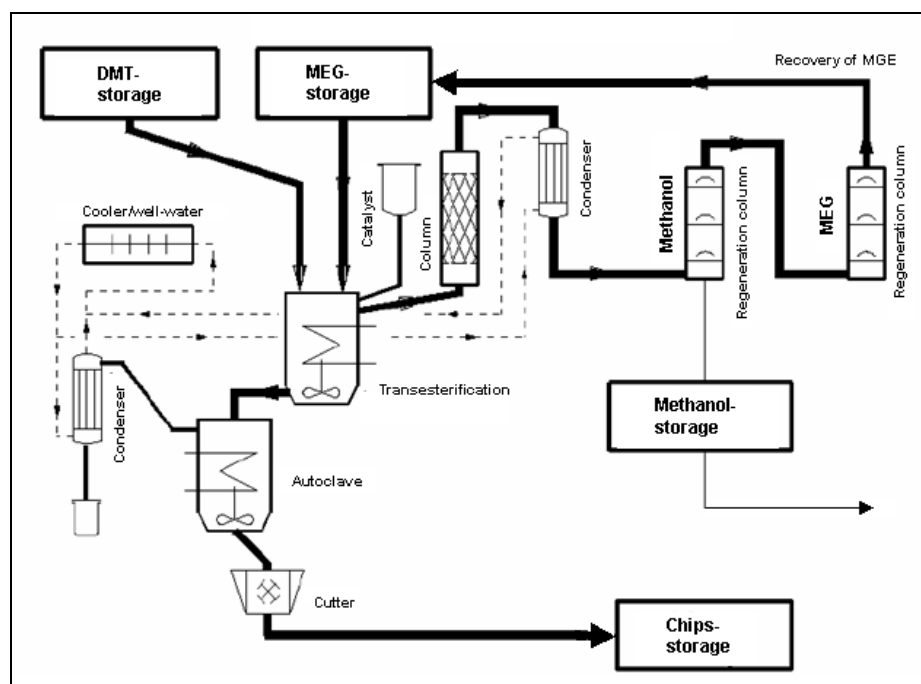

Figure 10.6: Flow diagram of the DMT-BPU process

10.2.6 Production of spinning chips

Polyester raw materials are stored in silos. The material is weighed and pneumatically conveyed to the in-feed hoppers of polyester dryers. Prior to drying, the polymer is crystallised at temperatures of between 150 and 200 °C in an agitated bed, to prevent agglomeration.

In the dryers, the product is heated to 150 – 200 °C by a stream of hot, dehumidified air.

Figure 10.7 shows a simplified flow diagram of the process.

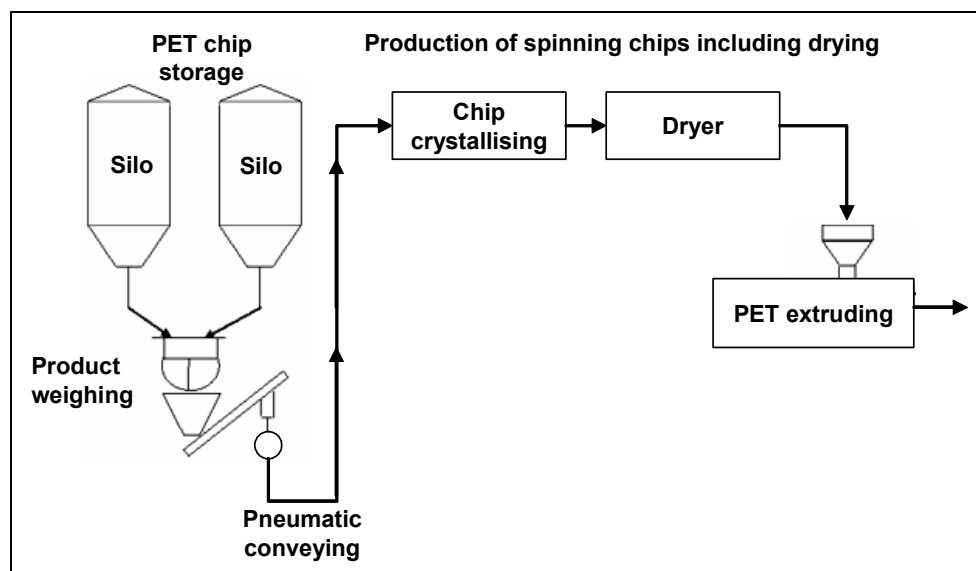

Figure 10.7: Flow diagram of the production of spinning chips

10.2.7 Production of staple fibres

The dried polyester polymer is transported to extruders where it is melted, and pumped to spinning packs held in a spin manifold. The spin packs contain spinnerets with a large number of fine holes through which the melted polymer flows to form filaments. Any contaminants in the polymer are removed by filtration prior to the spinneret. Different spinneret designs enable a wide range of fibre cross-sections to be produced including solid round, hollow and trilobal.

The hot filaments are cooled by blowing air through the filament bundle and are combined together into a tow band, which is deposited into a can. The fibre thickness is determined by the wind-up speed of the ‘denier setter’. Spin draw finish is applied as an aid to subsequent processing.

The spun tows are combined at the creel and drawn to optimise the tensile properties of the fibres. The tow is then crimped to give it the necessary bulk characteristics for different end uses. The crimped tow is dried and a final finish is applied to suit customer requirements. The tow is cut to the required fibre length, up to 150 mm, before being baled ready for dispatch.

Figure 10.8 and Figure 10.9 show simplified flow diagrams of the processes.

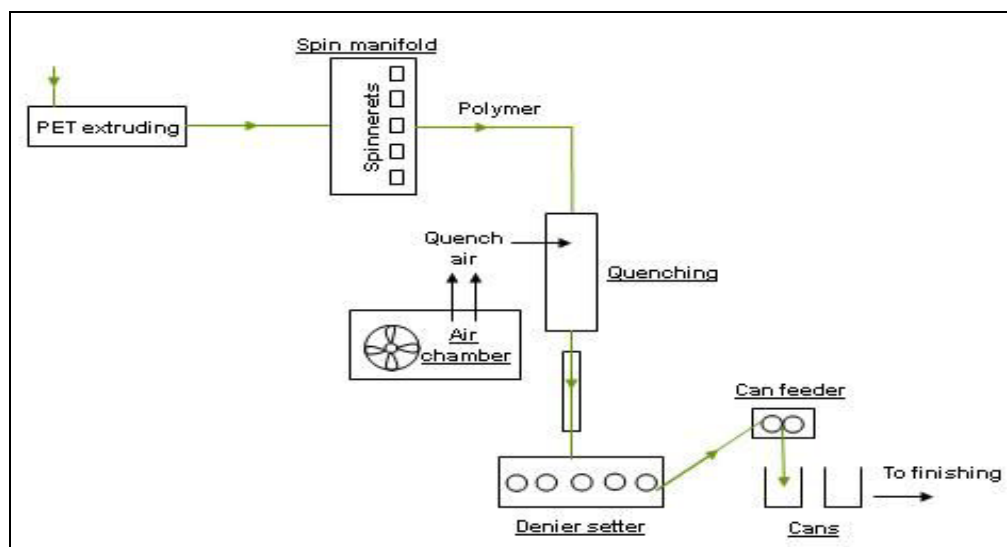

Figure 10.8: Flow diagram of the spinning of staple fibres

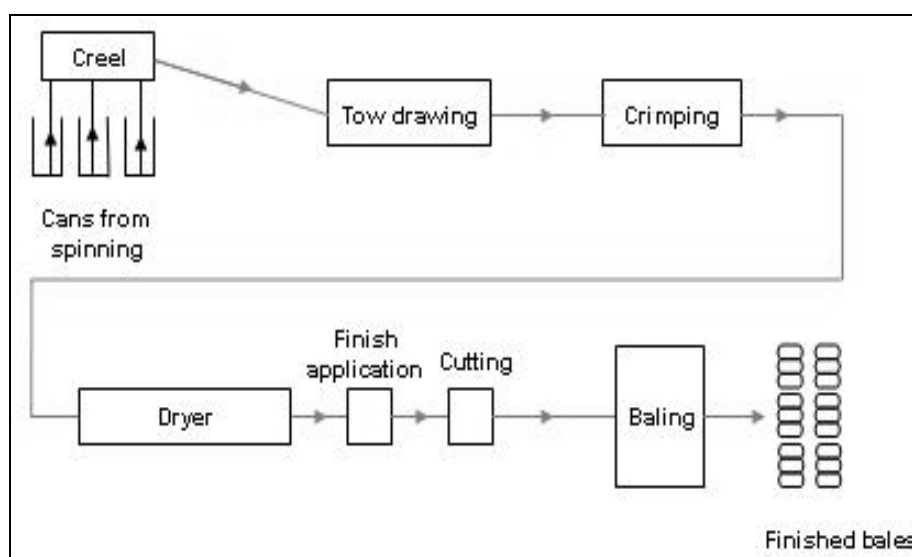

Figure 10.9: Flow diagram of the finishing of staple fibres

10.2.8 Production of filament yarns

Filament yarns are produced from PET chips. They are blended to ensure uniformity, prior to being pre-crystallised, and dried ready for melting. In the extruder, the polymer chips are melted, and then fed into a special manifold where the melt is distributed.

From there, the melted polymer is passed through spinnerets to produce thread lines. The thread lines are drawn, dressed with processing aids, and intermingled to give the yarn its excellent mechanical properties. They are then wound up onto packages called 'cheeses'.

Computer monitoring and control systems govern the process and quality at all stages of production and are linked to the robotic systems for yarn handling, packaging and storage.

The test station is the final stage in a process that ensures that the quality is controlled before packaging and distribution to the customer.

Figure 10.10 shows a simplified flow diagram of the process.

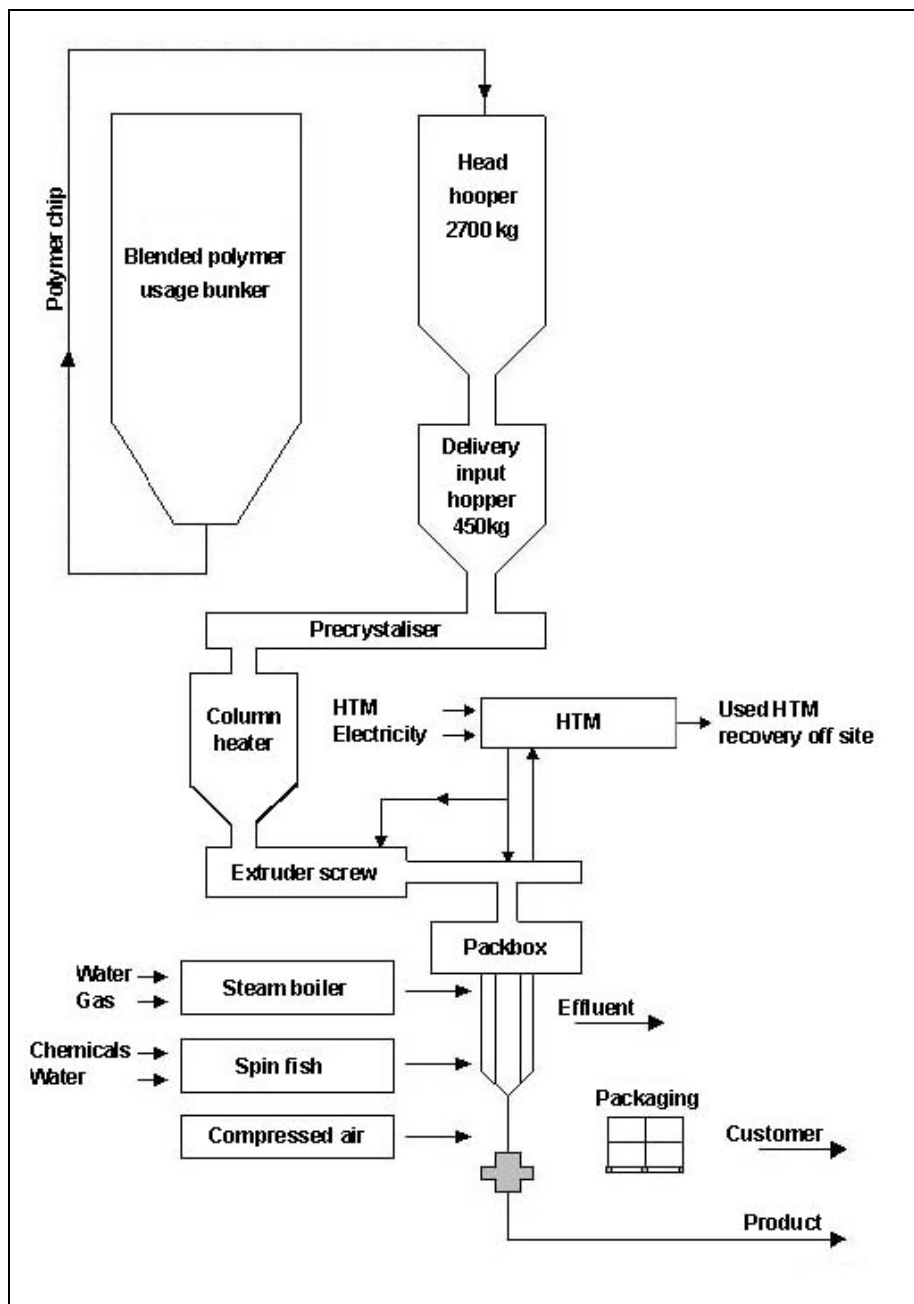

Figure 10.10: Flow chart of the production of filament yarns

10.3 Current emission and consumption levels

All emission and consumption data show the ranges of current levels.

10.3.1 Continuous polycondensation based on DMT, TPA and batch DMT-BPU processes

	DMT process	TPA process	DMT-BPU process
Consumption data			
Total energy (MJ/t)	2513 - 7410	2087 - 4500 (18500 ¹)	5100 - 11942
Water (m ³ /t)	0.1 - 2.15	0.4 - 10	7.5 - 122
DMT/TPA (t/t)	1.02	0.825 - 0.87	1.01 - 1.04
EG (t/t)	0.35 - 0.38	0.32 - 0.355	0.338 - 0.380
Catalyst (g/t)	589 - 1150	270 - 615	332 - 1323
P-stabiliser (g/t)	70 - 140	0 - 100	40 - 150
Emissions to air			
Methanol (g/t)	up to 73		50.7 - 300
Acetaldehyde (g/t)	up to 60	up to 60	28.5 - 1750
EG (g/t)	up to 10	up to 10	8.8 - 73
HTM (g/t)	50 - 90		80 - 110
VOC (g/t)	70 - 800 70 - 120 using thermal oxidation	up to 1200 5 using catalytic oxidation (only point sources)	32.5 - 2160
Generation of waste			
Polymer waste (g/t)	400 - 5556	140 - 18000	up to 6000
Hazardous waste (g/t)	up to 0.45	up to 0.45	up to 800
Other waste (g/t)	10700 - 16000	2000 - 5000	12400 - 25000
Waste water			
COD (g/t)	8000 - 16000	2000 - 16000	3000 - 5210
Noise at the fence (dB)	up to 66	up to 68	up to 66
¹ high viscosity PET for food packaging			

Table 10.4: Emission and consumption data of PET producing processes

- the energy consumption depends on the plant's capacity, the reactor design and the concentration of the catalyst. Higher consumptions of catalysts reduces the consumption of energy
- high values for methanol, acetaldehyde and VOC are from plants without abatement systems
- VOC emissions depend on the viscosity of the end-product
- the values for COD always refer to waste water prior to entering a waste water treatment plant.

Germany has reported a site that recycles most of its water after biological treatment and membrane filtration [27, TWGComments, 2004].

10.3.2 Post condensation processes

	Continuous post condensation	Batch post condensation
Consumption data		
Total energy (MJ/t)	903 - 949	2130 - 2379
Water external (m ³ /t)	0.2 - 15	0.9 - 1
Emissions to air		
Acetaldehyde (g/t)		up to 64
HTM (g/t)		up to 56
VOC (g/t)		up to 120
Generation of waste		
Polymer waste (g/t)	up to 667	0 - 1430
Hazardous waste (g/t)	0	up to 120
Other waste (g/t)	0	0
Waste water		
COD (g/t)	up to 663	up to 1300

Table 10.5: Emission and consumption data of post condensation processes

- VOC is the sum of acetaldehyde and HTM
- the values for COD always refer to waste water prior to entering a waste water treatment plant.

10.3.3 PET processing

	Spinning chips	Staple fibres	Filament yarns
Consumption data			
Total energy (MJ/t)	154 - 843	4400 - 8600	up to 27400
Water external (m ³ /t)	0.1 - 8.5	1.14 - 15	0.5 - 35.2
Finish (kt/t)		3.0 - 18	up to 18
EG (t/t)			
Catalyst (g/t)			
P-stabiliser (g/t)			
Emissions to air			
Methanol (g/t)	up to 50	up to 3	
Acetaldehyde (g/t)	up to 30	up to 49	up to 75
EG (g/t)	up to 8		
HTM (g/t)		up to 7	up to 45.3
VOC (g/t)		up to 59	up to 10300
Generation of waste			
Polymer waste (g/t)	5.0 - 50	up to 7700	up to 100000
Hazardous waste (g/t)		up to 4795	
Other waste (g/t)	2.0 - 5.0	up to 15711	940 - 17074
Waste water			
COD (g/t)		up to 14841	up to 4157
Noise at fence (dB)		up to 66	up to 60

Table 10.6: Emission and consumption data of PET processing techniques

- VOC including acetaldehyde and HTM
- the values for COD always refer to waste water prior to entering a waste water treatment plant.

11 PRODUCTION OF VISCOSE FIBRES

11.1 General information

Viscose fibres are made from regenerated cellulose. The process of dissolving pulp (the very viscose solution of pulp gave the name to the fibre product) was an achievement of the industrial revolution of the 19th century. And this innovation triggered the discovery of full synthetic fibres during the 20th century.

Many other cellulose dissolving and regeneration processes like cuprammonium rayon, which was the first process made available for manmade fibres and was already developed in the 1850s, or cellulose derivatives (like acetate) were in competition with the viscose process, but viscose proved to be superior based on process and product performance. Its booming period ended after World War 2 with the introduction of the synthetic competitive products. In the last decade, the production has stabilised at approximately 2.7 million tonnes worldwide (Europe 600000 tonnes).

It is preferably supplied to market end-uses (textile products and nonwovens) where the hydrophilic (moisture absorbing) properties of the material, for instance in direct contact with the skin or with mucous membranes, are relevant. Currently (2005), about 85 % of the total viscose fibre production is produced as staple fibres and about 15 % as filaments.

It has to be mentioned that a substantial amount of regenerated cellulose in the form of films (cellophane) based on the viscose process are still applied in sausage encasings and other packaging foils.

In recent history in Europe, textile viscose filament end-uses are receiving increased competition (resulting in phasing out of capacity) by cheaper competitive yarns based on polyester and polyamide, whereas viscose staple fibre and viscose tyre cord keep a strong position.

11.2 Applied processes and techniques in the production of viscose fibres

11.2.1 Processes and products

When producing viscose fibres, the pulp – which is mainly cellulose from wood – is dissolved and subsequently precipitated under controlled conditions. The most important process worldwide is the so-called ‘viscose process’ where the alkaline pulp is treated with carbon disulphide (CS_2) and dissolved by adding sodium hydroxide solution. A viscous orange-brown solution called ‘viscose’ is formed which is ripened, degassed and then pressed through spinnerets into a highly acidic spinning bath. Here, the cellulose precipitates when CS_2 and the by-product H_2S is released. After this, the cellulose is stretched, washed and then undergoes further processing.

At this point, a distinction has to be made between staple fibres and filament yarn. Staple fibres are cut into short pieces after the spinning bath. These short fibres, which are each approximately 4 cm long, are spun into textile yarns or processed into ‘non-woven’ products later on. In contrast, filament yarns are spun into endless fibres which can be used immediately. Viscose products for textile usage with certain improved product characteristics are called ‘modal fibres’.

However, since 1998 the Lyocell process has been used in Austria and the special feature of this process is the solution of the pulp which is in an organic solvent (NMMO = N-methylmorpholine-N-oxide), instead of CS_2/NaOH , which has the effect of eliminating the odorous and noxious emission of sulphurous gases. The properties of the products from this Lyocell process are different to the standard viscose fibre, and therefore this process should not be regarded as an environmentally compatible alternative to the viscose process.

Figure 11.1 gives a schematic view of both staple fibre and filament yarn production.

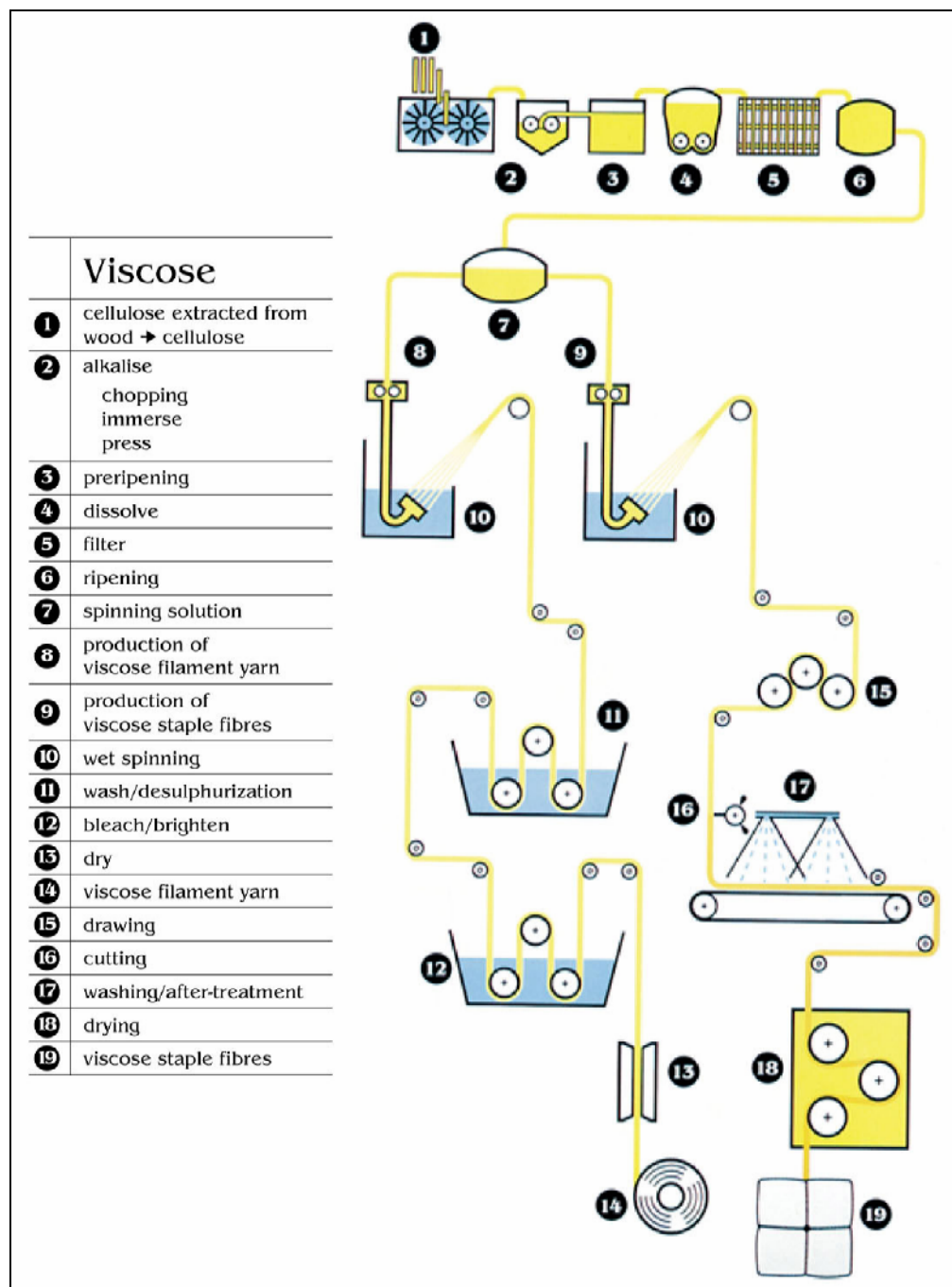

Figure 11.1: Flow diagram of viscose fibre production process [35, Chemiefaser]

11.2.2 Production of staple fibres

This process description comes from a reference plant which is a highly integrated into a compound of chemical plants. Totally free of chlorine (TFC) bleached pulp is manufactured via the sulphite process route and immediately fed to the viscose production plant. Furthermore, a paper production plant (which is not integrated in the production of pulp), a waste incineration plant as well as some minor chemical companies are situated at the same site.

Another part of the integration is that the biological waste water treatment plant treats all the waste waters from the site as well as the municipal waste water. The off-gas treatment for the production of viscose is combined with a sulphuric acid production unit. Gases containing sulphur can also be used as combustion air in various combustion plants with flue-gas desulphurisation. Additionally, the supply networks for steam and process water are highly sophisticated.

11.2.2.1 Alkalisiation and pre-ripening

Wood-based cellulose, as baled dry pulp or wet pulp (48 – 50 % dry substance) is mixed with temperature controlled sodium hydroxide liquor in several pulpers with special turbine agitators. Sodium cellulose is formed from the reaction of cellulose with sodium hydroxide whereby narrow distributions of decreased chain lengths are obtained. Impurities like the so-called ‘hemi-celluloses’ and their degradation products are dissolved in the liquor.

From the pulpers, the slurry is pumped into the presses, where the alkali cellulose (AC) is pressed to achieve about 50 % dry content. After defibration, the slurry is fed into the pre-ripening systems. Once there, the AC is pre-ripened to gain an average degree of polymerisation and an even viscosity. The pre-ripening process can be accelerated by adding a catalyst (e.g. cobalt chloride).

Part of the separated liquor is freed from remaining fibres and the concentration is raised by a dialysis process to gain pure liquor. The waste liquor from the dialysis process is disposed of by vaporisation and incineration. From this, ash is generated which can be used for neutralisation in waste water treatment.

The rest of the separated liquor is reprocessed by the addition of water, higher concentration liquor (about 50 % NaOH) and, if necessary, a catalyst for the acceleration of the molecular degradation of the cellulose in the pre-ripening step.

11.2.2.2 Dialysis process

The press liquor is recovered by filtration. Part of this is immediately used as a dissolving liquor. The other part is treated by dialysis for recovering NaOH.

Benefits of the recovery are lower concentrations of hemi-cellulose in the different liquors, and therefore in the AC and the viscose. The remaining press liquor, which is now called ‘waste liquor’, contains the better part of the organic load. It is evaporated and incinerated. The load of the waste water that has to be treated in a waste water plant is, therefore, significantly decreased.

11.2.2.3 Sulphidation process

The sulphidation process requires special safety measures because of the noxious substances used. As different concentrations of the substances occur, the danger of explosions especially has to be considered. Though the sulphidation machines may differ in construction design, usually the systems mix aggregates with internal vacuum. The AC is fed via a conveyor belt and a weighing bunker. The exothermic reaction of AC with carbon disulphide is controlled by cooling the AC and the sulphidation machine.

The sulphidation process consists of the following steps:

- evacuation
- feeding of CS₂
- mixing and reacting – the AC is converted to sodium cellulose xanthate via an exothermic reaction
- emptying – the xanthate is discharged from the sulphidation machines with diluted sodium hydroxide via homogenisers into the dissolver, and from Simplex machines directly into the dissolver.

An adequate degree of substitution is required for the xanthate solution in dilute NaOH, which is given as γ -value (number of mols CS₂/100 mols glucose units). The concentration of the sodium hydroxide determines the content of the viscose alkali. By varying the degree of substitution, the content of the alkali and the average length of the chain, different qualities of viscose can be achieved.

During the sulphidation process, the xanthate pulp and the viscose are both pumped through homogenisers. After being dissolved, the viscose is filtrated, and following this it is fed to the ripening units.

11.2.2.4 Ripening step

The spinning properties of the viscose can be adjusted by the ripening process. During the ripening step, the actual polymerisation takes place. This reaction depends on the temperature, time and composition of the viscose. It is monitored by the determination of the Hottenroth index ($^{\circ}$ H) or by the determination of the γ -value. The ripening step consists of a filtration, the actual ripening process, a de-aeration and another filtration.

The temperate and filtrated viscose is fed into the ripening vessels. The viscose is then led over a column under vacuum for de-aeration. Particles that contaminated the viscose during the preceding steps are separated by the second filtration. Usually, metal mats are used as filter material.

Condensates emerging from vacuum generation are collected and treated in a central waste water plant.

11.2.2.5 Spinning

A piston stroke dosing pump enables the addition of dyes, delustering agents (TiO₂) and/or modifiers. The spinnerets are made of metal with a defined number of bore holes. The number, the length and the diameter set the desired yarn count and capacity. The viscose is pressed through the spinnerets into the spinning bath that contains sulphuric acid which decomposes the xanthate and zinc sulphate. Besides emissions of CS₂, H₂S is also formed because of side reactions. Both are contained in the waste gas which is sucked off to the recovery unit. For the prevention of emissions, the spinning frames are enclosed by sliding windows.

The cellulose fibre is further crystallised in a hot water bath and collected as cable. While being drawn off to the cutting tower, it is stretched. The cable is sucked into the cable injector with cutting water (acidic water) and cut to the desired length with rotating, self-sharpening cutters. The cut fibre staples are then transferred with acidic water for an after-treatment.

11.2.2.6 After-treatment

This stage of the process consists of treatment with acidic water, desulphurisation, bleaching and a finishing treatment. The output of the spinning streets is usually combined for these first three steps, but only during the finishing treatment is it separated for the production of different quality fibres.

Between the individual steps, the flock fibres are washed and pressed for prevention of contamination by chemical carryover.

The four after-treatment processes are:

- acidic water treatment – carbon disulphide and hydrogen sulphide are removed by degassing, therefore this unit is attached to the suction of the recovery unit
- desulphurisation – the fibres are treated with an alkaline sodium sulphide solution to eliminate residual sulphur or sulphur compounds
- bleaching – if necessary, the flock fibres are bleached with a diluted sodium hypochlorite solution in a two-step process
- finishing – for optimal properties of the flock fibres for further processing, most are treated with adhesives or slip agents. These agents are usually fatty acids or their derivatives and they are applied in sprinkling vats. Without a further washing step, the flock fibres are then pressed and fed to the drying unit.

11.2.2.7 Drying and packing

The fibre fleece is opened by wet openers where the fleece is torn apart with a spiked roller and formed again. Drying is carried out in serial drying drums with a counter flow of hot air. This air is not treated any further. Between the dryers, the fibre is levelled more with another opener. After drying, the fibre is humidified to achieve the usual humidity of 11 %. Some types of fibre require further opening after the drying stage. The fibre is automatically pressed, baled, checked for weight and wet spots and then transported to the storage area.

11.2.3 Production of filament yarns

Until the spinning step, the process is very similar to the production of staple fibres (see Figure 11.1).

Long fibred pulp is used as the raw material. For the first step, it is treated with a diluted sodium hydroxide solution (approximately 15 %). Afterwards, the liquid is removed by pressing and then it is recycled back into the process together with fresh NaOH. Next, the pulp sheets are defibrated, pre-ripened and put into CS₂ for chemical conversion to xanthate. After the addition of aqueous NaOH, the viscose emerges which is ripened and degassed in vacuum prior to spinning.

Depending on the quality of the fibres, the spinnerets have different numbers of holes ranging from 30 to more than 2000. The spinning bath is sulphur acidic and contains high concentrations of sodium sulphate (Na₂SO₄) and zinc sulphate (ZnSO₄).

Three different spinning methods are used:

- pot spinning – the viscose is pressed directly into the spinning bath. This is possible for threads from the size of 67 to 1330 dtex*
- continuous spinning – the viscose is pressed through the spinneret into a spinning tube where the flowing spinning bath picks up the coagulating fibre. This is again possible for threads from the size of 67 to 1330 dtex
- bobbin spinning – this process is similar to continuous spinning, but the fibre is fully coagulated. In order to achieve this, it is let into a second spinning bath where the coagulation is finished. This technique is possible for threads from the size of 1220 to 2440 dtex.

* Note: 1 dtex = 1 g/10000 m of fibre

After spinning, the fibres are washed, finished, dried and spooled.

Currently, there are installations with integrated as well as batch washing.

11.2.4 Lyocell fibres

The core part of the Lyocell process is the direct dissolution of cellulose through NMMO (N-methyl-morpholine-n-oxide). The solvent, which is 100 % biodegradable, is able to dissolve cellulose physically without any chemical pretreatment.

Therefore, the chopped pulp is mixed with NMMO. Water is removed from the so-called 'premix' to form a solution, which is then filtrated and spun through spinnerets into an aqueous NMMO solution to make the filaments.

The wet filaments are cut and the staples run through several after-treatment sections. After washing out residual NMMO, spin finish is applied and the fibre is dried and packed.

Through a multistage cleaning process, more than 99.6 % of the solvent can be recovered. Also the water that is regained during the evaporation step is recycled back into the washing section of the fibre line.

This leads to a low specific water demand and overall low environmental emission figures.

Generally, the process includes the following steps:

- dissolving
- spinning
- precipitating
- washing
- finishing
- drying.

Figure 11.2 shows a simplified diagram of the Lyocell process.

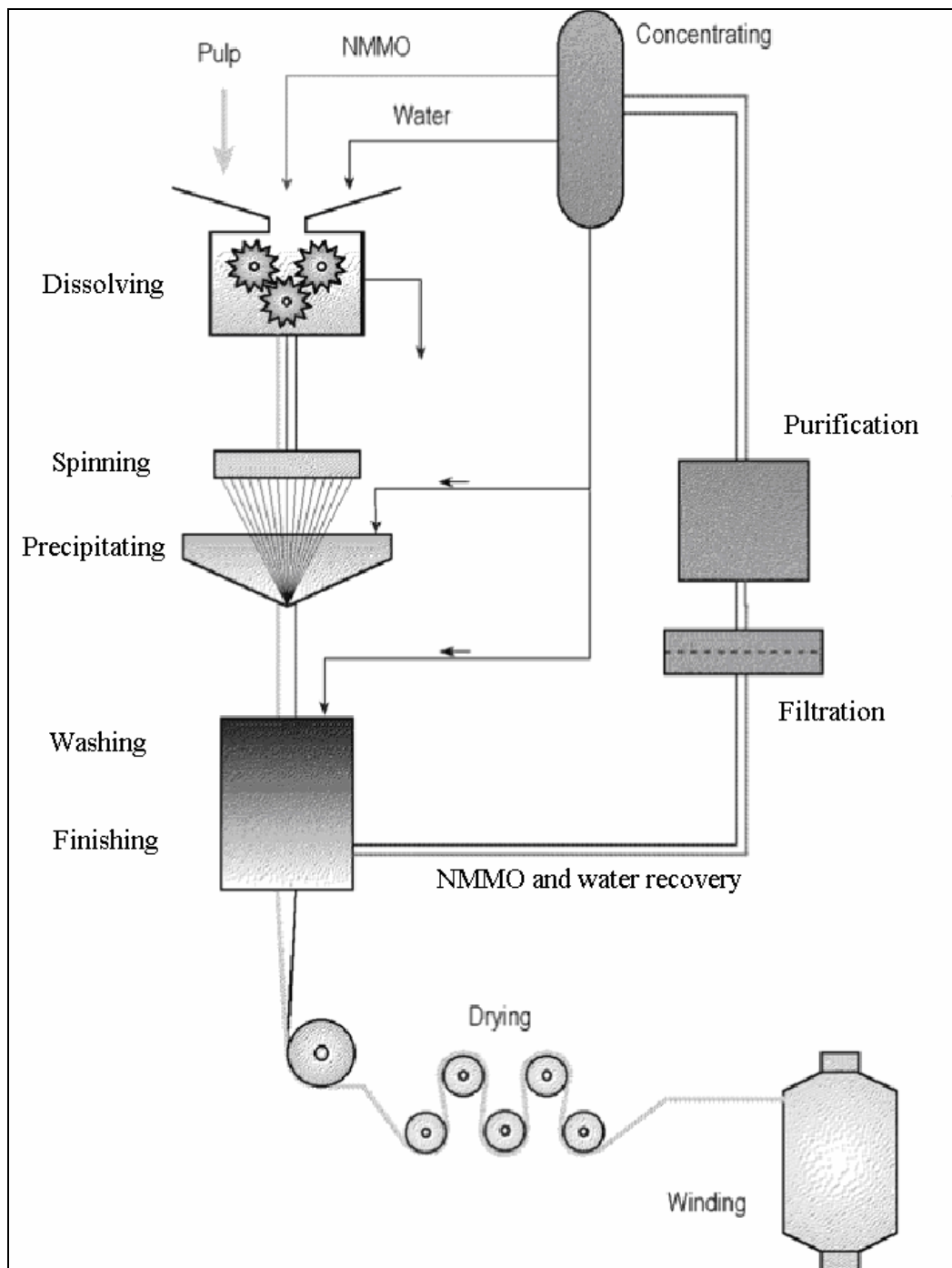

Figure 11.2: Flow diagram of the Lyocell process [15, Ullmann, 2001]

11.3 Current emission and consumption levels

The viscose process results in considerable waste waters, both in respect to volume and discharges. The main sources are:

- spent caustic from the pulp alkalisation and pressure filtration
- maintenance of the filtration units
- spent acid spinning bath solution
- purges from neutral or (sub) alkaline baths/conditioning steps
- vacuum units (steam-jet pumps with contact condensers, water seal pumps)
- waste gas scrubbing.

The total waste water volume depends mainly on the vacuum generation (steam-jet pumps consume far more water than water seal pumps with closed seal water loops) and on the spinning and conditioning steps. The options for re-use and treatment of the various waste water streams depend on the given composition [46, TWGComments, 2005].

Emission and consumption data for viscose fibre production processes were submitted by CIRFS [37, CIRFS, 2004] and a Member State [30, UBA, 2004]. Table 11.1 summarises data for staple fibres, Table 11.2 for filament yarns.

	Unit	[37, CIRFS, 2004]	[30, UBA, 2004]	Comment
Consumptions per tonne of product				
Energy	GJ	26.1 - 33.2	28.7	
Process water	t	35 - 130		Low values referring to closed systems, depending on local aquatic conditions
Cooling water	t	189 - 260		Depends on condensation technology for spinning bath and local aquatic conditions
Pulp	t	1.035 - 1.065		Depends on pulp specification, values based on conditioned pulp
CS ₂	kg	80 - 100	91	Depends on recovery technology and washing technology
H ₂ SO ₄	t	0.6 - 1.03		High values correspond with lower energy consumption at spin bath and second bath recovery, depends also on fibre specifications
NaOH	t	0.5 - 0.7	0.56	Including waste gas/water treatment
Zn	kg	2 - 10	20	Depending on fibre specifications and end uses
Spin finish	kg	3 - 5.3		Depending on fibre specifications and end uses
NaOCl	kg	0 - 50		Depending on fibre specifications and end uses, resp. the use of alternative bleaching agents
Emissions per tonne of product				
S to air	kg	12.5 - 30	17.04 CS ₂ 0.21 H ₂ S	Depends on CS ₂ consumption
SO ₄ ²⁻ to water	kg	230 - 495		Depends on sulphuric acid consumption and fibre properties
Zn to water	g	30 - 160	15 - 40	Depends on Zn consumption and spin bath recovery technology
AOX	g	10 - 20		
COD	kg	3.8 - 8	3.3	
Hazardous waste	kg	0.2 - 2.0	3	From utilities and maintenance operations
Noise at the fence	dBA	55 - 70		Depends on the local situation

Table 11.1: Emission and consumption data for viscose staple fibre production

	Unit	Filament production with integrated washing	Filament production with batch washing	Comment
Consumptions per tonne of product				
Energy	GJ	83 - 125	70 - 82	
Water	t	152 - 500	120 - 140	Including cooling and process water
Pulp	t	1.0 - 1.1	1 - 1.2	Depends on pulp specification
CS ₂	kg	290 - 300	90 - 100	Depends on recovery technology and washing technology
H ₂ SO ₄	t	0.9 - 1.6	0.9 - 1	
NaOH	t	0.7 - 1.0	0.7 - 1	Including waste gas/water treatment
Zn	kg	10 - 18	8 - 13	Depends on fibre specifications and end uses
Spin finish	kg	3 - 24	8 - 18	Depends on fibre specifications and end uses
NaOCl	kg	0 - 0.2	0	Depends on end uses and the use of alternative bleaching agents
Emissions per tonne of product				
S to air	kg	170 - 210	40 - 60	
Waste water	t	35 - 130	60	
SO ₄ ²⁻ to water	kg	250 - 1000	200 - 350	Depends on sulphuric acid consumption and fibre properties
Zn to water	g	500 - 3000	100 - 300	Depends on spin bath recovery technology and waste water treatment
AOX	g	7 - 50	5	
COD	kg	6 - 28	5 - 6	
Hazardous waste	kg	0.2 - 5	1 - 5	From utilities and maintenance operations
Noise at the fence	dBA	45 - 70		Depends on the local situation

Table 11.2: Emission and consumption data for viscose filament yarn production [37, CIRFS, 2004]

12 TECHNIQUES TO CONSIDER IN THE DETERMINATION OF BAT FOR THE PRODUCTION OF POLYMERS

This chapter sets out techniques considered generally to have potential for achieving a high level of environmental protection in the industries within the scope of this document. Management systems, process-integrated techniques and end-of-pipe measures are included, but a certain amount of overlap exists between these three when seeking the optimum results.

Prevention, control, minimisation and recycling procedures are considered as well as the re-use of materials and energy.

Techniques may be presented singly or as combinations to achieve the objectives of IPPC. Annex IV to the Directive lists a number of general considerations to be taken into account when determining BAT and techniques within this chapter will address one or more of these considerations. As far as possible a standard structure is used to outline each technique, to enable comparison of techniques and an objective assessment against the definition of BAT given in the Directive.

The content of this chapter is not an exhaustive list of techniques and others may exist or be developed which may be equally valid within the framework of BAT.

Generally, a standard structure is used to outline each technique, as shown in Table 12.1:

Type of information considered	Type of information included
Description	Technical description of the technique
Achieved environmental benefits	Main environmental impact(s) to be addressed by the technique (process or abatement), including emission values achieved and efficiency performance. Environmental benefits of the technique in comparison with others
Cross-media effects	Any side-effects and disadvantages caused by implementation of the technique. Details on the environmental problems of the technique in comparison with others
Operational data	Performance data on emissions/wastes and consumption (raw materials, water and energy). Any other useful information on how to operate, maintain and control the technique, including safety aspects, operability constraints of the technique, output quality, etc.
Applicability	Consideration of the factors involved in applying and retrofitting the technique (e.g. space availability, process specific)
Economics	Information on costs (investment and operation) and any possible savings (e.g. reduced raw material consumption, waste charges) also as related to the capacity of the technique
Driving force for implementation	Reasons for implementation of the technique (e.g. other legislation, improvement in production quality)
Example plants	Reference to a plant where the technique is reported to be used
Reference literature	Literature for more detailed information on the technique

Table 12.1: Information breakdown for each technique as described in this chapter

12.1 Generic techniques

12.1.1 Environmental management tools

Description

The best environmental performance is usually achieved by the installation of the best technology and its operation in the most effective and efficient manner. This is recognised by the IPPC Directive definition of ‘techniques’ as “*both the technology used and the way in which the installation is designed, built, maintained, operated and decommissioned*”.

For IPPC installations, an Environmental Management System (EMS) is a tool that operators can use to address these design, construction, maintenance, operation and decommissioning issues in a systematic, demonstrable way. An EMS includes the organisational structure, responsibilities, practices, procedures, processes and resources for developing, implementing, maintaining, reviewing and monitoring the environmental policy. Environmental Management Systems are most effective and efficient where they form an inherent part of the overall management and operation of an installation.

Within the European Union, many organisations have decided on a voluntary basis to implement environmental management systems based on EN ISO 14001 or the EU Eco-management and audit scheme EMAS. EMAS includes the management system requirements of EN ISO 14001, but places additional emphasis on legal compliance, environmental performance and employee involvement; it also requires external verification of the management system and validation of a public environmental statement (in EN ISO 14001 self-declaration is an alternative to external verification). There are also many organisations that have decided to put in place non-standardised EMSs.

While both standardised systems (EN ISO 14001:1996 and EMAS) and non-standardised (“customised”) systems in principle take the *organisation* as the entity, this document takes a more narrow approach, not including all activities of the organisation e.g. with regard to their products and services, due to the fact that the regulated entity under the IPPC Directive is the *installation* (as defined in Article 2).

An environmental management system (EMS) for an IPPC installation can contain the following components:

- (a) definition of an environmental policy
- (b) planning and establishing objectives and targets
- (c) implementation and operation of procedures
- (d) checking and corrective action
- (e) management review
- (f) preparation of a regular environmental statement
- (g) validation by certification body or external EMS verifier
- (h) design considerations for end-of-life plant decommissioning
- (i) development of cleaner technologies
- (j) benchmarking.

These features are explained in somewhat greater detail below. For detailed information on components (a) to (g), which are all included in EMAS, the reader is referred to the reference literature indicated below.

(a) Definition of an environmental policy

Top management are responsible for defining an environmental policy for an installation and ensuring that it:

- is appropriate to the nature, scale and environmental impacts of the activities
- includes a commitment to pollution prevention and control
- includes a commitment to comply with all relevant applicable environmental legislation and regulations, and with other requirements to which the organisation subscribes
- provides the framework for setting and reviewing environmental objectives and targets
- is documented and communicated to all employees
- is available to the public and all interested parties.

(b) Planning, i.e.:

- procedures to identify the environmental aspects of the installation, in order to determine those activities which have or can have significant impacts on the environment, and to keep this information up-to-date
- procedures to identify and have access to legal and other requirements to which the organisation subscribes and that are applicable to the environmental aspects of its activities
- establishing and reviewing documented environmental objectives and targets, taking into consideration the legal and other requirements and the views of interested parties
- establishing and regularly updating an environmental management programme, including designation of responsibility for achieving objectives and targets at each relevant function and level as well as the means and timeframe by which they are to be achieved.

(c) Implementation and operation of procedures

It is important to have systems in place to ensure that procedures are known, understood and complied with, therefore effective environmental management includes:

(i) Structure and responsibility

- defining, documenting and communicating roles, responsibilities and authorities, which includes appointing one specific management representative
- providing resources essential to the implementation and control of the environmental management system, including human resources and specialised skills, technology and financial resources.

(ii) Training, awareness and competence

- identifying training needs to ensure that all personnel whose work may significantly affect the environmental impacts of the activity have received appropriate training.

(iii) Communication

- establishing and maintaining procedures for internal communication between the various levels and functions of the installation, as well as procedures that foster a dialogue with external interested parties and procedures for receiving, documenting and, where reasonable, responding to relevant communication from external interested parties.

(iv) Employee involvement

- involving employees in the process aimed at achieving a high level of environmental performance by applying appropriate forms of participation such as the suggestion-book system or project-based group works or environmental committees.

(v) Documentation

- establishing and maintaining up-to-date information, in paper or electronic form, to describe the core elements of the management system and their interaction and to provide direction to related documentation.

(vi) Efficient process control

- adequate control of processes under all modes of operation, i.e. preparation, start-up, routine operation, shutdown and abnormal conditions
- identifying the key performance indicators and methods for measuring and controlling these parameters (e.g. flow, pressure, temperature, composition and quantity)
- documenting and analysing abnormal operating conditions to identify the root causes and then addressing these to ensure that events do not recur (this can be facilitated by a ‘no-blame’ culture where the identification of causes is more important than apportioning blame to individuals).

(vii) Maintenance programme

- establishing a structured programme for maintenance based on technical descriptions of the equipment, norms etc. as well as any equipment failures and consequences
- supporting the maintenance programme by appropriate record keeping systems and diagnostic testing
- clearly allocating responsibility for the planning and execution of maintenance.

(viii) Emergency preparedness and response

- establishing and maintaining procedures to identify the potential for and response to accidents and emergency situations, and for preventing and mitigating the environmental impacts that may be associated with them.

(d) Checking and corrective action, i.e.:

(i) Monitoring and measurement

- establishing and maintaining documented procedures to monitor and measure, on a regular basis, the key characteristics of operations and activities that can have a significant impact on the environment, including the recording of information for tracking performance, relevant operational controls and conformance with the installation's environmental objectives and targets (*see also the Reference document on Monitoring of Emissions*)
- establishing and maintaining a documented procedure for periodically evaluating compliance with relevant environmental legislation and regulations.

(ii) Corrective and preventive action

- establishing and maintaining procedures for defining responsibility and authority for handling and investigating non-conformance with permit conditions, other legal requirements as well as objectives and targets, taking action to mitigate any impacts caused and for initiating and completing corrective and preventive action that are appropriate to the magnitude of the problem and commensurate with the environmental impact encountered.

(iii) Records

- establishing and maintaining procedures for the identification, maintenance and disposition of legible, identifiable and traceable environmental records, including training records and the results of audits and reviews.

(iv) Audit

- establishing and maintaining (a) programme(s) and procedures for periodic environmental management system audits that include discussions with personnel, inspection of operating conditions and equipment and reviewing of records and documentation and that results in a written report, to be carried out impartially and objectively by employees (internal audits) or external parties (external audits), covering the audit scope, frequency and methodologies, as well as the responsibilities and requirements for conducting audits and reporting results, in order to determine whether or not the environmental management system conforms to planned arrangements and has been properly implemented and maintained
- completing the audit or audit cycle, as appropriate, at intervals of no longer than three years, depending on the nature, scale and complexity of the activities, the significance of associated environmental impacts, the importance and urgency of the problems detected by previous audits and the history of environmental problems – more complex activities with a more significant environmental impact are audited more frequently
- having appropriate mechanisms in place to ensure that the audit results are followed up.

(v) Periodic evaluation of legal compliance

- reviewing compliance with the applicable environmental legislation and the conditions of the environmental permit(s) held by the installation
- documentation of the evaluation.

(e) Management review, i.e.:

- reviewing, by top management, at intervals that it determines, the environmental management system, to ensure its continuing suitability, adequacy and effectiveness
- ensuring that the necessary information is collected to allow management to carry out this evaluation
- documentation of the review.

(f) Preparation of a regular environmental statement:

- preparing an environmental statement that pays particular attention to the results achieved by the installation against its environmental objectives and targets. It is regularly produced – from once a year to less frequently depending on the significance of emissions, waste generation etc. It considers the information needs of relevant interested parties and it is publicly available (e.g. in electronic publications, libraries etc.).

When producing a statement, the operator may use relevant existing environmental performance indicators, making sure that the indicators chosen:

- i. give an accurate appraisal of the installation's performance
- ii. are understandable and unambiguous
- iii. allow for year on year comparison to assess the development of the environmental performance of the installation
- iv. allow for comparison with sector, national or regional benchmarks as appropriate
- v. allow for comparison with regulatory requirements as appropriate.

(g) Validation by certification body or external EMS verifier:

- having the management system, audit procedure and environmental statement examined and validated by an accredited certification body or an external EMS verifier can, if carried out properly, enhance the credibility of the system.

(h) Design considerations for end-of-life plant decommissioning

- giving consideration to the environmental impact from the eventual decommissioning of the unit at the stage of designing a new plant, as forethought makes decommissioning easier, cleaner and cheaper
- decommissioning poses environmental risks for the contamination of land (and groundwater) and generates large quantities of solid waste. Preventive techniques are process-specific but general considerations may include:
 - i. avoiding underground structures
 - ii. incorporating features that facilitate dismantling
 - iii. choosing surface finishes that are easily decontaminated
 - iv. using an equipment configuration that minimises trapped chemicals and facilitates drain-down or washing
 - v. designing flexible, self-contained units that enable phased closure
 - vi. using biodegradable and recyclable materials where possible.

(i) Development of cleaner technologies:

- environmental protection should be an inherent feature of any process design activities carried out by the operator, since techniques incorporated at the earliest possible design stage are both more effective and cheaper. Giving consideration to the development of cleaner technologies can for instance occur through R&D activities or studies. As an alternative to internal activities, arrangements can be made to keep abreast with – and where appropriate – commission work by other operators or research institutes active in the relevant field.

(j) Benchmarking, i.e.:

- carrying out systematic and regular comparisons with sector, national or regional benchmarks, including for energy efficiency and energy conservation activities, choice of input materials, emissions to air and discharges to water (using for example the European Pollutant Emission Register, EPER), consumption of water and generation of waste.

Standardised and non-standardised EMSs

An EMS can take the form of a standardised or non-standardised (“customised”) system. Implementation and adherence to an internationally accepted standardised system such as EN ISO 14001:1996 can give higher credibility to the EMS, especially when subject to a properly performed external verification. EMAS provides additional credibility due to the interaction with the public through the environmental statement and the mechanism to ensure compliance with the applicable environmental legislation. However, non-standardised systems can in principle be equally effective provided that they are properly designed and implemented.

Achieved environmental benefits

Implementation of and adherence to an EMS focuses the attention of the operator on the environmental performance of the installation. In particular, the maintenance of and compliance with clear operating procedures for both normal and abnormal situations and the associated lines of responsibility should ensure that the installation’s permit conditions and other environmental targets and objectives are met at all times.

Environmental management systems typically ensure the continuous improvement of the environmental performance of the installation. The poorer the starting point is, the more significant short-term improvements can be expected. If the installation already has a good overall environmental performance, the system helps the operator to maintain the high performance level.

Cross-media effects

Environmental management techniques are designed to address the overall environmental impact, which is consistent with the integrated approach of the IPPC Directive.

Operational data

No specific information reported.

Applicability

The components described above can typically be applied to all IPPC installations. The scope (e.g. level of detail) and nature of the EMS (e.g. standardised or non-standardised) will generally be related to the nature, scale and complexity of the installation, and the range of environmental impacts it may have.

Economics

It is difficult to accurately determine the costs and economic benefits of introducing and maintaining a good EMS. A number of studies are presented below. However, these are just examples and their results are not entirely coherent. They might not be representative for all sectors across the EU and should thus be treated with caution.

A Swedish study carried out in 1999 surveyed all 360 ISO-certified and EMAS-registered companies in Sweden. With a response rate of 50 %, it concluded among other things that:

- the expenses for introducing and operating EMS are high but not unreasonably so, save in the case of very small companies. Expenses are expected to decrease in the future
- a higher degree of co-ordination and integration of EMS with other management systems is seen as a possible way to decrease costs
- half of all the environmental objectives and targets give payback within one year through cost savings and/or increased revenue
- the largest cost savings were made through decreased expenditure on energy, waste treatment and raw materials
- most of the companies think that their position on the market has been strengthened through the EMS. One-third of the companies report increasing revenue due to EMS.

In some Member States reduced supervision fees are charged if the installation has a certification.

A number of studies² show that there is an inverse relationship between company size and the cost of implementing an EMS. A similar inverse relationship exists for the payback period of invested capital. Both elements imply a less favourable cost-benefit relationship for implementing an EMS in SMEs compared to larger companies.

According to a Swiss study, the average cost for building and operating ISO 14001 can vary:

- for a company with between 1 and 49 employees: CHF 64000 (EUR 44000) for building the EMS and CHF 16000 (EUR 11000) per year for operating it
- for an industrial site with more than 250 employees: CHF 367000 (EUR 252000) for building the EMS and CHF 155000 (EUR 106000) per year for operating it.

² E.g. Dyllick and Hamschmidt (2000, 73) quoted in Klemisch H. and R. Holger, *Umweltmanagementsysteme in kleinen und mittleren Unternehmen – Befunde bisheriger Umsetzung*, KNI Papers 01/02, January 2002, p 15; Clausen J., M. Keil and M. Jungwirth, *The State of EMAS in the EU. Eco-Management as a Tool for Sustainable Development – Literature Study*, Institute for Ecological Economy Research (Berlin) and Ecologic – Institute for International and European Environmental Policy (Berlin), 2002, p 15.

These average figures do not necessarily represent the actual cost for a given industrial site because this cost is also highly dependent on the number of significant items (pollutants, energy consumption...) and on the complexity of the problems to be studied.

A recent German study (Schaltegger, Stefan and Wagner, Marcus, *Umweltmanagement in deutschen Unternehmen - der aktuelle Stand der Praxis*, February 2002, p. 106) shows the following costs for EMAS for different branches. It can be noted that these figures are much lower than those of the Swiss study quoted above. This is a confirmation of the difficulty to determine the costs of an EMS.

Costs for building (EUR):

minimum - 18750
maximum - 75000
average - 50000

Costs for validation (EUR):

minimum - 5000
maximum - 12500
average - 6000

A study by the German Institute of Entrepreneurs (Unternehmerinstitut/Arbeitsgemeinschaft Selbständiger Unternehmer UNI/ASU, 1997, *Umweltmanagementbefragung - Öko-Audit in der mittelständischen Praxis - Evaluierung und Ansätze für eine Effizienzsteigerung von Umweltmanagementsystemen in der Praxis*, Bonn.) gives information about the average savings achieved for EMAS per year and the average payback time. For example, for implementation costs of EUR 80000 they found average savings of EUR 50000 per year, corresponding to a payback time of about one and a half years.

External costs relating to verification of the system can be estimated from guidance issued by the International Accreditation Forum (<http://www.iaf.nu>).

Driving forces for implementation

Environmental management systems can provide a number of advantages, for example:

- improved insight into the environmental aspects of the company
- improved basis for decision-making
- improved motivation of personnel
- additional opportunities for operational cost reduction and product quality improvement
- improved environmental performance
- improved company image
- reduced liability, insurance and non-compliance costs
- increased attractiveness for employees, customers and investors
- increased trust of regulators, which could lead to reduced regulatory oversight
- improved relationship with environmental groups.

Example plants

The features described under (a) to (e) above are elements of EN ISO 14001:1996 and the European Community Eco-Management and Audit Scheme (EMAS), whereas the features (f) and (g) are specific to EMAS. These two standardised systems are applied in a number of IPPC installations. As an example, 357 organisations within the EU chemical and chemical products industry (NACE code 24) were EMAS registered in July 2002, most of which operate IPPC installations.

In the UK, the Environment Agency of England and Wales carried out a survey among IPC (the precursor to IPPC) regulated installations in 2001. It showed that 32 % of respondents were certified to ISO 14001 (corresponding to 21 % of all IPC installations) and 7 % were EMAS registered. All cement works in the UK (around 20) are certified to ISO 14001 and the majority are EMAS registered. In Ireland, where the establishment of an EMS (not necessarily of a standardised nature) is required in IPC licenses, an estimated 100 out of approximately 500 licensed installations have established an EMS according to ISO 14001, with the other 400 installations having opted for a non-standardised EMS.

Reference literature

(Regulation (EC) No 761/2001 of the European parliament and of the council allowing voluntary participation by organisations in a Community eco-management and audit scheme (EMAS), OJ L 114, 24/4/2001, http://europa.eu.int/comm/environment/emas/index_en.htm)

(EN ISO 14001:1996, <http://www.iso.ch/iso/en/iso9000-14000/iso14000/iso14000index.html>; <http://www.tc207.org>)

12.1.2 Equipment design

Description

The process vessels are equipped with vents to prevent pressure build up by inert gases. These vents are also used to depressurise and flush equipment during emergencies and prior to maintenance. Usually, vents are connected to air pollution control equipment, except major relief vents which, due to large flows, would overload the treatment system.

To prevent leaks from relief vents, rupture disks can be used in combination with safety valves, possibly with a previous 'safety risk analysis'. The pressure between the rupture disc and the safety valve is monitored to detect any leaks. If the safety valves are connected to an incinerator, rupture disks may not be necessary.

Technical provisions to prevent and minimise fugitive emissions of air pollutants include:

- use of valves with bellow or double packing seals or equally efficient equipment. Bellow valves are especially recommended for highly toxic services
- magnetically driven or canned pumps, or pumps with double seals and a liquid barrier
- magnetically driven or canned compressors, or compressors using double seals and a liquid barrier
- magnetically driven or canned agitators, or agitators with double seals and a liquid barrier
- minimisation of the number of flanges (connectors)
- effective gaskets
- closed sampling systems
- drainage of contaminated effluents in closed systems
- collection of vents.

Achieved environmental benefits

Prevention and reduction of VOC emissions.

Cross-media effects

No further information submitted.

Operational data

No further information submitted.

Applicability

Generally applicable for all processes.

Economics

	Mechanical seal	Magnetically driven	Canned	Double seals + liquid barrier
Pumps	100	120 - 170	130 - 170	130 - 250
Compressors	100	n/a	n/a	120
Agitator	100	120 - 150	120 - 150	130 - 250

Table 12.2: Cost factors for equipment design

Depending on the situation, the implementation may lead to different costs. The data shown in Table 12.3 are based on an estimate of the central cost estimation department of a polyethylene producer.

	Grass root plant		Adaptation of existing plant	
	Non BAT design pump	BAT design pump	Easy replacement	Difficult replacement
Pump purchasing cost	100	140	140	140
Installation cost	160	160	100	200
Basic and detailed engineering	40	50	40	100
Dismantling of existing pump	0	0	20	60
Total	300	350	300	500
Additional costs to derive BAT	-	50	300	500

Table 12.3: Cost situation for the implementation of a new pump

Driving force for implementation

Environmental and safety reasons.

Example plants

No further details submitted.

Reference literature

[1, APME, 2002, 2, APME, 2002, 3, APME, 2002]

12.1.3 Fugitive loss assessment and measurement

Description

A good fugitive loss measurement and repair programme requires an accurate calculation of components and the establishment of a database. In the database, components are classified in terms of type, service and process conditions to identify those elements with the highest potential for fugitive losses and to facilitate the application of industry standard leak factors. Experience has shown that an estimate derived by applying these standard factors can lead to an overestimation of overall fugitive emissions from the plant. A more accurate estimate is obtained if accessible components are screened by an established technique (e.g. USEPA 21), which identifies sources as 'leak', or 'no leak' according to a given threshold level. The percentage of leaking versus non-leaking components is applied to improve the overall validity of the fugitive loss estimates.

Accurate results can also be obtained when specific correlations are applied which have been developed from a set of comparable plants.

Further information can be found in the LVOC BREF Section 5.3.1.3.

Achieved environmental benefits

By the described means, the maintenance and repair programme of the installation is optimised and leads to a reduction of VOC emissions.

Cross-media effects

No cross-media effects.

Operational data

No further information submitted.

Applicability

Applicable for all processes.

Economics

The cost of a fugitive measurement programme is estimated at EUR 20000 to 30000 per line based on an annual measurement programme covering 25 % of all flanges plus the flanges repaired during the previous year. (Cost could vary depending on type of process and number of installed flanges)

Driving force for implementation

The implementation is caused by environmental as well as economic reasons to reduce emissions of monomers and/or solvents.

Example plants

Example European plants for specific correlations are the plants of ECVm member companies having adopted specific correlations for the quantification of VCM and EDC fugitive emissions and the emissions from water sealed gasholders. An example plant for both is the SolVin plant in Jemeppe, BE.

Reference literature

[2, APME, 2002, 3, APME, 2002] [9, ECVM, 2004, 10, ECVM, 2001]

12.1.4 Equipment monitoring and maintenance

Description

The established component and service database provides the basis for a routine monitoring and maintenance (M&M) programme or leak detection and repair (LDAR) programme. Components leak rates are checked on a regular basis using an organic vapour analyser. Leaking components are identified for repair and future monitoring. Over time, it is possible to build up a picture of priority areas and persistent critical components enabling effective targeting of maintenance work and/or improvement in design.

Further information can be found in the LVOC BREF and in the MON BREF.

Achieved environmental benefits

Through optimised maintenance and monitoring, fugitive emissions of VOC are reduced.

Cross-media effects

No cross-media effects.

Operational data

No further information submitted.

Applicability

Applicable for all processes.

Economics

The costs of applying LDAR are reported to be around:

- EUR 4.5/measure point in the first year (costs to map out the emission points, to draw up the LDAR programme, to measure the emissions, to report the emissions before and after repairs are made, to measure a second time (after repairs are made))
- EUR 2.5/measure point in the following years.

Driving force for implementation

The implementation is caused by environmental as well as economic reasons to reduce emissions of monomers and/or solvents.

Example plants

No further details submitted.

Reference literature

[2, APME, 2002, 3, APME, 2002]

12.1.5 Reduction of dust emissions

Description

Air used for pneumatically conveying pellets and operating pellet dedusting units contains dust and floss particles. Generally, the density of the polymer influences dust and floss formation, and a higher polymer density will lead to more dust formation, while a lower polymer density will increase the susceptibility for floss formation. Dust is potentially emitted, while floss ends up in the product or is collected as waste polymer. The following techniques and good operating practices to reduce dust emission are to be considered in the determination of BAT:

- dense conveying is more efficient to prevent dust emissions than dilute phase conveying, although upgrading to the dense phase conveying is not always possible due to design pressure constraints
- reduction of velocities in dilute phase conveying systems to as low as possible
- reduction of dust generation in conveying lines through surface treatment and proper alignment of pipes
- use of cyclones and/or filters in the air exhausts of dedusting units. The use of fabric filter systems is more effective, especially for fine dust
- use of wet scrubbers.

Further information can be found in the CWW BREF (See Section 3.5.3.2.)

Achieved environmental benefits

Reduction of dust emissions.

Cross-media effects

Energy requirements associated to the pressure drop.

Operational data

For dense phase conveying the investment costs are about 15 % higher than for dilute phase conveying. The energy consumption is higher for dilute phase conveying due to higher pressure drop/higher flow. Application of either dense or dilute phase conveying is product dependent. Dilute phase conveying is not recommended for products sensitive to attrition and dense phase conveying is not applicable for products tending to cake.

Applicability

Generally applicable.

Economics

No further information submitted.

Driving force for implementation

Environmental and legal reasons.

Example plants

No further details submitted.

Reference literature

[2, APME, 2002, 3, APME, 2002]

12.1.6 Minimisation of plant stops and start-ups

Description

Through improved operation stability (assisted by computer monitoring and control systems) and equipment reliability, the need for plant stops and start-ups is reduced to a minimum. Emergency stops can be avoided by timely identification of deviating conditions followed by the application of a controlled shut down process.

Achieved environmental benefits

Through the minimisation of shut downs, including emergency stops, and start ups the emission of VOC as well as dust is reduced.

Cross-media effects

No cross-media effects.

Operational data

No further information submitted.

Applicability

Applicable for all processes.

Economics

No further information submitted.

Driving force for implementation

The implementation is caused by environmental as well as economic reasons to reduce the loss of product, monomers and solvents.

Example plants

Reference literature

[2, APME, 2002, 3, APME, 2002]

12.1.7 Containment systems

Description

Emissions occurring during plant start ups, shut downs and emergency stops are sent to a containment system to avoid their emission to the environment. The contained material, which can be unreacted monomers, solvents, polymers, etc. are recycled if possible or used as fuel, e.g. in the case of polymers of undefined quality.

Achieved environmental benefits

Through the containment of the emitted reactor content, emissions of dust and hydrocarbons to the environment are avoided.

Cross-media effects

The contained material can be recycled back into the process and/or used as fuel.

Operational data

No further information submitted.

Applicability

Applicable for all processes except the high pressure PE process.

Economics

No further information submitted.

Driving force for implementation

The implementation is caused by environmental as well as economic reasons to reduce the loss of product, monomers and solvents.

Example plants

No further information submitted.

Reference literature

[2, APME, 2002, 3, APME, 2002]

12.1.8 Water pollution prevention**Description**

Process effluent and drainage or sewerage systems within the plant are made from corrosion-resistant materials and designed to prevent leaks to reduce the risk of loss from underground pipelines. To facilitate inspection and repair, effluent water collection systems at new plants and retrofitted systems are either:

- pipes and pumps placed above ground
- pipes placed in ducts accessible for inspection and repair.

Measures for water pollution prevention include separate effluent collection systems for:

- contaminated process effluent water
- potentially contaminated water from leaks and other sources, including cooling water and surface run-off from process plant areas, etc.
- uncontaminated water.

Further information can be found in the LVOC BREF and the CWW BREF.

Achieved environmental benefits

Improved management and control of waste water.

Cross-media effects

No further information submitted.

Operational data

No further information submitted.

Applicability

Generally applicable for all processes producing polymers. However, retrofitting a separate effluent collection system in an old plant can be complex.

Economics

No further information submitted.

Driving force for implementation

Environmental and economic reasons.

Example plants

No further details submitted.

Reference literature

[11, EVCM, 2002, 13, International Institute of Synthetic Rubber Producers, 2002, 27, TWGComments, 2004]

12.1.9 Post treatment of air purge flows coming from the finishing section and reactor vents**Description**

Thermal and catalytic incineration techniques are to be considered to treat VOC in air purges coming from the finishing section and reactor vents. Another option is to send this stream to a furnace, if available.

The need to treat the streams from the finishing section depends on residual VOC level in the product coming from the production or extrusion section. Table 12.4 shows an overview of different post treatment techniques for VOC:

Technique	Treatment efficiency	Energy consumption	CO ₂ emission
Reduction of emission at the source	100 %	0	0
Collect and send to furnace as fuel	99.5 %	saving	0
Collect and send to Incinerator	99 %	Increase	Increase
Collect and send to flare	98 - 99 %	Increase	increase

Table 12.4: Efficiency and cross-media effects of VOC treatment techniques

Further information can be found in the CWW BREF, LVOC BREF, and the ESB BREF.

Achieved environmental benefits

Reduction of VOC emissions.

Cross-media effects

Application of thermal and catalytic incineration techniques will increase energy consumption and CO₂ emissions.

Operational data

If the caloric value of the gas is higher than 11 MJ/Nm³, the efficiency of a flare is 98 - 99 %.

Applicability

Generally applicable. However, these techniques are not applied when chlorinated organic compounds are present in the stream. Chlorinated compounds are already removed from waste gases with stripping or condensation techniques during previous process steps.

Thermal oxidisers are used to reduce emissions from almost all VOC sources, including reactor vents, distillation vents, solvent operations and operations performed in ovens, dryers and kilns. They can handle minor fluctuations in flow, but excess fluctuations require the use of a flare. Their fuel consumption can be high, when low-loaded waste gases are fed, so thermal units are best suited for smaller process applications with moderate to high VOC loadings.

Catalytic oxidation is used to reduce emissions from a variety of stationary sources. The main emission source is VOC from solvent evaporation, and catalytic oxidation is widely used by many industry sectors in this category.

Economics

For a polyolefin plant the investment costs for a thermal oxidiser including a collection system are between EUR 3 million and 6 million per line (100 to 200 kt/yr PE). If a suitable furnace is available, the costs for collecting and sending to it are between EUR 1 million to 2 million per line.

Driving force for implementation

No further information submitted.

Example plants

No further details submitted.

Reference literature

[3, APME, 2002, 8, European Commission, 2003, 19, ESIG, 2003]

12.1.10 Flaring systems and minimisation of flared streams

Description

A major potential source of discontinuous emissions in the polymer production processes is the reactor system. Discontinuous emissions from reactor systems occur during plant start ups (for instance purging), shut downs and emergency stops.

Flare systems are used to treat discontinuous emissions. For flare systems, high efficiency burning tips and the injection of steam to suppress smoke formation are used to minimise emissions. Potential flows sent to the flare for incineration might include:

- gaseous hydrocarbon purge flows during startups and shut downs
- ethylene purge flows to control the build-up of inerts in the process
- hydrocarbon vapours from the intermediate purge section.

Hydrocarbon flows to be sent to a flare system are minimised by the following means:

- gaseous hydrocarbon purge flows during start-ups and shut downs:
 - reduction of the need for hydrocarbon purge by using nitrogen to make the unit free of O₂ before start up
- ethylene purge flows used to control build-up of inerts in the process:
 - recycling to a light hydrocarbon complex for reprocessing
 - use of purge ethylene as fuel
 - installation of a separate distilling purification unit to remove inerts and higher hydrocarbons.

The last technique will not completely avoid flaring, but will reduce it:

- hydrocarbon vapours from the intermediate product purge section:
 - hydrocarbon purge can be greatly reduced through the application of a closed loop nitrogen purging/condensing system.

Further information can be found in the CWW BREF.

Achieved environmental benefits

Through the flaring of the emitted reactor content, emissions of hydrocarbons to the air are avoided and dust emissions might be reduced.

Cross-media effects

The flaring of the material leads to an increase of CO₂ emissions. The noise produced when flaring is also an important aspect.

Operational data

No further information submitted.

Applicability

Applicable for all processes except the high pressure PE process and chlorinated gas streams in PVC processes. Ground flares are more suitable for the incineration of lower waste gas streams, because the noise and light emissions will be reduced.

Economics

The total costs depend on the number of polymerisation units to be connected and vary between EUR 3 million to 5 million for elevated flare and connecting lines.

Driving force for implementation

Not available.

Example plants

No further details submitted.

Reference literature

[2, APME, 2002, 3, APME, 2002]

12.1.11 Use of power and steam from cogeneration plants**Description**

A typical cogeneration system consists of an engine and a steam turbine, or a combustion turbine that drives an electrical generator. A waste heat exchanger recovers waste heat from the engine and/or exhaust gas to produce hot water or steam. Cogeneration produces a given amount of electric power and process heat with 10 to 30 % less fuel than it takes to produce the electricity and process heat separately.

Cogeneration is normally installed when the plant uses the steam produced, or where an outlet for the steam produced is available. The electricity produced can either be used by the plant or exported. [27, TWGComments, 2004]

Achieved environmental benefits

The overall efficiency of fuel utilisation is increased up to 90 %.

Cross-media effects

By the use of a cogeneration plant, not only are the energy costs reduced, but also the emissions caused by the production of energy.

Operational data

No further information submitted.

Applicability

The use of a cogeneration system is not only applicable for consumers of a vast amount of energy as the data in Table 12.5 show.

If required, possible outlets have to be available in the vicinity.

Unit	Electrical power	Efficiency %		
		Electrical conversion	Thermal recovery	Overall cogeneration
Smaller reciprocating gas engines	10 - 500 kW	20 - 32	50	74 - 82
Larger reciprocating gas engines	500 - 3000 kW	26 - 36	50	76 - 86
Diesel engines	10 - 3000 kW	23 - 38	50	73 - 88
Smaller gas turbines	800 - 10000 kW	24 - 31	50	74 - 81
Larger gas turbines	10 - 20 MW	26 - 31	50	78 - 81
Steam turbines	10 - 100 MW	17 - 34	-	-

Table 12.5: Energy efficiency of cogeneration systems of different size

Economics

No further information submitted.

Driving force for implementation

Economic and environmental reasons.

Example plants

No further details submitted.

Reference literature

[1, APME, 2002, 3, APME, 2002, 7, California Energy Commission, 1982]

12.1.12 Recovery of exothermic reaction heat through generation of low pressure steam

Description

The removed heat of reaction can be used to generate low pressure steam for preheating purposes (e.g. tubular processes, high pressure separators or tubular reactors in LDPE processes), other internal usage or for export to an external user.

Achieved environmental benefits

Reduction of energy consumption.

Cross-media effects

No cross-media effects known.

Operational data

No further information submitted.

Applicability

This technique can be applied in various processes, but is mainly applied in integrated sites where customers for the produced steam are available.

Economics

No further information submitted.

Driving force for implementation

Economic and environmental reasons.

Example plants

No further details submitted.

Reference literature

[2, APME, 2002]

12.1.13 Use of a gear pump instead of or in combination with an extruder

Description

Gear pumps, schematically shown in Figure 12.1, are more energy efficient to build up pressure to pelletise the product than extruders. However, the requirement to melt polymers and to efficiently disperse the additives in the melted polymer might restrict the application of gear pumps.

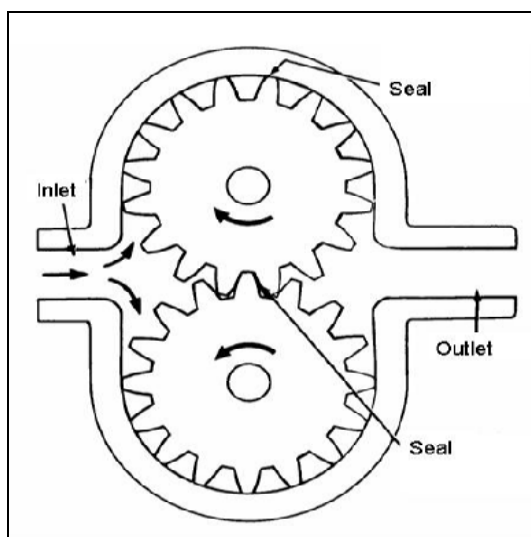

Figure 12.1: Schematic view of a gear pump

Achieved environmental benefits

Gear pumps are less energy consuming than extruders and therefore implemented to reduce energy consumption.

Cross-media effects

No further information submitted.

Operational data

No further information submitted.

Applicability

This technique is applicable where the polymer is already melted. Pelletisation of the polymer is sometimes carried out after compounding, which is a downstream operation outside the scope of this document.

Economics

No further information submitted.

Driving force for implementation

Economic reasons.

Example plants

No further details submitted.

Reference literature

[2, APME, 2002]

12.1.14 Compounding extrusion

Description

For compounding extrusion, the least energy is intended to be consumed. Therefore, online compounding is preferred over offline compounding because, in the case of offline extrusion, another melting of the product is required. The choice of offline compounding also relates to the requirements of the market.

Achieved environmental benefits

Reduction of energy consumption.

Cross-media effects

No cross-media effects known.

Operational data

No further information submitted.

Applicability

Generally applicable. Pelletisation of PVC is carried out after compounding, which is a downstream operation outside the scope of this document.

Economics

No further information submitted.

Driving force for implementation

No further information submitted.

Example plants

No further details submitted.

Reference literature

[1, APME, 2002, 2, APME, 2002]

12.1.15 Re-use of waste**Description**

Appropriate process-integrated measures help to prevent or reduce the amount of waste from a polymer plant, which contains waste solvent, waste oil, polymer waxes and scrap, purification bed agents and catalyst residues.

Waste solvent and oils can be used, where applicable, as cracker feedstock or as fuel. In some cases, concentrated polymer waxes can be sold as a by-product to the wax industry. Polymer scrap can be recycled. The usage of purification agents should be minimised through online regeneration and extended lifetime. Typically with the new generation of catalysts the efficiency is sufficiently high that catalyst residues can remain in the polymer, thus avoiding a catalyst wash step and the need to dispose of catalyst residues.

Achieved environmental benefits

Minimisation of waste and energy recovery.

Cross-media effects

No further information submitted.

Operational data

No further information submitted.

Applicability

Depending on the type of waste generated by the process. The Waste Incineration Directive sets requirements for incineration and monitoring, which could be difficult to meet in existing installation.

Economics

No further information submitted.

Driving force for implementation

No further information submitted.

Example plants

No further details submitted.

Reference literature

[2, APME, 2002, 3, APME, 2002]

12.1.16 Pigging systems

Description

Pigging technology is a subdivision of materials transport and cleaning technology. In pigging, the contents of a pipe are pushed by a close fitting plug (pig), to push the product almost completely out of the pipe. The pig is most frequently driven by a gaseous propellant (e.g. compressed air). The main components of an industrial pigging system are:

- pig
- piggable pipe with piggable valves
- pig loading and unloading station
- propellant supply
- control system.

Pigging can be applied in various locations, e.g:

- between vessels in a production plant
- process plant – tank farm
- tank farm – filling facilities.

Achieved environmental benefits

The main achieved environmental benefits include:

- no rinsing procedures or substantially smaller amounts of cleaning agents required
- lower load in rinsing waters
- reduced loss of valuable product.

Operational data

Depending on the particular task.

Cross-media effects

No issues.

Applicability

Applicable to a wide range of applications. Especially attractive for long pipelines, multi-product plants and for batch operation.

Economics

100 m pipeline, 3 inch diameter				
Conventional system	EUR		Pigging system	EUR
Investment costs (10 years service life)				
Pipe material			Pipe material	
Construction			Construction	
Valves, flanges			Valves, flanges, pressure relief vessel	
total	65000		total	105000
Operating costs				
Cleaning agent			3 pigs, EUR 250 each	
Rinsing once			maintenance	
Loss of product			(no rinsing)	
Disposal of lost product and cleaning agent				
total	14000			3250

Table 12.6: Comparison of costs for a conventional system and pigging pipeline system

Driving force for implementation

- possible automation, time saving in comparison to manual emptying
- lower costs.

Example plants

DSM unsaturated polyester plant, Schoonebeek, NL.

Reference literature

[12, Hiltcher, 2003]

12.1.17 Waste water buffer

Description

A sufficiently large buffer tank installed upstream of the waste water treatment plant for contaminated process waste water secures stable operation of the process waste water treatment by providing a constant input flow.

The buffer also functions as a reservoir (dump tank) for waste water not satisfying maximum concentration limits before discharge. These waste waters are returned to the buffer tank to be treated again.

Wash-water can also be buffered for re-use as a reactor cleaning agent in batch production (e.g. PVC) with the aim of reducing the amount of wash-water.

Further information can be found in the CWW BREF.

Achieved environmental benefits

Constant quality of waste water, leading to a constant performance of the WWTP.

Cross-media effects

No further information submitted.

Operational data

No further information submitted.

Applicability

Generally applicable for all PVC, ESBR and waste water producing processes.

Economics

No further information submitted.

Driving force for implementation

Environmental and health and safety reasons.

Example plants

No further details submitted.

Reference literature

[11, EVCM, 2002, 13, International Institute of Synthetic Rubber Producers, 2002, 27, TWGComments, 2004]

12.1.18 Waste water treatment

Description

Various techniques exist to treat waste water: biotreatment, denitrification, dephosphatation, sedimentation, flotation, etc. Depending on the waste water effluent and its composition, and the plant operation, the most appropriate techniques are selected to treat the waste water.

The main part of the WWTP is usually the aerobic biological activated sludge process. Around this central facility a complex of preparatory and subsequent separation operations is grouped. The facility may be a dedicated plant on the site of the polymer installation, a central facility in the site containing the polymer installation, or an external urban WWTP connected by dedicated pipeline or a sewer with little risk of storm overflow prior to the WWTP. The central waste water plant is normally equipped with:

- buffer or equalisation volumes, if not already provided by other upstream facilities
- mixing station, where neutralisation and flocculation chemicals are added and mixed (usually lime milk and/or mineral acids, ferrous sulphate); enclosed or covered if necessary to prevent releases of odorous substances, the captured exhaust air ducted to an abatement system
- primary clarifier, where the floc is removed; enclosed or covered if necessary to prevent fugitive releases of odorous substances, the captured exhaust air ducted to an abatement system
- activated sludge part, e.g.
 - aeration basin with nutrient feed at the entry, enclosed or covered if necessary with exhaust air ducts to an abatement system
 - or closed reaction tank (e.g. tower biology) with gas duct, connected to a gas abatement system
 - nitrification/denitrification stage (optionally) and phosphate elimination
- optional intermediate clarifier, when a second aerobic biological stage is operated, with sludge recycling

- optional second activated sludge part, for low load biology
- final clarifier with sludge recycling and transfer to sludge treatment; alternative sandfilter, MF or UF equipment
- optionally further special treatment facilities to eliminate the rest of remaining COD, e.g. UV treatment or stripping columns
- optionally further treatment facilities after the final clarifier, e.g. air flotation
- optionally sludge treatment facilities, such as:
 - digesters
 - sludge thickeners
 - sludge dewaterers
 - sludge incinerators.

- and/or other equivalent waste water treatment technologies.

Achieved environmental benefits

No further details submitted.

Cross-media effects

No further details submitted.

Operational data

No further details submitted.

Applicability

Generally applicable for all waste water producing processes.

Economics

No further details submitted.

Driving force for implementation

Environmental reasons.

Example plants

No further details submitted.

Reference literature

[8, European Commission, 2003, 36, Retzlaff, 1993]

12.2 PE techniques

12.2.1 Recovery of monomers from reciprocating compressors

Description

Packing losses at multistage compressors, used in high pressure polyethylene plants, are contained through collection and recycling to the low pressure suction stage. Monomers being emitted at the low pressure compressor are collected and sent to a thermal oxidiser or to a flaring system.

Achieved environmental benefits

Minimisation of VOC emissions from compressors.

Cross-media effects

- reduction of monomer costs through recycling
- reduction of energy consumption by using regenerative techniques
- flaring leads to an increase of CO₂ emissions.

Operational data

Not available.

Applicability

Applicable for high pressure LDPE processes.

Economics

No further information submitted.

Driving force for implementation

This technique reduces the plants emissions and, through recycling, the consumption of monomers.

Example plants

No further details submitted.

Reference literature

[31, UBA, 2004]

12.2.2 Collecting the off-gases from extruders

Description

Off-gases from the extruding section in LDPE production are rich in monomers. By sucking off the fumes from the extrusion section, the emission of monomers is reduced. The off-gases are collected and treated in a thermal oxidising unit.

Achieved environmental benefits

Reduction of monomer (VOC) emissions from the extrusion section.

Cross-media effects

Through the production of low pressure steam, the energy consumption of the plant can be reduced.

Operational data

The efficiency of the reduction is >90 %.

Applicability

Generally applicable.

Economics

No further data available.

Driving force for implementation

Environmental and legal reasons.

Example plants

No further details submitted.

Reference literature

[31, UBA, 2004]

12.2.3 Emissions from finishing and product storage sections

Freshly pelletised material coming from the extrusion and pelletising sections still contains residual monomers, comonomers and/or solvents. Therefore, emissions of these components can occur during the pelletising, classifying and drying step and the first stage of pellet storage, the so-called blending silos. The pellets enter these silos at a relatively high temperature (40 to 60 °C), which promotes the emission of potential hydrocarbon components. This potential emission source can be reduced by minimising the hydrocarbon level in the polymers entering the extrusion/storage section, vacuum devolatilisation during polymer extrusion and post treatment of air purges coming from blending silos.

The following techniques and factors are to be considered for lowering VOC emissions from polyethylene granulates:

12.2.3.1 Lowering the hydrocarbon content in polyethylene in the extrusion section

Description

Depending on the polyethylene process, several ways can be identified to lower the residual hydrocarbon content:

- high pressure polyethylene processes – operation of the low pressure separator (LPS) vessel at minimum pressure by lowering the pressure drop in the so-called low pressure recycle section between the LPS and the suction side of the booster compressor, while maintaining a stable polymer feed to the extruder
- gas phase and slurry processes (HDPE and LLDPE) – application of closed-loop nitrogen purge systems to remove monomers and/or solvents from polymer particles. Removed monomers can be collected and sent to a thermal oxidation unit
- LLDPE solution process – devolatilisation of polymer at a lower pressure and/or vacuum level.

Achieved environmental benefits

VOC emissions from product silos are reduced.

Cross-media effects

No further information submitted.

Operational data

No further information submitted.

Applicability

As described.

Economics

No further information submitted.

Driving force for implementation

No further information submitted.

Example plants

No further details submitted.

Reference literature

[2, APME, 2002]

12.2.3.2 Optimisation of the stripping in suspension processes (PP, HDPE)

Description

The deactivation and stripping is carried out in a stirred steamer. Thus, the homogeneity and contact time with the steam are improved.

By subsequent condensation, the stripped monomer is recovered and after purification recycled back into the process. Before the installation of the steamer off-gas recycling unit, these gases were flared.

Achieved environmental benefits

- reduction of monomer in the product and thus reduction of monomer
- recycling of monomer to the process and thus reduction of CO₂ emissions.

Cross-media effects

No further data available.

Operational data

- the content of monomer in the product is reduced by >75 %
- per tonne of product, about 10 kg of monomers can be recycled back into the process.

Applicability

Generally applicable for all processes using stripping.

Economics

No further data available.

Driving force for implementation

Environmental and economic reasons.

Example plants

No further details submitted.

Reference literature

[31, UBA, 2004]

12.2.3.3 Condensation of solvent

Description

The solvent evaporating from the fluidised bed dryer after the centrifuge in HDPE slurry processes is condensed and recycled back into the process.

Achieved environmental benefits

Reduction of hydrocarbon emissions.

Cross-media effects

No cross-media effects identified.

Operational data

Not available.

Economics

Not available.

Example plants

Many

Reference literature

[2, APME, 2002]

12.2.3.4 Solvent and comonomer selection for PE processes

Description

A solvent is needed as the carrier for catalyst or initiator feeds or as the reactor diluent for the solution and slurry suspension processes, while a comonomer is used to control the polymer density of the final product. In principle, the more volatile the hydrocarbon solvent and comonomer, the easier the separation from the polymer will be. However, there are some practical limitations:

- comonomer selection – comonomer selection is dictated by product design, desired application properties and targeted product value
- solvent selection for the LLDPE solution process – typically, the solution process is used to make higher value LLDPE grades through the application of hexene-1 or octene-1 as the comonomer. These comonomers are compatible with the hydrocarbon solvents, typically in the range of C6 to C9, used in the reactor system. Lower boiling comonomers and/or solvents are, in principle, possible, but might require a higher reactor operating pressure and thus more energy, to avoid phase separation and to maintain single phase conditions
- solvent and comonomer selection for the LLDPE gas phase process – the use of butene-1 as the comonomer results in very low residual hydrocarbon levels in the polymer fed to the extrusion section. However the use of hexene-1 as the comonomer (to improve product value) and/or the use of a condensable solvent (to improve plant productivity and energy consumption) will increase the residual hydrocarbon content
- solvent selection for the slurry HDPE suspension process – in principle, the more volatile the suspension solvent is the easier the removal, however low boiling solvents require a more complex condensing/recovery system. Furthermore, plant design (unit operations and design pressure) can prevent the application of low boiling solvents in the range of C4 to C6

- solvent selection for the high pressure polyethylene process – solvents are used as a carrier for the initiator in order to facilitate stable injection of the applied initiator. In principle, two types of solvents can be used in the high pressure polyethylene process, namely lower boiling hydrocarbon solvents in the range of C7 to C9 and higher boiling solvents in the range of C10 to C12. A lower boiling solvent will facilitate removal from the product, but leads to higher levels building up in the ethylene recycling systems. A higher boiling solvent is more difficult to remove from the polymer, but is easier to condense in the recycling streams and will thus lead to lower levels in the recycling systems. The net effect on the residual solvent level might be neutral. Good practice in the high pressure polyethylene process is to minimise the usage of hydrocarbon solvents while maintaining a stable injection of the initiators to the reactor system. Larger scale operations help to reduce the unit solvent consumption and also the residual solvent level in polymer.

Achieved environmental benefits

Low boiling solvents and suspension agents can be removed more easily and with less consumption of energy from the product leading to a reduction of VOC emissions from the storage.

Cross-media effects

No further information submitted.

Operational data

No further information submitted.

Applicability

As described. For some speciality products, such as PP for capacitor films, less volatile diluents are used to guarantee the product quality.

Economics

No further information submitted.

Driving force for implementation

No further information submitted.

Example plants

No further details submitted.

Reference literature

[2, APME, 2002]

12.2.3.5 Devolatilisation during the extrusion step for LDPE and LLDPE processes

Description

This technique, also called extruder degassing, is applied to remove residual hydrocarbon components in those processes in which the product is extruded starting from the melted form, for instance solution LLDPE and high pressure LDPE. This technique requires an extended extruder since the polymer needs to be compressed, vacuum devolatilised and then compressed again for the final pelletising step. The hydrocarbon vapours coming from the vacuum dome are processed in a vacuum/scrubber system. The non-condensable substances, mainly ethylene, are sent to a flare, due to the risk of undesirable contamination with oxygen.

Devolatilisation extrusion, while capable of delivering low volatiles, requires a properly designed system with respect to screw design, control loops and prevention of oxygen leaks.

In order to maintain availability or product quality similar to extruders without devolatilisation, attention has to be given to avoid oxygen intrusion and fouling of the degassing dome. Proper extruder layout and design is needed to allow operation of devolatilising extruders similar to extruders without degassing.

Achieved environmental benefits

- reduction of VOC emissions from the dryer and blending/storage silos. For example, the VOC content of a solution LLDPE with 10 – 15 % of solvent is reduced to 500 ppm by devolatilisation extrusion
- consumption reduction of resources (monomer, catalyst and fuel as well as electricity).

Cross-media effects

- extruder devolatilisation allows silo venting without post treatment of the purge flow
- extruder devolatilisation avoids the use of additional fuel for thermal post treatment of low loaded purge flows
- venting time in the silos can be reduced to about 20 to 30 % of the normal time or in certain cases venting can be avoided completely
- general plant safety downstream the devolatilisation extruder is increased
- comonomers and solvents are collected in the vacuum system and are normally sent to an incinerator or furnace (thermal value)
- the use of the flare system will increase when line-up to a furnace is not available
- apart from the degassing of ethylene, another potential advantage of extruder degassing is the effective reduction of higher boiling hydrocarbons. Such degassed polymers produce, for example, less emissions during processing at the converters.

Product properties can be affected by gel formation which may increase through oxygen intrusion and formation of cross-linked polymer in the vacuum dome.

Operational data

A reference plant uses two lines for producing LDPE (homopolymers as well as methacrylic acid). Both lines were converted, one at the beginning of the nineties and 1996 to be suitable for extruder degassing. The resulting volatiles are thermically utilised at a British Petroleum site.

As a result of extruder degassing, the normal airing time in the silo was reduced to below 50 %.

Apart from the degassing of ethylene, the main advantage of extruder degassing is the effective reduction of higher volatile hydrocarbons. Such degassed polymers produce considerably less emissions during further processing.

Another plant reports monomer contents in their EVA copolymer (example given for a 28 % VA grade) with and without the use of devolatilisation equipment (see Table 12.7):

	Ethylene ppm	Vinyl acetate ppm
With devolatilisation equipment	150	1500
Without devolatilisation equipment	1700	6200

Table 12.7: Monomer content in EVA copolymer with and without the use of devolatilisation equipment

If operational or other problems require switching off the vacuum conditions, this would lead to temporarily increased emission levels.

The currently demonstrated maximum capacity of a devolatilising extruder is 250 kt/yr for homopolymer lines.

Applicability

- applicable mainly for LDPE, but also for LLDPE
- also reported to be applicable for HDPE if necessary.

Economics

A comparison of variable operation costs for a devolatilisation extruder versus purge air treatment through a regenerative thermal oxidation unit is given in Table 12.8 below. The calculation is based on an electricity price of EUR 0.05/kWh and a fuel price of EUR 0.0162/kWh).

Operational costs in EUR/tonne of product	A	B
Electric power – extruder	3	3.9
Electric power – silo venting	0.5	0.1
Electric power – incinerator blowers	0.2	0.0
Incinerator fuel	0.3	0.0
Routine maintenance	0.4	0.5
Total costs	4.4	4.5
A: Extruder without devolatilisation		
B: Extruder with devolatilisation		

Table 12.8: Operational costs per tonne of homopolymer product (2 MFI) with (B) and without (A) devolatilisation extrusion

The cost comparison, based on variable operational costs for an LDPE homopolymer train, shows that devolatilisation extrusion and purge air treatment through regenerative thermal oxidation lead to similar operational costs.

Compared to a normal extruder with a length of 12 D (D = diameter of screw) a degassing extruder needs an additional 8 D length to house the degassing section. The additional foot print required makes it difficult to retrofit existing production lines due to space limitations.

For polymer modification by a chemical reaction, the devolatilisation extruder can provide mixing capabilities to disperse additives as well as the capability to remove unwanted by-products occurring with the reaction. With a conventional extruder, a second step would be required for this process, which then adds significant costs of about EUR 0.40/kg.

Driving force for implementation

Economic and environmental reasons, such as:

- efficient reduction of residual monomer, comonomers and solvents in the product
- less emissions during further processing at the converter.

Example plants

BP at Cologne, Germany

AT-Plastics at Edmonton, Canada

Sabic at Geleen, Netherlands

Dow at Terneuzen, Netherlands

Dow at Leuna, Germany

Actually 13 chemical companies operate about 30 devolatilisation extruders in LDPE homo- and copolymer plants. Most of these extruders are single screw extruders with a capacity of up to 35 t/h.

Reference literature

[2, APME], [18, Pfeleiderer, 2004, 27, TWGComments, 2004] [46, TWGComments, 2005]

12.2.3.6 Thermal oxidising to treat purge airflows from product silos

Description

Directly after production, LDPE still contains monomer dissolved in the polymer. Degassing silos are used to collect the monomers and transfer them to a regenerative thermal or catalytic oxidising unit.

Achieved environmental benefits

Reduction of monomer emission from the product silos.

Cross-media effects

Reduction of energy consumption by using regenerative techniques.

Operational data

The monomer emissions from the product silos are reduced to <10 %.

Applicability

Applicable for high pressure LDPE processes.

Economics

No further information submitted.

Driving force for implementation

Legal and environmental reasons.

Example plants

Borealis, Schwechat, AT.

Reference literature

[31, UBA, 2004]

12.2.4 Increase of the polymer concentration in the reactor system to the maximum possible**Description**

By increasing the concentration of the polymer in the reactor, the overall energy efficiency of the production process is optimised as follows:

- high pressure polyethylene process – in the high pressure polyethylene process this is achieved by maximising heat transfer. However, the properties of the product and the concentration of the polymer in the reactor are interdependent. The desired product quality imposes, therefore, a limitation to the maximum ethylene conversion level possible
- solution processes – the maximum polymer concentration in the solution process is a function of maximum temperature capability of the catalyst system, heat removal capability and maximum allowable process viscosity
- gas phase processes – in principle, there is no limitation as long as fluidised conditions and homogeneous temperature conditions are maintained in the reactor system. The recycling energy is reduced by improving heat removal by the addition of a condensable solvent and/or comonomer in the reactor system (so called ‘condensation mode’)
- HDPE slurry suspension process – the maximum viscosity of the slurry limits the maximum concentration of polymer solids in the hydrocarbon diluent. The slurry has to be maintained transportable. Depending on particle size distribution this means that typically the solid concentration has to be maintained between 30 and 35 vol-%.

Achieved environmental benefits

Increase of energy efficiency.

Cross-media effects

No further information submitted.

Operational data

No further information submitted.

Applicability

No further information submitted.

Economics

No further information submitted.

Driving force for implementation

Economic and environmental reasons.

Example plants

No further details submitted.

Reference literature

[2, APME, 2002]

12.2.5 Delivery of the product in the original particle shape

Description

This is potentially applicable for gas phase and slurry suspension products but it has found limited application due to the low bulk density which increases the storage and transportation costs, industrial hygiene and safety concerns (dust explosions possible). On the other hand, delivery of the product in bulk minimises packaging material.

Achieved environmental benefits

No packaging needed.

Cross-media effects

No further information submitted.

Operational data

No further information submitted.

Applicability

Applicable for slurry and gas phase processes.

Economics

No further information submitted.

Driving force for implementation

No further information submitted.

Example plants

No further details submitted.

Reference literature

[2, APME, 2002, 3, APME, 2002]

12.2.6 Closed loop cooling water systems

Description

Polyethylene plants are small process water consumers. Process water consumption is restricted to water for steam production (high pressure polyethylene plants), cooling water towers and pellet cooling water systems. To reduce the consumption of water, plants are equipped with closed loop cooling tower systems.

However, some plants located at the coast or a river delta, also use seawater or river water in a one-pass operation.

Achieved environmental benefits

Reduction of water consumption.

Cross-media effects

No further information submitted.

Operational data

No further information submitted.

Applicability

Generally applicable.

Economics

No further information submitted.

Driving force for implementation

Economic and environmental reasons.

Example plants

No further details submitted.

Reference literature

[2, APME, 2002, 3, APME, 2002]

12.3 PS techniques

The techniques listed from Table 12.10 to Table 12.11 are rated according to the scheme shown in Table 12.9.

Ratings	Efficiency rating, %	Operating cost/yr, EUR/t VOC	Installation cost, EUR/t VOC
Low	<30	<1000	<22000
Medium	30 - 70	1000 - 5000	22000 - 100000
High	>70	>5000	>100000

Table 12.9: Rating scheme for emission reduction techniques in PS processes

12.3.1 GPPS

Emissions	Available techniques	Cost	Efficiency	Remarks
Gaseous				
Storage	Minimise level variation	L	M	Only for integrated sites
	Gas balance lines	M	M	For adjacent tanks
	Floating roofs	H	H	For large tanks only
	Condensers installed	H	H	
	Vent recovery to treatment	H	H	
Process equipment	Collect vent	H	H	
Dust	Pelletiser	H	M	Type and size dependent
	Filters	H	M	
	Hydrocyclones	H	M	
Pelletiser	Collect and treat	H	M	
Liquid				
Purge	Recovered to be used with fuel oil or incinerated	M	H	
Waste water	Biological treatment*	L	H	
Solid waste**				
Hazardous and non-hazardous waste	Minimise the volume by good segregation	L	M	
	Collect to external treatment	M	H	
Management techniques		M	H	
* existing treatment plant				
** only insignificant quantities				

Table 12.10: Techniques used in GPPS processes

12.3.2 HIPS

Emissions	Available techniques	Cost	Efficiency	Remark
Gas				
Storage	Minimise level variation	L	M	Only for integrated sites
	Gas balance lines	M	M	For adjacent tanks
	Floating roofs	H	H	For large tanks only
	Condensers installed	H	H	
	Vent recovery to treatment	H	H	
Dissolving System	Cyclone to separate conveying air	M	M	High cost for retrofit
	High concentration pumping system	H	H	
	Continuous dissolving system	L	M	
	Vapour balance lines	L	M	
	Vent recovery to treatment	M	M	
	Condensers	H	M	
Process Equipment	Collect vent	H	H	
Dust	Pelletiser	H	M	Type and size dependent
	Filters	H	M	
	Hydrocyclones	H	M	
Pelletiser	Collect and treat	H	M	
Liquid				
Purge	Recovered to be used with fuel oil or incinerated	M	H	
Waste Water	Biological treatment*	L	H	
Solid Waste**				
Hazardous and non-hazardous Waste	Minimise the volume by good segregation	L	M	
	Collect for external treatment	M	H	
Management Techniques		M	H	
* existing treatment plant				
** only insignificant quantities				

Table 12.11: Techniques used in HIPS processes

12.3.3 EPS

Emissions	Available techniques	Cost	Efficiency	Remark
Gas				
Storage	Minimise level variation	L	M	Only for integrated sites
	Gas balance lines	M	M	For adjacent tanks
	Floating roofs	H	H	For large tanks only
	Condensers installed	H	H	
	Vent recovery to treatment	H	H	
Preparation of organic reactor charges	Vapour balance lines	L	H	[46, TWGComments, 2005]
	Vent recovery to external treatment (regenerative thermal oxidiser)	M	H	
Pentane emission after polymerisation	Adsorption/desorption systems/flare	H	H	Additional efficiency increase puts cost up exponentially
Liquid				
Purge	Recovered to be Used with fuel oil or incinerated	M	H	
Waste water	Biological treatment*	L	H	
Solid waste**				
Hazardous and non-hazardous waste	Minimise the volume by good segregation	L	M	
	Collect to external treatment	M	H	
Management techniques		M	H	
* existing treatment plant				
** only insignificant quantities				

Table 12.12: Techniques used in EPS processes

12.4 PVC techniques

12.4.1 Prevention of emissions from storage facilities

Description

VCM feedstock is, in general, supplied by pipeline from nearby production facilities. Plants need storage facilities for VCM. These tanks must be designed and maintained to prevent leaks and resulting soil and water pollution. VCM is alternatively stored in:

- refrigerated tanks at atmospheric pressure or
- pressurised tanks at ambient temperature.

Off-gas only occurs when there is an excess of inert gases (typically nitrogen) introduced, or from vapour return from loading operations. Emissions are prevented by providing tanks by

- refrigerated reflux condensers
- connection to the VCM recovery system or to appropriate vent treatment equipment.

Achieved environmental benefits

Prevention of emissions of VCM from storage.

Cross-media effects

No cross-media effects identified.

Operational data

No further information submitted.

Applicability

Generally applicable for all PVC processes.

Economics

No further information submitted.

Driving force for implementation

Environmental reasons.

Example plants

Plants complying with the ECVI Charters.

Reference literature

[11, ECVI, 2002, 27, TWGComments, 2004]

12.4.2 Prevention of emissions from VCM unloading facilities

Description

Emissions of VCM during unloading operations can occur from the decoupling of pipe connections, when VCM between the connections is not evacuated before decoupling. Provisions are required to purge coupling connections to VCM recovery or incineration.

Plants unloading VCM only from trucks, railcars or ships equipped with vapour return systems on their tanks avoid releases from the mobile tanks as the gas phase flows of the supplying and receiving VCM tanks are in balance.

Measures have to be undertaken to avoid any increase of oxygen content in order to prevent the formation of vinyl polyperoxides during the storage.

Achieved environmental benefits

Prevention of VCM emissions from unloading activities.

Cross-media effects

No cross-media issues identified.

Operational data

No further information submitted.

Applicability

Generally applicable for all PVC production processes.

Economics

No further information submitted.

Driving force for implementation

Environmental reasons.

Example plants

Plants complying with the ECVM Charter.

Reference literature

[11, EVCM, 2002, 27, TWGComments, 2004]

12.4.3 Prevention of emissions from polymerisation

Description

Any residual VCM remaining in the reactor before opening would be emitted to the environment without additional measures, whether that is between every batch or every 50 batches. Therefore, before opening, the reactor is degassed and steam-flushed.

The final emission level is determined by a combination of opening frequency and steam flushing efficiency. Procedures for effective reduction of residual VCM from reactors are:

- reducing the frequency of reactor openings
- depressurising the reactor by venting to VCM recovery
- draining the liquid contents to closed vessels
- rinsing and cleaning the reactor with water
- draining of this water to the stripping system
- steaming and/or flushing the reactor with inert gas to remove residual traces of VCM, with transfer of the gases to VCM recovery. The use of an extractor may also be considered.

During the venting operation, particular care needs to be taken to control foaming, and to stop foam from leaving the autoclave. This is carried out by careful control of the speed of valve opening, which is controlled by a computer. During venting, foaming is also limited by the addition of chemical defoamers. In E-PVC plants, systems must exist to catch and contain any latex leaving the reactor during venting; this latex is either fed to the latex or waste water stripping systems.

Achieved environmental benefits

Prevention of VCM emissions from reactors.

Cross-media effects

No cross-media effects identified. [27, TWGComments, 2004]

Operational data

No further information submitted.

Applicability

Generally applicable for all PVC producing processes.

Economics

No further information submitted.

Driving force for implementation

Hygiene and environmental reasons.

Example plants

Plants complying with the ECVI Charter.

Reference literature

[11, ECVI, 2002, 27, TWGComments, 2004]

12.4.4 Degassing

Description

A low VCM content in the suspension or latex is obtained during steam stripping by a suitable combination of temperature, pressure, and residence time and by maximising the ratio of free latex surface to total latex volume.

The maximum residence time and temperature which can be used, are determined by the thermal degradation of the PVC and by the propensity of the latex to coagulate. The lowest pressure and the highest stripping rate overall is determined by the tendency to foam, and thus by carryover of the polymer into, and fouling of, the steam condenser and other pipework downstream of the stripper.

The efficiency of the stripping process is also influenced by the particle size distribution, in particular the existence of particles with a diameter of 2 μm and above, as is the case with latices produced by the microsuspension and miniemulsion polymerisation processes. For smaller latex particles, the rate determining processes are the diffusion of VCM from the surface of the PVC particle into the aqueous phase and from the aqueous into the gas phase. At larger sizes, there is a switch to the rate determining step being diffusion of the VCM through the solid PVC particle and then into the aqueous phase.

The stripping can take place in the autoclave itself if it is equipped with a condenser system or in an external stripper either in batch, continuously or a combination batch/continuously. The most effective stripping is achieved when both the gas-polymer interface and the stripping time are optimised. Reactors are likely to be designed to optimise cooling efficiency during polymerisation by maximising the contact area between their liquid contents and the vessel walls; this does not maximise the gas-polymer interface, especially as the volume of the reactor increases. Continuous external strippers are well suited to the stripping of suspension PVC.

Stripping equipment for E-PVC can be designed to maximise the gas-latex interface by presenting the latex as a thin film, but there is little flexibility in stripping time, as it is defined by the geometry and physical size of the stripper itself, together with the plant throughput. The best latex stripping is achieved by batch or batch/continuous external strippers. However such strippers are not always appropriate, most noticeably in combination with continuous polymerisation processes.

Achieved environmental benefits

- removal of VCM from the latex and slurry
- prevention of VCM emissions to air during the drying stage
- prevention of VCM emissions from the final product.

Cross-media effects

No further information submitted.

Operational data

No further information submitted.

Applicability

Generally applicable for all suspension and emulsion PVC producing processes.

Economics

No further information submitted.

Driving force for implementation

Hygiene, environmental and economic reasons.

Example plants

Plants complying with the ECVM Charters

Reference literature

[11, ECVM, 2002, 27, TWGComments, 2004]

12.4.5 Prevention of dust emissions from drying**Description**

Dryers usually have very high airflow rates (typically some 10000 m³/tonne of PVC) with a low VCM content.

Due to the difference in particle size between emulsion and suspension PVC, the dried resin is separated from the air by multiple bag filters in the case of emulsion PVC or by cyclones in the case of suspension PVC.

Bag filters are most efficient in powder removal, but bags can split from time to time, thus it is important that the exit air is monitored for dust content either continuously or effectively in order to ensure that such split bags can be detected and replaced immediately. Another method for efficient final powder removal is water scrubbing.

S-PVC

The stripped suspension is normally dewatered as much as possible by mechanical processes (e.g. centrifugation) in order to reduce the consumption of energy used for drying. Effective drying is then ensured by one of several drying steps in equipment of miscellaneous designs, but all with the aim of optimising the combination of temperature, airflow and residence time.

E-PVC

The latex is sprayed through nozzles, normally with air as a second fluid, or by the use of a wheel spinning at high speed. Although more energy efficient, wheel spraying, for reasons of the rheology of the final plastisols, is little used. There are also problems with latex becoming lodged and burning in the wheel bearing.

The spraying nozzles can be blocked if coarse PVC particles are present in the latex, and thus latex is often filtered prior to drying to optimise dryer throughput.

Other drying processes are used for the production of speciality resins, e.g. coagulating the latex with a mineral acid, dewatering with a centrifuge, followed by drying using a rotating heated drum which is, in some cases, under vacuum.

Achieved environmental benefits

Prevention of dust emissions from drying processes.

Cross-media effects

No cross-media effects identified.

Operational data

No further details submitted.

Applicability

Generally applicable for emulsion and suspension PVC producing processes.

Economics

No further information submitted.

Driving force for implementation

Environmental reasons.

Example plants

No further details submitted.

Reference literature

[11, EVCM, 2002, 27, TWGComments, 2004]

12.4.6 Treatment of exhaust gases from the recovery system

Description

The VCM emissions from the recovery system depend on the efficiency of the condensation process. To remove VCM, vent gases are treated by the following techniques:

- absorption
- adsorption
- catalytic oxidation
- incinerator.

The efficiency of the condensation process depends on the number of condensation steps employed and the combination of reduced temperature and pressure which is ultimately achieved.

Achieved environmental benefits

- removal of VCM from vent gases
- prevention of VCM emissions from the recovery system.

Cross-media effects

No cross-media effects identified.

Operational data

No further information submitted.

Applicability

Generally applicable for all PVC producing processes.

Economics

No further information submitted.

Driving force for implementation

Environmental and economic reasons.

Example plants

No further details submitted.

Reference literature

[11, EVCM, 2002, 27, TWGComments, 2004]

12.4.7 Prevention and control of fugitive VCM emissions**Description**

The main sources of VCM emissions are:

- openings of polymerisation vessels and downstream equipment for cleaning. Before opening, the equipment is purged and/or steam flushed and degassed. However, any residual VCM remaining in the equipment before opening will be lost to the air. The use of an extractor may also be considered
- openings of any equipment for maintenance, despite thorough purging and flushing
- evaporation of VCM dissolved in the water seal of gasholders.

Fugitive emissions are emissions from connections and seals of equipment, which are normally considered to be leak tight. They are minimised by adequate operation, by selecting effective 'leak free' equipment, by installing VCM monitoring systems and by routine inspection to check the integrity of all relevant seals. Detection and repair programmes are part of the health, safety and environmental management systems of the plants. These actions are also necessary to achieve the low exposure level required to protect the health of plant staff.

ECVM has developed reference methodologies:

- for the measurement and control of fugitive emissions (ECVM reference method 'Identification, measurement and control of fugitive emissions from process equipment leaks', October 2004)
- for the assessment of emissions from gasholders (ECVM reference method for the assessment of atmospheric emissions from gasholders, October 2004 revision 2).

Achieved environmental benefits

Reduction of fugitive VCM emissions.

Cross-media effects

No cross-media effects identified.

Operational data

No further information submitted.

Applicability

Generally applicable for all PVC producing processes.

Economics

No further information submitted.

Driving force for implementation

Hygiene and environmental reasons.

Example plants

Plants using the methodology recommended by ECVM.

Reference literature

[9, EVCM, 2000, 10, EVCM, 2001, 11, EVCM, 2002, 27, TWGComments, 2004]

12.4.8 Prevention of accidental emissions of VCM

Description

Accidental emissions of VCM occur for example if the reaction rate during polymerisation exceeds the normal range and emergency control limits. If normal control provisions fail, the reaction energy has to be released by emergency venting of VCM.

Additional measures to prevent emergency discharge of VCM to the air include:

- specific control instrumentation for reactor feeds and operational conditions
- chemical inhibitor systems to stop the reaction
- emergency reactor cooling capacity
- emergency power for agitation
- controlled emergency vent capacity to the VCM recovery system.

Achieved environmental benefits

Prevention of VOC emissions in case of accidental conditions.

Cross-media effects

No cross-media effects identified.

Operational data

No further information submitted.

Applicability

Generally applicable for all PVC producing processes.

Economics

No further information submitted.

Driving force for implementation

Safety and environmental reasons.

Example plants

ECVM plants in general.

Reference literature

[11, EVCM, 2002, 27, TWGComments, 2004]

12.5 UP techniques

12.5.1 Technologies for the treatment of gaseous waste

Description

Waste gas streams are generated from several sources (in particular process vessels), which have to be treated prior to emitting the remaining gas to the air. The most widely used technique to treat these gases is thermal oxidation.

However, other technologies are available and used as well. An example is activated carbon adsorption used for VOC removal from vent streams that are relatively low in flow and VOC concentration.

Other examples are:

- glycol scrubbers used to treat vent streams from maleic and phthalic anhydride storage vessels
- sublimation boxes (cold traps, allowing sublimation of anhydrides, including a system of maintenance, cleaning and rework of recovered material).

Achieved environmental benefits

Reduction of VOC from reactors.

Cross-media effects

No further information submitted.

Operational data

No further information submitted.

Applicability

Generally applicable.

Economics

No further information submitted.

Driving force for implementation

Environmental reasons.

Example plants

DSM, Schoonebeek, NL (Thermal oxidiser)
Ashland, Benicarló, ES (Activated carbon drums).

Reference literature

[5, CEFIC, 2003, 8, European Commission, 2003]

12.5.2 Thermal treatment of waste water

Description

Waste water in the production of polyester is mainly reaction water. This water is treated either on site or externally. On site, this is treated by thermal oxidation.

Combined equipment for the burning of liquid waste and waste gas, is currently the most general technique. The incinerators are also used for heat recovery. The incinerator may recover energy through steam or hot oil generation, which is used for process heating purposes.

An external method for the treatment of reaction water is leading or transporting it to a biological waste water treatment plant (WWTP).

Achieved environmental benefits

Destruction of VOC and COD/TOC in general from reaction water.

Cross-media effects

- heat recovery
- increase of CO₂ and NO_x emissions.

Operational data

No further information submitted.

Applicability

Generally applicable. The Waste Incineration Directive sets requirements for incineration and monitoring.

Economics

No further information submitted.

Driving force for implementation

Environmental and economic reasons.

Example plants

No further details submitted.

Reference literature

[5, CEFIC, 2003]

12.5.3 Biological treatment of waste water

Description

Waste water in the production of polyester is mainly reaction water. This water is treated either on site or externally. An external method for the treatment of reaction water is leading or transporting it to a biological waste water treatment plant (WWTP) or in an anaerobic digester.

Achieved environmental benefits

- destruction of VOC and COD/TOC in general from reaction water
- destruction of harmful organic compounds without burning of water
- no use of fuels
- no emissions to the air.

Cross-media effects

Odour problems in transporting and in the WWTP.

Operational data

No further information submitted.

Applicability

Depending on the composition of reaction water. The biodegradability has to be tested.

Economics

Less expensive than burning of water (depends on the transportation distance).

Driving force for implementation

Environmental and economic reasons.

Example plants

Ashland Finland Oy, Porvoo, Finland

Reference literature

[27, TWGComments, 2004], [46, TWGComments, 2005]

12.6 ESRB techniques

[13, International Institute of Synthetic Rubber Producers, 2002]

The techniques listed are rated according to the scheme shown in Table 12.9.

Emissions	Available techniques	Cost	Efficiency
Gas			
Storage	Minimise level variation (integrated plants only)	L	M
	Gas balance lines (nearby tanks only)	M (H)	M (H)
	Floating roofs (large tanks only)	H	H
	Vent condensers	H	H
	Improved styrene stripping	M	M
	Vent recovery to external treatment (usually incineration)	H	H
Process equipment	Collect the vents for offsite treatment (usually incineration)	H	H
Dust, rubbers in finishing equipment, powder from additives	Filters	H	M
	Hydrocyclones	H	M
	Collect the vents for external treatment (usually incineration)		
Diffuse (fugitive) emissions	Monitoring of flanges, pumps, seals, etc.	H	M
	Preventive maintenance	H	H
	Closed loop sampling	H	H
	Plant updates: tandem mechanical seals, leak proof valves, improved gaskets	H	H
Liquid			
Process water	In-plant recycling	M	H
Waste water	Biological treatment	L	H
	Settling ponds	L	L
	Waste water strippers	H	H
Solid wastes			
Hazardous	Minimise the volume by good segregation	L	M
	Collect for external treatment	H	H
Non hazardous	Minimise volume by good management and off-site recycling	L	M

Table 12.13: Techniques used in ESRB processes

12.6.1 Storage

Description

The feedstock is, in general, supplied by pipeline from nearby production facilities or marine terminals. In some plants monomers are delivered by road or rail tankers. The plant storage tanks must be designed and maintained to prevent leaks and resulting soil and water pollution.

Butadiene is stored under its own vapour pressure in spheres that are coated with a refractory material to minimise risk from external fire.

Styrene is kept cool by means of an external heat exchanger. Both monomers contain an inhibitor such as t-butyl catechol to prevent polymer formation and in the extreme a runaway polymerisation reaction.

In general, all storage tanks are provided with sealed bunds to contain spillages should they occur. Butadiene is an exception to this; as it is considered better practice to channel away any leakage rather than allowing liquid to accumulate under the vessel, thus preventing the liquid accumulating under the tank and consequently preventing pool fires of butadiene. Gaseous emissions from butadiene storage are collected.

Additional information on storage can be found in the the Storage BREF (ESB).

Achieved environmental benefits

Prevention of emissions from storage.

Cross-media effects

No cross-media effects known.

Operational data

No further information submitted.

Applicability

Generally applicable.

Economics

No further information submitted.

Driving force for implementation

Environmental and economic reasons.

Example plants

No further details submitted.

Reference literature

[13, International Institute of Synthetic Rubber Producers, 2002]

12.7 Viscose fibre techniques

12.7.1 Housing of spinning frames

Description

Spinning frames are one of the sources of CS₂ emissions. These emissions can be avoided by the housing of spinning lines.

For operations the housing has to be equipped with leak-proof sliding windows. To avoid the accumulation of harmful and explosive gases, suction systems are installed in the housing from where CS₂ is purged to a recovery facility.

Achieved environmental benefits

Minimisation of CS₂ emissions from spinning.

Cross-media effects

Recovery of CS₂ reduces the amount of fresh chemicals needed in the process.

Operational data

No further information submitted.

Applicability

Applicable for all spinning lines.

Economics

No further information submitted.

Driving force for implementation

This technique reduces plant emissions and, through recycling, the consumption of CS₂.

Example plants

Lenzing, AT

Reference literature

[30, UBA, 2004]

12.7.2 Recovery of CS₂ through condensation

Description

Condensation systems are used for the waste gas from the spinning lines, where the CS₂ from the spinning frames is condensed for further use in the production process.

A mixture of steam, CS₂ and air with a temperature of approximately 95 °C is sucked off from the CS₂-box. Most of the vapour is condensed in the vapour condenser by mixing with water. The water temperature at the outlet of the condenser is approximately 70 to 75 °C, and the same water flows back into the acid water circulation system, to compensate for the water carried out of the system by the product. The feed temperature of the water to the vapour condenser should not be lower than 50 °C to avoid condensation of CS₂ inside the vapour condenser.

CS₂ and steam-saturated air pass through the condenser where the gases are extracted by a water jet, in which more CS₂ is condensed by the cold water.

The gaseous phase is then separated from the liquid phase by means of an air separator.

The gaseous phase contains air and all the non-condensed gases, whereas the liquid phase consists of process water and condensed CS₂, which are then separated in the CS₂-settler. The gaseous phase is vented to further purification, such as described in Section 12.7.3. The process is shown in Figure 12.2.

The recovered CS₂ is of high purity, so can be used in the viscose process again without an extra cleaning procedure. The water overflow of the settler is nearly CS₂ free, and can be circulated after treatment with caustic soda to remove the remaining H₂S.

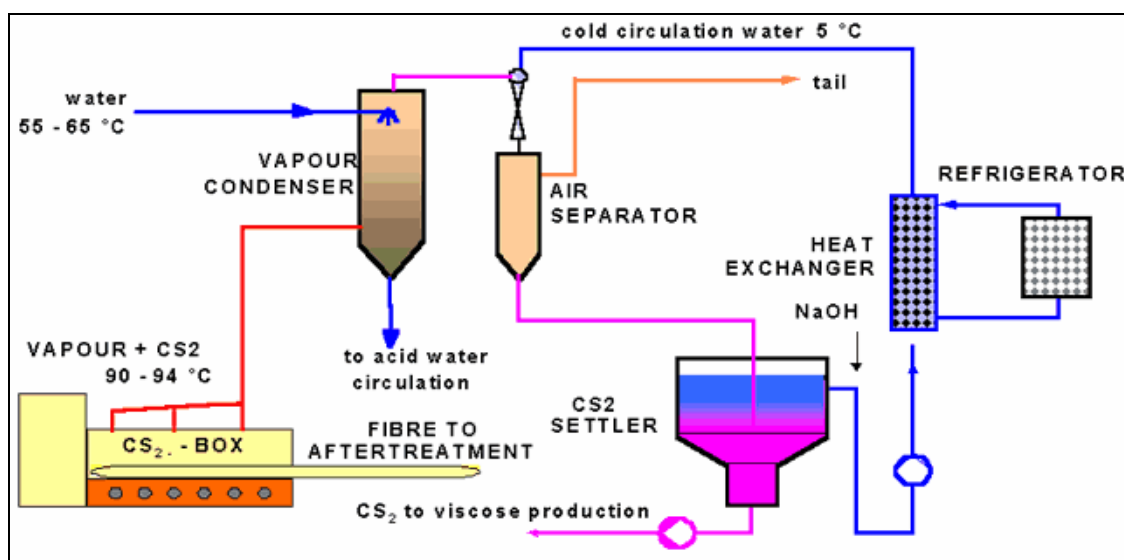

Figure 12.2: Schematic view of the condensation of CS₂ from viscose fibre production

Achieved environmental benefits

Reduction of CS₂ emissions.

Cross-media effects

The recovered CS₂ is recycled back into the process.

Operational data

The technique has a recovery efficiency of up to 98 % of the CS₂ content in the vapour.

Applicability

Generally applicable.

Economics

Not available.

Driving force for implementation

Environmental, economic and legal reasons.

Example plants

Lenzing, AT

Reference literature

[30, UBA, 2004, 41, Lenzing-Technik]

12.7.3 Recovery of CS₂ through adsorption on activated carbon**12.7.3.1 Recovery of CS₂ only****Description**

This technique is only applicable for waste gas streams that do not contain H₂S. To avoid contamination with H₂S, the gases are treated in a NaOH washer prior to the adsorption unit.

First the exhaust air, saturated with steam, is freed of H₂S. This takes place in an absorption unit consisting of two stream scrubbers operating with diluted sodium hydroxide. A centrifugal scrubber follows, where NaOH spray fog is removed. Then the exhaust air is led through two or three parallel adsorbers, where CS₂ is adsorbed. When the loading capacity of the adsorbers is reached, they are regenerated countercurrently to the loading direction by desorption with steam. The mixture of steam and CS₂-vapour is condensed and the components are separated due to their different densities in an elutriator. The recovered CS₂ is recycled without further cleaning measures into the viscose process. The condensed steam is stripped of CS₂ residues and added as dilution water for the stream scrubbers.

Achieved environmental benefits

Reduction of CS₂ emission and consumption due to recycling.

Cross-media effects

No data available.

Operational data

Operational data of an example plant:

- gas flow: 110000 Nm³/h
- CS₂ inlet: 5 - 15 g/m³
- CS₂ outlet: <150 mg/m³
- H₂S outlet: <5 mg/m³
- CS₂ removal efficiency: 94 - 96 %.

Applicability

Applicable for waste gases with low concentrations of H₂S.

Economics

No data available.

Driving force for implementation

Economic and environmental reasons.

Example plants

Lenzing, AT

Reference literature

[30, UBA, 2004]

12.7.3.2 Recovery of CS₂ and elementary sulphur

Description

With this technique, the H₂S rich exhaust streams from the spinning frames are treated.

In the so-called Sulfosorbon process, H₂S is converted to elementary sulphur, which can be extracted with CS₂. A separation column enables the subsequent separation of sulphur and CS₂.

The sulphur is extracted with recovered CS₂. The mixture produced is separated again by distillation. H₂S adsorbed in the upper region is stripped off by steam regeneration.

The exhaust gases are cooled and steam saturated when they enter the adsorbers. The lower sections of the adsorbers are filled with activated carbon which is impregnated with potassium iodide (KI) to facilitate the conversion of H₂S to elementary sulphur. The adsorbed sulphur is used for sulphuric acid production as described in Section 12.7.4.2 after being desorbed by CS₂ and subsequent evaporation of CS₂ and distillation.

The upper sections of the absorber are used for the recovery of the CS₂. When they are saturated, the activated carbon is regenerated with steam. The steam-CS₂ mixture is separated by condensation and the CS₂ is directly recycled back to the tank farm. The remaining CS₂ in the water is stripped off.

The exhaust air from the stripping is recycled back into the adsorber.

Achieved environmental benefits

Reduction of CS₂ emission and consumption due to recycling.

Cross-media effects

No data available.

Operational data

Operational data of an example plant:

- CS₂ inlet: 5 - 15 g/m³
- CS₂ outlet: <150 mg/m³
- H₂S outlet: <5 mg/m³
- CS₂ removal efficiency: 96 - 98 %.

Applicability

Applicable for waste gases containing solvents.

Economics

No data available.

Driving force for implementation

Economic and environmental reasons.

Example plants

Lenzing, AT

Reference literature

[30, UBA, 2004]

12.7.4 Desulphurisation with H₂SO₄ – production

With high concentrations of sulphur compounds in the exhaust air (>0.5 vol-%), there is a wider choice of techniques available. In practice, the combustion of the exhaust air by catalytic oxidation to sulphuric acid is often chosen. This process is only economically viable, if the acid can be produced with desired concentrations.

12.7.4.1 Wet catalytic process (single catalyst layer)

Description

In the example plant, an exhaust airflow of approx. 22000 Nm³/h from the flue-gas treatment of the four main emission sources (sulphidation, solution, vacuum degassing, spinning bath preparation) is treated. These gases contain approx. 2.4 g*Nm⁻³ H₂S and 2.3 to 2.4 g*Nm⁻³ CS₂. The gases are burnt to SO₂ between 350 and 400 °C on a noble metal catalyst and are then oxidised to SO₃ in one step on a wet catalyst (V₂O₅). The gases containing SO₃ are condensed at 250 °C, which leads to an approximately 88 % sulphuric acid. The remaining sulphuric acid aerosols are removed with a wet electrostatic precipitator. In the facility, about 200 l/h of sulphuric acid are produced that are used for the spinning process.

Achieved environmental benefits

Reduction of CS₂ and H₂S emissions.

Cross-media effects

- increase of SO₂ emissions
- sulphuric acid is recycled back into the process.

Operational data

- the residual emissions of SO_x (as SO₂) add up to about 100 - 190 mg/Nm³. Residual CS₂ is quoted with 5 mg/Nm³, and H₂S is not traceable in the exhaust gas
- the conversion rate is 99 %
- with additional H₂O₂ treatment of the off-gas, 50 mg/Nm³ of SO₂ are achievable.

Applicability

Especially applicable for gas streams with CS₂ and H₂S > 5 g per Nm³ in total as emitted in the sulphidation, solution, vacuum degassing and spinning bath preparation.

Economics

No data available.

Driving force for implementation

Environmental, legal and economic reasons.

Example plants

Glanzstoff, Austria.

Reference literature

[30, UBA, 2004], [41, Lenzing-Technik], [43, Glanzstoff].

12.7.4.2 Wet-dry catalytic double contact process

Description

In this process, the flue-gas from the production of fibre (approx. 40 - 45 vol-% of H₂S and approx. 10 - 15 vol-% of CS₂) is burnt. The process can work with elementary sulphur as well as with highly concentrated gases.

Achieved environmental benefits

Reduction of CS₂ and SO₂ emissions.

Cross-media effects

Sulphuric acid is recycled back into the process.

Operational data

- SO₂ emissions: 500 mg/Nm³
- SO₂ to SO₃ conversion rate: 99.8 %

Applicability

Applicable for highly loaded exhaust gases.

Economics

No data available.

Driving force for implementation

Economic, environmental and legal reasons.

Example plants

Lenzing, AT

Reference literature

[30, UBA, 2004]

12.7.5 Recovery of sulphate from spinning baths

Description

Sodium sulphate can be crystallised as Glauber's salt. Therefore, the spinning bath solution is led to multiple stage thickeners to raise the concentration of Na₂SO₄. There, water is vaporised to saturation point and crystallisation takes place.

By recrystallising in melting pots and evaporation of the crystal water in crystallisers, a pulp of sodium sulphate is obtained.

This pulp is centrifuged and dried at 450 °C in a drying tower by direct heating with a natural gas burner. Another technique for drying is the usage of a tumble dryer and a subsequent separation in a cyclone.

Achieved environmental benefits

Reduction of sulphate emissions.

Cross-media effects

The obtained Na_2SO_4 can be sold as a by-product.

Operational data

Not available.

Applicability

Generally applicable for sulphate reduction. If a further reduction of sulphate is necessary, the technique described in Section 12.7.7 can be applied.

Economics

Not available.

Driving force for implementation

Legal and environmental reasons.

Example plants

Lenzing and Glanzstoff, AT

Reference literature

[30, UBA, 2004]

12.7.6 Treatment of waste water streams containing ZnSO_4

Description

Zn from other solutions containing ZnSO_4 is eliminated by leading the waste water through a two- or three-stage neutralisation, where the pH value is raised from 4 to 10 by lime milk.

The zinc is precipitated as hydroxide ($\text{Zn}(\text{OH})_2$) and separated in downstream primary sedimentation. This sludge, which consists of zinc hydroxide and excess lime, is concentrated in thickeners and dewatered in centrifuges or chamber filter presses. After the dewatering process, the dry substance has about 50 - 55 % of the original weight with a zinc rate of 10 – 15 and 8 - 10 % respectively, depending on the dewatering technique used.

In a second stage, H_2S can be applied to precipitate further Zn as ZnS .

Achieved environmental benefits

Reduction of Zn from waste water.

Cross-media effects

The treatment of the sludge from precipitation has to be taken into account.

Operational data

Using step one of this technique, the concentration of Zn in the waste water can be reduced from 35 to <1 mg/l and 350 g/t respectively prior to the central WWT plant.

Using both steps, the Zn concentration in the waste water is reduced to <0.2 mg/l and 15 g/t respectively.

Applicability

Generally applicable.

Economics

Not available.

Driving force for implementation

Legal and environmental reasons.

Example plants

Lenzing and Glanzstoff, AT

Reference literature

[30, UBA, 2004]

12.7.7 Anaerobic sulphate reduction**Description**

In an anaerobic reactor, sulphate is reduced to H₂S by micro-organisms. A large part of the gas is transferred with the liquid phase into the aeration tank. The rest of the H₂S is found in the gas phase. A part of the dissolved H₂S is recycled to flocculate the Zn as ZnS as described in Section 12.7.6. In the aeration zone the H₂S is carefully re-oxidised with defined quantities of oxygen to get elementary sulphur, which is discharged from the cleaning process with the excess sludge. The remaining sewages are combined with municipal and industrial waste water and treated.

Achieved environmental benefits

Reduction of sulphate from the waste water.

Cross-media effects

The H₂S produced by the anaerobic reduction is used to precipitate Zn.

Operational data

Not available.

Applicability

Applicable for sulphate reduction in waste water discharged to sensitive waterbodies.

Economics

Not available.

Driving force for implementation

Legal and environmental reasons.

Example plants

Lenzing, AT

Reference literature

[30, UBA, 2004]

12.7.8 Treatment of non-hazardous waste

Description

Solid non-hazardous wastes from viscose fibre production are utilised for the production of steam and energy. They mainly consist of sewage sludge (primary and activated sludge).

These wastes are incinerated in a fluidised bed incinerator.

Ashes from viscose fibre production are utilised for material recovery, e.g. in the cement industry.

Achieved environmental benefits

Reduction of waste and fuels.

Cross-media effects

The consumption of fuels for the production of steam and energy is reduced.

Operational data

Not available.

Applicability

Generally applicable. Limits are given by the Waste Incineration Directive.

Economics

Not available.

Driving force for implementation

Environmental and economic reasons.

Example plants

Lenzing, AT

Reference literature

[30, UBA, 2004]

12.7.9 Biological waste water treatment

Description

After the reduction of sulphate and zinc in the waste water, it is transferred to a biological waste water plant. A schematic view of the waste water treatment is given in Figure 12.3.

The collected excess sludges of the different sedimentations are mechanically dewatered to about 35 – 50 % dry substance and incinerated by fluidised bed combustion. The press water is also collected and combined with the sewage from the plant.

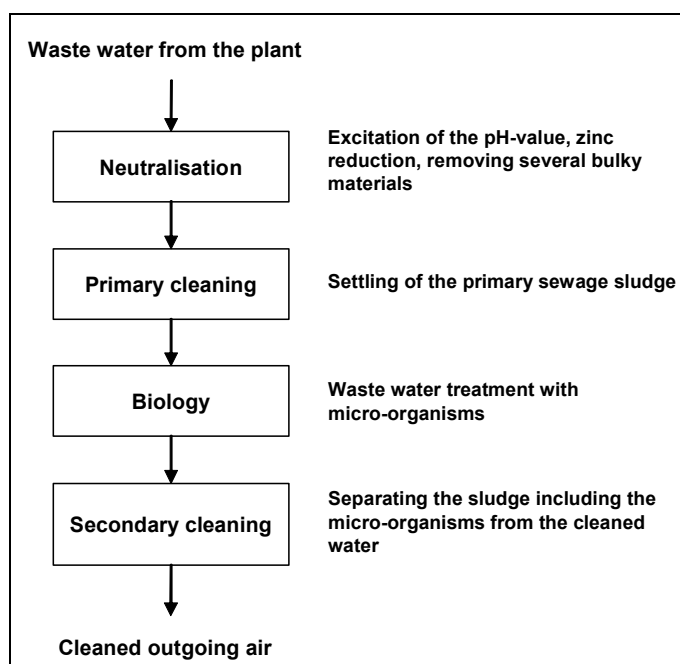

Figure 12.3: Schematic view of biological waste water treatment [43, Glanzstoff]

Achieved environmental benefits

- reduction of COD
- elimination of residual sulphide and Zn.

Cross-media effects

The treatment of the sewage sludge has to be taken into account.

Operational data

The following emission values are achieved:

- COD <20 mg/l.

Applicability

Generally applicable.

Economics

Not available.

Driving force for implementation

Environmental and legal reasons.

Example plants

Lenzing and Glanzstoff, AT

Reference literature

[30, UBA, 2004]

13 BEST AVAILABLE TECHNIQUES

In understanding this chapter and its contents, the attention of the reader is drawn back to the preface of this document and in particular the fifth section of the preface: “How to understand and use this document”. The techniques and associated emission and/or consumption levels, or ranges of levels, presented in this chapter have been assessed through an iterative process involving the following steps:

- identification of the key environmental issues for the sector
- examination of the techniques most relevant to address these key issues
- identification of the best environmental performance levels, on the basis of the available data in the European Union and worldwide
- examination of the conditions under which these performance levels were achieved; such as costs, cross-media effects, and the main driving forces involved in implementation of the techniques
- selection of the best available techniques (BAT) and the associated emission and/or consumption levels for this sector in a general sense, all according to Article 2(11) and Annex IV to the Directive.

Expert judgement by the European IPPC Bureau and the relevant Technical Working Group (TWG) has played a key role in each of these steps and in the way in which the information is presented here.

On the basis of this assessment, techniques, and as far as possible emission and consumption levels associated with the use of BAT, are presented in this chapter that are considered to be appropriate to the sector as a whole and in many cases reflect the current performance of some installations within the sector. Where emission or consumption levels “associated with best available techniques” are presented, this is to be understood as meaning that those levels represent the environmental performance that could be anticipated as a result of the application, in this sector, of the techniques described, bearing in mind the balance of costs and advantages inherent within the definition of BAT. However, they are neither emission nor consumption limit values and should not be understood as such. In some cases it may be technically possible to achieve better emission or consumption levels but due to the costs involved or cross-media considerations, they are not considered to be appropriate as BAT for the sector as a whole. However, such levels may be considered to be justified in more specific cases where there are special driving forces.

The emission and consumption levels associated with the use of BAT have to be seen together with any specified reference conditions (e.g. averaging periods).

The concept of “levels associated with BAT” described above is to be distinguished from the term “achievable level” used elsewhere in this document. Where a level is described as “achievable” using a particular technique or combination of techniques, this should be understood to mean that the level may be expected to be achieved over a substantial period of time in a well maintained and operated installation or process using those techniques.

Where available, data concerning costs have been given together with the description of the techniques presented in the previous chapter. These give a rough indication about the magnitude of the costs involved. However, the actual cost of applying a technique will depend strongly on the specific situation regarding, for example, taxes, fees, and the technical characteristics of the installation concerned. It is not possible to evaluate such site-specific factors fully in this document. In the absence of data concerning costs, conclusions on economic viability of techniques are drawn from observations on existing installations.

It is intended that the general BAT in this chapter are a reference point against which to judge the current performance of an existing installation or to judge a proposal for a new installation. In this way they will assist in the determination of appropriate "BAT-based" conditions for the installation or in the establishment of general binding rules under Article 9(8). It is foreseen that new installations can be designed to perform at or even better than the general BAT levels presented here. It is also considered that existing installations could move towards the general BAT levels or do better, subject to the technical and economic applicability of the techniques in each case.

While the BAT reference documents do not set legally binding standards, they are meant to give information for the guidance of industry, Member States and the public on achievable emission and consumption levels when using specified techniques. The appropriate limit values for any specific case will need to be determined taking into account the objectives of the IPPC Directive and the local considerations.

The interface with the BREF on CWW [31, UBA, 2004]

The BREF on "Common waste gas and waste water treatment/management systems in the chemical sector" describes techniques which are commonly applicable to the whole spectrum of the chemical industry. Detailed descriptions of recovery or abatement techniques can be found in the BREF on CWW.

The BAT associated emission levels of the end-of-pipe techniques described in the CWW BREF have to be considered BAT wherever these techniques are applied in the polymer sector.

Mass flow and concentration levels

In this chapter, where general BAT associated emission levels are given both in terms of concentration and mass flow, that which represents the greater amount in specific cases is intended as the BAT reference. All BAT associated emission levels relate to total emissions including both point sources and fugitive emissions.

Understanding the application of the BAT described in this chapter

This document deals with different polymer types (e.g. polyethylene, polyester). The BAT that are listed in this chapter include generic BAT (see Section 13.1) and specific BAT (see Sections 13.2 to 13.10) for the different polymers covered in this document. A scheme for the determination of BAT for a polymer is given in Table 13.1. The generic BAT are those that are considered to be generally applicable to all types of polymer installations. The polymer specific BAT are those that are considered to be specifically BAT for installations dealing mainly or wholly with certain types of polymer.

Therefore, in the determination of BAT, the generic as well as the specific techniques have to be considered (see Table 13.1).

Generic BAT as described in Section 13.1	plus	Specific BAT for polymer
		Polyolefins – Section 13.2
		Polystyrene – Section 13.3
		PVC – Section 13.4
		Unsaturated Polyester – Section 13.5
		ESBR – Section 13.6
		Solution polymerised rubbers containing butadiene – Section 13.7
		Polyamides – Section 13.8
		Polyethylene terephthalate fibres – Section 13.9
		Viscose fibres – Section 13.10

Table 13.1: How to combine the BAT described in this chapter for the different polymers

Please note that for polyamides and PET fibres, the information exchange has not allowed conclusions on specific BAT and BAT levels, therefore the applicable BAT for these polymers are considered to be the generic BAT, and the BAT levels are considered to be those of the CWW BREF.

Because it is not possible to be exhaustive and because of the dynamic nature of this industry, and the momentary nature of this document, it is possible that there may be additional techniques not described in this document but which meet or exceed the BAT levels established in this chapter.

13.1 Generic BAT

It is considered that in general for each polymer installation, the combination of the BAT listed here (Section 13.1), together with the polymer type specific BAT listed in Sections 13.2 to 13.10 represent a starting point for the process of determining appropriate local techniques and conditions. The practical aim is therefore the local optimisation in the circumstances of the installation, taking account of this BAT guidance, and other local factors.

Therefore, in combination with the additional specific BAT listed in later sections of this chapter, in order to provide for levels of performance that are generally compatible with BAT, the BAT for the production of polymers are the following:

1. BAT is to implement and adhere to an Environmental Management System

A number of environmental management techniques are determined as BAT. The scope (e.g. level of detail) and nature of the EMS (e.g. standardised or non-standardised) will generally be related to the nature, scale and complexity of the installation, and the range of environmental impacts it may have.

An Environmental Management System (EMS) incorporates, as appropriate to individual circumstances, the following features:

- definition of an environmental policy for the installation by top management (commitment of the top management is regarded as a precondition for a successful application of other features of the EMS)
- planning and establishing the necessary procedures
- implementation of the procedures, paying particular attention to
 - structure and responsibility
 - training, awareness and competence
 - communication
 - employee involvement
 - documentation
 - efficient process control
 - maintenance programme
 - emergency preparedness and response
 - safeguarding compliance with environmental legislation.
- checking performance and taking corrective action, paying particular attention to
 - monitoring and measurement (see also [32, European Commission, 2003])
 - corrective and preventive action
 - maintenance of records
 - independent (where practicable) internal auditing in order to determine whether or not the environmental management system conforms to planned arrangements and has been properly implemented and maintained.
- review by top management.

Three further features, which can complement the above stepwise, are considered as supporting measures. However, their absence is generally not inconsistent with BAT. These three additional steps are:

- having the management system and audit procedure examined and validated by an accredited certification body or an external EMS verifier
- preparation and publication (and possibly external validation) of a regular environmental statement describing all the significant environmental aspects of the installation, allowing for year-by-year comparison against environmental objectives and targets as well as with sector benchmarks as appropriate
- implementation and adherence to an internationally accepted voluntary system such as EMAS and EN ISO 14001:1996. This voluntary step could give higher credibility to the EMS. In particular EMAS, which embodies all the above-mentioned features, gives higher credibility. However, non-standardised systems can in principle be equally effective provided that they are properly designed and implemented.

Specifically for the polymer industry, it is also important to consider the following potential features of the EMS:

- the environmental impact from the eventual decommissioning of the unit at the stage of designing a new plant
- the development of cleaner technologies
- where practicable, the application of sectoral benchmarking on a regular basis, including energy efficiency and energy conservation activities, choice of input materials, emissions to air, discharges to water, consumption of water and generation of waste.

2. BAT is to reduce fugitive emissions by advanced equipment design (see Section 12.1.2.)

Technical provisions to prevent and minimise fugitive emissions of air pollutants include:

- use of valves with bellow or double packing seals or equally efficient equipment. Bellow valves are especially recommended for highly toxic services
- magnetically driven or canned pumps, or pumps with double seals and a liquid barrier
- magnetically driven or canned compressors, or compressors using double seals and a liquid barrier
- magnetically driven or canned agitators, or agitators with double seals and a liquid barrier
- minimisation of the number of flanges (connectors)
- effective gaskets
- closed sampling systems
- drainage of contaminated effluents in closed systems
- collection of vents.

For new installations, these techniques have to be taken into account in the plant design. For existing units, they are applied step by step following the results of the techniques described in Section 12.1.3 and Section 12.1.4 (see BAT 3 and 4).

3. BAT is to carry out a fugitive loss assessment and measurement to classify components in terms of type, service and process conditions to identify those elements with the highest potential for fugitive loss (see Section 12.1.3).

4. **BAT is to establish and maintain an equipment monitoring and maintenance (M&M) and/or leak detection and repair (LDAR) programme (see Section 12.1.4) based on a component and service database in combination with the fugitive loss assessment and measurement (see Section 12.1.3).**

5. **BAT is to reduce dust emissions (see Section 12.1.5) with a combination of the following techniques:**
 - dense phase conveying is more efficient to prevent dust emissions than dilute phase conveying
 - reduction of velocities in dilute phase conveying systems to as low as possible
 - reduction of dust generation in conveying lines through surface treatment and proper alignment of pipes
 - use of cyclones and/or filters in the air exhausts of dedusting units. The use of fabric filter systems is more effective, especially for fine dust [27, TWGComments, 2004]
 - use of wet scrubbers [27, TWGComments, 2004].

6. **BAT is to minimise plant start-ups and stops (see Section 12.1.6) to avoid peak emissions and reduce overall consumption (e.g. energy, monomers per tonne of product).**

7. **BAT is to secure the reactor contents in case of emergency stops (e.g. by using containment systems, see Section 12.1.7).**

8. **BAT is to recycle the contained material from BAT 7 or to use it as fuel.**

9. **BAT is to prevent water pollution by appropriate piping design and materials (see Section 12.1.8)**

To facilitate inspection and repair, effluent water collection systems at new plants and retrofitted systems are, e.g.

- pipes and pumps placed aboveground
- pipes placed in ducts accessible for inspection and repair.

10. **BAT is to use separate effluent collection systems (see Section 12.1.8) for:**

- contaminated process effluent water
- potentially contaminated water from leaks and other sources, including cooling water and surface run-off from process plant areas, etc.
- uncontaminated water.

11. BAT is to treat the air purge flows coming from degassing silos and reactor vents (see Section 12.1.9) with one or more of the following techniques:

- recycling
- thermal oxidation
- catalytic oxidation
- flaring (only discontinuous flows).

In some cases, the use of adsorption techniques may be considered BAT as well.

12. BAT is to use flaring systems to treat discontinuous emissions from the reactor system (see Section 12.1.10)

Flaring of discontinuous emissions from reactors is considered BAT if these emissions cannot be recycled back into the process or used as fuel (see BAT 7 above).

13. BAT is to use, where possible, power and steam from cogeneration plants (see Section 12.1.11)

Cogeneration is normally installed when the plant uses the steam produced, or where an outlet for the steam produced is available. The electricity produced can either be used by the plant or exported.

14. BAT is to recover the reaction heat through the generation of low pressure steam (see Section 12.1.12) in processes or plants where internal or external consumers of the low pressure steam are available.

15. BAT is to re-use the potential waste from a polymer plant (see Section 12.1.15)

Generally, the re-use of potential waste is favourable over landfill.

16. BAT is to use pigging systems in multiproduct plants with liquid raw materials and products (see Section 12.1.16)

17. BAT is to use a buffer for waste water upstream of the waste water treatment plant to achieve a constant quality of the waste water (see Section 12.1.17)

This applies to all waste water producing process, such as PVC and ESBR.

18. BAT is to treat waste water efficiently (see Section 12.1.18)

Waste water treatment can be carried out in a central plant or in a plant dedicated to a special activity. Depending on the waste water quality, additional dedicated pretreatment is required. Waste water treatment can be carried out in a central plant or in a plant dedicated to a special activity.

13.2 BAT for the production of polyolefins

Additionally to the generic BAT (see Section 13.1), for the production of polyolefins, the following BAT have to be taken into account.

1. BAT is to recover monomers from reciprocating compressors in LDPE processes (see Section 12.2.1) to:

- recycle them back to the process and/or
- send them to a thermal oxidiser.

2. BAT is to collect off-gases from the extruders (see Section 12.2.2)

Off-gases from the extruding section (extruder rear seal) in LDPE production are rich in VOC. By sucking off the fumes from the extrusion section, the emission of monomers is reduced. The efficiency of removal is >90 %.

3. BAT is to reduce the emissions from finishing and storage sections (see Section 12.2.3)

To reduce emissions from finishing and storage in LDPE processes, BAT is:

- operation of the low pressure separator (LPS) vessel at minimum pressure as described in Section 12.2.3.1 and/or
- solvent selection as described in Section 12.2.3.4 and
- devolatilisation extrusion as described in Section 12.2.3.5 or
- treatment of purge air from degassing silos as described in Section 12.2.3.6.

To reduce emissions from finishing and storage in low pressure suspension processes, BAT is:

- application of closed-loop nitrogen purge systems as described in Section 12.2.3.1 and
- optimisation of the stripping process as described in Section 12.2.3.2. Through optimised stripping, the monomer content in polyolefins produced with low pressure suspension technologies (PP, HDPE), is reduced to less than 25 % and
- recycling of monomers from the stripping process as described in Section 12.2.3.2. Instead of flaring, the monomers are recycled back into the production process. About 10 kg of monomers can be recycled per tonne of product and
- condensation of the solvent as described in Section 12.2.3.3 and
- solvent selection as described in Section 12.2.3.4.

To reduce emissions from finishing and storage in gas phase processes (LLDPE, HDPE, and PP), BAT is:

- application of closed-loop nitrogen purge systems as described in Section 12.2.3.1 and
- solvent and comonomer selection as described in Section 12.2.3.4 (only LLDPE).

To reduce emissions from finishing and storage in solution LLDPE processes, BAT is:

- condensation of the solvent as described in Section 12.2.3.3 and/or
- solvent selection as described in Section 12.2.3.4 and
- devolatilisation extrusion as described in Section 12.2.3.5 or
- treatment of purge air from degassing silos as described in Section 12.2.3.6.

4. **BAT is to operate the reactor at the highest possible polymer concentration (see Section 12.2.4)**

By increasing the concentration of the polymer in the reactor, the overall energy efficiency of the production process is optimised.

5. **BAT is to use closed loop cooling systems (see Section 12.2.6)**

6. **Taking into account the BAT in Section 13.1 and 13.2, the following emission and consumption levels are associated with BAT for the production of polyolefines:**

LDPE	Unit per tonne of product	BAT AEL
Consumptions		
Monomer Consumption	kg	1006
Direct energy consumption *	GJ	Tube: 2.88 – 3.24** Autoclave 3.24 – 3.60
Primary energy consumption *	GJ	Tube: 7.2 – 8.1** Autoclave: 8.1 – 9.0
Water consumption	m ³	1.7
Emissions to air		
Dust emission	g	17
VOC emission New installations Existing installations	g	700 - 1100 1100 - 2100
Emissions to water		
COD emission	g	19 - 30
Waste		
Inert waste	kg	0.5
Hazardous waste	kg	1.8 - 3
1. Direct energy is the energy consumption as delivered 2. Primary energy is energy calculated back to fossil fuel. For the primary energy calculation the following efficiencies were used: electricity: 40 %, and steam: 90 %. The large difference between direct energy consumption and primary energy consumption is due to the high share of electrical energy in LDPE processes 3. Dust includes all dust as reported by the participants 4. VOC includes all hydrocarbon and other organic compounds including fugitive emissions 5. Inert waste (to landfill) in kilograms per tonne of product (kg/t) 6. Hazardous waste (to treatment or incineration) in kilograms per tonne of product (kg/t) * Imported energy only ** Excludes a potential positive credit of 0 to 0.72 GJ/t for low pressure steam (depending on export possibilities for low pressure steam).		

Table 13.2: BAT associated emission and consumption levels (BAT AEL) for the production of LDPE

With respect to the economic viability of the above described BAT for existing plants with a limited remaining lifetime, a distinction between these existing plants and new plants was made for VOC emissions.

LDPE copolymers	Unit per tonne of product	BAT AEL
Consumptions		
Monomer consumption	kg	1020
Direct energy consumption	GJ	4.5
Primary energy consumption	GJ	10.8
Water consumption	m ³	2.8
Emissions to air		
Dust emission	g	20
VOC emission	g	2000
Waste		
Inert waste	kg	1.3
Hazardous waste	kg	5
Production of high pressure copolymers will lead to significant higher energy consumption. Production of high EVA copolymer (18 % w/w) can increase VOC emissions by 1500 g/tonne.		

Table 13.3: BAT associated emission and consumption levels (BAT AEL) for the production of LDPE copolymers.

Note: VOC and COD emissions depend on different types and levels of comonomer and are, in principle, higher than reported for LDPE.

HDPE	Unit per tonne of product	BAT AEL
Consumptions		
Monomer consumption	kg	1008
Direct energy consumption	GJ	New installations 2.05 Existing installations 2.05 – 2.52
Primary energy consumption	GJ	New installations 4.25 Existing installations 4.25 – 5.36
Water consumption	m ³	1.9
Emissions to air		
Dust emission	g	56
VOC emission New installations Existing installations	g	300 - 500 500 - 1800
Emissions to water		
COD emission	g	17
Waste		
Inert waste	kg	0.5
Hazardous waste	kg	3.1
1. Direct energy is the energy consumption as delivered 2. Primary energy is energy calculated back to fossil fuel. For the primary energy calculation the following efficiencies were used: electricity: 40 % and steam: 90 % 3. Dust includes all dust as reported by the participants. Dust emissions are mainly from drying powder prior to extrusion. 4. VOC includes all hydrocarbons and other organic compounds including fugitive emissions 5. Inert waste (to landfill) in kilograms per tonne of product (kg/t) 6. Hazardous waste (to treatment or incineration) in kilograms per tonne of product (kg/t)		

Table 13.4: BAT associated emission and consumption levels (BAT AEL) for the production of HDPE

LLDPE	Unit per tonne of product	BAT AEL
Consumptions		
Monomer consumption	kg	1015
Direct energy consumption	GJ	New installations 2.08 Existing installations 2.08 – 2.45
Primary energy consumption	GJ	New installations 2.92 Existing installations 2.92 – 4.14
Water consumption	m ³	1.1
Emissions to air		
Dust emission	g	11
VOC emission New installations Existing installations	g	200 - 500 500 - 700
Emissions to water		
COD emission	g	39
Waste		
Inert waste	kg	1.1
Hazardous waste	kg	0.8
<ol style="list-style-type: none"> 1. Direct energy is the energy consumption as delivered 2. Primary energy is energy calculated back to fossil fuel. For the primary energy calculation the following efficiencies were used: electricity: 40 %, steam: 90 % 3. Dust includes all dust as reported by the participants 4. VOC includes all hydrocarbons and other organic compounds including fugitive emissions. VOC emissions depend on the type of comonomer (200 ppm for butane-1 and 500 ppm for octane-1) 5. Inert waste (to landfill) in kilograms per tonne of product (kg/t) 6. Hazardous waste (to treatment or incineration) in kilograms per tonne of product (kg/t) 		

Table 13.5: BAT associated emission and consumption levels (BAT AEL) for the production of LLDPE

13.3 BAT for the production of polystyrene

Additionally to the generic BAT (see Section 13.1), for the production of polystyrene, the following BAT have to be taken into account.

1. BAT is to reduce and control emissions from storage (see Section 12.3)

BAT is to use one or more of the following techniques:

- minimisation of level variation
- gas balance lines
- floating roofs (large tanks only)
- installed condensers
- vent recovery to treatment.

2. BAT is to recover all purge streams and reactor vents (see Section 12.3)

Purge streams are used as fuel oils or treated with thermal oxidisers which can be used for heat recovery and steam production.

3. BAT is to collect and treat the exhaust air from pelletising (see Section 12.3)

Usually, the air sucked off the pelletising section is treated together with reactor vents and purge streams. This only applies to GPPS and HIPS processes.

4. BAT is to reduce emissions from the preparation in EPS processes (see Section 12.3)

BAT is to use one or more of the following or equivalent techniques:

- vapour balance lines
- condensers
- vent recovery to further treatment.

5. BAT is to reduce emissions from the dissolving system in HIPS processes (see Section 12.3)

BAT is to use one or more of the following or equivalent techniques:

- cyclones to separate conveying air
- high concentration pumping systems
- continuous dissolving systems
- vapour balance lines
- vent recovery to further treatment
- condensers.

6. Taking into account the BAT in Sections 13.1 and 13.3, the following emission and consumption levels are associated with BAT for the production of polystyrene:

GPPS	Unit per tonne product	BAT AEL
Air emissions		
Dust	g	20
VOC, total	g	85
Water emissions		
COD	g	30
Suspended solids	g	10
Hydrocarbons total	g	1.5
Waste water	t	0.8
Cooling tower purge water	t	0.5
Waste		
Hazardous	kg	0.5
Non-hazardous	kg	2
Consumptions		
Total energy	GJ	1.08
Styrene	t	0.985
Mineral oil	t	0.02
Cooling water (closed circuit)	t	50
Process water	t	0.596
Nitrogen	t	0.022
Diluent	t	0.001
Additives	t	0.005
1 The emission values in the water are measured after treatment. The waste water treatment facility can be inside the plant or at a centralised location. 2 Not including cooling tower purge water 3 Hazardous waste (to treatment or incineration) in kilograms per tonne of product (kg/t) 4 Inert waste (to landfill) in kilograms per tonne of product (kg/t)		

Table 13.6: BAT associated emission and consumption levels (BAT AEL) for the production of GPPS

HIPS	Unit per tonne of product	BAT AEL
Air emissions		
Dust	g	20
VOC, total	g	85
Water emissions		
COD	g	30
Suspended solids	g	10
Hydrocarbons total	g	1.5
Waste water	t	0.8
Cooling tower purge water	t	0.6
Waste		
Hazardous	kg	0.5
Non-hazardous	kg	3
Consumptions		
Total energy	GJ	1.48
Styrene	t	0.915
Mineral oil	t	0.02
Rubber	t	0.07
Cooling water (closed circuit)	t	50
Process water	t	0.519
Nitrogen	t	0.010
Diluent	t	0.001
Additives	t	0.005
1 The emission values in the water are measured after treatment. The waste water treatment facility can be inside the plant or at a centralised location. 2 Not including cooling tower purge water 3 Hazardous waste (to treatment or incineration) in kilograms per tonne of product (kg/t) 4 Inert waste (to landfill) in kilograms per tonne of product (kg/t)		

Table 13.7: BAT associated emission and consumption levels (BAT AEL) for the production of HIPS

EPS	Unit per tonne of product	BAT AEL
Air emissions		
Dust	g	30
VOC including pentane from point sources ¹	g	450 - 700
Water emissions		
COD	g	
Total solids	g	
Hydrocarbons total	g	
Dissolved solids	g	0.3
Waste water	t	5
Cooling tower purge water	t	1.7
Phosphate as P ₂ O ₅	g	
Waste		
Hazardous	kg	3
Non-hazardous	kg	6
Consumptions		
Total energy	GJ	1.8
Styrene	t	0.939
Pentane	t	0.065
Cooling water (closed circuit)	t	17
Process water	t	2.1
Nitrogen	t	0.01
Additives	t	0.03
<p>1 not including emissions from storage</p> <p>2 The emission values in the water are measured after treatment. The waste water treatment facility can be inside the plant or at a centralised location.</p> <p>3 Hazardous waste (to treatment or incineration) in kilograms per tonne of product (kg/t)</p> <p>4 Inert waste (to landfill) in kilograms per tonne of product (kg/t)</p>		

Table 13.8: BAT associated emission and consumption levels (BAT AEL) for the production of EPS

13.4 BAT for the production of PVC

Additionally to the generic BAT (see Section 13.1), for the production of PVC, the following BAT have to be taken into account.

- 1. BAT is to use appropriate storage facilities for the VCM feedstock, designed and maintained to prevent leaks and resulting air, soil and water pollution (see Section 12.4.1)**

BAT is to store VCM in:

- refrigerated tanks at atmospheric pressure or
- pressurised tanks at ambient temperature.

BAT is to avoid VCM emissions by providing tanks with:

- refrigerated reflux condensers and/or
- connection to the VCM recovery system or to appropriate vent treatment equipment.

- 2. BAT for VCM unloading is to prevent emissions from connections (see Section 12.4.2)**

BAT is to use one of the following techniques:

- use of vapour balance lines
- evacuation and treatment of VCM from connections prior to decoupling.

- 3. BAT is to reduce residual VCM emissions from reactors (see Section 12.4.3)**

BAT is to use an appropriate combination of the following or equivalent techniques:

- reducing the frequency of reactor openings
- depressurising the reactor by venting to VCM recovery
- draining the liquid contents to closed vessels
- rinsing and cleaning the reactor with water
- draining of this water to the stripping system
- steaming and/or flushing the reactor with inert gas to remove residual traces of VCM, with transfer of the gases to VCM recovery.

- 4. BAT is to use stripping for the suspension or latex to obtain a low VCM content in the product (see Section 12.4.4)**

A suitable combination of temperature, pressure, and residence time and a maximisation of the ratio of free latex surface to total latex volume are key elements to achieve a high efficiency.

- 5. BAT for PVC production is to use a combination of:**

- stripping
- flocculation
- biological waste water treatment (see Section 12.1.18.).

6. BAT is to prevent dust emissions from drying process (see Section 12.4.5)

Due to the difference in particle size between emulsion and suspension PVC, different techniques are considered BAT as follows:

- BAT is to use multiple bag filters for emulsion PVC
- BAT is to use bag filters for microsuspension PVC
- BAT is to use cyclones for suspension PVC.

7. BAT is to treat VCM emissions from the recovery system (see Section 12.4.6)

BAT is to use one or more of the following or equivalent techniques:

- absorption
- adsorption
- catalytic oxidation
- incineration.

8. BAT is to prevent and control fugitive emissions of VCM arising from equipment connections and seals (see Section 12.4.7)

Emissions are minimised by adequate operation, by selecting effective 'leak free' equipment, by installing VCM monitoring systems and by routine inspection to check the integrity of all relevant seals. Detection and repair programmes are part of the health, safety and environmental management systems of the plants. These actions are also necessary to achieve the low exposure level required to protect the health of plant staff.

9. BAT is to prevent accidental emissions of VCM from polymerisation reactors (see Section 12.4.8)

BAT is to use one or more of the following or equivalent techniques:

- specific control instrumentation for reactor feeds and operational conditions
- chemical inhibitor systems to stop the reaction
- emergency reactor cooling capacity
- emergency power for agitation^{*}
- controlled emergency vent capacity to the VCM recovery system.

(*) Emergency power for agitation is not necessary if the catalyst is only soluble in water.

10. Taking into account the BAT in Sections 13.1 and 13.4, the following emission and consumption levels are associated with BAT for the production of PVC

PVC	Unit per tonne of product	BAT AEL S-PVC	BAT AEL E-PVC
Emissions to air			
Total VCM	g	18 - 45	100 - 500
PVC dust	g	10 - 40	50 - 200
Emissions to water			
VCM to water*	g	0.3 - 1.5	1 - 8
COD**	g	50 - 480	
Suspended solids****	g	10	
Waste			
Hazardous waste***	g	10 - 55	25 - 75
* before WWT ** in the final effluent *** solid waste containing >0.1 % of VCM **** after pretreatment, in this way AOX values from 1 - 12 g/t PVCM in the final effluent are achieved for PVC production sites or combined EDC, VCM and PVC production			

Table 13.9: BAT associated emission and consumption levels for the production of PVC

Split view

Three Member States wanted a split view recorded against the values given in Table 13.9. According to the information given in Section 5.3, the values shown in Table 13.10 are to be considered BAT:

PVC	Unit per tonne of product	BAT AEL S-PVC	BAT AEL E-PVC
Emissions to air			
Total VCM	g	18 - 72	160 - 700

Table 13.10: Split view – VCM emissions related to BAT techniques

The upper value of the range applies to the small production sites. The wide range of BAT AEL does not belong to different BAT performance but to different product mix manufacturing. Any BAT AEL in this range is related to plants applying BAT throughout their processes.

13.5 BAT for the production of unsaturated polyester

Additionally to the generic BAT (see Section 13.1), for the production of unsaturated polyester, the following BAT have to be taken into account.

1. BAT is to treat exhaust gases (see Section 12.5.1)

BAT is to use one or more of the following or equivalent techniques:

- thermal oxidation
- active carbon
- glycol scrubbers
- sublimation boxes.

2. BAT is to thermally treat waste water, arising mainly from the reaction (see Section 12.5.2).

Combined equipment for the burning of liquid waste and waste gas is currently the most general technique.

3. Taking into account the BAT in Sections 13.1 and 13.5, the following emission and consumption levels are associated with BAT for the production of unsaturated polyester:

UP	Unit	BAT AEL range	
Consumptions			
Energy	GJ/t	2	3.5
Water	m ³ /t	1	5
Emissions to air			
VOC to air	g/t	40	100
CO to air	g/t		50
CO ₂ to air	kg/t	50	150
NO _x to air	g/t	60	150
SO ₂ to air	g/t	~ 0	100
Particles to air	g/t	5	30
Waste			
Hazardous waste for external treatment	kg/t		7

Table 13.11: BAT associated emission and consumption levels for the production of UP

13.6 BAT for the production of ESRB

Additionally to the generic BAT (see Section 13.1), for the production of ESRB, the following BAT have to be taken into account.

1. BAT is to design and maintain the plant storage tanks to prevent leaks and resulting air, soil and water pollution (see Section 12.6.1)

BAT is to store butadiene under its own vapour pressure in spheres that are coated with a refractory material to minimise risk from external fire.

BAT is to store styrene under cool conditions by means of an external heat exchanger.

BAT is to use one or more of the following or equivalent techniques:

- minimise level variation (integrated plants only)
- gas balance lines (nearby tanks only)
- floating roofs (large tanks only)
- vent condensers
- improved styrene stripping
- vent recovery to external treatment (usually incineration).

2. BAT is to control and minimise diffuse (fugitive) emissions (see Section 12.6)

BAT is to use the following or equivalent techniques:

- monitoring of flanges, pumps, seals, etc.
- preventive maintenance
- closed loop sampling
- plant updates: tandem mechanical seals, leak proof valves, improved gaskets.

3. BAT is to collect the vents from process equipment for treatment (usually incineration) (see Section 12.6)

4. BAT is to recycle water (see Section 12.6)

5. BAT is to treat waste water using biological treatment or equivalent techniques (see Section 12.6)

6. BAT is to minimise the volume of hazardous waste by good segregation and collect them to send for external treatment (see Section 12.6)

7. BAT is to minimise the volume of non-hazardous waste by good management and off-site recycling (see Section 12.6)

8. Taking into account the BAT in Sections 13.1 and 13.6, the following emission and consumption levels are associated with BAT for the production of ESRB:

	Unit	BAT AEL
Emissions to air		
Total VOC	g/t of solid product	170 - 370
Emissions to water		
COD	g/t	150 - 200

Table 13.12: BAT associated emission and consumption levels for the production of ESRB per tonne of product

13.7 BAT for the production of solution polymerised rubbers containing butadiene.

Additionally to the generic BAT (see Section 13.1), for the production of SBR, the following BAT has to be taken into account.

- 1. BAT is to remove solvents by using one or both of the following or an equivalent technique:**
 - devolatilisation extrusion
 - steam stripping.

13.8 BAT for the production of polyamides

Additionally to the generic BAT (see Section 13.1), for the production of polyamides, the following BAT has to be taken into account.

- 1. BAT is to treat flue-gases from polyamide production processes by wet scrubbing.**

13.9 BAT for the production of polyethylene terephthalate fibres

Additionally to the generic BAT (see Section 13.1), for the production of PET fibres, the following BAT have to be taken into account.

1. BAT is to apply a waste water pretreatment such as:

- stripping
- recycling
- or equivalent

before sending waste water from PET production processes to a WWT plant.

2. BAT is to treat waste gas streams from PET production with catalytic oxidation or equivalent techniques.

13.10 BAT for the production of viscose fibres

Additionally to the generic BAT (see Section 13.1), for the production of viscose fibres, the following BAT have to be taken into account.

1. **BAT is to operate spinning frames in houses (see Section 12.7.1)**
2. **BAT is to condense the exhaust air from spinning streets to recover CS₂ and recycle it back into the process (see Section 12.7.2)**
3. **BAT is to recover CS₂ from exhaust air streams through adsorption on activated carbon (see Section 12.7.3)**

Depending on the concentration of H₂S in the exhaust air, different technologies are available for the adsorptive recovery of CS₂.

4. **BAT is to apply exhaust air desulphurisation processes based on catalytic oxidation with H₂SO₄ production (see Section 12.7.4)**

Depending on the mass flows and concentrations, there are a number of different processes available to oxidise sulphur containing exhaust gases.

5. **BAT is to recover sulphate from spinning baths (see Section 12.7.5)**

BAT is to remove sulphate as Na₂SO₄ from the waste water. The by-product is economically valuable and sold.

6. **BAT is to reduce Zn from the waste water by alkaline precipitation followed by sulphide precipitation (see Section 12.7.6)**

BAT is to achieve 1.5 mg/l of Zn.

For sensitive waterbodies, BAT is to achieve 0.3 mg/l of Zn.

7. **BAT is to use anaerobic sulphate reduction techniques for sensitive waterbodies (see Section 12.7.7)**

If further sulphate elimination is necessary, anaerobic reduction to H₂S is carried out.

8. **BAT is to use fluidised bed incinerators to burn non-hazardous wastes (see Section 12.7.8) and recover the heat for the production of steam or energy**

9. Taking into account the BAT in Sections 13.1 and 13.10, the following emission and consumption levels are associated with BAT for the production of viscose staple fibres:

Viscose staple fibres	Unit per tonne of product	BAT AEL range	
Consumptions per tonne of product			
Energy	GJ	20	30
Process water	m ³	35	70
Cooling water	m ³	189	260
Pulp	t	1.035	1.065
CS ₂	kg	80	100
H ₂ SO ₄	t	0.6	1.0
NaOH	t	0.4	0.6
Zn	kg	2	10
Spin finish	kg	3	5
NaOCl	kg	0	50
Emissions per tonne of product			
S to air	kg	12	20
SO ₄ ²⁻ to water	kg	200	300
Zn to water	g	10	50
COD	g	3000	5000
Waste			
Hazardous waste	kg	0.2	2
Noise			
Noise at the fence	dB(A)	55	70

Table 13.13: BAT associated emission and consumption levels for the production of viscose staple fibres

14 EMERGING TECHNIQUES

14.1 Catalytic heat regenerative process for H₂SO₄ recovery in viscose fibre production

Description

At this industrial prototype plant, 100000 Nm³/h of weakly loaded exhaust gas (about 2 g/Nm³ CS₂) from tyre yarn spinning and the after treatment are purged in the plant. The low concentrations of SO₂ prohibit autothermic combustion, so this plant works according to the principle of the heat regenerative catalysis. Thus, the heat of the absorption process is utilised for heating of the exhaust gases through ceramic storage masses in two alternately used reactors. After the heating, there is a direct oxidation to SO₃ on a noble metal catalyst at approximately 450 °C and a condensation on the other respective ceramic reactor.

A schematic view of the process is shown in Figure 14.1:

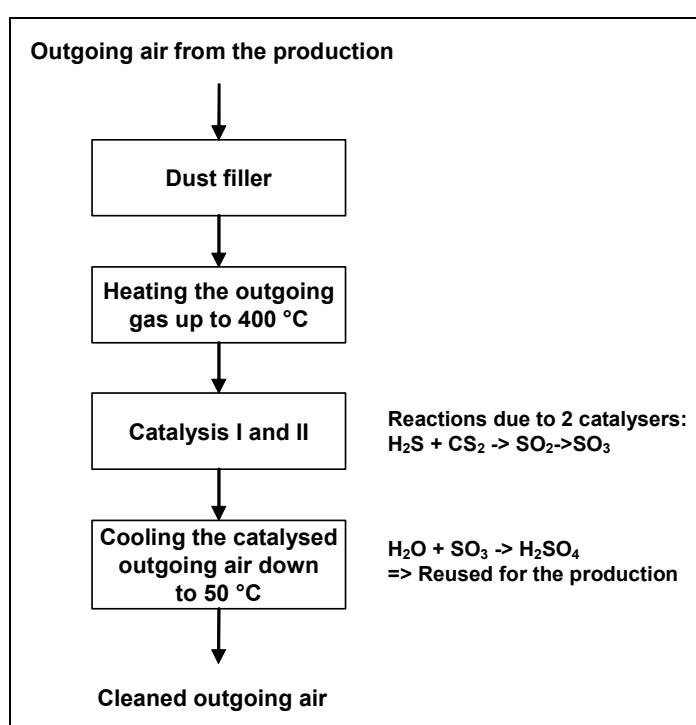

Figure 14.1: Desulphurisation and H₂SO₄ production with double catalysis [43, Glanzstoff]

Achieved environmental benefits

Reduction of CS₂ and H₂S emissions.

Cross-media effects

- increase of SO₂ emissions
- sulphuric acid is recycled back into the process.

Operational data

The residual emissions of SO_x (as SO₂) are about 180 mg/Nm³. Residual CS₂ is quoted with 45 mg/Nm³, and H₂S is not traceable in the exhaust gas.

Applicability

Especially applicable for low concentration off-gas streams.

Economics

No data available.

Driving force for implementation

Environmental, legal and economic reasons.

Example plants

Glanzstoff, AT

Reference literature

[30, UBA, 2004], [43, Glanzstoff]

15 CONCLUDING REMARKS

Timing of the work

The information exchange on Best Available Techniques for the Production of Polymers was carried out from 2003 to 2005. It took two years to collect the information, to draft this document and to develop this document based on the comments arising from two consultations and the final TWG meeting. Table 15.1 shows the milestones of the work.

Kick-off meeting	3 - 4 December 2003
First draft	September 2004
Second draft	April 2005
Final Technical Working Group meeting	24 - 27 October 2005

Table 15.1: Timing of the work for this document

Sources of information and development of this document

Some reports were elaborated prior to the kick-off meeting on purpose to provide targeted information for the development of this document. The reports were submitted by Plastics Europe, the industry association representing the majority of European polymer producers, and by Germany, Italy, and France. These documents can be considered building blocks for the first draft.

A big part of the information was obtained by visiting 12 production sites in Spain, Belgium, the Netherlands and Austria, usually organised and accompanied by one or more TWG members. Additionally, a wide variety of other sources provided information and examples of good practices. The sources include Industry and Member State shadow groups. Additionally, information so that two more chapters could be included in the second draft was provided by Plastics Europe and Austria.

Generally, the exchange of information was dominated by the input of industry associations.

This document was developed based on about 600 comments to the first draft and again about 600 comments to the second draft. Major discussion items at the final meeting were the BAT associated emission levels and the methodology on how they were derived from the data provided and the applicability of certain end-of-pipe technologies used to destroy VOC from the production processes.

Information provided

According to the complexity of the sector and as agreed at the kick-off meeting, this document cannot cover all production processes for polymers. This document focuses on the most important products or product families. Some important products such as polyoxymethylene or polycarbonate are not dealt with for lack of information submitted.

The wide ranges for emissions and consumptions in polyamide and PET production and processing depend on the specific product and these need to be assessed for further understanding in order to identify BAT associated emission and consumption levels.

Methodology for the determination of BAT associated emission and consumption levels

The current emission and consumption levels as provided by APME show a statistic approach, e.g. to set the BAT level at the performance of the top 25 or 50 % of installations. Where there was a technical justification for this approach, it was agreed by the TWG.

For solution polymerised rubbers containing butadiene, no technical justification could be agreed on. Therefore, no BAT associated emission and consumption levels could be identified.

Level of consensus

The information exchange process was successful and a high degree of consensus was achieved during and following the final meeting of the Technical Working Group. Only one split view was recorded. However, it has to be noted that increasing confidentiality concerns represented a considerable obstacle throughout the work.

Recommendations for future work

It is recommended to widen the scope of this document and to include more products and generic processes in a review. For this purpose, data collection and updating in the Member States should be carried out well in advance of the review process.

For the emission data from thermal oxidisers, the information should contain a statement explaining whether the emissions from the fuel used to operate them are included or not. In the case of data provided by APME in this document, these emissions are included.

Suggested topics for future R&D work

The EC is launching and supporting, through its RTD programmes, a series of projects dealing with clean technologies, emerging waste stream treatment and recycling technologies and management strategies. Potentially these projects could provide a useful contribution to future BREF reviews. Readers are therefore invited to inform the EIPPCB of any research results which are relevant to the scope of this document (see also the Preface of this document).

REFERENCES

- 1 APME (2002). "BAT Reference Document: Contribution by Industry".
- 2 APME (2002). "Best Available Techniques: Production of Polyethylene".
- 3 APME (2002). "Best Available Techniques: Production of Polystyrenes and Expandable Polystyrenes".
- 4 APME (2004). "Best Available Techniques: Production of Polyamides".
- 5 CEFIC (2003). "Best available Techniques, Production of unsaturated Polyesters".
- 7 California Energy Commission (1982). "Cogeneration Handbook".
- 8 European Commission (2003). "BREF on common waste water and waste gas treatment / management systems in the chemical sector", European Commission.
- 9 ECVM (2004). "Identification, measurement and control of fugitive emissions from process equipment leaks".
- 10 ECVM (2001). "ECVM reference method for the assesment of atmospheric emissions from gasholders (revision 2)".
- 12 Hiltsher, M., Smits (2003). "Industrial pigging technology", Wiley-VCH, 3-527-30635-8.
- 13 International Institute of Synthetic Rubber Producers, I. (2002). "Best Available Techniques: Production of Emulsion polymerised Styrene-Butadiene Rubber (ESBR)".
- 14 Winnacker-Kuechler (1982). "Chemische Technologie, Technology for organic compounds", Carl Hanser Verlag, Muenchen.
- 15 Ullmann (2001). "Ullmann's Encyclopedia of Industrial Chemistry", Wiley-VCH.
- 16 Stuttgart-University (2000). "Resource-sparing production of polymer materials", Institute for Plastics Testing and Plastics Engineering.
- 18 Pfleiderer, W. (2004). "ZSK MEGAc ompounders The polyolefin machines."
- 19 ESIG (2003). "Guide on VOC emissions management".
- 20 CIRFS, C. I. d. I. R. e. d. F. S. (2003). "Best Available Techniques: Polyester Fibre Technology".
- 21 G. Verrhiest, J.-M. B. (2003). "French contribution for the Kick-off meeting of the Technical Working Group for Best Available Techniques for the production of Polymers".
- 22 Ministerio de Medio Ambiente, S. (2003). "Location, Capacity and Production of Polymer Installations in Spain at the end of 2002".
- 23 Roempp (1992). "Roempp Chemie Lexikon", G. Thieme Verlag, 3137348102.
- 25 J. Brandrup and E. Immergut (1998). "Polymer Handbook", John Wiley & Sons, 0 471 47936 5.

References

- 27 TWGComments (2004). "Comments made by the TWG on the first draft document. Excel spreadsheet."
- 28 Italy (2004). "Polyamides", TWG.
- 29 M. Parth; N. Aust and K. Lederer (2003). "Molecular Characterization of Ultra-high Molar Mass and Soluble Fractions of Partially Cross-linked Polyethylenes", Int. J. Polym. Anal. Charact., 8.
- 30 UBA, A. (2004). "Austrian Mini BREF Cellulose Fibres".
- 31 UBA, U. (2004). "Medienübergreifende Umweltkontrolle in ausgewählten Gebieten. Umweltbundesamt", Bd. M-168. Wi.
- 35 Chemiefaser, I. "Man-made Fibres, The way from production to use".
- 36 Retzlaff, V. (1993). "Reststoffproblematik bei der Herstellung von synthetischen Chemiefasern", Technische Hochschule Koethen, Institut fuer Umwelttechnik.
- 37 CIRFS, C. I. d. I. R. e. d. F. S. (2004). "Proposal for a BREF document on Viscose fibres".
- 38 Plastics_Europe (2004). "An analysis of plastics consumption and recovery in Europe".
- 39 APME (2003). "Annual Report".
- 40 Fechiplast_Belgian_Plastics_Converters'_Association.
- 41 Lenzing-Technik.
- 42 International Institute of Synthetic Rubber producers (2004). "BAT Production of Solution Polymerised Rubber containing Butadiene".
- 43 Glanzstoff, A., Glanzstoff Austria.
- 46 TWGComments (2005). "Comments made by the TWG on the second draft document. Excel spreadsheet."
- 48 EPA (1989). Reference Method 21, "Determination of Volatile Organic Compounds Leaks".

GLOSSARY

ABS	polyacrylonitrile-butadiene-styrene
AC	alkali cellulose
acid	proton donor. A substance that, more or less readily, gives off hydrogen ions in a water solution
AH salt	organic salt obtained by the reaction of 1.6 hexamethylenediamine and 1.6 hexanedicarboxylic acid
AOCI	adsorbable organic chlorine compounds
AOX	adsorbable organic halogen compounds. The total concentration in milligrams per litre, expressed as chlorine, of all halogen compounds (except fluorine) present in a sample of water that are capable of being adsorbed on activated carbon
APE	alkyl phenol ethoxylates
API separator	oil/water/sludge separator (developed by American Petroleum Institute)
Aquifer	a water-bearing layer of rock (including gravel and sand) that will yield water in usable quantity to a well or spring
Assimilative capacity	the ability of a natural body of water to receive waste waters or toxic materials without harmful effects and without damage to aquatic life
ASA	acrylonitrile styrene acrylate
Bactericide	a pesticide used to control or destroy bacteria
BAT	best available techniques
BATAEL	Best available technique associated emission level
BCF	bulk continuous filament
BF	batch wise flocculation
BFO	bunker fuel oil
BFW	boiler feed-water to produce steam
Biochemicals	chemicals that are either naturally occurring or identical to naturally occurring substances. Examples include hormones, pheromones and enzymes. Biochemicals function as pesticides through non-toxic, non-lethal modes of action, such as disrupting the mating pattern of insects, regulating growth or acting as repellants
Biodegradable	that can be broken down physically and/or chemically by micro-organisms or other biological environments. For example, many chemicals, food scraps, cotton, wool and paper are biodegradable
BOD	biochemical oxygen demand: the quantity of dissolved oxygen required by micro-organisms in order to decompose organic matter. The unit of measurement is mg O ₂ /l. In Europe, BOD is usually measured after 3 (BOD ₃), 5 (BOD ₅) or 7 (BOD ₇) days
BPU	batch polymerisation unit
BR	Butadiene rubber
BREF	BAT reference document
BTEX	benzene, toluene, ethylbenzene, xylene
BTX	benzene, toluene, xylene
CAS	chemical abstracts service
CCR	conradson carbon residue
CF	continuous flocculation
CHP	cogeneration of heat and power
COD	chemical oxygen demand: the amount of potassium dichromate, expressed as oxygen, required to chemically oxidise at c. 150 °C substances contained in waste water.
Concarbon	Conradson carbon = the amount of carbon residue
Cross-media effects	the calculation of the environmental impacts of water/air/soil emissions, energy use, consumption of raw materials, noise and water extraction (i.e. everything required by the IPPC Directive)

CSTR	continuous stirred tank reactor
DAF	dissolved air flotation
DCPD	dicyclopentadiene
Diffuse emission	emissions arising from direct contact of volatile or light dusty substances with the environment (atmosphere, under normal operating circumstances). These can result from: <ul style="list-style-type: none"> • inherent design of the equipment (e.g. filters, dryers...) • operating conditions (e.g. during transfer of material between containers) • type of operation (e.g. maintenance activities) • or from a gradual release to other media (e.g. to cooling water or waste water)
Diffuse sources	sources of similar diffuse or direct emissions which are multiple and distributed inside a defined area
DMT	dimethyl terephthalate
DS	dry solids (content). The mass of a material remaining after drying by the standard method of test
EC50	effect concentration 50. The concentration at which effects are observed in 50 % of the test population after administering a single dose. Effects include the immobilisation of daphnia, inhibition of growth, cell division or biomass production, or the production of chlorophyll by algae
ECVM	the European Council of Vinyl Manufacturers
EDC	ethylene dichloride
Effluent	physical fluid (air or water together with contaminants) forming an emission
EG	ethylene glycol
EI catalyst	Ester interchange catalyst
EIPPCB	European IPPC Bureau
Emerging techniques	Potential future BAT
Emission	the direct or indirect release of substances, vibrations, heat or noise from individual or diffuse sources in the installation into the air, water or land
BAT AEL	Emissions and consumptions which are achievable using BAT
Emission limit values	the mass, expressed in terms of certain specific parameters, concentration and/or level of an emission, which may not be exceeded during one or more periods of time
Emulsifier	substance which stabilises an emulsion
End-of-pipe technique	a technique that reduces final emissions or consumptions by some additional process but does not change the fundamental operation of the core process. Synonyms: "secondary technique", "abatement technique". Antonyms: "process-integrated technique", "primary technique" (a technique that in some way changes the way in which the core process operates thereby reducing raw emissions or consumptions)
EOP	end-of-pipe
EP	electrostatic precipitator
EPDM	ethylene-propylene-diene rubber
EPS	expandable polystyrene
EPVC	Emulsion PVC
ESBR	emulsion polymerised styrene butadiene rubber
EVA	Ethylene-vinylacetate
Existing installation	an installation in operation or, in accordance with legislation existing before the date on which this Directive is brought into effect, an installation authorised or in the view of the competent authority the subject of a full request for authorisation, provided that that installation is put into operation no later than one year after the date on which this Directive is brought into effect

FB	fluidised bed
FDY	Fully drawn yarn
FOY	Fully oriented yarn
Fugitive emission	emission caused by non-tight equipment/leak: emission into the environment resulting from a gradual loss of tightness from a piece of equipment designed to contain an enclosed fluid (gaseous or liquid), basically caused by a difference of pressure and a resulting leak. Examples of fugitive emissions: leak from a flange, a pump, a sealed or tightened equipment, etc...
GDP	gross domestic product
GPPS	general purpose polystyrene
HDPE	high density polyethylene
HFO	heavy fuel oil
HIPS	high impact polystyrene
HP	high pressure
HPS	high pressure separator
HTM	heat transfer medium
HVAC	heat/ventilation/air condition
HVU	high vacuum unit. Production unit (step in the production line) which operates under high vacuum
IBC	intermediate bulk container
IEF	Information Exchange Forum (informal consultation body in the framework of the IPPC Directive)
Immission	occurrence and level of polluting substance, odour or noise in the environment
Installation	a stationary technical unit where one or more activities listed in Annex I of IPPC Directive are carried out, and any other directly associated activities which have a technical connection with the activities carried out on that site and which could have an effect on emissions and pollution
IPPC	integrated pollution prevention and control
IPS	impact polystyrene
IV	intrinsic viscosity
LDAR	leak detection and repair programme
LDPE	low density polyethylene
LLDPE	linear low density polyethylene
LOEC	lowest observed effect concentration. The lowest experimentally determined concentration of a test substance at which adverse effects can be observed
LP	low pressure
LPS	low pressure separator
LTD	low temperature drying
LVOC	large volume organic chemicals (BREF)
MDI	methylene diphenyl diisocyanate
MDPE	medium density polyethylene
Median	the value below which 50% of the cases fall
MEG	monoethylene glycol
MF	membrane filtration
MFI	melt flow index
Micelles	aggregate of surfactant molecules dispersed in a liquid colloid
MLSS	mixed liquor suspended solids. The concentration of suspended solids in activated sludge mixed liquor, expressed in milligrams per litre. Commonly used in connection with activated sludge aeration units
MMD	molar mass distribution
Monitoring	process intended to assess or to determine the actual value and the variations of an emission or another parameter, based on

	procedures of systematic, periodic or spot surveillance, inspection, sampling and measurement or other assessment methods intended to provide information about emitted quantities and/or trends for emitted pollutants
Multi-media effects	see cross-media effects
MWD	molecular weight distribution
n/a	not applicable OR not available (depending on the context)
n/d	no data
Naphthenes	hydrocarbons containing one or more saturated rings of 5 or 6 carbon atoms in their molecules, to which paraffinic-type branches are attached (adjective: naphthenic).
NBR	nitrile-butadiene rubber
N-Kj	nitrogen analysed by Kjeldahl method
NMMO	N-methyl-morpholine-N-oxide
NOAC	no observed acute effect concentration
NOEC	no observed effect concentration
Operator	any natural or legal person who operates or controls the installation or, where this is provided for in national legislation, to whom decisive economic power over the technical functioning of the installation has been delegated
PA	polyamide
PBT	polybutylene terephthalate
PBu	polybutadiene
PC	polycarbonate
PE	polyethylene
PEEK	polyetheretherketone
PE-HD	polyethylene, high density
PEI	polyetherimide
PE-LD	polyethylene, low density
PE-LLD	polyethylene, linear low density
PEN fibres	Polyethylene naphthalate fibres
PES	polyethersulphone
PET	polyethylene terephthalate
PFR	plug flow reactor
PI	polyimide
PI	process-integrated
PLA	Polylactic acid
PMMA	polymethyl methacrylate
Pollutant	individual substance or group of substances which can harm or affect the environment
POM	polyoxymethylene (polyacetal)
PP	polypropylene
PPO	polyphenylene oxide
PPS	polyphenylene sulphide
Primary measure/technique	a technique that in some way changes the way in which the core process operates thereby reducing raw emissions or consumptions (see end-of-pipe technique)
PS	polystyrene
PTA	polyterephthalic acid
PTFE	polytetrafluoroethylene
PUR	polyurethane
PVA	polyvinyl acetate
PVC	polyvinyl chloride
PVDC	polyvinylidene chloride
PVDF	polyvinylidene fluoride
SAN	polystyrene-acrylonitrile

SBC	Styrenic block copolymer
SBR	styrene butadiene-rubber
SBS	styrene butadiene styrene
SEBS	Styrene-ethylene- butylene-styrene
Secondary measure/technique	see end-of-pipe technique
SEPS	Styrene-ethylene-propylene-styrene
SIS	styrene isoprene styrene
SM	styrene monomer
SMA	polystyrene-maleic anhydride
SME	small and medium enterprise(s)
Specific emission	emission related to a reference basis, such as production capacity, or actual production (e.g. mass per tonne or per unit produced)
S-PVC	suspension PVC
SS	suspended solids (content) (in water) (see also TSS)
SSBR	solution styrene butadiene rubber
STR	stirred tank reactor
Surfactant	Substance that reduces the surface tension of a liquid, used in detergents, wetting agents and foaming agents
SV	solution viscosity (SV)
SWS	sour water stripper
TBC	4-tert-butylcatechol
TFC	totally free of chlorine
THF	tetrahydrofuran
TOC	total organic carbon – a measure of organic compounds in waste waters. Does not include other reducing agents in the determination (unlike CODCr). The European standard method for total organic carbon (TOC) is: EN 1484
TMEDA	tetramethyl ethylenediamine
TPA	terephthalic acid
TS	total solids (content). Solid content before drying of the material
TSS	total suspended solids (content) (in water) (see also SS)
TWG	technical working group
UP	unsaturated polyester
USEPA	United States Environmental Protection Agency
UV	ultraviolet
VDI	Verein Deutscher Ingenieure
V.I.	viscosity index
VA	vinylacetate
VCM	vinyl chloride monomer
VKE	Verband Kunststoffherzeugende Industrie
VOC	volatile organic compounds in this document mean any organic compound having at 293.15 K a vapour pressure of 0.01 kPa or more, or having a corresponding volatility under the particular condition of use
WHB	waste heat boiler
WWTP	waste water treatment plant

COMMON UNITS, MEASUREMENTS AND SYMBOLS

TERM	MEANING
atm	normal atmosphere (1 atm = 101325 N/m ²)
bar	bar (1.013 bar = 1 atm)
°C	degree Celsius
cgs	centimetre gram second. A system of measurements now largely replaced by SI.
cm	centimetre
cSt	centistokes = 10 ⁻² stokes
d	day
g	gram
GJ	gigajoule
Hz	hertz
h	hour
ha	hectare (10 ⁴ m ²)
J	joule
K	kelvin (0 °C = 273.15 K)
kA	kiloamp(ere)
kcal	kilocalorie (1 kcal = 4.19 kJ)
kg	kilogram (1 kg = 1000 g)
kJ	kilojoule (1 kJ = 0.24 kcal)
kPa	kilopascal
kt	kilotonne
kWh	kilowatt-hour (1 kWh = 3600 kJ = 3.6 MJ)
l	litre
m	metre
m ²	square metre
m ³	cubic metre
mg	milligram (1 mg = 10 ⁻³ gram)
MJ	megajoule (1 MJ = 1000 kJ = 10 ⁶ joule)
mm	millimetre (1 mm = 10 ⁻³ m)
m/min	metres per minute
Mt	megatonne (1 Mt = 10 ⁶ tonne)
Mt/yr	megatonnes per year
mV	millivolts
MW _e	megawatts electric (energy)
MW _{th}	megawatts thermal (energy)
ng	nanogram (1 ng = 10 ⁻⁹ gram)
Nm ³	normal cubic metre (101.325 kPa, 273 K)
Pa	pascal
ppb	parts per billion
ppm	parts per million (by weight)
ppmv	parts per million (by volume)
s	second
t	metric tonne (1000 kg or 10 ⁶ gram)
t/d	tonnes per day
t/yr	tonne(s) per year
V	volt
vol-%	percentage by volume. (Also % v/v)
W	watt (1 W = 1 J/s)
wt-%	percentage by weight. (Also % w/w)
yr	year
~	around; more or less