



EUROPEAN COMMISSION

Integrated Pollution Prevention and Control (IPPC)
Reference Document on
Best Available Techniques in the Glass Manufacturing Industry
December 2001

EXECUTIVE SUMMARY

1) Introduction

This reference document on best available techniques in the glass industry reflects an information exchange carried out according to Article 16 (2) of Council Directive 96/61/EC. The document has to be seen in the light of the preface that describes the objective of the document and its use.

This document covers the industrial activities specified in Sections 3.3 and 3.4 of Annex 1 of Directive 96/61/EC, namely:

- 3.3 Installations for the manufacture of glass including glass fibre with a melting capacity exceeding 20 tonnes per day.
- 3.4 Installations for melting mineral substances including the production of mineral fibres with a melting capacity exceeding 20 tonnes per day.

For the purposes of this document the industrial activities falling within these descriptions in the Directive are referred to as the glass industry, which is considered to be comprised of eight sectors. These sectors are based on the products manufactured, but inevitably there is some overlap between them. The eight sectors are: container glass; flat glass; continuous filament glass fibre; domestic glass; special glass (including water glass); mineral wool (with two sub-sectors, glass wool and stone wool.); ceramic fibre; and frits.

The document is made up of seven chapters and a number of annexes containing supplementary information. The seven chapters and four annexes are:

- 1. General Information
- 2. Applied Processes and Techniques
- 3. Present Consumption and Emission Levels
- 4. Techniques to Consider in the Determination of BAT
- 5. BAT Conclusions
- 6. Emerging Techniques
- 7. Conclusions and Recommendations
- 8. Annex 1 Example installation emission data
- 9. Annex 2 Example sulphur balances
- 10. Annex 3 Monitoring
- 11. Annex 4 Member State Legislation

The objective of the executive summary is to summarise the main findings of the document. Due to the nature of the main document it is impossible to present all of its complexities and subtleties in such a short summary. Therefore, references are made to the main text and it should be stressed that only the main document in its entirety should be used as a reference in the determination of BAT for any particular installation. To base such decisions on the executive summary alone could lead to the information being taken out of context and to a misinterpretation of the complexities of the issues.

2) The Glass Industry

Chapter 1 provides general background information on the glass industry. Its main purpose is to provide a basic understanding of the industry as a whole to help decision makers view the information provided later in the document in context with the wider influences affecting the industry.

The glass industry within the European Union (EU) is extremely diverse, both in the products made and the manufacturing techniques employed. Products range from intricate hand-made lead crystal goblets to huge volumes of float glass produced for the construction and automotive

industries. Manufacturing techniques vary from small electrically heated furnaces in the ceramic fibre sector to cross-fired regenerative furnaces in the flat glass sector, producing up to 700 tonnes per day. The wider glass industry also includes many smaller installations that fall below the 20 tonnes per day threshold in Annex 1 to the Directive.

The glass industry is essentially a commodity industry, although many ways of adding value to high volume products have been developed to ensure the industry remains competitive. Over 80 % of the industry output is sold to other industries, and the glass industry as a whole is very dependent on the building industry, and the food and beverage industry. However, some of the smaller volume sectors produce high value technical or consumer products.

The total production of the glass industry within the EU in 1996 was estimated at 29 million tonnes (excluding ceramic fibres and frits), an indicative breakdown by sector is given in the table below.

Sector	% of Total EU Production (1996)
Container Glass	60
Flat Glass	22
Continuous Filament Glass Fibre	1.8
Domestic Glass	3.6
Special Glass	5.8
Mineral Wool	6.8

Approximate sector based breakdown of glass industry production (excluding ceramic fibre and frit sectors)

Chapter 1 provides information for each sector under the following headings: sector overview, products and markets, commercial and financial considerations, and main environmental issues. Due to the diversity of the industry the information given is very different for each sector. As an illustrative example the information given for the container glass sector is summarised in the paragraph below. Comparable information is provided for all sectors where available.

Container glass production is the largest sector of the EU glass industry, representing around 60 % of the total glass production. The sector covers the production of glass packaging i.e. bottles and jars although some machine made tableware may also be produced in this sector. In 1997 the sector produced over 17.3 million tonnes of glass products from the 295 furnaces operating in the EU. There are approximately 70 companies with 140 installations. Container glass is produced in all Member States with the exception of Luxembourg. The beverage sector accounts for approximately 75 % of the total tonnage of glass packaging containers. The main competition is from alternative packaging materials steel, aluminium, cardboard composites and plastics. A significant development within the sector has been the increased use of recycled glass. The average rate of utilisation of post consumer waste within the EU container glass sector is approximately 50 % of total raw material input, with some installations utilising up to 90 % waste glass.

3) Applied Processes

Chapter 2 describes the processes and manufacturing techniques commonly encountered in the glass industry. Most processes can be divided into five basic stages: materials handling; melting; forming; downstream processing and packaging.

The diversity of the glass industry results in the use of a wide range of raw materials. The techniques used for materials handling are common to many industries and are described in Section 2.1 of the BREF. The main issue is the control of dust from the handling of fine materials. The main raw materials for melting are glass forming materials (e.g. silica sand, cullet), intermediate/modifying materials (e.g. soda ash, limestone, feldspar) and colouring/decolouring agents (e.g. iron chromite, iron oxide).

Melting, the combination of the individual raw materials at high temperature to form a molten glass, is the central phase in the production of glass. The melting process is a complex combination of chemical reactions and physical processes, and melting can be divided into several stages: heating; primary melting; fining and homogenisation; and conditioning.

The main melting techniques are summarised below. Different techniques are used within the stone wool and frits sectors, and these techniques are described in detail in the main document. Glass making is a very energy intensive activity and the choice of energy source, heating technique and heat recovery method are central to the design of the furnace. The same choices are also some of the most important factors affecting the environmental performance and energy efficiency of the melting operation. The three main energy sources for glass making are natural gas, fuel oil and electricity.

Regenerative furnaces utilise regenerative heat recovery systems. Burners are usually positioned in or below combustion air/waste gas ports. The heat in the waste gases is used to preheat air prior to combustion, by passing the waste gases through a chamber containing refractory material, which absorbs the heat. The furnace only fires on one side at a time. After about twenty minutes, the firing is reversed and the combustion air is passed through the chamber previously heated by the waste gases. Preheat temperatures up to 1400 °C may be attained leading to very high thermal efficiencies. In the cross-fired regenerative furnace, combustion ports and burners are positioned along the sides of the furnace, and the regenerator chambers are located either side of the furnace. In the end-fired regenerative furnace the principles of operation are the same, however, the two regenerative chambers are situated at one end of the furnace.

Recuperative furnaces utilise heat exchangers (termed recuperators) for heat recovery, with continuous preheat of combustion air by the waste gases. Air preheat temperatures are limited to around 800 °C for metallic recuperators. The specific melting capacity (per unit of melter area) of recuperative furnaces is around 30 % lower than for a regenerative furnace. The burners are located along each side of the furnace, transverse to the flow of glass, and fire continuously from both sides. This type of furnace is primarily used where high flexibility of operation is required with minimum initial capital outlay, particularly where the scale of operation is too small to make the use of regenerators economically viable. It is more appropriate to small capacity installations although higher capacity furnaces (up to 400 tonnes per day) are not uncommon.

Oxy-fuel firing involves the replacement of the combustion air with oxygen (>90 % purity). The elimination of the majority of the nitrogen from the combustion atmosphere reduces the volume of the waste gases by about two thirds. Therefore, furnace energy savings are possible because it is not necessary to heat the atmospheric nitrogen to the temperature of the flames. The formation of thermal NO_x is also greatly reduced. In general, oxy-fuel furnaces have the same basic design as unit melters, with multiple lateral burners and a single waste gas exhaust port. However, furnaces designed for oxygen combustion do not utilise heat recovery systems to pre-heat the oxygen supply to the burners.

Electric furnaces consist of a refractory lined box supported by a steel frame, with electrodes inserted either from the side, the top or more usually the bottom of the furnace. Energy for melting is provided by resistive heating as the current passes through the molten glass. The technique is commonly applied in small furnaces particularly for special glass. There is an upper size limit to the economic viability of electric furnaces, which depends on the cost of electricity compared with fossil fuels. The replacement of fossil fuels in the furnace eliminates the formation of combustion products.

Combined fossil fuel and electric melting can take two forms: predominantly fossil fuel firing with electric boost; or predominantly electrical heating with a fossil fuel support. Electric boosting is a method of adding extra heat to a glass furnace by passing an electric current

through electrodes in the bottom of the tank. A less common technique is the use of gas or oil as a support fuel for a principally electrically heated furnace.

Discontinuous batch melters are used where smaller amounts of glass are required, particularly if the glass formulation changes regularly. In these instances pot furnaces or day tanks are used to melt specific batches of raw material. Many glass processes of this type would not fall under the control of IPPC because they are likely to be less than 20 tonnes per day melting capacity. Basically a pot furnace consists of a lower section to preheat the combustion air and an upper section which holds the pots and serves as the melting chamber. Day tanks are further developed from pot furnaces to have larger capacities, in the region of 10 tonnes per day. Structurally they more closely resemble the quadrangle of a conventional furnace, but are still refilled with batch each day.

Special melter designs have been produced to improve efficiency and environmental performance. The best known of this type of furnace are the LoNO_x melter and the Flex Melter.

Aspects of the main process and techniques used within the industry are outlined for each sector in the paragraphs below.

Container glass is a diverse sector and almost all of the melting techniques described above are found. The forming process is carried out in two stages, the initial forming of the blank either by pressing with a plunger, or by blowing with compressed air, and the final moulding operation by blowing to obtain the finished hollow shape. These two processes are thus respectively termed "press and blow" and "blow and blow". Container production is almost exclusively by IS (Individual Section) machines.

Flat glass is produced almost exclusively with cross-fired regenerative furnaces. The basic principle of the float process is to pour the molten glass onto a bath of molten tin, and to form a ribbon with the upper and lower surfaces becoming parallel under the influence of gravity and surface tension. From the exit of the float bath the glass ribbon is passed through the annealing lehr, gradually cooling the glass to reduce residual stresses. On-line coatings can be applied to improve the performance of the product (e.g. low emissivity glazing).

Continuous filament glass fibre is produced using recuperative or oxy-fuel fired furnaces. The glass flows from the furnace to the forehearth where it passes through bushings at the base. The glass is drawn through the bushing tips to form continuous filaments. The filaments are drawn together and pass over a roller or belt, which applies an aqueous coating to each filament. The coated filaments are gathered together into bundles (strands) for further processing.

Domestic glass is a diverse sector involving a wide range of products and processes. Ranging from intricate handmade lead crystal, to high volume, mechanised methods used for mass produced tableware. Almost all of the melting techniques, described above are used in the sector, from pot furnaces to large regenerative furnaces. The forming processes are automatic processing, hand made or semi-automatic processing, and following production the basic items can be subjected to cold finishing operations (e.g. lead crystal is often cut and polished).

Special glass is also a very diverse sector, covering a wide range of products that can differ considerably in composition, method of manufacture and use. The most common techniques are recuperative furnaces, oxy-gas furnaces, regenerative furnaces, electric melters and day tanks. The wide product range means that many forming techniques are used within the sector. Some of the most important are: press and blow production; rolling; pressing, ribbon process; tube extrusion; the drawing process; and dissolution (water glass).

Glass wool furnaces are usually either electric melters, gas fired recuperative furnaces, or oxy-fuel furnaces. Molten glass flows along a forehearth and through single orifice bushings into rotary centrifugal spinners. Fiberising is by centrifugal action with attenuation by hot flame gases. An aqueous phenolic resin solution is sprayed onto the fibres. The resin coated fibre is drawn

under suction onto a moving conveyor and then passes through an oven to dry and cure the product.

Stone wool is usually produced with the coke fired hot blast cupola. The molten material gathers in the bottom of the furnace and flows out along a short trough onto the spinning machine. Air is used to attenuate the fibres and to direct them onto the collection belts. An aqueous phenolic resin solution is sprayed onto the fibres by a series of spray nozzles. The remainder of the process is essentially as for glass wool.

Ceramic fibre is produced exclusively using electric furnaces. The melt is fiberised either by high speed wheels or a high pressure air jet, and the fibres are drawn on to a collection belt. The product can be baled at this point or processed into blanket to be baled as product or needle felted. Further downstream processing may also be carried out.

Frit production utilises both continuous furnaces and batch furnaces. It is common for small batches to be produced for a wide range of formulations. Frit furnaces are generally natural gas or oil fired, and many frit plants use oxy-fuel firing. Continuous furnaces can be cross-fired or end-fired with a single burner. Discontinuous batch furnaces are box shaped or cylindrical refractory lined vessels, mounted to allow a degree of rotation. The melt can be quenched directly in a water bath, or can be cooled between water cooled rollers to produce a flake product.

4) Consumption and Emission Levels

Chapter 3 provides information on the ranges of consumption and emission levels that are encountered within the glass industry across the scope of processes and techniques described in Chapter 2. The inputs and outputs are discussed for the industry as a whole, and then a more specific consideration is made for each sector. The key emission characteristics, emission sources and energy issues are identified in this chapter. The information is intended to allow the emission and consumption figures for any particular installation being considered for a permit, to be viewed in context against other processes in the same sector or in the glass industry as a whole.

The core process inputs can be divided into four main categories: raw materials (those materials which form part of the product), energy (fuels and electricity), water, and ancillary materials (processing aids, cleaning materials, water treatment chemicals, etc). Glass industry raw materials are largely solid inorganic compounds, either naturally occurring minerals or man-made products. They vary from very coarse materials to finely divided powders. Liquids and gases are also widely used, both as ancillary materials and as fuels.

In the main document Table 3.1 lists the most common raw materials used for the production of glass. The raw materials used in product forming and other downstream activities (e.g. coatings and binders) are more specific to each sector and are discussed in later sections. The glass industry as a whole is not a major consumer of water, the main uses being cooling, cleaning and batch humidification. Glass making is an energy intensive process and therefore fuels can form a significant input to the processes. The main energy sources within the glass industry are fuel oil, natural gas and electricity. Energy and fuel issues are discussed in Section 3.2.3 and in the sector specific sections.

The core process outputs can be divided into five main categories: product, emissions to air, liquid waste streams, solid process residues, and energy.

All of the sectors within the glass industry involve the use of powdered, granular or dusty raw materials. The storage and handling of these materials represents a significant potential for dust emissions.

The major environmental challenges for the glass industry are emissions to air and energy consumption. Glass making is a high temperature, energy intensive activity, resulting in the

Executive Summary

emission of products of combustion and the high temperature oxidation of atmospheric nitrogen; i.e. sulphur dioxide, carbon dioxide, and oxides of nitrogen. Furnace emissions also contain dust and lower levels of metals. It is estimated that in 1997 the glass industry emissions to air consisted of: 9000 tonnes of dust; 103500 tonnes of NO_x; 91500 tonnes of SO_x; and 22 million tonnes of CO₂ (including electrical generation). This amounted to around of 0.7 % of total EU emissions of these substances. Total energy consumption by the glass industry was approximately 265 PJ. The main emissions arising from melting activities within the glass industry are summarised in the table below.

Emission	Source / Comments
Particulate matter	Condensation of volatile batch components. Carry over of fine material in the batch. Product of combustion of some fossil fuels.
Oxides of Nitrogen	Thermal NO _x due to high melter temperatures. Decomposition of nitrogen compounds in the batch materials. Oxidation of nitrogen contained in fuels.
Oxides of Sulphur	Sulphur in fuel. Decomposition of sulphur compounds in the batch materials. Oxidation of hydrogen sulphide in hot blast cupola operations.
Chlorides/HCl	Present as an impurity in some raw materials, particularly man made sodium carbonate. NaCl used as a raw material in some special glasses.
Fluorides/HF	Present as a minor impurity in some raw materials. Added as a raw material in the production of enamel frit to provide certain properties in the finished product. Added as a raw material in the continuous filament glass fibre industry, and in some glass batches to improve melting, or to produce certain properties in the glass e.g. opalescence. Where fluorides are added to the batch, typically as fluorspar, uncontrolled releases can be very high.
Heavy Metals (e.g. V, Ni, Cr, Se, Pb, Co, Sb, As, Cd)	Present as minor impurities in some raw materials, post consumer cullet, and fuels. Used in fluxes and colouring agents in the frit industry (predominantly lead and cadmium). Used in some special glass formulations (e.g. lead crystal and some coloured glasses). Selenium is used as a colorant (bronze glass), or as a decolourising agent in some clear glasses.
Carbon Dioxide	Combustion product. Emitted after decomposition of carbonates in the batch materials (e.g. soda ash, limestone).
Carbon Monoxide	Product of incomplete combustion, particularly in hot blast cupolas.
Hydrogen Sulphide	Formed from raw material or fuel sulphur in hot blast cupolas due to the reducing conditions found in parts of the furnace.

Summary of emissions to atmosphere arising from melting activities

The emissions from downstream activities can vary greatly between the different sectors and are discussed in the sector specific sections. Although there are similarities in the melting techniques used in many sectors the downstream activities tend to be specific. Emissions to air can arise from: coating application and/or drying; secondary processing (e.g. cutting, polishing, etc); and from some product forming operations (e.g. mineral wool, and ceramic fibre).

In general, emissions to the water environment are relatively low and there are few major issues that are specific to the glass industry. However, there are activities undertaken in some sectors which require further consideration and are discussed in the sector specific sections, particularly domestic glass, special glass and continuous filament glass fibre.

A characteristic of most of the sectors is that the great majority of internally generated glass waste is recycled back to the furnace. The main exceptions to this are the continuous filament sector, the ceramic fibre sector and producers of very quality sensitive products in the special glass and domestic glass sectors. The mineral wool and frits sectors show a wide variation in the amount of waste recycled to the furnace ranging from nothing to 100 % for some stone wool plants.

5) Techniques for Consideration in the Determination of BAT

Many of the sectors within the glass industry utilise large continuous furnaces with lifetimes up to twelve years. These furnaces represent a large capital commitment and the continuous operation of the furnace and the periodic rebuild provide a natural cycle of investment in the process. Major changes of melting technology are most economically implemented if coincided with furnace rebuilds, and this can also be true for complex secondary abatement measures. However, many improvements to the operation of the furnace, including the installation of secondary techniques, are possible during the operating campaign.

This summary briefly outlines the main techniques for controlling each substance emitted from melting activities and from some of the downstream operations. It concentrates predominantly on emissions to air as these are generally the most significant emissions from glass processes. Chapter 4 gives detailed descriptions of each technique and explains the emission levels achieved, the applicability of the technique, financial issues and other associated considerations.

Particulate Matter

Techniques for controlling particulate emissions include secondary measures, generally electrostatic precipitators and bag filters, and primary measures.

The electrostatic precipitator (EP) consists of a series of high voltage discharge electrodes and corresponding collector electrodes. Particles are charged and subsequently separated from the gas stream under the influence of the electric field. EPs are very effective in collecting dust in the range 0.1 μm to 10 μm , and overall collection efficiency can be 95 - 99 %. Actual performance varies depending mainly on waste gas characteristics and EP design. In principle, this technique is applicable to all new and existing installations in all sectors (except stone wool cupolas due to the risk of explosion). Costs are likely to be higher for existing plants, particularly where there are space restrictions.

In most applications a modern well designed two or three stage EP could be expected to achieve 20 mg/m^3 . Where high efficiency designs are used or where favourable conditions exist lower emission levels are often possible. Costs vary greatly, depending heavily on required performance and waste gas volume. Capital costs (including acid gas scrubbing) are generally in the range 0.5 to 2.75 million euros, with operating costs 0.03 to 0.2 million euros annually.

Bag filter systems use a fabric membrane which is permeable to gas but which will retain the dust. Dust is deposited on and within the fabric, and as the surface layer builds up it becomes the dominating filter medium. The direction of gas flow can be either from the inside of the bag to the outside, or from the outside to the inside. Fabric filters are highly efficient and a collection efficiency of 95 - 99 % would be expected. Particulate emissions between 0.1 mg/m^3 and 5 mg/m^3 can be achieved and levels consistently below 10 mg/m^3 , could be expected in most applications. The ability to achieve such low levels can be important if dusts contain significant levels of metals, and low metal emissions must be achieved.

In principle, bag filters are applicable to all new and existing installations in all sectors. However, due to their potential to blind in certain circumstances, they are not the preferred choice in all applications. In most cases there are technical solutions to these difficulties, but there may be an associated cost. Capital and operating costs are broadly comparable with EPs.

Primary control techniques are based mainly on raw material changes and furnace/firing modifications. In most applications primary techniques cannot achieve emission levels comparable with bag filters and EPs.

Oxides of Nitrogen (NO_x)

The most appropriate techniques for controlling emissions of NO_x are generally: primary measures, oxy-fuel melting, chemical reduction by fuel, selective catalytic reduction and selective non-catalytic reduction.

Primary measures can be split into two main types “conventional” combustion modifications and then special furnace designs or optimised combustion design packages. Oxy-firing is also a primary technique but is dealt with separately due to its specific nature. Conventional combustion modifications are usually based on: reduced air/fuel ratio, reduced preheat temperature, staged combustion and low NO_x burners; or a combination of these techniques. Capital costs are generally quite low and operating costs are often reduced due to reduced fuel usage and improved combustion. A great deal of progress has been made in this area, but the emission reductions achievable clearly depend on the starting point. NO_x reductions of 40 - 60 % are not uncommon and emission levels of less than 650 - 1100 mg/Nm³ have been achieved in some applications.

Special furnace designs have been developed which reduce NO_x emissions, e.g. the LoNO_x melter. These designs have been very successful but there are certain process constraints that limit their applicability. The FENIX process is a combustion optimisation package based on primary measures, that is tailored for a specific furnace. Results of 510 mg/Nm³ and around 1.1 kg/tonne of melt have been reported, but the number of examples is limited at the time of writing.

Oxy-fuel firing involves the replacement of the combustion air with oxygen. The elimination of the majority of the nitrogen from the combustion atmosphere reduces the volume of the waste gases by about two thirds. Therefore, energy savings are possible because it is not necessary to heat the atmospheric nitrogen to the temperature of the flames. The formation of thermal NO_x is greatly reduced, because the only nitrogen present in the combustion atmosphere is the residual nitrogen in the oxygen/fuel, nitrogen from nitrate breakdown, and that from any parasitic air.

The principle of oxy-fuel firing is well established and in principle can be considered as applicable to the industry as a whole. However, the technique is still considered by some sectors (particularly flat glass and domestic glass), as a developing technology with potentially high financial risk. Considerable development work is being undertaken and the technique is becoming more widely accepted as the number of plants increases. The issues surrounding this technique are very complex and are discussed in detail in Chapter 4. The economic competitiveness of the technique depends largely on the scale of energy savings (and the relative costs of alternative abatement techniques) compared with the cost of oxygen. Both the technical and economic viability of the technique are heavily dependent on site specific issues.

Chemical reduction by fuel describes those techniques where fuel is added to the waste gas stream to chemically reduce NO_x to N₂ through a series of reactions. The fuel does not burn but pyrolyses to form radicals which react with the components of the waste gas. The two main techniques that have been developed for use in the glass industry are the 3R process and the Reburning process. Both of these techniques are currently restricted to regenerative furnaces. The 3R process has been fully developed for application within the industry and the Reburning process has been run at full plant scale and has shown promising results. The 3R process can achieve emission levels of less than 500 mg/Nm³ corresponding to an increase in fuel usage of 6 - 10 %. The Reburning process is hoped to achieve comparable emission levels following development. The increased energy usage for both techniques can be greatly reduced by the use of energy recovery systems, and by combining the techniques with primary measures.

Selective catalytic reduction (SCR) involves reacting NO_x with ammonia in a catalytic bed generally at around 400 °C. Most applications in the glass industry will require a 3-stage system including dust abatement and acid gas scrubbing. Systems are normally designed to achieve 75 - 95 % reductions, and in general emission levels of less than 500 mg/Nm³ are achievable. The cost of SCR depends mainly on the waste gas volume and the desired NO_x reduction. In general, capital costs (including EP and scrubbing) are in the range 1 million to 4.5 million euros with operating costs 0.075 to 0.5 million euros annually. In principle, SCR can be applied to most processes in the glass industry and to both new and existing processes. However, there are a number of issues that can limit the applicability of the technique in certain cases. For example, the technique has not been proven for heavy fuel oil fired glass furnaces, glass wool or continuous filament glass fibre.

Selective non-catalytic reduction (SNCR) operates on the same basis as SCR but the reactions take place at higher temperature (800 - 1100°C) without the need for a catalyst. SNCR does not require dust abatement or acid gas scrubbing. Reduction efficiencies of 30 - 70 % are generally achievable, the critical factor is the availability of sufficient ammonia at the correct temperature window. Capital costs are in the range 0.2 to 1.35 million euros and operating costs from 23000 to 225000 euros per year, depending on furnace size. In principle, the technique is applicable to all glass processes including new and existing plants. The main limitation to the applicability of SNCR is whether the reagent can be introduced at a point in the waste gas system where the correct temperature can be maintained for an adequate reaction time. This is of particular relevance in existing plants and for regenerative furnaces.

Oxides of Sulphur (SO_x)

The main techniques for controlling SO_x emissions are fuel selection, batch formulation and acid gas scrubbing.

In oil fired processes the main source of SO_x is the oxidation of sulphur in the fuel. The amount of SO_x derived from the batch materials varies depending on the glass type but in general wherever oil is burned the SO_x emissions from the fuel outweigh those from the batch materials. The most obvious way to reduce SO_x emissions is to reduce the sulphur content of the fuel. Fuel oil is available in various sulphur grades (<1 %, <2 %, <3 % and >3 %), and natural gas is essentially sulphur free. The conversion to a lower sulphur content fuel does not generally result in any increased costs except the higher fuel price. The conversion to gas firing requires different burners and a range of other modifications. The prices of the various fuels vary substantially with time and between Member States, but in general lower sulphur fuels are more expensive. As explained in Chapter 5 the financial and political issues associated with fuel pricing and availability are such that fuel selection is considered to be outside the scope of this document. However, where natural gas is burned SO_x emissions will usually be lower, and where oil is burned a sulphur level of 1% or less is considered BAT. Burning higher sulphur content fuels may also represent BAT if abatement is used to achieve equivalent emission levels.

In conventional glass making, sulphates are the main source of SO_x emissions from batch materials. Sulphates are the most widely used fining agents and are also important oxidising agents. In most modern glass furnaces the levels of batch sulphates have been reduced to the minimum practicable levels, which vary depending on the glass type. The issues surrounding the reduction of batch sulphates are discussed in Section 4.4.1.1 and the issues relating to the recycling of filter/EP dust are discussed in Section 4.4.3.3.

In stone wool production important sources of SO₂ emission (in addition to coke) are the use of blast furnace slag and cement bound briquettes in the batch. The availability of low sulphur coke and slag are restricted by very limited supply within economical transport distances. Slag can generally be eliminated from most batches, with the exception of the production of limited amounts of white fibre for specific applications. The use of cement bound waste briquettes involves a balance between waste minimisation and SO_x emission reduction, which will often

depend on specific priorities and must be considered in association with the use of acid gas scrubbing. This issue is discussed extensively in chapters 4 and 5 of the main document.

The operating principles of dry and semi-dry scrubbing are the same. The reactive material (the absorbent) is introduced to, and dispersed in the waste gas stream. This material reacts with the SO_x species to form a solid, which must be removed from the waste gas stream by an electrostatic precipitator or bag filter system. The absorbents chosen to remove SO_x are also effective in removing other acidic gases. In the dry process the absorbent is a dry powder (usually Ca(OH)₂, NaHCO₃, or Na₂(CO)₃). In the semi-dry process the absorbent (usually Na₂CO₃, CaO or Ca(OH)₂) is added as a suspension or solution and water evaporation cools the gas stream. The reductions achieved with the techniques depend on a number of factors including waste gas temperature, the amount and type of absorbent added (or more precisely the molar ratio between reactant and pollutants) and the dispersion of the absorbent. Section 4.4.3.3 outlines the efficiencies obtained with various absorbents and processes.

The complete recycling of filter dust, including the sulphated waste, is often considered to be a reasonable environmental and economic option, where it is technically possible. The overall reduction of SO_x emissions is limited (by mass balance considerations) to the reduction at source obtained by substituting sulphate in the raw materials by filter dust. (Clearly this is in addition to other appropriate primary measures to reduce overall sulphur input.) Therefore, in order to reduce acid gas emissions, it may be necessary to consider an external disposal route for a portion of the collected material. The determination of what represents the best protection of the environment as a whole can often be site-specific and may involve balancing the potentially conflicting priorities of waste minimisation and SO_x emission reduction. Where this is the case a process sulphur balance will be essential in determining emission levels commensurate with BAT.

With closed loop filter dust recycling, the SO_x emission levels observed today, are generally in the range of 200 - 800 mg/Nm³ for natural gas firing and 800 - 1600 mg/ Nm³ with 1 % S fuel oil. The majority of installed SO_x scrubbing systems operate with dry lime scrubbing at a temperature of around 400 °C, which is the waste gas temperature obtained from an efficient regenerative type furnace. At these temperatures, an SO_x reduction of around 50 % can be achieved. An improved SO_x reduction rate can be reached at temperatures around 200 °C and with a humid atmosphere but this involves further considerations.

SO_x scrubbing is an extremely complex area which generated a great deal of discussion within the technical working group. It is therefore essential that the discussion and explanation presented in chapters 4 and 5 are considered in full.

Fluorides (HF) and Chlorides (HCl)

HF and HCl emissions generally arise from the volatilisation of fluorides and chlorides in the batch materials, either present as impurities, or added intentionally to provide specific product or processing characteristics to the glass. The main techniques for the reduction of these emissions are batch modification or scrubbing. Where the halides are present as impurities emissions can generally be controlled by raw material selection, although scrubbing is often used either where raw material selection is not sufficient or where scrubbing is used to control other substances. Where halides are used to impart specific characteristics there are two main approaches scrubbing or batch reformulation to achieve the same characteristics by other means. Particular successes with reformulation have been achieved in continuous filament glass fibre.

Emissions from Non-Melting Activities

Emissions from downstream processing are sector specific and are described in some detail in Section 4.5 of the main document. With the exception of the mineral wool sector emissions are generally much lower than from the melting activities. Abatement techniques are generally

based on conventional dust collection and wet scrubbing techniques with some thermal oxidation.

In mineral wool processes there is the potential for substantial emissions from the application and curing of organic resin based binder systems. The techniques for controlling these emissions are discussed in detail in Section 4.5.6 of the main document.

Emissions to Water

In general, emissions to the water environment are relatively low and there are few major issues that are specific to the glass industry. Water is used mainly for cleaning and cooling and can be readily recycled or treated using standard techniques. Specific issues of organic contamination can arise from mineral wool and continuous filament glass fibre processes. Issues of heavy metals (particularly lead) can arise from special glass, frits and domestic glass processes. The table below identifies the main potential techniques for controlling emissions to water.

<u>Physical/Chemical Treatment</u>	
• Screening	• Neutralisation
• Skimming	• Aeration
• Settlement	• Precipitation
• Centrifuge	• Coagulation and Flocculation
• Filtration	
<u>Biological Treatment</u>	
• Activated sludge	
• Biofiltration	

List of potential wastewater treatment techniques for use in the Glass Industry

Solid Waste

A characteristic of the glass industry is that most of the activities produce relatively low levels of solid waste. Most of the processes do not have significant inherent by-product streams. The main process residues are unused raw materials, waste glass that has not been converted into the product, and waste product. Other solid wastes include waste refractory and dust collected in abatement equipment or flues. Non-fibrous waste is generally readily recycled to the process and techniques are under development for recycling other wastes. The extent of waste recycling is increasing as financial incentives develop, particularly increased disposal costs. The main process residues encountered in the glass industry and the techniques used to control them are discussed in Section 4.7 of the main document.

Energy

Glass making is a very energy intensive process and the choices of energy source, heating technique and heat recovery method are central to the design of the furnace and to the economic performance of the process. The same choices are also some of the most important factors affecting the environmental performance and energy efficiency of the melting operation. In general, the energy necessary for melting glass accounts for over 75 % of the total energy requirements of glass manufacture. The cost of energy for melting is one of the largest operational costs for glass installations and there is a significant incentive for operators to reduce energy use.

The main techniques for reducing energy usage are listed below and are discussed in detail in the main document:

- Melting technique and furnace design (e.g. regenerators, recuperators, electric melting, oxy-fuel combustion, and electric boost).
- Combustion control and fuel choice (e.g. low NO_x burners, stoichiometric combustion, oil/gas firing).
- Cullet usage
- Waste heat boilers
- Cullet/batch preheating

6) Summary of BAT Conclusions

Chapter 5 presents the conclusions on the best available techniques to achieve integrated prevention and control of pollution in the glass industry. The chapter contains an introduction, a general section and then sector specific conclusions. It is intended that the “general BAT” in Chapter 5 could be used to judge the current performance of an existing installation or to judge a proposal for a new installation and thereby assist in the determination of appropriate “BAT” – based conditions for that installation. The figures presented are **not** emission limit values and should not be understood as such. The appropriate emission limit values for any specific case will need to be determined taking into account the objectives of the IPPC Directive and the local considerations.

Chapter 5 was written following a great deal of discussion and redrafting within the Technical Working Group. The context and subtleties of the conclusions are very important and it is difficult to summarise the chapter without compromising these issues and the effort and discussion that was required to get to the current position. This summary outlines the main conclusions of Chapter 5 but it is essential that the full document and particularly the full text of Chapter 5 are consulted for a full understanding.

This summary outlines some of the industry wide issues and then summarises the main general conclusions using a predominantly substance based approach. One important conclusion that came out of this work was that the glass industry is so diverse that it is often inappropriate to specify particular techniques. The general approach taken in Chapter 5 is to identify levels of performance that are indicative of the best available techniques, but at the same time acknowledging that the best way of achieving these levels of performance could differ from process to process.

General

An important characteristic of many installations in the glass industry is the periodic rebuild of the furnaces, although the extent of the rebuild can vary. There may be technical and economic advantages to co-ordinating the implementation of certain techniques until a rebuild, but this is not always the case. The rebuild cycle also means the age of a furnace is important in determining the appropriate course of action in terms of overall BAT.

The reference conditions for Chapter 5 are:

- For combustion gases: dry, temperature 0°C (273K), pressure 101.3 kPa, 8 % oxygen by volume (continuous melters), 13 % oxygen by volume (discontinuous melters). For oxy-fuel fired systems the expression of the emissions corrected to 8 % oxygen is of little value, and emissions from these systems should be discussed in terms of mass.
- For others gases (including emissions from curing and drying ovens without tail gas incineration): temperature 0°C (273 K), pressure 101.3 kPa with no correction for oxygen or water vapour concentration.

In the main document, emission levels associated with BAT are presented as ranges for both emission concentration (mg/m³) and mass emission (kg/tonne of glass melted), to allow comparison between furnace techniques and to provide an indication of the relative

environmental impact. For fossil fuel fired furnaces the relationship between mass and concentration depends predominantly on specific energy consumption for melting, but this varies considerably depending on a wide range of factors including melting technique, furnace size and glass type. For such a diverse industry it is very difficult to relate concentrations and mass emission figures directly without presenting ranges so wide as to diminish the value of numerical conclusions. Therefore, the approach taken is to give concentration figures as the basis of BAT and to use indicative conversion factors based on modern energy efficient furnaces to determine mass emission figures which “generally equate to” these concentration levels.

For the purposes of this executive summary emission levels associated with BAT are given in concentration only. The exception to this is where techniques such as oxy-firing are discussed and mass emissions are the most meaningful way of describing the performance level. For the mass per tonne of glass melted reference should be made to the discussion on conversion factors in Section 5.2 and to the sector specific sections in Chapter 5.

Particulate Matter/Dust

The conclusion regarding dust emissions was broadly comparable for all sectors and is summarised in the paragraph below. There were two minor exceptions to this conclusion. For ceramic fibre the emission level associated with BAT was considered to be less than 10 mg/Nm³ due to the nature of the particulate matter. For frit processes the general conclusion was as given below but it was acknowledged that for some installations a degree of development would be required to achieve these levels.

In general, BAT for controlling dust emissions from furnaces in the glass industry is considered to be the use of either an electrostatic precipitator or bag filter system, operating where appropriate, in conjunction with a dry or semi-dry acid gas scrubbing system. The BAT emission level associated with these techniques is 5 - 30 mg/Nm³ which generally equates to less than 0.1 kg/tonne of glass melted. Values in the lower part of the range given would generally be expected for bag filter systems. These figures are based on a typical averaging period of not less than 30 minutes and not greater than 24 hours. In some cases the application of BAT for metals emissions may result in lower emissions levels for dust.

Some opinions within the Technical Working Group differed on whether the environmental benefits of secondary abatement of dust justified the higher costs in all cases. However, the general conclusion is that on balance secondary dust abatement represents BAT for most glass furnaces, unless equivalent emissions can be achieved with primary measures. The pros and cons of primary and secondary techniques are discussed extensively in Section 4.4.1.7 and 5.2.2.

Oxides of Nitrogen

This substance proved to be one of the most difficult on which to reach firm BAT conclusions. In particular, it is difficult to ascribe general emission levels that apply to more than one sector. It is therefore essential that the figures given in this section are only viewed as an indicative summary of the conclusions presented in Chapter 5. To base any consideration of BAT permit conditions on the information in this summary without reference to the main document would be to take the figures completely out of context. This could lead to unnecessarily stringent or lenient benchmarks being used for comparison.

For oxides of nitrogen the selection of techniques that represents BAT will depend very much on the site-specific issues, in particular the melting technique used and the age of the furnace. Certain techniques may achieve different results in different applications and may incur differing costs depending on site specific conditions.

For container glass, flat glass, special glass (including water glass), mineral wool and frit processes it is considered that the emission level for oxides of nitrogen (expressed as NO₂) associated with the techniques that will generally constitute BAT is 500 - 700 mg/Nm³. Although the emission level associated with BAT is generally the same, the techniques that can be used to achieve these levels, their associated costs, and the relative difficulty of applying them vary between the sectors.

There are various situations where further considerations are necessary and the emission levels indicated above may not be appropriate. For example, where nitrates are needed, where certain recycled materials are used or where a furnace is nearing the end of its campaign. These considerations are very important and are discussed in the sector specific sections of Chapter 5.

At the time of writing the continuous filament sector is going through a transition period in NO_x control, which makes it difficult to form firm conclusions regarding BAT. The most promising technique appears to be oxy-fuel melting, although some good results have been achieved with primary measures and there are no overriding technical obstacles to the use of SNCR. In general in this sector, BAT for oxides of nitrogen (expressed as NO₂) is considered likely to be oxy-fuel melting; and the emission level associated with BAT is considered to be 0.5 - 1.5 kg/tonne of glass melted. This statement is not a firm conclusion, rather a balanced judgement based on the information available at the time of writing. It is acknowledged that the technique still carries an element of financial risk, but it is expected that the technique will become more widely accepted as BAT in the medium term. Where other techniques are practicable a comparable BAT emission level for air fuel fired furnaces is considered to be 500 - 700 mg/Nm³.

Similarly it is difficult to form firm conclusions for NO_x levels in the domestic glass sector. There are certain issues specific to the sector which affect the options for NO_x control. Some of these can be illustrated by a comparison with container glass e.g. potentially higher quality constraints; lower production volumes; smaller average furnace size; cullet restrictions; higher temperatures and longer residence times. All of these factors lead to higher specific energy consumption and increase the potential for NO_x formation. In general where electrical melting (either 100 % or predominantly electrical) is economically viable, and particularly for lead crystal, crystal glass and opal glass production the technique is considered BAT. In this case, the emission level associated with BAT would generally be 0.2 – 1.0 kg/tonne of glass melted.

Where electrical melting is not economically viable a number of other techniques could be used. The domestic glass sector utilises a wide range of furnace types and the most appropriate technique will generally be installation specific. It is envisaged that given the necessary time for development and implementation of techniques, the emission level for oxides of nitrogen (expressed as NO₂) associated with BAT will be 500 - 700 mg/Nm³ (or for oxy-fuel melting 0.5 – 1.5 kg/tonne of glass melted). This is based on the use of (or combinations of) primary measures (combustion modifications), oxy-fuel firing, SNCR, SCR or 3R/Reburning (regenerative furnaces only).

Stone wool cupolas do not generally give rise to substantial NO_x emissions and emissions less than 0.5 kg/tonne of melt can be achieved without specific controls. Where tank furnaces are used the emission level associated with BAT is considered to be equivalent to glass wool production. Ceramic fibre is produced exclusively with electric furnaces and NO_x emissions are generally significantly below 0.5 kg/tonne of melt.

Oxides of Sulphur

The determination of emission levels associated with BAT for each of the sectors is a complex subject with many inter-related and in some instances conflicting considerations. These issues are explained in detail in chapters 5 and 4 with the information presented here only an indicative summary.

A major influence is the choice of fuel and its sulphur level. Therefore, the circumstances for oil and gas firing are considered separately. Furthermore, certain formulations, particularly soda-lime glasses, require the use of sulphates in the batch, and clearly such formulations will tend to show higher unabated SO₂ emissions.

It is envisaged that in most instances BAT for dust emissions will involve the use of a dust abatement system, which will often include acid gas scrubbing, and this is taken into account in the proposed emission levels associated with BAT in Chapter 5. The sulphated waste produced can generally be recycled with the furnace raw materials to avoid the generation of a solid waste stream. However, there is a limit to the extent to which the glass can act as a sink for the sulphur and the system can rapidly reach an equilibrium where a significant amount of the sulphur recycled is re-emitted. Therefore, with full dust recycling the desulphurisation effect of the scrubber can be limited by the capacity of the glass to absorb sulphur.

In order to reduce SO₂ emissions further it may be necessary to consider an external disposal route or if practicable to reduce fuel sulphur levels.. The economically viable options for recycling the material off-site are extremely limited and the most likely disposal route is landfill, resulting in a solid waste stream. From an integrated environmental approach there is a need to consider the relative priorities of the reduction of SO₂ emissions and the potential generation of a solid waste stream. The most appropriate approach may differ from process to process and for this reason emission levels are presented for where SO₂ reduction is the priority and for where waste reduction is the priority. In practice there are many cases where the lower emission level can be achieved with full dust recycling.

The table below summarises the emission levels associated with BAT for each sector and for various situations. Again this is only an indicative summary and reference should be made to Chapter 5 to allow consideration of the complexities involved.

Sector	BAT emission levels (mgSO ₂ /Nm ³)		Comments
	gas-firing	oil-firing	
Container glass with SO ₂ reduction as priority	200 - 500	500 - 1200	
Container glass with waste minimisation as priority	< 800	< 1500	Where mass balance does not allow the figures above to be achieved.
Flat glass with SO ₂ reduction as priority	200 - 500	500 - 1200	
Flat glass with waste minimisation as priority	< 800	< 1500	Where mass balance does not allow the figures above to be achieved.
Continuous filament glass fibre	< 200	500 - 1000	If sulphates in batch, gas-firing could be up to 800. For oil-firing, upper end of range relates to dust recycling.
Domestic glass	200 - 500	500 - 1300	If low sulphate in batch, then <200 for gas-firing. Figures in upper part of ranges relate to dust recycling.
Special glass including water glass	200 - 500	500 - 1200	Figures in upper part of ranges relate to dust recycling.
Glass wool	generally <50	300 - 1000	Generally low sulphate glass.
Stone wool (coke fired) with waste minimisation and recycling as priority.	(a) < 600 (b) < 1100 (c) < 1400		(a) Stone charge (b) 45 % cement bound briquettes (c) Cement briquettes inc. filter dust
Stone wool (coke fired) with SO ₂ reduction as priority.	(a) < 200 (b) < 350 (c) < 420		(a) Stone charge (b) 45 % cement bound briquettes (c) Cement briquettes inc. filter dust
Ceramic fibre (electric melting)	< 0.5 kg/tonne melt		Electric furnaces only, concentration will be case specific.
Frits	< 200	500 - 1000	Oil firing is rare.

Indicative summary of oxides of sulphur emission levels associated with BAT (expressed as SO₂)

Other Emissions from Melting

Each of the sector-specific sections in Chapter 5 has a subsection to cover those emissions from the melting operations other than dust, NO_x, and SO_x. The most significant of these “other emissions” are generally chlorides (expressed as HCl), fluorides (expressed as HF), and metals and their compounds. Certain metals are grouped together and termed either Group 1 or Group 2. Those metals, which fall outside of these groupings are either specified individually, due to their higher toxicity, or covered only within the category of dust, because their low toxicity does not justify specific consideration. The two Groups are given in the table below.

Group 1 metals and their compounds	Group 2 metals and their compounds
Arsenic	Antimony
Cobalt	Lead
Nickel	Chromium III
Selenium	Copper
Chromium VI	Manganese
	Vanadium
	Tin

Classifications of metals and their compounds

The BAT conclusions for most sectors relating to these substances were generally equivalent. BAT for controlling these emissions is considered to be raw material selection to minimise emissions, combined with acid gas scrubbing, where appropriate. Acid gas scrubbing may not

always be necessary either to protect the abatement equipment or to achieve the figures given for SO_x. Where this is the case, acid gas scrubbing is considered to constitute BAT if the levels identified below cannot be achieved by primary measures. The emission levels associated with BAT for the pollutants specified below are considered to be:

- Chlorides (expressed as HCl) <30 mg/Nm³
- Fluorides (expressed as HF) <5 mg/Nm³
- Metals (gas + solid phase) (Group 1 + Group 2) <5 mg/Nm³
- Metals (gas + solid phase) (Group 1) <1 mg/Nm³

In the frits and special glass sectors there are some cases with potential emissions of cadmium and thallium. The emission level associated with BAT for these metals and their compounds is <0.2 mg/Nm³. For the production of continuous filament glass fibre the fluoride emission level associated with BAT is 5 - 15 mg/Nm³. The lower end of this range relates to non-fluoride added compositions and the higher end relates to added fluoride compositions.

In the stone wool sector emission levels associated with BAT are also given for carbon monoxide and hydrogen sulphide. These are <200 mg/Nm³ and < 5 mg/Nm³, respectively.

Downstream Processes

Downstream processes vary greatly depending on the specific sector and installations involved and reference should be made to the sector specific sections in Chapter 5. However, with the exception of mineral wool some indicative emission levels associated with BAT are given below. Not all substances will be encountered in all installations or sectors, and certain substances are addressed in some of the sector specific sections that are not covered here because they apply to only one sector. Notwithstanding these issues, there is some commonality in the types of techniques that could be used if secondary abatement was appropriate.

- Chlorides (expressed as HCl) <30 mg/Nm³
- Fluorides (expressed as HF) <5 mg/Nm³
- Particulates <20 mg/Nm³
- Metals (gas + solid phase) (Group 1 + Group 2) <5 mg/Nm³
- Metals (gas + solid phase) (Group 1) <1 mg/Nm³

Emissions to Water

Aqueous emissions from the activities in the glass industry are generally low and not specific to the industry. However, a number of activities can give rise to more significant aqueous emissions. The emission levels given below are generally considered to be appropriate to protecting the water environment and are indicative of the emission levels that would be achieved with those techniques generally considered to represent BAT. They do not necessarily represent levels currently achieved within the industry but are based on the expert judgement of the TWG.

- Suspended solids <30 mg/l
- Chemical oxygen demand (Note1) 100 - 130 mg/l
- Ammonia (Kjeldahl) <10 mg/l
- Sulphate <1000 mg/l
- Fluoride 15 - 25 mg/l
- Arsenic <0.3 mg/l
- Antimony <0.3 mg/l
- Barium <3.0 mg/l
- Cadmium <0.05 mg/l
- Chromium (Total) <0.5 mg/l
- Copper <0.5 mg/l

Executive Summary

• Lead (Note 2)	<0.5 mg/l
• Nickel	<0.5 mg/l
• Tin (Note 3)	<0.5 mg/l
• Zinc	<0.5 mg/l
• Phenol	<1.0 mg/l
• Boric acid	2 - 4 mg/l
• pH	6.5 - 9
• Mineral oil	<20 mg/l

(Note 1) - For the continuous filament glass fibre sector this figure is considered to be 200 mg/l. In general, chemical oxygen demand is quite low and the actual level associated with BAT may depend on the receiving water. If the receiving water is particularly sensitive levels below this figure may be required.

(Note 2) - For domestic glass processes utilising significant amounts of lead compounds, 1.0 mg/l is currently considered to be more appropriate. There are no overriding technical obstacles to the achievement of 0.5 mg/l, and given the necessary time for the development and implementation of appropriate techniques this figure will be achievable.

(Note 3) - For container glass processes utilising aqueous scrubbers for treating downstream emissions an emission level of <3 mg/l is more appropriate.

Under certain circumstances, discharge to a sewage treatment works or to other off-site treatment may also constitute BAT. Where this approach is proposed consideration should be given to the suitability of the receiving facility.

7) Project Conclusions and Recommendations

This chapter is divided into three sections: information exchange, general conclusions and recommendations for further work. The first section outlines the timescales and mechanisms for the information exchange exercise. A great deal of information was made available from industry and Member States and was generally of high quality. The available information was refined and validated during the consultation processes. It is recommended that this document be reviewed in the next 4 to 5 years.

The main general conclusions are:

- That the information exchange was successful and a high degree of agreement was reached following the second meeting of the technical working group.
- The industry is extremely diverse and it is not generally appropriate to specify a single technique as BAT in most cases.
- A great deal has been achieved in recent years to improve the environmental performance of the industry. However, further developments/improvements are expected particularly with primary techniques but also with the application of secondary techniques that have been more commonly applied in other sectors.

The main recommendations for future work are:

- A more in depth (preferably semi-quantitative) assessment of cross media issues would be beneficial.
- A more detailed consideration of the costs of techniques would be useful in determining BAT.
- When the work is reviewed a more in-depth assessment of techniques to improve energy efficiency would be useful, taking into account more recently available information.
- When the work is reviewed the progress with primary emission control methods should be reassessed.

- When the work is reviewed a reassessment should be made of those techniques which currently have some issues unproven or contested, either for the glass industry as a whole or in certain applications. In particular, sulphur dioxide removal, oxy-fuel firing and SCR.

PREFACE

1. Status of this document

Unless otherwise stated, references to “the Directive” in this document mean Council Directive 96/61/EC on integrated pollution prevention and control. This document forms part of a series presenting the results of an exchange of information between EU Member States and industries concerned on best available techniques (BAT), associated monitoring, and developments in them. It is published by the European Commission pursuant to Article 16(2) of the Directive, and must therefore be taken into account in accordance with Annex IV of the Directive when determining “best available techniques”.

2. Relevant legal obligations of the IPPC Directive and the definition of BAT

In order to help the reader understand the legal context in which this document has been drafted, some of the most relevant provisions of the IPPC Directive, including the definition of the term “best available techniques”, are described in this preface. This description is inevitably incomplete and is given for information only. It has no legal value and does not in any way alter or prejudice the actual provisions of the Directive.

The purpose of the Directive is to achieve integrated prevention and control of pollution arising from the activities listed in its Annex I, leading to a high level of protection of the environment as a whole. The legal basis of the Directive relates to environmental protection. Its implementation should also take account of other Community objectives such as the competitiveness of the Community’s industry thereby contributing to sustainable development.

More specifically, it provides for a permitting system for certain categories of industrial installations requiring both operators and regulators to take an integrated, overall look at the polluting and consuming potential of the installation. The overall aim of such an integrated approach must be to improve the management and control of industrial processes so as to ensure a high level of protection for the environment as a whole. Central to this approach is the general principle given in Article 3 that operators should take all appropriate preventative measures against pollution, in particular through the application of best available techniques enabling them to improve their environmental performance.

The term “best available techniques” is defined in Article 2(11) of the Directive as “the most effective and advanced stage in the development of activities and their methods of operation which indicate the practical suitability of particular techniques for providing in principle the basis for emission limit values designed to prevent and, where that is not practicable, generally to reduce emissions and the impact on the environment as a whole.” Article 2(11) goes on to clarify further this definition as follows:

“techniques” includes both the technology used and the way in which the installation is designed, built, maintained, operated and decommissioned;

“available” techniques are those developed on a scale which allows implementation in the relevant industrial sector, under economically and technically viable conditions, taking into consideration the costs and advantages, whether or not the techniques are used or produced inside the Member State in question, as long as they are reasonably accessible to the operator;

“best” means most effective in achieving a high general level of protection of the environment as a whole.

Furthermore, Annex IV of the Directive contains a list of “considerations to be taken into account generally or in specific cases when determining best available techniques ... bearing in mind the likely costs and benefits of a measure and the principles of precaution and prevention”.

These considerations include the information published by the Commission pursuant to Article 16(2).

Competent authorities responsible for issuing permits are required to take account of the general principles set out in Article 3 when determining the conditions of the permit. These conditions must include emission limit values, supplemented or replaced where appropriate by equivalent parameters or technical measures. According to Article 9(4) of the Directive, these emission limit values, equivalent parameters and technical measures must, without prejudice to compliance with environmental quality standards, be based on the best available techniques, without prescribing the use of any technique or specific technology, but taking into account the technical characteristics of the installation concerned, its geographical location and the local environmental conditions. In all circumstances, the conditions of the permit must include provisions on the minimisation of long-distance or transboundary pollution and must ensure a high level of protection for the environment as a whole.

Member States have the obligation, according to Article 11 of the Directive, to ensure that competent authorities follow or are informed of developments in best available techniques.

3. Objective of this Document

Article 16(2) of the Directive requires the Commission to organise “an exchange of information between Member States and the industries concerned on best available techniques, associated monitoring and developments in them”, and to publish the results of the exchange.

The purpose of the information exchange is given in recital 25 of the Directive, which states that “the development and exchange of information at Community level about best available techniques will help to redress the technological imbalances in the Community, will promote the world-wide dissemination of limit values and techniques used in the Community and will help the Member States in the efficient implementation of this Directive.”

The Commission (Environment DG) established an information exchange forum (IEF) to assist the work under Article 16(2) and a number of technical working groups have been established under the umbrella of the IEF. Both IEF and the technical working groups include representation from Member States and industry as required in Article 16(2).

The aim of this series of documents is to reflect accurately the exchange of information which has taken place as required by Article 16(2) and to provide reference information for the permitting authority to take into account when determining permit conditions. By providing relevant information concerning best available techniques, these documents should act as valuable tools to drive environmental performance.

4. Information Sources

This document represents a summary of information collected from a number of sources, including in particular the expertise of the groups established to assist the Commission in its work, and verified by the Commission services. All contributions are gratefully acknowledged.

5. How to understand and use this document

The information provided in this document is intended to be used as an input to the determination of BAT in specific cases. When determining BAT and setting BAT-based permit conditions, account should always be taken of the overall goal to achieve a high level of protection for the environment as a whole.

The rest of this section describes the type of information that is provided in each section of the document.

Chapters 1 and 2 provide general information on the industrial sector concerned and on the industrial processes used within the sector. Chapter 3 provides data and information concerning current emission and consumption levels reflecting the situation in existing installations at the time of writing.

Chapter 4 describes in more detail the emission reduction and other techniques that are considered to be most relevant for determining BAT and BAT-based permit conditions. This information includes the consumption and emission levels considered achievable by using the technique, some idea of the costs and the cross-media issues associated with the technique, and the extent to which the technique is applicable to the range of installations requiring IPPC permits, for example new, existing, large or small installations. Techniques that are generally seen as obsolete are not included.

Chapter 5 presents the techniques and the emission and consumption levels that are considered to be compatible with BAT in a general sense. The purpose is thus to provide general indications regarding the emission and consumption levels that can be considered as an appropriate reference point to assist in the determination of BAT-based permit conditions or for the establishment of general binding rules under Article 9(8). It should be stressed, however, that this document does not propose emission limit values. The determination of appropriate permit conditions will involve taking account of local, site-specific factors such as the technical characteristics of the installation concerned, its geographical location and the local environmental conditions. In the case of existing installations, the economic and technical viability of upgrading them also needs to be taken into account. Even the single objective of ensuring a high level of protection for the environment as a whole will often involve making trade-off judgements between different types of environmental impact, and these judgements will often be influenced by local considerations.

Although an attempt is made to address some of these issues, it is not possible for them to be considered fully in this document. The techniques and levels presented in chapter 5 will therefore not necessarily be appropriate for all installations. On the other hand, the obligation to ensure a high level of environmental protection including the minimisation of long-distance or transboundary pollution implies that permit conditions cannot be set on the basis of purely local considerations. It is therefore of the utmost importance that the information contained in this document is fully taken into account by permitting authorities.

Since the best available techniques change over time, this document will be reviewed and updated as appropriate. All comments and suggestions should be made to the European IPPC Bureau at the Institute for Prospective Technological Studies at the following address:

Edificio Expo-WTC, Inca Garcilaso s/n, E-41092 Seville, Spain
Telephone: +34 95 4488 284
Fax: +34 95 4488 426
e-mail: eippcb@jrc.es
Internet: <http://eippcb.jrc.es>

Reference Document on Best Available Techniques in the Glass Industry

EXECUTIVE SUMMARY	I
PREFACE	XXI
1 GENERAL INFORMATION	1
1.1 Scope of the Document	1
1.2 Introduction	2
1.2.1 Characteristics of Glass	4
1.2.2 Broad Classification of Glass Types	5
1.2.3 Historical Origins	6
1.3 Container Glass	7
1.3.1 Sector Overview	7
1.3.2 Products and Markets	8
1.3.3 Commercial and Financial Considerations	9
1.3.4 Main Environmental Issues	10
1.4 Flat Glass	10
1.4.1 Sector Overview	10
1.4.2 Products and Markets	12
1.4.3 Commercial and Financial Considerations	12
1.4.4 Main Environmental Issues	13
1.5 Continuous Filament Glass Fibre	14
1.5.1 Sector Overview	14
1.5.2 Products and Markets	15
1.5.3 Commercial and Financial Considerations	15
1.5.4 Main Environmental Issues	15
1.6 Domestic Glass	16
1.6.1 Sector Overview	16
1.6.2 Products and Markets	17
1.6.3 Commercial and Financial Considerations	18
1.6.4 Main Environmental Issues	18
1.7 Special Glass	19
1.7.1 Sector Overview	19
1.7.2 Products and Markets	19
1.7.3 Commercial and Financial Considerations	21
1.7.4 Main Environmental Issues	22
1.8 Mineral Wool	22
1.8.1 Sector Overview	22
1.8.2 Products and Markets	23
1.8.3 Commercial and Financial Considerations	24
1.8.4 Main Environmental Issues	25
1.9 Ceramic Fibre	25
1.9.1 Sector Overview	25
1.9.2 Products and Markets	26
1.9.3 Commercial Considerations	26
1.9.4 Main Environmental Issues	27
1.10 Frits	27
1.10.1 Sector Overview	27
1.10.2 Products and Markets	28
1.10.3 Commercial Considerations	28
1.10.4 Main Environmental Issues	28
2 APPLIED PROCESSES AND TECHNIQUES	31
2.1 Materials Handling	31
2.2 Glass Melting	32
2.2.1 Raw Materials for Glass Making	32
2.2.2 The Melting Process	34
2.3 Melting Techniques	36
2.3.1 Regenerative Furnaces	37

2.3.2	Recuperative Furnaces	39
2.3.3	Oxy-fuel Melting.....	40
2.3.4	Electric Melting.....	40
2.3.5	Combined Fossil Fuel and Electric Melting.....	41
2.3.6	Discontinuous Batch Melting.....	42
2.3.7	Special Melter Designs.....	42
2.4	Container Glass.....	43
2.5	Flat Glass.....	46
2.5.1	The Float Glass Process	46
2.5.2	The Rolled Process (Patterned and Wired Glass).....	48
2.6	Continuous Filament Glass Fibre.....	49
2.7	Domestic Glass.....	51
2.8	Special Glass.....	53
2.9	Mineral Wool.....	57
2.9.1	Glass Wool.....	57
2.9.2	Stone Wool.....	59
2.10	Ceramic Fibre.....	61
2.11	Frits.....	62
3	PRESENT CONSUMPTION AND EMISSION LEVELS	65
3.1	Introduction.....	65
3.2	General Glass Industry Overview.....	66
3.2.1	Process Inputs.....	66
3.2.2	Process Outputs.....	68
3.2.2.1	Emissions to Air.....	69
3.2.2.2	Emissions to Water.....	71
3.2.2.3	Emissions of Other Wastes.....	71
3.2.3	Energy.....	72
3.3	Container Glass.....	76
3.3.1	Process Inputs.....	77
3.3.2	Emissions to Air.....	78
3.3.2.1	Raw Materials.....	78
3.3.2.2	Melting.....	78
3.3.2.3	Downstream Activities.....	80
3.3.3	Emissions to Water.....	80
3.3.4	Other Wastes.....	81
3.3.5	Energy.....	81
3.4	Flat Glass.....	82
3.4.1	Process inputs.....	82
3.4.2	Emissions to Air.....	84
3.4.2.1	Raw Materials.....	84
3.4.2.2	Melting.....	84
3.4.2.3	Downstream Activities.....	85
3.4.3	Emissions to Water.....	85
3.4.4	Other Wastes.....	85
3.4.5	Energy.....	86
3.5	Continuous Filament Glass Fibre.....	86
3.5.1	Process inputs.....	87
3.5.2	Emissions to Air.....	89
3.5.2.1	Raw Materials.....	89
3.5.2.2	Melting.....	89
3.5.2.3	Downstream Activities.....	90
3.5.3	Emissions to Water.....	90
3.5.4	Other Wastes.....	91
3.5.5	Energy.....	91
3.6	Domestic Glass.....	92
3.6.1	Process inputs.....	93
3.6.2	Emissions to Air.....	95
3.6.2.1	Raw Materials.....	95
3.6.2.2	Melting.....	95
3.6.2.3	Downstream Activities.....	96
3.6.3	Emissions to Water.....	96

3.6.4	Other Wastes.....	97
3.6.5	Energy.....	97
3.7	Special Glass.....	98
3.7.1	Process inputs.....	98
3.7.2	Emissions to Air.....	101
3.7.2.1	Raw Materials.....	101
3.7.2.2	Melting.....	101
3.7.2.3	Downstream Activities.....	102
3.7.3	Emissions to Water.....	102
3.7.4	Other Wastes.....	102
3.7.5	Energy.....	102
3.8	Mineral Wool.....	103
3.8.1	Process Inputs.....	103
3.8.2	Emissions to Air.....	104
3.8.2.1	Raw Materials.....	105
3.8.2.2	Melting.....	105
3.8.2.3	Emissions from Non-Melting Activities.....	107
3.8.3	Emissions to Water.....	108
3.8.4	Other Wastes.....	108
3.8.5	Energy.....	109
3.9	Ceramic Fibre.....	110
3.9.1	Process inputs.....	110
3.9.2	Emissions to Air.....	111
3.9.2.1	Raw materials.....	111
3.9.2.2	Melting.....	111
3.9.2.3	Downstream Activities.....	111
3.9.3	Emissions to Water.....	111
3.9.4	Other Wastes.....	111
3.9.5	Energy.....	112
3.10	Frits.....	112
3.10.1	Process inputs.....	112
3.10.2	Emissions to Air.....	113
3.10.2.1	Raw materials.....	113
3.10.2.2	Melting.....	113
3.10.2.3	Downstream Activities.....	114
3.10.3	Emissions to Water.....	114
3.10.4	Other Wastes.....	114
3.10.5	Energy.....	114
4	TECHNIQUES TO CONSIDER IN THE DETERMINATION OF BAT.....	117
4.1	Introduction.....	117
4.2	Melting Technique Selection.....	119
4.2.1	Electric Melting.....	121
4.3	Techniques for Materials Handling.....	124
4.4	Techniques for Controlling Emissions to Air from Melting Activities.....	125
4.4.1	Particulate Matter.....	125
4.4.1.1	Primary Techniques.....	127
4.4.1.2	Electrostatic Precipitators.....	132
4.4.1.3	Bag Filters.....	136
4.4.1.4	Mechanical Collectors.....	139
4.4.1.5	High Temperature Filter Media.....	140
4.4.1.6	Wet Scrubbers.....	140
4.4.1.7	Summary of Considerations of Techniques in Section 4.4.1.....	141
4.4.2	Oxides of Nitrogen (NO _x).....	143
4.4.2.1	Combustion Modifications.....	143
4.4.2.2	Batch Formulation.....	147
4.4.2.3	Special Furnace Designs.....	148
4.4.2.4	The FENIX process.....	150
4.4.2.5	Oxy-Fuel Melting.....	151
4.4.2.6	Chemical Reduction by Fuel (CRF).....	159
4.4.2.7	Selective Catalytic Reduction (SCR).....	164
4.4.2.8	Selective Non-Catalytic Reduction (SNCR).....	169

4.4.2.9 Comparison of NO _x Abatement Technique Costs.....	171
4.4.3 Oxides of Sulphur (SO _x).....	174
4.4.3.1 Fuel Selection	175
4.4.3.2 Batch Formulation	176
4.4.3.3 Dry or Semi-dry Scrubbing.....	177
4.4.4 Fluorides (HF) and Chlorides (HCl).....	184
4.4.4.1 Reduction at Source	184
4.4.4.2 Scrubbing Techniques.....	186
4.4.5 Oxides of Carbon	186
4.5 Techniques for Controlling Emissions to Air from Non Melting Activities	187
4.5.1 Container Glass	187
4.5.2 Flat Glass.....	188
4.5.3 Continuous Filament Glass Fibre	189
4.5.4 Domestic Glass.....	190
4.5.5 Special Glass	190
4.5.6 Mineral Wool	190
4.5.6.1 Forming Area.....	191
4.5.6.2 Curing Oven.....	200
4.5.6.3 Product Cooling	204
4.5.6.4 Product Machining and Packaging.....	204
4.5.6.5 Odours Arising from Mineral Wool Production	205
4.5.7 Ceramic Fibre.....	207
4.5.8 Frits	208
4.6 Techniques for Controlling Emissions to Water	208
4.7 Techniques for Minimising Other Wastes	211
4.8 Energy	212
4.8.1 Melting Technique and Furnace Design.....	213
4.8.2 Combustion Control and Fuel Choice	215
4.8.3 Cullet Usage	215
4.8.4 Waste Heat Boiler	217
4.8.5 Batch and Cullet Preheating	217
5 BAT CONCLUSIONS	220
5.1 Introduction	220
5.2 General	221
5.2.1 Materials Storage and Handling	223
5.2.2 Particulate Matter	223
5.2.3 Oxides of Sulphur.....	224
5.2.4 Other Substances.....	224
5.3 Container Glass	225
5.3.1 Dust.....	225
5.3.2 Oxides of Nitrogen	225
5.3.3 Oxides of Sulphur.....	225
5.3.4 Other Emissions from Melting.....	226
5.3.5 Downstream Processes	226
5.4 Flat Glass	227
5.4.1 Dust.....	227
5.4.2 Oxides of Nitrogen	227
5.4.3 Oxides of Sulphur.....	227
5.4.4 Other Emissions from Melting.....	228
5.4.5 Downstream Processes	228
5.5 Continuous Filament Glass Fibre	228
5.5.1 Dust.....	228
5.5.2 Oxides of Nitrogen	229
5.5.3 Oxides of Sulphur.....	229
5.5.4 Other Emissions from Melting.....	230
5.5.5 Downstream Processes	230
5.6 Domestic Glass	230
5.6.1 Dust.....	230
5.6.2 Oxides of Nitrogen	231
5.6.3 Oxides of Sulphur.....	232
5.6.4 Other Emissions from Melting.....	232

5.6.5	Downstream Processes	232
5.7	Special Glass	233
5.7.1	Dust.....	233
5.7.2	Oxides of Nitrogen.....	233
5.7.3	Oxides of Sulphur	234
5.7.4	Other Emissions from Melting.....	234
5.7.5	Downstream Processes	234
5.8	Mineral Wool	235
5.8.1	Dust.....	235
5.8.2	Oxides of Nitrogen.....	235
5.8.3	Oxides of Sulphur	235
5.8.4	Other Emissions from Melting.....	236
5.8.5	Downstream Processes.	237
5.9	Ceramic Fibre	238
5.9.1	Melting.....	238
5.9.2	Downstream Processing.....	238
5.10	Frits	239
5.10.1	Dust.....	239
5.10.2	Oxides of Nitrogen.....	239
5.10.3	Oxides of Sulphur	239
5.10.4	Other Emissions from Melting.....	239
5.10.5	Downstream Processes.	240
5.11	Emissions to Water	240
5.12	Other Wastes	241
6	EMERGING TECHNIQUES	243
6.1	Low NO _x Burner Systems	243
6.2	Oxy-fuel melting	244
6.3	Cullet and Batch Preheating	244
6.4	Batch Formulations	244
6.5	Integration of Frit Processes	245
6.6	Flue Gas Recirculation	245
6.7	Glasulin Research Program	245
6.8	New Melter Designs	246
6.8.1	The Seg-Melter	246
6.8.2	The Advanced Glass Melter	246
6.8.3	The Plasma Melter	246
7	CONCLUDING REMARKS	248
7.1	Information Exchange	248
7.2	General Conclusions	248
7.3	Recommendations for Further Work	249
8	ANNEX I: EXAMPLE INSTALLATION EMISSION DATA.....	251
8.1	Container Glass Sector	251
8.2	Flat Glass Sector	252
8.3	Continuous Filament Glass Fibre Sector	253
8.4	Domestic Glass Sector	254
8.5	Special Glass Sector	255
8.6	Mineral Wool Sector	256
9	ANNEX II: EXAMPLE SULPHUR BALANCES FOR INDUSTRIAL GLASS FURNACES	259
10	ANNEX III: EMISSION MONITORING.....	261
10.1	Main Pollutants	261
10.2	Monitoring of Emissions	262
11	ANNEX IV: NATIONAL LEGISLATION	269
	GLOSSARY	283
	REFERENCES	285

List of tables

Table 1.1: Approximate sector based breakdown of Glass Industry production.....	3
Table 1.2: Major producers of container glass in EU (1997).....	7
Table 1.3: Distribution of container glass installations in Member States.....	8
Table 1.4: Number of container glass installations in specified production ranges.....	8
Table 1.5: Locations of float tanks in the EU in 1997.....	11
Table 1.6: Number of float tanks in Member States in 1997.....	11
Table 1.7: Percentage of float capacity in specified ranges.....	11
Table 1.8: Number of continuous filament installations and furnaces in Member States.....	14
Table 1.9: Number of continuous filament furnaces in specified production ranges.....	14
Table 1.10: Number and distribution of domestic glass installations in Member States in 1997.....	17
Table 1.11: Number of domestic glass installations in specified production ranges (estimated).....	17
Table 1.12: Special Glass Sector breakdown.....	20
Table 1.13: Distribution of special glass production in EU.....	21
Table 1.14: Investment costs for special glass installations.....	22
Table 1.15: Number of mineral wool installations in Member States.....	23
Table 1.16: Number of mineral wool installations in specified production ranges.....	23
Table 1.17: Distribution of ceramic fibre installations in Member States.....	26
Table 1.18: Distribution of frit installations in Member States (estimated).....	27
Table 1.19: Number of frit installations in specified production ranges (estimates).....	27
Table 2.1: Important glass making raw materials.....	32
Table 2.2: Elements used to impart colour.....	33
Table 2.3: Estimate of EU furnace types in 1997 [tm18 CPIV].....	36
Table 2.4: Typical container glass composition.....	43
Table 2.5: Typical flat glass composition.....	46
Table 2.6: Typical E Glass composition.....	49
Table 2.7: Chemical composition of the main products of the Special Glass Sector.....	56
Table 2.8: Typical mineral wool compositions.....	57
Table 2.9: Chemical composition of typical refractory ceramic fibres in weight percent.....	61
Table 3.1: Common raw materials utilised in the Glass Industry [tm18 CPIV].....	68
Table 3.2: Summary of emissions to atmosphere arising from melting activities.....	70
Table 3.3: Potential heavy metal emissions from glass processes.....	71
Table 3.4: Theoretical energy requirements for melting common glass formulations.....	73
Table 3.5: Examples of specific energy consumption for a range of glass furnaces.....	75
Table 3.6: Overview of Container Glass Sector inputs and outputs [tm18 CPIV].....	76
Table 3.7: Materials utilised in the Container Glass Sector (CPIV Jan98).....	77
Table 3.8: Total emission ranges reported for Container Glass Sector furnaces with primary and secondary abatement measures.....	79
Table 3.9: Mid 80 percentile emission ranges for Container Glass Sector furnaces with primary and secondary abatement measures.....	80
Table 3.10: Materials utilised in the Flat Glass Sector.....	83
Table 3.11: Emission levels from unabated and abated flat glass furnaces.....	84
Table 3.12: Overview of Continuous Filament Glass Fibre Sector inputs and out puts [tm18 CPIV].....	87
Table 3.13: Materials utilised in the Continuous Filament Glass Fibre Sector.....	88
Table 3.14: Emission levels from continuous filament glass fibre furnaces.....	89
Table 3.15: Overview of Domestic Glass Sector inputs and outputs.....	93
Table 3.16: Materials utilised in the Domestic Glass Sector.....	94
Table 3.17: Summary of emissions to air from domestic glass furnaces.....	96
Table 3.18: Materials utilised in the Special Glass Sector.....	99
Table 3.19: Overview of inputs and out puts for an example water glass process [tm28 EMPA].....	99
Table 3.20: Overview of inputs and out puts for an example TV funnel glass process.....	100
Table 3.21: Overview of inputs and out puts for an example TV panel glass process (SCR fitted for NOx reduction).....	100
Table 3.22: Materials utilised in the Mineral Wool Sector.....	103
Table 3.23: Mineral wool process exhaust gas volumes.....	105
Table 3.24: Full range of emissions from mineral wool melting activities.....	106
Table 3.25: Middle 80 % of emissions from mineral wool melting activities.....	106
Table 3.26: Full range of mineral wool line emissions in mg/m ³	107
Table 3.27: Middle 80 % range of mineral wool line emissions.....	108
Table 3.28: Mineral Wool Sector solid waste generation and disposal.....	109

Table 3.29: Energy use in mineral wool production.....	109
Table 3.30: Materials utilised in the Ceramic Fibre Sector	110
Table 3.31: Main raw materials utilised in frit production	113
Table 3.32: Emission levels from frit furnaces.....	114
Table 4.1: Main advantages and disadvantages of electric melting.....	124
Table 4.2: Main advantages and disadvantages of primary techniques for dust reduction.....	132
Table 4.3: Costs of electrostatic precipitators with acid gas scrubbing [tm32 Beerkens].....	134
Table 4.4: Main advantages and disadvantages of electrostatic precipitators.....	136
Table 4.5: Main advantages and disadvantages of bag filters.....	139
Table 4.6: Main advantages and disadvantages of cyclones.....	140
Table 4.7: Main advantages and disadvantages of combustion modifications	147
Table 4.8: Main advantages and disadvantages of oxy-fuel melting	158
Table 4.9: The main advantages and disadvantages of the 3R Process	161
Table 4.10: Costs of SCR with electrostatic precipitators and acid gas scrubbing	166
Table 4.11: Main advantages and disadvantages of SCR	168
Table 4.12: Costs of SNCR	170
Table 4.13: Main advantages and disadvantages of SNCR.....	171
Table 4.14: Capital costs for abatement techniques.....	173
Table 4.15: Annual operating costs for abatement techniques	173
Table 4.16: Specific costs for the abatement techniques in euros/tonne glass.....	174
Table 4.17: Costs of oxy-fuel melting (euros/tonne of glass) for two oxygen prices	174
Table 4.18: Indicative SOx emissions in glass furnace waste gas for different fuels	175
Table 4.19: Variations in EU energy prices – source (CPIV).....	176
Table 4.20: Dry absorption efficiencies for Ca(OH) ₂ (Indicative figures)	178
Table 4.21: SOx abatement rates for dry scrubbing with Ca(OH) ₂	178
Table 4.22: SOx abatement rates for dry scrubbing with Na ₂ CO ₃	179
Table 4.23: SOx abatement rates for semi-dry scrubbing with Na ₂ CO ₃ solution	179
Table 4.24: SOx abatement rates for semi-dry scrubbing with Ca(OH) ₂	179
Table 4.25: Main advantages and disadvantages of dry and semi-dry scrubbing.....	184
Table 4.26: Main advantages and disadvantages of wet EPs.....	198
Table 4.27: Main advantages and disadvantages of stone wool filters	200
Table 4.28: Main advantages and disadvantages of incineration.....	204
Table 4.29: General achievable values for line emissions to air (mg/Nm ³).....	206
Table 4.30: Investment and operating costs of abatement techniques	207
Table 4.31: List of potential wastewater treatment techniques for use in the Glass Industry	210
Table 5.1: Indicative conversion factors for mg/m ³ to kg/tonne of glass melted ⁽¹⁾	223
Table 5.2: Classifications of metals and their compounds.....	224
Table 10.1: Main pollutants likely to be considered for measurement in the Glass Industry	261
Table 10.2: Continuous monitoring techniques	265
Table 10.3: Mass flows for continuous monitoring (France and Germany)	265
Table 10.4: Discontinuous monitoring techniques	266

List of figures

Figure 1.1: Total glass production 1986 to 1996 (*excluding frits and ceramic fibres).....	3
Figure 2.1: A cross-fired regenerative furnace.....	38
Figure 2.2: Cross section of a regenerative furnace	38
Figure 2.3: Single pass end-fired regenerative furnace	39
Figure 2.4: Plan view of end-fired regenerative furnace.....	39
Figure 2.5: Press and blow forming and blow and blow forming	44
Figure 2.6: The Float Glass Process.....	47
Figure 2.7: The Rolled Glass Process	48
Figure 2.8: The pressing process for the formation of glass articles.....	52
Figure 2.9: The spinning process for the formation of glass articles.....	52
Figure 2.10: A typical glass wool plant.....	57
Figure 2.11: A typical mineral wool process water circuit.....	59
Figure 2.12: A typical stone wool plant	59
Figure 3.1: Energy usage in a typical container glass plant	82
Figure 3.2: Energy usage for a typical float glass process	86
Figure 3.3: Energy usage in a typical continuous filament glass fibre process	92
Figure 3.4: Energy usage in lead crystal manufacture (pot furnace).....	98
Figure 4.1: Reburn Process Overview.....	162

1 GENERAL INFORMATION

1.1 Scope of the Document

This document covers the industrial activities specified in Sections 3.3 and 3.4 of Annex 1 of Directive 96/61/EC, namely:

- 3.3 Installations for the manufacture of glass including glass fibre with a melting capacity exceeding 20 tonnes per day.
- 3.4 Installations for melting mineral substances including the production of mineral fibres with a melting capacity exceeding 20 tonnes per day.

The types of activities falling within these categories vary widely in scale, the techniques employed, and the associated environmental issues. When determining whether an installation comes within the definitions in Annex 1 the aggregated capacity of each melting activity at the installation is considered. For the purposes of this document the melting capacity criteria of 20 tonnes per day has been taken to relate to the mass of the melt produced. This approach is not intended to pre-judge the interpretation of the definition in the Directive, rather it is intended to ensure that the information provided is consistent with the standard terminology used within the Glass Industry.

For the purposes of this document the industrial activities falling within the definitions in Sections 3.3 and 3.4 of Annex 1 of Directive 96/61/EC will be referred to as the Glass Industry, which is considered to be comprised of eight sectors. These sectors are based on the products manufactured, but inevitably there is some overlap between them. The eight sectors are:

1. Container Glass
2. Flat Glass
3. Continuous Filament Glass Fibre
4. Domestic Glass
5. Special Glass (including water glass)
6. Mineral Wool (With two sub-sectors, glass wool and stone wool.)
7. Ceramic Fibre
8. Frits

In addition to the basic manufacturing activities this document covers the directly associated activities which could have an effect on emissions or pollution. Thus the document includes activities from receipt of raw materials through production of any intermediates to dispatch of finished products. Certain activities are not covered, because they are not considered to be directly associated with the primary activity. For example, the subsequent processing of flat glass into other products (e.g. double-glazing or automotive products) is not covered. Again this approach is not intended to pre-judge the interpretation of the Directive by Member States. The activities covered include:

- Raw materials handling and storage.
- Mixing and transfer.
- Melting and refining.
- Forming (e.g. float bath, rolling, pressing, blowing, fiberising, frit quenching).
- Conditioning (e.g. Lehr, annealing, tempering).
- Coating, including binder and lubricant application.
- Surface treatments (e.g. acid polishing).
- Curing and drying activities.
- Milling.
- Machining, cutting and packaging.
- Waste storage, handling, and processing.

1.2 Introduction

[tm18 CPIV, CPIV stats, EURIMA stats]

The Glass Industry within the European Union (EU) is extremely diverse, both in the products made and the manufacturing techniques employed. Products range from intricate hand-made lead crystal goblets to the huge volumes of float glass produced for the construction and automotive industries. Manufacturing techniques vary from the small electrically heated furnaces in the Ceramic Fibre Sector to the cross-fired regenerative furnaces in the Flat Glass Sector, producing up to 700 tonnes per day. The wider Glass Industry also includes many smaller installations that fall below the 20 tonnes per day threshold. However, for some of the statistical data given in this chapter it has not been possible to separate out the contribution from the smaller plants, but this is not considered significant since they account for less than 5 % of the total industry output.

The Glass Industry is essentially a commodity industry, although many ways of adding value to high volume products have been developed to ensure the industry remains competitive. Over 80 % of the industry output is sold to other industries, and the Glass Industry as a whole is very dependent on the building, and the food and beverage industries. However, this general picture is not true for all of its components, as some of the smaller volume sectors produce high value technical or consumer products.

In the late nineteen nineties, the Glass Industry is continuing a period of reorganisation. In order to reduce costs and compete more effectively in a global market, and to benefit from economies of scale companies are merging together and the number of independent operators is falling. The groups that dominate the industry are becoming more international in their operations, and users are increasingly requiring homogeneous quality, regardless of the country where the products are used. The EU Glass Industry is at the forefront of technological developments and thus is likely to benefit from improved industrial performance in future years.

With the notable exception of Saint-Gobain, there are few major companies operating in more than two of the eight sectors specified in the previous section. For example, the Owens Corning Corporation specialises in glass fibre technology, continuous filament glass fibre and glass wool. PPG is a large international producer of flat glass and continuous filament glass fibre. And the Pilkington Group specialises mainly in flat glass activities.

The major environmental challenges for the Glass Industry are emissions to air and energy consumption. Glass making is a high temperature, energy intensive activity, resulting in the emission of products of combustion and the high temperature oxidation of atmospheric nitrogen; i.e. sulphur dioxide, carbon dioxide, and oxides of nitrogen. Furnace emissions also contain dust, which arises mainly from the volatilisation and subsequent condensation of volatile batch materials. It is estimated that in 1997 the Glass Industry emissions to air consisted of: 9000 tonnes of dust; 103500 tonnes of NO_x; 91500 tonnes of SO_x; and 22 million tonnes of CO₂ (including electrical generation). This amounted to around of 0.7 % of total EU emissions. Total energy consumption by the Glass Industry was approximately 265 PJ.

Emissions to the water environment are relatively low and there are few major issues that are specific to the Glass Industry. However, there are water pollution issues in some sectors and these are covered in the specific sections of this document. Solid waste levels are also generally very low, and many initiatives have been implemented for reducing waste generation, and for recycling in-house and post consumer waste.

In general, the raw materials for glass making are readily available, relatively harmless natural or man made substances. There are no major environmental problems associated with the provision of the raw materials and waste levels are usually very low.

Many of the sectors within the Glass Industry utilise large continuous furnaces with lifetimes up to twelve years. These furnaces represent a large capital commitment and the continuous

operation of the furnace and the periodic rebuild provide a natural cycle of investment in the process. Major changes of melting technology are most economically implemented if coincided with furnace rebuilds. This can also be true for complex secondary abatement measures that must be correctly sized and any necessary gas conditioning implemented. However, many improvements to the operation of the furnace, including the installation of secondary techniques, are possible during the operating campaign. For smaller furnaces with more frequent rebuilds and lower capital costs, the advantages of co-ordinating environmental improvements and furnace repairs are less significant, but environmental improvements may be more economical if co-ordinated with other investments.

The total production of the Glass Industry within the EU in 1996 was estimated at 29 million tonnes (excluding ceramic fibres and frits), an indicative breakdown by sector is given in Table 1.1 below. There has been a steady growth in the overall volume of sales over the last decade. However, there have been fluctuations in each sector, which are discussed later in the document. The growth in total EU glass production, and in production from the three largest sectors, between 1986 and 1996 is summarised in Figure 1.1.

Sector	% of Total EU Production (1996)
Container Glass	60
Flat Glass	22
Continuous Filament Glass Fibre	1.8
Domestic Glass	3.6
Special Glass	5.8
Mineral Wool	6.8
Ceramic Fibre	-
Glass Frit and Enamel Frit	-

Table 1.1: Approximate sector based breakdown of Glass Industry production

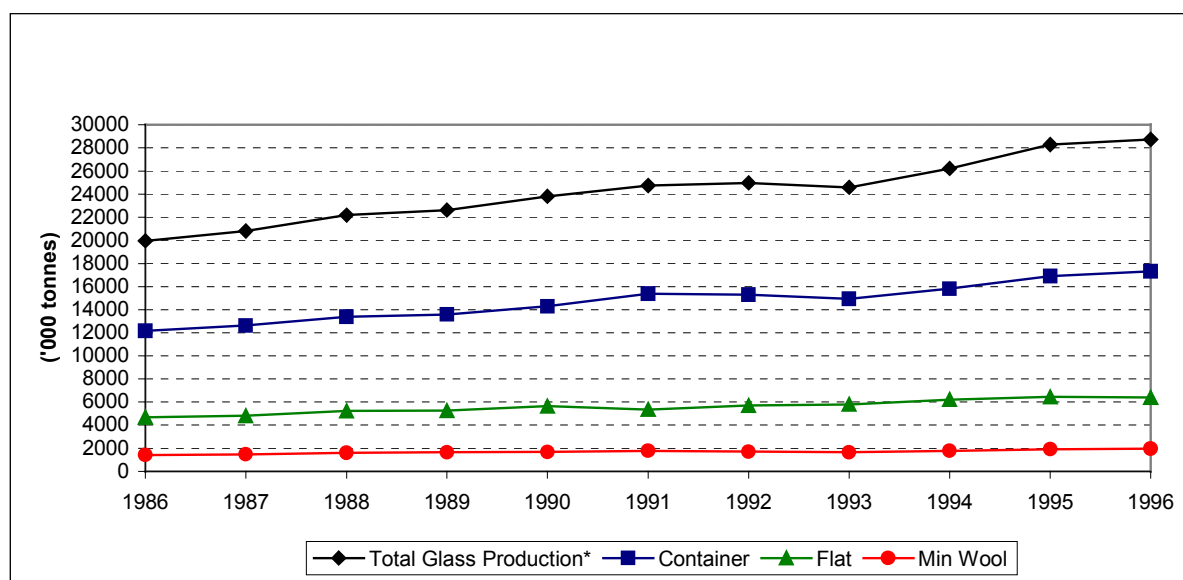

Figure 1.1: Total glass production 1986 to 1996 (*excluding frits and ceramic fibres)

The outputs from the different sectors are very diverse and the links between the sectors are at times tenuous. However, the common thread linking all of the activities discussed in this document is the melting of inorganic materials to form a molten glass, or glass-like, substance which is then formed into products.

In many senses each of the sectors of the Glass Industry is a separate industry in its own right, each producing very different products for different markets and facing different challenges. Sections 1.3 to 1.10 of this chapter give a brief overview of each of the sectors and try to outline some of the important factors that affect each. Where possible the information is presented in a comparable way for each sector. The differing structures, organisation and priorities of each sector means that the information sometimes varies in detail and in nature. This is to be expected because the relative importance of certain parameters will differ from sector to sector.

1.2.1 Characteristics of Glass

[tm21 Schott]

The term glass does not have a convenient simple definition. In its broadest sense glass is a collective term for an unlimited number of materials of different compositions in a glassy state. More specifically, the term is used to relate to a state of inorganic matter which may be likened to a solid, but which has the properties of a very highly viscous liquid, exhibiting neither crystalline structure nor a distinct melting point, i.e. a super-cooled liquid. In the Glass Industry the term is usually used to refer to silicate glasses, substances containing a high proportion of silica (SiO_2) and which naturally form glasses under normal conditions of cooling from the molten state.

Glasses are structurally similar to liquids, but at ambient temperatures they react to the impact of force with elastic deformation and so must also be considered to behave as solids. The use of the term glass is generally restricted to inorganic substances and not used in connection with organic materials such as transparent plastics.

Various chemical materials can form a vitreous structure; such as the oxides of silicon, boron, germanium, phosphorus and arsenic. When cooled quickly from the molten state they solidify without crystallisation to form glasses. These glass formers exhibit the same behaviour when mixed with other metallic components within certain compositional limits. The addition of these glass-modifying components (e.g. oxides of calcium and aluminium) changes the bonding relationships and structural groupings, resulting in changes in the physical and chemical properties of the glass. The glassy state is not limited to oxides and can also be observed when certain sulphur and selenium compounds are rapidly cooled. Under extreme conditions glass can be made from some oxide free metallic alloys, and many organic liquids transform into a glassy state at low temperatures (e.g. glycerine at -90°C).

Glasses are energetically unstable in comparison with a crystal of the same chemical composition. In general, when cooling a melted substance crystallisation begins when the temperature falls below the melting point. In glass this does not occur because the molecular building blocks (SiO_4 tetrahedrons in silicate glass) are spatially cross-linked to each other. To form crystals these linkages must first be broken so that crystal nuclei can form. This can only occur at lower temperatures, but at these temperatures the viscosity of the melt impedes the restructuring of the molecules and the growth of crystals. In general, the tendency to crystallise (devitrification) decreases with an increasing rate of cooling (within the critical temperature range below the melting point) and with the number and type of different components in the formulation.

The mechanical properties of glass are rather specific. The actual tensile strength of glass is several hundred times lower than the theoretical value calculated from chemical bond energies. The tensile strength is heavily dependent on the surface condition of the glass and the presence of internal defects. Treatments such as coating, fire polishing and prestressing can greatly improve the tensile strength but it still remains far below the theoretical value.

Many glass formulations are also susceptible to breaking under rapid temperature changes. There are several reasons for this, principally poor heat conductivity, the relatively high thermal expansion coefficient of alkali rich glasses, and limited tensile strength. Glasses are divided into

two categories, those with a thermal expansion coefficient below $6 \times 10^{-6}/\text{K}$ are termed hard glasses, and those with a higher thermal expansion coefficient are termed soft glasses.

1.2.2 Broad Classification of Glass Types

[tm21 Schott]

The most widely used classification of glass type is by chemical composition, which gives rise to four main groupings: soda lime glass, lead crystal and crystal glass, borosilicate glass and special glasses. The first three of these categories account for over 95 % of all glass produced. The thousands of special glass formulations produced mainly in small amounts account for the remaining 5 %. With very few exceptions most glasses are silicate based, the main component of which is silicon dioxide (SiO_2).

Stone wool is an exception to this classification of glass types in that the typical chemical composition does not fit into any of these categories. A typical stone wool composition is presented in Table 2.8.

Soda-lime glasses

The vast majority of industrially produced glasses have very similar compositions and are collectively called soda-lime glasses. A typical soda-lime glass is composed of 71 - 75 % silicon dioxide (SiO_2 derived mainly from sand), 12 - 16 % sodium oxide ('soda' Na_2O from soda ash – Na_2CO_3), 10 - 15 % calcium oxide ('lime' CaO from limestone – CaCO_3) and low levels of other components designed to impart specific properties to the glass. In some compositions a portion of the calcium oxide or sodium oxide is replaced with magnesium oxide (MgO) and potassium oxide (K_2O) respectively. More detailed glass compositions are given in Chapter 2.

Soda-lime glass is used for bottles, jars, everyday tableware and window glass. The widespread use of soda-lime glass results from its chemical and physical properties. Amongst the most important of these properties is the excellent light transmission of soda-lime glass, hence its use in flat glass and transparent articles. It also has a smooth, nonporous surface that is largely chemically inert, and so is easily cleaned and does not affect the taste of contents. The tensile and thermal performances of the glass are sufficient for these applications, and the raw materials are comparatively cheap and economical to melt. The higher the alkali content of the glass the higher the thermal expansion coefficient and the lower the resistance to thermal shock and chemical attack. Soda-lime glasses are not generally suited to applications involving extremes or rapid changes of temperature.

Lead crystal and crystal glass

Lead oxide can be used to replace much of the calcium oxide in the batch to give a glass known popularly as lead crystal. A typical composition is 54 - 65 % SiO_2 , 25 - 30 % PbO (lead oxide), 13 - 15 % Na_2O or K_2O , plus other various minor components. This type of formulation, with lead oxide content over 24 %, gives glass with a high density and refractive index, thus excellent brilliance and sonority, as well as excellent workability allowing a wide variety of shapes and decorations. Typical products are high quality drinking glasses, decanters, bowls and decorative items. Lead oxide can be partially or totally replaced by barium, zinc or potassium oxides in glasses known as crystal glass that have a lower brilliance or density than lead crystal. Precise definitions associated with chemical and physical characteristics are set in Directive 69/493/EEC.

Borosilicate glasses

Borosilicate glasses contain boron trioxide (B_2O_3) and a higher percentage of silicon dioxide. A typical composition is 70 - 80 % SiO_2 , 7 - 15 % B_2O_3 , 4 - 8 % Na_2O or K_2O , and 2 - 7 % Al_2O_3 (aluminium oxide). Glasses with this composition show a high resistance to chemical corrosion

and temperature change (low thermal expansion coefficient). Applications include chemical process components, laboratory equipment, pharmaceutical containers, lighting, cookware, and oven doors and hobs. Many of the borosilicate formulations are for low volume technical applications and are considered to fall into the special glass category.

A further application of borosilicate glass is the production of glass fibre, both continuous filaments and glass wool insulation. In addition to the chemical resistance and low thermal expansion coefficient, the boron trioxide is important in fiberisation of the glass melt. Typical compositions for glass fibre differ from the composition above. For example, the composition of EGlass is SiO₂ 53 - 60 %, earth alkali oxides 20 - 24 %, B₂O₃ 5 - 10 %, Al₂O₃ 5 - 10 % plus other minor components. It should also be noted that for continuous filament glass fibre new low boron/boron free formulations are becoming more important.

Special glasses

This is an extremely diverse grouping, which covers the specialised low volume, high value products, the compositions of which vary very widely depending on the required properties of the products. Some of the applications include: specialist borosilicate products; optical glass, glass for electrotechnology and electronics; cathode ray tubes; fused silica items; glass seals; X-ray tubes; glass solders; sintered glass; electrodes; and glass ceramics. More information on technical glass formulations is given in Chapter 2.

1.2.3 Historical Origins

[tm18 CPIV, tm21 Schott]

Glassy materials do occur naturally, for example, obsidian is often found in volcanic areas and has a composition comparable to man-made glass. This material, which consists mainly of silicon dioxide, and sodium and calcium compounds, was used by early man to make arrowheads, spearheads and knives. Other natural forms of glass are tektites, formed by the solidification of molten rock sprayed into the atmosphere when meteorites hit the surface of the earth; and fulgurites, formed when lightning hits sand.

Although it is not known when glass was first produced artificially, the oldest finds date back to around 3500 BC. It is thought that glass making originated in Egypt and Mesopotamia, but developed later and independently in China, Greece and the Northern Tyrol. Ancient glass manufacture is believed to be linked with the production of ceramics or bronze, where it could have originated as a by-product. Its early uses were as jewellery and for small vessels. Production began to increase significantly from around 1500 BC when larger and more utilitarian items (bowls, containers and cups) were made by moulding glass around a sand or clay core. The first major technical revolution in the manufacture of glass occurred in the first century AD in Palestine or in Syria with the discovery of the glass blowing pipe. This technique involved taking molten glass on to the end of the blowpipe into which the artisan blew to form a hollow body. This technique allowed the production of a wide variety of shapes and spread across the whole occident, e.g. Italy and France.

Glass manufacturing in Europe developed further in the Middle Ages, and Venice became the European centre of glass art. In the 14th century, glass workshops were set up all over the continent and at the same time the manufacture of flat glass for glazing developed in France. For centuries, window glass was blown with a glassblowing pipe into large cylindrical bodies, cut up and ironed flat while still hot. Only limited glass quantities could be handled and the window glass was very small. The new technique consisted of blowing a glass sphere with a pipe, which was then opened at the end, opposite where the glass was attached to the pipe, and spun flat. After the discovery of the plate pouring process in 1688 under Louis XIV, large surface mirrors could be created. At the same time, English glass manufacturers developed lead crystal, yielding a glass of high brilliance and pure ring.

In the 18th century, some factories were already producing more than 1 million bottles per year (around 3 tonnes/day), by manual mouth-blown techniques. During the industrial revolution of the 19th century, technical progress accelerated: furnaces were heated with coal instead of wood; the first automatic machines were used; and blowing was done using compressed air in metallic moulds. At the end of the 19th century, the continuous furnace was invented by Friedrich Siemens, allowing large-scale continuous production and the use of machinery.

Two important steps were taken in the 20th century: The full mechanisation of bottle manufacture with the introduction of the first automatic IS (individual section) machine around 1920, and the invention of the float process for flat glass in 1962. Today, the production of an IS machine can be above 500 bottles/minute and the production of float can be up to 900 t/d.

1.3 Container Glass

1.3.1 Sector Overview

[tm18 CPIV, CPIV stats]

Container glass production is the largest sector of the EU Glass Industry, representing around 60 % of the total glass production. The sector covers the production of glass packaging i.e. bottles and jars although some machine made tableware may also be produced in this sector. In 1997 the sector produced over 17.3 million tonnes of glass products from the 295 furnaces operating in the EU. There are approximately 70 companies with 140 installations and the sector directly employs 50000 people. Container glass is produced in all Member States with the exception of Luxembourg, and output has risen annually on average 1.8 % (see Figure 1.1) with sales in 1997 in excess of 6 billion euros.

More than 50 % of the EU output is from the ten largest producers shown in Table 1.2 below. The companies are grouped geographically and are not in order of size. At the time of writing the largest producer of container glass in the EU was the French group Saint-Gobain followed by Danone, Gerresheimer and AVIR. Western Europe is the biggest producer of container glass, followed by the USA and Japan. The geographical distribution of the sector and the range of installation sizes are shown in Table 1.3 and Table 1.4.

Company	Country	Ownership
B S N	France	Danone Group (France)
Saint Gobain Emballage	France	Saint Gobain (France)
Gerresheimer Glas	Germany	VIAG (Germany)
Oberland Glas	Germany	Saint Gobain (France)
AVIR	Italy	Owens Illinois (USA)
Vetrierie Italiana VETR.I	Italy	Saint Gobain (France)
Vereenigde Glasfabrieken	Netherlands	Danone Group (France)
Vicasa	Spain	Saint Gobain (France)
Rockware Glass	UK	Owens Illinois (USA)
United Glass	UK	Owens Illinois (USA)

Table 1.2: Major producers of container glass in EU (1997)

Member State	Number of Installations	Number of Furnaces	% Distribution of EU Production	
Germany	33	70	26	
France	22	54	20	
Italy	32	54	17	
United Kingdom	14	32	11	
Spain	14	23	10	
Portugal	6	17	16	
Netherlands	5	13		
Austria	4	9		
Belgium	4	9		
Greece	2	5		
Finland	1	2		
Denmark	1	3		
Ireland	1	2		
Sweden	1	2		
Total	140	295		17316000 tonnes in 1997

Table 1.3: Distribution of container glass installations in Member States

Production Range (Tonnes/day)	<150	150 to 300	300 to 600	600 to 1000	>1000
Number of Installations In Each Range	14	37	57	28	4

Table 1.4: Number of container glass installations in specified production ranges

1.3.2 Products and Markets

[tm18 CPIV]

Container glass is made from a basic soda lime formulation and is melted in a fossil fuel fired or, exceptionally, an electrically heated furnace. The molten glass is generally formed into the products by automated individual section (IS) machines. Where appropriate colouring agents are added to the glass and surface coatings are applied to the finished products.

The most important products of the container glass sector are bottles for wine, beer, spirits, soft drinks etc, and wide neck jars for the food industry. These products are generally considered as commodity items, but another important part of the sector is the production of higher value containers for the pharmaceutical and perfume industries. The majority of production is sold to customer industries within the EU, which then sell their packaged products into markets in the EU and the rest of the world. The relative importance of the various customer industries varies considerably between Member States. This is reflected in the great diversity of national markets for glass containers and the products they require, particularly colour, shape, size and design.

There are three broad customer industry sectors. The beverage sector accounts for approximately 75 % of the total tonnage of glass packaging containers. This includes still and sparkling wines, fortified wines, spirits, beer, soft drinks, fruit juices and mineral waters. The food sector accounts for about 20 % of the tonnage (mostly jars). This covers a wide range of products, such as: wet and dry preserves, milk and milk products, jams and spreads, sauces and dressings, oil, vinegar, etc. Perfumery and pharmaceutical containers, generally small bottles (flaconnage) account for the remaining 5 % or so of container glass tonnage.

An important characteristic of the sector is that delivery distances are generally limited to a few hundred kilometres, because for empty containers the cost of transport is relatively high compared to the sales price. Furthermore, specific local or regional markets exist with characteristic glass containers, particularly in alcoholic beverages (distinct wine regions, whisky, cognac, champagne, and beer), and this has acted against rapid market concentration. Indeed even when companies have been absorbed into larger groups they tend to conserve their local identity and customers.

1.3.3 Commercial and Financial Considerations

[tm18 CPIV, CPIV stats]

Container Glass is a mature industry serving extremely dynamic markets, which has experienced slow overall growth during the past decade. There are inevitable local or temporary changes, but the overall trend is expected to continue in the medium term. However, the competition from alternative packaging materials is expected to present an increasingly challenging threat to the sector.

During 1997, subject to regional variations, the sector utilised approximately 90 % of production capacity, with a variation between 84 % and 95 % over the previous decade. The large number of furnaces and the competitive nature of the business provide a degree of self-regulation of capacity. Although furnaces have long operating lives the large number of furnaces means that in any one year a significant portion of capacity will be approaching rebuild. In the Container Glass Sector over capacity tends to be localised and short term. Competition from alternative materials is a significant factor for price levels.

Due to transport costs most products are sold within 500 km of the point of production, and so imports and exports tend to be fairly limited. During 1997 EU exports exceeded imports by around 8 %, i.e. 453000 tonnes against 417000 tonnes. Total extra EU trade represents only 5 % of the sector production of 17.3 million tonnes. However, areas on the fringes of the EU can be subject to quite severe competition from non-EU countries, often with significantly lower prices but acceptable quality. This is particularly true for lower value products. It is however important to remember that although the containers are sold locally the packaged goods can rely heavily on extra EU trade.

There is a wide range of factors that can affect the market for container glass. The main threat is from alternative packaging materials, especially metals (steel and aluminium) and plastics. The main disadvantages of glass are greater weight (therefore transport costs) and risk of breakage. The main advantages of glass are ease of cleaning and reuse, recyclability, transparency, chemical inertness, and perceived quality for premium products. The relative position of glass to its competitors varies widely between regions and products, depending on market preferences, costs and packaging developments.

Other important factors are associated with fluctuations in the demand for the packaged products. For example, changes in consumer habits, such as the trend towards the consumption of lower volumes but of higher quality wines. Climatic factors such as the size of wine harvests and the increased consumption of beer and soft drinks during hot summers can also be important. Fluctuations in foreign exchange rates and prevailing local economic climate will effect the demand for high value items such as perfumes and spirits.

Glass making is a capital-intensive industry and this restricts entry into the market to fairly large enterprises with substantial financial resources. The long term slow growth means that although new furnaces are being constructed they tend to be built by companies already operating in that region, or by other existing companies entering that region. Much of the growth in sales will be met by upgrading existing plants at scheduled rebuilds. Overall there is a trend of transfer of ownership of smaller companies to large companies.

In general, container glass furnaces operate continuously, or with a minor intermediate repair, for up to 12 years, after which time they are rebuilt with either partial or total replacement of the structure depending on its condition. The straightforward rebuild of a medium sized furnace (around 250 tonnes per day) will cost in the region of 3 to 5 million euros. The actual expenditure can be significantly higher, because the rebuild can be a convenient time to implement any upgrades to the process. A new plant of comparable size on a green field site would cost in the region of 40 to 50 million euros including infrastructure and services.

1.3.4 Main Environmental Issues

The main environmental problem associated with container glass production is that it is a high temperature, energy intensive process. This results in the emission of products of combustion and the high temperature oxidation of atmospheric nitrogen; i.e. sulphur dioxide, carbon dioxide, and oxides of nitrogen. Furnace emissions also contain dust (arising from the volatilisation and subsequent condensation of volatile batch materials) and traces of chlorides, fluorides and metals present as impurities in the raw materials. Technical solutions are possible for minimising all of these emissions, but each technique has associated financial and environmental implications.

Waste levels within the sector are very low. Indeed a significant development within the sector has been the increased use of recycled glass. The average rate of utilisation of post consumer waste within the EU Container Glass Sector is approximately 50 % of total raw material input, with some installations utilising up to 90 % waste glass. A distinct advantage of glass over alternative packaging materials is the ease of reuse and recycling. In general, glass container production should not present significant water pollution problems. Water is used mainly for cleaning and cooling and can be readily treated or reused.

Major environmental improvements have been made within the sector, with major reductions in furnace emissions and energy usage. In particular advances have been made with primary emission reduction techniques for oxides of nitrogen and sulphur dioxide.

1.4 Flat Glass

1.4.1 Sector Overview

[tm18 CPIV]

Flat glass is the second largest sector of the Glass Industry in the EU representing around 22 % of the total glass production. The sector covers the production of float glass and rolled glass. In 1997 the sector produced approximately 6.9 million tonnes of glass from the 40 float tanks operating in the EU. There are five manufacturers of float glass and four rolled glass manufacturers operating in the EU. Flat glass is produced in eleven Member States, the exceptions being Austria, Denmark, Greece and Ireland.

The sector directly employs 12500 people in the manufacture of the glass, and a further 90000 are employed in the processing of glass into building and automotive products. Flat glass output increased substantially between 1986 and 1997 (see Figure 1.1), boosted in part by the entry of Sweden and Finland into the EU in 1995. However, year on year the demand can fluctuate significantly. For example 1997 showed a particularly high growth of over 6 %, but annual growth is predicted to be 2 - 3 % between 1998 and 2000.

Flat glass manufacture is a world-wide business that is dominated by five major groups; in order of world-wide sales they are Asahi (Japan), Pilkington (UK), Saint-Gobain (France), PPG Industries (USA), and Guardian Industries (USA). EU production is dominated by Pilkington and Saint-Gobain, which together are estimated to hold over 70 % of the market. Until recently

all five major groups had manufacturing sites in the EU. PPG has sold its European float glass plants (2 in Italy and 2 in France) to the Belgian company Glaverbel, which is largely owned by Asahi. The operations of EU float glass producers in 1997 are summarised in Table 1.5. Four new float tanks will be constructed in the EU between 1998 and 2000, one in each of Germany, UK, Italy and Spain. All four tanks will be in the 450 to 600 tonnes per day range.

Company	Number of Tanks	Locations
Saint-Gobain	13	Germany (4), France (3), Belgium (2), Spain (2), Italy (1), Portugal (1).
Pilkington	12	Germany (4), UK (3), Italy (3), Finland (1), Sweden (1)
Glaverbel	9	Belgium (4), France (2), Italy (2), Netherlands (1)
Guardian	5	Luxembourg (2), Spain (2), Germany (1)
Euroglas	1	France (1)

Table 1.5: Locations of float tanks in the EU in 1997

The geographical distribution of the sector and the range of installation sizes are shown in Table 1.6 and Table 1.7.

Member State	Number of Float Tanks	% Distribution of EU Production
Germany	9	20
France	6	15
Italy	6	15
Belgium	6	15
United Kingdom	3	10
Spain	4	10
Finland	1	14
Netherlands	1	
Luxembourg	2	
Portugal	1	
Sweden	1	
Austria	-	<1
Denmark	-	
Greece	-	
Ireland	-	
Total	40	6893000 tonnes in 1997

Table 1.6: Number of float tanks in Member States in 1997

Capacity Range (tonnes/day)	<400	400 to 550	550 to 700	>700
% Capacity in each range in EU	3	31	38	28
% Capacity in each range world-wide	17	47	20	16

Table 1.7: Percentage of float capacity in specified ranges

1.4.2 Products and Markets

[tm18 CPIV, CPIV stats]

There are two types of flat glass produced in the EU, rolled glass and float glass. Although strictly there are other types of flat glass they are not considered to fall within this sector, either because they are covered within the Special Glass Sector or they do not meet the production criterion of 20 tonnes per day specified in Directive 96/61/EC. The majority of rolled glass is patterned or wired glass and accounts for around 5 % of the total sector output. Patterned glass is used for horticultural greenhouses, for decorative purposes and in applications where light is dispersed for example glass partitions and bathroom windows. Float glass makes up the other 95 % of output and is used principally in the building and automotive industries.

Prior to the invention of the float glass process in 1962 by Pilkington, there were two main types of unpatterned glass, sheet glass and plate glass. The most widely used method for producing sheet glass was the Pittsburgh process, which involves drawing glass vertically from the tank. A refractory guidance device is placed in the glass at the drawing location and cooled grippers receive the glass. The glass passes through an annealing shaft about 12 m long and is then cut to shape. Prior to float glass, plate glass was the highest quality glass available. Plate glass is produced from rolled glass or thick sheet glass by grinding and polishing the glass using rotating discs on large tables or conveyors. The twin process involves polishing the glass on both sides at once. The grinding and polishing process generates large amounts of solid waste for disposal.

The advantages of the float process (economy, product range, low waste and quality) are such that, since its introduction in 1962 sheet glass and plate glass have gradually been replaced and are no longer produced within the EU. Some rolled glass products are still polished for specialist applications, and diminishing levels of sheet glass and plate glass are still produced in some parts of the world. For the purposes of this document sheet glass and plate glass manufacture can be considered as essentially obsolete techniques.

The most important markets for float glass are the building and automotive industries. The largest of these markets is the building industry which accounts for 75 % to 85 % of output, and the majority of the remaining 15 % to 25 % is processed into glazings for the automotive industry. Some glass is simply cut to size and used directly, but the majority of flat glass production is processed into other products. For the automotive industry these are laminated windscreens, side and rear glazings, and sunroofs. The main processed product for the building industry is insulated glazing in the form of double or triple glazed units, often with one layer of coated glass. These glazed units account for 40 % to 50 % of the building market with the remainder being made up of silvered, coated, toughened, and laminated products which each make up 10 % to 15 %.

1.4.3 Commercial and Financial Considerations

[tm18 CPIV, CPIV stats]

On average total extra EU trade represents about 20 % of EU production with a slightly positive balance of trade. In the region of 10 % of production is exported to non-EU countries and a similar but generally lower figure is imported into the EU market, predominantly from Eastern Europe. This summary is true for both unprocessed and processed glass. Flat glass is expensive to transport and it is desirable to supply customers as close to the manufacturing site as possible. However, with only 40 float lines in the EU and intense competition between companies the distances the glass is transported can be substantial, but is ultimately limited by cost. The vast majority of glass manufactured and processed in the EU is sold in Western Europe.

Basic flat glass production is a mature, cyclical, and essentially commodity business. Between 1986 and 1997 the sector showed a substantial if at times erratic growth in output, and annual growth is expected to average 2 % to 3 % from 1998 to 2000. However, over capacity in the

sector has led to severe price pressure, with glass prices falling in real terms between 1992 and 1997. Prices can fluctuate between markets but have been particularly bad in Germany, the largest producer. Demand for flat glass is particularly sensitive to economic cycles because it is heavily dependant on the building and automotive industries. During periods of economic growth and high demand flat glass can be quite a prosperous business, during economic downturns or recession the opposite can be true.

Capacity utilisation has varied from 79 % to 92 % between 1987 and 1997, and between 1990 and 1997 did not rise much above 86 %. General opinion within the industry is that long-term profitability requires capacity utilisation in excess of 90 %. The predicted weak growth is not expected to erode the surplus capacity in the short-term, and the situation is worsened by over capacity in Eastern Europe. Flat glass manufacture and float glass in particular is a very capital-intensive activity requiring substantial financial resources, long-term investment and high technical skills. Hence, the limited number and large size of international manufacturers, although smaller producers do exist they are not common.

Flat glass furnaces operate continuously for 8 to 12 years, after which time they are rebuilt with either partial or total replacement of the structure depending on its condition. A major rebuild would cost 30 - 50 million euros and a new float line (typically 500 tonnes per day) would cost in the region of 100 million euros.

1.4.4 Main Environmental Issues

The main environmental issue associated with flat glass production is that it is a high temperature, energy intensive process. This results in the emission of products of combustion, and the high temperature oxidation of atmospheric nitrogen; i.e. sulphur dioxide, carbon dioxide, and oxides of nitrogen. Furnace emissions also contain dust (arising from the volatilisation and subsequent condensation of volatile batch materials) and traces of chlorides, fluorides and metals present as impurities in the raw materials. Technical solutions are possible for minimising all of these emissions, but each technique has associated financial and environmental implications

Waste glass generated on site is recycled to the furnace and the sector has made significant improvements in the recycling of processor and post consumer waste. Flat glass cullet is a useful raw material for other parts of the glass industry particularly the Container Glass Sector, and it is estimated that up to 95 % of waste glass from processing is recycled in some way. In general flat glass production should not present significant water pollution problems. Water is used mainly for cleaning and cooling and can be readily treated or reused.

Major environmental improvements have been made in flat glass production, emissions have been reduced substantially and in particular major reductions have been made in energy consumption. In 1995 average energy consumption per tonne of glass melted was more than 30 % lower than in 1975, and around 60 % lower than it would have been in 1960. Energy consumption levels for melting are approaching the theoretical minima.

In considering the overall environmental impact of the Flat Glass Sector it is useful to consider some of the environmental benefits associated with the products. For example, the total energy associated with glazing includes, both the energy consumed in its manufacture and its impact on the energy consumed by the building throughout the period it is installed (say thirty years). In the case of the most advanced low emissivity double glazing, heat losses are reduced to less than 20 % of single glazing, and to less than 40 % of normal double glazing. This can make a significant impact on the use of energy in buildings. Advanced products for the automotive market help to reduce fuel consumption by saving weight, and to reduce air conditioner load by the use of solar control glasses.

The building sector accounts for at least 40 % of EU energy consumption, half of which is used to heat homes. Around 60 % of EU homes are still single glazed. The energy saved by upgrading them with low emissivity double glazing would save 80 million tonnes of CO₂ annually. During the lifetime of the glass, the reduction in CO₂ emissions achieved by low emissivity coated glass will typically outweigh those created in applying the coating in the factory by 1000:1.

1.5 Continuous Filament Glass Fibre

1.5.1 Sector Overview

[tm18 CPIV, CPIV stats]

The production of continuous filament glass fibre is one of the smallest sectors of the Glass Industry in terms of tonnage, but the products have a relatively high value to mass ratio. This sector covers the manufacture of continuous glass filaments, which are converted into other products. It is distinct from the manufacture of glass fibre insulation, which is made by a different process and is generally termed glass wool. In 1997 the sector produced 475000 tonnes of fibre from the 26 furnaces operating at the 12 sites in the EU. In 1996 the sector directly employed 6750 people.

The sector showed good growth from 1986 until 1995 when output peaked at 488000 tonnes, it then fell marginally in 1996 and then again by 2.5 % in 1997. There are five producers in the EU, Ahlstrom, Bayer, Owens Corning, PPG Industries, and Vetrotex. The largest of these is Vetrotex, which is a subsidiary of Saint-Gobain and has plants in France, Germany, Italy, and Spain. The next biggest producers in the EU are Owens Corning with plants in Belgium, France, the UK and Norway, and PPG with plants in the Netherlands and the UK.

On a global basis the USA is the biggest producer with over 40 % of world-wide output, Europe and Asia each account for 20 % to 25 %. The World's largest producer is Owens Corning followed by Vetrotex and PPG. The geographical distribution of the sector and the range of furnace sizes are shown in Table 1.8 and Table 1.9.

Member State	Number of Installations	Number of Furnaces (in operation in 1997)	% Distribution of EU Production
Northern Europe	5	10	43
Germany	1	1	
Finland	1	3	
Netherlands	1	2	
United Kingdom	2	4	
Central and Southern Europe	7	16	57
France	2	4	
Belgium	2	7	
Italy	2	3	
Spain	1	2	
Total	12	26	475000 tonnes in 1997

Table 1.8: Number of continuous filament installations and furnaces in Member States

Production Range (Tonnes/day)	<27	27 to 55	55 to 82	>82
Number of furnaces in each range (1997)	6	7	9	4

Table 1.9: Number of continuous filament furnaces in specified production ranges

1.5.2 Products and Markets

[tm18 CPIV, CPIV stats]

Continuous filament glass fibre is produced and supplied in a variety of forms: roving, mat, chopped strand, textile (yarn), tissue, and milled fibre. The main end use (approximately 75 %) is the reinforcement of composite materials, mainly thermosetting resins but also thermoplastics. Composites are used in a wide variety of industrial applications within the EU and new applications are being developed continuously.

The main markets for composite materials are the building industry, the automotive and transport sectors, and the electrical and electronics industry. Other uses are in pipes and tanks, agricultural equipment, industrial machinery, and in the sports, leisure and marine sectors. The second most important end use is the manufacture of textiles that are used in similar markets to composites though clearly for different applications. The main market for glass textiles is the electronics industry where they are used in the production of printed circuit boards.

The sector has a wide and increasingly diverse customer base with substantial international trade. This means it is not as vulnerable as some other sectors of the Glass Industry, to economic problems in specific markets or geographical regions. However, around 50 % out the sector output goes into the building and automotive/transport industries.

1.5.3 Commercial and Financial Considerations

[tm18 CPIV, CPIV stats]

The Continuous Filament Glass Fibre Sector shows good growth over the longer term. Its products have relatively high value, are readily transported and there is significant international trade. Although demand for the products is increasing there is very strong competition which places pressure on prices, and limits profitability. Capacity utilisation averaged around 95 % between 1994 and 1997, but averaged only 75 % between 1990 and 1993.

In 1996 exports and imports were 27 % and 30 % of EU output respectively, representing a slightly negative balance of trade. Certain earlier years showed higher import penetration, with the majority of imports coming from Eastern Europe and North America. Glass filament manufacture is a very capital-intensive activity requiring substantial financial resources, long-term investment and high technical skills. Hence, the limited number and large size of international manufacturers, and although smaller producers do exist they are not common.

Furnaces in this sector operate continuously for 8 to 12 years, after which time they are rebuilt with either partial or total replacement of the structure depending on its condition. The rebuild of a medium sized furnace (around 75 tonnes per day) will cost in the region of 8 million euros. A new plant of comparable size on a green field site would cost in the region of 75 to 90 million euros including infrastructure and services.

1.5.4 Main Environmental Issues

The production of continuous filament glass fibre is a relatively low waste activity compared to many industrial activities. However, the production of fine fibres can cause breakages, which in turn leads to a higher level of waste per tonne of product than the Glass Industry average. At the time of writing little of this waste is recycled within the process, but some alternative disposal options to landfill have been developed.

In general glass filament production should not present major water pollution problems. Water is used mainly for cleaning and cooling, but there are potential emissions associated with the use of coating materials. Emissions can arise from coating preparation and handling, throw off from winding, and secondary processing operations. Emissions can be minimised by appropriate

techniques for handling and spillage containment, and residual levels of pollution can be treated with standard techniques.

The main environmental issue associated with glass filament production is that it is a high temperature, energy intensive process. This results in the emission of products of combustion, and the oxidation of atmospheric nitrogen; i.e. sulphur dioxide, carbon dioxide, and oxides of nitrogen. Furnace emissions also contain dust (arising from the volatilisation and subsequent condensation of volatile batch materials) and traces of chlorides, and metals present as impurities in the raw materials.

Due to the nature of the fiberising process varying levels of fluorides are sometimes used in the batch, which can give rise to emissions of hydrogen fluoride. This is a complex issue that is discussed in detail in Chapter 4. Technical solutions are possible for minimising all of these emissions, but each technique has associated financial and environmental implications. Major environmental improvements have been made in glass filament production, emissions have been reduced substantially and reductions have been made in energy consumption.

In considering the overall environmental impact of the sector it is useful to consider some of the environmental benefits associated with composite materials, the main end use for glass filaments. In addition to their numerous technical benefits, composite materials generally use much less energy to produce than the materials they replace, particularly steel and aluminium. They provide a weight reduction in transport applications, (which contributes to fuel savings) and they have a longer service life due to their high resistance to corrosion.

1.6 Domestic Glass

1.6.1 Sector Overview

[tm27 Domestic]

The Domestic Glass Sector is one of the smaller sectors of the Glass Industry with approximately 4 % of total output. This sector covers the production of glass tableware, cookware and decorative items, which include drinking glasses, cups, bowls, plates, cookware, vases and ornaments. The manufacture of domestic glass is very widely distributed across the EU with about 140 installations. Approximately 40 of these meet the production criterion of 20 tonnes per day required by Directive 96/61/EC, and these account for the majority of EU production. Total production was slightly over 1 million tonnes in 1997, and around 90000 people are directly employed within the sector. Growth in EU production between 1986 and 1997 was quite low with output falling during certain years.

The biggest domestic glass manufacturers in Europe are Bormioli-Rocco e Figlio (Italy), Calp (Italy), Schott (Germany), Durobor-Ravenhead (Belgium and UK), Edinburgh Crystal (UK), Nachtmann (Germany), Verrerie Cristallerie d'Arques Vca (France), and Waterford Crystal (Ireland). As mentioned above there are many smaller companies, which often specialise in higher value added products (lead crystal, etc.).

The geographical distribution of the sector and the range of installation sizes are shown in Table 1.10 and Table 1.11.

Member State	Number of Installations	% of EU Production
France	15	44.5
Italy	14	17.5
United Kingdom	16	10.7
Germany	35	9.8
Portugal	17	2.4
Greece	1	1.3
Austria	6	1.3
Spain	not known	
Belgium	2	11.8
Denmark	1	
Ireland	>4	
Netherlands	1	
Sweden	15	0.7
Finland	>4	
Total	>131	1045694 tonnes in 1997

Table 1.10: Number and distribution of domestic glass installations in Member States in 1997

Production Range (Tonnes/day)	<20	20 to 50	50 to 100	100 to 200	>200
Number of Installations In Each Range	>90	20	14	5	2

Table 1.11: Number of domestic glass installations in specified production ranges (estimated)

1.6.2 Products and Markets

[tm27 Domestic]

The Domestic Glass Sector is very diverse in its products and the processes utilised. Products range from bulk consumer goods to high value lead crystal decanters and goblets. Product forming methods include manual methods (blowpipes and cutting) and completely automated machines. The basic products are outlined in the section above with drinking glasses accounting for over 50 % of output.

The majority of products are made from soda-lime glass, which can be clear or coloured. Lead crystal and crystal glass formulations are used to produce glasses, decanters and decorative items with high brilliance and density. Opal glass is used to produce cups, plates, serving dishes, and ovenware. Borosilicate domestic glass is perhaps better known by some of the common trademarks namely Arcuisine (Vca.), Duran (Schott) and Pyrex (Newell), and the main products are cookware and heat resistant tableware. In some cases, products made of these different glass formulations are tempered in order to increase their resistance to mechanical and thermal shocks. Glass ceramic products are used for high temperature applications, principally cookware, and can withstand high levels of thermal shock.

The end user customer base is clearly extremely broad but immediate sales are generally to large retailers and wholesalers, although some producers do also sell directly to the public. Different parts of the market are affected by a wide range of factors. Customer tastes and social trends are very important. For example, the trend towards more casual dining particularly in Europe has resulted in a higher demand for cheaper medium quality items, and the demand for coloured glass varies with time and region. It is important for the manufacturer to keep ahead of these changes and to respond accordingly; therefore flexibility is an important part of the manufacturing operation.

As a consequence domestic glass formulations must be tailored to specific product and processing requirements. Even basic soda-lime formulations can show significant differences from other soda-lime formulations such as container or flat glass.

Increased mechanisation in lead crystal production has led to the production of cheaper items with quality close to that of hand-made items. However, this type of high value product is particularly sensitive to customer perception and the crucial hand-made label still commands a higher price. This means it is unlikely that hand-made items will be restricted (in the medium term at least) to individually commissioned products.

1.6.3 Commercial and Financial Considerations

[tm27 Domestic]

In common with most sectors of the Glass Industry the Domestic Glass Sector is an established mature business that experiences modest long-term growth in demand. Domestic glass products are readily transported and there is substantial international trade both between Member States and extra EU. The main threat to this sector is competition in the domestic markets from increased imports, and greater competition in the important export markets. This increased competition has led to severe pressure on prices and therefore restricted profitability. In 1996 exports and imports represented 34 % and 17 % respectively of EU output, in value terms. Although this represents a good overall balance of trade the majority of imports were from Turkey and Eastern Europe, which greatly outweighed EU exports into these regions.

As in other sectors of the industry large scale glass making is very capital intensive requiring substantial long-term investment. This is reflected in the small proportion of domestic glass manufacturers producing more than 20 tonnes per day. Although these few companies produce the majority of the EU output, the Domestic Glass Sector is unusual in that there are a large number of smaller, less capital intensive installations often specialising in high value hand-made items or niche markets. These small amounts of glass can be produced in pot furnaces and day tanks, which are relatively cheap to build and operate, but could never compete economically in high volume markets.

The Domestic Glass Sector utilises a wide range of furnace sizes and types and the furnace repair interval will vary accordingly. Large fossil fuel furnaces will run for 5 to 8 years before a major repair is needed, for electrically heated furnaces it will be 3 to 6 years, and for pot furnaces 10 to 20 years, with the pots being replaced every 3 to 12 months. For a typical electrically heated 30 tonnes per day lead crystal furnace, a major repair (excluding forming machines) would be in the region of 2 million euros, and a new furnace 8 million euros. For a typical fossil fuel fired 130 tonnes per day soda-lime furnace a major repair (excluding forming machines) would be in the region of 4 million euros, and a new furnace 12 million euros.

1.6.4 Main Environmental Issues

In general, the raw materials for domestic glass production are relatively harmless natural or man made substances. The exception to this is the production of lead crystal or crystal glass, which involve the use of lead oxide and sometimes antimony or arsenic trioxide, which require careful handling and storage to prevent emissions. The sector produces relatively low levels of waste and most internally produced cullet is recycled, where this is not possible the cullet is usually recovered or recycled by the Container Glass Sector (except lead crystal and crystal glass), where quality restrictions allow. Quality considerations generally prevent the use of external cullet in the process.

Most types of domestic glass production should not present major water pollution problems. Water is used widely for cleaning and cooling and can be readily recycled or treated. However, the use of more toxic compounds in lead crystal or crystal glass production provides a higher

potential for pollution. Emissions can be minimised and residual levels of pollution can be treated with standard techniques.

The main environmental issue associated with domestic glass production is that it is a high temperature, energy intensive process. For fossil fuel furnaces this results in the emission of products of combustion, and high temperature oxidation of atmospheric nitrogen; i.e. sulphur dioxide, carbon dioxide, and oxides of nitrogen. Furnace emissions also contain dust and traces of chlorides, fluorides and metals present in the raw materials. Opaque glasses require the use of raw materials containing fluoride, which can give rise to emissions of hydrogen fluoride. Where acid polishing is carried out there are associated air, water and waste issues to consider.

Technical solutions are possible for minimising all of these emissions, but each technique has associated financial and environmental implications. In recent years environmental improvements have been made, with emissions and energy consumption being reduced significantly.

1.7 Special Glass

1.7.1 Sector Overview

[tm25 Special, CPIV stats]

The Special Glass Sector produces around 6 % of the Glass Industry output, and in terms of tonnage is the fourth largest sector. Special glass products have a relatively high value. The value of gross production in 1996 was approaching 3 billion euros, around half of the value of the largest sector Container Glass. In 1997 including water glass production the sector produced 1.46 million tonnes of products and directly employed in the region of 35000 people.

This is an extremely broad sector covering a wide range of products, but the main products are: cathode ray tube (CRT) glass for televisions and monitors; lighting glass (tubes and bulbs); optical glass; laboratory and technical glassware; borosilicate and ceramic glasses (cookware and high temperature domestic applications); and glass for the electronics industry (e.g. LCD panels). There is a degree of overlap between the Special Glass Sector and other sectors of the Glass Industry, particularly the Domestic Glass Sector for some borosilicate and glass ceramic products. This is not considered to be a significant issue since these products only represent a minor part of the sector output

Most smaller producers of the low volume specialist products such as optical glass and glass for the electronics industry fall below the 20 tonnes per day production level specified in Directive 96/61/EC. Of the plants producing CRT glass, lighting glass, borosilicate glass, and glass ceramics most will be above this threshold. There are some integrated installations that produce a wide range of low and higher volume products, and in these cases total production may be above this level.

Although usually considered to be part of the chemical industry, water glass (sodium silicate) can be produced by melting sand and soda ash. This activity fits the definitions in Sections 3.3 and 3.4 of Annex 1 of Directive 96/61/EC. For the purposes of this document this activity has been considered as falling within the Special Glass Sector, although where considered appropriate, distinctions have been made.

1.7.2 Products and Markets

[tm25 Special]

Table 1.12 shows the relative outputs of each part of the sector. CRT glass, and glass tubes plus bulbs account for over 80 % of capacity.

Glass Type	1997 Production (tonnes)	Capacity (tonnes per year)	% Sector Capacity (exc. water Glass)
CRT (panel and funnel)	525000	880000	61.2
Glass Tubes and Bulbs	240000	290000	20.2
Borosilicate Glass (exc. tubes)	60000	90000	6.3
Other Lighting Glass (exc. quartz, tubes and bulbs)	30000	60000	4.2
Glass Ceramics	25000	65000	4.5
Quartz Glass	5000	15000	1.0
Optical Glass	6000	12000	0.8
Other Glass Types	10000	25000	1.8
Total Special Glass	901000	1437000	100
Water Glass	560000	600000	(42 % of Special Glass)
Combined Total	1461000	2037000	142

Table 1.12: Special Glass Sector breakdown

In the EU, CRT glass is produced only in Germany, the UK and France. Production is controlled by five companies: Philips (plants in Germany and UK); Schott (Germany); Samsung-Corning (Germany); Nippon Electrical Glass (NEG, UK), and Thomson Videoglass (France). There are 13 furnaces operating in the EU ranging from 70 to 360 tonnes/day, with an average capacity of 185 tonnes/day. The majority of furnaces are cross-fired regenerative furnaces, but some oxy-gas fired furnaces are in operation. These products are traded internationally and the markets are very regionalised. For example, in Europe there is a high growth in the number of personal computers and so a high demand for monitors; but in general growth in television production is much slower except in some developing countries.

The production of tubes for pharmaceutical applications and lighting glass, and bulbs for lighting glass is more widely distributed in the EU, but production is highest in Germany, the Netherlands and the UK. There are 10 companies producing these types of products, Schott, Osram, and Techn. Glaswerke Ilmenau (Germany); Philips (Netherlands); Demaglass (UK); Kimble Italiana and Bormioli Rocco E Figlio (Italy); Wheaton Lawson Mardon (France); Averti (Spain); and Glass Componenten Lommel (Belgium).

Furnaces range from 20 - 200 tonnes/day for soda-lime glasses and 20 - 50 tonnes/day for borosilicate glasses. Soda-lime furnaces are predominantly cross-fired regenerative furnaces and borosilicate furnaces are largely electrically heated furnaces with some recuperative furnaces. The production of glass for use in the lighting industry is dominated by the manufacturers of the complete lighting products. Other lighting glass consists principally of lamp glass for technical and automotive applications and represents approximately 4 % of special glass production.

Borosilicate glass production (excluding tubes and lighting) is concentrated in Germany (Schott, Desag, Jenaer and Techn. Glaswerke Ilmenau), in France (Verrerie Cristallerie D'Arques) and in the UK (Corning). Melting capacity ranges from 20 - 50 tonnes/day and furnaces are predominantly electrically heated with some recuperative furnaces. Products include domestic glassware, laboratory products, fireglass for windows and doors, and small heat resistant glass panes for oven doors etc. In this sector, ceramic glass products are made principally by Schott Glas in Germany, and Keraglass and Eurokera in France. The main products are temperature resistant cookware and tableware (e.g. Jena 2000 and Pyroflam) and ceramic flat glass for cooker tops.

Water glass is produced in Germany (Henkel KG,APS-Akzo, and Woellner Silicat), the UK (ICI/Crossfield Chemicals), the Netherlands (Akzo-PQ Silica Vof), France (Rhone-Poulenc - Rhodia), Finland (Zeofinn Oy) and Spain (FMC foret). The market leader is Henkel KG. Furnaces range from <40 - 350 t/day and are mainly cross-fired regenerative or recuperative furnaces, although one manufacturer uses rotary furnaces. Water glass is also produced using

the hydrothermal process, which does not meet the definitions in Sections 3.3 and 3.4 of Annex 1 of Directive 96/61/EC, and is not covered in this document. Approximately 20 to 30 % of water glass produced in the EU is made by the hydrothermal process.

Table 1.13 shows the breakdown of production by Member States, but this data is only available for CRT and glass tubes/bulbs, which represented 85 % of 1997 production.

Member State	CRT Glass		Glass Tubes/Bulbs	
	No. Installations	% EU Production	No. Installations	% EU Production
Germany	3	69	3	40
UK	2	21	1	15
France	1	10	1	See Others
Netherlands/Belgium	-	-	2	32
Others	-	-	3	13

Table 1.13: Distribution of special glass production in EU

1.7.3 Commercial and Financial Considerations

[tm25 Special, CPIV stats]

The sub-sectors of special glass range from mature established businesses to those serving highly developing markets, with some companies operating in a wide range of markets. Growth, profits and outlook can vary widely for each part of the sector. For example, in 1996 CRT glass production for computer monitors showed very high growth in Europe, while the demand for optical glass in Europe was stagnant due to competition from alternative materials. Overall sector growth between 1986 and 1996 was steady with the value of production rising from 1.75 to 2.76 billion euros.

In 1996 EU exports of special glass (excluding water glass) were 68500 tonnes and imports were 87500 tonnes, giving a significant trade deficit. The highest level of imports (over 40 %) were from Japan with lower levels from Eastern Europe (22 %) and the USA (12 %).

Large-scale glass making is very capital intensive requiring substantial long-term investment and technical skill. This is reflected in the limited number of special glass manufacturers in the EU producing more than 20 tonnes/day. Although these few companies produce the majority of the EU output, the Special Glass Sector has a large number of smaller, less capital intensive installations often specialising in high value, high quality and technically demanding products.

These small amounts of glass are produced in small furnaces, often electrically heated, and operated for shorter campaigns. Despite the scale these operations usually also require substantial long-term investment in high quality equipment, skilled staff, and extensive research and development work.

The Special Glass Sector utilises a wide range of furnaces and the furnace repair interval will vary accordingly. Large fossil fuel furnaces will run for 6 to 7 years for special glass and 8 to 12 years for water glass, before a major repair is needed. For electrically heated furnaces the rebuild interval is 3 to 4 years. Due to the wide variation within the sector typical costs are difficult to predict, but the following costs have been supplied by the sector, and are for example production units.

Production Unit	Capacity	Output	Total Investment
Borosilicate cookware, laboratory glass, etc	1 furnace 35 - 40 t/day	Typically 26 million pieces per year.	25 million euros
CRT glass, panels and funnels. Forming lines: 3 for panels, 2 for funnels.	1 Panel tank 200 - 300 t/day 1 Funnel tank 140 - 200 t/day	6 - 10 million sets per year.	300 - 400 million euros
Glass ceramic oven tops.	2 furnaces x 60 t/day.	800000 m ² , 3 million pieces.	175 million euros
Glass tubes, melting and drawing.	2 furnaces x 30 - 35 t/day	16000 tonnes – net.	30 million euros

Table 1.14: Investment costs for special glass installations

1.7.4 Main Environmental Issues

The broad range and specialised nature of the products of the Special Glass Sector leads to the use of a wider range of raw materials than encountered in most other sectors. For example, CRT funnels have a lead oxide content of over 20 %, which is comparable to lead crystal. Certain compositions can require specialised refining agents such as oxides of arsenic and antimony, and some optical glass can contain up to 35 % fluoride and 10 % arsenic oxide

The sector produces relatively low levels of waste and most internally produced cullet is recycled. Quality considerations have restricted the use of external and post-consumer cullet in the process. Initiatives are being developed to standardise CRT glass formulations to make it easier to recycle market place waste in the future. Water is used widely for cleaning and cooling and can be readily recycled or treated. Special glass production can give rise to water pollution issues due to polishing and grinding operations, particularly with lead containing glasses. Emissions can be minimised by appropriate techniques for handling and spillage containment, and residual levels of pollution can be treated with standard techniques.

The main environmental issue associated with all fossil fuel fired glass furnaces is that it is a high temperature, energy intensive process. This results in the emission of products of combustion, and the high temperature oxidation of atmospheric nitrogen; i.e. sulphur dioxide, carbon dioxide, and oxides of nitrogen. Furnace emissions also contain dust and traces of chlorides, fluorides and metals present in the raw materials. Where glass formulations require the use of raw materials containing fluoride there will be emissions of hydrogen fluoride. Where toxic batch materials are used there is the potential for emissions from handling, storage and from the furnace, and appropriate measures should be taken. Technical solutions are possible for minimising all of these emissions, but each technique has associated financial and environmental implications. In recent years environmental improvements have been made, with emissions and energy consumption being reduced significantly by both primary and secondary measures.

1.8 Mineral Wool

1.8.1 Sector Overview

[tm26 EURIMA, EURIMA stats]

The Mineral Wool Sector represents approximately 6 to 7 % of the total output of the Glass Industry. The sector covers the production of glass wool and stone wool insulating materials, which are essential randomly interlaced masses of fibre with varying lengths and bound by a resin based binder. Although the term glass fibre is sometimes used to describe glass wool, insulation should not be confused with the products of the Continuous Filament Glass Fibre Sector, which are made by different processes and sold into different markets.

In 1996 the sector directly employed over 10000 people at 48 installations, and produced 2 million tonnes of products with a value of around 2 billion euros. Between 1986 and 1996 output grew only slowly from 1.4 million tonnes to 2 million tonnes. The EU is dominated by five main producers: Saint-Gobain (20 installations in 12 Member States); Rockwool International (10 installations in 5 Member States); Partek Insulation (6 installations in 2 Member States); Pflleiderer (3 installations in 2 Member States); and Owens Corning (4 installations in 2 Member States). Most of these companies have operations in non-EU countries or in other sectors. There are also several independent manufacturers in the EU. The geographical distribution of the sector and the range of installation sizes are shown in Table 1.15 and Table 1.16.

Member State	Number of Installations	% 1996 Production
Austria	2	3.5
Belgium	2	4.5
Denmark	4	9.0
Finland	5	7.5
France	7	16.0
Germany	9	28.0
Greece	1	Approx. 0.5
Portugal	1	
Italy	2	2.0
Netherlands	2	9.5
Spain	2	3.0
Sweden	5	7.0
United Kingdom and Ireland	6	9.5
Total	48	2000000 tonnes

Table 1.15: Number of mineral wool installations in Member States

Table 1.16 shows the number of installations falling in specified production ranges in 1996. Several of the installations operate more than one furnace. These figures represent actual output in 1996 and it is estimated that most installations were operating between 10 % and 30 % below full capacity. The average production per installation in 1996 was in the region of 41000 tonnes. It should be noted that these figures are for tonnage and for a given application, stone wool products are significantly more dense than glass wool products, particularly for the lower density range.

Production Range (Tonnes/day)	<27	27 to 82	82 to 164	164 to 274	>274
Number of Installations In Each Range	5	16	16	9	2

Table 1.16: Number of mineral wool installations in specified production ranges

1.8.2 Products and Markets

[tm26 EURIMA]

Mineral wool was first produced in 1864 by applying a jet of steam on molten slag escaping from a blast furnace. Commercial patents and production began in about 1870. The market started to grow significantly during the 2nd World War when there was a demand for cheap prefabricated housing to replace damaged homes. In 1943, in the USA alone, there was over 500000 tonnes of mineral wool produced. In most developed countries thermal insulation has become universally accepted and incorporated into almost every form of building. In addition to its thermal properties, mineral wool insulation has good acoustic and fire protection properties.

The main products are low density insulation rolls, medium and high density slabs, loose wool for blowing, and pipe insulation. The main markets for these products are: building thermal insulation (walls, roofs, floors etc.); heating and ventilation applications; industrial (technical) installations (process pipework, vessels, chemical plant, offshore and marine); fire protection; acoustics (sound absorption and insulation); inert growing media and soil conditioning. Glass wool and stone wool are interchangeable in many applications, but some applications demand one product in preference to another. Stone wool is usually favoured for high temperature or fire protection applications, and glass wool is frequently used where lightweight is critical.

The most important market for mineral wool is the building industry, which takes up to 70 % of output and is very dependant on the prevailing economic climate. Although there are some exceptions in the EU, in the 1990s the building industry has shown very slow growth with significant periodic and local downturns. Other key factors which influence the market are: weather, or climatic conditions; fuel costs including taxation on fuel; legislation, such as building codes; and pressures for global environmental improvement (global warming and pollution).

In spite of the technical expertise required to manufacture fibre insulation, it is essentially a commodity product. There is little opportunity for differentiation between products competing in the same markets, and competition is based mainly on price. This has led to substantial cost reductions and downsizing within the sector. Price competition is weaker in the "technical" product market, which requires higher value added products such as rigid pipe sections for high temperature and fire resistant applications.

Due to the moderate temperature range required for the building industry a wide variety of alternative insulation materials are available, the most common being: plastic foams (the main competitor); cellulose fibre (shredded newspaper); vermiculite and perlite; and foamed glass. None of these materials can match mineral wool in all areas of performance (low price, thermal performance, acoustic performance, flammability, and ease of installation), but they all have their place in the market.

1.8.3 Commercial and Financial Considerations

[tm26 EURIMA, tm8 S2 3.03]

The Mineral Wool Sector is a very mature business that shows slow growth but is increasingly competitive. There is considerable over capacity in the market despite the closure of several operations, and this combined with slow growth has led to severe pressure on price. The selling price of a tonne of product in 1997 was the same as in 1987, and therefore significantly lower in real terms. Mineral wool products have a low value to volume ratio, which limits the distance over which they can be economically transported. Despite this there is significant trade within the EU but extra EU trade represents less than 5 % of output. Clearly extra EU trade is greatest where Member States border non-EU countries. Exports are greatest from Sweden and Finland to Poland, Russia and the Baltic States, and imports greatest into Germany, Austria, and Italy from Hungary, Slovenia and Croatia.

Mineral wool production is a very capital-intensive activity requiring substantial financial resources, long-term investment and high technical skills. This creates a substantial barrier against entry into the market and most producers are large companies with a long history in the business. There is a trend within the sector for acquisition of independent manufacturers by the larger groups as the sector consolidates.

The Mineral Wool Sector uses mainly recuperative and electrical furnaces, and to a lesser extent oxy-gas fired furnaces for glass wool production; and predominately hot blast cupolas for stone wool production. The furnace repair interval will vary accordingly. Recuperative furnaces will run for 8 to 12 years before a major repair is needed, and electrically heated furnaces for 3 to 6 years. The lifetimes of oxy-gas fired furnaces have not been fully established, but are expected

to be comparable to recuperative furnaces. Cupola furnaces do not operate continuously for such long periods, usually operating for 1 to 3 weeks between shutdowns. In such a mature sector new plants are very rare, but a 20000 tonnes per year glass wool plant was built in 1998, and represented an investment of 45 million euros. A stone wool plant producing a similar volume (i.e. approximately 40000 tonnes per year) would represent a similar investment. The costs of glass furnace rebuilds are comparable with those quoted for other sectors.

1.8.4 Main Environmental Issues

In common with all glass making activities mineral wool production is a high temperature, energy intensive process. For fossil fuelled furnaces this results in the emission of products of combustion and the high temperature oxidation of atmospheric nitrogen; i.e. sulphur dioxide, carbon dioxide, and oxides of nitrogen. Furnace emissions also contain dust, and traces of chlorides, fluorides and metals if present as impurities in the raw materials.

In this sector there are two further important emission sources, the forming area (where the binder is applied to the fibres) and the curing oven (where the product is dried and the binder cured). Forming area emissions are likely to contain significant levels of particulate matter, phenol, formaldehyde, ammonia and water. Curing oven emissions will contain volatile binder components, binder breakdown products, and combustion products from the oven burners. Technical solutions are possible for minimising all of these emissions, but each technique has associated financial and environmental implications. Major environmental improvements have been made in mineral wool production, emissions have been reduced substantially and major reductions have been made in energy consumption.

In general, the production of mineral wool insulation should not present major water pollution problems. The basic processes are net users of water, mainly due to evaporation from the forming area and curing oven. Process water systems are usually a closed loop with clean water top up, but precautions are necessary to prevent contamination of clean water systems. Emissions can be minimised by appropriate techniques for handling and spillage containment, and residual levels of pollution can be treated with standard techniques.

In considering the overall environmental impact of the sector it is useful to consider some of the environmental benefits associated with the products. The production of mineral wool requires relatively little energy, compared to the potential saving during the use of the products. In less than one month following installation, mineral wool products can save the entire quantity of energy used for their manufacture. After 50 years of use, which is common for buildings, the amount of energy saved can be 1000 times greater than that consumed during production. If compared to typical CO₂ emissions from fossil fuel derived power generation, after 50 year's use, a product can also save 1000 times the quantity of CO₂ emitted during its production. At higher temperatures, for example, in pipes, boilers and process plant, the savings can be significantly higher, and the environmental return on the investment can be days rather than weeks.

1.9 Ceramic Fibre

1.9.1 Sector Overview

[tm40 ECFIA]

There are currently six plants in the EU, employing approximately 800 people. Estimated production in 1997 was approximately 42000 tonnes (0.15 % of the Glass Industry total), arising predominantly from the UK and France. There are only three companies operating in the EU Thermal Ceramics (3 installations), Carborundum - part of the Saint-Gobain Group - (2 installations), and Rath (1 installation). In this document only the production of ceramic fibres

by melting minerals substances is discussed. Some fibres (e.g. crystalline alumina fibres) can be produced by chemical means, but these activities do not fall within the definitions given in Sections 3.3 or 3.4 of Annex 1 of Directive 96/61/EC

Member State	Number of Installations
France	2
Germany	1
Italy	1
United Kingdom	2
Total	6

Table 1.17: Distribution of ceramic fibre installations in Member States

1.9.2 Products and Markets

[tm40 ECFIA]

Ceramic fibre is a vitreous, siliceous, fibrous material used mainly as a high temperature insulation material (1000 - 1460°C). Its main uses and the market splits are: furnace and heater linings (50 %); appliances (20 %); metals processing (10 %); general industrial insulation (10 %); automotive uses (5 %); and fire protection (5 %). The main product forms are bulk fibre, blanket (felt or modules), board, paper, vacuum formed articles, and textiles. All of these forms originate from bulk fibre.

Many of the products are sold into traditional heavy industries such as petroleum, petrochemical, iron and steel, ceramics, glass, non-ferrous metals, cement etc. Ceramic fibre products are relatively high value and can be economically transported to most markets in the world. The products are often converted into or incorporated in other products such as automotive catalytic converters, gaskets, piston linings, heat shields and brake linings. Around 30 - 40 % of primary products are used as components in secondary applications.

1.9.3 Commercial Considerations

[tm40 ECFIA]

The fact that there are currently only three companies producing ceramic fibre in the EU is a result of a consolidation within the sector. Most significant was the purchase of Carborundum by Saint-Gobain and its merger with the existing holding Kerlane. The main factors affecting the sector are production costs (energy, raw materials and labour), and the activity in the customer industries. There are significant exports from the EU and imports are relatively low.

The estimated cost of a new factory of typical capacity is 3 to 8 million euros. Furnaces are electrically heated and have a lifetime of 3 to 5 years, furnace costs are estimated at 1 to 2 million euros.

In the refractory lining market ceramic fibres compete directly with other refractory materials such as bricks. In other applications the main competition is from mineral wool, and a range of specialist silica and alumina fibres. Stone and glass wool products are substantially cheaper than those made from ceramic fibre, but less durable, whereas those produced from specialist fibres are considerably more expensive. Owing to the unique thermal and physical properties of ceramic fibres the immediate competitive threat from substitutes is not considered to be substantial.

1.9.4 Main Environmental Issues

Unlike other sectors of the Glass Industry the Ceramic Fibre Sector uses exclusively electrically heated furnaces and consequently direct emissions from the furnace are very low and readily controlled. The main environmental issue is the emission into air of particulate matter, which may contain fibre. Under the definitions of the Dangerous Substances Directive 67/548/EEC ceramic fibre has recently been classified as a category 2 carcinogen, therefore fibre emissions in the work place and to the environment must be carefully controlled. Generally, waste levels are relatively low and low levels of aqueous emissions containing suspended solids and some organic compounds may arise from secondary processing operations. Emissions levels of ceramic fibre are very low from the installations in the EU, which are all fitted with dust abatement equipment where necessary.

1.10 Frits

1.10.1 Sector Overview

[tm46 ANFFECC]

The Frits Sector is more usually associated with the Ceramic Industry, but falls within the scope of this document because it is covered under the definition in Section 3.4 of Annex 1 of Directive 96/61/EC. Production in the EU is estimated at 1 - 1.25 million tonnes per year making Frits one of the smallest sectors of the Glass Industry. The number of employees is difficult to establish because for many companies frits production is only a small part of the business. The sector covers the production of frits for glazes and enamels, which are used for decorating ceramic materials and metals.

It is estimated that there are around 60 installations in the EU mostly in Spain and Italy. Spain is the largest producer in the world accounting for more than half of the total EU output. Italy has more installations but production volumes are smaller. The three main producers in the EU are Cerdec, Ferro and Cookson Matthey. These three companies own a range of operating companies and there are a number of independent companies for example, Colorobbia in Spain.

Member State	Number of Installations
Spain	17
Italy	32 (estimated)
Portugal	1
Belgium	1
Germany	4
Netherlands	1
United Kingdom	4
Total	60 (estimated)

Table 1.18: Distribution of frit installations in Member Stated (estimated)

Production Range (Tonnes/day)	<80	80 to 150	>150
Number of Installations In Each Range	>14	>5	>5

Table 1.19: Number of frit installations in specified production ranges (estimates)

Note: no information is available concerning the size of installations in Italy.

1.10.2 Products and Markets

[tm46 ANFFECC, tm8 S23.03]

The principal application of glass frit is in the manufacture of ceramic glazes and pigments. These glazes, when applied to the surface of ceramic bodies such as tiles and tableware, and then fired, provide an impervious, protective and decorative coating. Frits may be sold in the pure form to the ceramic ware manufacturers who create their own glazes, or the frit manufacturers may produce and supply the glazes themselves. Across the sector typically over half the frit manufactured is used internally in the production of glazes.

Enamel frits are used in the manufacture of enamel glazes, the principal application of which is the coating of metal surfaces to provide a chemically and physically resistant covering. The principal market for enamels is in the manufacture of cooking equipment, and as a coating for hobs, ovens, grills etc. Other applications for enamels include storage tanks, silos, baths, electronic components and signs.

Frits are relatively high value, low volume products and transport costs generally comprise a relatively small proportion of the total product price. World-wide consolidation in the industry is resulting in relatively fewer but larger plants serving wider international markets.

1.10.3 Commercial Considerations

[tm46 ANFFECC, tm8 S23.03]

Production volumes have shown reasonable growth overall, with Spain showing an increase in sales in 1997 of over 15 %, a significant proportion of this is thought to have been in the EU.

There is fierce competition between the producers in the EU both within, and between Member States. Most of the frits produced in the EU are used internally but exports are an important market for EU producers and are generally significantly higher than imports from non EU countries. The performance of the Frits Sector closely follows the success of the Ceramic Sector as a whole, and if the latter declines, then the Frits Sector that serves it, will also suffer. Imports into the EU of products using frits is potentially a greater threat than imports of frits themselves

The production of glass frit is a well established industry and has served the ceramics sector for many years. Competition from raw glazes, which do not contain frit, is limited by their relatively poor leaching properties. Plastic coatings have been developed for tableware, but these suffer from the same leachability problems as raw glazes, particularly in the presence of organic acids, which are commonly found in food. It is not known to what extent plastic coatings may influence the market for fritted tile glazes. Threats to enamel glazes from substitutes are small. Alternatives, such as paints, could potentially be used in similar applications, but they cannot match the properties of enamels, in terms of heat, chemical and scratch resistance, and "cleanability".

1.10.4 Main Environmental Issues

The main environmental problem associated with frit production is that it is a high temperature, energy intensive process. This results in the emission of products of combustion and the high temperature oxidation of atmospheric nitrogen; i.e. sulphur dioxide, carbon dioxide, and oxides of nitrogen. Furnace emissions also contain dust (arising from the volatilisation and subsequent condensation of volatile batch materials) and traces of chlorides, fluorides and metals present in the raw materials. Frits produced for enamel glazes may result in substantial fluoride emissions due to the use of fluoride containing materials in the batch. Technical solutions are possible for minimising all of these emissions, but each technique has associated financial and environmental implications.

Water is used mainly for cooling and cleaning but also for shattering the molten glass to produce the frit (quenching) and for wet milling. Generally, these water circuits are closed circuits with a purge. Water used for quenching and milling may not need a purge, but will require the solids to be separated.

Waste levels are very low arising mainly from the solids collected from the water circuits. In many cases, waste from dust abatement equipment can be recycled to the furnace.

2 APPLIED PROCESSES AND TECHNIQUES

The first three general sections of this chapter cover the common raw material and melting considerations that apply to most of the sectors in the Glass Industry. The following sections then describe separately the specific issues for each of the sectors. Three of the sectors, namely stone wool, frits and ceramic fibre, differ in some of the materials and techniques utilised. These differences have been covered in the sections relating to each sector.

2.1 Materials Handling

The diversity of the Glass Industry results in the use of a wide range of raw materials. The majority of these materials are solid inorganic compounds, either naturally occurring minerals or man-made products. They vary from very coarse materials to finely divided powders. Liquids and, to a lesser extent, gases are also used within most sectors.

The gases used include hydrogen, nitrogen, oxygen, sulphur dioxide, propane, butane and natural gas. These are stored and handled in conventional ways for example, direct pipelines, dedicated bulk storage, and cylinders. A wide range of liquid materials are used, including some which require careful handling such as phenol and strong mineral acids. All standard forms of storage and handling are used within the industry e.g. bulk storage, intermediate bulk containers (IBCs), drums and smaller containers. Potential techniques for minimising emissions from liquid storage and handling are discussed in Chapter 4.

Very coarse materials (i.e. with particle diameter > 50 mm) are only used in stone wool production. These materials are delivered by rail or road haulage and conveyed either directly to silos or stockpiled in bays. Storage bays can be open, partially enclosed or fully enclosed, there are examples of all within the sector. Where coarse material is stored in silos they are usually open and are filled by a conveyor system. The materials are then transferred to the furnace by enclosed conveyor systems. Materials are mixed simply by laying them on the feeder conveyor simultaneously.

Granular and powdered raw materials are delivered by rail or road tanker and are transferred either pneumatically or mechanically to bulk storage silos. Pneumatic transfer of the materials requires them to be essentially dry. Displaced air from the silos is usually filtered. Lower volume materials can be delivered in bags or kegs and are usually gravity fed to the mixing vessels.

In large continuous processes the raw materials are transferred to smaller intermediate silos from where they are weighed out, often automatically, to give a precisely formulated "batch". The batch is then mixed and conveyed to the furnace area, where it is fed to the furnace from one or more hoppers. Various feeder mechanisms are found in the industry ranging from completely open systems to fully enclosed screw fed systems. To reduce dust during conveying and "carry-over" of fine particles out of the furnace, a percentage of water can be maintained in the batch, usually 0 - 4 % (some processes e.g. borosilicate glass production use dry batch materials). The water content can be introduced as steam at the end of the mixing operation but the raw materials may have an inherent water content. In soda-lime glass, steam is used to keep the temperature above 37°C and so prevent the batch being dried by the hydration of the soda ash.

Due to its abrasive nature and larger particle size, cullet is usually handled separately from the primary batch materials and may be fed to the furnace in measured quantities by a separate system.

In discontinuous processes the batch plant is much smaller and is often manually operated. Following mixing, the batch can be stored in small mobile hoppers each containing one charge

for the melter. Several charges will be made up, sometimes of different formulation, and stored close to the melter for use during a specific melting period. Common with large scale melting the mixed batch cannot be stored for too long before use, because the different components can settle-out, which makes it difficult to obtain an homogenous melt. The presence of water in the batch helps to mitigate this tendency.

2.2 Glass Melting

Melting, the combination of the individual raw materials at high temperature to form a molten glass, is the central phase in the production of glass. There are numerous ways to melt glass depending on the desired product, its end use, the scale of operation, and the prevailing commercial factors. The glass formulation, raw materials, melting technique, fuel choice and furnace size will all depend on these factors.

2.2.1 Raw Materials for Glass Making

[tm18 CPIV, tm21 Schott]

Table 2.1 shows the most important glass making raw materials. A more detailed table is given in Chapter 3.

Glass forming materials
Silica sand, process cullet, post consumer cullet
Intermediate and modifying materials
Soda ash (Na_2CO_3), limestone (CaCO_3), dolomite ($\text{CaCO}_3.\text{MgCO}_3$), feldspar, nepheline syenite, potassium carbonate, fluorspar, alumina, zinc oxide, lead oxide, barium carbonate, basalt, anhydrous sodium sulphate, calcium sulphate and gypsum, barium sulphate, sodium nitrate, potassium nitrate, boron containing materials (e.g. borax, colemanite, boric acid), antimony oxide, arsenic trioxide, blast furnace slag (mixed calcium, aluminium, magnesium silicate and iron sulphide)
Colouring/Decolouring agents
Iron chromite ($\text{Fe}_2\text{O}_3.\text{Cr}_2\text{O}_3$), iron oxide (Fe_2O_3), cobalt oxide, selenium/zinc selenite

Table 2.1: Important glass making raw materials

Sand is the most important raw material for glass making, being the principal source of SiO_2 . It is a common raw material but most deposits are not of sufficient purity for glass making. The melting point of sand is too high for economic melting and a fluxing agent, usually sodium oxide, is needed to reduce the melting temperature.

Soda ash (Na_2CO_3) is the main source of the fluxing agent sodium oxide (Na_2O). During melting the sodium oxide becomes part of the melt and the carbon dioxide is released. Sodium sulphate is added as a refining and oxidising agent and is a secondary source of sodium oxide. The sodium oxide is incorporated into the glass and the sulphur oxide gases are released through the melt. Potassium carbonate (K_2CO_3) acts as a flux and is used in some processes especially for special glass. The potassium oxide is incorporated into the melt and the carbon dioxide is emitted.

Other metal oxides are added to the glass to reinforce the structural network to improve the hardness and chemical resistance. Calcium oxide (CaO) has this effect and is added to the glass as calcium carbonate (CaCO_3) in the form of limestone or chalk. It can also be added as dolomite, which contains both calcium carbonate and magnesium carbonate (MgCO_3).

Aluminium oxide (Al_2O_3) is added to improve chemical resistance and to increase viscosity at lower temperatures. It is usually added as nepheline syenite ($\text{Na}_2\text{O} \cdot \text{K}_2\text{O} \cdot \text{Al}_2\text{O}_3 \cdot \text{SiO}_2$), feldspar, or alumina, but is also present in blast furnace slag and feldspatic sand.

Lead oxides (PbO and Pb_3O_4) are used to improve the sonority and to increase the refractive index of the glass to give better brilliance in products such as lead crystal. Barium oxide (derived from barium carbonate), zinc oxide, or potassium oxide may be used as alternatives to lead oxide, but they produce lower levels of density and brilliance than those associated with lead crystal. There is also a penalty in the workability of handmade glass.

Boron trioxide (B_2O_3) is essential in some products, particularly special glass (borosilicate glasses) and in glass fibres (glass wool and continuous filaments). The most important effect is the reduction of the glass expansion coefficient, but in fibres it also changes viscosity and liquidity to aid fiberisation, and confers resistance to attack by water.

Table 2.2 below shows some of the elements used to impart colour to the glass. The colouring materials can be added either in the main batch or into the canal following the furnace (in the form of coloured frit).

Element	Ion	Colour
Copper	(Cu^{2+})	Light blue
Chromium	(Cr^{3+})	Green
	(Cr^{6+})	Yellow
Manganese	(Mn^{3+})	Violet
Iron	(Fe^{3+})	Yellowish-brown
	(Fe^{2+})	Bluish-green
Cobalt	(Co^{2+})	Intense blue, in borate glasses, pink
	(Co^{3+})	Green
Nickel	(Ni^{2+})	Greyish-brown, yellow, green, blue to violet, depending on the glass matrix.
Vanadium	(V^{3+})	Green in silicate glass; brown in borate glass
Titanium	(Ti^{3+})	Violet (melting under reducing conditions).
Neodymium	(Nd^{3+})	Reddish-violet
Selenium	(Se^0)	Pink (also Se^{2+} , Se^{4+} , and Se^{6+} , depending on glass type)
Praseodymium	(Pr^{3+})	Light green

Table 2.2: Elements used to impart colour

Fluoride containing materials (e.g. fluorspar CaF_2) are used to make certain products opaque. This is achieved by the formation of crystals in the glass, which render it cloudy and opaque. Fluoride is also used in the continuous glass filament sector to optimise surface tension and liquidity properties to aid fiberisation and minimise filament breakage.

An increasingly important raw material in glass making is glass cullet, both in-house cullet and external or foreign cullet. Virtually all processes recycle their in-house cullet, but for some processes quality constraints mean it may not be possible to secure a supply of foreign cullet of sufficient quality and consistency to make its use economically viable. In the container glass sector cullet usage at over 80 % of the batch is sometimes used. Cullet requires less energy to melt than virgin raw materials, and every 1 tonne of cullet replaces approximately 1.2 tonnes of virgin material.

2.2.2 The Melting Process

[tm21 Schott]

The melting process is a complex combination of chemical reactions and physical processes. This section only represents a brief summary of some of the important aspects of the process. Melting can be divided into several phases which all require very close control.

Heating

The conventional and most common way of providing heat to melt glass is by burning fossil fuels above a bath of batch material, which is continuously fed into, and then withdrawn from the furnace in a molten condition. The temperature necessary for melting and refining the glass depends on the precise formulation, but is between 1300°C and 1550°C. At these temperatures heat transfer is dominated by radiative transmission, in particular from the furnace crown, which is heated by the flames to up to 1650 °C, but also from the flames themselves. In each furnace design heat input is arranged to induce recirculating convective currents within the melted batch materials to ensure consistent homogeneity of the finished glass fed to the forming process. The mass of molten glass contained in the furnace is held constant, and the mean residence time is of the order of 24 hours of production for container furnaces and 72 hours for float glass furnaces.

Primary melting

Due to the low thermal conductivity of the batch materials the melting process is initially quite slow allowing time for the numerous chemical and physical processes to occur. As the materials heat up the moisture evaporates, some of the raw materials decompose and the gases trapped in the raw materials escape. The first reactions (decarbonisation) occur around 500°C. The raw materials begin to melt between 750°C and 1200°C. First the sand begins to dissolve under the influence of the fluxing agents. The silica from the sand combines with the sodium oxide from the soda ash and with other batch materials to form silicates. At the same time large amounts of gases escape through the decomposition of the hydrates, carbonates, nitrates and sulphates; giving off water, carbon dioxide, oxides of nitrogen, and oxides of sulphur. The glass melt finally becomes transparent and the melting phase is completed. The volume of the melt is about 35 - 50 % of the volume of the virgin batch materials due to the loss of gases and the elimination of interstitial spaces.

Fining and Homogenisation

The glass melt must be completely homogenised and free of bubbles before it can be formed into the products. This involves the complete dissolution and even distribution of all components and the elimination of all bubbles by refining.

During the melting process gas bubbles are formed mainly from carbon dioxide given off by the decomposition of the carbonate materials (principally soda ash and limestone) and to a much lesser extent from air trapped in the raw materials. These bubbles must be eliminated from the glass melt as they potentially cause defects in the finished product affecting mechanical strength and appearance. The upward movement of bubbles contributes to the physical mixing of the melt necessary to obtain a homogenous material with optimal physical properties. The bubbles rise at speeds determined by their size and the viscosity of the glass. Large bubbles rise quickly and contribute to mixing, while small bubbles move slowly, at speeds that may be small with respect to the larger scale convection currents in the furnace and are thus more difficult to eliminate. Small bubbles remaining in the finished glass are termed "seeds".

Carbon dioxide and the components of air have limited solubility in the glass melt and it is usually necessary to use chemical fining agents to effectively eliminate the small bubbles generated by the melting process. The general principle of chemical fining is to add materials which when in the melt will release gases with the appropriate solubility in the glass. Depending on the solubility of the gas in the glass melt (which is generally temperature dependant) the

bubbles may increase in size and rise to the surface or be completely reabsorbed. Small bubbles have a high surface to volume ratio, which enables better exchange between the gas contained in the bubbles and the glass.

The most frequently used fining agent in the glass industry is sodium sulphate. At approximately 1450°C (1200°C if reducing agents are present) the sodium sulphate decomposes to give sodium oxide (which is incorporated into the glass), gaseous oxides of sulphur, and oxygen. The oxygen bubbles combine with or absorb other gases, particularly carbon dioxide and air, thereby increasing in size and rising to the surface. The gaseous oxides of sulphur are absorbed into the glass, or join the furnace waste gas stream.

In flat glass and container glass production sodium sulphate is by far the most common fining agent. The predominance of sodium sulphate as the fining agent is due to its parallel action as an oxidising agent for adjusting the redox state of the colouring elements in the glass. It is also the least expensive effective fining agent for mass produced glass. Other fining agents include carbon materials and oxides of arsenic and antimony. These are more expensive, have associated environmental and health issues, and tend to be used mainly for the production of special glass. Sodium nitrate can also be used as a fining/oxidising agent particularly if a high degree of oxidation is required. Calcium sulphate and various nitrates are sometimes used for coloured flat glass.

Homogenisation can also be aided by introducing bubbles of steam, oxygen, nitrogen or more commonly air through equipment in the bottom of the tank. This encourages circulation and mixing of the glass and improves heat transfer. Some processes, for example optical glass, may use stirring mechanisms to obtain the high degree of homogeneity required. Another technique for use in small furnaces (especially special glass) is known as plaining; and involves increasing the temperature of the glass so it becomes less viscous and the gas bubbles can rise more easily to the surface.

The maximum crown temperatures encountered in glass furnaces are: container glass 1600°C, flat glass 1620°C, special glass 1650°C, continuous filament 1650°C, and glass wool 1400°C.

Conditioning

A conditioning phase at lower temperatures follows the primary melting and fining stages. During this process, all remaining soluble bubbles are reabsorbed into the melt. At the same time, the melt cools slowly to a working temperature between 900°C and 1350°C.

In batch melting, these steps occur in sequence, but in continuous furnaces the melting phases occur simultaneously in different locations within the tank. The batch is fed at one end of the tank and flows through different zones in the tank and forehearth where primary melting, fining, and conditioning occur. The refining process in a continuous furnace is far more delicate.

Glass does not flow through the tank in a straight line from the batch feeder to the throat where the glass reaches the working temperature for processing. It is diverted following thermal currents. The batch pile, or the cold mixture of raw materials, is not only melted at the surface, but also from the underside by the molten glass bath. Relatively cold, bubbly glass forms below the bottom layer of batch material and sinks to the bottom of the tank. Appropriate convection currents must bring this material to the surface, since fining occurs in tank furnaces primarily at the surface of the melt, where bubbles need to rise only a short distance to escape. If thermal currents flow too fast, they inhibit fining by bringing the glass to the conditioning zone too soon. Guiding walls or weirs can be built into the inner tank structure to create ideal glass flow paths.

2.3 Melting Techniques

[tm18 CPIV]

This section summarises the most important melting techniques used within the glass industry. Different techniques are used within the stone wool and frits sectors, and these techniques are discussed separately within the specific sections for each sector. As mentioned above the choice of melting technique will depend on many factors but particularly the required capacity, the glass formulation, fuel prices, existing infrastructure and environmental performance. For example, as a general guide (to which there are inevitably exceptions):

- For large capacity installations (> 500 t/d) cross-fired regenerative furnaces are almost always employed.
- For medium capacity installations (100 to 500 t/d), regenerative end port furnaces are favoured, though cross-fired regenerative, recuperative unit melters, and in some cases oxy-fuel or electric melters may also be used according to circumstances.
- For small capacity installations (25 to 100 t/d) recuperative unit melters, regenerative end port furnaces, electric melters and oxy-fuel melters are generally employed.

The table below gives an estimate of the different types of furnace existing in the EU, with the numbers and capacities for each type.

Type of furnace	Number of units	Melting capacity (t/y)	Average melting capacity (t/d)
End-fired	265	13100000	135
Cross-fired	170	15300000	250
Electric	100	1100000	30
Oxygen	30	1200000	110
Others	335	4300000	35
Total	900	35000000	110

Table 2.3: Estimate of EU furnace types in 1997 [tm18 CPIV]

Glass furnaces are generally designed to melt large quantities of glass over a continuous period of up to twelve years and range in output from 20 tonnes of glass per day to over 600 tonnes of glass per day. The glass is contained in a tank constructed of blocks of appropriate refractory materials and generally of overall rectangular form closed by a vaulted ceiling or crown. Electrical furnaces tend to be more square with a flat ceiling and open on one side, for batch access. The refractory blocks are maintained in position by an external steel framework. There are many furnace designs in use, and they are usually distinguished in terms of the method of heating, the combustion air preheating system employed, and the burner positioning.

Glass making is a very energy intensive activity and the choice of energy source, heating technique and heat recovery method are central to the design of the furnace. The same choices are also some of the most important factors affecting the environmental performance and energy efficiency of the melting operation. The three main energy sources for glass making are natural gas, fuel oil and electricity. In the first half of the century many glassmakers used producer gas, made by the reactions of air and water with coal at incandescent temperatures.

The use of natural gas is increasing in the Glass Industry due to its high purity, ease of control and the fact that there is no requirement for storage facilities. Many companies are now using gas in preference to oil in order to reduce emissions of sulphur dioxide even where there is a cost penalty.

In recent decades the predominant fuel for glass making has been fuel oil. There are various grades from heavy to light, with varying purity and sulphur content. The generally held opinion within the industry is that oil flames, being more radiant than gas flames, give better heat transfer to the melt. As the industry has developed more experience with gas firing it is thought that the efficiency and operational control achieved with gas firing is progressively approaching that of oil firing.

Many large furnaces are equipped to run on both natural gas and fuel oil, with only a straightforward change of burners being necessary. In many cases gas supply contracts are negotiated on an interruptible basis during peak demand, which necessitates the facility for fuel changeover. The main reason for the periodic change between gas and fuel oil is the prevailing relative prices of the fuels. In order to enhance control of the heat input, it is not uncommon for predominantly gas-fired furnaces to burn oil on one or two ports.

The third common energy source for glass making is electricity. Electricity can be used either as the exclusive energy source or in combination with fossil fuels, this is described in more detail later. Electricity can be used to provide energy in three basic ways: resistive heating, where a current is passed through the molten glass; induction heating, where heat is induced by the change in a surrounding magnetic field; and the use of heating elements. Resistive heating is the only technique that has found commercial application within the Glass Industry, and it is the only technique considered within this document.

2.3.1 Regenerative Furnaces

[tm18 CPIV, tm1 UKDoE]

The term regenerative refers to the form of heat recovery system. Burners firing fossil fuels are usually positioned in or below combustion air/waste gas ports. The heat in the waste gases is used to preheat air prior to combustion. This is achieved by passing the waste gases through a chamber containing refractory material, which absorbs the heat. The furnace fires on only one of two sets of burners at any one time. After a predetermined period, usually twenty minutes, the firing cycle of the furnace is reversed and the combustion air is passed through the chamber previously heated by the waste gases. A regenerative furnace has two regenerator chambers, while one chamber is being heated by waste gas from the combustion process, the other is preheating incoming combustion air. Most glass container plants have either end-fired or cross-fired regenerative furnaces, and all float glass furnaces are of cross-fired regenerative design. Preheat temperatures up to 1400 °C may be attained leading to very high thermal efficiencies.

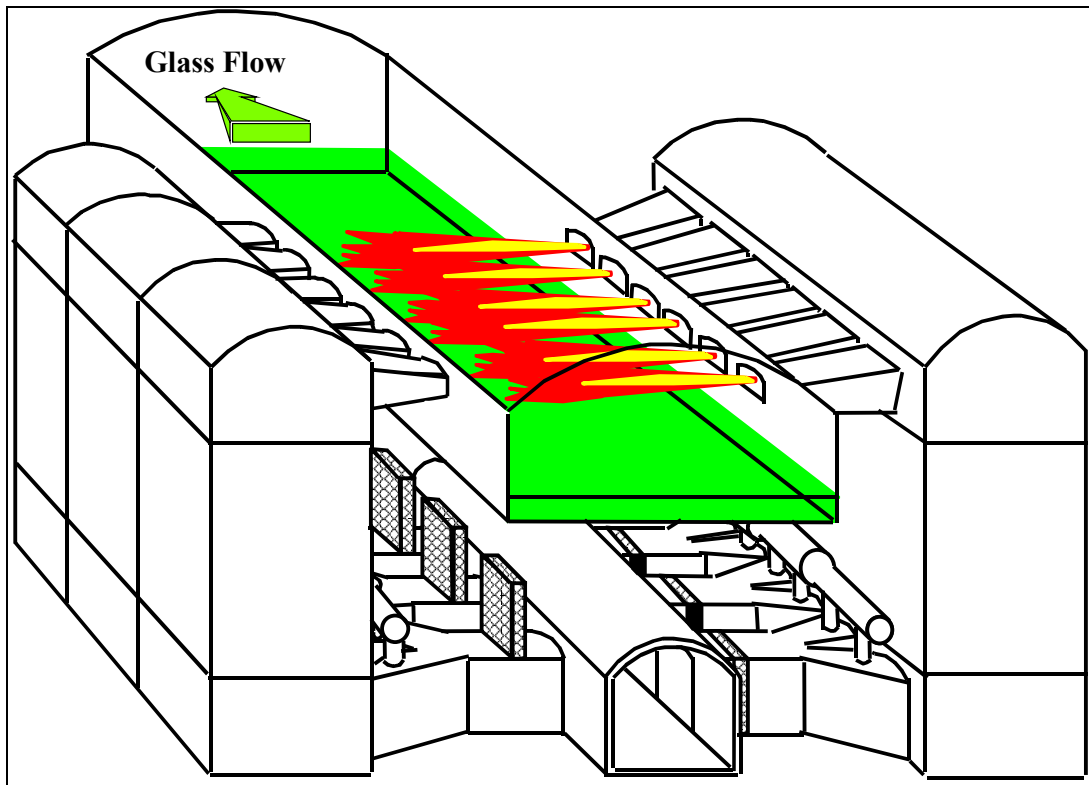

Figure 2.1: A cross-fired regenerative furnace

In the cross-fired regenerative furnace, combustion ports and burners are positioned along the sides of the furnace, regenerator chambers are located either side of the furnace and are connected to the furnace via the port necks. The flame passes above the molten material and directly into the opposite ports. The number of ports (up to 8) used is a function of the size and capacity of the furnace and its particular design. Some larger furnaces may have the regenerator chambers divided for each burner port.

This type of design using effectively a multiplicity of burners is particularly suited to larger installations, facilitating the differentiation of the temperature along the furnace length necessary to stimulate the required convection currents in the glass melt.

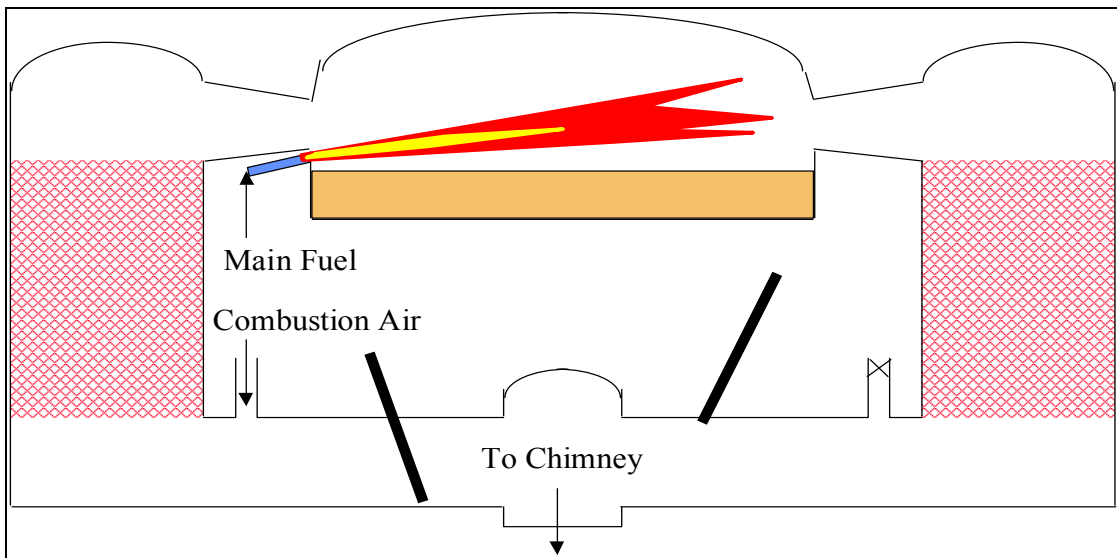

Figure 2.2: Cross section of a regenerative furnace

In the end-fired regenerative furnace the principles of operation are the same, however, the two regenerative chambers are situated at one end of the furnace each with a single port. The flame path forms a U shape returning to the adjacent regenerator chamber through the second port. This arrangement enables a somewhat more cost effective regenerator system than the cross-fired design but has less flexibility for adjusting the furnace temperature profile and is thus less favoured for larger furnaces.

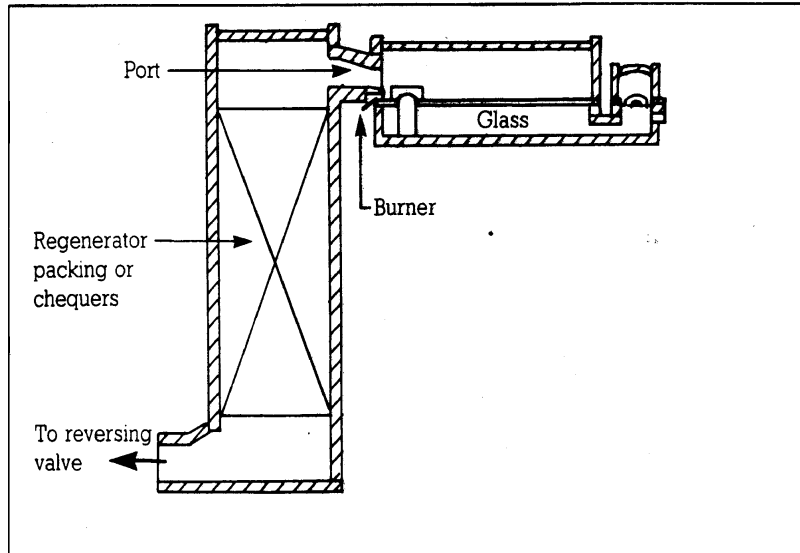

Figure 2.3: Single pass end-fired regenerative furnace

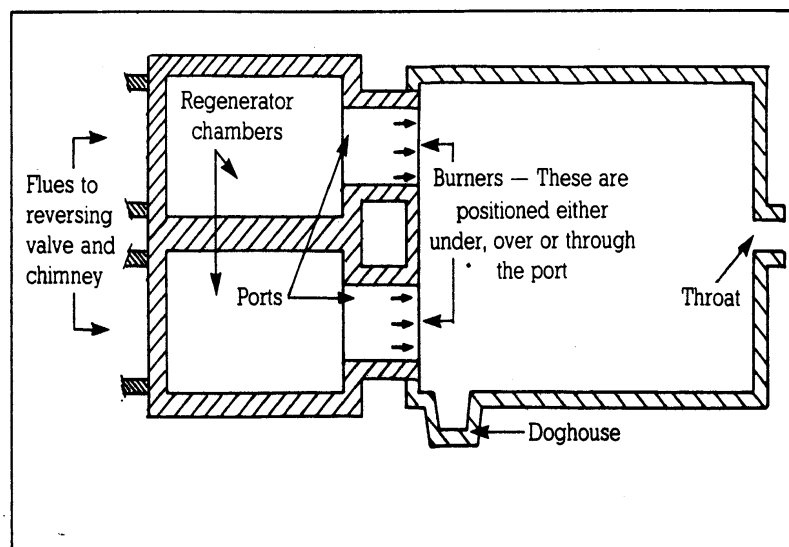

Figure 2.4: Plan view of end-fired regenerative furnace

2.3.2 Recuperative Furnaces

[tm18 CPIV]

The recuperator is another common form of heat recovery system usually used for smaller furnaces. In this type of arrangement the incoming cold air is pre-heated indirectly by a continuous flow of waste gas through a metal (or, exceptionally, ceramic) heat exchanger. Air preheat temperatures are limited to around 800°C for metallic recuperators, and the heat

recovered by this system is thus lower than for the regenerative furnace. The lower direct energy efficiency may be compensated by additional heat recovery systems on the waste gases, either to preheat raw materials or for the production of steam. However, one consequence is that the specific melting capacity of recuperative furnaces is limited to 2 tonnes/m²/day compared to typically 3.2 tonnes/m²/day for a regenerative furnace in the Container Glass Sector. This lack of melting capacity can be partially compensated by the use of electric boosting.

Although originally unit melters (or direct fired) furnaces were not necessarily equipped with recuperators this is now exclusively the case and the term unit melter has become synonymous with the recuperative furnace. The burners are located along each side of the furnace, transverse to the flow of glass, and fire continuously from both sides. This allows better control and more stable temperatures than in end-fired furnaces. By controlling the burners to create a temperature gradient along the furnace, the convective currents generated draw the hot combustion gases over the batch surface and up through the exhaust port at the upstream end of the furnace.

This type of furnace is primarily used where high flexibility of operation is required with minimum initial capital outlay, particularly where the scale of operation is too small to make the use of regenerators economically viable. It is more appropriate to small capacity installations although higher capacity furnaces (up to 400 tonnes per day) are not uncommon.

2.3.3 Oxy-fuel Melting

This technique involves the replacement of the combustion air with oxygen (>90 % purity). The elimination of the majority of the nitrogen from the combustion atmosphere reduces the volume of the waste gases, which are composed almost entirely of carbon dioxide and water vapour, by about two thirds. Therefore, energy savings are possible because it is not necessary to heat the atmospheric nitrogen to the temperature of the flames. The formation of thermal NO_x is greatly reduced, because the only nitrogen present in the combustion atmosphere is the residual nitrogen in the oxygen, nitrogen in the fuel, nitrogen from nitrate breakdown, and that from any parasitic air.

In general oxy-fuel furnaces have the same basic design as unit melters, with multiple lateral burners and a single waste gas exhaust port. However, furnaces designed for oxygen combustion do not utilise heat recovery systems to pre-heat the oxygen supply to the burners.

The principle of oxy-fuel furnaces is well established, particularly in the frits sector. The technique is still considered by some sectors of the glass industry, as a developing technology with potentially high financial risk. However, considerable development work is being undertaken and the technique is becoming more widely accepted as the number of plants is increasing. This technique is discussed further in Chapter 4.

2.3.4 Electric Melting

[tm18 CPIV, tm8 S2 3.03, tm1 UKDoE]

An electric furnace consists of a refractory lined box supported by a steel frame, with electrodes inserted either from the side, the top or more usually the bottom of the furnace. The energy for melting is provided by resistive heating as the current passes through the molten glass. It is, however, necessary to use fossil fuels when the furnace is started up at the beginning of each campaign. The furnace is operated continuously and has a lifetime of between 2 and 7 years. The top of the molten glass is covered by a layer of batch material, which gradually melts from the bottom upwards, hence the term cold top melter. Fresh batch material is added to the top of the furnace, usually by a conveyor system that moves across the whole surface. Most electric furnaces are fitted with bag filter systems and the collected material is recycled to the melter.

The technique is commonly applied in small furnaces particularly for special glass. The main reason for this is the thermal efficiency of fossil fuel fired furnaces decreases with furnace size and heat losses per tonne of melt from small furnaces can be quite high. Heat losses from electric furnaces are much lower in comparison, and for smaller furnaces the difference in melting costs between electrical and fossil fuel heating is therefore less than for larger furnaces. Other advantages of electric melting for small furnaces include lower rebuild costs, comparative ease of operation and better environmental performance.

There is an upper size limit to the economic viability of electric furnaces, which is closely related to the prevailing cost of electricity compared with fossil fuels. Electric furnaces can usually achieve higher melt rates per square metre of furnace, and the thermal efficiency of electric furnaces is two to three times higher than fossil fuel fired furnaces. However, for larger furnaces this is often not sufficient to compensate for the higher costs of electricity.

The absence of combustion in electric melting means that the waste gas volumes are extremely low, resulting in low particulate carry over and reduced size of any secondary abatement equipment. The emission of volatile batch components is considerably lower than in conventional furnaces due to the reduced gas flow and the absorption and reaction of gaseous emissions in the batch blanket. The main gaseous emission is carbon dioxide from the carbonaceous batch materials.

The complete replacement of fossil fuels in the furnace eliminates the formation of combustion products, namely sulphur dioxide, thermal NO_x, and carbon dioxide. However, if a global view is taken these benefits should be considered against the releases arising at the power generation plant, and the efficiencies of power generation and distribution.

A complication with electric melting is the use of sodium nitrate or potassium nitrate in the batch. The general view of the glass industry is that nitrate is required in cold-top electric furnaces to provide the necessary oxidising conditions for a stable, safe and efficient manufacturing process. The problem with nitrate is that it breaks down in the furnace to release oxides of nitrogen, but at levels lower than those associated with conventional fossil fuel firing.

2.3.5 Combined Fossil Fuel and Electric Melting

[tm18 CPIV, tm8 S2 3.03]

There are two principal approaches to the use of this technique: predominantly fossil fuel firing with electric boost; or predominantly electrical heating with a fossil fuel support. Clearly the proportion of each type of heat input can be varied with each technique.

Electric boosting is a method of adding extra heat to a glass furnace by passing an electric current through electrodes in the bottom of the tank. The technique is commonly used within fossil fuel fired furnaces in the Glass Industry. Traditionally, it is used to increase the throughput of a fossil fuel fired furnace to meet periodic fluctuations in demand, without incurring the fixed costs of operating a larger furnace. The technique can be installed while a furnace is running, and it is often used to support the pull rate of a furnace as it nears the end of its operating life or to increase the capacity of an existing furnace.

Electric boosting can also be used to improve the environmental performance of the furnace by substituting electrical heating for combustion for a given glass pull rate. Usually 5 % to 20 % of total energy input would be provided by electric boost although higher figures can be achieved. However, a high level of electric boost is not used as a long-term option for base level production due to the associated high operating costs. Variable levels of electric boost are frequently used in coloured glass due to the poor radiant heat transfer in green and amber glass.

A less common technique is the use of gas or oil as a support fuel for a principally electrically heated furnace. This simply involves firing flames over the surface of the batch material to add heat to the materials and aid melting. The technique is sometimes referred to as over-firing and is often used to overcome some of the operational difficulties encountered with 100 % electric melting. Clearly the technique reduces some of the environmental benefits associated with combustion free cold top melting.

2.3.6 Discontinuous Batch Melting

[tm21 Schott]

Where smaller amounts of glass are required, particularly if the glass formulation changes regularly, it can be uneconomical to operate a continuous furnace. In these instances pot furnaces or day tanks are used to melt specific batches of raw material. Most glass processes of this type would not fall under the control of IPPC because they are likely to be less than 20 tonnes per day melting capacity. However, there are a number of examples in domestic glass and special glass where capacities above this level exist, particularly where more than one operation is carried out at the same installation.

A pot furnace is usually made of refractory brick for the inner walls, silica brick for the vaulted crown and insulating brick for the outer walls. Basically a pot furnace consists of a lower section to preheat the combustion air (either a regenerative or a recuperative system), and an upper section which holds the pots and serves as the melting chamber. The upper section holds six to twelve refractory clay pots, in which different types of glass can be melted.

There are two types of pots open pots and closed pots. Open pots have no tops and the glass is open to the atmosphere of the furnace. Closed pots are enclosed and the only opening is through the gathering hole. With open pots the temperature is controlled by adjusting furnace firing, with closed pots firing is at a constant rate, and the temperature is controlled by opening or closing the gathering hole. The capacity of each pot is usually in the range 100 kg to 500 kg, with a lifetime of 2 to 3 months under continuous operation.

The furnace is heated for 24 hours each day but the temperature varies (glass temperature only for closed pots) according to the phase of the production cycle. Generally, the batch is loaded into the pots and melted in the afternoon, and the temperature is increased overnight to refine the melt so the glass can be processed the next morning. During melting the temperature climbs to between 1300°C and 1600°C, depending on the glass type, and during the removal and processing of the glass the furnace temperature is in the range 900°C to 1200°C.

Day tanks are further developed from pot furnaces to have larger capacities, in the region of 10 tonnes per day. Structurally they more closely resemble the quadrangle of a conventional furnace, but are still refilled with batch each day. The melting is usually done at night and the glass goes into production the next day. They allow a change in glass type to be melted at short notice and are primarily used for coloured glass, crystal glass and soft special glasses.

2.3.7 Special Melter Designs

[SORG LoNOx, SORG Flex]

The attention paid to limiting NOx emissions has led some furnace designers to propose unit melter type furnaces that integrate various features intended to permit lower flame temperatures. The best known of this type of furnace is the Sorg LoNOx melter.

The Sorg LoNOx melter uses a combination of shallow bath refining and raw material preheating to achieve reduced NOx levels, potentially without the penalty of reduced thermal performance. The shallow bath refiner forces the important critical current path close to the surface of the glass bath, thereby reducing the temperature differential between it and the

furnace superstructure. The furnace can be operated at lower temperatures than a comparable conventional furnace. This technique is described more fully in Chapter 4.

Another new furnace design is the Sorg Flex Melter, which is principally marketed as an alternative to pot furnaces and day tanks. It uses a combination of electricity and natural gas resulting in a compact furnace with low operating temperatures and low energy consumption. The furnace is divided into melting and refining zones, which are connected by a throat. The refining area consists of a shallow bank followed by a deeper area. The melting end is electrically heated and the refining zone is gas heated, but electrodes may be added at the entrance. The waste gases from the refining zone pass through the melting area and over the batch. A number of low arches prevent radiation from the hotter part of the furnace reaching the colder areas, so that a large part of the energy in the waste gases is transferred to the batch.

The separation of the melting and refining zones is the basis of the furnace's flexibility. During standstill periods temperatures are lowered and volatilisation from refining is reduced. No drain is needed and due to the low glass volume, normal operating temperature is re-established quickly. The low volume also helps to make faster composition changes.

2.4 Container Glass

[tm18 CPIV, tm1 UKDoE]

This section deals with the manufacture of packaging glass based on soda-lime and modified soda-lime formulations by fully automated processes. The manufacture of other products is covered in the Domestic and Special Glass Sectors. Typical container glass composition is given in Table 2.4 below. Due to the diversity of the sector almost all of the melting techniques described in Section 2.3 are found in container glass production.

Component	Percentage
Silicon Oxide (SiO ₂)	71 – 73
Sodium Oxide (Na ₂ O)	12 - 14
Calcium Oxide (CaO)	9 – 12
Magnesium Oxide (MgO)	0.2 – 3.5
Aluminium Oxide (Al ₂ O ₃)	1 – 3
Potassium Oxide (K ₂ O)	0.3 – 1.5
Sulphur trioxide (SO ₃)	0.05 – 0.3
Colour modifiers etc.	Traces

Table 2.4: Typical container glass composition

Glass containers are produced in a two stage moulding process by using pressing and blowing techniques. There are five essential stages in automatic bottle production.

1. Obtaining a piece of molten glass (gob) at the correct weight and temperature.
2. Forming the primary shape in a first mould (blank mould) by pressure from compressed air or a metal plunger.
3. Transferring the primary shape (parison) into the final mould (finish mould).
4. Completing the shaping process by blowing the container with compressed air to the shape of the final mould.
5. Removing the finished product for post forming processes.

The molten glass flows from the furnace along a forehearth to a gathering bowl (spout) at the end. From the bottom of the gathering bowl one to four parallel streams of glass are formed through appropriately sized orifices. These glass streams, modulated by a mechanical plunger system, are cut into accurate lengths by a shear mechanism to form primitive, sausage shaped,

glass "gobs". The complete system for forming the gobs is termed the feeder mechanism. Gobs are cut simultaneously from the parallel glass streams, to be formed simultaneously in parallel moulds on the forming machine. These are termed single, double, triple or quadruple gob machines, the latter being adapted to high volume production of smaller containers. Double gob is the most common. Container glass furnaces feed two or more such forming machines, each via a dedicated forehearth.

A mixture of water and soluble oil is sprayed onto the shears to ensure they do not overheat and that the glass does not stick to them. From the feeder mechanism the gobs are guided by a system of chutes into the blank moulds on the forming machine.

The forming process is carried out in two stages as shown in Figure 2.5. The initial forming of the blank may be made either by pressing with a plunger, or by blowing with compressed air, according to the type of container. The final moulding operation is always by blowing to obtain the finished hollow shape. These two processes are thus respectively termed "press and blow" and "blow and blow". The formed containers are presented for post forming production stages on a continuous conveyor. Press and blow forming is particularly adapted to producing jars, but is also widely used for producing lightweight bottles. Blow and blow forming is more versatile and is preferred for producing standard weight bottles and more complex forms. Simplified diagrams of the two main forming processes are shown in Figure 2.5.

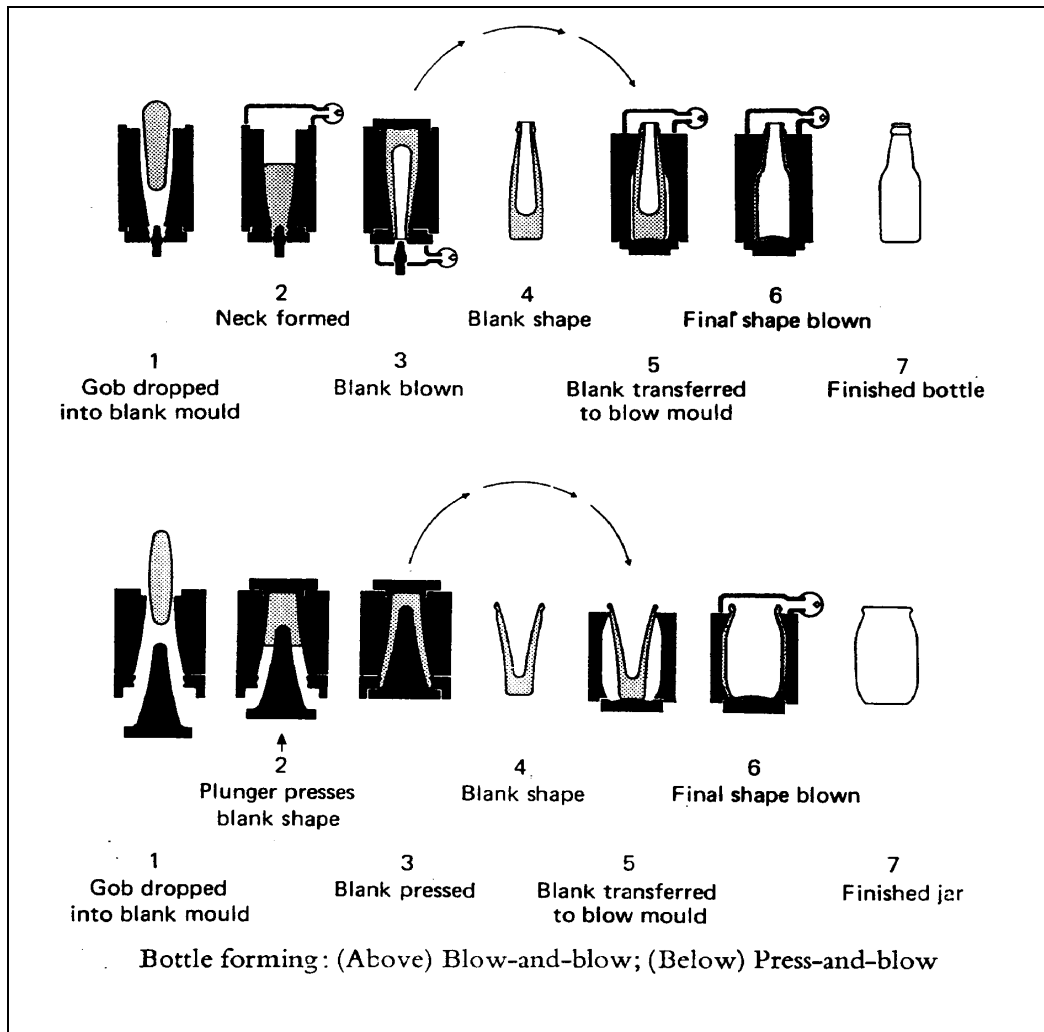

Figure 2.5: Press and blow forming and blow and blow forming

During the forming process the glass temperature is reduced by as much as 600°C to ensure that the containers are sufficiently solidified when taken away by conveyor. The extraction of heat is achieved with high volumes of air blown against and through the moulds. To prevent glass sticking to the moulds various high temperature graphite based release agents are applied manually and automatically to specific mould parts (“swabbing”). The moulds require periodic cleaning and maintenance.

Glass flow from the forehearth must be held constant in order to maintain the necessary temperature stability, viscosity and homogeneity of the glass fed to the forming process. If the forming process is interrupted on one of the sections the gobs of hot glass are diverted by chutes to the basement, where they are cooled with water, fragmented, and returned to the batch house along with all other production rejects to be recycled as process cullet.

The earliest automatic machines were of rotating design, and although forming machines for tableware still use this principle, container production is almost exclusively by the more flexible in line IS (Individual Section) machines. The IS machine consists of multiple individual container making units (sections) assembled side by side. Each section has mould cavities corresponding to the number of gobs to be formed in parallel. The gobs are delivered sequentially to the different sections via a scoop and trough system (gob distributor and delivery). Typically IS machines are made up of from 6 to 20 sections, depending on the volume and type of market served. One major advantage of IS machines is the possibility of independently stopping the sections for adjustments or replacing mould parts.

Automatic container manufacture can be used to produce bottles and jars of almost any size, shape and colour. The simpler the shape the faster the production rate; lightweight round beer bottles are produced at up to 750 /minute (on IS 12 section, quadruple gob machines).

Rapid cooling of the containers on the outside surface creates high differential stresses in the glass and consequent fragility. To eliminate these the containers are passed through a continuous annealing oven (lehr), where they are re-heated to 550°C then cooled under controlled conditions to prevent further stresses being set up. Lehrs are heated by gas or electricity but once brought to operating temperature the heat from the incoming containers provides the majority of the heating energy. Once sufficiently cool all containers are inspected automatically with automatic rejection for out of tolerance and other quality concerns. After inspection the product is assembled onto pallets either in cartons or in bulk and packed and stored before shipment to the customer.

The overall efficiency of the production is measured as a "pack to melt" ratio, i.e. the tonnage of containers packed (for shipment) as a percentage of the tonnage of glass melted in the furnace. Installations making containers for foodstuffs and beverages generally attain pack to melt ratios between 85 % and 94 %. Higher value perfume and pharmaceutical products are subject to more stringent controls, and pack to melt ratios average around 70 %.

To improve the performance of the products, surface coatings can be applied either immediately after forming, while the articles are still at a temperature over 500°C (“hot end coating”), or after annealing (“cold end coating”). Practically always a combination of hot end and cold end treatments are employed.

Glass containers are conveyed through various inspection, packaging, unpacking, filling and re-packaging systems. To prevent damage between containers and to enable them to slide through guide systems without damage; lubricating treatments can be applied to the product at the cold end of the annealing lehr. The materials used are food safe oleic acid and polyethylene based products applied by spraying a dilute aqueous suspension, or by contact with vapours. These treatments do not, in general, give rise to significant environmental emissions.

Hot surface coatings, usually a very fine coating of tin oxide or titanium oxide can be applied to the glass containers immediately after leaving the forming machine. In combination with

subsequent lubricating cold surface coating, this prevents glass surface damage during subsequent handling. The metal oxide coating acts as a substrate to retain the lubricating organic molecules on the glass surface, and this permits a high level of scratch resistance to be developed with simple food safe lubricants. The hot end treatment also improves mechanical resistance.

The treatments themselves must be invisible and are thus extremely thin. The thickness of the hot surface treatment is generally $< 0.01 \mu\text{m}$. To obtain uniform coatings of this thickness the treatment is most frequently made by chemical vapour deposition (CVD), using the anhydrous chlorides of tin or titanium, or specific organo-metallic compounds. Application by spray is also employed. The quantity of material involved is in all cases low, in the order of 2 to 10 kg/day per production line according to production speed.

Once manufactured glass containers may in certain cases go through a secondary process to add decoration and identity before being sent to the customer. This can take the form of a pressure sensitive or heat shrink label or heat applied ceramic decoration.

2.5 Flat Glass

[tm18 CPIV]

The term flat glass strictly includes all glasses made in a flat form regardless of the form of manufacture. However, for the purposes of this document it is used to describe float glass and rolled glass production. Most other commercially produced flat glasses are either covered in the Special Glass Sector (e.g. ceramic hobs) or the scale of production is below the 20 tonnes/day specified in Directive 96/61/EC. Other methods of producing large quantities of flat glass for building and automotive applications are considered obsolete in the European Union. These products are referred to as sheet glass and plate glass, and are discussed briefly in Chapter 1. Most flat glass is produced with a basic soda lime formulation, a typical float glass composition is given in Table 2.5. Float glass and rolled glass are produced almost exclusively with cross-fired regenerative furnaces.

Component	Percentage
Silicon oxide (SiO_2)	72.6
Sodium oxide (Na_2O)	13.6
Calcium oxide (CaO)	8.6
Magnesium oxide (MgO)	4.1
Aluminium oxide (Al_2O_3)	0.7
Potassium oxide (K_2O)	0.3
Sulphur trioxide (SO_3)	0.17
Minor materials (colour modifiers and incidental impurities from raw materials)	Traces

Table 2.5: Typical flat glass composition

2.5.1 The Float Glass Process

The basic principle of the float process is to pour the molten glass onto a bath of molten tin, and to form a ribbon with the upper and lower surfaces becoming parallel under the influence of gravity and surface tension.

The float tank (or bath) consists of a steel casing supported by a steel framework, and lined with refractory blocks which contain the molten tin. The float tank is about 55m to 60m long, 4m to 10m wide and divided into 15 to 20 bays. The tank is airtight and a slightly reducing atmosphere is maintained by the injection of a mixture of nitrogen and hydrogen. This is

essential to prevent the oxidation of the tin surface, which would damage the crucial contact surface between the glass and the tin. Molten tin is used as the bath liquid because it is the only substance which remains liquid and without a significant vapour pressure over the required temperature range.

The molten glass flows from the furnace along a refractory lined canal, which can be heated to maintain the correct glass temperature. At the end of the canal the glass pours onto the tin bath through a special refractory lip ("the spout") which ensures correct glass spreading. The glass flow is controlled by means of an adjustable suspended refractory shutter in the canal (the front "tweel"). Where the glass first makes contact with the tin, the temperature of the metal is about 1000°C cooling to about 600°C at the exit of the bath. As it passes over the surface of the bath the glass develops a uniform thickness and assumes the almost perfect flatness of the molten tin.

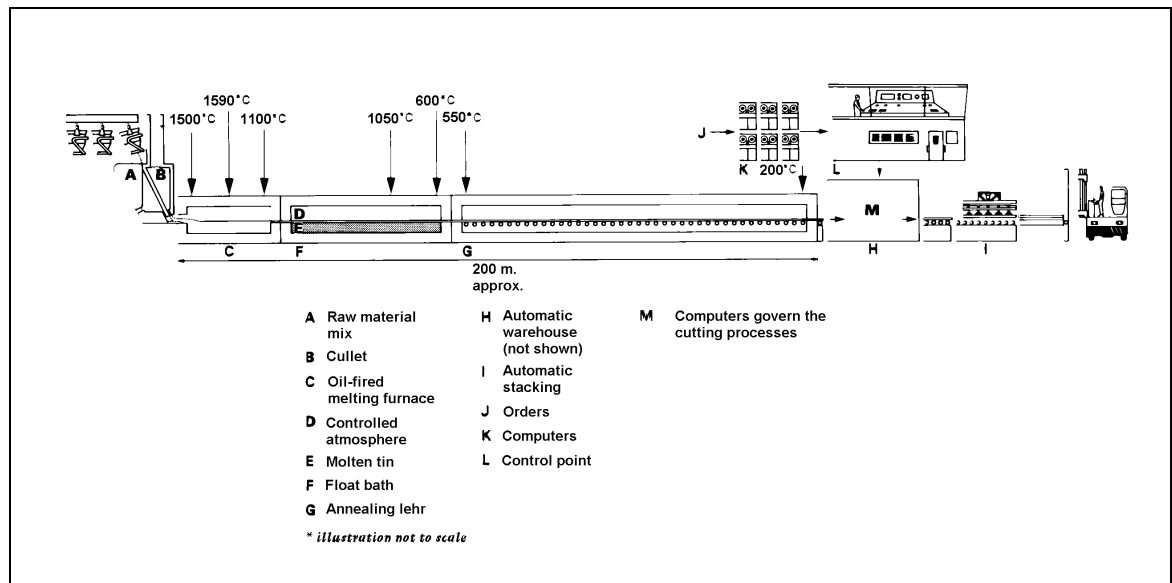

Figure 2.6: The Float Glass Process

Inside the float tank are several pairs of water-cooled top rollers, adjustable in direction, height, penetration and angle. These rollers catch the glass sheet on both edges by cog-wheels and draw it in length and width. The rate of glass flow and the rotation speeds of the rollers help to govern the thickness of the glass, typically from 1.5 mm to 19 mm. The glass has a maximum natural thickness on the tin surface and graphite barriers can be introduced in order to produce the thicker glasses.

At the exit of the float bath the glass ribbon is taken out by lift-out rollers, and is passed through a temperature controlled tunnel, the lehr, to be annealed. At the beginning of the lehr, SO_2 is sprayed on both sides of the ribbon, providing a surface treatment to protect the glass against the contact of the rollers. The lehr is divided in sections in which there is heating and indirect or direct cooling by forced and natural convection. Glass is thus gradually cooled from 600°C to 60°C in order to reduce residual stresses, caused during the forming process, to an acceptable level. This operation needs time and space, from the pouring of glass onto the float bath to the cutting line, there is a continuous 200 m ribbon of glass.

The cooled glass ribbon is cut on-line by a travelling cutter, the angle of the cutter against the line depends on the speed of the line (90° if it was not moving). The edges of the ribbon that bear roller marks are cut off and recycled to the furnace as cullet. The glass sheets are then inspected, packed and stored, either for sale or for secondary processing.

On-line coatings can be applied to improve the performance of the product (e.g. low emissivity glazing). On-line coating processes are case specific and the total number of plants within the

industry with on-line coating facilities is very low. A moving ribbon of glass is coated whilst hot by the impingement onto its surface of silica or tin compounds where they react to form the required film. The process generally consists of two separate coating stages, a silicon based undercoat and a separate topcoat, e.g. fluorine doped tin oxide. Due to the nature of the chemicals used, emissions of acid gases and fine particulates can arise, which are generally treated in a dedicated abatement system.

2.5.2 The Rolled Process (Patterned and Wired Glass)

A schematic representation of the Rolled Glass Process is shown in Figure 2.7 below.

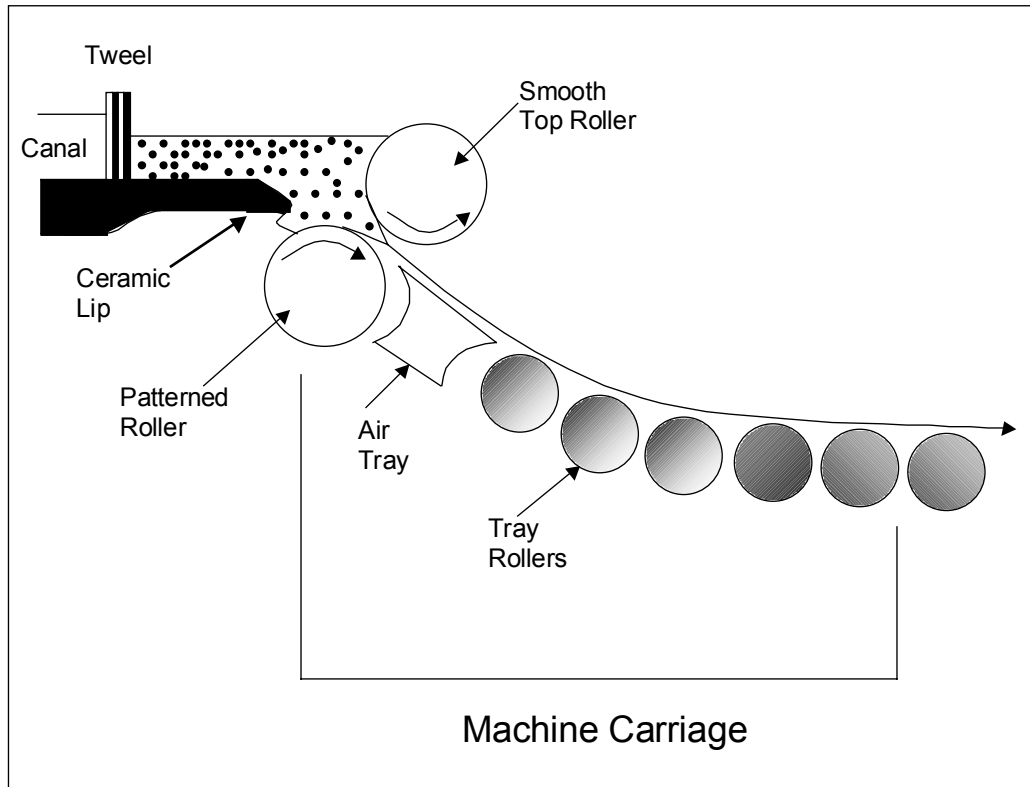

Figure 2.7: The Rolled Glass Process

Rolled glass is formed by a continuous double-roll process. Molten glass at about 1000°C is squeezed between water-cooled steel rollers to produce a ribbon with controlled thickness and surface pattern.

The glass is conveyed from the melting furnace into a forehearth in order to reach the required temperature upstream of the roller pass. Depending on the furnace capacity and the desired output, one or two machines can be fed from one furnace. The rotating rollers pull molten glass into the pass, from which it emerges as a ribbon of thickness determined by the separation between the rollers. A typical ribbon width is about 2 metres. In passing through the water-cooled rollers, heat is extracted. Control of the temperature at the interface is essential to the correct operation of the process and the quality of the product. When emerging from the rollers, the ribbon is viscous enough to avoid significant narrowing and to be carried forward over moving rollers for about 2 metres. There it is further cooled and carried forward into the annealing lehr at about 600°C.

In this process, the rollers serve three functions: to form the ribbon, to imprint the chosen pattern, and to remove heat. The rollers must be very accurately machined with perfect axial symmetry and a uniform pattern without any defect over the whole roller surface.

The range of patterns produced is very wide so that frequent changes must be made to meet market demands. Thus, one important consideration of machine design is the ease with which a pattern roller can be changed. The most usually adopted solution is to set up two rolling machines side by side on a switch rail. In this way, the new pattern rollers can be mounted in the spare machine ready to be pushed into place when the changeover is needed. This operation requires the flow of glass to be stopped by means of a metallic boom placed in the canal upstream of the rollers.

The rolling process has been extended to produce wire-reinforced glass. There are two different techniques employed. In the first, two canals are used to provide two flows of glass to the forming machine, but in the second method only one flow of glass and one canal are required. A wire mesh is fed down from a roll suspended above the machine and guided into the so-called bolster of glass that is formed by the glass flow entering the space between two rollers. Specification, control and conditioning of the wire mesh are of great importance for the quality of the product.

2.6 Continuous Filament Glass Fibre

[tm18 CPIV, tm8 S2 3.03]

The most widely used composition to produce continuous fibres is E Glass, which represents more than 98 % of the sector output. The typical E Glass composition is shown in Table 2.6. Other compositions are also used to produce continuous filaments, but only very small quantities are produced in the EU. The melting techniques used for these other formulations are very specific and are not generally representative of the techniques used in the sector as a whole. For the purposes of this document only E Glass production is considered.

Component	Percentage
SiO ₂	53 - 60
Alkali oxides	< 2
Earth alkali oxides	20 - 24
B ₂ O ₃	5 - 10
Al ₂ O ₃	11 - 16
ZrO ₂	0
TiO ₂	0 - 3
F ₂	0 - 2
Iron oxide	< 1
Zinc oxide	0
Impurities	<1

Table 2.6: Typical E Glass composition

The glass melt for continuous filament glass fibre is generally produced in a cross-fired fossil fuel recuperative furnace. There are also a number of oxy-fuel fired furnaces in Europe, but these have only been operating for a limited period. Regenerative furnaces are not used due to the relatively small furnace sizes, and because at the temperature in the regenerators the borate condensation would be difficult to control. The most commonly used glass formulation in this sector is E Glass, which has a very low alkali content resulting in low electrical conductivity. It is not currently considered economically viable to melt E Glass using 100 % electric melting.

The molten glass flows from the front end of the furnace through a series of refractory lined, gas heated canals to the forehearth. In the base of each forehearth there are bushings to allow the

flow of glass. Bushings are complex box-like structures with a perforated metal plate (bushing plate) at the base, with several hundred calibrated holes (bushing tips). The bushing is electrically heated and its temperature is precisely regulated over the whole surface in order to obtain a consistent rate of flow of molten glass from each hole.

The glass flowing through the bushing tips is drawn out and attenuated by the action of a high-speed winding device to form continuous filaments. Specific filament diameters in the range of $5\mu\text{m}$ to $24\mu\text{m}$ are obtained by precisely regulating the linear drawing speed (which may vary from 5 m/s to 70 m/s). Directly under the bushing, the glass filaments undergo a drastic cooling by the combined effect of water-cooled metal fins, high airflow, and water sprays.

The filaments are drawn together and pass over a roller or belt, which applies an aqueous mixture, mainly of polymer emulsion or solution to each filament. The coating is also referred to as binder or size and serves one or both of two purposes: protecting the filaments from their own abrasion during further processing and handling operations; and for polymer reinforcements, ensuring good adhesion of the glass fibre to the resin. The binder content on the filaments is typically in the range of 0.5 % to 1.5 % by weight. The coating material will vary depending on the end use of the product. Typical coating components are: film formers (e.g. polyvinyl acetate, starch, polyurethane, epoxy resins); coupling agents (e.g. organo-functional silanes); pH modifiers (e.g. acetic acid, hydrochloric acid, ammonium salts); and lubricants (e.g. mineral oils, surfactants).

The coated filaments are gathered together into bundles called strands that go through further processing steps, depending on the type of reinforcement being made. The strands can undergo either conventional or direct processing. In conventional processing, the strands are wound onto the rotating mandrel of the winder to form “cakes” up to 50 kg in weight. The cakes containing the binder up to 1.5 % and water up to 15 %, are labelled and pass forward for fabrication. For some applications the cakes can be processed wet, but for most they have to pass through drying ovens. The ovens are heated by gas, steam, electricity, or indirectly by hot air. The main products are chopped strands, rovings, chopped strand mats, yarns, tissues, and milled fibres.

Chopped strands are produced by unwinding the cakes and feeding the filaments into a machine with a rotating bladed cylinder. The chopped strands are typically between 3 mm and 25 mm, and are conveyed into a variety of packages up to 1 tonne in weight. Rovings are produced by unwinding and combining the strands from multiple cakes, sufficient to achieve the desired weight of glass per unit length.

Chopped strand mat is produced by chopping the strands unwinding from cakes, or rovings, in cylindrical choppers. The choppers are arranged so that chopped strands can be applied to a moving conveyor belt up to 3.5 m wide. The strands are sprayed with a secondary binder, e.g. an aqueous solution of polyvinyl acetate or saturated polyester powder. Total binder content is in the range 2 % to 10 %. The conveyor takes the now wet mat through a drying and curing oven, and then through a pair of compaction rollers before winding the mat onto a mandrel. The mat can be made in various densities and widths and is packed into boxes with a typical weight of 50 kg.

Yarn products are produced from either dried forming cakes or from wet cakes, where the drying of the strands takes place during the twisting operation. The yarn is made on a twisting machine (or twist frame) which holds up to 100 cakes, containing any combination of different strands. The strands are brought together, twisted into a yarn and wound onto a bobbin. This is a complex process similar to that used in the textile industry. Usually the twisting machine will produce only one yarn from a single strand, but (although less common) multiple wound yarns are also produced.

The glass fibre tissue is produced by chopping the strands unwound from the cakes in cylindrical choppers, which feed either directly into a pulper or into intermediate bulk containers for later use. After dispersion in the pulper, the fibres are applied to a wire mesh

conveyer belt by the wet-laid method. An aqueous solution of different types of resins, polyvinyl alcohol and latex is added as a binder at up to 20 % (dry content). The wire takes the web through a drying and curing oven before winding the tissue onto a tambour. The glass fibre tissue can be made in various densities and widths.

Milled fibres are made by milling cakes or chopped strands into lengths of 50 - 300 μm . The milled fibres are conveyed into a variety of packages from 20 kg up to 1 tonne.

Chopped strands, rovings, and continuous filament mats can also be produced by direct processes. Chopped strands are produced by directly introducing the strand, following coating, into a high-speed chopper. The strands are collected and, depending on the product use, either packaged wet or are dried. Direct rovings are produced using a bushing plate with a particular number of holes of different diameters, corresponding to the desired product. The filaments can be coated and the roving dried in the normal way. Continuous filament mat is produced by directly laying the strands onto a moving conveyor and spraying with an aqueous or powder binder. A special device is used to ensure correct deposition of the filaments on the conveyor. The mat passes through a drying oven and compaction rollers, before being wound onto a mandrel and packed.

2.7 Domestic Glass

[tm27 Domestic]

This sector is one of the most diverse sectors of the Glass Industry, involving a wide range of products and processes. Processes range from intricate handmade activities producing decorative lead crystal, to the high volume, highly mechanised methods used to make lower value bulk consumer products. The majority of domestic glass is made from soda-lime glass with formulations close to those of container glass. However, the formulations are generally more complex due to specific quality requirements and the more varied forming processes. As with container glass, colouring agents can be added either in the furnace or in the feeder. The other main types of domestic glass are:

1. Opal (opaque) glasses containing fluoride or phosphate.
2. Full lead crystal, lead crystal and crystal glass, with official definitions (formulation and properties) provided by Directive 69/493/EEC.
3. Borosilicate glass containing boron, particularly adapted for cookware due to a very low thermal expansion coefficient.
4. Glass-ceramic for cookware with even lower expansion coefficient.

The wide range of products and processes means that virtually all of the melting techniques, described in Section 2.3 are likely to be used within the sector, from pot furnaces to large regenerative furnaces. Unlike in container production external cullet is not widely used due to quality constraints, but internal cullet is universally used.

The forming processes fall into two main categories, automatic processing and hand made or semi-automatic processing. Automatic processing is similar to that in the Container Glass Sector. Glass from the furnace is fed via one or more forehearths to the forming machine, where the articles are formed using moulds. The precise forming technique depends on the dimensions of the product being made. The four main techniques are: press and blow; blow and blow; pressing; and spinning. The press and blow, and blow and blow techniques are essentially the same as for the Container Glass Sector and so are not described further here, although the design of the machines and operating conditions (speed, quality requirements) differ.

The pressing process is relatively simple and is used for articles which are quite shallow and where the mouth is wider than or of equal width to the base. It involves pressing a hot glass gob between a mould and a plunger. The temperature of the glass will vary depending on the formulation but for soda-lime glass is typically 1150 $^{\circ}\text{C}$.

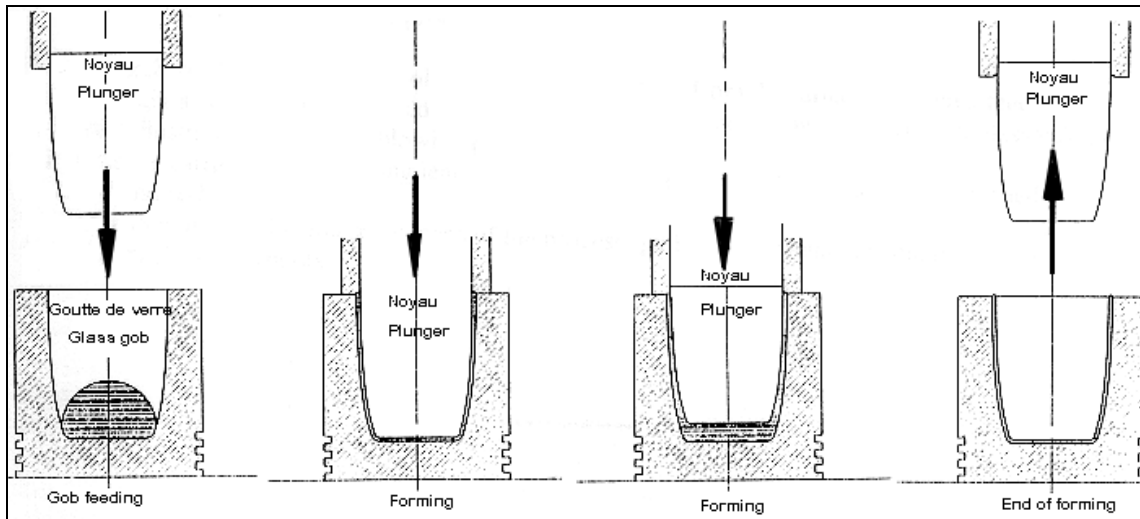

Figure 2.8: The pressing process for the formation of glass articles

The spinning process is used to produce circular articles such as plates and shallow bowls. A hot glass gob is dropped into the mould, which is then rotated and the article is formed by the resulting centrifugal force.

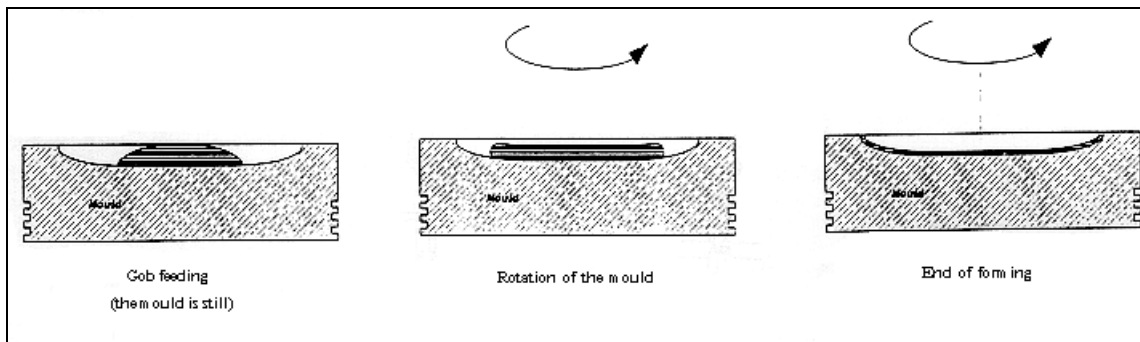

Figure 2.9: The spinning process for the formation of glass articles

The formed articles are generally fire-finished and polished to obtain the required surface quality. Very high temperatures are often necessary and are provided by means of oxy-gas or in some cases oxygen-hydrogen firing. These processes have the advantage of a lower specific energy consumption, easy use and reduction of exhaust gases volumes. Following firing, the articles pass through an annealing lehr and may have surface coatings applied. The annealing and cold coating operations are comparable with those for container glass and so are not described further. In some cases articles do not pass through an annealing lehr but through a tempering furnace in order to increase their resistance to mechanical and thermal shock. The production of certain articles involves joining separately two or more parts after local re-melting. This applies to stems and feet for glasses and handles for cups and glasses. These items are made separately by pressing, drawing or extrusion. Glass stems are often drawn from the bulb of the glass and only the foot is added separately.

For handmade articles, glass is gathered by a person with a hollow pipe, either directly from the furnace or from a feeder. A small hollow body (the parison) is made by giving a short puff into the pipe, and the shape is then formed by turning in a wooden or metal mould. The items are carried to an annealing lehr to eliminate any internal tensions and are fire finished, polished and re-heated. In semi-automatic production some steps of the process (gathering, forming, and

handling) are carried out with machines or robots. In general, the manufacture of handmade articles is likely to only fall under IPPC where it is carried out at an installation where other glass making activities are undertaken.

Following production of the basic items, they can be subjected to one or more cold finishing operations. Some of these are outlined below.

Cutting involves carving precise pre-selected patterns on the blank glass articles using diamond impregnated wheels. This process can be carried out either by hand or automatically depending on the product. Water (sometimes dosed with lubricants etc) is used as a coolant for cutting and also removes the fine glass particles produced. The water is treated and either discharged or recycled. The edges of the articles are sometimes ground and polished using similar but less specialised techniques.

Glass cutting produces a grey, unfinished surface on the glass. The glass surface is restored to its original appearance by immersion in a polishing bath of hydrofluoric and sulphuric acids. The acids smooth the glass surface because the rough areas are dissolved more readily due their greater surface area. A white "skin" (composed of lead sulphate) is formed on the surface of the glass. After rinsing in hot water the glass is restored to a sparkling condition.

Fumes of HF and SiF₄ are released from the surface of the polishing bath. These fumes are treated in scrubbing towers. During this operation, hexafluorosilicic acid (H₂SiF₆) is formed, with typical concentrations up to 35 %, and the acidic washing water is then neutralised. As an alternative, H₂SiF₆ can be recovered and, where feasible, used as a feedstock in the chemical industry. The acidic rinse water also requires periodic neutralisation. Alternative techniques to acid polishing are under development, e.g. mechanical polishing, and high temperature polishing either with flames or lasers

A great variety of other techniques can be used to create attractive patterns: These include: decorating with enamels, frosting by sand blasting or acid etching, and engraving. The volumes of and associated emissions from these operations are small in comparison with the main processing stages.

2.8 Special Glass

[tm25 Special, tm1 UKDoE, tm21 Schott]

The Special Glass Sector is extremely diverse, covering a wide range of products that can differ considerably in terms of composition, method of manufacture and end use. Also many of the products could be considered to overlap with other sectors, especially the Domestic Glass Sector for borosilicate glasses. Cathode ray tube glass and borosilicate glass account for about 70 % of special glass production with most other products being of relatively low volume and often significantly below the 20 tonnes/day threshold. However, many of these low volume products are manufactured at installations where the total production of all operations exceeds this figure. Table 2.7 gives the compositions of the main glass types. This section outlines the main production methods used within the sector.

Due to the diversity of the sector a wide range of melting techniques is used, however, the low volumes of production mean that most furnaces are quite small. The most common techniques are recuperative furnaces, oxy-gas furnaces, electric melters and day tanks. In some cases regenerative furnaces are also used, for example in CRT-glass and water glass production. It should be noted that the melting temperatures of special glasses can be higher than for more conventional mass-produced compositions. CRTs, borosilicate glass and glass ceramics, in particular necessitate melting temperatures of more than 1650°C. These high temperatures and complex formulations can lead to higher environmental emissions per tonne than, for example soda-lime products. The lower scale of production coupled with higher temperatures, also

means that energy efficiency is generally lower, and furnace lifetimes are generally shorter in this sector.

The high quality requirements of certain products such as optical glass and ceramic glass mean it is necessary to construct (or cover) components from the refining section onwards with platinum, to prevent contamination.

As in the other sectors, following melting and refining molten glass flows from the furnace along temperature controlled forehearths to the downstream forming apparatus. The main forming techniques used within the sector are:

- a) Press and blow production (borosilicate glass, tableware and kitchen products).
- b) Rotary-mould (past-mould) process (borosilicate glass, lamp units).
- c) Blow down (or settle blow) process (borosilicate glass, domestic glass)
- d) Rolling (ceramic flat glass).
- e) Pressing (CRT glass and lamp units).
- f) Ribbon process (light bulbs).
- g) Spinning process (borosilicate glass,)
- h) Tube extrusion, the Danner and Vello processes (glass tubing including lighting).
- i) Casting (optical glass blocks and some special products).
- j) Drawing process (down draw for thin film glass like display glass, up draw for borosilicate glass)
- k) Floating (borosilicate glass)
- l) Dissolution (water glass solutions).

Press and blow, and blow and blow production is essentially the same as described for the Container Glass Sector. The rolling process used to produce articles such as ceramic hobs for cookers is a scaled down version of the process described for Flat Glass Sector, but with plain rollers. These processes are not described further here and reference should be made to earlier sections.

In the pressing process the glass is in contact with all parts of the metallic mould material. The pressing mould consists of three parts: the hollow mould; a plunger, which fits into the mould leaving a space which determines the thickness of the glass wall; and a sealing ring which guides the plunger when it is removed from the mould. A glass gob is fed into the mould and is hydraulically or pneumatically pressed by the ring-guided plunger until the glass is pressed into all areas of the mould. The plunger and the mould remove much of the heat from the glass, and after solidification the plunger is withdrawn. Most pressing machines operate on turntables which usually have between 4 and 20 moulds (maximum 32, most common for CRT-glass is 11). The turntable takes the glass step by step through the loading, pressing, cooling and removal stages.

Light bulbs can be produced using the ribbon process. A ribbon of glass is formed by rolling molten glass between two water-cooled rollers. On leaving the rollers the ribbon of glass is carried through the machine on a series of orifice plates, which form a continuous belt pierced with holes. As the ribbon moves forward a continuous chain of blow heads meet it from above, each blow head coinciding with a hole in the belt. A puff from the blow head blows the glass through the hole and the glass forms into a bulb inside a rotating mould, which meets and closes around it from below. Moving forward on the ribbon, the shaped bulb is released from its mould, cooled by air and then released from the ribbon and transferred to a conveyor belt. This carries the bulbs through an annealing lehr, and onto cooling, inspection and packing. Production rates in excess of 1000 bulbs a minute can be achieved.

Extrusion can be used for glasses with a steep viscosity curve or for glasses with a tendency to crystallise, to produce items with very close dimensional tolerances. It is an economical method of making various types of full or hollow profiles with sharp-edged cross sections for industrial

use. By using laminate extrusion methods, two or three types of glass can be combined to produce, for example, components sheathed with chemically resistant glass.

The most widely used method for the continuous drawing of glass tubing is the Danner process. A continuous strand of molten glass flows onto a slightly angled, slowly rotating refractory core called the Danner mandrel. At the lower end of the mandrel a hollow bulb forms from which the tubing is drawn. Air is blown through the hollow mandrel shaft maintaining a hollow space in the glass. After being redirected horizontally, the solidifying tube is transported on a roller track to the pulling unit, behind which it is cut into 1.5m lengths, or sometimes longer. These machines can produce more than 3m per second of glass tubing.

The Vello process is the second most widely used process and has about the same rate of output as the Danner process. The glass from the furnace flows along the forehearth and downward through an orifice (the ring), with the hollow space in the glass being maintained by a pipe with a conical opening (the bell) located within the ring. The still soft tube, is redirected horizontally and is drawn off along a roller track, cooled and cut as in the Danner process.

A variation on the Vello process is the down-draw process, which can be used to produce tubing with diameters up to 360 mm. The glass is drawn downwards through a vacuum chamber, and passes through a sealed iris diaphragm, a circular shutter which can be adjusted to different apertures. A fourth process is the up-draw process, where the glass tube is drawn vertically upwards from a rotating bowl. The drawing area is shielded by a rotating ceramic cylinder, one end of which is submerged in the glass. The hollow space is formed by means of an air jet placed below the surface of the glass. This technique is particularly useful for producing tubing with thick walls and large diameters.

Optical glass can be either cast into blocks or extruded into cylinders to form the blanks, which are sold for further processing. Moulds are usually made from refractory materials.

Water glass (sodium silicate, Si:Na ratio 2 - 3.5) is made by melting sand and soda ash (sodium carbonate) in a fossil fuel fired furnace. A potassium silicate derivative can also be made using potash (potassium carbonate). The furnace is very similar to a conventional furnace and can be either regenerative or recuperative depending on the size. The furnace is usually shorter than a conventional furnace with a shorter residence time, because it is not necessary to refine the glass. The molten glass flows from the end of the furnace (forehearths are generally not necessary) and is immediately cooled, usually by direct contact with water or a water-cooled conveyor. The glass can be sold as a solid but is more usually dissolved in water at elevated temperature and pressure (the glass is only sparingly soluble at atmospheric pressure) to give a solution.

Water glass can also be produced by the hydrothermal process, which involves the direct dissolution of sand in sodium hydroxide to produce a crystal silicate solution in one precisely controlled step. The reaction takes place in autoclaves, specially designed to withstand the aggressive conditions. This process is not considered as a glass process but may have to be considered in a permit for an installation, which involves both activities.

Material	CRT Glass		Glass Tube		Borosilicate Glass e.g. chemical glass ware	Other Lighting Glasses		Glass Ceramic	Quartz Glass	Optical Glass		Others e.g. Diodes	Waterglass a)Na silicate b)K silicate
	Panel	Funnel	Earth alkaline	Borosilicate		Opaque Glass	Lamp Bulb			Boron Crown	Fluorine Crown		
SiO ₂	60 - 63	53 - 55	70	70 - 81	70 - 81	67.5	73 - 75	60 - 64	99.9	61.7		35	66 - 88
Al ₂ O ₃	2 - 3.4	1 - 5.2	4	2.3 - 5.5	2.3 - 5.5	5	1 - 4	10 - 20	0.005	0.3 - 3.0	15		0.1
Fe ₂ O ₃				0.01 - 0.03	0.01 - 0.03	0.15							0.03
CaO	0 - 3.2	0.9 - 3.8	4	0.01 - 1	0.01 - 1	9.4	0.5	0.5 - 7.0	0.001	0 - 3.0			0.008
PbO		21 - 23										60	<0.0002
MgO	0 - 1.2	0.6 - 2.2	2	0.01 - 0.5	0.01 - 0.5		0.5	0.0 - 1.0	0.001				0.008
Na ₂ O	6.6 - 9.4	5.8 - 6.7	12.5	3.5 - 6.5	3.5 - 6.5	13.6	3 - 4	0.5 - 10	0.001	0 - 5.0			20 - 34(a)
K ₂ O	6.6 - 8.4	7.8 - 8.1	2.5	0.5 - 1.5	0.5 - 1.5	1.8	1.5 - 2.5			12 - 18		5.0	27 - 32(b)
SO ₃						0.2							0.015
F						4.0					35		
B ₂ O ₃			1	8 - 13	8 - 13		12 - 17			6 - 20			
BaO	8.3 - 13	0 - 2.5	4					1.0 - 2.0		0 - 10	20		
ZnO								0.5 - 6.0					
SrO	2.2 - 8.8	0 - 0.5											
ZrO	0 - 2.3	0 - 0.2		0.01 - 1	0.01 - 1			1 - 2.0					
P ₂ O ₅											20		
LiO ₂								3.0 - 4.0					
TiO ₂				0.01 - 5	0.01 - 5			1.5					

Table 2.7: Chemical composition of the main products of the Special Glass Sector

Some of the glass compositions vary widely from product to product and the figures given above can only be a guide.

2.9 Mineral Wool

[tm26 EURIMA, tm8 S2 3.03]

Mineral wool manufacture consists of the following stages: raw material preparation; melting; fibrisation of the melt; binder application; product mat formation; curing; cooling; and product finishing. Mineral wool can be divided into two main categories: glass wool; and stone or slag wool. The products are used in the essentially same applications and differ mainly in the raw materials and melting methods. Following the melting stage the processes and environmental issues are essentially identical. The characteristic formulations of mineral wool are given in Table 2.8 below.

Mineral Wool	SiO ₂	Alkaline Oxides	Earth Alkaline Oxides	B ₂ O ₃	Iron Oxides	Al ₂ O ₃	TiO ₂	P ₂ O ₅
Glass Wool	57 - 70	12 - 18	8 - 15	0 - 12	<0.5	0 - 5	Trace	0 - 3
Stone Wool	38 - 57	0.5 - 5	18 - 40	Trace	0.5 - 12	0 - 23	0.5 - 4	0 - 3
Slag Wool	38 - 52	0.5 - 3	30 - 45	Trace	0 - 5	5 - 16	<1	Trace

Table 2.8: Typical mineral wool compositions

2.9.1 Glass Wool

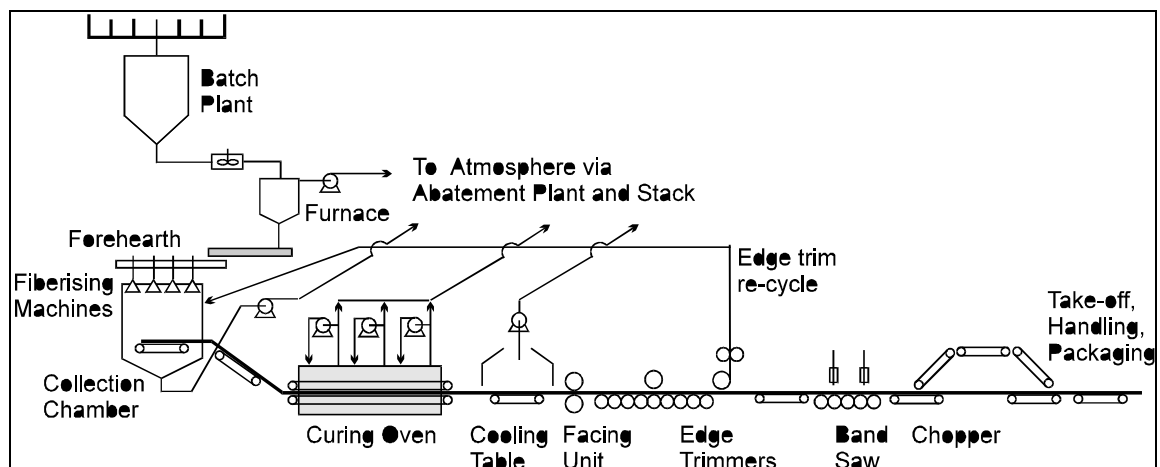

Figure 2.10: A typical glass wool plant

The raw materials for glass wool manufacture are mainly delivered by road tanker and pneumatically conveyed into storage hoppers. Each process will use a range of raw materials and the precise formulation of the batch may vary considerably between processes. The basic materials for glass wool manufacture include sand, soda ash, dolomite, limestone, sodium sulphate, sodium nitrate, and minerals containing boron and alumina.

Most processes also use process cullet as a raw material. This is shattered glass, which has been produced by quenching the molten stream from the furnace in water when the fiberising operation has been interrupted. Process cullet has the same precise formulation as the final product, and is readily recycled to the furnace. Other forms of waste glass e.g. bottle cullet and plate glass cullet are also increasingly used as a feedstock. This type of material is more difficult to recycle and its use depends heavily on cost, composition, purity and consistency of supply.

Several manufacturers also recycle processed fibrous waste and the dust collected from the furnace waste gas stream to the melter.

The fibrous nature of much of the waste makes it impracticable to recycle without further treatment. Glass furnace raw materials are charged as powders or in granular form, and so waste material must be ground or pelletised before charging. This is usually achieved by some form of milling operation. The waste product and the filtered waste contain significant levels of organic binder. In a glass furnace the carbon content of the waste presents a number of potential problems including: reduced heat transfer; foaming; destabilisation of melting conditions; and alteration of the furnace chemistry. These problems can be mitigated but there is a limit to the amount of waste that can be recycled to the furnace. Furthermore, it can be necessary to add sodium or potassium nitrate as an oxidising agent, and the decomposition of these materials can add significantly to the emissions of oxides of nitrogen.

The various raw materials are automatically weighed out and blended to produce a precisely formulated batch. The blended batch is then transferred to an intermediate storage hopper before it is added to the furnace.

The furnace (with a few rare exceptions) will either be an electrically heated furnace, a traditional gas fired recuperative furnace, or less commonly an oxy - gas furnace. These techniques are described in Section 2.3 above.

A stream of molten glass flows from the furnace along a heated refractory lined forehearth and pours through a number (usually one to ten) of single orifice bushings into specially designed rotary centrifugal spinners. Primary fiberising is by centrifugal action of the rotating spinner with further attenuation by hot flame gases from a circular burner. This forms a veil of fibres with a range of lengths and diameters randomly interlaced. The veil passes through a ring of binder sprays that spray a solution of phenolic resin based binder and mineral oil onto the fibres to provide integrity, resilience, durability and handling quality to the finished product.

The resin coated fibre is drawn under suction onto a moving conveyor to form a mattress of fibres. This mattress passes through a gas fired oven at approximately 250°C, which dries the product and cures the binder. The product is then air cooled and cut to size before packaging. Edge trims can be granulated and blown back into the fibre veil, or they can be combined with surplus product to form a loose wool product. Some products are produced without oven curing, e.g. microwave cured, hot pressed, uncured or binder free products. Also certain laminated products are made by the application of a coating e.g. aluminium foil or glass tissue which is applied on line with an adhesive.

Water is sprayed into much of the downstream process ducting: to prevent the build up of fibre and resinous material, which could cause fires or blockages; and to remove entrained material from the flue gas. Water is also used for cleaning the collection belt and other parts of the plant. The process water system is generally a closed loop, it is collected, filtered and reused for duct sprays, cleaning water and binder dilution. A typical process water system is shown in Figure 2.11 below.

A range of secondary products can be produced from manufactured glass fibre. These include granulated insulation wool for blown installation, packaged uncured wool for supply to customers for further processing, and laminated or faced products. Pipe insulation is a significant secondary product usually manufactured by diverting uncured wool from the main process for press moulding and curing. Alternatively, the wool may be wound onto retractable heated mandrels to form the bore and heat-processed to form the outer wall before transfer to an overall curing stage.

The binder is prepared by mixing the partially polymerised resin with certain additives that improve application efficiency, promote resin adhesion to the wool, suppress dust formation, confer water resistance and assist binder dilution. The binder is diluted with a substantial amount of water (process water where this is available) prior to application in the veil.

The most commonly used resin is a thermoset product of phenol, formaldehyde and a catalyst. The resin is water-based and typically contains up to 50 % solids. A more detailed description of the binder chemistry is given in Chapter 4. Resin may be imported from specialist manufacturers or may be made on-site by the mineral wool manufacturer. On-site resin production usually consists of a batch process where the raw materials are reacted under thermal control to give the desired degree of polymerisation and solids. Resin manufacture is considered to be a chemical process and is not covered in this document.

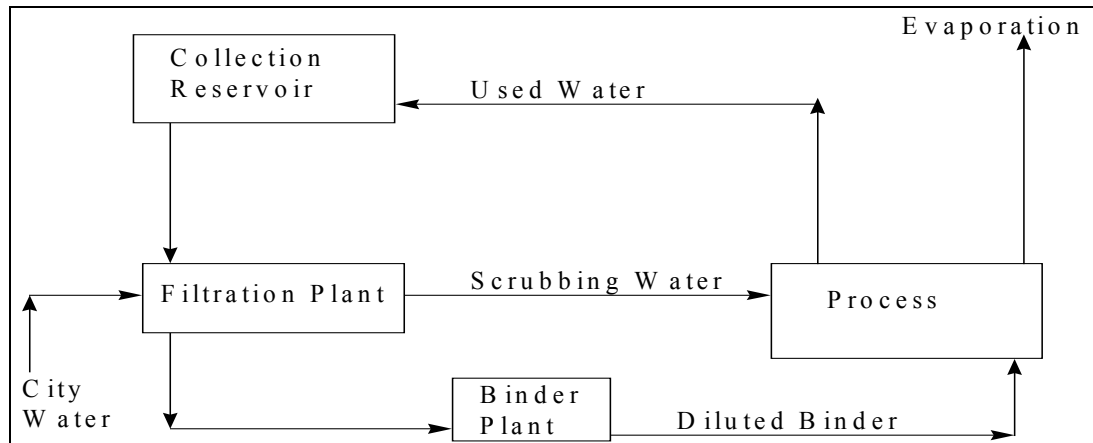

Figure 2.11: A typical mineral wool process water circuit

2.9.2 Stone Wool

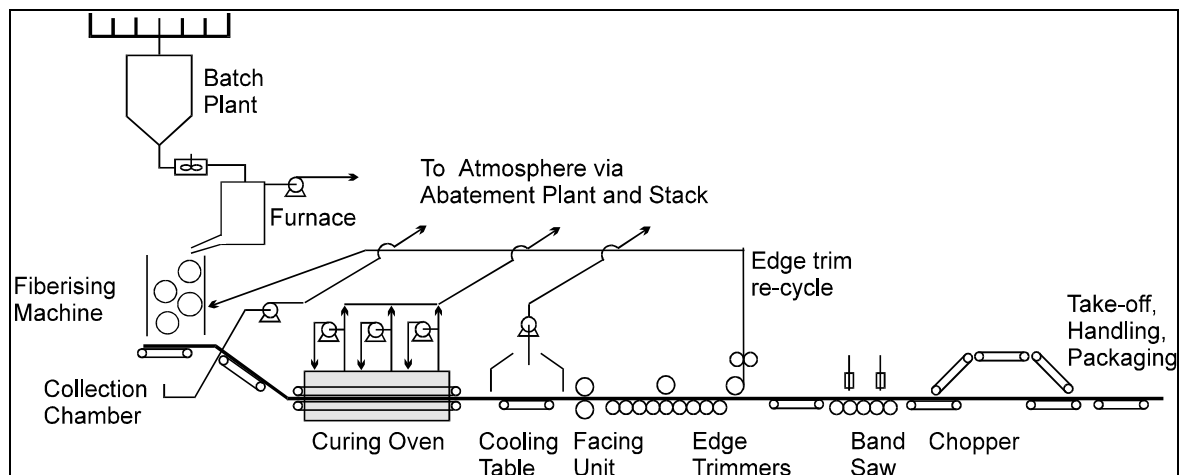

Figure 2.12: A typical stone wool plant

Traditional stone wool is made by melting a combination of aluminosilicate rock (usually basalt), blast furnace slag, and limestone or dolomite. The batch may also contain recycled process or product waste. The most common melting technique is the coke fired hot blast cupola. The cupola consists of a cylindrical steel mantle which may be refractory lined and closed in at the bottom. The whole furnace surface is water cooled by means of an open, convective cooling water loop.

The raw materials and coke are charged to the top of the cupola in alternate layers, or are sometimes mixed. Air, sometimes oxygen enriched, is injected into the combustion zone of the cupola, about 1 to 2 metres from the bottom. This is the hottest part of the cupola at approximately 2000°C. The molten material gathers in the bottom of the furnace and flows out of a notch and along a short trough positioned above the spinning machine. Basalt and to a lesser extent blast furnace slag contain iron as Fe^{3+} and Fe^{2+} . In the reducing conditions of some areas of the cupola

the ferric/ferrous iron is reduced to metallic iron. This collects in the bottom of the cupola, and would damage the expensive spinning machine if it were allowed to build up to the point where it flowed from the notch. To prevent this the iron is periodically drained, by piercing the lowest part in the curved base of the cupola.

In hot blast cupolas any fibrous or dusty material would be carried out of the top of the cupola, or would adversely affect the porosity of the bed and disrupt the flow of blast air. The accepted solution to this problem is to mill the material and produce briquettes of comparable size to the other raw materials. Cement is the usual binder for the briquettes but this can lead to higher emissions of sulphur dioxide due to the sulphur in the cement. However, briquetting provides other advantages e.g. lower energy use and the ability to add other fine materials to the batch, particularly other wastes such as foundry sand.

The melt falls onto the rapidly rotating wheels of the spinning machine, and is thrown off in a fine spray producing fibres. Air is blasted from behind the rotating wheels to attenuate the fibres and to direct them onto the collection belt to form a mattress. An aqueous phenolic resin solution is applied to the fibres by a series of spray nozzles on the spinning machine. The collection belt is under strong extraction, this performs three functions; it draws the fibre onto the belt, it removes the polluted air in the fiberising chamber, and it helps to distribute the phenolic binder across the mattress. The phenolic resin provides strength and shape to the product as in glass fibre insulation. The primary mat is layered to give the required product weight per unit area. The long chamber forming process that generates the product specific weight in a single stage, can also be used but is much less common.

The mat passes through a fossil fuel-fired oven at approximately 250°C, which sets the product thickness, dries the product and cures the binder. The product is then air cooled and cut to size before packaging. Pipe insulation and some secondary products may be manufactured in the way described for the glass wool process in Section 2.9.1.

Water can be sprayed into the ducting to prevent resin and fibre build-up, to reduce the risk of fires, and to remove entrained material from the flue gas. It is also used for a variety of cleaning operations. As in the production of glass fibre insulation the process water is collected, filtered and reused.

Stone wool can also be produced using flame furnaces and immersed electric arc furnaces. The other process operations including fiberising are the same. The design and operation of flame furnaces used for stone and slag wool manufacture is basically comparable to the flame furnaces used for glass wool manufacture. The furnace consists of a refractory tank heated by fossil fuel burners, either cross fired or end fired. Melting areas up to 100 m² are possible. Again metallic iron is reduced from the raw materials and iron tapping is necessary, e.g. by an orifice bushing located at the bottom of the furnace.

An immersed electric arc furnace for stone wool manufacture consists of a cylindrical steel mantle, which can be refractory, lined, and is cooled by means of either oil or water. The electrodes are immersed into the molten mass from the top of the furnace, providing energy for melting by resistive heating. The raw materials are inserted from above to provide a material blanket over the melt surface (cold top). Due to the electrode arrangement, however, there is always an open melt bath around the electrodes. Alternatively the electric furnace can operate with only partial coverage of the melt surface (hot top). Graphite electrodes are used and, as a result, a small amount of free metallic iron is reduced from the raw materials. Iron tapping is necessary, but at a much lower frequency (once per week or less) than for cupola furnaces.

2.10 Ceramic Fibre

[tm8 S2 3.03]

The process can be divided into two parts, the production of the fibre and the conversion of the fibre into other components. Typical chemical compositions for ceramic fibre are shown in Table 2.9.

Oxides of aluminium, calcium, magnesium, silicon and zirconium are delivered in bulk road tankers and pneumatically transferred to bulk storage silos. Smaller volume raw materials, including organic additives, are received in and dispensed from drums or sacks. The bulk raw materials are transferred from storage to the blending plant where they are mixed to give the required composition. The blended material is transferred to the furnace, where it is melted by electrical resistive heating at temperatures up to 2000 °C. The furnaces are about 1 metre deep and 2 - 3 metres in diameter, and have an open top, which is covered in a layer of unmelted batch materials.

A molten stream of the melt flows from the furnace to fall either onto high speed rotating wheels, which throw off a spray of fibres into a collecting chamber, or alternatively, in front of a high pressure air jet which attenuates the molten material into fibres. In neither case are binders added to the fibres, but a small amount of lubricant may be added which aids needling.

If the fibre production is interrupted the molten stream is not stopped, it is quenched in water and where practicable reused in the process.

The fibres are drawn from the collecting chamber on to a continuously moving belt to which a vacuum can be applied. As the resulting fleece comes off the lay-down belt it can be removed, baled and bagged, or allowed to continue down the production line to make blanket. This material can be baled as product or needle felted to knit the fibres together for additional strength. The needle-felted product can be passed through an oven to remove lubricant before being rolled up as blanket or cut into sized pieces.

Further downstream processing may also be carried out. The vacuum forming process consists of supplying a wet colloidal mixture of starch, latex, silica or clay to appropriately shaped moulds. The moulded shape is usually dried in a gas fired oven, and may be buffed or trimmed and cut to size before packing and dispatch. Papers, felts and boards may also be produced. This involves the laying down of an aqueous suspension of fibres onto a vacuum drum, followed by oven drying. A mixture of binders and additives may be added to the aqueous suspension.

Component	High purity alumina-silicate (%)	Zirconia alumina-silicate (%)
SiO ₂	48.5 - 54	47.5 - 50
Al ₂ O ₃	45.5 - 50.5	35 - 36
K ₂ O	< 0.01	<0.01
Na ₂ O	0.2	<0.03
MgO	<0.01	0.01
CaO	<0.05	<0.05
TiO ₂	0.02	0.04
ZrO ₂	0.2	15 - 17
Fe ₂ O ₃	<0.2	<0.05
Cr ₂ O ₃	<0.01	<0.01

Table 2.9: Chemical composition of typical refractory ceramic fibres in weight percent

2.11 Frits

[tm8 S2 3.03, tm46 ANFFECC]

Frit is prepared by fusing raw materials in a melter at high temperature. The molten material is then quenched causing the melt to solidify rapidly and shatter into friable particles termed frit. Glass frit is used as a raw material in the production of ceramic glaze. This is a vitreous coating applied to a ceramic body and fused by the application of heat. Similarly, enamel frit is a raw material used in the production of enamel. This is applied to metals for decorative and/or protective purposes. Glazes and enamels may be applied either dry or wet, the latter predominates and is usually in the form of a slip or slurry.

The process of fritting fuses water soluble raw materials into an insoluble glass, thereby making it easier to keep these materials uniformly distributed in the glaze or enamel suspension during subsequent processing. Furthermore, some of the raw materials used in the manufacture of glazes or enamels are both toxic and soluble. The conversion of these materials into an insoluble glass minimises the dissolution of toxic substances and therefore their potential for release to the environment.

The raw materials used in glass and enamel frit manufacture are essentially the same. They can be divided into four different groups, refractories, fluxes, opacifiers and colouring agents. Refractories include materials such as clay, feldspar and quartz. They are generally acidic in character and provide body to the frit. Fluxes are basic in character and react with the acidic refractories to form the glass. They include materials such as soda ash, potash, borax, cryolite and fluorspar.

Opacifiers provide the white opaque appearance that characterises many enamels. They can be insoluble such as titanium dioxide, tin oxide and zirconium oxide, or devitrification opacifiers such as cryolite or fluorspar. The latter may also act as fluxes rendering enamels more fusible. Opacifiers are not always included at the fritting stage, but may instead be added during slip production. Colouring agents may be oxides, elements or salts. Aside from their colouring properties they may act as either refractories or fluxes, and include materials such as cobalt oxide, chromium oxide and manganese oxide.

Raw materials may be stored in silos and conveyed to the weighing area pneumatically or mechanically. However, due to the relatively small size of some manufacturers many materials are stored in bags and manually dosed to the weighing apparatus. The various raw materials are precisely weighed and mixed to produce a batch that is chemically and physically uniform before being charged to the furnace.

The frit industry utilises both continuous furnaces and discontinuous batch furnaces. The choice of furnace is dependent on the scale of production and the product formulation. The nature of the business is such that it is common for small batches to be produced for a wide range of frit formulations. Frit furnaces are generally natural gas or oil fired, and most modern frit plants in Europe use oxy-fuel firing.

In continuous furnaces the raw materials are charged via a screw-feeder and form a pile at the charging point. Burners located along the sides provide temperature conditions of appropriate stability to enable the face of the pile to melt continuously. Smaller continuous furnaces may be end-fired with a single burner. As the materials melt, they form a shallow layer on the base of the furnace and flow to emerge at the opposite end. Production remains constant due to the continuous feeding of the raw material pile at the inlet. The molten frit can be quenched directly in a water bath, or can be cooled between water cooled rollers to produce a flake product.

Discontinuous batch furnaces are box shaped or cylindrical refractory lined vessels, mounted on bearings to allow a degree of rotation. To avoid contamination such furnaces are normally dedicated to similar types of formulation, though it is possible to purge furnaces between melts. Raw materials are charged through a port at the top of the furnace, and this can result in a short-

term high level of particulate matter emission. Direct water quenching is used almost exclusively in batch manufacture, and the quench water may become contaminated with particulate matter and any soluble components from the melt.

Temperatures in the furnace are typically in the range 1000°C to 1500°C, though lower temperatures are used for high lead frits. During the melting operation metal fume and other particulates may be generated. Residence time in the furnace is typically less than 4 hours.

To produce a slip, the frit must first be finely ground. Grinding is generally carried out in ball mills utilising alumina balls or flint pebbles in water. Further constituents of the glaze or enamel, such as clays, colours, electrolytes and opacifiers, may be added at any desired stage in the grinding cycle. Mill cycle times may vary from 6 to 16 hours. On completion of the milling operation the blended slip is passed over a mesh screen and over a magnet to remove tramp iron. For dry products the resulting slip may be dried or a dry grinding process may be used.

3 PRESENT CONSUMPTION AND EMISSION LEVELS

3.1 Introduction

This chapter provides information on the ranges of consumption and emission levels that are encountered within the Glass Industry across the scope of processes and techniques described in Chapter 2. The inputs and outputs are discussed for the industry as a whole, and then a more specific consideration is made for each sector.

The key emission characteristics, emission sources and energy issues are identified in this chapter and discussed further for each technique in Chapter 4. The information in this chapter is intended to allow the emission and consumption figures for any particular installation being considered for a permit, to be viewed in context against other processes in the same sector or in the Glass Industry as a whole.

The majority of raw materials for the Glass Industry are naturally occurring minerals or manmade inorganic substances. Most of the minerals used occur naturally in abundance and in general there are no major environmental issues associated with the provision of these materials. However, one of the considerations of the IPPC Directive is to minimise the consumption of raw materials commensurate with BAT. The manmade raw materials are generally manufactured in industries that are subject to separate regulation. Process residues and post consumer materials are increasingly important as raw materials for the Glass Industry particularly in the Container Glass and Mineral Wool Sectors.

The main environmental concerns for the Glass Industry as a whole are emissions to atmosphere and energy consumption. Glass making is a high temperature, energy intensive process, and the energy is provided either directly by the combustion of fossil fuels, by electrical heating or by a combination of both techniques. In general the most significant emissions include oxides of nitrogen, particulate matter, sulphur dioxide, halides and in some cases metals. Water pollution is not a major issue for most installations within the glass industry, although clearly there are exceptions. Water is used mainly for cleaning and cooling and is generally readily treated or reused. Process waste levels are relatively low with many solid waste streams being recycled within the process.

The Glass Industry is extremely diverse and the summary above is clearly a very broad generalisation. There are exceptions for specific processing options or for individual plants, and the environmental priorities can differ between sectors. Where these exceptions are inherent in a particular sector they are discussed in the relevant section. However, it is not possible to cover all eventualities for all plants and certain emissions not considered in this document may be encountered at a particular installation. Therefore, the information on process emissions given here should not be considered as exhaustive. The information presented in this section relates to the whole range of plant sizes and operations but does not include special modes such as start-up and shutdown. Some of the lowest emission values relate to the operation of only one plant, which achieves these figures for site specific reasons and the results are not necessarily indicative of BAT for the sector.

Emissions can vary greatly between sectors and between individual installations. The main factors are: inherent differences in the raw materials and products for each sector; the process selection (particularly the melter option); the process scale; and the degree of abatement implemented. When considering the emissions from different sectors and installations it is important to consider, in addition to the emission concentrations, the overall amount of any substance emitted and the mass emitted per tonne of product or melt.

Some of the emission data presented in this chapter is necessarily quite general and may contain quite wide ranges. These ranges are representative but do not necessarily provide enough detail for comparison with a particular installation under consideration. For this reason a number of

case studies that are broadly representative of the given ranges or which represent examples of performance within a particular sector, are presented in Annex 1.

3.2 General Glass Industry Overview

This section gives a qualitative discussion of those issues that are common to most processes and sectors within the Glass Industry. The specific issues relating to each sector are covered in the later sections, which, where possible, present quantitative information for consumption and emission levels. More detailed considerations of the mechanisms of formation of the substances emitted, and of the factors affecting the emission levels are given, where appropriate, in Chapter 4.

3.2.1 Process Inputs

The core process inputs can be divided into four main categories: raw materials (those materials which form part of the product), energy (fuels and electricity), water, and ancillary materials (processing aids, cleaning materials, water treatment chemicals, etc). Energy issues are dealt with separately in Section 3.2.3.

The Glass Industry as described in the document scope includes many different processes with a wide range of products, raw materials and processing options. It is not possible within a document of this type to cover all the process inputs even within the sector specific sections. Therefore, this document concentrates on those inputs that are most common within the industry and those that have greatest effect on the environment.

Glass Industry raw materials are largely solid inorganic compounds, either naturally occurring minerals or man-made products. They vary from very coarse materials to finely divided powders. Liquids and gases are also widely used, both as ancillary materials and as fuels. Table 3.1 lists the most common raw materials used for the production of glass. Due to the wide range of potential raw materials this table should be viewed as indicative only and not as exhaustive. The raw materials used in product forming and other downstream activities (e.g. coatings and binders) are more specific to each sector and are discussed in later sections. An increasingly important raw material for melting is recycled dust from process abatement systems. The composition of the dust will depend on the nature of the process and whether any absorbents are used.

Raw Material	Form	Description	Source/Comments
Glass forming materials			
Silica Sand	Granular	Principal source of SiO ₂	Quarried either as granular sand or as sandstone, which is subsequently crushed, graded and treated to remove impurities. High purity is required.
Process Cullet	Granular	Glass	Recycled glass from the manufacturing process. Glass composition identical to the glass produced.
Post Consumer Cullet	Granular	Glass	Recycled glass from collection schemes. Cullet purity and colour homogeneity can be variable.
Intermediate and modifying materials			
Nepheline Syenite Na ₂ O.K ₂ O.Al ₂ O ₃ . SiO ₂	Granular	Principle source of aluminium oxide in clear glass.	Quarried, crushed and graded. Low in iron content. Two major sources in the world Norway and China, also Canada.
Sodium Carbonate (Soda Ash – Na ₂ CO ₃)	Granular	Principal source of Na ₂ O.	Manufactured from natural salt using the Solvay process in Europe, and so contains some NaCl. Natural sodium carbonate also imported from the USA. African sources rarely used in Europe.
Limestone (CaCO ₃)	Granular	Principal source of CaO	Natural material quarried/mined, crushed and graded. In stone wool sector limestone is used in larger pieces usually >50mm in diameter.
Dolomite (CaCO ₃ .MgCO ₃)	Granular	Source of CaO and MgO	Natural material quarried, crushed and graded. In stone wool dolomite is used in larger pieces usually >50mm in diameter.
Potassium Carbonate	Granular	Source of K ₂ O	Used in special glass (lead crystal, TV glass, etc). Synthetic product.
Colemanite	Powder	Source of boron.	Natural borate from Turkey, used in continuous glass filaments.
Borax	Granular	Source of boron.	Synthetic sodium borate, mainly from California.
Boric Acid H ₃ BO ₃	Granular	Source of boron.	Synthetic product mainly used in continuous glass filaments.
Feldspar	Granular	Source of Al ₂ O ₃	Main source of alumina in coloured soda-lime glass. Natural product.
Fluorspar CaF ₂	Granular	Source of fluorine.	Natural product used mainly in opal glass.
Lead Oxides	Powder	Source of PbO.	PbO carriers in lead crystal glass, and special glass.
Barium Carbonate	Granular	Source of barium oxide BaO	Manufactured product used mainly in special glass.
Basalt	Granular	Alumino-silicate	In stone wool it is used in larger pieces usually >50mm in diameter.
Anhydrous Sodium Sulphate	Granular	Refining and oxidising agent, source of Na ₂ O	Manufactured product
Calcium Sulphate and Gypsum	Granular	Refining and oxidising agent, secondary source of CaO	Natural material or manufactured product
China Clay	Powder	Source of alumina.	Natural product used mainly in continuous glass filaments.
Sodium Nitrate	Granular	Refining and oxidising agent, source of Na ₂ O	Manufactured product
Potassium Nitrate	Granular	Refining agent, oxidising agent, source of K.	Manufactured product.
Antimony Oxide	Powder	Refining and oxidising agent	Manufactured product, mainly special glass formulations.
Arsenic Trioxide	Powder	Refining and oxidising agent	Manufactured product, mainly special glass and lead crystal formulations.
Slag	Granular	Source of	By-product of blast furnace. Particle size must be

Raw Material	Form	Description	Source/Comments
Mixed Ca, Al, Mg, Fe silicate and sulphide		aluminium oxide, modifying oxides, refining agents, flux and colouring species.	adjusted to glass raw material.
Carbon	Granular or powder	Reducing agent	Manufactured or processed natural product, small amounts used to produce a glass with a reduced oxidation state when manufacturing green, amber and sometimes clear glass.
Sodium chloride	Crystals	Fining agent	Used in some borosilicate glasses.
Colouring agents			
Iron Chromite (Fe ₂ O ₃ .Cr ₂ O ₃)	Powder	Colouring agent	Quarried, crushed and graded. Iron chromite is the colouring agent used for producing green container glasses
Iron Oxide (Fe ₂ O ₃)	Powder	Colouring agent	Manufactured product used mainly as a colouring agent in green and amber glasses.
Cobalt Oxide	Powder	Colouring agent	Manufactured product used both as a decolouriser and as colorant to produce blue glass.
Selenium metal/zinc or sodium selenite	Powder	Colouring agent	Manufactured product, also trace quantities used as a "decolouriser" (colour corrector). Large quantities used for bronze glass.

Table 3.1: Common raw materials utilised in the Glass Industry [tm18 CPIV]

The Glass Industry as a whole is not a major consumer of water, the main uses being cooling, cleaning and batch humidification. Some sectors use water for other purposes, which are discussed further in the sector specific sections. Where practicable water circuits are closed loops with make up of evaporative losses. Water can be taken either from the mains supply or from natural sources.

The term ancillary materials is used to describe those substances which are used in the manufacture of the products but which do not form part of the final product. For example, the tin and hydrogen used in float glass baths, oxygen in oxy-fuel fired systems, sulphur dioxide in flat glass (and occasionally container glass) surface treatment, and the cutting compounds and polishing acids used in lead crystal production. These types of materials are generally quite specific to each sector and are discussed in the later sections. The impact of these materials on process emissions will vary from case to case. Some can be quite significant e.g. acid polishing, while others are very low e.g. tin emissions from float baths.

Glass making is an energy intensive process and therefore fuels can form a significant input to the processes. The main energy sources within the Glass Industry are fuel oil, natural gas and electricity. Energy and fuel issues are discussed in Section 3.2.3 and in the sector specific sections.

3.2.2 Process Outputs

The core process outputs can be divided into five main categories: product, emissions to air, liquid waste streams, solid process residues, and energy. Liquid and solid waste streams can be recycled or disposed of, depending on process specific issues. In general, glass installations do not have significant co-product or by-product streams. However, it is becoming increasingly common for material that would otherwise be disposed of as a waste stream to be converted into a saleable (or no cost) form, for use as either a feedstock for other processes or as an end product.

In general, glass making involves the melting of a significant mass of materials such as metal oxides, carbonates, sulphates and nitrates. On melting these substances decompose and release gases such as carbon dioxide, water vapour, and oxides of sulphur and nitrogen. The batch materials may also contain moisture (between 0 and 4 %, either physically or chemically incorporated), and as the material is heated water vapour is released. In general, between 3 % and 20 % of the batch weight may be emitted as gases. Where high levels of cullet are used the figure will be at the lower end of this range. (1 tonne of cullet replaces approximately 1.2 tonnes of virgin raw material.)

Other outputs from the processes can include noise and odours. Noise arises from a range of activities including: fans, motors, material handling; vehicle movements, engineering activities, and compressed air systems. Noise is not considered to be a particular problem in the Glass Industry. However, noise sources clearly exist and could lead to problems with any close residential developments. In general, any problems are readily dealt with by good design and where necessary, noise abatement techniques. Certain pollution control techniques can also require noise control, which can add to the overall cost of the technique. Odours are not generally a problem within the Glass Industry, but they can arise from certain activities and measures may be required to avoid problems off-site. The main activities that can be associated with odour problems are mineral wool curing, cullet preheating and sometimes oil storage.

3.2.2.1 Emissions to Air

Raw materials

All of the sectors within the Glass Industry involve the use of powdered, granular or dusty raw materials. The storage and handling of these materials represents a significant potential for dust emissions. The movement of materials through systems incorporating silos and blending vessels results in the displacement of air, which if uncontrolled could contain very high dust concentrations. This is particularly true if pneumatic transfer systems are used. The transfer of materials using conveyor systems and manual handling can also result in significant dust emissions.

Many processes in the Glass Industry involve the use of cullet (either internal or external) which may require sorting and crushing prior to use in the furnace. Like all similar processes this has the potential for dust emissions. The level of emissions will depend on factors such as the design of the facility, if extraction is filtered before discharge, how well buildings are sealed, etc. Some processes also involve the use of volatile liquids, which can result in releases to air from tank breathing losses and from the displacement of vapour during liquid transfers.

Melting

For many of the processes falling within the scope of this document the greatest potential for environmental pollution arises from the melting activities. In general, the main environmental pollutants arising from melting are:

- the products of fossil fuel combustion and the high temperature oxidation of nitrogen in the combustion atmosphere (i.e. sulphur dioxide, carbon dioxide, and oxides of nitrogen),
- particulate matter arising mainly from the volatilisation and subsequent condensation of volatile batch materials, and
- gases emitted from the raw materials and melt during the melting processes.

Where 100 % electrical heating is used the emissions of combustion products and thermally generated NO_x are eliminated, and particulate emissions arise principally from batch carry over. The partial substitution of fossil fuel firing with electrical heating will reduce direct emissions from the installation, depending on the level of substitution and the particular combustion conditions. Oxy-fuel firing greatly reduces the level of nitrogen in the furnace and so reduces

the potential for NO_x formation. There are usually off-site emissions associated with the generation of electricity and oxygen, which should be taken into consideration when assessing overall environmental impact.

The furnaces encountered within the Glass Industry, and within each sector, vary considerably in size, throughput, melting technique, design, age, raw materials utilised, and the abatement techniques applied. Therefore, there is considerable variation in the emissions reported. There are also significant differences in the methodologies used for measuring emissions, and this can make direct comparisons of some actual data misleading. The minimum values are not always necessarily indicative of best technology and may only reflect more favourable operating conditions (e.g. high volume stable production, or low emission compositions) or plants with lower output. Clearly many of the lower releases represent those modern plants with advanced abatement measures, or “clean” technologies. The main emissions arising from melting activities within the Glass Industry are summarised in Table 3.2 below.

Emission	Source / Comments
Particulate matter	Condensation of volatile batch components. Carry over of fine material in the batch. Product of combustion of some fossil fuels.
Oxides of Nitrogen	Thermal NO _x due to high melter temperatures. Decomposition of nitrogen compounds in the batch materials. Oxidation of nitrogen contained in fuels.
Oxides of Sulphur	Sulphur in fuel. Decomposition of sulphur compounds in the batch materials. Oxidation of hydrogen sulphide in hot blast cupola operations.
Chlorides/HCl	Present as an impurity in some raw materials, particularly man made sodium carbonate and external cullet. NaCl used as a raw material in some special glasses.
Fluorides/HF	Present as a minor impurity in some raw materials, including external cullet. Added as a raw material in the production of enamel frit to provide certain properties in the finished product. Added as a raw material in the continuous filament glass fibre industry, and in some glass batches to improve melting, or to produce certain properties in the glass e.g. opalescence. Where fluorides are added to the batch, typically as fluorspar, uncontrolled releases can be very high.
Heavy Metals (e.g. V, Ni, Cr, Se, Pb, Co, Sb, As, Cd)	Present as minor impurities in some raw materials, post consumer cullet, and fuels. Used in fluxes and colouring agents in the frit industry (predominantly lead and cadmium). Used in some special glass formulations (e.g. lead crystal and some coloured glasses). Selenium is used as a colourant (bronze glass), or as a decolourising agent in some clear glasses.
Carbon Dioxide	Combustion product. Emitted after decomposition of carbonates in the batch materials (e.g. soda ash, limestone).
Carbon Monoxide	Product of incomplete combustion, particularly in hot blast cupolas.
Hydrogen Sulphide	Formed from raw material or fuel sulphur in hot blast cupolas due to the reducing conditions found in parts of the furnace.

Table 3.2: Summary of emissions to atmosphere arising from melting activities

Heavy metal and trace element emission concentrations can be significant from some processes, and are generally present in the dust. Table 3.3 below is taken from [tm41 VDI2578] and shows some actual examples. The figures below can generally be taken to be illustrative maximum figures and are not indicative of the use of BAT.

Metal	Container Glass	Flat Glass	Lead Crystal Glass
Vanadium (when firing fuel oil)	up to 4 mg/Nm ³	up to 2 mg/Nm ³	
Nickel (when firing fuel oil)	up to 0.5 mg/Nm ³	up to 0.4 mg/Nm ³	
Chromium (green glass)	up to 3 mg/Nm ³		
Selenium	up to 1 mg/Nm ³		
Selenium, gaseous (flint hollow glass)	up to 14 mg/Nm ³		
Lead	up to 4 mg/Nm ³	up to 1 mg/Nm ³	up to 700 mg/Nm ³
Cadmium	up to 0.3 mg/Nm ³	up to 0.1 mg/Nm ³	
Antimony			up to 10 mg/Nm ³
Arsenic			up to 20 mg/Nm ³

Table 3.3: Potential heavy metal emissions from glass processes [tm41 VDI2578]

Downstream Activities

This term is used to describe activities undertaken following melting, for example, forming, annealing, coating, processing, etc. The emissions from downstream activities can vary greatly between the different sectors and are discussed in the sector specific sections. Although many of the sectors share some similar melting techniques the downstream activities tend to be exclusive to each sector. In general, emissions to air can arise from:

- coating application and/or drying (e.g. mineral wool, continuous filament glass fibre, container glass, and some flat glass);
- from any activities performed on the materials produced such as cutting, polishing, or secondary processing (e.g. mineral wool, domestic glass, special glass, ceramic fibre); and
- from some product forming operations (e.g. mineral wool, and ceramic fibre).

3.2.2.2 Emissions to Water

In general, emissions to the water environment are relatively low and there are few major issues that are specific to the Glass Industry. In general water is used mainly for cleaning and cooling and can be readily recycled or treated using standard techniques.

Most activities will use some liquids even if only water treatment chemicals and lubricants or fuel oil. All liquid raw materials pose a potential threat to the environment through spillage or containment failure. In many cases basic good practice and design is sufficient to control any potential emissions. Specific issues relating to aqueous emissions are discussed in the sector specific sections.

3.2.2.3 Emissions of Other Wastes

A characteristic of most of the Glass Industry sectors is that the great majority of internally generated glass waste is recycled back to the furnace. The main exceptions to this are the Continuous Filament Sector, the Ceramic Fibre Sector and producers of very quality sensitive products in the Special Glass and Domestic Glass Sectors. The Mineral Wool and Frits Sectors show a wide variation in the amount of waste recycled to the furnace ranging from nothing to almost 100 % for some stone wool plants. Other waste production includes waste from raw material preparation and handling, waste deposits (generally sulphates) in waste gas flues, and waste refractory materials at the end of the life of the furnace.

In some sectors of the Glass Industry chromium containing refractories are used for the construction of upper walls, crowns and regenerators. The chromium when combined with magnesia to form mag-chrome bricks is very resistant to batch carryover and combustion products at the high temperatures that exist in the regenerator chambers. The chromium used in the preparation of these materials, Cr^{3+} , is essentially non-hazardous, has low solubility and presents little risk. However, at high temperatures under alkaline and oxidising conditions, small amounts of the chromium will convert to Cr^{6+} during the furnace campaign. Cr^{6+} compounds are highly soluble, toxic and carcinogenic.

As with all furnace waste every effort is made at the end of a campaign to have the materials recycled. Where this is not possible, the Cr^{6+} content of the used mag-chrome refractories will be determined to ensure that they are correctly classified and disposed of appropriately. The industry is gradually reducing the amount of chromium containing refractories by development and redesign.

Small tonnages of high purity chromic oxide refractories may also be used. They are generally purchased on the basis that at the end of a campaign they will be taken back by the manufacturer for recycling. In some continuous glass filament furnaces large amounts of this material are used.

3.2.3 Energy

[tm14 ETSU, tm18CPIV]

Glass making is energy intensive and the choices of energy source, heating technique and heat recovery method are central to the design of the furnace. The same choices are also some of the most important factors affecting the environmental performance and energy efficiency of the melting operation. Thus, one of the most important inputs to the glass making process is energy, and the three main energy sources are fuel oil, natural gas and electricity. The exception to this is the manufacture of stone wool where the predominant melting technique is the hot blast cupola, which is fuelled by coke.

In recent decades the predominant fuel for glass making has been fuel oil, although the use of natural gas is increasing. There are various grades of fuel oil from heavy to light, with varying purity and sulphur content. Many large furnaces are equipped to run on both natural gas and fuel oil, and it is not uncommon for predominantly gas-fired furnaces to burn oil on one or two ports. The third common energy source for glass making is electricity, which can be used either as the only energy source or in combination with fossil fuels. Resistive electrical heating is the only technique to have found widespread commercial application within the Glass Industry. Indirect electric heating has only been used for very small tanks and pot furnaces or for heating part of a tank (e.g. the working end or forehearth).

In general, the energy necessary for melting glass accounts for over 75 % of the total energy requirements of glass manufacture. Other significant areas of energy use are forehearths, the forming process, annealing, factory heating and general services. The typical energy use for the Container Glass Sector, which accounts for around 60 % of EU output is: furnace 79 %, forehearth 6 %, compressed air 4 %, Lehr 2 %, and others 6 %. Throughout this document the energy figures relate to energy at the point of use, and are not corrected to primary energy.

Although there are wide differences between sectors and individual plants the example for container glass can be considered as broadly indicative for the industry. The main exception to this generalisation is the Mineral Wool Sector where the fiberising operation and the curing oven are also major energy consumers.

As discussed earlier fuel oil and natural gas are the predominant energy sources for melting, with a small percentage of electricity. Forehearths and annealing lehrs are heated by gas or electricity, and electrical energy is used to drive air compressors and fans needed for the

process. General services include water pumping, steam generation for fuel storage and trace heating, humidification/heating of batch, and heating buildings. Some furnaces have been equipped with waste heat boilers to produce part or all of the steam required.

In order to provide a benchmark for process energy efficiency it is useful to consider the theoretical energy requirements for melting glass. The theoretical energy requirements for the three most common glasses are given in Table 3.4. The calculation assumes all available heat is fully utilised and has three components:

- the heat of reaction to form the glass from the raw materials;
- the heat required, enthalpy, to raise the glass temperature from 20 °C to 1500 °C; and
- the heat content of the gases (principally CO₂) released from the batch during melting.

	Soda-Lime (Flat/Container Glass) GJ/tonne	Borosilicate (8 % B₂O₃) GJ/tonne	Crystal Glass (19 % PbO) GJ/tonne
Heat of reaction	0.49	0.41	0.40
Enthalpy of glass	1.89	1.70	1.69
Enthalpy of gases emitted	0.30	0.14	0.16
Theoretical energy requirement	2.68	2.25	2.25

Table 3.4: Theoretical energy requirements for melting common glass formulations [tm14 ETSU]

The actual energy requirements experienced in the various sectors vary widely from about 3.5 to over 40 GJ/tonne. This figure depends very heavily on the furnace design, scale and method of operation. However, the majority of glass is produced in large furnaces and the energy requirement for melting is generally below 8 GJ/tonne. Energy consumption is considered further for each sector where information is available.

Because glass making is such an energy intensive, high temperature process there is clearly a high potential for heat loss. Substantial progress with energy efficiency has been made in recent years and some processes (e.g. large regenerative furnaces) are approaching the theoretical minimum energy consumption for melting, taking into account the inherent limitations of the processes.

A modern regenerative container furnace will have an overall thermal efficiency of around 50 % (maximum 60 %), with waste gas losses around 20 %, and structural losses making up the vast majority of the remainder. This efficiency compares quite well with other large-scale combustion activities particularly electricity generation which typically has an efficiency of around 30 %. Structural losses are inversely proportional to the furnace size, the main reason being the change in surface area to volume ratio. Electrically heated and oxy-fuel fired furnaces generally have better specific energy efficiencies than fossil fuel furnaces, but have associated drawbacks which are discussed later in this document.

Some of the more general factors affecting the energy consumption of fossil fuel fired furnaces are outlined below. For any particular installation it is important to take account of the site-specific issues which will affect the applicability of the general comments given below. These factors also affect the emissions per tonne of glass of those substances which relate directly to the amount of fossil fuel burned, particularly CO₂, SO₂ and NO_x.

- a) The capacity of the furnace significantly affects the energy consumption per tonne of glass melted, because larger furnaces are inherently more energy efficient due to the lower surface area to volume ratio.

- b) The furnace throughput is also important, with most furnaces achieving the most energy efficient production at peak load. Variations in furnace load are largely market dependent and can be quite wide, particularly for some container glass and domestic glass products.
- c) As the age of a furnace increases its thermal efficiency usually declines. Towards the end of a furnace campaign the energy consumption per tonne of glass melted may be up to 20 % higher than at the beginning of the campaign.
- d) The use of electric boost improves the energy efficiency of the furnace. However, when the cost of electricity, and the efficiency of electrical generation and distribution, are taken into account the overall improvement is lower (or even negative). Electric boost is generally used to improve the melting capability of the furnace rather than to improve energy efficiency.
- e) The use of cullet can significantly reduce energy consumption, because the chemical energy required to melt the raw materials has already been provided. As a general rule each 10 % increase in cullet usage results in an energy saving of 2 - 3 % in the melting process.
- f) Oxy-fuel firing can also reduce energy consumption, particularly in smaller furnaces. The elimination of the majority of the nitrogen from the combustion atmosphere reduces the volume of the waste gases leaving the furnace by 60 - 80 %. Therefore, energy savings are possible because it is not necessary to heat the atmospheric nitrogen to the temperature of the flames.

Energy efficiency is a very complex issue that is dealt with further in the sector specific sections of this chapter and in Chapter 4. Since the 1960s the Glass Industry as a whole has reduced specific energy consumption by approximately 1.5 % per year. Today this figure is lower, as the thermodynamic limits are approached.

Table 3.5 is taken from the German VDI guideline [tm41 VDI2578] and gives a useful summary of specific energy consumption for a range of modern, energy efficient glass furnaces.

Tank furnace type	Glass type	Melting area *)	Glass bath depth Melting end	Tank capacity Melting end	Length/width ratio of the tank bath	Output	Specific output	Specific energy consumption **)
		m ²	mm	metric t		metric t/d	metric t/m ² d	kJ/kg glass
Cross-fired furnace with regenerative air preheating	Container glass or water glass	15 – 155	1200 – 1700	50 – 500	1.9 – 3.0 : 1	40 – 500	2.5 – 4.0	4200
Regenerative end fired furnace	Container glass	15 – 140	1200 – 1700	50 – 500	1.9 – 2.5 : 1	40 – 450	2.5 – 4.0	3800
Recuperative furnace	Container glass	up to 250	1100 – 1600	50 – 650	2.0 – 2.8 : 1	40 – 450	2.0 – 3.0	5000
Fuel-oxygen-fired furnace ***)	Container glass	110 – 154	1300 – 1700	390 – 600	2.0 – 2.4 : 1	350 – 425	2.3 – 3.5	3050 – 3500
Cross-fired furnace with regenerative air preheating	Flat glass	100 – 400	1200 – 1400	300 – 2500	2.1 – 2.8 : 1	150 – 900	2.3 – 2.7	6300
Cross-fired furnace with regenerative air preheating	Television tube glass (screen)	70 – 300	900 – 1100	160 – 700	2.0 . 3.0 : 1	100 – 500	1.1 – 1.8	8300
Furnace with recuperative air preheating	Tableware	15 – 60	1100 – 1300	40 – 180	1.8 – 2.2 : 1	15 – 120	1.0 – 2.0	6700
Furnace with recuperative air preheating	Glass fiber	15 - 110	800 - 1500	50 - 200	2.8 : 1	30 - 350	3.4	4300

- *) Surface area of glass furnace for glass melting and refining; normally the area between the doghouse and the throat; in the case of float glass furnaces without the unheated conditioning area.
- **) Specific energy consumption without working end and feeder during start-up and nominal load operation (tank aging 0.1 to 0.2 % per month; without electrical boosting, melt preheating and secondary waste heat utilization)
standardized to 70 % cullet for container glass
 20 % cullet for float glass
 40 % cullet for television tube glass and tableware
- Energy savings per percent of additional cullet used: 0.15 to 0.3 %
- The specific energy consumption figures given are approximate guide values for new medium-size and large plants. They are not suitable for energy balance considerations owing to the large differences which occur in individual cases. The effective specific energy consumption is dependent not only on the cullet content and the tank age, but also, inter alia, on batch composition, air preheating, specific tank loading, insulation of the tank and the required glass quality standard.
- ***) The data indicated are based on the operating experience with two commercial plants using oxy-fuel-technology. The energy required for oxygen production is not included in the specific energy consumption.

Table 3.5: Examples of specific energy consumption for a range of glass furnaces [tm41 VDI2578]

3.3 Container Glass

[tm18 CPIV]

As described in Chapter 1 the Container Glass is the largest sector of the EU Glass Industry representing around 60 % of total production. In 1997 there were 295 furnaces operating at 140 installations. Furnace types include cross fired regenerative, end fired regenerative, recuperative, electrical, and oxy-gas fired furnaces; and the sizes also vary widely from less than 50000 tonnes per year (10000 for perfume bottle production) to over 150000 tonnes per year. Production from an installation with several furnaces can be more than 1000 tonnes per day.

Clearly such a large and varied sector leads to significant variations in the amount and types of process inputs and outputs. However, products of this sector are almost exclusively produced using soda-lime or modified soda-lime formulations, and so the variation in glass making raw materials is limited.

The ratio of raw material input to melt produced will vary depending on the level of cullet used, which affects the amount of gases lost from the raw materials on melting. Degassing and drying of the raw materials can account for between 3 % and 20 % of the input, and 1 tonne of cullet replaces approximately 1.2 tonnes of virgin raw materials. Pack to melt ratio can range from 50 % to over 90 % with most glass waste recycled to the furnace.

Table 3.6 below gives an overview of the major inputs to and outputs from the process. The emissions represent typical midrange furnaces.

	Units/tonne (glass melted)	Range (mean value)			
Inputs					
Post consumer cullet	tonne	0	-	0.85	(0.40)
Silica sand	tonne	0.04	-	0.66	(0.35)
Carbonates	tonne	0.02	-	0.40	(0.20)
Minor mineral ingredients	tonne	0.002	-	0.05	(0.02)
Furnace refractory materials	tonne	0.005	-	0.01	(0.008)
Packaging materials	tonne	0.040	-	0.080	(0.045)
Moulds and other	tonne	0.004	-	0.007	(0.005)
Energy, fuel/gas total (1)	GJ	4	-	14	(6.5)
Energy, electricity total (1)	GJ	0.6	-	1.5	(0.8)
Water	m ³	0.3	-	10	(1.8)
Outputs					
Finished, packed products	tonne	0.75	-	0.97	(0.91)
Atmospheric emissions					
- CO ₂	kg	300.	-	1000.	(430.)
- NO _x	kg	1.2	-	3.9	(2.4)
- SO _x	kg	0.5	-	7.1	(2.5)
- dust (without secondary abatement)	kg	0.2	-	0.6	(0.4)
- dust (with secondary abatement)	kg	0.002	-	0.05	(0.024)
- HCl (without secondary abatement)	kg	0.02	-	0.08	(0.041)
- HCl (with secondary abatement)	kg	0.01	-	0.06	(0.028)
- HF (without secondary abatement)	kg	0.001	-	0.022	(0.008)
- HF (with secondary abatement)	kg	0.001	-	0.0011	(0.003)
- metals (without secondary abatement)	kg	0.001	-	0.011	(0.006)
- metals (with secondary abatement)	kg	0.000	-	0.002	(0.001)
- H ₂ O (evaporation and combustion)	tonnes	0.3	-	10	(1.8)
Waste water	m ³	0.2	-	9.9	(1.6)
Waste to recycling	tonnes	0.002	-	0.006	(0.005)
Other waste	tonnes	0.003	-	0.015	(0.005)

Table 3.6: Overview of Container Glass Sector inputs and outputs [tm18 CPIV]

(1) Total energy (furnace + other) for a typical plant operating fossil fuel fired furnaces.

3.3.1 Process Inputs

Glass forming materials	Silica sand, process cullet, post consumer cullet.
Glass intermediate and modifying materials	Sodium carbonate, limestone, dolomite, sodium sulphate, blast furnace slag, feldspar, nepheline syenite, potassium carbonate, carbon, filter dust.
Glass colouring and decolouring agents	Iron chromite, iron oxide, iron sulphide, cobalt oxide, cerium oxide, selenium or zinc selenite.
Product coating agents (hot coating)	Inorganic or organic metal chlorides. Predominantly tin tetrachloride, titanium tetrachloride and monobutyl tin chloride.
Product lubricants	Polyethylene based lubricants and fatty acids (e.g. oleic acid).
Fuels	Fuel oil, natural gas, electricity, butane, propane.
Water	Mains supply and local natural sources (wells, rivers, lakes etc).
Ancillary Materials	Packaging materials including plastics, paper, cardboard, and wood. Mould lubricants, generally high temperature graphite based release agents. Machine lubricants, predominantly mineral oils. Process gases, oxygen and sulphur dioxide. Water treatment chemicals for cooling water and wastewater.

Table 3.7: Materials utilised in the Container Glass Sector (CPIV Jan98)

The largest inputs to the process are the silica containing materials (sand and glass cullet) and the carbonates (soda ash, dolomite and limestone). The raw materials for the glass batch are blended in the correct proportion to produce the range of glass compositions identified in Chapter 2. In most container glass compositions the oxides of silicon, sodium and calcium account for over 90 % of the glass (SiO_2 71 - 73 %, Na_2O 12 - 14 % and CaO 10 - 12 %). The silicon dioxide is derived mainly from glass cullet and sand. Sodium oxide is derived mainly from glass cullet and soda ash; and calcium oxide mainly from glass cullet, limestone and to a lesser extent dolomite.

Many container glass processes utilise a substantial level of glass cullet in the batch materials, with the sector average at around 48 %, made up of internal cullet and post consumer cullet. The use of post consumer cullet varies greatly (from 0 to >80 %) but almost all processes will recycle their internal cullet which is usually around 10 % of the batch. The inputs of the other glass making materials, particularly sand, soda ash, limestone and dolomite, will vary depending on the amount of cullet used and its composition.

The use of product surface treatment materials, i.e. coatings and lubricating treatments, varies from process to process. However, the amounts of material used are very low relative to glass making raw materials. On average a single production line uses 2 to 10 kg/day of the coating agents and a similarly low level of lubricant treatments.

The fuels used will vary from process to process, but in general, fuel oil, natural gas and electricity are used for glass melting, either separately or in combination. Forehearth and annealing lehrs are heated by gas or electricity, which are also used for heating and general services. Light fuel oil, propane and butane are sometimes used as backup fuels.

The main uses of water in the Container Glass Sector are for cooling circuits and cleaning. Water is frequently used (generally as steam) to humidify the batch materials (0 to 4 % moisture) to avoid raw material separation and to reduce dust carry-over from the furnace. Cooling water is used, usually in closed or open circuits, to cool various equipment and the hot glass from production rejects, with corresponding losses from evaporation and purges. Actual

water consumption and water vapour emissions may vary according to local conditions (e.g. ambient temperature and the hardness of water input).

3.3.2 Emissions to Air

3.3.2.1 Raw Materials

In most modern container glass processes silos and mixing vessels are fitted with filter systems which reduce dust emissions to below 5 mg/m^3 . Mass emissions from both filtered and unfiltered systems will depend on the number of transfers, granule size, and the amount of material handled.

3.3.2.2 Melting

In the Container Glass Sector the greatest potential environmental emissions are emissions to air from the melting activities. The substances emitted and the associated sources are identified in Section 3.2.2.1. The majority of furnaces in this sector are heated predominantly with fossil fuels, both natural gas and fuel oil. However, due to the large size and wide distribution of the sector there is a particularly wide range of furnaces in operation giving rise to a very wide range of emission levels. In the tables below emission ranges are divided into those with and without secondary measures. At the lower end of the range for installations without secondary measures some of the primary techniques are quite advanced, and conversely at the high end of the range no specific emission reduction measures are likely to have been taken.

Reported emission levels are given in Table 3.8. The source of this table is a statistical study made among members of the container glass trade association FEVE on data from 228 fossil fuel fired furnaces, with and without electric boosting, from the entire spectrum of furnace and product types. Data refers to measurements made in 1996 and 1997. Sampling and measurement techniques are not standardised and the data can only be considered as indicative of the range of actual emissions at the time of the survey. The data for metals emissions was supplied for only 42 % of the furnaces and the metals included may differ.

About 30 % (72/228) of the container glass furnaces in the FEVE study are equipped with secondary abatement. The secondary abatement referred to is in all cases dust abatement, by an EP or (less frequently) a bag filter, generally with upstream desulphuring. Filter dust is recycled in all cases into the glass melt, within the limits imposed by possible substitution of raw materials. Overall reduction of sulphur oxide emissions thus corresponds in current practice to the substitution of sulphate in raw materials. The desulphuring is considered as secondary abatement for other acid gases (HCl & HF) with similar limitations on the overall effect due to recycling of filter dust. Secondary abatement of NO_x (by SCR) is only installed in one EU container plant (4 furnaces), but at least one furnace is thought to have a 3R licence.

Low values for NO_x ($<600 \text{ mg/Nm}^3$ or $<1 \text{ kg/t}$) can be observed on certain furnaces without secondary abatement. The factors enabling these low values are described in Section 4.4.2, with indication of applicability to existing installations. High values ($>2000 \text{ mg/Nm}^3$) should only be observed in special cases, e.g. where nitrates are required as a refining/oxidising agent, or for certain existing furnace configurations where high local flame temperatures and/or uncontrolled air leakage into the flames are difficult to avoid.

For SO_x, low values ($<300 \text{ mg/Nm}^3$) represent situations with low sulphur input from fuel, low sulphate in batch and no excess SO_x from cullet. High values are uniquely due to the use of high sulphur fuels, the use of which is progressively declining in the EU.

Low values for dust ($<100 \text{ mg/Nm}^3$) may be observed without secondary abatement in particular circumstances, but such low values are infrequent at the time of writing. Very high

values ($>400 \text{ mg/Nm}^3$) are observed for example from unabated emissions from borosilicate furnaces. Measurements of dust emissions are particularly subject to errors both in the techniques used and due to the complex nature of the equilibrium between the different sulphur compounds. Some high or low values of dust concentration reported may thus be due to measurement error.

For HCl low values ($<10 \text{ mg/Nm}^3$) may be observed without secondary abatement where low chloride sodium carbonate (from natural deposits) and high cullet levels are employed. Note that in the case of high local recycling rates associated with recycling of filter dust, chloride will progressively build up in the raw waste gas, particularly when chloride from “hot end” surface treatment is abated in the same system. In this case secondary abatement, (in combination with desulphuring) will not necessarily be associated with the lowest emission values, particularly as the conditions used for desulphuring may not be optimal for dechlorination with the same absorbing reagent. High values ($>50 \text{ mg/Nm}^3$) will generally be due to high chloride content of manufactured sodium carbonate.

Fluoride is an incidental impurity in certain natural raw materials. It may be present as an impurity in recycled glass (e.g. from fluoride containing opal glass that, although excluded by cullet specifications, may be present in small quantities). No generalities can be made about low values (without secondary abatement), or high values, which correspond to particularly favourable or unfavourable cases.

Low values for metals ($<1 \text{ mg/Nm}^3$) may be observed on unabated waste gases in favourable cases, particularly low cullet levels (for lead impurities), low vanadium fuel or gas firing and in the absence of selenium in raw materials (which is the case for all except certain white flint glasses). High values ($>5 \text{ mg/Nm}^3$) are generally associated with high cullet rates (lead), fuel firing or white flint glass production (selenium).

The data for Table 3.9 is from the same FEVE study as for Table 3.8, split into populations with and without secondary abatement (72/228 and 156/228 furnaces respectively for the main case of dust abatement). The 80 % middle range (P10 to P90) is as an indication of the performance of the majority of EU-wide installations in 1996 – 1997.

Total Range of Container Glass Melting Furnaces				
Emission type	Without Secondary Abatement With or without primary measures		With Secondary Abatement	
	mg/Nm ³	kg/t glass melted	mg/Nm ³	kg/t glass melted
NOx (as NO ₂)	400 – 5000	0.6 - 11.7	<400	<0.74
SOx (as SO ₂)	100 – 4500	0.2 - 9.8	100 - 1637	0.2 - 3.4
Dust	40 – 800	0.1 - 1.9	1 - 32	0.002 - 0.22
HCl	5 – 62	0.01 - 0.12	7 - 30	0.01 - 0.07
HF	1 – 70	≤ 0.16	≤ 1 - 6	≤ 0.02
Metals	≤ 1 – 16	≤ 0.017	≤ 1 - 3	≤ 0.003
Cullet Rate	5 - 95 %			
Typical Load	25 - 600 t/day			
Specific Energy Melting only incl. Boosting	3.2 - 12.2 [GJ/t]			

Table 3.8: Total emission ranges reported for Container Glass Sector furnaces with primary and secondary abatement measures.

(See remarks for Table 3.9 below)

Emission type	Middle 80 % (P10 to P90) of Container Glass Melting Furnaces Without Secondary Abatement With or without primary measures		Middle 80 % (P10 to P90) of Container Glass Melting Furnaces With Secondary Abatement	
	mg/Nm ³	kg/t glass melted	mg/Nm ³	kg/t glass melted
NO _x (as NO ₂)	600 - 2000	1.2 - 3.9	<400	<0.74
SO _x (as SO ₂)	250 - 3200	0.5 - 7.2	230 - 1500	0.4 - 2.8
Dust	100 - 270	0.2 - 0.6	2 - 32	0.002 - 0.05
HCl	10 - 40	0.02 - 0.08	7 - 30	0.01 - 0.06
HF	1 - 11	≤ 0.027	≤ 1 - 5	≤ 0.011
Metals	0.2 - 8	≤ 0.016	≤ 1	≤ 0.002
Cullet Rate	18 - 80 %			
Typical Load	100 - 360 t/day			
Specific Energy Melting only Inc. Boosting	3.9 - 6.4 [GJ/t]			

Table 3.9: Mid 80 percentile emission ranges for Container Glass Sector furnaces with primary and secondary abatement measures

Remarks:

- Relation between emissions in mg/Nm³ and kg/tonne is given by volume factor Nm³ waste gas/tonne glass obtained from fuel consumption, fuel type and cullet rate (the cullet rate gives a correction to degassing of raw materials)
- Reference conditions are: dry, temperature 0°C (273K), pressure 101.3 kPa, 8 % oxygen by volume.

3.3.2.3 Downstream Activities

The application of hot surface coatings and cold surface treatments can give rise to emissions of fume and vapours, principally HCl and tin compounds. The levels of emissions will vary between processes and will depend on many factors. The German VDI Guidelines (VDI 2578) quote the following concentrations found in waste gases from hot coating activities.

HCl	30 to 95 mg/m ³ .
Tin (particulate matter)	0.006 to 10 mg/m ³ .
Tin (gaseous)	0.4 to 15 mg/m ³ .

Mass emissions are quite low due to the low amounts of substance used, and concentrations will depend heavily on the amount of extraction air applied. Methods for controlling these emissions are discussed in Chapter 4. To date, the control of these substances seems to have concentrated on the control of workplace exposure levels. Wherever, HCl containing waste gas from hot end coating is combined with waste gas with a significant organics content, consideration must be given to the potential for the formation of dioxins and furans.

The forming processes are highly mechanised which can give rise to mists of lubricating oils but these are controlled according to workplace exposure levels and do not represent a significant emission to air. However, they do represent a potential hydrocarbon contamination of wastewater discharges.

3.3.3 Emissions to Water

[tm18 CPIV]

As discussed earlier the main uses of water in this sector are cleaning, cooling water systems, hot glass rejects cooling and batch humidification. The aqueous emissions are limited to the cooling water system purges, cleaning waters and surface water run off. The cleaning waters do

not present any particular issues that would not be common with any industrial facility i.e. inert solids and potentially oil. Cooling system purges will contain dissolved salts and water treatment chemicals. Surface water quality will depend on the degree of drainage segregation and site cleanliness.

Only the circuit for cooling and fragmenting hot glass rejects is particular to the sector. This recycled water may contain fine particles of glass from fragmentation and from the action of mechanical scraper systems used to dredge the glass from the water troughs. The chutes bringing the glass to the collection system may also bring small quantities of oil from the machines and oil or soluble oil/water mixtures used in the shear and delivery mechanisms. The circuit thus generally includes a solids and oil separator, which also serves to give suitable thermal inertia to the system during mould changing or incidents on forming machines, when large quantities of glass must be cooled. Separated glass solids are usually recycled in the raw materials. Open circuit cooling is generally used to allow for more rare severe incidents when large quantities of hot glass must be cooled (major furnace leakage or incident causing interruption of forming operations).

Excluding domestic wastewater, discharges generally contain only glass solids, some oil contamination, and cooling water system treatment chemicals. Simple pollution control techniques such as settlement, screening, oil separators, and neutralising can be found within the sector.

3.3.4 Other Wastes

[tm18 CPIV]

It is a characteristic of the Container Glass Sector that in all but exceptional cases, all process waste may be recycled directly on site. This includes glass rejects from the forming and quality control stages, but also waste from raw materials handling, abatement equipment dust, and sulphate deposits in furnace waste gas ducting.

At the end of a furnace campaign, the entire refractory structure is dismantled and replaced. These operations produce some 500 to 2000 tonnes of waste refractory materials, which are sorted and largely valorised. Only a minor quantity of these materials is unfit for any valorisation and is directed to landfill, if necessary after appropriate treatment. Some materials (e.g. silica refractories) may be ground and recycled through the furnace. However, the technical feasibility has been proven, but the cost of this technique is generally higher than alternative approaches such as elimination or valorisation.

Glass raw materials are very generally delivered in bulk and do not give rise to packaging waste. Waste materials from product packaging operations (plastic, cardboard, and wood) are usually reused or recycled through suppliers or other appropriate channels. Other waste not specific to the industry e.g. waste oils, drums and other packaging materials, paper, batteries, oily rags, etc are disposed of by conventional means or if appropriate recycled by an external waste company.

3.3.5 Energy

[tm18 CPIV, tm14 ETSU]

The energy necessary for melting glass accounts generally for over 75 % of the total energy requirements of container glass manufacture. Other significant energy use areas are forehearth, the forming process (compressed air and mould cooling air), annealing, factory heating and general services. The typical energy use by process step is given in Figure 3.1.

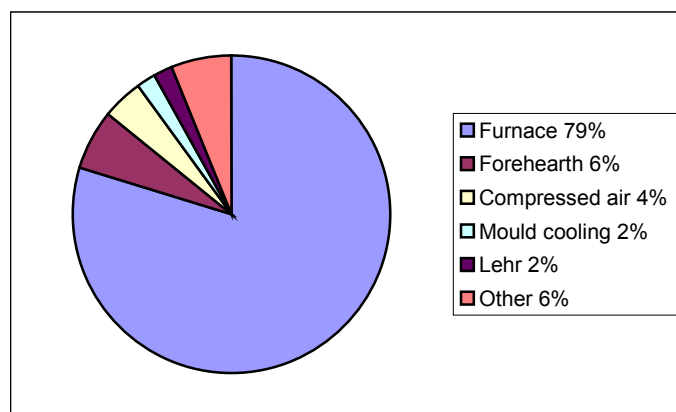

Figure 3.1: Energy usage in a typical container glass plant

Heavy fuel oil or natural gas are the primary energy sources for melting, sometimes with a small percentage of electrical boost (up to 5 %). There are a few examples of all electric melting but these are rare. Forehearths and annealing lehrs are heated by gas or electricity. Electrical energy is used to drive air compressors and fans needed for the process. General services include water pumping and, usually steam generation for fuel oil storage and trace heating, humidification/heating of batch and sometimes heating buildings. In some cases, larger furnaces have been equipped with waste heat boilers to produce part or all of the steam required.

The energy consumption of the process will depend on many factors, and the main ones are those outlined in Section 3.2.3. The range of energy consumption encountered within the sector is extremely wide (see Table 3.8). However, it is estimated that the majority of plants fall into the range of 4.5 to 7.0 GJ/tonne of glass melted and 6.5 to 9.0 GJ/tonne of finished products. For some very high quality products this figure may be significantly higher.

3.4 Flat Glass

The main output from a flat glass process is of course the product, which represents approximately 70 % of the raw material input. The remainder largely consists of emissions to air 10 - 20 %, made up mainly of CO₂ from the decomposition of carbonates; and scrap glass (cullet) around 10 - 20 % arising from edge trimming, product changes and breakages. The cullet is usually continuously recycled to the furnace and so the product actually represents closer to 85 % of the raw material input.

3.4.1 Process inputs

[tm18 CPIV]

There is generally less variation in the glass composition for flat glass than for the other sectors of the glass industry. However, different producers may choose slightly different ways of achieving the final composition depending on particular preferences or variations in raw material supplies. There may be particular differences in the amount of cullet used, any colourants and in any on-line coating processes. The main basic raw materials utilised in the sector are listed in the table below.

Glass forming materials	Silica sand, process cullet, (sometimes also post consumer cullet).
Glass intermediate and modifying materials	Sodium carbonate, limestone, dolomite, anhydrous sodium sulphate, calcium sulphate and gypsum, sodium nitrate, nepheline syenite, feldspar, blast furnace slag, carbon, filter dust.
Glass colouring agents	Potassium dichromate, iron oxide, cobalt oxide, cerium oxide, selenium metal or zinc selenite.
On-line coating processes	Silicon compounds (e.g. silicon tetrachloride, silicon carbonates), strong acid halides, organic and inorganic tin compounds.
Fuels	Fuel oil, natural gas, electricity, back up light fuel oils
Water	Mains supply and local natural sources (wells, rivers, lakes etc)
Ancillary Materials	Packaging materials including plastics, paper, cardboard, and wood. Machine lubricants, predominantly mineral oils. Process gases nitrogen, hydrogen and sulphur dioxide. Tin in the float bath. Water treatment chemicals for cooling water and wastewater.

Table 3.10: Materials utilised in the Flat Glass Sector

The largest inputs to the process are the silica containing materials (sand and glass cullet) and the carbonates (soda ash, dolomite and limestone). The raw materials for the glass batch are blended in the correct proportion to produce the range of glass compositions identified in Chapter 2. In typical float glass compositions the oxides of silicon, sodium, calcium and magnesium account for around 98 % of the glass (SiO_2 72.6 %, Na_2O 13.6 %, CaO 8.6 %, and MgO 4.1 %). The silicon dioxide is derived mainly from sand and glass cullet, cullet also provides a proportionately smaller level of the other oxides. Sodium oxide is derived mainly from soda ash, the calcium oxide mainly from dolomite and limestone, and the magnesium oxide from dolomite.

In all but exceptional cases, flat glass plants recycle all internal cullet directly to the furnace. Flat glass is generally processed into other products for the building and automotive industries and the cullet coming from this further transformation is also recycled in some cases. The amount of recycled cullet is generally limited by the availability of cullet of the correct quality and chemical compatibility. The total cullet introduced in the furnace is typically around 20 % but can range from 10 % to 40 % for a float furnace, and to over 80 % for other types of flat glass. Increasingly, waste glass from fabrication processors is reused or recycled to flat glass production units, but slightly contaminated waste can be used by glass container manufacturers or manufacturers of other types of glass products. Probably 95 % of waste glass from processors is recycled one way or another.

On-line coating processes are very specialised and case specific, Table 3.10 lists some of the typical raw materials used.

In common with other parts of the Glass Industry the main uses of water are cooling, cleaning and batch humidification. Flat glass is produced in a continuous ribbon, emerging from the annealing lehr at temperatures over 200°C. Most of the water consumed in the factory is used for cooling/washing this hot ribbon, and is not contaminated (may contain some Na_2SO_4). Actual water consumption and water vapour emissions may vary according to local conditions (e.g. ambient temperature and the hardness of water input).

Flat glass furnaces are almost exclusively fired on heavy fuel oil or natural gas, in some cases with electrical boost at up to 5 % of energy input. There are some small scale electrical furnaces

for specialist applications, and there is also one oxy-fuel fired furnace, commissioned recently in the USA.

3.4.2 Emissions to Air

[tm18 CPIV]

3.4.2.1 Raw Materials

In most modern flat glass processes silos and mixing vessels are fitted with filter systems which reduce dust emissions to below 5 mg/m³. Mass emissions from both filtered and unfiltered systems will clearly depend on the number of transfers and the amount of material handled.

3.4.2.2 Melting

In the Flat Glass Sector the greatest potential environmental emissions are emissions to air from the melting activities. The substances emitted and the associated sources are identified in Section 3.2.2.1. Almost all of the furnaces in this sector are fossil fuel fired (both natural gas and fuel oil), cross fired regenerative furnaces.

A summary of the range of emissions to air is given in Table 3.11 below. The table shows figures separately for unabated furnaces and furnaces with secondary abatement techniques installed. The data covers both gas and oil fired furnaces making clear float glass under normal operating conditions and includes measurements from 1996 and 1997 only.

	Unabated Furnaces mg/m³ (kg/tonne glass melted)	Abated Furnaces Primary/Secondary Methods mg/m³ (kg/tonne glass melted)
Oxides of Nitrogen (as NO ₂)	1800 - 2870 (1.7 - 7.4)	495 - 1250 (1.1 - 2.9)
Oxides of Sulphur (as SO ₂)	365 - 3295 (1.0 - 10.6)	218 - 1691 (0.54 - 4.0)
Particulate matter	99 - 280 (0.2 - 0.6)	5.0 - 40 (0.02 - 0.1)
Fluorides (HF)	<1.0 - 25 (<0.002 - 0.07)	<1.0 - 4.0 (<0.002 - 0.01)
Chlorides (HCl)	7.0 - 85 (0.06 - 0.22)	4.0 - 30 (<0.01 - 0.08)
Metals	<1.0 - 5.0 (<0.001 - 0.015)	<1.0 (<0.001)

Table 3.11: Emission levels from unabated and abated flat glass furnaces

Reference conditions are: dry, temperature 0°C (273K), pressure 101.3 kPa, 8 % oxygen by volume.

The term unabated furnaces refers to furnaces operating normally with no specific pollution control technology. The values in the table are actual reported measurements, but because the data relates to 1996 and 1997 one important result is missing. This is the Saint Gobain plant at Aniche, which operates the FENIX process and in 1998 was achieving emission levels for NO_x of 510 mg/Nm³ and 1.1 kg/tonne of glass melted, with essentially primary techniques.

For the unabated furnaces the maximum and minimum emission levels were not substantially different from the 80 percentile values, and there were too few abated furnaces to make an 80 percentile analysis meaningful (e.g. there were only 2 furnaces operating deNO_x techniques). Therefore 80 percentile values are not presented.

For unabated furnaces the highest emissions of NO_x were from highly loaded gas-fired plants, and the lowest are from oil-fired plants. The two abated emissions were from a furnace operating 3R on two ports only, and from a furnace with SCR.

The highest emissions of SO_x for unabated furnaces are from oil fired plants with high-sulphur fuel, and the lowest are from low loaded gas-fired plants. The highest emissions of dust for unabated furnaces are from oil fired plants, and the lowest are from low loaded gas fired plants with high cullet levels. For unabated furnaces the highest emissions of HCl and HF are from plants with relatively high levels of Cl and F in the raw materials. The highest emissions of metals from unabated furnaces are from oil fired plants or those using colouring agents (Se, Co, Fe and Cr), and the lowest are from gas fired plants. The ranges of emissions of SO_x, dust, HCl, HF and metals from abated furnaces were associated with installations operating particulate abatement systems in combination with acid gas scrubbing, in order to meet local permit requirements. For metals this meant emissions were beneath detection limits.

3.4.2.3 Downstream Activities

The emission of tin vapour from the float bath has been found to be very low and it is generally monitored only to ensure low workplace exposure levels. The issue is not considered further in this document.

The on-line coating processes applied to flat glass are very case specific and the raw materials used and the pollutants emitted will vary. However, emissions will typically contain acid gases (HF, HCl) and fine particulate matter (e.g. oxides of silicon and tin). This type of process is usually subject to the general local environmental legislation and abatement is installed accordingly. For example, HCl 10 mg/m³, HF 5 mg/m³, particulate 20 mg/m³, and tin compounds 5 mg/m³.

3.4.3 Emissions to Water

As discussed earlier the main uses of water in this sector are cleaning, cooling, and batch humidification. The aqueous emissions are limited to the cooling water system purges, cleaning waters and surface water run off. The cleaning waters do not present any particular issues that would not be common with any industrial facility i.e. inert solids and oil. Cooling system purges will contain dissolved salts and water treatment chemicals. Surface water quality will depend on the degree of drainage segregation and site cleanliness.

Excluding domestic wastewater, discharges generally only contain glass solids, potentially some oil contamination, and cooling water system treatment chemicals. Simple abatement techniques such as settlement, screening, oil separators, and neutralising can be found within the sector.

3.4.4 Other Wastes

Wherever possible, batch plant dusts are returned to the raw material silos and reused in the process. Reject batches are gradually fed back into the process by the inclusion of small amounts in subsequent batches wherever possible. Typically 99 % of the glass waste from the end of the glassmaking process, trims, rejects and damaged glass, is returned to be remelted.

At the end of a furnace campaign, the refractory structure (sometimes not regenerators) is dismantled and replaced. As in the Container Glass Sector as much as practicable of this material is recovered for reuse or sale. The issues concerning chromium containing materials are discussed in Section 3.2.2.3.

Most glass raw materials are generally delivered in bulk and do not give rise to packaging waste. Waste materials from product packaging operations (plastic, cardboard, wood etc) are usually reused or recycled if practicable. Other waste non specific to the industry are disposed of by conventional means.

3.4.5 Energy

[tm18 CPIV, tm14 ETSU]

The energy usage distribution for a typical float glass process is shown in Figure 3.2 below, but energy usage in particular processes may vary slightly. It can be seen that over three quarters of the energy used in a glass plant is expended on melting glass. Forming and annealing takes a further 5 % of the total. The remaining energy is used for services, control systems, lighting, factory heating, and post forming processes such as inspection and packaging.

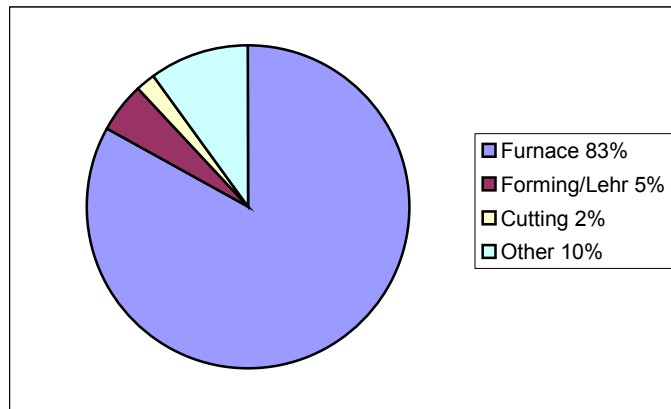

Figure 3.2: Energy usage for a typical float glass process

Float glass furnaces are almost exclusively fired on heavy fuel oil or natural gas, sometimes with electrical boost at up to 5 %. Many furnaces have the capacity to fire on either oil or gas, or potentially both at the same time on different burners. There are some examples of electrical furnaces, but these are small scale and for specialist applications. There is also one oxy-fuel fired furnace in the USA, which began operation in 1998.

Forehearths (in rolled glass) and annealing lehrs are heated by gas or electricity. Electrical energy is used to drive air compressors and fans needed for the process. General services include water pumping, usually steam generation for fuel storage and trace heating, humidification/heating of the batch and sometimes heating buildings. In some cases, larger furnaces have been equipped with waste heat boilers to produce part or all of the steam required.

The energy consumption of the process will depend on many factors, the main ones are those outlined in Section 3.2.3. The range of energy consumption encountered within the sector is quite narrow, because there is relatively little variation in the type of furnace used. Energy levels for melting are typically 5.5 to 8.0 GJ/tonne of glass melted, with specific energy requirements for the process as a whole generally less than 8.0 GJ/tonne.

3.5 Continuous Filament Glass Fibre

The major output mass flow is the product, which may be from 55 % to 80 % of raw material input. The losses arise through emissions to air, solid residues, and aqueous wastes. The molten glass represents around 80 - 85 % of the furnace raw material input. Most of the loss is made up of gaseous emissions particularly CO₂ from the decomposition of carbonates. Waste fibre and

drain glass can be between 10 and 30 % of process inputs. Table 3.12 below shows a typical input/output summary for the manufacture of continuous filament glass fibre.

		Amount/tonne of product			
		Input	Unit	Output	Unit
Raw materials for glass					
	Silica	300 - 457	kg		
	Colemanite	141 - 250	kg		
	Calcium carbonate	300 - 411	kg		
	Clay	395 - 544	kg		
	Fluorspar	0 - 20	kg		
	Others	3 - 153	kg		
Emissions to air					
	Dust without abatement system			1.4 - 4	kg
	Dust with abatement system			0.02 - 0.24	kg
	CO ₂ from raw materials decomposition			120 - 200	kg
	CO ₂ from combustion			450 - 1000	kg
	Water vapour from combustion / raw material decomposition			180 - 800	kg
	Water from drying processes			75 - 200	kg
	NO _x (as NO ₂)			2.6 - 6.7	kg
	SO _x (as SO ₂)			1 - 8	kg
	HF			0 - 2	kg
	HCl			0.03 - 0.12	kg
	Water from evaporative, cooling			3200	kg
	VOC in forming area, ovens...			0.1 - 0.5	kg
Binder products balance					
(as supplied)	Polymers (~50 % solid)	20 - 40	kg		
(as supplied)	Silane	1 - 2	kg		
(as supplied)	Lubricants	1 - 5	kg		
(as supplied)	Others	0 - 10	kg		
(dry solids)	Binder on glass			4 - 20	kg
(dry solids)	Binder in waste water			1 - 13	kg
(dry solids)	Binder in solid waste			<1	kg
	Binder in air (see VOC above)				kg
Water balance	Total	5000 - 20000	kg		
	Added for binder	<200	kg		
	For cooling (added)	>1500	kg		
	For spraying, cleaning	>3000	kg		
	In waste glass			10 - 20	kg
	In sewage			1500 - >6000	kg
	In air (ovens)			100 - 200	kg
Solid wastes (dry solids)					
	Fibre glass			60 - 250	kg
	Binder wastes			1 - 13	kg
Energy	Total	22.3 - 36	GJ		
	Energy for melting (Furnace + Forehearth)	11.2 - 23	GJ		
	Energy for forming (including bushing, winders, direct choppers, etc)	2.5 ⁽¹⁾	GJ		
	Energy for processes (including oven, winders, choppers, etc)	2.2 ⁽¹⁾	GJ		
	Energy for utilities	1.1 ⁽¹⁾	GJ		
	Heat out of the stack			1.8 - 2.9	GJ

**Table 3.12: Overview of Continuous Filament Glass Fibre Sector inputs and out puts [tm18 CPIV]
(1) One example furnace**

3.5.1 Process inputs

The chemical composition of the fibre varies depending on the glass type and the end use, and is usually expressed in terms of the oxides of the elements it contains. It is difficult to identify a “typical” batch composition beyond that given in Table 3.12 above. The basic raw materials are

selected and blended to give the final desired glass compositions following melting. The typical glass types and composition ranges are shown in Chapter 2. Table 3.13 below shows the main raw materials used to achieve these compositions.

Glass forming materials	Silica sand.
Glass intermediate and modifying materials:	Calcium carbonate, calcium oxide, alumina silicate, colemanite, calcium borate, borax, boric acid, feldspar, fluorspar, calcium sulphate, sodium carbonate, potassium carbonate, sodium sulphate, zinc oxide, titanium oxide or rutile, zirconium oxide, dolomite, iron oxide.
Coating materials:	The coating material will vary depending on the end use of the product. Typical coatings are: film formers (e.g. polyvinyl acetate, starch, polyurethane, epoxy resins); coupling agents (e.g. organo-functional silanes); pH modifiers (e.g. acetic acid, hydrochloric acid, ammonium salts); and lubricants (e.g. mineral oils, surfactants).
Binders for secondary products:	Polyvinylacetate, saturated polyester powders, phenolic resin powders.
Fuels:	Fuel oil, natural gas, electricity.
Water:	Mains supply and local natural sources (wells, rivers, lakes etc).
Ancillary Materials:	Packaging materials including plastics, paper, cardboard, etc. Process gases, oxygen. Water treatment chemicals for cooling water and wastewater.

Table 3.13: Materials utilised in the Continuous Filament Glass Fibre Sector

The largest inputs to the process are the silica sand, the alkali/alkali earth metal carbonates and oxides, alumina and the boron containing materials. In the E glass composition the oxides of silicon, sodium, potassium, calcium, magnesium, boron and aluminium account for over 95 % of the glass. The dominant oxides and the main materials from which they are derived are: SiO₂ (53 - 60 % - sand); CaO+MgO (20 - 24 % - limestone, dolomite); B₂O₃ (0 - 10 % - colemanite, borax, etc); Al₂O₃ (11 - 16 % - alumina); and Na₂O+K₂O (<2 % - soda ash/potash).

Coating materials represent a very small proportion of the product mass, typically 0.5 % to 2 %. They consist mainly of aqueous polymer solutions, typically 50 % solids, and smaller amounts of the other materials specified in Table 3.13.

Water is used for cooling, cleaning, coating preparation and in some cases for wet scrubbing systems. One of the main characteristics of the manufacture of glass fibres, is the need for a large amount of water for cooling. Each bushing needs water to reduce the temperature of the filament very quickly from 1250°C to ambient temperature. This cooling is achieved by transferring heat to metallic bars close to the bushing tips, and cooling by circulating water, passing cold air through the filaments, and by water sprays. Cooling water is also required around the furnace and the forehearth, Cooling water is generally in semi-closed circuits and total flows are typically several thousands of m³/h.

Significant amounts of water are also used in coating preparation and wash down in the forming/winding area. The total water consumption per tonne of finished product is typically between 4 and 20 m³, cooling system losses account for around 20 % of this figure.

3.5.2 Emissions to Air

3.5.2.1 Raw Materials

In most modern processes silos and mixing vessels are fitted with filter systems which reduce dust emissions to below 5 mg/m^3 . Mass emissions from both filtered and unfiltered systems will clearly depend on the number of transfers and the amount of material handled. The storage and handling of coating materials may also give rise to emissions of dusts or volatile organic compounds (VOC), but these are generally very low and can be controlled by good practice and local extraction.

3.5.2.2 Melting

{tm18 CPIV}

In the Continuous Filament Glass Fibre Sector the greatest potential environmental emissions are emissions to air from the melting activities. The major substances emitted and the associated sources are identified in Section 3.2.2.1. The predominant furnace type in this sector is a natural gas fired recuperative furnace, with the facility for electric boost (some furnaces are oil fired).

A summary of the range of emissions to air is given in Table 3.14 below. The table shows figures for both primary and secondary abatement methods. The dust emission is predominantly composed of alkali sulphates and borates. (e.g. sodium/potassium sulphate and sodium/potassium borate).

	Primary abatement methods mg/m^3 [kg/tonne glass melted]	Secondary abatement methods mg/m^3 [kg/tonne glass melted]
Oxides of Nitrogen (as NO_2)	670 - 1600 [0.5 - 8.0]	no examples of secondary abatement
Oxides of Sulphur (as SO_2)	150 - 1200 [0.75 - 6.0] (gas fired) up to 3000 [15] (oil fired)	no examples of secondary abatement
Particulate matter	200 - 500 [1.0 - 2.5]	5 - 50 [0.025 - 0.25]
Fluorides (HF)	10 - 50 [0.05 - 0.25] (no added fluoride) 50 - 400 [0.25 - 2.0] (added fluoride)	<20 [<0.1]
Chlorides (HCl)	<10 [<0.05]	<10 [<0.05]
Metals	<5 [<0.025]	<5 [<0.025]

Table 3.14: Emission levels from continuous filament glass fibre furnaces

Reference conditions: dry, temperature 0°C (273K), pressure 101.3 kPa, 8 % oxygen by volume.

The lowest mass emission for NO_x relates to an oxy-fuel furnace and therefore does not relate to the same furnace as the lowest concentration.

Emission levels for a particular furnace can depend on many factors, including batch composition, abatement techniques utilised, and the age of the furnace. Emissions of fluorides are directly related to the use of compounds containing fluorine in the batch. In some cases fluoride is added as a raw material to meet the requirement of the glass composition, in others it is an impurity of some raw materials. Whatever the origin, a portion of the fluoride will be emitted in the waste gases from the furnace. The fluoride concentration can vary significantly depending on the level of fluoride in the batch and the abatement measures used. The amount of fluorine considered necessary will depend on a variety of specific technical factors related to furnace and fibre forming design, throughput and filament diameter requirements of the finished product.

3.5.2.3 Downstream Activities

[tm18 CPIV]

Emissions to air from coating application are usually quite low, due to the general low volatility of the coating materials and the low glass temperatures at the point of application. However, the airflows in the forming area are very high to ensure adequate cooling of the glass and some carry over of droplets or evaporation of organic compounds occurs. In most cases, the extracted cooling air is treated by water scrubbing systems prior to release or partial recycling into the forming area. The high volume of cooling air means that emission concentrations are generally quite low. Limited measurements (including the use of coatings with higher solvent levels) have shown VOC concentrations from very low levels up to 20 mg/m³.

The coating materials are generally water based and the fibre cakes are often dried in ovens. The drying process will give rise to emissions of water vapour and any substances volatile at the drying temperatures. The coatings are chemically bonded to the glass during the drying process and emissions levels are generally relatively low. However, the coating formulations, and so the emissions, can vary widely, and only a limited number of measurements are available from recent years. These show VOC emissions ranging from barely detectable to a maximum of 70 mg/m³, which equated (in this example) to less than 100 g/h.

Emissions can also arise from secondary processing to produce mats and tissues, which involve the use of binders which must be cured or dried. Again very little information is available and this indicates a wide variation depending on the techniques and substances used. Maximum reported VOC emissions were 150 mg/m³ and 270 g/h.

3.5.3 Emissions to Water

[tm18 CPIV]

Emissions arise from the forming area, binder preparation, cleaning, cooling, tissue/mat binder application, and from water based scrubbing systems. The main source of emission is the forming area. Due to the high speed of the winders (centrifugal action) and movement of the filaments during the forming process, a proportion of the applied binder is thrown off and squeezed out. This is collected in the immediate area together with the water used to periodically clean the forming and winding area. The water sprayed on the filaments is also collected in the same place.

Emissions can arise in the binder preparation area from spillages and leaks, which drain to the waste water system. The high volume cooling water systems require a purge stream, which will contain low levels of water treatment chemicals. Most scrubbing systems in use are recirculating water scrubbers, which require either a purge stream or periodic discharge and replacement of the scrubbing medium. The total water consumption per tonne of finished product is typically 4 to 20 m³, cooling system losses (purge and evaporation) account for around 20 % of this figure. With the clear exception of evaporative losses most of this water is discharged as wastewater. The general practice within the sector is to discharge to a sewage treatment works or to treat on-site.

The wastewater pollutant concentrations are usually very low (less than 0.2 % solid content before any treatment), due to the dilution by wash down water, and their content is mostly biodegradable. The chemicals used do not contain any heavy metals, or dangerous listed substances, but the actual composition varies widely from site to site, due to the great variety of binder compositions. For some products a chrome based coupling agent is still used, but this is being gradually phased out.

3.5.4 Other Wastes

[tm18 CPIV]

Wastes can arise in the batch plant from reject batches and spillages or leakages. The process is very sensitive to raw material quality and in general such wastes are sent to landfill (5 to 50 tonnes per year).

The molten glass delivered by the melter to the forehearths may include small quantities of impurities (unmelted particles), which have the potential to cause bushing filament breaks and thus waste glass fibres. In order to reduce such breaks, drain bushings can be installed at the bottom of the channel feeding the forehearths in order to withdraw a small flow of glass containing these denser unmelted particles. When drain bushings are used, this drain glass is typically 1 to 5 % of the melted glass. The drain glass can be processed into cullet and either recycled internally or used in other applications. The internal recycling of this material is not usually desirable, because it involves returning to the furnace the separated impurities that will flow back to the bushings. This could lead to a gradual build up of unmeltable material and potentially a higher level of drain glass.

Waste glass and fibre also arise due to product change over, package change over, and filament breakage, when the glass is still flowing but cannot be converted into saleable product. Manufacture of very low diameter filaments (from 5 μ m to 25 μ m) is difficult without some level of breakage. Consequently the quantity of waste glass fibre can be relatively high, and usually forms one of the main waste streams from the process. The amount of waste can be between 10 and 25 % of the total amount of molten glass that flows out of the furnace, depending on the type of forming process and on the diameter of the filaments. These quantities can be greatly increased when problems occur with raw materials, or in the performance and stability of the furnace. The waste fibre contains up to 25 % water and dilute binder.

The conversion of cake to finished product results in an amount of waste, which varies, depending on the products, from 3 to 10 %. The unusable material is mostly from the inside and outside of the cakes, fuzz, damaged and reject material, test samples, mat trimmings, etc. Commonly the waste contains coating material at a level from 0.5 to 10 % (up to 20 % for tissues), and may contain water up to 15 %.

The dust collected in abatement equipment can be recycled to the furnace. If dry scrubbing techniques are incorporated this may be more difficult requiring blending or processing.

3.5.5 Energy

[tm18 CPIV, tm14 ETSU]

The energy usage distribution for a typical continuous filament process is shown in Figure 3.3 below. Energy usage in particular processes may vary depending on the size of the melter and the type of downstream processes. It can be seen that generally over three quarters of the energy is used for melting. Forming, including bushing heating, and product conversion account for around 15 %, and the remaining energy is used for services, control systems, lighting, and factory heating.

Most furnaces in this sector are gas fired recuperative furnaces some with electric boost (up to 20 % of melting energy). There are also examples of oil fired furnaces, oxygen enriched firing and some oxy-gas furnaces. The air preheat temperature of recuperative furnaces is lower than that of regenerative furnaces and the energy requirements are consequently higher per tonne of glass. In this sector the electrical conductivity of the glass is very low, and currently 100 % electric melting is not considered economically or technically practicable.

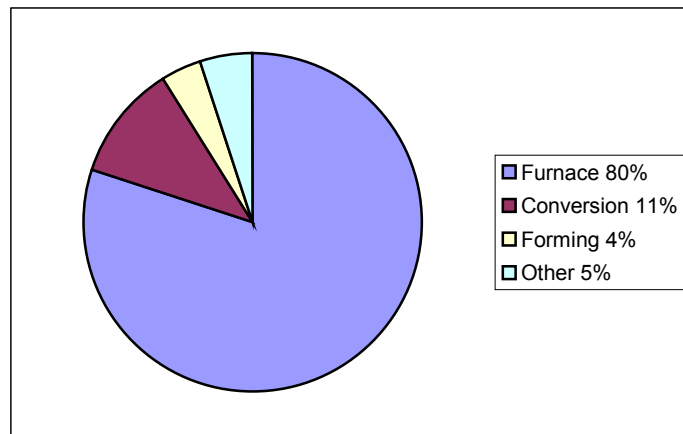

Figure 3.3: Energy usage in a typical continuous filament glass fibre process

The energy consumption of the process will depend on many factors, the main ones are outlined in Section 3.2.3. Energy consumption for melting is typically 11 to 23 GJ/tonne of melt, although for some small furnaces producing specialised compositions this can be up to 30 GJ/tonne. Overall energy consumption is usually in the range 18 to 33 GJ/tonne of product. Maximum crown temperatures in continuous filament glass fibre furnaces are typically around 1650°C, which is up to 50°C higher than container glass and up to 250°C higher than glass wool. The higher melting temperatures contribute to the relatively high specific energy consumption in this sector

3.6 Domestic Glass

[tm27 Domestic]

As described in Chapters 1 and 2 the Domestic Glass Sector is very diverse, producing a wide range of products from different compositions and furnace types. Therefore, there is quite a wide variation in the process inputs and outputs. As in all other sectors the main output from the process is the product. In soda-lime production the product represents 50 to 90 % (average 85 %) of the raw material input, for lead crystal this figure is 35 % to 80 % (average 75 %). The lower figure for lead crystal is due to a range of factors such as more cutting and polishing, and higher quality constraints. The other types of domestic glass (crystal, opal, borosilicate and glass ceramic) have values between the two extremes. Table 3.15 below summarises the main input and output parameters for soda-lime and lead crystal, and again the values for the other domestic glass types lie between the examples given.

		Soda-lime Glass	Lead Crystal
	units/tonne of glass melted	range (mean value)	range (mean value)
Inputs			
Energy, oil / gas	GJ	5 - 14 (9)	0.5 - 5 (3)
Energy, electricity	GJ	1 - 4 (2.5)	1 - 6 (4)
Silica sand	tonne	0.65 - 0.75 (0.6)	0.20 - 0.50 (0.42)
Carbonates	tonne	0.3 - 0.42 (0.34)	0.08 - 0.20 (0.14)
Lead Oxide	tonne		0.08 - 0.21 (0.18)
Minor mineral ingredients	tonne	0.02 - 0.08 (0.04)	0.005 - 0.02 (0.01)
Internal cullet	tonne	0.15 - 0.4 (0.25)	0.25 - 0.65 (0.35)
Packaging materials	tonne	0.06 - 0.20 (0.1)	0.06 - 0.20 (0.1)
Moulds and other	tonne	0.001 - 0.003 (0.002)	0.001 - 0.003 (0.002)
Water	m ³	4 - 9 (7)	3 - 70 (7.5)
Hydrofluoric acid (100 %)	kg/t glass ac. pol. ⁽¹⁾		40 - 130 (65)
Sulphuric Acid (96 %)	t/t HF(100 %) ⁽¹⁾		1 - 10(5)
Sodium hydroxide	t/t HF(100 %) ⁽¹⁾		0 - 0.2(0.1)
Calcium hydroxide	t/t HF(100 %) ⁽¹⁾		1 - 10(4)
Fresh washing water	t/t HF(100 %) ⁽¹⁾		0.025 - 0.07(0.05)
Outputs			
Finished, packed products	tonne	0.5 - 0.9 (0.85)	0.35 - 0.8 (0.75)
Emissions to Air	kg		
CO ₂		150 - 1000(700)	150 - 400(300)
NO _x		0.9 - 11(4.8)	0.9 - 5.0(1)
SO _x		0.1 - 2.8(0.7)	0.1 - 1.0(0.2)
Dust		0.001 - 0.8(0.4)	0.001 - 0.1(0.02)
H ₂ O		60 - 500(300)	60 - 250(120)
Waste water	m ³	3.6 - 9.1 (6.3)	2.7 - 70 (6.8)
Internal cullet	tonne	0.15 - 0.4 (0.25)	0.25 - 0.65 (0.35)
Waste to recycling	kg	10 - 60 (30)	10 - 60 (30)
Other waste	kg	6 - 50 (10)	6 - 50 (10)
Waste to recycling PbSO ₄ O ₂ PbCO ₃	t/t HF(100 %) ⁽¹⁾		0.2 - 1.5(0.8)
CaSO ₄	t/t HF(100 %) ⁽¹⁾		2 - 20(7.5)
Waste to deposition Cutting sludge	t/t HF(100 %) ⁽¹⁾		0.3 - 0.7(0.45)
Heavy metal sludge	t/t HF(100 %) ⁽¹⁾		0.1 - 0.5(0.3)

Table 3.15: Overview of Domestic Glass Sector inputs and outputs

(1) With regard to acid polishing, the consumption of 100 % hydrofluoric acid is the best reference parameter because it takes into account the surface/volume ratio. Consumption of 100 % HF/tonne of glass acid polished will depend on the surface area/volume ratio and consequently on the types of articles being polished.

3.6.1 Process inputs

The inputs to the process will vary depending on the product made and the required glass composition. The main glass types are soda-lime, lead crystal, crystal, borosilicate, opaque, and glass ceramics. The main raw materials utilised within the sector are outlined in Table 3.16 below.

Glass forming materials	Silica sand, process cullet.
Glass intermediate and modifying materials	Sodium carbonate, potassium carbonate, limestone, dolomite, sodium sulphate, alumina, nepheline syenite, sodium nitrate, potassium nitrate, borax, arsenic, antimony carbon, lead oxide, fluorspar.
Glass colouring and decolouring agents	Oxides of chromium, iron, cobalt, copper, manganese, nickel, and selenium or zinc selenite, cerium.
Product coating agents	Inorganic or organic metal chlorides. Predominantly tin tetrachloride, titanium tetrachloride and monobutyl tin chloride.
Product lubricants	Polythene based lubricants and fatty acids (e.g. oleic acid).
Fuels	Fuel oil, natural gas, electricity, butane, propane, acetylene.
Water	Mains supply and local natural sources (wells, rivers, lakes etc).
Ancillary Materials	Packaging materials including plastics, paper, cardboard, and wood. Mould lubricants, generally high temperature graphite based release agents. Machine lubricants, predominantly mineral oils. Process gases oxygen and hydrogen. Polishing materials mainly strong mineral acids (HF, H ₂ SO ₄) also NaOH. Decorating materials, enamels, sands. Water treatment chemicals for cooling water and wastewater.

Table 3.16: Materials utilised in the Domestic Glass Sector

The raw materials for the glass batch are blended in the correct proportion to produce the desired glass composition. For soda-lime glass the oxides of silicon, sodium and calcium account for over 90 % of the glass (SiO₂ 71 - 73 %, Na₂O 12 - 14 % and CaO 10 - 12 %). The silicon dioxide is derived mainly from sand and cullet. Sodium oxide is derived mainly from soda ash, and calcium oxide mainly from limestone. A typical composition range for lead crystal is SiO₂ 54 - 65 %, PbO 25 - 30 %, Na₂O or K₂O 13 - 15 %, plus other various minor components. In crystal glass formulations, lead oxide is partially or totally replaced by barium, zinc or potassium oxides, the limits being defined in Directive 69/493/EEC.

Borosilicate glasses contain boron trioxide (B₂O₃) and a higher percentage of silicon dioxide. A typical composition is 70 - 80 % SiO₂, 7 - 15 % B₂O₃, 4 - 8 % Na₂O or K₂O, and 2 - 7 % aluminium oxide Al₂O₃. The boron trioxide is derived from borax or other boron containing materials, and the aluminium oxide is derived mainly from alumina.

Opaque glasses are composed mainly of the oxides of silicon, sodium, calcium, aluminium and potassium, but they also contain around 4 - 5 % of fluoride derived from minerals such as fluorspar. The predominant oxides of ceramic glass are silicon, aluminium, sodium and calcium with lower levels of magnesium, barium, zinc, zirconium, lithium and titanium. The use of cullet within the sector varies, most processes will recycle internal cullet, but external cullet is not normally used due to quality considerations.

The Domestic Glass Sector uses different types of refining agents nitrates, sulphates, and in some specific cases arsenic and antimony compounds typically As 0.1 - 1 % and Sb 0.1 - 0.4 % of the batch. Selenium is also used, as a decolourising agent typically <1 % of the batch. In lead crystal production it is generally necessary to polish the glass after cutting, currently the most common way of doing this is by dipping in a mixture of strong hydrofluoric and sulphuric acid, and then rinsing with water. Some products receive surface treatments similar to those in the Container Glass Sector described in Section 3.3.

The fuels used will vary from process to process, but in general, natural gas, fuel oil and electricity are used for glass melting, either separately or in combination. Forehearths and annealing lehrs are heated by gas or electricity, which are also used for heating and general services. Light fuel oil, propane and butane are sometimes used as backup fuels and for surface finishing (also acetylene).

In general, the main uses of water in the Domestic Glass Sector are for cooling circuits and cleaning. Cooling water is used, usually in closed or open circuits, to cool various equipment with corresponding losses from evaporation and purges. Water is also used in specific downstream steps of the process (cutting, polishing, washing etc) and for wet scrubber systems. Therefore, actual water consumption may vary according to local conditions (e.g. ambient temperature and the hardness of water input).

3.6.2 Emissions to Air

[tm27 Domestic]

3.6.2.1 Raw Materials

In most modern domestic glass processes silos and mixing vessels are fitted with filter systems which reduce dust emissions to below 5 mg/m³. Mass emissions from both filtered and unfiltered systems will depend on the number of transfers and the amount of material handled. However, a characteristic of this sector is that some batch plants are relatively small and due to the specialised nature and lower volumes of some of the products, there is a higher level of manual (and semi-manual) handling and transfer. Emissions from these activities will depend on how well systems are controlled, this is discussed further in Chapter 4. Clearly where materials containing potentially more toxic compounds (e.g. lead oxide, arsenic, etc) are handled there is the potential for emission of these substances. Usually specific controls are used to prevent emissions (e.g. dust extraction and pneumatic handling) and consequently emissions levels are usually very low.

3.6.2.2 Melting

[tm27 Domestic]

In the Domestic Glass Sector the greatest potential environmental emissions are emissions to air from the melting activities. The main substances emitted and the associated sources are identified in Section 3.2.2.1. In this sector there is a wide range of products and most of the melting techniques described in Chapter 2 can be found. Fuels can be natural gas, oil or electricity. A summary of the range of emissions to air is given in Table 3.17 below. This data is for emissions from soda-lime furnaces and lead crystal furnaces only. These figures taken together are considered to represent the full range of the sector, with emissions from other glass types falling between the examples.

Substance	Soda-lime Glass (mean figure)		Lead Crystal (mean figure)	
	mg/Nm ³	kg/tonne of melt	mg/Nm ³ ⁽¹⁾	kg/tonne of melt
Oxides of Nitrogen (as NO ₂)	140 - 5500 ⁽²⁾ (2300)	0.9 - 11 (4.8)	1000 - 2000 (1500)	0.9 - 5.0 (1)
Oxides of Sulphur (as SO ₂)	50 - 1000 (250)	0.1 - 2.8 (0.7)		0.1 - 1 (0.2)
Particulate Matter	0.5 - 400 (200)	0.001 - 0.8 (0.4)	2 - 10 (5)	0.001 - 0.1 (0.02)
Fluorides (HF)	<5		0.1 - 1.0 (0.5)	0.0002 - 0.004 (0.0003)
Chlorides (HCl)	<10		0.5 - 5.0 (2.0)	0.001 - 0.003 (0.002)
Metals (including lead)	<5		0.05 - 0.5 (0.2)	0.0001 - 0.035 (0.01)

Table 3.17: Summary of emissions to air from domestic glass furnaces

⁽¹⁾ These data relate to conventional furnaces (i.e. not electrical)

⁽²⁾ Some high results relate to the use of nitrates in the batch or to other specific conditions (e.g. very low pull rate).

Emission levels for a particular furnace can depend on many factors, such as batch composition, abatement techniques utilised, and the age of the furnace. Emissions of fluorides, lead and other metals are directly related to the use of compounds containing these substances in the batch. In some cases fluoride is added as a raw material to meet the requirement of the glass composition; in others it is an impurity of some raw materials. Some of the material will be incorporated into the glass but some will inevitably be emitted to air. Fluorine is usually emitted as HF, and metals can be emitted as fumes or more commonly contained in the particulate matter.

3.6.2.3 Downstream Activities

Soda-lime products may have surface treatments applied. The treatments and emissions are similar to those described for container glass in Section 3.3.2. Many products are fire finished which does not give rise to emissions other than the flame combustion products. Acid polishing of lead crystal products can lead to emissions of acid fumes (HF and SiF₄) which are usually treated in scrubbing towers circulating water or an alkali solution (e.g. sodium hydroxide). Emissions from these processes tend to be quite low after scrubbing. Grinding and cutting activities can give rise to dust emissions. These are usually controlled by cutting under liquid or with local air extraction.

3.6.3 Emissions to Water

[tm27 Domestic]

In common with other sectors of the industry, the main water uses are for cooling and cleaning purposes, and aqueous emissions are limited to the cooling water system purges, cleaning waters and surface water run off. The cleaning waters do not, in general, present any particular issues that would not be common with any industrial facility i.e. inert solids and potentially oil. Cooling system purges will contain dissolved salts and water treatment chemicals. Surface water quality will depend on the degree of drainage segregation and site cleanliness.

However, the production of certain products in particular lead containing glasses can give rise to other direct emissions, which may contain lead or other compounds. The main potential sources of contaminated wastewater are: cleaning waters from areas where batch material may have been spilled (may contain lead, arsenic, antimony, etc); and the water used in the cutting and grinding of the products. Most processes will utilise techniques to remove solids e.g. settlement, precipitation, flocculation to achieve compliance with local requirements. Lead levels below 1 mg/l are common.

Acid polishing also results in emissions to water. After dipping in acid the glass has a layer of lead sulphate and hexafluorosilicates on the surface. This is washed off with hot water which will become acidic and will contain lead sulphate. Depending on the chemicals used to neutralise this water the lead sulphate may further react (e.g. to form CaSO_4 with $\text{Ca}(\text{OH})_2$) changing the form of the lead.

The polishing process also results in a small proportion of the glass dissolving, which is partly precipitated from the acid bath as a mixture of salts that after separation gives an "etching sludge". This sludge is processed by filtering and washing in order to obtain lead sulphate, or by reaction with calcium or sodium carbonate in order to obtain lead carbonate. Both products can be reused as raw materials (reintroduced in the batch) or recovered. The liquid fraction from the processing of the etching sludge gives an acidic solution which is reused in the polishing bath.

The fumes from the acid bath react in the water to give hexafluorosilicic acid (H_2SiF_6) at concentrations up to 35 %. This acidic water must be neutralised before discharge. Alternatively the acid can in some circumstances be recovered and sold to the chemical industry.

3.6.4 Other Wastes

Most glass waste (cullet) is recycled back to the furnace and waste levels are generally quite low. General wastes from packaging and furnace repairs are common with other sectors. Waste from dust control systems and dry scrubbing are generally recycled to the furnace. In lead crystal production the sludges separated from the waste water system must be disposed of where they cannot be reused. The formation of the sludge is discussed in Section 3.6.3 above and figures are given in Table 3.15.

3.6.5 Energy

[tm14 ETSU]

The consideration of energy consumption in this sector is quite difficult due to its diversity and the wide range of melting techniques employed. High volume production of soda-lime tableware has much in common with container glass production, see Section 3.3.5, and shows comparable energy usage distribution. However, a higher proportion of energy use is associated with downstream operations (e.g. fire polishing and finishing). Specific energy consumption for melting is higher in this sector than for container glass. This is because furnaces tend to be smaller, melting temperatures are slightly higher, and residence time in the furnace is up to 50 % longer.

Some other processes within the sector, particularly lead crystal production, are carried out on a much smaller scale and pot furnaces may be used. The energy usage distribution for high quality lead crystal manufacture from pot furnaces is shown in Figure 3.4 below. This is not typical of the sector as a whole.

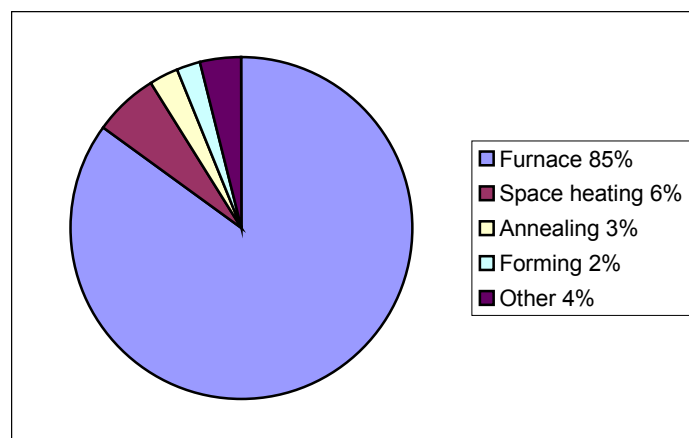

Figure 3.4: Energy usage in lead crystal manufacture (pot furnace)

The overall energy consumption for lead crystal manufacture can be as high as 60 GJ/ tonne of finished product, when the calculated energy requirement is only around 2.5 GJ/tonne. The difference can be due to many factors, but the main ones are:

- High quality requirements may lead to high reject levels. The pot is slowly dissolved by the glass, leading to cords and stones in the product.
- The glass is frequently hand worked and the yield from forming may be below 50 %, and the articles may need reheating during forming.
- The pots have to be “founded” or fired up to high temperature before use, and they have a very limited lifetime compared to continuous furnaces.

Electric melting of lead crystal allows the use of high quality refractories, which give a much higher glass quality and therefore lower reject rate and better yield. The continuous nature of electric melting also means it is often associated with more efficient automated forming. These factors can lead to energy consumption close to the figure of 25 GJ/tonne of product. Other continuous or semi-continuous melting techniques can similarly lead to better energy efficiencies.

3.7 Special Glass

The Special Glass Sector is very diverse with a wide range of products, glass formulations and process techniques. Many installations do not meet the 20 tonnes/day criteria specified in Directive 96/61/EC unless they are associated with other furnaces. Therefore, it is not practicable or indeed necessarily useful to try to summarise the full range of emissions from the whole of the sector. However, over 70 % of the sector capacity is made up of TV glass and water glass. This section attempts, where possible, to cover the entire sector but quantitative information is only provided for TV glass and water glass manufacture.

3.7.1 Process inputs

[tm25 Special]

The chemical composition of the glass varies depending on the glass type and the end use, and is generally expressed in terms of the oxides of the elements it contains. It is difficult to identify “typical” batch compositions for such a diverse sector. The basic raw materials are selected and blended to give the final desired glass compositions following melting. The typical glass types and composition ranges are shown in Chapter 2. Table 3.18 below shows the main raw materials used to achieve these compositions.

More detailed information is given for the inputs for water glass and TV glass in Table 3.19, Table 3.20, and Table 3.21. This data is for three specific example processes.

Glass forming materials	Silica sand, process cullet.
Glass intermediate and modifying materials	Sodium carbonate, potassium carbonate, limestone, dolomite, sodium sulphate, alumina, sodium nitrate, potassium nitrate, borax, boric acid (pure for some applications), arsenic (As ₂ O ₃), antimony (Sb ₂ O ₃), carbon, lead oxide, strontium carbonate, fluorspar, nepheline syenite, feldspars, sodium chloride.
Glass colouring agents	Iron chromite, iron oxide, cobalt oxide, selenium or zinc selenite, cerium.
Fuels	Fuel oil, natural gas, electricity, butane, propane, acetylene.
Water	Mains supply and local natural sources (wells, rivers, lakes etc).
Ancillary Materials	Packaging materials including plastics, paper, cardboard, and wood. Mould lubricants, generally high temperature graphite based release agents. Machine lubricants, predominantly mineral oils. Process gases nitrogen, oxygen, hydrogen and sulphur dioxide. Water treatment chemicals for cooling water and wastewater.

Table 3.18: Materials utilised in the Special Glass Sector

INPUTS / tonne water glass		OUTPUTS	
Raw materials		Product water glass	1000 kg
Sand (dry)	772.1 kg	Air emissions	
Sodium carbonate	399.6 kg	Fluoride (HF)	0.4 g
Ancillary materials		Carbon dioxide	540 kg
Water (steam production)	7.3 kg	Carbon monoxide	0.258 kg
Water treatment chemicals	0.1 kg	Chloride (HCl)	0.024 kg
Water consumption		Oxides of sulphur (as SO ₂)	1.322 kg
Process water	0.28 m ³	Dust	0.212 kg
Cooling water	0.94 m ³	Oxides of nitrogen (as NO ₂)	2.028 kg
Washing water (recycled water)	0.18 m ³ 68 kg	Waste water	0.28 m ³
Energy*		BOD	0.17 g
Total	6053 MJ	COD	0.003 g
Recovered	708 MJ	suspended solids	4.2 g
Consumption	5344 MJ	Solid waste	0.65 kg

**Table 3.19: Overview of inputs and out puts for an example water glass process [tm28 EMPA]
(*This process was fitted with a heat recovery boiler)**

INPUTS / tonne glass melted		Outputs / tonne glass melted	
Raw materials		Product TV funnels	1000 kg
Sand	327 kg	Air emissions	
Sodium carbonate	53 kg	Dust	6.1 g
Limestone	35 kg	Oxides of nitrogen (as NO ₂)	12000 g
Dolomite	18 kg	Oxides of sulphur (as SO ₂)	71.4 g
Feldspar	35 kg	Lead	1.4 g
Lead oxide	140 kg	Other metals	0.14 g
Potash	70 kg	Chloride (HCl)	9.24 g
Sodium nitrate, Ba,Sb,Zr compounds	47 kg	Fluoride (HF)	1.37 g
Process cullet	20 %	Others	
Other waste (filter dust etc)	20 %	Waste water	
Ancillary materials		BOD	20.9 g
Cooling water (see process water)	-	COD	107.4 g
Process water	3.6 m ³	AOX	0.2 g
Water treatment chemicals	0.43 kg	Solid waste	
Lubricants polishing, grinding	0.33 kg	Total	15.5 g
Energy		Of that heavy metals	2.7 g
Electricity	893 MJ		
Natural gas	268 m ³		
Technical gases	1.4 m ³		

Table 3.20: Overview of inputs and out puts for an example TV funnel glass process

INPUTS / tonne glass melted		Outputs / tonne glass melted	
Raw materials		Product TV panels	1000 kg
Sand	271 kg	Air emissions	
Sodium carbonate	50 kg	Dust	32.6 g
Barium carbonate	63.8 kg	Oxides of nitrogen (as NO ₂)	2700 g
Dolomite	11.7 kg	Oxides of sulphur (as SO ₂)	81.7 g
Feldspar	58.5 kg	Antimony	3.3 g
Strontium carbonate	65 kg	Other metals	-
Potash	46 kg	Chloride (HCl)	2.6 g
Sodium nitrate, Ti, Co, Sb, Zr, Ni, Zn, Ce compounds	50 kg	Fluoride (HF)	1.3 g
Process cullet	50 %	Others e.g. NH ₃ (SCR)	100 g
Other waste (filter dust etc)	%	Waste water	
Ancillary materials		BOD	10.6 g
Process water (inc. cooling top up)	1.82 m ³	COD	54.7 g
Water treatment chemicals	0.33 kg	AOX	0.11 g
Lubricants polishing, grinding	0.21 kg	Solid waste	
Grinding aid	2.64 kg	Total	7.9 g
Energy		Of that heavy metals	1.4 g
Electricity	892 MJ		
Natural gas	174 m ³		
Low sulphur oil	46.8 l		
Technical gases NH ₃ (SCR)	2.0 kg		
O ₂	1.5 m ³		

Table 3.21: Overview of inputs and out puts for an example TV panel glass process (SCR fitted for NOx reduction)

3.7.2 Emissions to Air

3.7.2.1 Raw Materials

In most modern special glass processes silos and mixing vessels are fitted with filter systems which reduce dust emissions to below 5 mg/m³. Mass emissions from both filtered and unfiltered systems will clearly depend on the number of transfers and the amount of material handled. However, a characteristic of this sector is that some batch plants are relatively small and due to the specialised nature and lower volumes of some of the products, there is a higher level of manual (and semi-manual) handling and transfer. Emissions from these activities will depend on how well systems are controlled. Clearly where materials containing potentially more toxic compounds (e.g. lead oxide, arsenic, etc) are handled there is a potential for emission of these substances.

3.7.2.2 Melting

In the Special Glass Sector the greatest potential environmental emissions are emissions to air from the melting activities. The main substances emitted and the associated sources are identified in Section 3.2.2.1. The wide range and specialised nature of the products of the Special Glass Sector lead to the use of a wider range of raw materials than encountered in most other sectors. For example: CRT funnels have a lead oxide content of over 20 % (comparable to lead crystal); certain glass compositions may involve the use of specialised refining agents such as oxides of arsenic and antimony; and some optical glass can contain up to 35 % fluoride and 10 % arsenic oxide. Emissions of fluorides, lead, arsenic and other metals are directly related to the use of compounds containing these substances in the batch

Due to the diverse nature of the sector most of the melting techniques described in Chapter 2 can be found. However, the low volumes of production mean that most furnaces are quite small, and the most common techniques are recuperative furnaces, oxy-gas furnaces, electric melters and day tanks. In some cases regenerative furnaces are also used, for example in CRT-glass and water glass production. The melting temperatures of special glasses can be higher than for more conventional mass-produced compositions. CRTs, borosilicate glass and glass ceramics, in particular, necessitate melting temperatures of more than 1650 °C.

These high temperatures and complex formulations can lead to higher emissions per tonne than, for example, soda-lime products. The higher temperatures favour higher rates of volatilisation and NO_x formation, and the greater use of nitrate refining agents can result in higher NO_x, SO₂, and metal emissions. The lower scale of production coupled with higher temperatures also means that energy efficiency is generally lower.

Water glass melting is generally more conventional than in other special glass processes. The raw materials are basically sand and soda ash only and emissions are generally limited to NO_x, SO₂, CO₂ and dust. There is a degree of overlap between special glass and some other sectors of the Glass Industry, particularly domestic glass for some borosilicate and glass ceramic products. The emissions from these furnaces will also be comparable with those producing domestic glass.

Emission levels for a particular furnace can depend on many factors, but principally batch composition, furnace type, abatement techniques utilised, the operation of the furnace and the age of the furnace. Emission levels (kg/ tonne product) are given in the tables above for three example processes. Examples for emissions of both mass and concentrations are given in Annex 1.

3.7.2.3 Downstream Activities

Emissions from activities downstream of the furnace are very case specific and must be considered for each site. However, there are some general issues.

Water glass is dissolved at high temperature and pressure to produce a solution of sodium silicate. This does not present any major potential for emissions to air, but there is a degree of material handling and processing that may give rise to dust emissions.

TV glass production usually involves an element of grinding and polishing which could lead to emissions of dust (funnel glass contains over 20 % PbO). These operations are usually carried out under liquid or have air extraction and filtration. Thus emission levels are generally very low. Some special glass processes also use secondary NO_x abatement (SCR, SNCR) which can lead to emissions of ammonia.

Several types of products may require varying degrees of cutting, grinding and polishing, which all have the potential to emit dusts and each must be assessed separately.

3.7.3 Emissions to Water

In common with other sectors of the industry, the major water uses include cooling and cleaning, and aqueous emissions will contain the cooling water system purges, cleaning waters and surface water run off. In general, the cleaning waters do not present any particular issues that would not be common with any industrial facility i.e. inert solids and potentially oil. Cooling system purges will contain dissolved salts and water treatment chemicals. Surface water quality will depend on the degree of drainage segregation and site cleanliness.

However, the diversity of the sector means it is not possible to identify all of the potential emissions, and each case must be assessed specifically. The raw materials used for each product and the processing undertaken must be considered. Any potentially harmful raw materials used on site will have the potential to enter wastewater streams, particularly where materials are handled and products are cut or ground. For example, the grinding and polishing of TV glass produces an aqueous stream containing the grinding and polishing aids, and fine glass that may contain for example, lead. In general, solids will be removed and the liquid will be recycled as far as practicable, but there will be a certain level of discharge and a potential for spillage. Some quantitative information is provided in the tables above for three example processes.

3.7.4 Other Wastes

In general, most internally generated glass waste (cullet) is recycled back to the furnace and waste levels are generally quite low. General wastes from packaging and furnace repairs are common with other sectors. Waste from dust control systems and dry scrubbing are recycled to the furnace where practicable. In processes involving grinding and cutting the sludges separated from the water circuits must be disposed of if they cannot be recycled or reused. Some quantitative information is provided in the tables above for three example processes.

3.7.5 Energy

For such a diverse sector it is very difficult to give general information on energy consumption. The tables for the three example processes give an indication of the energy consumption for these examples, but there can be a wide variation depending on the melting technique, the batch formulation and how the plant is designed and operated. The Dutch report on BAT for the Glass Industry quotes a range of 12 - 15 GJ/tonne end product [tm29 Infomil].

The general comments in Section 3.2.3 are applicable to this sector and the discussion of energy efficient techniques in Chapter 4 provides further information. Considerations specific to special

glass are that the melting temperatures for special glasses are generally higher than those for mass produced glasses, and that special glass furnaces are in general smaller than in other sectors of the Glass Industry. Both of these factors result in higher CO₂ emissions and higher specific energy consumption.

3.8 Mineral Wool

The information presented in this section relates to the whole range of plant sizes and operations but does not include special modes such as start-up and shutdown. Some of the lowest emission values relate to the operation of only one plant, which achieves these figures for site specific reasons and the results are not necessarily indicative of BAT for the sector.

The major output mass flow is the product, which may be from 55 % to 85 % of material input, for stone wool processes, and 75 % to 95 % for glass wool processes. An important factor in this is the recycling of process residues which significantly increases the efficiency of raw material utilisation. The losses arise through solid residues, aqueous wastes and emissions to air.

3.8.1 Process Inputs

The chemical composition of mineral wool can vary widely, and is generally expressed in terms of the oxides of the elements it contains. It is difficult to identify a “typical” batch composition for any of the main types of mineral wool i.e. glass wool, stone wool or slag wool. The basic raw materials are selected and blended to give the final desired glass compositions following melting. The percentage of each raw material in the batch can vary significantly particularly where substantial amounts of recycled materials are used.

The characteristic composition ranges for glass wool, stone wool and slag wool are shown in Chapter 2, Table 3.24 and below shows the range of raw materials that may be used to achieve these compositions.

Glass Wool:	Silica sand, process cullet, external cullet, process wastes, nepheline syenite, sodium carbonate, potassium carbonate, limestone, dolomite, sodium sulphate, borax, colemanite.
Stone/Slag Wool:	Basalt, limestone, dolomite, blast furnace slag, silica sands, sodium sulphate, process waste, occasionally wastes from other processes e.g. foundry sand.
Binder Materials:	Phenol formaldehyde resin (in solution), phenol, formaldehyde and resin catalyst if resin produced on site), ammonia, urea, mineral oil, silicone, silane, water
Fuels:	Natural gas, electricity, coke (stone/slag wool only), back up fuels (light fuel oil, propane, butane).
Water:	Mains supply and local natural sources (wells, rivers, lakes, etc)
Ancillary Materials:	Packaging materials including: plastics, paper, cardboard, and wood. Machine lubricants, predominantly mineral oils. Process gases, nitrogen and oxygen. Water treatment chemicals for cooling water and wastewater.

Table 3.22: Materials utilised in the Mineral Wool Sector

In glass wool the main oxides are silicon dioxide, oxides of alkali metals (predominantly sodium and potassium) and oxides of alkali earth metals (predominantly calcium and magnesium). The most significant sources of silicon dioxide are sand and waste glass materials

i.e. cullet and fibrous wastes. The most significant sources of alkali and alkali earth metal oxides are soda ash, potash, limestone, dolomite and to a lesser extent recycled glass.

In stone/slag wool the main oxides are silicon dioxide and oxides of alkali earth metals (predominantly calcium and magnesium). The silicon dioxide is derived principally from basalt, briquetted recycled material and blast furnace slag. The alkali earth metal oxides are derived from limestone, dolomite and briquetted recycled material. Some stone wool and slag wool have significant levels of aluminium oxide which is derived from blast furnace slag, basalt and recycled materials. Some low alumina formulations are produced from batches with significant levels of foundry sand and glass cullet rather than only basalt and slag.

The proportion of mineral wool to binder will vary depending on the product application. Typically mineral wool products contain 95 to 98 % by mass of fibre. Some very rare products will have a maximum of 20 % binder with 1 % mineral oil and 0.5 % of miscellaneous ingredients (e.g. silicone). Stone/slag wool products usually contain lower proportions of binder compared to glass wool products for similar applications. This is because densities of products fulfilling similar application requirements differ between glass wool and stone/slag wool. Stone wool may be up to twice the density of glass wool to achieve the same thermal insulation performance, particularly for low-density products.

In common with all processes in the Glass Industry a significant mass of the raw materials will be released as gases on melting. This will depend mainly on the amount of recycled material used, but for a typical mineral wool process the ignition losses will be generally around 10 %. Higher levels may be observed if high levels of carbonaceous materials are used in the batch.

Binder raw materials are generally manufactured liquid chemicals, although powdered solid chemicals are sometimes used. Binder formulations are generally considered as confidential and are not disclosed. The phenolic resin can be either manufactured on-site or bought from an external supplier. This will have little impact on the emissions from the mineral wool process itself, but clearly there are consumption and emission issues associated with resin manufacture. These issues are not covered within the scope of this document and reference should be made to appropriate guidance material for the Chemical Industry.

Water can be used in the production process for cooling, cleaning, and for binder dilution and dispersion, though the extent and methods of use depend upon the manufacturing technique. The basic processes are net users of water with the potential for release of water vapour and droplets from the forming and curing areas. Also the cullet quench system for glass wool processes will result in water evaporation. Most installations operate a closed loop process water system with a high level of recycling. Water is brought into the process water system from the mains supply or natural sources. Some water is also brought in with raw materials, particularly binder raw materials. The overall water consumption for mineral wool manufacture is: 3 to 10 m³/tonne of product for glass wool; and 0.8 to 10 m³/tonne of product for stone wool.

3.8.2 Emissions to Air

[tm26 EURIMA]

In the Mineral Wool Sector the emissions to air can be divided into three parts; raw materials handling, emissions from melting activities and emissions from downstream processes or line operations (i.e. fiberising and forming, product curing, product cooling, and product finishing). An emission from the downstream processes that is difficult to quantify is odour. Odours arise mainly from the curing operation and are thought to be caused by binder breakdown products. This section provides information on process emissions in concentration and mass per unit output, and the table below gives the waste stream volumes.

Process Activity		(x1000)	Process Exhaust Volume
Raw materials handling		Nm ³ /h	1 to 5
Furnace	Electric	Nm ³ /h	5 to 20
	Flame – glass	Nm ³ /h	5 to 40
	Combination	Nm ³ /h	5 to 40
	Cupola	Nm ³ /h	5 to 30
	Immersed electric arc	Nm ³ /h	3 to 10
	Flame – stone	Nm ³ /h	10 to 50
Line	Fiberising and forming	Nm ³ /h	100 to 400
	Product curing	Nm ³ /h	5 to 40
	Product cooling	Nm ³ /h	10 to 40
	Product finishing	Nm ³ /h	5 to 70

Table 3.23: Mineral wool process exhaust gas volumes

3.8.2.1 Raw Materials

In most modern glass wool processes silos and mixing vessels are fitted with filter systems which reduce dust emissions to below 5 mg/m³. Mass emissions from both filtered and unfiltered systems will clearly depend on the number of transfers and the amount of material handled. It should be noted that glass wool raw material batches tend to be dry and pneumatically conveyed. Therefore, the potential for dust emissions from raw material handling may be higher than in some other sectors.

Stone wool processes generally use coarse raw materials with particle diameters >50mm. The materials are stored in silos or bays and are handled using manual systems and conveyors. There is potential for wind born dust during storage and handling particularly during dry weather. A range of techniques can be used to control dust emissions, e.g. enclosure of bays and conveyors, damping of stock piles etc. The level of releases is difficult to quantify and will depend largely on the amount of material handled and how well these techniques are applied.

3.8.2.2 Melting

[tm26 EURIMA]

Glass wool furnaces are predominantly air-gas fired (usually with electric boost), but with a substantial number of electrically heated furnaces and a smaller number of oxy-gas fired furnaces. Stone wool furnaces are nearly all coke-fired cupolas with a few examples of gas fired or electrically heated furnaces. The substances emitted and the associated sources are identified in Section 3.2.2.1. Where relevant to the pollution control techniques the mechanism of emissions formation is discussed in more detail in Chapter 4.

Stone wool cupola furnaces have several important differences from more conventional glass furnaces, which can affect the emissions from the process. One of the most significant is the fact that cupolas operate under strong reducing conditions. Therefore, emissions of NO_x are relatively low, part of the sulphur released from the fuel or raw materials is reduced to hydrogen sulphide, and the carbon monoxide level is high. Most processes have an after burner system installed which oxidises the hydrogen sulphide to sulphur dioxide and the carbon monoxide to carbon dioxide. The coke and raw materials may contain higher levels of metals, chlorides and fluorides than in some other glass processes, giving rise to higher emissions of these substances.

An increasingly important factor affecting melter emissions is the contribution from recycled materials. If fibre containing binder is recycled to the furnace the organic component must be considered. In cupolas this is not a problem, but in glass furnaces it may be necessary to add oxidising agents such as potassium nitrate, which may have the effect of increasing NO_x emissions.

In stone wool processes cement is often used for briquetting of process residues, and when the briquettes are melted there are consequent emissions of SO₂.

Table 3.24 below shows the full range of emissions from mineral wool plants in the EU, with figures for kg/tonne of melt in brackets. Table 3.25 below shows the estimated middle 80 % of the range, with figures for kg/tonne of melt in brackets.

Substance mg/m ³ . (kg/tonne of melt)	Electric Melting Glass Wool	Flame Fired Furnaces Glass Wool	Combined Fossil fuel / electrical melting	Cupola Furnaces Stone Wool	Immersed Electric Arc Furnace Stone Wool	Flame Fired Furnaces Stone Wool
Particulate matter	2 - 250 (0.004 - 1.0)	10 - 1000 (0.02 - 4.0)	10 - 1000 (0.02 - 4.0)	10 - 3000 (0.03 - 9.0)	10 - 30 (0.01 - 0.03)	10 - 50 (0.02 - 0.1)
Oxides of Sulphur (as SO ₂)		20 - 1000 (0.05 - 4.0)	20 - 1000 (0.05 - 4.0)	150 - 3500 (0.4 - 10.0)	1000 - 3000 (1.0 - 3.0)	30 - 300 (0.06 - 0.6)
Oxides of Nitrogen (as NO ₂)	15 - 500 (0.002 - 0.03)	100 - 1500 (0.5 - 6.0) ⁽¹⁾	100 - 1500 (0.5 - 6.0)	50 - 400 (0.14 - 1.1)	50 - 200 (0.05 - 0.2)	800 - 1500 (1.6 - 3.0)
Fluorides (HF)	0.5 - 5 (0.003 - 0.03)	0.5 - 5 (0.002 - 0.02)	0.5 - 5 (0.002 - 0.02)	1 - 30 (0.003 - 0.09)	1 - 5 (0.001 - 0.005)	0.5 - 5 (0.002 - 0.02)
Chlorides (HCl)	0.2 - 5 (0.001 - 0.03)	1 - 30 (0.004 - 0.08)	1 - 30 (0.004 - 0.08)	10 - 150 (0.03 - 0.4)	10 - 50 (0.01 - 0.05)	1 - 30 (0.002 - 0.02)
Hydrogen Sulphide (H ₂ S)				1 - 500 (0.003 - 1.4)	0 - 5 (0 - 0.005)	
Carbon Monoxide				10 - 100000 (0.03 - 300)	30 - 100 (0.03 - 0.1)	
Carbon Dioxide	30000 - 150000 (100 - 300)	150000 - 190000 (400 - 500)	150000 - 190000 (400 - 500)	130000 - 260000 (400 - 800)	20000 - 200000 (20 - 200)	150000 - 200000 (400 - 500)
Metals ⁽²⁾				0.1 - 30 (0.0003 - 0.09)		

Table 3.24: Full range of emissions from mineral wool melting activities

(1) The lower levels of NO_x are from an oxy-gas fired furnace.

(2) Metals are emitted mainly as particulate matter.

Substance mg/m ³ . (kg/tonne of melt)	Electric Melting Glass Wool	Flame Fired Furnaces Glass Wool	Combined Fossil fuel / electrical melting	Cupola Furnaces Stone Wool	Immersed Electric Arc Furnace Stone Wool	Flame Fired Furnaces Stone Wool
Particulate matter	25 - 220 (0.08 - 0.9)	30 - 200 (0.06 - 0.8)	30 - 200 (0.06 - 0.8)	20 - 100 (0.06 - 0.3)	10 - 30 (0.01 - 0.03)	10 - 50 (0.02 - 0.1)
Oxides of Sulphur (as SO ₂)		20 - 100 (0.05 - 0.4)	20 - 100 (0.05 - 0.4)	400 - 2500 (1.1 - 7.1)	1000 - 3000 (1.0 - 3.0)	30 - 250 (0.06 - 0.5)
Oxides of Nitrogen (as NO ₂)	200 - 400 (0.02 - 0.025)	500 - 1200 (2.5 - 4.8)	500 - 1200 (2.5 - 4.8)	80 - 250 (0.25 - 0.7)	50 - 200 (0.05 - 0.2)	1150 - 1250 (2.3 - 2.5)
Fluorides (HF)	0.5 - 1.0 (0.003 - 0.006)	1.0 - 5.0 (0.004 - 0.02)	1.0 - 5.0 (0.004 - 0.02)	1.0 - 15.0 (0.003 - 0.03)	1.0 - 5.0 (0.001 - 0.005)	1.0 - 5.0 (0.004 - 0.02)
Chlorides (HCl)	0.5 - 1.0 (0.003 - 0.006)	1.0 - 15.0 (0.004 - 0.04)	1.0 - 15.0 (0.004 - 0.04)	10 - 50 (0.03 - 0.2)	10 - 50 (0.01 - 0.05)	1.0 - 25 (0.002 - 0.015)
Hydrogen Sulphide (H ₂ S)				1.0 - 200 (0.003 - 0.6)	0 - 5.0 (0 - 0.005)	
Carbon Monoxide				30 - 80000 (0.1 - 250)	30 - 100 (0.03 - 0.1)	
Carbon Dioxide	30000 - 150000 (100 - 300)	150000 - 190000 (400 - 500)	(400 - 500)	130000 - 260000 (400 - 800)	20000 - 200000 (20 - 200)	150000 - 200000 (400 - 500)
Metals				0.1 - 2.0 (0.0003 - 0.006)		

Table 3.25: Middle 80 % of emissions from mineral wool melting activities

3.8.2.3 Emissions from Non-Melting Activities

[tm26 EURIMA]

As discussed in Chapter 2 mineral wool products usually contain a proportion of phenolic resin based binder. The binder solution is applied to the fibres in the forming area and is cross-linked and dried in the curing oven. The forming area waste gas will contain particulate matter, phenol, formaldehyde and ammonia.

The particulate matter consists of both organic and inorganic material, often with a very small particle size. Lower levels of VOCs and amines may also be detected if they are included in the binder system. Due to the nature of the process the gas stream has a high volume and high moisture content. The releases from the oven will consist of volatile binder materials, binder breakdown products, water vapour and combustion products from the oven burners.

After exiting the oven the product is cooled by passing a large quantity of air through it. This gas is likely to contain mineral wool fibre and low levels of organic material. Product finishing involves cutting, handling and packaging, which can give rise to dust emissions.

An important factor that has a major impact on emissions from forming, curing and cooling is the level of binder applied to the product, as higher binder content products will generally result in higher emission levels. Binder derived emissions depend essentially on the mass of binder solids applied over a given time, and therefore high binder content, and to a lesser extent high density products may give rise to higher emissions.

Table 3.26 below shows the full range of emissions from downstream operations of mineral wool plants in the EU, with figures for kg/tonne of product in brackets. Table 3.27 below shows the estimated middle 80 % of the range.

Substance mg/Nm ³ (kg/tonne of product)	Combined fiberising, forming and curing	Fiberising and forming	Product curing	Product cooling	Product finishing
Particulate matter	10 - 200 (0.3 - 6.0)	10 - 200 (0.3 - 6.0)	5.0 - 55 (0.01 - 0.18)	10 - 50 (0.04 - 0.3)	1.0 - 50 (0.005 - 0.4)
Phenol	2.0 - 50 (0.05 - 1.6)	2.0 - 50 (0.05 - 1.5)	2.0 - 40 (0.004 - 0.11)	1.0 - 10 (0.004 - 0.06)	
Formaldehyde	2.0 - 30 (0.05 - 1.2)	2.0 - 30 (0.05 - 1.0)	2.0 - 60 (0.004 - 0.17)	1.0 - 10 (0.004 - 0.06)	
Ammonia	20 - 250 (0.6 - 8.8)	20 - 250 (0.5 - 7.6)	30 - 460 (0.06 - 1.9)	1.0 - 50 (0.004 - 0.3)	
Oxides of Nitrogen (NO _x)			50 - 200 (0.1 - 0.6)		
Volatile Organic Compounds (VOC)	5.0 - 150 (0.1 - 5.0)	5.0 - 150 (0.1 - 4.6)	5.0 - 150 (0.01 - 0.43)	1.0 - 30 (0.004 - 0.2)	
Carbon Dioxide	(40 - 230)		20000 - 80000 (40 - 230)		
Amines	1.0 - 40 (0.1 - 1.3)	5.0 - 40 (0.1 - 1.2)	5.0 - 20 (0.01 - 0.06)	1.0 - 5.0 (0.004 - 0.03)	

Table 3.26: Full range of mineral wool line emissions in mg/m³

Substance mg/Nm ³ (kg/tonne of product)	Combined fiberising, forming and curing	Fiberising and forming	Product curing	Product cooling	Product finishing
Particulate matter	10 - 50 (0.9 - 1.9)	10 - 50 (0.6 - 3.5)	5.0 - 25 (0.01 - 0.07)	10 - 30 (0.04 - 0.2)	5.0 - 20 (0.03 - 0.16)
Phenol	5.0 - 25 (0.2 - 1.3)	5.0 - 25 (0.1 - 0.8)	5.0 - 15 (0.01 - 0.04)	1.0 - 5.0 (0.004 - 0.03)	
Formaldehyde	5.0 - 20 (0.15 - 0.43)	5.0 - 20 (0.1 - 0.6)	5.0 - 30 (0.01 - 0.09)	1.0 - 5.0 (0.004 - 0.03)	
Ammonia	40 - 150 (1.8 - 5.4)	40 - 150 (1.0 - 4.5)	50 - 200 (0.1 - 0.6)	2.0 - 20 (0.007 - 0.12)	
Oxides of Nitrogen (NO _x)			50 - 150 (0.1 - 0.4)		
Volatile Organic Compounds (VOC)	10 - 80 (0.2 - 2.7)	10 - 80 (0.3 - 2.4)	10 - 80 (0.02 - 0.23)	1.0 - 10 (0.004 - 0.06)	
Carbon Dioxide	(40 - 230)		20000 - 60000 (40 - 170)		
Amines	5.0 - 20 (0.1 - 1.0)	5.0 - 20 (0.1 - 0.6)	5.0 - 10 (0.01 - 0.03)	1.0 - 5.0 (0.004 - 0.03)	

Table 3.27: Middle 80 % range of mineral wool line emissions

3.8.3 Emissions to Water

Under normal operations the processes are net consumers of water and aqueous emissions are very low. Most processes operate a closed loop process water system, and where practicable cooling water blow down and cleaning waters are fed into that system. If they are incompatible or if the volumes are too great they may have to be discharged separately, but many plants have a holding tank to accommodate volume overloads, which can then be bled back into the system. At some plants clean warmed cooling water is discharged to sewer or a natural water course. Small amounts of contaminated wastewater may arise from chemical bunds, spillages and oil interceptors etc, and these are usually discharged to the process water system, transported for off-site treatment, or discharged to sewer.

The large volume of the process water system causes a potential for contamination of clean water circuits such as surface water and cullet quench water. If systems are poorly designed or not properly controlled more serious emissions may arise. If wet scrubbing techniques are used, particularly chemical scrubbing, the effluent may not be compatible with the process water system, giving rise to a further waste stream.

3.8.4 Other Wastes

[tm26 EURIMA]

The main sources of solid waste are:

- Spillages from batch raw materials handling.
- Process cullet produced by quenching hot melt in water during fiberising machine by-pass in glass wool production.
- Unfiberised melt from stone wool processes during fiberising machine by-pass.
- Dust collected from abatement systems, mainly electrostatic precipitators and bag filters.
- Shot from stone wool fiberising. This is heavy non-fibrous and semi-fiberised material that is too heavy to reach the collection belt, and is collected below the fiberising machine. Around 10 to 20 % of the melt hitting the fiberising machine forms shot.
- Product edge trims.
- Waste wool created during product changeovers, line stoppages or out of specification products.
- Waste from stone wool filters, which has a high organic content, often around 50 %.
- Iron and melt from stone wool cupola tap outs.
- Mixed melt and stone from cupola shut downs.

- k) Solid waste from process water circuit filtration. This represents 0.5 to 2.0 % of process throughput and consists of fibre, binder solids and up to 50 % moisture.
- l) Packaging waste and other general waste.
- m) Refractory waste from furnace rebuilding.

In glass wool production it is common to recycle directly to the furnace, batch spillages, glass wool cullet and dust collected from abatement systems. In stone wool processes shot, by-pass melt, and abatement system dust is generally recycled if a briquetting process is in use. Fibrous waste can be recycled by grinding and inclusion in briquettes, but again this only occurs if a briquetted recycling system is in operation. However, edge trims are usually shredded and recycled to the forming area, and in some cases the dry waste product can be shredded to produce a blowing wool product.

Cupola shut down and tap out waste can theoretically be recycled through a briquetting system, but this is not common, because it is inert and can be used as filling material (e.g. road fill). It is also possible to separate the metallic iron from the waste and sell it as scrap iron, but there is little financial incentive to do this.

An estimate of the percentage of waste recycled in the mineral wool sector is not currently available. However, Table 3.28 below gives an indication of current practice at the time of writing.

	Glass Wool	Stone and Slag Wool
Total waste generated as a percentage of product output.	5 to 25 %	20 to 60 %
Percentage of total waste recycled.	10 to 100 %	0 to 100 %
Percentage of total waste disposed of off-site.	0 to 90 %	0 to 100 %

Table 3.28: Mineral Wool Sector solid waste generation and disposal

3.8.5 Energy

[tm26 EURIMA, tm14 ETSU]

The predominant energy sources for glass wool melting are natural gas and electricity. Stone wool is predominantly produced in cupolas which are fuelled by coke, and there are some examples of gas fired and electrically heated furnaces. Natural gas is also used in substantial quantities for fiberising and curing. Electricity is used for general services and light fuel oil, propane and butane are sometimes used as back up fuels. There are a number of oxy-gas fired furnaces in the sector.

The three main areas of energy consumption are melting, fiberising and curing. The split can vary greatly between processes and is very commercially sensitive. Table 3.29 shows the total energy consumption in mineral wool production, with a breakdown into the main process areas. The figures for fiberising, curing and other consumption are estimates made by the EIPPCB, based on discussions with industry and figures from [tm14 ETSU].

	Glass Wool	Stone and Slag Wool
Total energy consumption, GJ/tonne of finished product.	11 to 22	7 to 18
Melting, % of total energy.	20 to 45 %	30 to 70 %
Fiberising, % of total energy.	25 to 35 %	25 to 35 %
Curing and drying, % of total energy.	25 to 35 %	25 to 35 %
Others, % of total energy.	6 to 10 %	6 to 10 %

Table 3.29: Energy use in mineral wool production

Direct energy consumption for electrical melting is in the range 3.0 to 5.5 GJ/tonne of finished product. Energy consumption for electrical melting is approximately one third of that required for 100 % air-gas melting, and the relative energy consumption of each process stage can be estimated accordingly. With these figures the inherent error in such an estimate is very high, but they give an indication of the energy consumption.

3.9 Ceramic Fibre

[tm8 S23.03, tm40 ECFIA]

The main output is the product. The yield from raw materials to melt is generally greater than 90 % and the yield from melt to finished product (blanket/bulk) ranges from 55 % to 85 %. However, it is important to note that the yield from melt to finished product is an estimate and may vary according to the type, nature, volume and duration of the production. In particular, the lowest level corresponds to specific and technically more difficult productions.

3.9.1 Process inputs

There are two main product formulations high purity alumina-silicate and zirconia alumina-silicate, the compositions of which are given in Chapter 2. The main raw materials are given in the table below, they are a combination of natural (usually processed) and man-made substances.

Raw materials for melting	Oxides of aluminium, calcium, magnesium, silicon and zirconium. Also smaller levels of oxides of potassium, sodium, titanium, iron and chromium.
Secondary processing	For vacuum forming a wet colloidal mixture of starch, latex, silica or clay is used. Other activities may use similar substances and sometimes fillers and organic polymers or resins.
Fuels	Electricity, natural gas, sometimes light fuel oils (back up, heating)
Water	Mains supply and local natural sources (wells, rivers, lakes etc)
Ancillary Materials	Packaging materials including plastics, paper, cardboard, and wood. Mineral oils (fibre coating and other general uses). Water treatment chemicals for cooling water and wastewater.

Table 3.30: Materials utilised in the Ceramic Fibre Sector

The raw materials for the melt are blended to give the required compositions on melting. In general over 90 % of the composition is derived from the oxides of silicon, aluminium and zirconium. Silicon dioxide is derived mainly from high-grade silica sand, and aluminium oxide (alumina) can occur naturally but is usually derived by processing bauxite. Zirconium dioxide occurs naturally as baddeleyite or can be manufactured.

Waste materials are recycled if possible either directly to the furnace as powders and sometimes into the products as fibre. Secondary processing can be very specific the substances identified in the table for vacuum forming are common but others may vary widely.

The main uses of water in the Ceramic Fibre Sector are for cooling circuits and cleaning. Cooling water is used, usually in closed circuits, to cool various equipment, with corresponding losses from evaporation and purges. Water is also used in vacuum forming operations and for boards and papers. Actual water consumption and water vapour emissions may vary according to local conditions (e.g. ambient temperature and the hardness of water input).

The energy source for melting is exclusively electricity but natural gas is often used for downstream activities particularly drying.

3.9.2 Emissions to Air

3.9.2.1 Raw materials

In most modern ceramic fibre processes silos and mixing vessels are fitted with filter systems which reduce dust emissions to below 5 mg/m³. Mass emissions from both filtered and unfiltered systems will depend on the number of transfers, and the amount of material handled.

3.9.2.2 Melting

Emissions from melting are generally very low consisting mainly of dust from raw materials. The raw materials are usually very pure and consist almost exclusively of oxides; therefore there is little degassing and no significant emissions of gaseous compounds. Most furnaces are served by an extraction system that vents via a bag filter. Dust emissions are generally below 20 mg/m³.

3.9.2.3 Downstream Activities

Dust and fibre releases can be generated from a number of areas within the process, these include: fibrisation and collection, needling, lubricant burn off, slitting, trimming, cutting, packaging, and areas of secondary processing. All areas where particulate or fibre releases may be generated, are usually served by an efficient extraction system which vents to a fabric filter system. Dust emissions are generally below 20 mg/m³ and fibre emissions are in the range 1 - 5 mg/m³. Low levels of organic emissions may also occur from some secondary processing activities, usually less than 50 mg/m³.

3.9.3 Emissions to Water

As discussed earlier the main uses of water in this sector are cleaning, cooling, and for vacuum forming and other secondary processing. The aqueous emissions are limited to the cooling water system purges, cleaning waters and surface water run off. The cleaning waters do not present any particular issues that would not be common with any industrial facility i.e. inert solids and oil. Cooling system purges will contain dissolved salts and water treatment chemicals. Surface water quality will depend on the degree of drainage segregation and site cleanliness. Water used for vacuum forming is recycled with a purge, which may contain low levels of organic substances. Simple abatement techniques such as settlement, screening, oil separators, and neutralising can be found within the sector.

3.9.4 Other Wastes

[tm40 ECFIA]

Waste levels are generally low. Wherever possible waste materials (batch, cullet, edge trims etc) are recycled either directly to the furnace (requires processing for fibres) or into the products. Waste is also produced in the form of the material collected in the dust abatement equipment. In general, this material is not recycled directly to the furnace. Potential contamination and uncertainty over composition make this difficult but some initiatives are underway to address the issue. Due to the nature of the material it can be expensive to dispose of and this helps to provide an incentive to find alternatives.

Most mineral raw materials are delivered in bulk and do not give rise to packaging waste. Waste materials from product packaging operations (plastic, cardboard, wood etc) are usually reused or recycled if practicable. Other waste non-specific to the industry is disposed of by conventional means, or recycled where local or national schemes permit. At the end of a furnace campaign, the refractory structure is dismantled and replaced. Where practicable this material is recovered for reuse or sale.

The EU Ceramic Fibre Sector as a whole produces around 700 - 900 tonnes per year of fibre containing waste, and 100 - 700 tonnes of other waste.

3.9.5 Energy

[tm40 ECFIA]

There is little information available on energy use within this sector. Melting is exclusively electrically heated with very low volatile losses. Therefore, the direct melting efficiency (excluding off-site issues) is quite high, although the composition has a high melting energy requirement and the furnaces are relatively small. The energy consumption ranges from 6.5 - 16.5 GJ/tonne of melt. The energy consumption for the other activities ranges from 3.5 - 9.5 GJ/tonne product (based on 75 % conversion raw materials to finished product).

3.10 Frits

The main output is the product, and the melt yield from raw materials is 75 - 80 % depending on the precise formulation. Most of this loss is made up of CO₂ emitted during melting. The processes do not produce cullet as such; and the only material generally recycled is dust from abatement equipment, which does not significantly affect the yield. The basic product yield from melt is very high because the material is simply quenched, the only losses are solids that cannot be separated from the water.

3.10.1 Process inputs

[tm46 ANFFECC]

The main raw materials used for the most common formulations are given in the table below, along with an indicative batch composition. The precise figures will vary but those in the table are broadly indicative.

Frit Type	Raw Materials	Approximate % in batch
Ceramic/Glass Frits	Zirconium compounds	7.7
	Feldspar	26.8
	Quartz	25.9
	Boric acid	6.8
	Zinc oxide	8.4
	Dolomite	8.4
	Calcium carbonate	13.4
	Potassium nitrate	2.6
Enamel Frits	Borax	19.1
	Quartz	42
	Sodium nitrate	7.8
	Sodium fluorsilicate	1.2
	Potassium fluorsilicate	7.8
	Sodium phosphate	3.2
	Titanium oxide	18.9
Low melting point frits	Red lead Pb ₃ O ₄	50
	Quartz	19.8
	Zinc oxide	15.1
	Boric acid	15.1

Table 3.31: Main raw materials utilised in frit production

Water is used for cooling and cleaning purposes, but also for cooling and shattering the molten glass (quenching) and for wet milling. All of the water circuits are usually closed circuits with corresponding losses from evaporation and purges. Other water losses are the water content of the product and the water content of the solids collected from the quench water circuit. Water consumption is estimated at 0.5 - 1.5 m³/tonne of frit.

The main fuel used is natural gas, oil is also used in some installations but much less commonly (<10 %). Many installations are oxy-gas fired and so consume a relatively large amount of oxygen.

3.10.2 Emissions to Air

3.10.2.1 Raw materials

In most modern container glass processes silos and mixing vessels are fitted with filter systems which reduce dust emissions to below 5 mg/m³. Mass emissions from both filtered and unfiltered systems will depend on the number of transfers, granule size, and the amount of material handled. Although quite rare and only in low levels some frit processes involve the use of raw materials containing lead or other heavy metals. Where materials containing potentially toxic compounds are handled there is the potential for emission of these substances. Almost invariably effective measures will already be in place to minimise emissions of these substances.

3.10.2.2 Melting

In the Frits Sector the greatest potential environmental emissions are emissions to air from the melting activities. The substances emitted and the associated sources are identified in Section 3.2.2.1. All of the furnaces in this sector are fossil fuel fired (mainly natural gas and some fuel oil). The table below shows the range of emissions from this sector, no statistical breakdown is available.

Substance	Concentration mg/m ³ .	Mass emission kg/tonne melt
Dust	5 - 850	0.1 - 9.0
Oxides of nitrogen (as NO ₂)	290 - 2000	0.4 - 16.0
Oxides of sulphur (as SO ₂)	<50 - 4000	0.4 - 32.0
Chlorides (HCl)	0.1 - 20	<0.01 - 0.16
Fluorides (HF)	0.1 - 100	<0.01 - 0.8
Metals	<1 - 25	<0.01 - 0.2

Table 3.32: Emission levels from frit furnaces

Dust emissions depend on whether abatement is fitted, and most plants will have bag filters. Oxides of nitrogen emissions depend mainly on the combustion system, many furnaces are oxy-gas fired and these represent the lowest mass emission figures given above. Most furnaces are gas fired and emissions of oxides of sulphur are less than 200 mg/m³ depending on the sulphate level of the batch.

3.10.2.3 Downstream Activities

Emissions to air from downstream processes are very low. The vast majority of milling is carried out wet, but dry milling could give rise to dust emissions if not abated.

3.10.3 Emissions to Water

Emissions to water consist of normal cooling, cleaning and surface run off emissions. The quenching and milling circuits are usually closed with fresh water top-up but sometimes have a purge to prevent salts build up. Emission levels are very low but may contain suspended solids and in some circumstances heavy metals may be present in the suspended solids. The metals are usually bound in the glass and can be removed by solids separation techniques.

3.10.4 Other Wastes

Waste levels are generally very low. The main processing waste is the solid material (mainly frit) separated from the water circuits. This material is not usually recycled because the composition is too variable. In most plants the waste to good production ratio will be in the region of 0.5 - 3 %.

Most mineral raw materials are delivered in bulk and do not give rise to packaging waste. Waste materials from product packaging operations (plastic, cardboard, wood etc) are usually reused or recycled if practicable. Other waste non-specific to the industry is disposed of by conventional means, or recycled where local or national schemes permit. At the end of a furnace campaign, the refractory structure is dismantled and replaced. Where practicable this material is recovered for reuse or sale.

3.10.5 Energy

There is very little information available on energy use within this sector. Furnaces are predominantly (>90 %) gas fired although there are some oil fired furnaces and some dual fuel fired furnaces. There are no known examples of electrical melting on a commercial scale. Furnaces tend to be very small relative to most furnaces in the Glass Industry and there are few individual furnaces greater than 20 tonnes per day and many furnaces are smaller batch furnaces. There are usually several small furnaces at a particular installation, each producing different formulations. However, refining requirements are generally less and overall energy

consumption per tonne of melt is comparable to other sectors, approximately 13 GJ/tonne. Non-melting energy use is very low due to the low level of downstream processing, and products are not usually dried.

Many furnaces in Northern Europe are oxy-gas fired and this can result in substantial energy savings. Decreases in gas usage in excess of 50 % have been reported in several cases.

4 TECHNIQUES TO CONSIDER IN THE DETERMINATION OF BAT

4.1 Introduction

This chapter presents those emission reduction techniques, which are considered most appropriate in the determination of what constitute the best available techniques both generally and for any particular installation. The Glass Industry includes a wide range of products, processes and manufacturing techniques, and so a wide range of abatement techniques can be used. However, the suitability and effectiveness of the techniques can vary significantly between applications.

This chapter has seven main sections, which cover:

- Melting technique selection.
- Materials handling.
- Techniques for controlling emissions to air from melting activities.
- Techniques for controlling emissions to air from non-melting activities.
- Techniques for controlling emissions to water.
- Techniques for minimising other wastes.
- Energy.

The main environmental impact of the Glass Industry as a whole arises due to emissions to air from melting activities. Techniques to reduce these emissions are described in Section 4.4, which is the largest and most detailed section of this chapter. Most of the techniques described are relevant to the majority of installations in the Glass Industry and share a common basis. For this reason Section 4.4 is structured with a substance-based approach and for each substance the various emission reduction techniques are described. The techniques have been described in the section relating to the substance on which they have greatest effect, but there are inevitably multi-substance effects for many of the techniques. Where appropriate the effects on other substances have been described and cross-referenced to other sections.

In various parts of the document the terms primary and secondary abatement measures are used. These terms are rather imprecise but help to categorise some of the techniques. In general, primary techniques are those which reduce or avoid the formation of the pollutants; and secondary techniques are those which act on the pollutants to render them less harmful (e.g. by converting to other species) or collect them in a form that can be reused, recycled or disposed of. Some of the techniques described do not fall conveniently into either category, and where appropriate this is made clear in the text.

Where practicable, the information for the techniques is provided in a consistent way, grouped under five general headings. However, for some of the techniques (particularly some of the primary techniques) this approach is not the most logical or effective way of presenting the information and where appropriate the sections have been structured differently. The five general headings are:

- Description of technique – discussing the principles of the technique and how it can be used in the Glass Industry.
- Environmental performance – describing emission levels achieved.
- Financial considerations – containing information on costs (capital, operating and infrastructure) where available.
- Applicability – covering the issues relating to different applications.

- Associated considerations – including inter-media and intra-media consequences and the effects on things other than emission levels and costs (e.g. energy usage, process flexibility, product quality, furnace lifetime, off-site emissions, and build up of impurities within the process cycle).

An important consideration for this chapter is that a technique, which is successful in one application may have very different implications if used in a different sector or even at a different installation in the same sector. The costs, environmental performance and associated advantages and disadvantages can differ widely for different sectors and for individual installations. For each technique its availability and likely applicability in a range of situations is discussed.

In assessing the applicability of any technique described in this chapter, to a continuous melting process, it is necessary to consider whether it can be applied to the furnace during the campaign, or if it can only be applied (or is best applied) at a rebuild. An important feature of the Glass Industry is the fact that furnaces have a limited operational life, after which time they must be repaired or rebuilt, to varying degrees. In general, fossil fuel fired furnaces producing container glass, flat glass, glass wool, continuous filament glass fibre, and water glass operate continuously for 8 to 12 years. Special glass and domestic glass fossil fuel fired furnaces usually operate continuously for 3 to 8 years. Electrically heated furnaces tend to have shorter operating lives in all applications i.e. 2 to 7 years. Some other furnaces such as cupola furnaces and batch melters are operated for much shorter periods, from a few days to several weeks.

There are two main categories of rebuild for continuous processes:

- In a “normal” rebuild the refractory of the furnace and where appropriate, the regenerators, are repaired by the full or partial replacement of the material. The furnace frame is not significantly adjusted and the furnace dimensions remain basically unchanged. Where there is no significant change in furnace requirements or technology this is the most common type of rebuild between campaigns.
- A “complete” rebuild usually involves a major adjustment or replacement of the furnace frame in addition to the replacement of the refractory material. This can be comparable to the construction of a new furnace although in many cases much of the existing infrastructure and particularly the regenerators may be retained. This type of rebuild is less common and is usually undertaken where a major change in furnace requirements (e.g. significantly increased melting area or major changes in firing capacity) or technology is involved. A complete rebuild generally involves significantly higher costs than a normal rebuild.

During a furnace campaign the opportunity to modify the furnace is limited. Although, hot repairs to replace or shore-up damaged refractories are often undertaken, and burner modifications or replacement can also be relatively straightforward. Major changes affecting melting technology are usually most economically implemented if coincided with furnace rebuilds. This can also be true for complex secondary abatement measures. However, many improvements to the operation of the furnace, including the installation of secondary techniques, are possible during the operating campaign. Where appropriate these issues are discussed in the consideration of the applicability of the various techniques.

The distinction between a “normal” rebuild and a “complete” rebuild is not absolute and there are a number of increments between the simplest normal rebuild and the complete demolition and total replacement of a furnace. For example, a small repair can be carried out either hot or cold to repair specific damage or introduce a minor modification. Also minor rebuilds may occur where a scheduled cold repair is made but most of the refractory is retained and only damaged parts replaced. The most important difference, which affects both the cost and the freedom to implement new technology, is whether there is a significant change to the furnace frame and therefore its dimensions.

For smaller furnaces with more frequent rebuilds and lower capital costs, the advantages of co-ordinating environmental improvements and furnace repairs are less significant, but environmental improvements may be more economical if co-ordinated with other investments.

4.2 Melting Technique Selection

The melting techniques used within the Glass Industry are described in Chapter 2. They range in size from small pot furnaces to large regenerative furnaces producing over 600 tonnes of glass a day. The choice of melting technique depends on many factors but particularly the required capacity, the glass formulation, fuel prices, and existing infrastructure. The choice is one of the most important economic and technical decisions made for a new plant or for a furnace rebuild. The overriding factors are the required capacity and the glass type.

The choice between regenerative or recuperative furnace is an economical and technical decision that is not generally a significant consideration in the determination of BAT. Therefore the environmental aspects are only discussed briefly here. The choice between conventional air-fuel firing and electrical or oxy-fuel melting is an important factor in determining BAT and these techniques are described separately. Similarly other specific melting techniques e.g. the Sorg LoNOx melter are discussed separately in the substance specific sectors.

Each of the techniques described in Chapter 2 has its inherent advantages, disadvantages and limitations. For example, at the time of writing, the best technical and most economical way of producing high volume float glass is from a large cross-fired regenerative furnace. The alternatives are either still not fully proven in the sector (e.g. oxy-fuel melting) or compromise the economics or technical aspects of the business (e.g. electric melting or recuperative furnaces).

The environmental performance of the furnace is a result of a combination of the choice of melting technique, the method of operation, and the provision of secondary abatement measures. From an environmental perspective, melting techniques that are inherently less polluting or can be controlled by primary means are generally preferred to those that rely on secondary abatement. However, the economic and technical practicalities have to be considered and the final choice should be an optimised balance.

The environmental performance of the various melting techniques will differ greatly depending on the glass type being produced, the method of operation and the design. For example, the emissions (before secondary abatement) from a recuperative TV glass furnace with added nitrate and nearing the end of a campaign, will bear little resemblance to the emissions from a newly built recuperative continuous filament furnace which has optimised geometry, formulation and firing. These factors make a direct quantitative comparison of the various melting techniques difficult and of limited value, and the sections below only summarise the main environmental considerations for each of the techniques described in Chapter 2. Oxy-fuel melting and special melter designs are covered in Sections 4.4.2.5 and 4.4.2.3 respectively. The differences in emissions from the different furnace types are discussed where appropriate in the substance specific sections of this Chapter.

Electric melting differs from the other techniques described below, because it is a fundamental change in technology and has very significant effects on emissions. Electric melting is presented as one of the specific techniques for consideration in determining BAT. However, due to its impact on all emissions it does not fit conveniently into the substance-based approach of this Chapter, therefore, it is presented in this section.

Regenerative Furnaces

These furnaces are generally more energy efficient than other conventional fossil fuel fired furnaces due to the more efficient combustion air preheating system. The low energy use per tonne of glass melted leads to reductions in many of the pollutants associated with combustion. However, the high preheat temperatures favour higher NO_x formation. These furnaces have shown very good results with primary emission control techniques, particularly for NO_x. Of the two types of regenerative furnace the end-fired furnaces tend to show better energy efficiency and lower emissions. However, in some cases, the primary NO_x control measures can result in greater reductions with cross-fired furnaces.

The high capital cost of regenerative furnaces means they are normally only economically viable for large-scale glass production (generally >100 tonnes per day although there are examples of smaller furnaces). For production rates of >500 tonnes per day cross-fired furnaces are generally used to obtain good heat control along the full length of the furnace.

Recuperative Furnaces

These furnaces are less energy efficient than regenerative furnaces, but still recover a substantial amount of heat via the recuperator system. Further improvements in energy efficiency are possible using further techniques, e.g. electric boost, waste heat boilers, gas preheating, and batch/cullet preheating. Preheat temperatures are lower than in regenerative furnaces and good results can be achieved with primary NO_x controls.

Combined Fossil Fuel and Electric Melting

There are two principal approaches to the use of this technique, predominantly fossil fuel firing with electric boost or predominantly electrical heating with a fossil fuel support. Provision for electric boosting is installed in many furnaces and can contribute 2 - 20 % of total energy input. Generally in container and float glass furnaces, the amount of electric boosting is very limited (<5 %) due to the cost of electricity. Electric boosting will reduce the direct emissions from the furnace by the partial substitution of combustion by electrical heating for a given glass pull rate. As discussed in Section 4.2.1 below if a more holistic view is taken the reductions achieved on-site should be considered against the emissions associated with power generation.

The high costs associated with electric boost mean that it is not generally a practicable long-term emission reduction option for base level production. It is an operational tool, the use of which is determined by economic and technical issues. Electric boost has a beneficial effect on furnace emissions and can be used in association with techniques such as low NO_x burners to improve melting and reduce emissions, but it is not a cost-effective option when used in isolation. Electric boost can also be used to improve the convective currents within the furnace which helps heat transfer and can aid refining.

Fossil fuel over-firing on a predominantly electrically heated furnace is a much less commonly used technique. It allows many of the environmental benefits of electric melting to be realised by overcoming some of the technical and economical limitations of the technique. The use of the burners increases the melting rate of the raw materials. Clearly there are emissions associated with the fuel combustion and these will depend on the ratio of the heat supply. Many of the emission reduction techniques discussed in this chapter can be applied in these furnaces, including low NO_x burners and oxy-fuel melting.

Discontinuous Batch Melting

The technique traditionally used for low volume discontinuous melting is the pot furnace, although other techniques such as day tanks and the Flex Melter are becoming more common. The choice of technique will usually depend on the logistics of the specific installation, particularly scale of production, number of different formulations produced, and customer

requirements. Many of the primary abatement measures described in this chapter will be applicable to these furnaces to a greater or lesser degree. The most effective techniques are likely to be the optimisation of batch formulations and combustion techniques. Due to the design of pot furnaces the techniques will generally give better results for day tanks and semi-continuous furnaces. Where the use of day tanks or continuous/semi-continuous melting is practicable better energy efficiency and lower emissions will usually be achieved.

Stone Wool Melting

The most commonly used technique for stone wool melting is the hot blast cupola, although there are examples of electric melting and gas fired furnaces. In several cases these other options have been designed as full-scale developmental plants to study the long-term viability of the techniques, or they have been chosen due to particular local circumstances. The hot blast cupola has a number of operational advantages and is the preferred technique within the sector. The alternatives either do not show any substantial environmental advantages or are not proven to be technically and economically viable for wider application.

4.2.1 Electric Melting

Description of Technique

The technique is described in Chapter 2, because it is a basic melting technique common in several sectors. Electric melting has important effects on pollutant emissions and so is also discussed in this chapter as a “primary” abatement measure.

Environmental Performance

The complete replacement of fossil fuels in the furnace eliminates the formation of combustion products; namely oxides of sulphur, thermal NO_x, and carbon dioxide. The remaining emissions arise from particulate carry over and the decomposition of batch materials, particularly CO₂ from carbonates, NO_x from nitrates and SO_x from sulphates. In most applications sulphate use is quite low because it is not as important for refining and is used mainly as an oxidising agent.

There may also be low levels of halide emissions (e.g. HF) or metals where these materials are present in the raw materials. However, emissions can be significant from added fluoride formulations. The emission of all volatile batch components is considerably lower than in conventional furnaces due to the reduced gas flow and the absorption, condensation and reaction of gaseous emissions in the batch blanket which usually covers the whole surface of the melt.

The furnaces are usually open on one side and there are significant air currents due to the gaseous emissions and the heat from the melt. It is usually necessary to provide some form of ventilation to allow dust, gases and heat to escape without entering the work place. This is achieved either by natural draught or by extraction. The waste gas emitted by natural draft will have a very low volume but may have a high dust concentration, and poor dispersion characteristics.

Dust emissions can be controlled by extraction to a dust abatement system, which due to the low volumes involved is usually a bag filter. This arrangement results in very low dust emissions and also allows for the treatment of HF emissions by dry scrubbing if necessary. See Sections 4.4.1.3 and 4.4.4.2.

The actual emissions achieved will depend greatly on the batch formulation, and due to the low waste gas flows a comparison of emission concentrations can be misleading. However, as a broad indication overall direct emissions are reduced by a factor of between 10 and 100 compared with a conventional air-fuel fired furnace of comparable pull rate. Some actual

quantitative data is given in Chapter 3 for mineral wool installations, and in the case studies in Annex 1.

Financial Considerations

The economic viability of electric melting depends mainly on the price differential between electricity and fossil fuels. At the time of writing average electricity costs per unit energy are 4 to 5 times the cost of fuel oil. Electricity costs can vary by up to 100 % between Member States but fossil fuel prices tend to show less difference. Fuel prices and their variation are discussed in Section 4.4.3.1. Electric furnaces are very thermally efficient, in general 2 to 4 times better than air-fuel fired furnaces. The comparison for large energy efficient furnaces is at the lower end of this range, and for smaller furnaces at the upper end.

Electric furnaces have much lower capital costs than conventional furnaces which when annualised partially compensate for the higher operating costs. However, the furnaces have shorter campaign lives before they require rebuild or repair, i.e. 2 to 6 years compared to 10 to 12 years for conventional furnaces. For small air-fuel conventional furnaces (up to around 50 tonnes/day), the heat losses are relatively high compared to bigger furnaces. In the range of 10 to 50 tonnes/day, because of the higher specific heat losses of air-fuel furnaces, the electric furnace can be more competitive.

Based on current practice the following is proposed as a very general indicative guide to the size of electrical furnaces which may be viable, i.e. those which can potentially be a practicable alternative. There are inevitably exceptions due to local circumstances.

- Furnaces below 75 tonnes per day are generally viable.
- Furnaces in the range 75 - 150 may be viable in some circumstances.
- Furnaces greater than 150 tonnes per day are generally unlikely to be viable.

The financial considerations can also be greatly affected by site-specific factors including: prevailing energy costs; product quality requirements; available space; costs of alternative abatement measures; prevailing legislation; ease of operation; and the anticipated operating life of alternative furnaces.

In those Member States where the price difference between fossil fuels and electricity is at the upper end of the range given, the option of electric melting may appear less attractive. In such cases this could lead the operator to select a combination of other techniques in preference to electric melting.

Applicability

Electric melting is applicable in many parts of the Glass Industry and is widely used in several sectors including Ceramic Fibre, Mineral Wool, Special Glass, Domestic Glass, and to a lesser extent in Container Glass. Electric melting can clearly only be installed at a furnace rebuild. There are no known full-scale examples of electric melting in the Flat Glass or Frits Sectors. The technique is commonly used for the production of potentially highly volatile, polluting glasses (e.g. lead crystal and opal glass) and for high value added products.

The wider use of the technique is limited by the operating costs and by some technical considerations. As discussed above the main constraint is the operating cost and depending on a range of factors this sets an upper size limit on the economic viability. The fact that the technique is potentially viable does not mean it necessarily represents BAT for any particular application.

At the time of writing, the technique is not in use for large volume glass production (>300 tonnes per day) and so cannot be considered fully proven either technically or economically.

Continuous filament glass fibre is produced with E-glass, which has a low sodium content resulting in very poor electrical conductivity. The production of E Glass using 100 % electric melting is not considered to be currently economically or technically viable.

An experimental float glass line with an electrically heated furnace is currently operating in the UK. This plant was built to demonstrate the principle of cold top electric melting for float glass production. The plant has operated successfully on this pilot scale and it has been used to produce a range of exotic glasses, the emissions from which would have been very difficult to control from a conventionally fired furnace. The experiment has also shown that it is not currently economically viable to operate a full-scale float glass line (>500 tonnes per day) with an electric furnace. The main factors are high operating costs, limitations of furnace design, and the short operating life of the furnace.

Associated Considerations

Direct emissions from the furnace are greatly reduced using this technique and the thermal efficiency is very high. However, when considering the overall environmental performance of the technique the environmental impact of power generation can offset some of the advantages. A full quantitative analysis is impossible within the scope of this document. The environmental issues associated with electricity generation are very complex, and differ widely across the EU and sometimes between installations.

Electricity can be supplied from the national supply or from a local or dedicated supply, which can affect both the cost and the efficiency of supply. If the power is taken from the national supply network it can be from a wide variety of sources. Power generation from coal, oil, gas, nuclear, hydro and other renewable sources all have very different environmental issues associated with them.

The difference in thermal efficiency between electric melting and fossil fuel melting is also reduced when the efficiency of electricity generation is considered. Again it depends very much on the source of electricity, but for a traditional fossil fuel fired power plant the efficiency from primary fuel to point of electricity use is in the region of 30 - 35 %. For a combined cycle natural gas turbine plant the figure would be closer to 50 %.

Due to the low waste gas volumes associated with the technique the cost of any downstream abatement equipment is greatly reduced, and the low volumes of collected dust can be readily recycled. The low volatile loss also reduces the consumption of raw materials, which reduces both emissions and costs. This is particularly beneficial for some of the more expensive and/or toxic components such as lead oxides, fluorides, arsenic compounds, borax etc.

In general, electric melting produces a very homogenous high quality glass. For some domestic and special glass applications this can be one of the primary reasons for choosing electric melting.

The traditional view within the Glass Industry is that sodium nitrate or potassium nitrate are required in cold-top electric furnaces to provide the necessary oxidising conditions for a stable, safe and efficient manufacturing process. The use of nitrates directly affects the emissions of NO_x and although not necessary for all applications, this can reduce some of the environmental benefits of electric melting. The use of nitrates as oxidising agents becomes more important where waste material containing organic compounds is recycled to the melter. The use of high external cullet levels (or other recycled materials) can sometimes cause odour problems.

Advantages

- Very low direct emissions.
- Potentially increased melting rate per m² of furnace area.
- Improved direct energy efficiency.
- In some cases lower raw material costs
- In many cases electric melting gives a better quality more homogenous glass.
- Reduced capital cost and furnace space requirements.
- Potentially more simple operation.

Disadvantages

- High operating cost.
- Reduced campaign length.
- Not currently technically and economically viable for very large-scale glass production.
- Less flexible and not adapted to large pull variations for high quality glasses.
- Associated environmental implications of electricity generation.

Table 4.1: Main advantages and disadvantages of electric melting

Example Installations

Schott Glas, Mainz, Germany – Special Glass.

Pilkington Glass Technology, St Helens, UK – Flat Glass (Experimental/Specialist).

Thermal Ceramics, Merseyside, UK – Ceramic Fibre.

British Gypsum Isover, Runcorn, UK – Glass Wool.

Saint-Gobain Desjonqueres, Mers-les-Bains, France – Container Glass.

4.3 Techniques for Materials Handling

The diversity of the Glass Industry results in the use of a wide range of raw materials. The majority of these materials are solid inorganic compounds, either naturally occurring minerals or man-made products. They vary from very coarse materials to finely divided powders. Liquids and, to a lesser extent, gases are also used within most sectors. The general techniques used for materials handling are described in Chapter 2, Section 2.1. There are very few issues regarding emissions to air from materials handling that are specific to the Glass Industry. Therefore, this section only summarises those techniques, which are generally considered to constitute good practice when handling these types of materials.

Bulk powder materials are usually stored in silos, and emissions can be minimised by using enclosed silos, which are vented to suitable dust abatement equipment such as fabric filters. Where practicable collected material can be returned to the silo or recycled to the furnace. Where the amount of material used does not require the use of silos, fine materials can be stored in enclosed containers or sealed bags. Stockpiles of coarse dusty materials can be stored under cover to prevent wind born emissions. Where dust is a particular problem, some installations may require the use of road cleaning vehicles and water damping techniques.

Where materials are transported by above ground conveyors some type of enclosure to provide wind protection is necessary to prevent substantial material loss. These systems can be designed to enclose the conveyor on all sides. Where pneumatic conveying is used it is important to provide a sealed system with a filter to clean the transport air before release. To reduce dust during conveying and "carry-over" of fine particles out of the furnace, a percentage of water can be maintained in the batch, usually 0 - 4 %. Some processes (e.g. borosilicate glass production) use dry batch materials, and where dry materials are used the potential for dust emissions is higher and greater care is needed.

An area where dust emissions are common is the furnace feed area. The main techniques for controlling emissions in this area are listed below:

- Batch moisture.
- Slight negative pressure within the furnace (only applicable as an inherent aspect of operation).
- Provision of extraction, which vents to a filter system, (common in cold top melters).
- Enclosed screw feeders.
- Enclosure of feed pockets (cooling may be necessary).

Dust emissions can occur directly to atmosphere or may occur within the process buildings. Where this occurs, dust can build up within the building and can lead to fugitive emissions by the movement of air currents in and out of the building. In potentially very dusty areas such as batch plants the buildings can be designed with the minimum of openings and doors, or dust curtains can be provided where necessary. In the furnace buildings it is often necessary to ensure a degree of natural cooling and so vents etc are provided. It is important to ensure a good standard of house keeping and that all dust control measures (seals, extraction etc.) are properly functioning.

Areas of the process where dust is likely to be generated (e.g. bag opening, frit batch mixing, fabric filter dust disposal, etc) can be provided with extraction which vents to suitable abatement plant. This can be important at smaller installations where a higher degree of manual handling takes place. All of these techniques are particularly relevant where more toxic raw materials are handled and stored, e.g. lead oxide and fluorine compounds.

Volatile raw materials can be stored so as to minimise emissions to air. In general, bulk storage temperatures should be kept as low as practicable and temperature changes due to solar heating etc. should be taken into account. For materials with a significant vapour pressure, or for odorous substances, specific techniques may be necessary for reducing releases arising from tank breathing or from the displacement of vapour during liquid transfers.

Techniques for reducing losses from storage tanks at atmospheric pressure include the following:

- tank paint with low solar absorbency,
- temperature control,
- tank insulation,
- inventory management,
- floating roof tanks,
- vapour return transfer systems,
- bladder roof tanks,
- pressure/vacuum valves, where tanks are designed to withstand pressure fluctuations,
- specific release treatment e.g. adsorption, absorption, condensation,
- subsurface filling.

4.4 Techniques for Controlling Emissions to Air from Melting Activities

4.4.1 Particulate Matter

[tm18 CPIV, tm30 Dust]

For the purposes of this document the term particulate matter is taken to mean all material that is solid at the point of measurement, and for emissions from melting activities is considered to

be synonymous with the term dust. Both of these terms are used interchangeably throughout this chapter. The term total particulate matter is taken to mean all inorganic and organic solid materials (with no lower size limit), droplets and aerosols. The temperature at the point of measurement is particularly important for glass furnaces because some of the materials that form dust (particularly borates) can be volatile at quite low temperatures. Also the nature of the dust from these processes makes accurate measurement very difficult.

The nature of the dust emission from glass furnaces varies for different processes, but depends mainly on the furnace design and operation, and on the glass composition. The three main sources of dust from melting are:

- Batch material carryover.
- Volatilisation and reaction of substances from batch materials and the glass melt.
- Metals impurities in the fuels.

For fossil fuelled furnaces the volatilisation and subsequent reaction/condensation of volatile materials released from the hot glass surface, represents by far the largest proportion of the overall dust emission. In general, 80 to 95 % of the dust emission will be produced in this way. It is therefore important to ensure that any volatile species have been condensed before the waste gas is treated or measured. This is not a problem for sodium sulphate (melting point c. 888°C) but is a consideration for borate containing flue gases.

Carry over of batch materials usually accounts for less than 5 % of the final emission from a modern, well operated furnace. This dust is made up of the components of the batch, and is dominated by the lightest materials.

Metal impurities in fuels (vanadium and nickel) will contribute to dust emissions, but at a level generally significantly below 5 % of the total. These impurities arise mainly with fuel oil, which may also add a small amount of ash to the total. Metal impurities also occur in cullet and other raw materials.

The mechanisms of material volatilisation and particulate formulation are not fully understood for all glass types. Approximately 90 % of all glass produced in the EU is soda-lime glass, and most information is available for these compositions. Dust from soda-lime glass furnaces is predominantly composed of sodium sulphate. Up to 98 % of the dust is made up of soluble materials, of this 80 - 90 % is sodium sulphate. The remainder will depend on the precise glass composition, but will contain mainly sulphates, particularly K_2SO_4 . The insoluble fraction contains mainly silica, with lower levels of metals (e.g. Al, Fe, and Cr). If external cullet is used the dust may contain other components (e.g. lead). The particle diameter is generally in the range 0.02 to 1 μ m, but the small particulates readily agglomerate into larger particles. A number of different volatilisation processes can be distinguished and are discussed in Section 4.4.1.1 below.

For glasses that contain substantial levels of boron in the composition (e.g. continuous filament glass fibre, glass wool, and borosilicate glass) borates are a major component of the emitted dust. The ratio of sodium sulphate to borates in the dust will depend on the glass composition. In low alkali formulations e.g. E glass and glass wool, the borate based compounds will represent over 85 % of the total dust emissions. The remainder will be made up of sulphates, silica and compounds dependent on minor batch components and impurities.

In lead glass (T.V. and crystal glass), lead volatilisation will produce lead oxide or sometimes lead sulphate condensations.

In cold top electric melters the emission of dust is much lower and arises almost exclusively from batch material carry over. The absence of the high temperature combustion atmosphere precludes the formation of particulate matter by reactive volatilisation. In stone wool cupola

furnaces the dust emissions are a combination of raw material dust, combustion products, and condensed volatiles released during melting.

The emissions to air of metals from glass processes are largely contained in the particulate matter. For this reason metals are not treated separately in this chapter, but are discussed in respect of dust emissions and where appropriate references are made to other sections. However, in some circumstances there can be significant gaseous metal emissions, for example, selenium from bronze or decolourised glasses, and lead from some lead crystal or special glass processes.

The main sources of metals are impurities in raw materials, metals in raw materials/additives used to impart specific properties (e.g. lead oxides, and colourants/decolourants), cullet and fuel. External cullet is an important source of metal contamination particularly for lead (in some cases >400 ppm) but also for other metals for example, mercury contamination can occur if cullet contains mercury vapour light tubes. Information on metal emission levels is given in the sector specific sections in Chapter 3 and in Table 3.3.

There are three main approaches to controlling emissions of metals either within the dust or as gaseous components.

1. Raw material selection to minimise contamination and where practicable to use alternative additives. Raw material selection includes cullet sourcing and sorting.
2. Dust abatement techniques, particularly bag filter systems and electrostatic precipitators. Where emissions contain significant metal concentrations high efficiency dust abatement systems can generally reduce emissions to less than 5 mg/Nm³.
3. Gaseous metal emissions (e.g. selenium) can be substantially reduced by the use of dry or semi-dry scrubbing techniques in combination with dust abatement, see Section 4.4.3.3.

In some instances, and particularly in Germany, a major factor in the driving force for the installation of dust abatement combined with dry or semi-dry scrubbing has been the reduction of metal emissions.

4.4.1.1 Primary Techniques

[tm18 CPIV, tm30 Dust]

A glass furnace is a very dynamic environment and any changes to the chemistry or operating conditions can have consequent effects within the melting process, and on other emissions. For this reason it is important to consider all the primary techniques described in this document as a package rather than simply as individual techniques. However for clarity the techniques have necessarily been described separately, but consequent effects have been discussed where possible.

A low level of emission from material carry over is achieved by maintaining a level of moisture in the raw materials and by controlling the batch blanket coverage, particle size, gas velocity and burner positioning. For those processes which require dry batch materials and/or very fine batch materials the figures may be slightly higher. However, the contribution to the overall emission will still be minor compared to the volatile species contribution. Issues relating to dust arising from material charging are dealt with in Section 4.3 above.

Because the dust emissions arise mainly from volatile species, the primary abatement techniques discussed here concentrate on this source. From dust analysis of soda-lime furnaces, it can be concluded that sodium species are the major components leading to dust formation in flue gases. Volatile species from the batch (e.g. NaCl) and from the melt (e.g. NaOH) react with sulphur oxides to form Na₂SO₄, which condenses in the waste gas below 1100°C. In most cases, sodium sulphate is used as the fining agent. The dissociation of the sodium sulphate in the

molten glass leads to sulphur oxide concentrations, which are much higher than the sodium component concentrations in the combustion chamber and in the flue gases. The oxides of sulphur from fuel combustion or batch sulphate are available in stoichiometric excess compared to the volatilised sodium, which is the governing parameter for the dust formation. The main sources of sodium are the cullet or soda ash, and the sodium in the sodium sulphate is not a significant factor.

In very sulphur lean gases, sodium chloride, sodium fluoride or sodium carbonate particles can be formed during the cooling of the flue gases to below 900°C. This is not common, and can only occur when natural gas is used and when sodium sulphate is replaced by another fining agent, like antimony. This is never the case for container or flat glass but could happen in special applications.

A number of different volatilisation processes can be distinguished in soda-lime glass:

- (a) Reactive volatilisation from the molten glass surface. The sodium oxide in the silicate melt reacts at the surface with water vapour: $\text{Na}_2\text{O (melt)} + \text{H}_2\text{O} \rightarrow 2 \text{NaOH (g)}$. This type of volatilisation may be the major source of dust emissions in soda-lime glass furnaces.
- (b) Volatilisation of NaCl, present as an impurity in synthetic soda. This volatilisation leads not only to sodium sulphate dust but also to HCl formation.
- (c) Volatilisation of sodium sulphate from the surface of molten glass.
- (d) Reactive volatilisation by chemical reactions at the batch blanket surface with components in the furnace atmosphere. The water vapour in the combustion chamber is thought to be important for the reaction of soda ash to form sodium hydroxide vapours, with similar reactions for potassium compounds: $\text{Na}_2\text{CO}_3 + \text{H}_2\text{O} \rightarrow 2\text{NaOH(g)} + \text{CO}_2$.
- (e) Volatilisation of raw material components from the surface of the batch blanket (e.g. sand, feldspars, lime, soda ash, dolomite and sodium sulphate) is generally very low. Vapour pressures are very low below 1200°C, and above 1000°C the single components have already reacted to form silicates.
- (f) Volatilisation of sodium compounds in gas bubbles during the fining process is also of relatively minor importance
- (g) In the case of recycling of external cullet (container furnaces), emissions of lead components (PbO, PbCO₃, PbSO₄) might take place because of lead glass, mirror fragments and metallic lead contaminants in the cullet.

The situation is different for other glass types. For low alkali boron containing glasses (e.g. E Glass and glass wool) reactive volatilisation is thought to be the main source of particulate. The emitted dust is made up mainly of the reaction products of metaboric acid with sodium and potassium. Metaboric acid is formed by the reaction of boric acid with water vapour - $\text{B}_2\text{O}_3 (\text{l}) + \text{H}_2\text{O} \rightarrow 2\text{HBO}_2(\text{g})$. Dust formation by volatilisation occurs very readily for boron containing glasses and the concentration of unabated emissions is generally higher than for soda-lime glasses. In some cases they are more than ten times higher.

The types of volatilisation mechanisms described for soda-lime glass are the general basis of volatilisation in most other glasses, but clearly there is variation depending on the chemistry.

The most important factors affecting volatilisation are temperature, water vapour content in the furnace atmosphere, and the velocities of the gases at the surface of the melt. The availability of reactive species is also an important factor, particularly sodium and sulphates in soda-lime glass, and boron in boron glasses. However, this factor is often limited by the glass chemistry.

The most important primary measures that can be taken to reduce dust emissions are outlined below:

Raw material modifications

Sodium chloride can be a significant factor in emissions of dust and chlorides. It is used in some special glasses as a refining agent, but is more usually present as a low level impurity in soda ash made by the Solvay process. Pressure from the Glass Industry has led soda ash producers to lower NaCl levels significantly in recent years (now generally around 1 kg/tonne). A further significant reduction in the short term would probably require further processing and therefore an increase in price. Natural soda ash is available which is virtually NaCl free, but this material is generally more expensive in the EU due to taxes and transport costs from the countries of origin.

In most modern furnaces the batch sulphate levels have been reduced to the minimum commensurate with good fining and maintaining the correct oxidation state of the glass. Alternatives to sodium sulphate can pose a greater environmental problem e.g. arsenic and antimony based fining agents. Further progress in this area is not expected to yield substantial emission reductions. It is thought the limiting factor is the concentration of the sodium containing vapours, but for gas fired furnaces very reduced sulphate concentrations would limit the reaction in the gas phase.

In boron containing glasses the boron is essential to the forming of the products and the product characteristics. In recent years substantial reductions have been made in boron levels, but further progress is becoming difficult without affecting the productivity, energy consumption and quality. Boron containing materials are relatively expensive and every effort is made to reduce consumption. At the time of writing no credible alternatives to boron are available and the difficulties have led many operators to install secondary abatement techniques, particularly for glass wool and borosilicate furnaces. In general, abated dusts are recycled to the furnace.

A number of companies in the Continuous Filament Glass Fibre Sector have developed glass compositions that have low levels of boron and fluorine or only contain these elements due to trace levels in the raw materials. Emissions below 50 mg/m³ have been reported, which demonstrate the importance of boron in the dust formation. This type of glass requires a higher melting temperature, is more difficult to fiberise, and the long-term effects on refractory life have yet to be determined. The details of the technique are proprietary, and therefore, although extremely promising, the technique cannot yet be considered as generally available. Progress varies between the different companies, but several of these formulations are now marketable.

Temperature reduction at melt surface

The crown temperature is an important factor in particulate formation, as more volatile species are generated at higher temperatures. A correlation between crown temperature and particulate formation has been shown in soda-lime furnaces. Reduction of furnace temperature must be balanced with glass quality and the productivity of the furnace. Measures which have the greatest effect in reducing dust per tonne of glass are those which improve the energy efficiency and particularly the heat transfer to the glass, thus allowing a lower crown temperature. The main points are:

- Furnace design and geometry, to improve convective currents and heat transfer. These modifications can only be implemented at the furnace rebuild. Larger furnaces are generally more energy efficient resulting in also lower emissions per tonne of glass
- Electric boost, helps to reduce crown temperature by putting energy directly into the melt and improving convective currents. The positioning of the electrodes is important, but this is difficult to change except at the furnace rebuild. The use of electric boost is usually limited by the cost of electricity.
- The increased use of cullet will reduce the melting energy requirement allowing operation at a lower temperature and lower fuel usage. Also, because cullet has already been melted its use helps to reduce the level of some of the volatile and reactive species, which contribute to dust formation e.g. sodium chloride and batch sulphates. In oil fired furnaces cullet usage also reduces the fuel requirement and therefore SO₂ levels. Cullet usage is limited by the availability of cullet at the correct quality and composition. For example, container glass furnaces use 5 - 95 % cullet (internal and external), soda-lime domestic glass and flat glass furnaces generally 10 - 40 % (usually only internal), and continuous filament glass fibre furnaces rarely use any cullet.

Burner positioning

Another important factor in the rate of volatilisation from the melt is the rate of replacement of the gases above the melt. A high gas velocity or a high level of turbulence at the surface of the melt will increase the rate of volatilisation. Progress has been made with burner positioning to optimise combustion air velocity and direction, and fuel velocity and direction. Further work has also been carried out involving combining these changes with modifications to furnace width and the length of the unfired portion of the blanket. Changes that involve modifications to furnace design can only be implemented at furnace rebuild, and other changes are sometimes most effective when implemented with furnace redesign.

Conversion to gas firing (or very low sulphur oils)

Conversion from fuel oil firing to natural gas firing can give substantial reductions in dust emissions. The reasons for this are probably the particular condensation reactions for particulates with gas firing, although in some cases the reduced SO_x levels might also be a factor. For example, the flat glass sector has reported dust emission reductions in excess of 25 % for the conversion from oil to gas firing. The flat glass sector has also reported a significant effect from reducing the sulphur content of the oil (20 mg/Nm³ reduction in dust per 1 % reduction in oil sulphur content). A similar effect was observed in domestic glass with low sulphur oil (<1 %). Conversion to natural gas firing is discussed in more detail in Section 4.4.3.1. The main points are summarised below:

- The majority of plants are already equipped to use either fuel, although some may not have access to a natural gas supply.
- Costs of the technique will depend mainly on the prevailing fuel prices.
- There is concern within the industry that heat transfer to the melt is poorer than with oil firing due to the lower luminosity of the flame.
- Natural gas firing can result in higher NO_x emissions compared with oil firing.
- Some cases of mixed combustion, using simultaneously both types of fuels in one furnace, may give interesting compromises of the two types of melting processes (low NO_x, SO_x and dust emissions).

Other considerations

Emissions from cold top electric melters can be minimised by reducing air flows and turbulence during charging, and by raw material grain size and moisture optimisation. Primary measures

are rarely implemented for dust emissions from stone wool cupolas. The main action that could be taken would be washing the raw materials to remove dust. However, most cupolas are fitted with bag filters and so there is little incentive to take primary measures, because they are very unlikely to change the need for secondary measures.

Environmental performance of primary techniques

The emission levels achievable using primary techniques are difficult to quantify, because of the wide range of factors that can affect the results and the wide variation in furnace types and glass formulations.

For flame fired furnaces the lowest emission levels, using only primary abatement techniques, are achieved by furnaces producing soda-lime glasses. Average mass emissions are around 0.4 kg/tonne of glass melted, and the majority of the emission concentrations fall into the range of 100 - 300 mg/m³. There are some furnaces achieving less than 100 mg/m³ for dust, but these are not common.

By the optimisation of primary techniques (based on current knowledge and expected improvements to furnace operation), the soda-lime glass industry has stated that a value of between 70 and 100 mg/m³ could be a realistically achievable dust emission within the foreseeable future [tm30 Dust]. At the time of writing few plants have dust emission levels below 100 mg/Nm³ without secondary abatement, and 100 - 200 mg/Nm³ (≤ 0.4 kg/tonne of glass) is considered currently achievable with primary measures. It is unlikely that these figures could be achieved for compositions other than soda-lime glass. In general, for other compositions the optimisation of primary techniques could be expected to reduce emissions by 10 - 30 %.

Financial considerations

Very little data is available on the costs of primary techniques, but industry has reported that the costs of the measures implemented to date are considered to be low. Indeed those techniques that reduce energy usage may result in cost savings. Costs relating to gas firing are discussed in Section 4.4.3.1.

Primary measures can involve varying costs depending on the level and time scale of application. The measures are an overall package and it is the optimisation of the package that determines the costs and results. For example, the use of low chloride or natural soda ash is unlikely to reduce dust emissions to levels comparable to secondary abatement, and depending on other factors the costs may be disproportionate to the benefits. However, it is one aspect of the package of measures, the costs and results of which, must be considered as a whole.

Applicability

The principles described are considered to be generally applicable to all parts of the industry within the constraints identified. However, techniques successfully implemented in one process may not have the same effects in other plants. In the short to medium term, primary measures for dust abatement are likely to achieve more significant reductions for soda-lime formulations than for other glass types.

Associated considerations

Advantages

- Low cost.
- Focus on prevention rather than abatement.
- Do not involve the use of energy or the potential solid wastes that can be associated with secondary techniques.

Disadvantages:

- Primary measures cannot meet the emission levels associated with secondary techniques such as electrostatic precipitators. This is unlikely to change in the foreseeable future.
- Primary measures place additional operating constraints on the process.

Table 4.2: Main advantages and disadvantages of primary techniques for dust reduction

4.4.1.2 Electrostatic Precipitators

Description of technique

The electrostatic precipitator (EP) is capable of operating over a wide range of conditions of temperature, pressure and particulate burden. It is not particularly sensitive to particle size, and can collect particulate in both wet and dry conditions. The EP consists of a series of high voltage discharge electrodes and corresponding collector electrodes. Particles are charged and subsequently separated from the gas stream under the influence of the electric field generated between the electrodes. The electrical field is applied across the electrodes by a small direct current at a high voltage (up to 80kV). In practice an EP is divided into a number of discrete zones (up to 5 fields can be used).

Particles are removed from the gas stream in four stages:

- application of an electrical charge to the particles;
- migration of the particle within the electrical field;
- capture of the particles onto the collecting electrode; and
- removal of the particles from the surface of the electrode.

The discharge electrodes must be rapped or vibrated to prevent material build-up and their mechanical strength must be compatible with transmission of the rapping blow or vibration. The mechanical reliability of the discharge electrodes and their supporting frame is important as a single broken wire can short out an entire electrical field of the precipitator. In wet precipitators, the collected material is removed from the collector plates by flushing with a suitable liquid, usually water, either intermittently or by continuous spray irrigation.

The performance of an EP follows the Deutsch Formula, which relates dust collection efficiency to the total surface area of collector electrodes, the volumetric flow rate of the gases and the migration velocity of the particles. For a given material, maximising the surface area of the collector electrodes and the residence time in the electrical fields are two of the most important parameters. Also the larger the distance between collecting electrodes the higher the voltage that can be applied. This distance is dependent on the supplier design.

Good rectifier design includes the use of separate rectifier sections for each zone or portion of a zone of the EP. This allows the applied voltage to be varied in the inlet and outlet zones to take account of the reduced particulate load towards the outlet, and allows operation of the zones at progressively higher voltages. Good design is also influenced by the use of automatic control systems, which ensure that the optimum high-tension (HT) voltage is applied to the electrodes. Fixed HT power supplies are unlikely to provide optimal collection efficiencies.

The resistivity (the inverse of the conductivity) of the particulate material is particularly important. If it is too low the particles reaching the collector electrode lose their charge easily and particulate re-entrainment can occur. When the particulate has too high a resistivity an insulating layer is formed on the electrode, which hinders normal corona discharge and leads to reduced collection efficiency. Most particulates encountered in the Glass Industry have a resistivity within the correct range. However, if necessary collection can be improved by conditioning the particulate, e.g. ammonia and sulphur trioxide, can be used but this is not generally necessary in glass processes. The resistivity can also be reduced by reducing the gas temperature or by adding moisture to the gas.

To achieve the best performance from a precipitator it is essential that the gas flow through the unit is uniform and that no gas bypasses the electrical field. Correct design of inlet ducting and the use of flow distribution devices within the inlet mouthpiece must achieve uniform flow at the inlet to the precipitator. In general, the operating temperature must be kept below 430°C. The performance of an EP will reduce during prolonged operation. Electrodes can rupture, become misaligned or scaly, and regular overhaul is necessary particularly in older equipment.

In applications where the gas stream may contain significant concentrations of acid gases (particularly SO_x, HCl and HF) it is generally considered necessary to use some form of acid gas scrubbing prior to the EP. This usually consists of dry or semi-dry scrubbing using calcium hydroxide, sodium carbonate or sodium bicarbonate. These techniques are discussed in Section 4.4.3. The acid gases arise from the raw materials and from fuel oil combustion, without acid gas removal the EP could suffer severe corrosion problems. With some boron containing glasses the alkali also helps to precipitate volatile boron compounds. If waste gases do not contain high levels of acid gases (i.e. gas firing and low sulphur raw materials) pre-treatment may not be necessary, e.g. in most glass wool processes.

Environmental performance

EPs are very effective in collecting dust in the range 0.1 µm to 10µm, and overall collection efficiency can be 95 - 99 % (depending on inlet concentration and EP size). Actual performance varies depending mainly on waste gas characteristics and EP design, but emission concentrations in the range 5 to 50 mg/m³ can be achieved. Although an important factor, the performance does not depend exclusively on the number of electrical fields applied. A two stage EP of one design may be as efficient as a three stage EP of a different design or in a different application, and the choice will depend on the necessary performance level.

In most applications a modern well designed two or three stage EP could be expected to achieve 20 mg/m³ and less than 0.1kg dust per tonne of glass melted. In the Glass Industry almost all examples of EPs are two stage and modern designs can achieve the figures indicated. In many applications EPs can achieve figures below these levels either due to favourable conditions or because high efficiency designs are used. Emission levels for EPs can sometimes be less than 10 mg/Nm³. However, except where favourable conditions exist, to guarantee performance at this level would generally involve costs higher than those identified in this section.

At installations with several furnaces the EP may be common.

Financial considerations

The major factors affecting EP costs are:

- waste gas volume;
- required efficiency;
- number of fields;
- waste gas conditioning;
- if acid gas scrubbing is required; and
- dust disposal costs (if not possible to recycle).

Each additional electrical field over two will increase capital costs by about 15 - 20 %.

The table below shows indicative capital and operating costs for EPs for varying sizes of furnaces and airflow, including acid gas scrubbing. The figures given may vary by plus or minus 15 % for capital costs and 30 % for operating costs, depending on a number of site-specific factors. The operating costs include the cost of the acid gas scrubbing but not interest or depreciation. For installations that do not require acid gas scrubbing the capital costs will be approximately 30 % lower and operating costs 30 - 40 % lower. For existing installations further costs (generally 5 - 20 %) may be incurred if modifications to the existing configuration are required.

Size tonnes/day	Gas Volume Nm ³ /hour	Capital cost (x1000) euros	Operating cost (x1000) euros per year
50 t/d Container	6400	565	37
100 t/d Container	11120	875	53
300 t/d Container	23000	1420	89
450 t/d Container	33350	1820	116
600 t/d Float	70000	2750	186
100 t/d Glass Filament	-	-	64

Table 4.3: Costs of electrostatic precipitators with acid gas scrubbing [tm32 Beerkens]

The infrastructure costs will vary depending on the size of the EP and on the local circumstances for each installation. As mentioned above EPs can be quite large and on existing installations substantial civil work may be necessary where space is restricted.

Applicability

In principle, this technique is applicable to all new and existing installations in all sectors. Costs are likely to be higher for existing plants, particularly where there are space restrictions. However, for electric furnaces and smaller conventional furnaces (less than 200 tonnes per day) the high capital costs may lead operators to chose alternative techniques, particularly bag filters. EPs are not used with stone wool cupolas due to the explosion risk associated with carbon monoxide.

There are many examples of EPs used successfully within the Glass Industry, e.g. in Germany approximately 80 furnaces are fitted with EP and acid gas scrubbing. Where Member State regulations have required large-scale glass installations to meet dust emission limits that require secondary abatement, the EP has been the technique favoured by the industry.

Associated considerations

The use of this technique involves an increase in energy consumption, but this is low relative to the energy consumption of the furnace, less than 1 % (1 to 3 % of energy cost). There will be a

resultant environmental effect at the point of electricity generation, which will depend on the source of the electricity.

In many applications within the Glass Industry it will be necessary to remove acid gases prior to treatment. This will usually be achieved by dry or semi-dry scrubbing which creates a solid material stream up to ten times greater than the dust abated. If this can be recycled to the furnace there will be an overall reduction in consumption of raw materials, if not then there will be a waste stream to dispose of.

In practice the collected dust can be recycled in most cases and depending on the sorbent chosen the material can replace a portion of the other raw materials particularly sodium sulphate (and where appropriate fluoride and lead containing materials). Problems could occur in the Container Glass Sector where the sulphate requirements for a reduced glass, especially with high cullet levels, are very low. This could limit the potential for recycling dust especially if high sulphur fuel oil is used, and a portion of the collected dust would have to be disposed of off-site. In some sectors the ability to recycle the collected dust may be limited by product quality constraints and glass chemistry, for example, where very high optical quality is required.

At the time of writing, the costs of disposing of a dust that cannot be recycled can often be higher than the cost of lower sulphur fuels (e.g. low sulphur oil or natural gas). Therefore, in many circumstances (particularly container glass) an operator would be able to change fuels rather than create a solid waste stream for disposal. However, a high cost differential between low sulphur fuel (particularly natural gas) and other fuels may make such an option economically unattractive.

One of the main purposes of the acid gas scrubbing phase is often to condition the gas for the EP, it can also result in lower overall acid gas emissions. If the dust is recycled some of the acid gases will be re-emitted. However, a dynamic equilibrium will form where generally, the overall uptake in the glass will be higher and the emissions will be less.

In the Glass Industry the majority of the particulate matter emitted is formed by reactive volatilisation. It is therefore important to ensure that the gas stream is below the particulate formation temperature. In regenerative furnaces the waste gas temperature is generally around 400°C and cooling is not usually required either to condense volatiles or to achieve the EP operating limits. In recuperative furnaces the waste gas temperature is usually around 800°C and cooling is required, both to condense particulate and to cool the gas to the limits of the EP. For borate containing glasses (e.g. glass wool) it may be necessary to reduce the gas temperature to below 200°C prior to abatement, whilst ensuring that condensation and the associated risk of corrosion are minimised in the system. The waste gas temperature from oxy-fuel furnaces is usually >1000°C and substantial cooling is required.

Advantages:

- High dust removal efficiency.
- Collected dust generally in a form that permits reuse.
- Low pressure drop relative to bag filters, and so relatively low operating costs.
- Can form part of integrated treatment system e.g. with scrubbers and SCR.
- EPs are not easily blocked due to high load or moisture content, can be a problem with fabric filters.
- In general (i.e. not restricted to the Glass Industry), there is more operating experience at high temperature than for bag filters.
- Can be designed to allow addition of further field at later date.

Disadvantages:

- Energy use. Although this is low relative to furnace energy (<1 %), costs are more significant because it is electricity.
- Solid waste stream generated that is not always possible to recycle.
- Many processes require acid gas scrubbing and in these cases an absorbent is consumed.
- EPs can involve higher capital costs than some other systems.
- It is critical to maintain plant operations within the design conditions or performance can drop considerably.
- Safety precautions must be observed in the use of high voltage equipment.
- EPs can be very large and the space requirement must be considered.

Table 4.4: Main advantages and disadvantages of electrostatic precipitators

4.4.1.3 Bag Filters

Description of technique

Fabric filter systems are used for many applications within the Glass Industry, due to their high efficiency in controlling the fine particulate matter encountered in mineral operations. However, due to their potential to blind in certain circumstances, they are not the preferred choice in all applications. In many cases there are technical solutions to these difficulties, but there may be an associated cost.

The basic principle of fabric filtration is to select a fabric membrane which is permeable to gas but which will retain the dust. Initially, dust is deposited both on the surface fibres and within the depth of the fabric, but as the surface layer builds up it itself becomes the dominating filter medium. As the dust cake thickens, the resistance to gas flow increases, and periodic cleaning of the filter media is necessary to control the pressure drop over the filter. The direction of gas flow can be either from the inside of the bag to the outside, or from the outside to the inside.

The most common cleaning methods include reverse air flow, mechanical shaking, vibration and compressed air pulsing. Often a combination of these methods is used. The normal cleaning mechanisms do not result in the fabric returning to its pristine condition. It is not beneficial to over clean the fabric because the particles deposited within the depth of the cloth help to reduce the pore size between the fibres, thus enabling high efficiencies to be achieved.

Fabric filters are designed on the basis of anticipated filtration velocity which is defined as the maximum acceptable gas velocity flowing through a unit area of fabric (expressed in m/s). Filtration velocities generally lie in the range 0.01 to 0.06 m/s according to the application, the filter type and the cloth. The filter design must optimise the balance between pressure drop (operating cost) and size (capital cost). If the filtration velocity is too high then the pressure drop will be high and the particles will penetrate and blind the fabric. If the filtration velocity is too low the filter will be efficient but very expensive.

Because of the tendency of particles present in the waste gas downstream of glass tank furnaces to adhere to the filter material, cleaning of precipitated particles from the filter material is frequently made difficult. Achieving satisfactory continuous operation can be assisted by the tendency of the particles to agglomerate, by continuously recycling a partial stream of particles cleaned off the filter material to the dirty gas stream.

Fabric selection must take into account the composition of the gases, the nature and particle size of the dust, the method of cleaning to be employed, the required efficiency and economics. The gas temperature must also be considered, together with the method of gas cooling, if any, and the resultant water vapour and acid dew point. Characteristics of the fabric to be considered include chemical resistance, fibre form and type of yarn, fabric weave, fabric finish, abrasion and flex resistance, strength, collecting efficiency, cloth finishes and cloth permeability.

It is essential to maintain the waste gas temperature within the correct range for a bag filter system. The gas must be maintained above the dew point of any condensable species present (e.g. H_2SO_4 or water) and below the upper temperature limit of the filter medium. If the temperature is too low condensation occurs, which can cause bag blinding; and if the temperature is too high the filter material can be damaged requiring expensive replacement. Conventional filter fabrics usually have a maximum operating temperature between 130°C and 220°C and in general the higher the operating temperature, the higher the cost. In most glass processes the waste gas temperature is between 450 and 800°C . Therefore, the gas must be cooled before the filter, by dilution, quenching or by a heat exchanger

If the flue gases are likely to contain acidic species (in particular oil fired furnaces) then it is considered necessary to install a scrubbing stage upstream of the filter, to prevent acid condensation which would damage the bags and the filter housing. In practice it is not recommended to use fuel oil with more than 1 % sulphur. For boron containing flue gases the scrubbing stage helps precipitate volatile boron species and may make the dust easier to collect without blockages.

Environmental performance

Fabric filters are highly efficient dust collection devices and a collection efficiency of 95 - 99 % would be expected. Particulate emissions between 0.1 mg/m^3 and 5 mg/m^3 can be achieved and levels consistently below 10 mg/m^3 could be expected in most applications. This generally equates to significantly less than 0.1 kg per tonne of glass melted. The ability to achieve such low levels can be important if dusts contain significant levels of metals, and low metal emissions must be achieved.

Financial considerations

In general, investment costs are lower than for electrostatic precipitators but running costs are higher. However, as competition in the abatement equipment industry increases the costs of bag filters and EPs are becoming closer particularly for larger gas volumes. The differences for both capital and operating costs generally fall within the ranges of costs discussed for EPs in Section 4.4.1.2. This is a case by case assessment, but often smaller plants favour bag filters due to lower capital costs and because for low airflows operating costs are proportionally reduced.

A specific example is given in [tm32 Beerkens], for a 550 - 600 t/day float glass furnace with a flue gas volume of $65000 \text{ m}^3/\text{hour}$ the capital costs for a filter and semi-dry scrubber are approximately 3 million euros, with operating costs (excluding interest and depreciation) of 0.5 million euros. This assumes complete recycling of the collected dust. For a container glass furnace with a flue gas volume of 20000 m^3 the capital costs for a filter and semidry scrubber are approximately 1.5 million euros.

Applicability

In principle, fabric filters can be applied to all types of furnace within the Glass Industry, and to both new and existing furnaces. However, in many of the sectors it has not been the technique of choice due to relatively high maintenance requirements and the potential for the fabric to blind, resulting in the costly replacement of the filter medium. In modern systems some of these problems have been overcome and there are examples of bag filters operating well in container glass plants, borosilicate glass plants and one float glass plant. The addition of a scrubbing stage and low fuel sulphur levels reduce the tendency of the bags to blind.

Filter blockages due to fabric blinding have been a particular concern in fossil fuel fired glass wool furnaces (and some other boron containing glasses), because of the sticky nature of the fine particulate matter, which without a dry scrubbing stage makes it difficult to avoid blockages. The furnaces are usually gas fired with very low concentrations of acid species, and therefore, with an electrostatic precipitator there is no need to install a scrubbing stage. This significantly reduces capital and operating costs and makes dust recycling much easier.

A further concern with bag filters is that most fossil fuelled furnaces require sensitive pressure control, and the presence of a fabric filter with a high pressure drop can make this more difficult.

Bag filters have gained wide acceptance within a number of the sectors of the Glass Industry, particularly for smaller gas volumes. The technique is widely used in conjunction with electric furnaces, stone wool cupolas, frit furnaces and ceramic fibre furnaces. In some smaller fossil fuel fired furnaces bag filters have been chosen as the technique to operate with scrubbing systems which are installed to reduce acid gas emissions. Furthermore, for smaller processes the lower capital costs of bag filters compared with electrostatic precipitators can be very attractive, offsetting the expenses associated with higher maintenance and the risk of bag blinding.

Associated considerations

If a scrubbing stage is incorporated with the technique, a solid waste stream is generated that must either be recycled to the furnace or disposed of. The scrubbing phase will usually result in lower overall acid gas emissions (see Sections 4.4.3.3 and 4.4.4.2). If the dust is recycled some of the acid gases will be re-emitted. However, a dynamic equilibrium will form where generally, the uptake in the glass will be higher, some raw material levels may be reduced, and the overall emissions will be less. The efficiency of scrubbing can be higher with bag filters than EPs, because further absorption can take place on the filter cake.

Due to the generally low operating temperatures of bag filter systems they are not usually the best option for use with SCR systems, because the waste gas would normally have to be reheated to around 350°C to obtain the best efficiencies.

One of the difficulties with bag filters is that although under normal running conditions the bags can have a long life (2 - 4 years), if a problem occurs on the plant and they become blinded or damaged the cost of replacement can be high. These types of problems can and do infrequently occur and so there is a risk of incurring high costs that is not associated with electrostatic precipitators.

Filter fabrics are sensitive materials. A well developed technical procedure combined with a reliable continuous electronic control system are required to prevent avoidable damage to the filter fabric.

If bag filters are damaged emission levels can be quite high and it is important to incorporate a system of bag failure detection. The most effective way of doing this is by continuous dust monitoring.

Advantages

- Very high collection efficiencies.
- Collection of product in dry condition.
- Low capital cost on simpler applications.

Disadvantages

- Solid waste stream generated that is not always possible to recycle..
- Energy consumption due to pressure drop.
- Gas cooling often required.
- Fabric conditioning sometimes required.
- Expensive fabrics sometimes required.
- Space requirements can be high.
- Dew point problems leading to blinding of fabric.
- Cleaning air (reverse flow) sometimes requires to be heated.
- Some dusts very difficult to dislodge causing pressure drop to exceed the design value.
- Bag replacement required periodically.

Table 4.5: Main advantages and disadvantages of bag filters**4.4.1.4 Mechanical Collectors**

This term is used to describe techniques, which use mechanical forces (gravity, inertia, centrifugal) to separate the dust from the gas stream, i.e.

- Cyclones – spinning motion imparted to gas, and dust separated by centrifugal force.
- Gravity settlers – gas enters a large chamber reducing gas velocity and causing dust to settle out.
- Baffle chambers – baffles cause gas to change direction and dust to settle out.
- Louvers – banks of small baffles split and change direction of gas flow causing dust to settle out.

These techniques have poor collection efficiencies for small particles, and due to the low particle size of most dusts encountered in the Glass Industry they are rarely used. The exception to this is the cyclone, which can be found in some applications, particularly as a pre-treatment stage for other techniques. The operating principles and main advantages and disadvantages are summarised below. However, because they are not considered an effective technique for furnace emissions cyclones are not described in detail.

The cyclone is an inertial gas cleaning device. Dust becomes separated from the gas stream when the direction of gas flow is changed and the dust continues in the original direction by virtue of its inertia and is then deposited on a collection surface. There are two types of cyclone, reverse flow and straight through. Reverse flow cyclones are the most common, and consist of a cylindrical shell with a conical base, a dust collection hopper, and air inlet and outlets. There are two main types of reverse flow cyclones, tangential and axial. These classifications arise from the geometry of the air inlet.

The inlet gas stream is channelled into a vortex and centripetal forces sustain the circular motion. Particles above a critical size are thrown from the inlet spiral into a wider circular path and are deposited on the cyclone wall. The airflow carries the dust to the collection hopper, and at the base of the cone the gas flow reverses and clean gas passes back along the centre of the cyclone in the outlet spiral.

In general, the efficiency of a cyclone increases for corresponding increases in: density of particulate material, inlet velocity, cyclone length, number of gas revolutions, ratio of body

diameter to outlet diameter, particle diameter, amount of dust, and smoothness of cyclone wall. Efficiency decreases with increase in: gas viscosity, gas density, temperature, cyclone diameter, gas outlet diameter, inlet gas duct width, and inlet area.

Cyclones are widely used in many industries, and are particularly suitable for collecting particles with diameters greater than 10 μm . Depending on design, medium/high efficiency cyclones give collection efficiencies of 45 - 90 % at 10 μm , and 5 - 30 % at 1 μm . They are frequently placed preceding more expensive technologies, in order to remove coarse material from the gas stream and hence reduce the dust burden entering the main abatement equipment.

Advantages:

- Low capital and operating costs (including maintenance).
- Moderate pressure drop.
- Low space requirement, relative to other techniques.
- Capable of operation with high dust loading.
- Can be used with a wide range of gases and dusts.
- Can be operated at high temperatures and pressures.
- Manufacture possible in a wide range of materials.

Disadvantages:

- Low collection efficiency on small particles.
- Light materials or needle shaped materials difficult to remove.
- Plugging can result where dew points are encountered.
- Explosion relief for flammable materials is difficult.
- Potential problems with abrasive dusts.

Table 4.6: Main advantages and disadvantages of cyclones

4.4.1.5 High Temperature Filter Media

One of the problems with conventional bag filters is the need to maintain the waste gas temperature within the operating range of the filter material. When the temperature goes above the upper temperature limit the filter has to be by-passed or the gas cooled, e.g. by dilution. Conventional filter materials have a temperature limit of 120 - 180°C, with some materials up to 250°C (glass fibre). The costs of the materials increases significantly for materials capable of operating above 180°C. In some applications high temperature media have been used, but these filters are not normal bag filters and usually are similar to candle filter designs.

High temperature filters have been used successfully for abating emissions from some stone wool cupolas, but are no longer used due to high costs. The most common high temperature filters used in other industries are ceramic filters. However, there are no known applications of this technique within the Glass Industry, and consequently no quantitative cost or environmental performance information is currently available. The applications to date have generally been in industries with significantly lower waste gas volumes than associated with most glass furnaces.

4.4.1.6 Wet Scrubbers

Wet scrubbing systems can be used to control both gaseous and particulate emissions. Whilst the basic technology for both of these is similar, the design criteria for particulate or gas removal are very different. However, to keep down capital costs wet scrubbing systems are often used to control mixed emissions of particulates and gases. The design is inevitably a compromise, but may represent BAT where separate control systems are prohibitively expensive. Wet scrubbing systems can also be prone to blockage by insoluble particles, and a waste slurry is generated. The technique is described in more detail in Section 4.5.6.1.2.

In some applications venturi scrubbers may be considered. These systems have a high-pressure drop and consequently they have high power consumption and operating costs. Although good collection efficiencies can be achieved with venturi scrubbers, in some applications, the scale of most glass processes will mean the technique is both technically and economically impracticable. However, the technique may find application in some small-scale specialised applications, particularly if gaseous emissions are also present.

For most glass furnaces wet scrubbing is not likely to be a useful technique for particulate matter abatement.

4.4.1.7 Summary of Considerations of Techniques in Section 4.4.1

The reduction of emissions of particulate matter from glass furnaces is somehow considered as a debatable issue from both a technical and an economic point of view. There are a number of factors that play a role when determining the BAT for de-dusting at glass furnaces, the most important are:

- The environmental impact of the dust.
- Primary and secondary abatement techniques in relation to BAT.
- The economy of scale and related cost considerations

Environmental impact of the dust

The relevant aspects of dust emissions from an environmental point of view are the emission of dust in general, the potential emission of (heavy) metals and the emission of fine particulate matter.

In soda-lime glasses, the main component of the dust is sodium sulphate (up to 95 %). Sodium sulphate is not considered harmful in itself, but as a solid it contributes to the emission of particulate matter. Such emissions are currently receiving increasing attention from environmental policy makers, particularly for particles with a diameter of less than 10 μ m, which is generally the case for emissions from glass furnaces.

Several species of metals may also be found in the particulate matter from glass furnaces. Main components of concern are selenium (Se), lead (Pb), chromium (Cr), copper (Cu), vanadium (V), nickel (Ni), antimony (Sb), arsenic (As), cadmium (Cd), zinc (Zn) and manganese (Mn). The emission of these components strongly depends on the quantity and quality of recycled glass (cullet) used, whether or not fuel oil is used and the addition of metals to the batch formulation for colouring and /or decolouring the glass. Most of these components are predominantly bound in the particulate matter. However, especially for selenium, cadmium, lead and zinc, volatile emissions of these substances may also be significant. In many cases, the main driving force for installing de-dusting equipment has been the reduction of emissions of (heavy) metals, either volatile or incorporated in the dust. The reduction of gaseous emissions (SO₂, HCl etc) has also been the driving force in many cases.

A final point of consideration is the potential condensation of gaseous components after the stack, which can occur especially in boron containing glasses, where a portion of the gaseous boron compounds may pass through the dust abatement equipment and condense after emission to the atmosphere.

Primary and secondary abatement techniques in relation to BAT

The most well established secondary abatement techniques in the glass industry are bag filters and electrostatic precipitators. Both techniques are used widely, although each with its respective possibilities and restrictions. By the end of 1998 approximately 30 % of the soda-

lime glass furnaces in the EU and 100 % of the furnaces in some Member States were fitted with secondary abatement for dust.

On the other hand, the implementation of secondary measures involves substantial financial cost, and a certain degree of environmental cost. In general (for small container plants to large float plants), capital costs will be in the range of 0.5 - 2.75 million euros with operating costs of 37000 to 186000 euros per year. Questions are raised whether secondary de-dusting would be necessary in all cases. Clearly, the costs of primary measures are much lower than for secondary measures and no waste is produced or energy consumed. These are good reasons to prefer primary measures above secondary measures and to stimulate the development of primary measures.

The European Glass Industry invests significantly in understanding the mechanism behind dust formation and the development of primary dust abatement techniques, but experience in this field is still young. At the time of writing only a small number of soda-lime plants have dust emissions below 100 mg/Nm³ without the use of secondary abatement, and 100 - 200 mg/Nm³ (around 0.3 kg/tonne glass) is currently considered the range generally achievable with primary measures. It is claimed that emissions in the range of 70 - 100 mg/Nm³ are possible in the medium term [tm30 Dust]. The relative benefit of further reductions in dust should be considered in the context of the protection of the environment as a whole.

The positive aspects of primary techniques are overshadowed in a technical sense by the currently much better performance of secondary abatement techniques (< 30 mg/Nm³ and < 0.1 kg/tonne glass) and the lack of prospect of reaching such low values with primary measures in the near future, and in an environmental sense by the need to reduce emissions of dust, especially fine particulate matter, acid components and (heavy) metals.

In addition, the exclusive use of primary techniques for reducing dust emissions could limit the flexibility of the operational conditions of the furnace, in terms of quality of the feed materials (low impurities: fluorides, chlorides, heavy metals), type of fuel (low sulphur and heavy metals), production changes (coloured or decoloured glasses).

In the coming years, the Glass Industry will further explore and develop the potential of primary measures to reduce dust emissions from glass furnaces. Due to the lack of solid predictions, it is not possible to anticipate the developments. Therefore, the decision on BAT for dust abatement should be based on the knowledge that is available today.

Economy of scale and related cost considerations

The definition of “available technique” in Directive 96/61/EC requires a technique to be developed on a scale which allows implementation in the relevant industrial sector, under economically and technically viable conditions, taking into consideration the costs and advantages, and to be reasonably accessible. In general, secondary abatement techniques for dust in the Glass Industry are considered to be accessible, technically viable and in the vast majority of cases economically viable.

However, as for any secondary technique, the economy of scale is an important aspect. It means that for small furnaces, relative costs (costs per Nm³ of flue gas treated) are generally higher than for large furnaces. The costs depend on the application and particularly the volume of waste gas. The economy of scale should be taken into account when determining BAT on a general level. Apart from the economy of scale, the overall cost considerations for de-dusting should also include the environmental benefits: removal of fine particulate matter, metals (if present) and acid gas scrubbing (if present), and the drawbacks due to waste generation (if recycling is not possible) and energy consumption.

4.4.2 Oxides of Nitrogen (NO_x)

The term oxides of nitrogen (NO_x) includes nitric oxide (NO) and nitrogen dioxide (NO₂) expressed as the NO₂ equivalent. Nitrous oxide (N₂O) is not a normal pollutant within the Glass Industry, and is not covered in the term NO_x. The three main sources of NO_x emissions from glass melting activities are raw materials, fuel and thermal NO_x. A fourth source, prompt NO_x (from the reaction of nitrogen by a complex route with short lived hydrocarbon radicals) is relatively insignificant.

When nitrates are present in the batch materials NO_x will be emitted as the materials melt. In general, the majority of the nitrogen component is emitted as NO_x and is not incorporated into the glass. For example, when NaNO₃ is melted the sodium component is incorporated into the glass as Na₂O and the rest of the compound is released as gases (NO_x, O₂ and N₂).

Fuel NO arises by from the oxidation of nitrogen and nitrogen compounds present in the fuel, but the overall contribution is low in comparison with thermal NO_x. With natural gas firing, fuel NO is effectively zero.

Due to the high temperatures in glass furnaces (up to 1650°C and 2000°C in the flame) the major source of NO_x is thermally generated NO_x, arising from the oxidation of nitrogen in the combustion atmosphere at temperatures above 1300°C. The main sources of the nitrogen are combustion air, atomising air (in oil fired furnaces), and air leakage into the furnace. The predominant species is NO (90 - 95 %) formed by the reaction $N_2 + O_2 \rightarrow 2NO$. Levels of NO₂ are very low, and most NO₂ detected in the emissions results from atmospheric oxidation of NO. The conditions in the furnace are such that nitrous oxide (N₂O) is not detected in the emissions.

In electrically heated furnaces NO_x arises from batch material breakdown only. In stone wool cupolas there is an overall reducing atmosphere and NO_x emissions are generally very low. Emissions may arise if an afterburner system is installed. The purpose of such a system is to oxidise carbon monoxide and hydrogen sulphide.

In fossil fuel fired furnaces, if all other factors are equal, thermal NO_x emissions are reduced if fuel consumption is reduced. Therefore, techniques that improve energy efficiency generally result in lower overall NO_x emissions expressed in kg NO_x/tonne of glass melted. However, the concentration of the emissions is not always reduced, particularly if waste gas volumes are also lower. The reduction in thermal NO_x is a result of a combination of factors but principally, lower temperatures and reduced combustion air levels. Techniques that reduce NO_x emissions but are primarily intended to reduce energy consumption are described in Section 4.8 and are not discussed here.

4.4.2.1 Combustion Modifications

Description of techniques

The formation of thermal NO_x is qualitatively described by the formula shown below. Where A and B are constants, T is the flame temperature and t is the residence time at temperature T . For gases the relationships relate to concentrations.

$$NO_x = A \times \exp\left(-\frac{B}{T}\right) \times N_2 \times (O_2)^{0.5} \times t$$

The main factors influencing NO_x formation are therefore, flame temperature, oxygen content in the reaction zone and the residence time in the high temperature zone of the flame. The

primary control measures for NO_x seek to generate those conditions least favourable for NO_x formation, i.e. to avoid the simultaneous presence of nitrogen and oxygen at high temperature. The main techniques to minimise thermal NO_x are summarised below.

Reduced air/fuel ratio

The leakage of air into the furnace, particularly around burner nozzles and through the batch material feeder can lead to increased NO_x levels. The burner block is relatively easy to seal and measures can be taken to avoid air ingress at the batch feed area. These measures are relatively cheap and quite effective. The NO_x reduction clearly depends on the starting level but can be up to 10 %.

Generally, furnaces operate with an excess of air of 5 - 10 % (e.g. 1 - 2 % excess oxygen) to ensure complete combustion. By reducing the air/fuel ratio to near stoichiometric levels significant NO_x reductions can be achieved, and the technique can also result in significant energy savings. To implement the technique effectively it will be necessary to monitor the NO, CO and O₂ levels in the waste gas. If combustion is sub stoichiometric carbon monoxide levels and refractory wear may increase, and the redox level of the glass may be altered thus affecting the glass quality.

This type of change must be implemented carefully and incrementally to avoid problems and to achieve the best results. In some cases (e.g. recuperative furnaces) if the stoichiometry of the furnace as a whole is considered, some burner positions may fire with excess fuel in the hottest parts of the furnace, and others with slightly excess air in cooler parts. Overall, the ratio will be close to stoichiometric. Depending on the starting position, emission reductions of up to 40 % can be achieved using these techniques.

The air levels in the furnace may be further reduced by using natural gas, high pressure or steam as an alternative to air for oil atomisation. This reduces oxygen levels and so reduces peak flame temperatures. Results with this technique have been mixed, with very little benefit seen in some applications.

Reduced combustion air temperature

The flame temperature can be reduced by reducing the combustion air preheat temperature. For example, the combustion air temperatures in recuperative furnaces are significantly lower than in regenerative furnaces, resulting in lower flame temperatures and lower NO_x concentrations. However, the lower preheat temperature results in a lower furnace efficiency (lower specific pull), lower fuel efficiency and thus higher fuel demand and potentially higher emissions (kg/tonne of glass) of NO_x, CO₂, oxides of sulphur, particulate, etc. Thus overall, this technique is unlikely to be of environmental benefit.

Staged combustion

If the fuel and air/oxygen are injected at the same place in the burner, a flame is produced with a hot oxidising primary zone close to the port and a cooler secondary zone further away. The majority of the NO_x is produced in the hottest zone. Therefore, by reducing the proportion of either the air or the fuel injected at the burner the maximum temperature and the NO_x formation are reduced. The remaining fuel or air is added later in the combustion zone.

Air staging involves firing sub-stoichiometrically and then adding the remaining air or oxygen into the furnace to complete combustion. There are several ways of achieving air or oxygen staging. First experiences by hot air staging have been problematic. The techniques of blowing air staging (BAS) and Oxygen-Enriched Air Staging (OEAS) are currently under development in the USA and are proposed by Combustion Tec. Around 10 furnaces are equipped with this system and claimed results are up to 70 % NO_x reduction.

Fuel staging is based on the following principle: a low impulse gas flame (around 10 % of the total energy) is developed in the port neck. This secondary flame will cover the root of the primary flame, reducing the oxygen content of the primary flame and its core temperature.

Therefore, NO_x formation is reduced. This technique has been more successful than air staging and is quite widely used. Emission reductions of up to 35 % can be achieved using this technique.

Flue gas recirculation

Waste gas from the furnace can be re-injected into the flame to reduce the oxygen content and therefore the temperature and the NO_x formation efficiency. Difficulties have been encountered with applying this technique in the Glass Industry at full-scale, and it is no longer thought to be in use. At the time of writing this technique is not considered to be technically proven in this application.

Low NO_x burners

This is a term used to cover a range of proprietary or glass company burner systems designed to minimise NO_x formation. These systems can vary in principle and can incorporate a range of features, including some of those described above and others listed below. Emissions reductions of around 30 % may be achieved using these optimised systems. Systems for gas firing will differ in some ways from those for oil firing. The main features of low NO_x burner systems are:

- Slower mixing of fuel and air to reduce peak flame temperatures (flame shaping).
- Minimum injection velocities commensurate with complete combustion.
- Higher emissivity flames, e.g. by promoting thermal cracking of gaseous fuels to give better emissivity and hence overall lower temperature flames.

Fuel choice

The general experience within the Glass Industry is that gas fired furnaces result in higher NO_x emissions than oil fired furnaces. For example, for a typically performing float glass furnace NO_x concentrations are given in Section 3.4.2.2 as 2500 mg/m³ for gas firing and 1800 mg/m³ for oil firing. The differences vary widely between furnace type and application but a variation of 25 - 40 % is not uncommon.

The main reason for this is that gas flames have a lower thermal emissivity than fuel oil flames, requiring higher flame temperatures to enable the same heat transfer to the glass melt and thus more favourable conditions for NO_x formation. However, as the industry has developed more experience with gas firing and furnace designs have changed, the difference in NO_x emissions and fuel requirements for the two fuels has reduced. In some applications (e.g. container glass) fuel efficiency and NO_x emissions progressively approaching those associated with fuel oil firing have been attained with gas by suitable flame adjustment. The nitrogen content of natural gas is generally negligible, but can vary from region to region, with a consequent effect on NO_x.

Environmental Performance

The indicative emission reductions that can be achieved using these techniques are given in the description for each technique. The effects of these techniques are not cumulative, as they are generally different ways of achieving the same broad objectives. Therefore, a 10 % reduction arising from one technique cannot simply be added to 10 % from a different technique. The overall emission reductions for optimised combustion systems vary widely from less than 10 % to greater than 70 %. For a furnace where little or no work has been done using these techniques, reductions in NO_x emissions of 40 - 60 % could be expected in most applications.

The actual emission levels achievable with these techniques will vary considerably depending on the starting point, the age and design of the furnace, and particularly on the rigour with which they are applied and monitored. A great deal can be achieved with relatively simple measures if they are properly applied. The Glass Industry has made substantial progress during the 1990's and a great deal of resource has been devoted to the work.

End-fired regenerative furnaces generally give lower NO_x emissions than cross-fired regenerative furnaces (see Section 4.2) and the techniques described in this section are generally more successful for end-fired furnaces. Emission levels of 700 - 1100 mg/m³ and 0.9 - 2 kg/tonne of glass have been achieved for cross fired furnaces. For end-fired furnaces of 650 - 800 mg/m³ and less than 1.5 kg/tonne of glass have been achieved. A limited number of figures have been reported below these levels, for certain applications.

Results on recuperative furnaces are more varied, but this may be due to the more variable use of these furnaces. Results comparable to (or sometimes lower than) regenerative furnaces have been achieved with container glass and continuous glass filament recuperative furnaces, but less success has been achieved in glass wool production.

Financial Considerations

The costs of combustion modifications are relatively low and can sometimes be off set by lower operating costs from energy savings. Low NO_x burner systems cost between 100000 and 550000 euros per furnace depending on size and type, and a further 65000 to 90000 euros can be added for monitoring and control systems. The costs for burners represent replacement costs not the additional costs, for a new furnace the extra costs would be very low. Air staged combustion systems can be substantially more expensive.

These primary techniques combined with formulation optimisation are in general very much cheaper than secondary abatement techniques. Comparative costs are discussed in Section 4.4.2.9.

Applicability

In principle (and subject to the limitations stated above), these techniques are applicable to all conventional fossil fuel fired furnaces. Most of the techniques can be applied to both existing and new furnaces. However, the benefits of some techniques (e.g. low NO_x burners) may only be fully realised when combined with the optimum furnace design and geometry, which can only be achieved for a new furnace or rebuild.

The success achieved with these techniques may also depend on the degree of operator expertise and scientific resource. To optimise the systems requires a sustained period of gradual experimentation and monitoring, and a high degree of technical expertise and experience. For those operators that do not possess these resources, specialist consultants offer services for furnace combustion modifications and optimisation. This development work of course adds to the costs of the techniques.

The degree to which these techniques can be applied will also vary depending on product and process requirements. For example, in some domestic glass production the product quality constraints demand a highly oxidised, very clear glass. This involves higher residence times, higher temperatures, and the use of oxidising agents, all of which contribute to higher NO_x emissions and limit the use of some of the techniques described above. This example is discussed further in Section 4.4.2.2 below.

Associated Considerations

Advantages:

- Low relative costs.
- Substantial reductions in NO_x emissions are achievable for most types of furnace.
- Applicable to new and existing furnaces.
- These techniques do not have any significant negative environmental aspects and can often result in significant energy savings.
- The lower furnace temperatures and energy use also result in lower overall emissions.

Disadvantages:

- Substantial expertise required to obtain the best results.
- Modified furnace design may be required to obtain the best results.
- Care must be taken to avoid glass quality problems due to redox changes.
- CO levels must be controlled to avoid refractory damage.
- The more reducing atmosphere can encourage SO₂ emissions.

Table 4.7: Main advantages and disadvantages of combustion modifications

4.4.2.2 Batch Formulation

Nitrates are used in glass manufacture as oxidising agents and also as fining agents. By far the most common nitrate used is sodium nitrate, but in some special glass applications potassium or barium nitrate are also used. Although sodium nitrate acts as a fining agent, its primary use is as an oxidising agent, and in most applications sodium sulphate would be the preferred fining agent. During the melting process the nitrates dissociate to form NO, NO₂, N₂, and O₂. The O₂ is used to oxidise the melt (particularly iron Fe²⁺ to Fe³⁺) to give a very clear glass, and to oxidise any organic components of the batch materials.

The use of nitrates varies widely between the different sectors of the Glass Industry. They are rarely used in flat glass or container glass, except to produce some very high quality, very colourless products or highly coloured glass e.g. grey or bronze glass. Nitrates are used in the Domestic Glass Sector for some high quality products, which require a high optical clarity and so low Fe²⁺ levels. Nitrates are widely used in the special glass sector for TV glass, borosilicate, ceramic and optical glasses. Electric furnaces producing very oxidised glasses, or where raw materials containing organic compounds are melted (e.g. glass wool waste) may also require nitrates as oxidising agents. In all an estimated 7 - 9 % of EU glass production involves the use of significant quantities of nitrates.

Typical quantities introduced are around 0.5 - 1 % of nitrate, i.e. 5 - 10 kg of NaNO₃ for 1 tonne of glass. For some processes e.g. TV glass this can be up to 4 % or even higher. During melting the main gases emitted are NO and O₂ with only low levels of N₂ and NO₂. For 1 % of nitrate introduced in the batch, the maximum NO_x emission is 5.4 kg/tonne of glass. This value is equivalent to approximately 2700 mg/Nm³ at 8 % O₂. The actual NO_x emission from nitrates varies from 30 % to 80 % of this maximum, with a typical value under industrial conditions of around 50 - 65 % (although the full range of values are frequently found).

The amount of NO emitted from nitrate depends on the heating rate, the redox state of the batch and the effect of reducing gases (reducing flames) contacting the nitrate containing batch blanket.

Effective alternatives to nitrates are limited by environmental and economic considerations. For example, sulphates can be used but the required quantity is much higher, more than three times, and SO₂ is emitted. Arsenic oxides can also be used but these are being phased out wherever practicable for environmental reasons. Cerium oxide can be used in some cases but is many

times more expensive than sodium nitrate. Some process modifications can also reduce the nitrate requirement, but these are generally prohibitive due to quality considerations, energy requirements, throughput restrictions or thermal NO_x generation.

In conclusion, the current opinion within the industry is that nitrate levels can be reduced by experimentation to the minimum commensurate with product and melting requirements, but due to economic and environmental reasons an effective alternative is not currently available.

In many Member States the legislation has allowed a doubling of the normal NO_x emission limit for glasses requiring nitrate addition. This approach is not generally considered to be commensurate with the objectives of Directive 96/61/EC. It makes no allowance for the wide variation in nitrate addition levels and provides little incentive to minimise nitrate usage. Furthermore, for processes adding only small amounts of nitrate the doubling of the emission limit can mask high thermal NO_x emissions and could reduce the incentive to optimise firing conditions.

The addition of nitrates cannot be considered as an isolated feature of the melting process. In general, glasses that require nitrate also have other specific constraints linked to their use. For example, the melting process for soda-lime glass tableware or luxury packaging differs from container glass production not only by the use of nitrates, but also by: residence time (at least 50 % longer); by the requirement for much more oxidising conditions in the melt and in the furnace; and by higher glass temperatures (between 50°C and 100°C higher). All of these issues contribute to higher NO_x emissions per unit of glass production, and can be up to 2 to 3 times higher than in container glass end-port fired regenerative furnaces.

The costs of the methods for reducing nitrate addition and the emission levels that can be achieved are very difficult to quantify, they depend greatly on the starting point and are very case specific.

4.4.2.3 Special Furnace Designs

The concern over NO_x emissions has led some furnace designers to propose recuperative type furnaces that integrate various features intended to permit lower flame temperatures and so lower NO_x levels. The best known of this type of furnace is the Sorg LoNO_x[®] melter. Another design by Sorg is the Flex[®] melter, which is generally intended for use in discontinuous applications and is understood to have comparable NO_x emissions to the LoNO_x[®] melter. A brief description of the Flex[®] melter is given in Chapter 2, but only the LoNO_x[®] melter is discussed in detail here.

Description of Technique

[Sorg LoNO_x], [tm19 5yrs LoNO_x]

The Sorg LoNO_x[®] melter uses a combination of shallow bath refining and raw material preheating to achieve reduced NO_x levels, potentially without the penalty of reduced thermal performance. The shallow bath refiner forces the important critical current path close to the surface of the glass bath, thereby reducing the temperature differential between it and the furnace superstructure. The furnace can be operated at lower temperatures than a comparable conventional furnace.

Combustion air preheating is recuperative and two-stage raw material preheating is used to compensate for the reduction in combustion air preheating compared to a regenerative furnace. The waste gases from the main burners are passed over the raw materials entering the furnace, in an extensive premelting zone, before entering the recuperators. On exiting the recuperators the waste gases are passed through an external cullet preheater, before finally leaving the system.

The LoNOx[®] melter is basically long and narrow and is divided into three parts. The first part is used to preheat, and then premelt the batch and cullet. Following this is the refining area, where the glass bath depth is reduced to 400 mm (or less). A deep refiner completes the tank.

The main heating is provided by gas or oil burners in the melting area. The waste gases are exhausted over the top of the batch and cullet in the first part of the furnace. The furnace is divided by internal walls to ensure that the raw materials entering the furnace are not directly heated by radiation from the hotter part of the furnace. Therefore, a high temperature differential is maintained between the raw materials and the gases and efficient heat transfer is achieved. A small amount of electric boosting may be provided to assist the maintenance of convection currents in the preheating area. This effect is aided by bubblers installed near the end of the melting zone.

The external cullet preheater is positioned after the recuperator and is an important part of the LoNOx[®] melter. It is a direct heating system, where the hot waste gases and the cullet to be heated are in contact with each other. The cullet and the waste gas flow counter currently. The cullet enters the tower construction at the top and slowly makes its way downward to the exit; the waste gases enter at the bottom and are exhausted at the top. The preheater has internal louver type vanes, which distribute the waste gases more evenly through the column of cullet. The cullet residence time in the preheater is around five hours. The waste gases enter the preheater at typically 500 °C and exit at typically 200 °C. The cullet preheat temperature is typically 400 °C.

Environmental Performance

Due to the lower operating temperatures, quite low NOx levels have been achieved. In [Sorg LoNOx] continuous emissions of between 420 - 440 mg/Nm³ are reported, which equates to less than 1kg NOx per tonne of glass melted. Lower emissions may be possible with increased operating experience and the application of combustion optimisation techniques.

Financial Considerations

In [tm6 NOxInd.duVerre] it is estimated that for a 350 tonnes/day container glass furnace the extra operating costs of this technique are negligible but the extra capital cost may be in the region of 1.8 million euros. No other information is currently available.

Applicability

The technique relies on significant raw material preheating which is difficult to achieve without high cullet levels. These furnaces are only really viable when high levels of cullet are used i.e. greater than 70 %. Therefore, at the time of writing this implies the technique is only applicable to the Container Glass Sector and to those furnaces with >70 % cullet. The technique can only be applied at a full rebuild. The dimensions of the tank (long and narrow) may also limit the applicability where there are space restrictions.

Associated Considerations

The technique can achieve good melting efficiencies, figures of approximately 3.3 GJ/tonne of glass melted were reported [tm19 5yrs LoNOx] for a cullet ratio of 90 - 95 % and electrical boost of 3 %. This figure compares favourably with modern regenerative furnaces.

Due to the low glass depths an inherent feature of the design is that it is a long narrow furnace, and the area of the furnace can be significantly greater than a conventional design, for a specified pull rate. This increases the space requirements and may increase the capital cost for the furnace.

In container glass production it can be difficult to produce amber glass with high levels of mixed cullet. Partly due to the low glass depth this technique is relatively efficient in this respect and amber glass has been produced with up to 95 % cullet with high quantities of colour mixed cullet.

As with all cullet preheating systems there is the potential for emissions of organic species, including odorous substances and potentially dioxins/furans. Measurements have shown dioxin emissions are below 0.1 ng/Nm³ TEQ. These issues are discussed further in Section 4.8.

Example Installations

Gerresheimer Glas, Budenheim, Germany – Container Glass.

Wiegand & Söhne, Steinbach am Wald, Germany – Container Glass.

4.4.2.4 The FENIX process.

Description of Technique

The FENIX process is based on the combination of a number of primary measures for the optimisation of combustion and the reduction of energy consumption. In common with the techniques described in Section 4.4.2.1, the optimisation of combustion for FENIX relates to:

- the reduction of excess air without giving rise to glass quality problems or carbon monoxide emissions;
- the suppression of hot spots and the homogenisation of flame temperatures; and
- controlled mixing of the fuel and combustion air.

However, the FENIX process also involves a complete modification of the combustion system and particularly the use of a new type of injectors. These modifications are the subject of a patent application. The technique also includes a review of the furnace control system and the installation of methods of monitoring certain furnace parameters. In particular, oxygen probes are installed at the top of the regenerator chambers to provide better control of excess air levels.

The main characteristics of the modifications to the combustion system are described in the patent application [tm36 FENIXpat], and are summarised below.

Temperature peaks are limited by the maintenance of the flame length while increasing the flame volume. The staging of combustion is achieved by control of the supply of fuel and oxidant to stagger the contact and/or increase the flame volume. A 100 % oxygen flame may be used at the hottest level of the furnace. The staggering of the contact is also partly achieved by the use of an inert “buffer” gas on at least one injector. The inert gas can be CO₂ or recycled flue gas and is injected between the main fuel and oxidant supplies. This pushes the development of the flame towards the centre of the furnace and promotes a wider more even flame of greater volume.

The contact between the oxidant and fuel can also be retarded by a secondary fuel injector(s) positioned in or close to the air inlet opening above the injectors of the main fuel supply. The technique can also include the use of air injectors or oxygen lances at various locations to maintain an oxidising atmosphere above the glass without overall excess air. These devices can also be used to help control the combustion. A very important aspect of the technique is the design of the burner, details of which are considered confidential.

Environmental Performance

The FENIX process is a relatively new technique and has only been fully developed on one furnace, the Saint-Gobain float glass line in Aniche, France. Results from this plant are reported

in [tm24 FENIX]. The NO_x concentration has been reduced from 1600 mg/m³ to 580 mg/m³, a reduction of 63 %. The mass of NO_x per tonne of glass melted has been reduced from 4 kg/tonne to 1.25 kg/tonne, a reduction of 68 %. The implementation of the technique also resulted in an energy saving of around 6 % (5.76GJ/tonne to 5.4 GJ/tonne with 21 % cullet).

Following the publication of [tm24 FENIX] it has been confirmed that NO_x emission levels of 510 mg/m³ and 1.1kg/tonne of glass melted are being consistently achieved at the Aniche plant.

Financial Considerations

Due to the energy savings experienced the technique actually results in an overall cost saving. However, there is an initial capital outlay but the return on investment is quite short, usually less than two years. The capital costs comprise the new burners and the improved control systems (approximately 700000 Euros). For a new plant or rebuild requiring new burners and a fresh control system the extra costs would be very low. Consideration would also have to be given to any license fee and the time and expertise required to implement the technique.

Applicability

At the time of writing the technique has only been applied to one cross-fired regenerative float glass furnace (600 tonnes/day) fired on heavy fuel oil with sulphur content less than 1 %. However, the developers of the technique state that in principle it can be applied to any cross fired furnace, although modifications are necessary for gas firing.

The technique is currently in the course of being applied to other furnaces in the group including a gas-fired furnace. For each furnace the technique requires careful application by a specialised team. Saint-Gobain have stated that they are ready to grant a non-exclusive license under FENIX technology to other glassmakers, provided that an agreement can be reached on the conditions of such license.

Associated Considerations

At the time of writing, this technique has only been applied to one process, although it seems it is more widely applicable and could be considered to be technically proven. However, as with all primary measures the results may differ from application to application. It cannot automatically be assumed that the results achieved at Aniche can be achieved in all cases. Results in other applications would be expected to be comparable but may be better or worse depending on local circumstances.

The main issue concerning this technique is whether it can be considered available and accessible to all processes where it could be applicable. The implementation of the technique is a specialised and time consuming process. Saint-Gobain have stated their readiness to license the technology, but there still remains the question of whether the existing expertise is sufficient to permit the widespread implementation of the technique within the medium term.

Example Installations

Saint-Gobain Vitrage, Aniche, France – Float Glass.

4.4.2.5 Oxy-Fuel Melting

Description of Technique

Oxy-fuel melting involves the replacement of the combustion air with oxygen (>90 % purity). The technique can be used with either natural gas or oil as the fuel, although the use of gas is

more common. The elimination of the majority of the nitrogen from the combustion atmosphere reduces the volume of the waste gases (composed mainly of CO₂ and water vapour) by 70 - 85 % depending on oxygen purity. In general, oxy-fuel furnaces have the same basic design as recuperative melters, with multiple lateral burners and a single waste gas exhaust port. In the most modern furnaces the geometry is optimised for oxy-fuel firing and NO_x minimisation. Furnaces designed for oxygen combustion do not currently utilise heat recovery systems to pre-heat the oxygen supply to the burners, due to safety concerns.

The technique potentially involves substantial energy savings, because it is not necessary to heat the atmospheric nitrogen to the temperature of the flames. Less gas has to be heated and so less energy is lost from the furnace. The extent of the energy savings depends greatly on the furnace with which it is being compared. This complex issue is discussed later in this section.

The formation of thermal NO_x is greatly reduced because the main source of nitrogen in the furnace is very much lower, although some nitrogen is still present in the combustion atmosphere. This is derived from the residual nitrogen in the oxygen (VSA/PSA 4 - 6 %, cryogenic <0.5 %), nitrogen in the fuel (natural gas 2 - 15 %), nitrogen from nitrate breakdown, and from any parasitic air. Due to the high flame temperatures any N₂ present is more readily converted to NO_x, and even low levels of N₂ can prove quite significant. It is therefore important to minimise air ingress into the furnace.

The furnace waste gas temperature can be very high 1200 - 1300°C and will usually require cooling. Due to the high water content and concentration of corrosive species (e.g. chlorides and sulphates) cooling is usually by dilution with air. Following dilution, waste gas volumes are generally in the region of 70 - 150 % of conventional furnace waste gas volumes depending on the degree of dilution necessary.

Oxy-fuel melting requires different burner designs than those found in conventional air-gas firing. Since the introduction of the technique, the burner systems have undergone substantial development, from early modifications of existing designs for other oxy-fuel applications to the current highly specialised low NO_x oxy-fuel burners developed specifically for glass making. These systems can feature some of the characteristics of other low NO_x high efficiency burners for conventional firing. Some of the important features of the main proprietary systems are summarised below.

- Burners with longer, wider flames with better luminosity giving deeper and more uniform heat transfer.
- Flatter flames with wider coverage.
- Delayed mixing of fuel and oxygen to reduce peak flame temperatures in the O₂ rich zone.
- No water cooling.
- Flame adjustability for momentum and shaping.
- Multi-fuel use.

The oxygen required for combustion can be supplied either by delivery to the site or by on-site production. Except for very small applications (e.g. some frit plants) the amounts of oxygen required usually make it more economical to produce the oxygen on-site. However, if a site is situated close to an industrial oxygen pipeline it is usually more cost effective to obtain the oxygen directly from the pipeline. There are two main techniques for producing oxygen on-site, cryogenically or via an absorber system. The oxygen plant is usually owned and operated by the supplier who makes a charge for the oxygen supplied, although some operators will choose to have complete ownership of the oxygen plant. On-site oxygen plants are always provided with back up storage of liquid oxygen.

Oxygen is produced cryogenically by compressing air and passing it through a purification unit to remove dust, water, carbon dioxide and trace contaminants. The purified air is then cooled and passed through a low temperature distillation column where the separation takes place. The

separated gases can be warmed in heat exchangers to provide gaseous oxygen and nitrogen, and if required, liquid oxygen can be taken from the colder parts of the system.

The absorption process usually takes one of two forms vacuum swing absorption (VSA) or pressure swing absorption (PSA). Both of these are non-cryogenic systems and the separation takes place around ambient temperatures. The technique is usually much cheaper than a cryogenic system, but has limited capacity and is usually chosen for medium level oxygen demands. Most sites supplying only one or two glass furnaces would opt for this technique. For multiple furnaces or for furnaces with high O₂ demand (e.g. float glass) a cryogenic system may be preferred. The choice depends mainly on economic factors, which can be influenced by local conditions.

Compressed air enters the bottom of one of two absorber vessels filled with zeolite, which absorbs most of the nitrogen. The oxygen is withdrawn from the top of the vessel until the zeolite becomes saturated with nitrogen. The air stream is then directed to the second vessel whilst the nitrogen in the first vessel is discharged to atmosphere. In the vacuum system the nitrogen is removed by vacuum and in the pressure system it is vented under pressure. The vacuum system usually gives the highest efficiencies.

The technique of partial oxy-fuel heating has been in use in glass making for many years. Two different techniques have been tested: oxygen lancing which was an additional injection of O₂ in a conventional air-fuel furnace in order to improve the heat transfer; or the addition of a pure oxy-fuel burner. The technique was used mainly to solve glass quality and furnace pull problems by positioning very hot flames accurately on the melt surface, in order to increase temperature gradients and consequently to enhance the convective currents inside the melt. This also reduced the flow of waste gas feeding the same energy to the system. The technique was often used to extend the operating life of a furnace that was showing signs of deterioration or regenerator problems. The technique is still used in these ways today but the use is less common due to the problems of potentially increased NO_x emissions arising from the high temperatures.

Environmental Performance

Compared to air-fuel fired furnaces NO_x emissions are generally reduced by 70 - 90 %. This figure clearly depends on the point of comparison and can be higher than 95 % and lower than 60 %. For fibre and container glass furnaces this normally equates to <1 kg/tonne of glass melted. For special glass (without nitrate addition) the figure may be 1 - 2 kg/tonne of glass melted [tm32 Beerkens]. The latest versions of oxy-fuel burners combined with optimised furnace design and operation can in some cases reduce emissions to 0.3 - 0.8 kg NO_x/tonne of glass melted. No information is available for emissions from flat glass, but emissions of 0.5 - 1.5 kg/tonne of glass melted are considered likely.

Concentrations of all pollutants may actually be higher due to the reduced gas volume. Correction to 8 % oxygen is not particularly meaningful for oxy-fuel furnaces, although the dilution with cooling air usually brings the concentrations closer to more normal levels.

Oxy-fuel firing can also help to reduce overall emissions of volatile materials from the furnace (particulates, fluorides, chlorides etc.), due to reduced gas flow over the melt and in some cases reduced turbulence. Particulate emissions in soda-lime glass can be reduced to 0.2 - 0.3 kg/tonne of glass melted, although this is not seen in all applications [tm18 CPIV]. Particulate emissions are most effectively reduced for boron containing glasses (up to 50 %). In the USA the motivation for conversion to oxy-fuel melting has in several cases been particulate reduction rather than NO_x reduction. Reduction in fuel usage will also lead to lower SO₂ emissions for oil fired furnaces, and emissions of CO₂ are also reduced in proportion to any energy saving.

Financial Considerations

The financial aspects of oxy-fuel melting can vary very greatly between the different sectors and from case to case. The costs are very difficult to predict, but some indicative figures are given in Section 4.4.2.9. The main factors affecting costs are:

- The capital cost compared to the most likely alternative.
- The energy savings that can be achieved (very dependent on furnace size and design).
- The prevailing cost of oxygen for that installation.
- The potential effect on campaign length and the financial risk that entails.

An important factor in the capital cost is that oxy-fuel furnaces do not have a conventional combustion gas preheat system and so the capital cost is generally lower than for a regenerative or recuperative furnace of comparable pull-rate. This is most evident for new plants where the total cost of the preheating system is saved. The most advanced oxy-fuel burners are generally more expensive than advanced low NO_x burners and the costs of the oxygen control system are quite substantial (0.3 - 0.45 million euros). However, for most furnaces the extra costs of the oxy-fuel burners and control system are significantly lower than the savings for the preheater. Concerns over the effect of the technique on refractory life may lead to the use of more expensive materials for the furnace crown. If necessary, this extra cost could reduce the capital advantage significantly. In the frit industry preheater systems are less common, but the extra capital costs are generally paid back within two years by the substantial energy savings [tm8 S23.03].

For regenerative furnaces the regenerator systems can date back to the first furnace built in that position, and they will be repaired, up graded or replaced as necessary with each furnace rebuild. Therefore, although there is a significant saving it may not be as great as for a new plant. With recuperative furnaces the recuperator is usually replaced with each furnace rebuild, but the supporting framework may be reused if the furnace design and position are largely unchanged. The capital saving for new plants are in the region of 20 % for recuperative furnaces and 30 - 40 % for regenerative furnaces.

If the supplier operates the oxygen plant the capital cost is generally included in the oxygen charge and is not considered separately. The housing of the oxygen facility is usually provided by the glass company, but the cost is quite low. If the glass company chooses to operate the oxygen plant independently the capital cost may be up to 10 % of the furnace cost [tm29 Infomil]. If the nitrogen by-product from oxygen generation can be used or sold then it may contribute to reducing the overall costs.

Several documents in the Glass Industry literature [e.g. tm3 EPA, tm6 NO_x Ind.duVerre] quote the costs of oxy-fuel firing as greater than or equal to SCR. However, this has not always been reflected in practice with some operators reporting cost neutral conversions or in some cases savings on operating costs. Most of the positive results are from conversions of smaller non-regenerative furnaces that do not use high levels of cullet.

Excluding concerns over refractory life, in most applications the determining factor regarding the cost effectiveness of oxy-fuel firing will be the difference between the energy savings and the costs of the oxygen, compared with the costs of alternative NO_x abatement techniques. This is case specific and for many smaller furnaces the balance will be beneficial. However, for larger furnaces the savings are generally lower and the financial balance will depend much more on the specific circumstances, and other factors (particularly the annualised capital cost) will become more important. The prevailing energy and particularly the oxygen costs (both of which are subject to variation) are also clearly important.

Applicability

Although the principle of 100 % oxy-fuel melting is well established, particularly in the frits sector, its use in the glass industry as a whole has been limited by a number of factors. The technique is still considered by some sectors of the glass industry, as a developing technology with potentially high financial risk. However, considerable development work is being undertaken and the number of plants and the level of operating experience are increasing.

In general, it is beneficial to delay installation until the next furnace rebuild to maximise potential benefits and to avoid any anticipated operating problems. In principle, oxy-gas burners could be installed in many processes without waiting until a cold repair. Hot installation may lead to energy savings and to an increased pull rate. However, it is unlikely to result in lower NO_x emissions and may actually increase NO_x levels, also there is a danger of accelerated refractory wear.

It is estimated that 5 - 10 % of the world's glass production is made with oxy-fuel melting, but this figure varies between the sectors. There is only one float glass line in operation in USA. In Europe, according to [tm17 Ercole], 5.3 % of the glass container production is produced by oxy-firing. For glass fibre (glass wool and continuous filament) and for special glass the figures are 27.5 % and 48.5 % respectively. Estimations made by the French oxygen producer Air Liquide, indicate that of the total glass production made by oxy-fuel, 25 % is produced in Europe and 56 % in North America.

There are several examples of oxy-fuel melters operating successfully in the following sectors: container glass, glass wool, special glass (particularly TV glass), continuous filament glass fibre, and frits [tm32 Beerkens]. Trials have been carried out in the domestic glass sector resulting in good NO_x reduction, but problems occurred with severe foaming. This did not affect glass quality in this example because the trial was with a glass formulation less sensitive to these factors. The problems encountered in domestic glass production are similar to those initially encountered in other applications e.g. container glass. Similar solutions are likely to be possible but the higher quality requirements make them more difficult to apply. There are several examples of the technique operating successfully for domestic glass production worldwide. For example:

Orrefors Kosta Boda, Sweden - < 5 tonnes /day crystal glass

Verrerie de La Rochère, France – 17 tonnes/day soda-lime

St George Crystal, USA – 32 tonnes/day lead crystal

Nachtman, Germany – 9 tonnes/day lead crystal

The only known application in the Flat Glass Sector is the recent conversion of the Pilkington LOF line in Ohio. It is understood that a further float plant in the USA is planned for conversion. One of the main problems with the use of oxy-fuel melting in flat glass is that it is not yet a fully proven technique in this application, either technically or economically. There are no fundamental technical barriers to its application but there are a number of serious reservations. The main concern is the possibility of high refractory wear and a reduced campaign length or the need for an expensive repair. The very high capital investments and high quality requirements for flat glass make the risks higher than in some other sectors. Also the high thermal efficiencies achieved in the sector mean that the potential energy savings are much lower.

The sector had generally taken the view that if necessary other NO_x reduction techniques were available, and so the benefits did not justify the risks of being the first to implement the technique. There are a number of site-specific issues at Pilkington LOF that make the technique potentially more cost effective. These issues combined with the current state of developments and the desire to know how the technique performs have led the company to make the decision to implement the technique. No results are currently available.

Associated Considerations

One of the most important issues related to this technique is the potential energy saving that can be achieved. As mentioned above this can often be the deciding factor in the economic viability of the technique in a particular application. In considering the cost effectiveness of the technique it must be compared not just with the furnace it replaces, but with all the available options and alternative abatement measures.

Energy savings can be greater than 50 % on small thermally inefficient furnaces (e.g. frit furnaces). For a medium sized recuperative furnace with no specialised energy saving measures, standard levels of insulation, and using only internal cullet the energy use with oxy-fuel melting would be in the region of 20 - 50 % lower. However, for large energy efficient regenerative furnaces with optimised thermal performance the savings are much lower (5 - 15 % - BOC plc) and potentially close to zero. In these cases the savings in energy would be less likely to compensate for the cost of the oxygen. Each case is unique and must be considered with regard to its individual circumstances.

The energy saving measures available for conventional furnaces (e.g. waste heat boilers, higher levels of insulation, high efficiency burners, and cullet preheating) have not been as widely applied for oxy-fuel furnaces. There is some experience with these techniques; and at the time of writing it is understood that there are at least two furnaces fitted with waste heat boilers and one with cullet preheating. However, as experience grows more of these measures may be used in conjunction with oxy-fuel firing. There are no technical reasons why most of these techniques could not be used with oxy-fuel firing, but there are important technical issues that must be addressed and would take time to resolve (e.g. the optimal level of insulation possible without compromising refractory life).

A particular issue that could improve the economics of oxy-fuel melting is the recovery of heat from the waste gases. The high temperature of the waste gases improves the potential for heat recovery, but there are also a number of difficulties. The waste gases require cooling prior to any waste gas treatment, in order to reach the operating temperature of the abatement equipment and to ensure that any particulate matter that will derive from volatile materials has been condensed. The nature of the waste gases from many furnaces limits the use of direct heat exchangers due to problems of fouling by condensed particulates and corrosion. These problems are increased by high waste gas concentrations associated with oxy-fuel firing. A particular problem exists in boron containing glasses, where the gases have to be cooled quickly to prevent the formation of sticky solids which are corrosive and readily cause fouling in ducting and abatement equipment such as electrostatic precipitators. For these reasons cooling tends to be carried out by dilution with air.

Potentially the most promising way of recovering heat from the waste gases of container glass oxy-fuel furnaces could be the use of a batch and cullet preheating system (see Section 4.8). Initial trials have also been carried out with preheating the oxygen supply. The options for heat recovery from oxy-fuel furnaces are discussed in [tm45 Illy]. Some development work has been done on preheating gas and oxygen supplies, but this has not been developed at full scale and cannot be considered as available.

When considering the overall environmental impact of oxy-fuel melting consideration should be given to the environmental impact of oxygen production. This is extremely difficult to calculate and will vary greatly from case to case. The environmental impact of oxygen production relates mainly to the emissions associated with the generation of the electricity consumed. This is almost impossible to assess except for a specific case where (amongst other things) the oxygen consumption, the method of oxygen production, the national statistics for average emissions from electricity production, and the energy saving in that application can be derived. On average oxygen production by VSA consumes approximately 1.44 MJ/Nm³ [private communication BOC].

In general, it can be said that if the energy savings from oxy-fuel melting outweigh the costs of the oxygen production then the reduced emissions will significantly outweigh the emissions associated with the oxygen production. In recuperative furnaces without additional energy recovery (waste heat boiler or cullet preheating) the average energy saving including oxygen production will be 25 - 35 %, and for large regenerative furnaces 5 - 15 %. For highly efficient regenerative furnaces this figure can be less than 5 %. As with all abatement measures that require energy the environmental benefits seen on-site are partially eroded when the global view is taken.

Oxy-fuel melting involves higher flame temperatures, which in some applications can lead to higher pull rates per square meter of furnace size (up to 25 % increase). This is particularly important where there is a desire to increase the capacity of a furnace, but where space is not available to accommodate a conventional furnace of the desired size. This situation is aided further by the absence of the preheating system. In some applications the technique can also lead to better process control and improved glass quality. This is particularly so for some special glass processes that require high melting temperatures. However, the higher levels of oxygen and water vapour may affect the glass chemistry for some glass types, requiring changes to the batch composition.

There is concern that the higher temperatures associated with the technique can result in higher refractory wear and therefore shorten furnace lifetimes. In some cases it may also lead to a higher level of glass defects (e.g. due to crown dripping). Reduced campaign lengths can have a very important financial impact on a plant particularly for larger furnaces such as in float glass. Experience to date varies from application to application varying from poor to very promising. A great deal of work has been done in this area and the problem can be reduced greatly. Some borosilicate producers report extended furnace lifetimes, and in some applications lower crown temperatures have been experienced following conversion.

The new high emissivity burner systems are much more effective at transferring heat into the glass. Combined with careful design of the furnace, careful burner positioning and higher quality refractories these burners make it easier to maintain operation within the thermal resistance limit of the refractories. The use of higher quality refractory materials can add to the capital cost of the furnace and there remain concerns that they may not be sufficiently resistant in all applications. In soda-lime glass the high vapour pressure of water can cause high NaOH vapour pressures, which can contribute to refractory wear particularly above the glass level.

At the time of writing the oldest oxy-fuel furnaces are less than ten years old and in general, there is insufficient experience with the technique in large glass furnaces to be confident of the long-term effect on furnace lifetimes. However, the technique is under constant development and furnaces designed using the latest techniques are likely to have greater campaign lengths than the earlier furnaces. In some applications problems with batch foaming have been reported. This can cause quality problems and reduce the efficiency and stability of heating.

In glass wool manufacture the high oxygen levels in the furnace can make it easier to recycle wastes containing organic materials without the use of nitrates.

The high concentration of water vapour in the atmosphere of the furnace created by oxy-fuel firing may give rise to an important advantage for the technique. In [tm17 Ercole] it is reported that if a way can be found to optimise the chemical absorption of water during melting, very favourable changes in the glass structure may result. The changes resulting from the reaction with the water vapour can reduce the viscosity of the glass at all temperatures and result in more favourable heat transmission from the flame to the melt. It may also make cooling during forming much easier, which can be particularly important for container glass and domestic glass.

Example Installations

- Owens Corning Building Products (UK) Ltd, Cwmbran, UK – Glass Wool.
- Schott Glas, Mainz, Germany – Special Glass.
- Pilkington-LOF, Ohio, USA – Float Glass.
- Heye Glas, Moerdijk, Netherlands – Container Glass.
- PPG Industries, Hoogezand, Netherlands – Continuous Filaments.
- James Kent Ltd, Stoke on Trent, UK - Frit.
- Saint Gobain Desjonquieres, Mers, France – Container Glass.

Summary

Due to the complexity of the issues surrounding this technique it is considered useful to have a concluding summary.

<p><u>Advantages</u></p> <ul style="list-style-type: none">• Substantial reductions in NOx emissions can be achieved (70 - 90 %).• Capital costs for furnaces are usually significantly lower.• In some applications the technique is cost neutral or results in savings.• Substantial reductions in energy consumption are possible in some applications (particularly where a recuperative furnace is replaced).• Potentially lower emissions of volatile substances and dust.• Where waste gas volumes are reduced this can lead to lower capital costs for abatement equipment.• Potentially improved production/m² and improved process control. <p><u>Disadvantages</u></p> <ul style="list-style-type: none">• If substantial energy savings are not realised the technique can be very expensive, especially for large soda-lime furnaces.• The cost effectiveness varies greatly between applications and must be assessed individually.• There have been problems with refractory wear, which have not been fully resolved.• The generation of oxygen requires electrical energy.• The technique is essentially a primary measure in that it reduces NOx formation, but does nothing to reduce NOx from non-thermal sources e.g. batch nitrates.• The technique is most effectively installed at a furnace rebuild.• The storage, generation and use of oxygen have inherent risks and appropriate safety considerations are necessary.• Oxygen generation can give rise to noise that must be controlled.
--

Table 4.8: Main advantages and disadvantages of oxy-fuel melting

Oxy-fuel melting can be a very effective technique for NOx abatement, and with the exception of flat glass, and to a lesser extent domestic glass, the technique can be considered to be technically proven. In principle, oxy-fuel melting can be considered as applicable to the Glass Industry as a whole, but the problems of the implementation should not be underestimated.

There are still some important unanswered questions concerning the effect on the lifetime of furnace refractory materials. It seems likely that solutions will be found to this problem, but it will take some time to prove the long-term effects with confidence. Until this is achieved there will be a degree of financial risk associated with the technique.

The economic competitiveness of the technique depends mainly on the potential for energy savings, and on the relative costs of alternative techniques for achieving comparable NOx emission levels. In many applications that require small to medium sized furnaces, significant energy savings can be realised, which makes the technique more competitive. Indeed in some applications (particularly furnaces <50 tonnes per day) the energy savings alone may be sufficient motivation to install the technique. Larger furnaces tend to be inherently more energy efficient and the potential reductions in energy consumption are much less, which increases the

overall cost of the technique. In a number of applications the savings are unlikely to outweigh the costs and the technique may not represent the most cost-effective way of achieving NO_x reductions.

The improvements in the performance of other NO_x abatement techniques (particularly primary techniques and 3R), combined with the advances in furnace energy efficiency are eroding the competitiveness of oxy-fuel melting. However, in applications where these developments have not been so great or where other factors limit their application (e.g. glass wool and special glass), oxy-fuel melting is potentially a very attractive technique.

The relative merits of oxy-fuel melting vary greatly from case to case and the decision to implement the technique can be greatly affected by other factors. For example, if an increase in pull rate is required without an increase in the size of the furnace, or if the plant is located close to a cheap source of oxygen. The economics can be affected to such a degree by site-specific factors that each case must be considered on its individual circumstances.

Developments that may improve the performance of oxy-gas firing still further are continuing, and oxygen companies are continuing developments to reduce the costs of on-site oxygen production.

Oxy-fuel melting should be considered as one of a suite of effective NO_x abatement measures, that depending on the site-specific issues might represent the most appropriate approach. It should, however, be recognised as one of the instrumental techniques in determining the emission levels that represent BAT in the Glass Industry.

4.4.2.6 Chemical Reduction by Fuel (CRF)

Chemical reduction by fuel describes those techniques where fuel is added to the waste gas stream to chemically reduce NO_x to N₂ through a series of reactions. The fuel does not burn but pyrolyses to form radicals, which react with the components of the waste gas. The two main techniques that have been developed for use in the Glass Industry are the 3R process and the Reburn process. Both of these techniques are currently restricted to regenerative furnaces. The 3R process has been fully developed for application within the industry and at the time of writing the Reburn process is undergoing a second phase of full scale development trials, and has shown promising results.

4.4.2.6.1 The 3R Process

Description of Technique

The basis of the 3R process is the addition of a hydrocarbon fuel (e.g. natural gas or oil) in a controlled manner to the waste gas stream at the regenerator entrance. This fuel does not burn but dissociates and acts to chemically reduce the NO_x formed in the furnace. The technology is designed for use in regenerative furnaces, where the regenerator provides the necessary conditions of temperature, turbulent mixing and residence time for the reactions to proceed. The process name “3R” relates to Reaction and Reduction in Regenerators.

There are two main stages involved in the 3R process, deNO_x and burnout. In the deNO_x stage there are two principle mechanisms, the first involving the reaction between 3R fuel radicals and NO. The radicals (CH_x) are formed mainly by thermal decomposition (pyrolysis) which occurs very quickly as the fuel enters the regenerator. The main reactions occurring at this stage are:

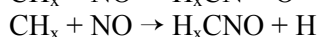
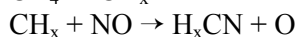
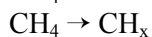
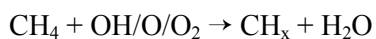

These reactions are very rapid and take place mainly in the upper regenerator chamber. They account for around 25 % of the NO_x reduction.

The second mechanism occurs as the waste gases pass down through the regenerator checkerwork, where the residence time is relatively long. The CO and H₂ (formed from primary and 3R fuels) have adequate time at a high enough temperature to reduce the majority of the remaining NO to N₂. This reaction takes place throughout the regenerator system, but predominantly in the checkerwork and accounts for the majority of the NO_x reduction achieved by 3R. The main reactions are:

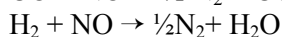
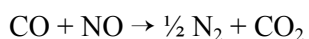

The second stage of the process involves the burnout of reduced species, mainly unreacted CO and H₂. These species are oxidised by the controlled supply of air into the flues below the regenerator. The main reactions are given below.

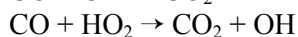
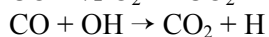
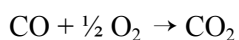

Environmental Performance

The degree of NO_x reduction achieved with 3R depends mainly on the amount of extra fuel added, and can be tailored to meet various emission standards. The technique can achieve concentrations below 500 mg/Nm³ at 8 % O₂ dry volume, in some applications figures close to 400 mg/Nm³ have been achieved. Depending on the application this equates to 1.0 - 1.5 kg/tonne of glass melted, and an overall NO_x reduction in the range 70 - 85 %.

Financial Considerations

Capital costs are quoted as up to 300000 euros but are generally significantly lower than this. At optimised melting conditions operating costs to achieve 500 mg/Nm³ are 1.5 - 2.0 euros per tonne of glass melted, due mainly the fuel requirement and equating to approximately 350 euros per tonne of NO_x abated. To these costs should be added the cost of licensing the technology. The license fee formula is quite complex, but over the lifetime of the licence typically equates to about 0.5 euros per tonne of glass melted.

Applicability

The technique is only currently considered applicable to regenerative furnaces, but is applicable to both new and existing plants and to furnaces firing on either oil or natural gas. There are seven furnaces currently operating the technique and many more glass plants are licensed to use it. The main reason the technique is not more widely operated, is that current plant NO_x emissions using primary reduction methods are generally within the existing legislative limits.

There is a concern that the reducing atmosphere created in the regenerators could damage some types of refractory materials, particularly if higher temperatures are also experienced. Most experience with the technique has been gained with float glass furnaces, which tend to use high quality refractory materials in the regenerators. The likelihood of refractory damage is greater with lower quality refractories (e.g. those containing Ca, Fe and Cr) which are found in some container glass plants. This is very case specific but the replacement of existing refractories with materials of higher thermal and chemical resistance could involve substantial costs.

The developers of the technique anticipate that regenerator repairs will not be necessary in the vast majority of cases. Section 4.4.2.9 shows costs at the limits of the likely ranges with and without regenerator repairs.

Associated Considerations

The main drawbacks with 3R are that the use of hydrocarbon fuels to achieve the necessary NO_x reduction involves an inherent cost and leads to an increase in CO₂ emissions. This means it is attractive to combine 3R with more conventional primary NO_x reduction measures in order to reduce the 3R fuel requirement.

If a waste heat boiler is installed most of the energy in the 3R fuel can be recovered and the overall CO₂ increase will be minimal. The use of 3R does not necessarily imply that a waste heat boiler would be cost effective overall, but where one is already installed (or intended to be installed) 3R results in a beneficial increase in the furnace load range over which the boiler can be utilised. Overall this may lead to a substantial saving in the site energy requirements, and the use of other energy sources (e.g. fossil fuel boilers) can be greatly reduced. Depending on the specific application this energy saving means that the 3R process can give rise to significant cost savings (one example [tm39 3R-update] quotes around 600000 euros/year).

With no waste heat recovery on the plant, the extra fuel required is generally around 7 % of the melting energy. This would result in an increased CO₂ emission of 20 - 30 kg per tonne of glass melted or 4 - 6 tonnes per tonne of NO_x abated. In practice, the precise fuel requirement to achieve the desired NO_x reduction may vary depending on the specific conditions of the furnace. For example, if oxidising conditions are required in the furnace the fuel usage will be higher than when more reducing conditions exist.

Although 3R is sometimes considered a primary technique because of its relative simplicity, it shares an important characteristic of secondary techniques such as SCR and SNCR in that it not only reduces thermal NO_x, but also NO_x from other sources, such as raw materials.

Advantages

- Can achieve substantial NO_x reductions.
- Applicable to most types of regenerative furnace.
- No major changes to plant design or operation.
- Low capital costs.
- Can be applied without the need for a furnace shut down.
- No chemical reagents required.
- Increased fuel usage can in some cases be compensated by waste heat recovery.
- Can be considered as proven and available technology.
- Reduces NO_x from all sources.

Disadvantages

- Increased fuel usage (generally 7 %, but can be reduced with waste heat recovery).
- Increased CO₂ emissions (20 - 30 kg/t glass melted, but can be reduced with waste heat recovery).
- Concern over effect on regenerator refractory material in some applications.
- Not applicable to non-regenerative furnaces.

Table 4.9: The main advantages and disadvantages of the 3R Process

Example Installations

Pilkington UK Ltd, Greengate Works, St Helens, UK.
 Flachglas AG, Weiherhammer, Bavaria, Germany.
 Flachglas AG, Gladbeck, Nordrhein-Westphalia, Germany.

Pilkington Finland
Pilkington LOF, Ohio, California
Samsung Corning, Korea
(All Float Glass Installations except Samsung Corning which is TV Glass)

4.4.2.6.2 Reburning

[tm53 Gas Reburning], [tm54 Gas Reburning2], [tm55 Field Test], and [tm56 GazdeFrance]

Description of Technique

Reburning is a combustion modification technology removing NO_x from combustion products by using fuel as a reducing agent. It can be used to control emissions from virtually any continuous emission source, and is not fuel specific although natural gas is generally used.

The technique was originally applied to large boiler plant in the early 1980's and is based on the principle that pyrolysed CH fuel radicals will react to reduce NO species to N₂ through a series of reactions. Reburning technology has been successfully demonstrated on utility boilers, typically achieving NO_x removal efficiencies between 50 % - 65 % at a moderate cost per tonne of NO_x abated.

These achievements led to consideration of reburning for use in the Glass Industry. Glass furnaces appeared to be good candidates for a successful installation of reburning because of their large postmelter cavities (furnace flues and regenerator crown), and characteristics such as hot combustion gases and high initial NO_x concentrations.

A schematic of the process is shown in the figure below. The reburning process can be conceptually divided into three zones, the primary zone, the reburning zone and the burnout zone. In the primary zone the fuel and air are fired through the existing burners on the furnace at normal or reduced primary fuel stoichiometry. The level of the NO_x exiting the zone is the input to the reburning process. In the reburning zone the reburning fuel is injected downstream of the primary zone to create a fuel rich, NO_x reduction zone. Depending upon the primary stoichiometry, the amount of fuel required is 5 – 20 % of the primary fuel. In the burnout zone air is added to produce overall fuel lean conditions and to oxidise all unburned species.

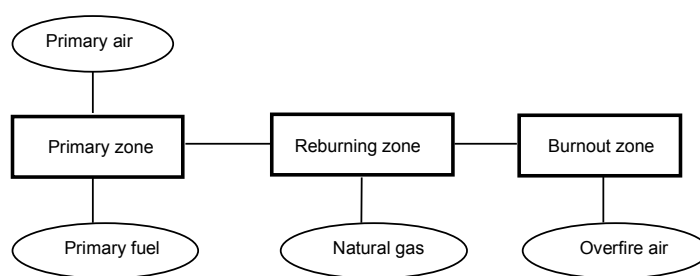
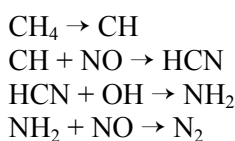

Figure 4.1: Reburn Process Overview

Hydrocarbon radicals formed from natural gas in the fuel rich reburn zone, primarily CH species, react with NO formed in the primary zone to form other nitrogen species such as HCN and NH₃. Once formed, these species rapidly react with other primary NO molecules to form molecular nitrogen (N₂). After allowing the reburn fuel to mix and react with the combustion gases, burnout air is injected to complete combustion of the reburn fuel. In the burnout zone, any remaining reduced nitrogen species are completely converted to molecular nitrogen (N₂) or back to NO. High combustion gas temperatures and high primary NO_x concentrations have been shown to improve the NO_x reduction achievable with reburn. If reburn can be accomplished under nearly isothermal condition and at residence times of about 0.5 seconds,

significant NO_x reductions are theoretically achievable. The principal reaction pathway is summarised below.



For application of reburn to glass furnaces, it is expected that the reburn fuel will be injected at the back end of the melter or just downstream of the melter to minimise impacts on the heat distribution above the melt. For glass furnaces with sufficient gas residence time between the reburn fuel injection point and the heat recovery device (i.e. regenerator or recuperator), the burnout air would be injected just upstream of the heat recovery device.

Environmental Performance

This technology was tested in 1996 on a 350 t/day container glass furnace located in Antioch (U.S., California). Because of pending regulations on NO_x control, a 50 % reduction (2.5 kg of NO_x/tonne of glass) was selected as the target. On baseline, the NO_x emissions were about 3500 mg/Nm³ at 8 % O₂, and by reducing the amount of primary air, this was reduced to 2500 mg/Nm³. After using 5 % of natural gas (compared to primary heat input) 1800 mg/Nm³ was achieved, and increasing the amount of reburning gas to 9 % reduced the NO_x emissions to 1000 mg/Nm³. Flue gas temperature increased by 40°C to 80°C leading to an increased preheated air temperature. Therefore, two thirds of the energy was recovered using 9 % natural gas with an increased fuel consumption of 3 %.

Another demonstration is currently in progress on a furnace of Glaverbel-France. The main goal is to reduce the NO_x emissions by 50 % or to reach 500mg/Nm³. The strategy used to achieve this goal is to focus on the ports generating the highest levels of NO_x and therefore easiest to treat. Depending on the configuration, at least 50 % of the energy is expected to be recovered. Therefore, the additional fuel consumption should be limited to about 4 %.

Financial Considerations

Capital costs for the reburning process are estimated at 800000 euros for a 500 t/day flat glass furnace, 500000 euros for a 250 t/day container glass furnace and 320000 euros for a 125 t/day fibre glass furnace. Operating costs depend on the number of ports treated, on the amount of gas used and on the percentage of heat recovered. These costs are about 0.5 to 1.5 euros/tonne of glass.

Applicability

The technique is applicable to both new and existing furnaces. However, at the time of writing there are no examples of its long-term use at full scale and it is still considered as a developing technique. Reburning is suitable for retrofit applications because the modifications necessary to install the technology are minimal. The application of reburning during a furnace rebuild offers the potential for minimising the impacts on the furnace thermal performance and increasing NO_x reductions. For example, regenerators can be redesigned to substantially recover the reburn fuel heat content and to implement an advanced gas reburn concept. Reburning technology is usually applied after primary NO_x control technologies and can achieve NO_x reductions of up to 70 %.

Associated Considerations

The primary design criteria for reburning is to achieve a stoichiometry in the reburn zone of 0.9, the optimum stoichiometry for reburn operation. For glass furnace applications, it is assumed

that the reburn fuel is added to the system downstream of the melter to minimise any impact of reburning on the melt. In a real application, it may be possible to inject the reburning fuel into the end of the melter region, however, this possibility would need to be evaluated on a specific site basis. Reburn fuel injection downstream of the melt can decrease the overall furnace efficiency if the added heat input is not fully recovered in the regenerators. Therefore, to minimise the amount of reburn fuel injected and the impact on furnace efficiency, the primary stoichiometry needs to be minimised (between 1.01 and 1.05). These levels should be achievable on most glass furnaces, but may require some optimisation of the melter firing rate and distribution. On furnaces where it is not possible to modify the melter stoichiometry without impacting on the melter operation or glass quality, some of the energy associated with the reburn fuel will be absorbed by the regenerator resulting in higher air preheat temperatures. Lower primary fuel consumption will result in lower airflows and reduced reburn fuel and overfire air requirements. Thus, determination of the reburn material balance is an iterative calculation.

The injection of the reburn fuel downstream of the furnace increases the flue gas temperature in the regenerators by 50°C to 100°C, depending on the configuration. Consequently the preheated air temperature increases and allows the recovery of part of the energy used for reburning. To limit the increase of temperature in the regenerators, the quantity of overfire air is controlled. The amount of recovered energy depends on the quantity of gas used for reburning and the amount of overfire air injected. Up to two thirds of the energy used for the reburning operation can be recovered.

Example Installations

Glaverbel, France – Float Glass

4.4.2.7 Selective Catalytic Reduction (SCR)

Description of Technique

SCR involves reacting NO_x with ammonia in a catalytic bed at the appropriate temperature. Several catalysts are available each operating over a slightly different temperature window. The most common catalysts are vanadium and titanium oxides (usually TiO₂ and V₂O₅) impregnated onto a metallic or a ceramic substrate. Zeolite molecular sieves can also be used, with the reaction taking place in the microscopic porous structure. The performance of zeolites can be optimised by adding metals such as platinum or palladium to the structure. Whichever catalyst is used it is important to maintain the correct operating temperature, usually 200°C to 500°C with the optimum 300°C to 450°C.

The catalyst units used in the Glass Industry are modular honeycomb structures, although granular or plate forms are used in some Industries. The size of the unit depends on the volume of waste gas being treated and the desired NO_x reduction. The modular structure allows easy section replacement, or the addition of further catalyst. Catalyst lifetimes depend on many factors but particularly waste gas composition and plant design. Most suppliers will guarantee three years or more, and in most industrial applications 5 to 6 years could be expected without significant deterioration of activity. In early applications in the glass industry catalyst problems were experienced with the activity seriously reduced after 3 years.

Systems are normally designed to achieve 75 - 95 % NO_x reduction. In theory the NO_x reduction efficiency increases with the NH₃:NO_x ratio, but this is usually kept below 1.1:1 to minimise ammonia breakthrough. The NO_x reacts with the NH₃ according to the overall reactions given below. These reactions normally take place at around 950°C (SNCR), but the presence of the catalyst lowers the temperature by absorbing the NH₃ which reacts with the NO from the gas phase. The ammonia is injected upstream of the catalyst either as liquid NH₃ or as

an aqueous solution, urea has been used in some applications but is not favoured in the Glass Industry.

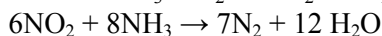
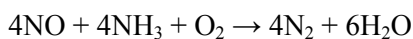

Several undesirable reactions can also take place

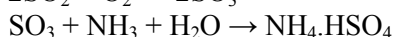
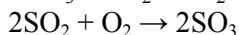
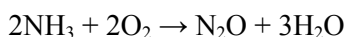

With SCR the production of N_2O is very low and is not usually a problem. The formation of SO_3 and subsequent reaction to ammonium bisulphate (NH_4HSO_4) can be a problem, particularly with high sulphur fuels. The ammonium bisulphate can poison the catalyst and cause fouling and corrosion of the equipment. Some dusts containing alkali metals (e.g. MgO , CaO , Na_2O , K_2O) or heavy metals can also act as catalyst poisons.

Although high dust systems exist, with glass processes it is necessary to install a dust removal unit before the SCR unit. This unit must reduce the dust concentration to 10 - 15 mg/m^3 , and is almost always an electrostatic precipitator (2 or 3 stage). The low operating temperatures of bag filters would require the waste gas to be reheated to the reaction temperature for the catalyst, which would add greatly to the operating costs and would generally be considered as prohibitively expensive. It is also necessary to blow air through the catalyst bed (about every 2 hours) to prevent blinding and blockages by the remaining fine dust. The use of the EP means that in many cases an acid gas scrubbing system must also be installed upstream of the EP. At the time of writing there is no experience in the Glass Industry with heavy fuel oil firing and SCR and further development work is necessary to determine if the technique is compatible.

Environmental Performance

The NO_x emission levels achieved will depend mainly on the inlet concentration and on the amount of catalyst and ammonia used. The level of ammonia is usually kept below 1.1:1 to limit the potential for ammonia breakthrough. In general, NO_x reductions of up to 70 - 95 % are quoted for most applications. Some applications within the glass industry e.g. special glass have high unabated NO_x emissions ($>4000 \text{ mg}/\text{m}^3$), and theoretically a 90 % reduction would give a concentration below $500 \text{ mg}/\text{m}^3$. In theory given a sufficient amount of catalyst very low emission levels are possible, but in practice there are many limiting factors which restrict performance.

Without a high degree of primary NO_x abatement measures, more typical glass furnace emissions would be in the range $1200 \text{ mg}/\text{m}^3$ to $2000 \text{ mg}/\text{m}^3$, and an 80 - 90 % reduction would give values ranging from below $200 \text{ mg}/\text{m}^3$ to $500 \text{ mg}/\text{m}^3$ and 0.5 - 1.0 kg/tonne of glass melted. If combined with the primary measures described in Section 4.4.2.1 very low figures could be anticipated.

In most current applications within the Glass Industry SCR is used to maintain compliance with the applicable local legislation, which is usually not lower than $500 \text{ mg}/\text{m}^3$. Therefore, subject to the limitations discussed in this section, for glass processes NO_x emissions levels of $<500 \text{ mg}/\text{m}^3$ ($<800 \text{ mg}/\text{m}^3$ for high inlet concentration) can be achieved using SCR. In some industries figures of $<200 \text{ mg}/\text{m}^3$ have been achieved, and it is not unreasonable to expect that figures around these levels could be achieved in some cases in the Glass Industry. However, it should be emphasised that at the time of writing these lower figures have not been achieved in practice in the Glass Industry and both the technical and economic implications should be considered. Most existing applications of the technique within the Glass Industry have achieved

reductions in the range 70 - 80 % but 80 - 95 % could potentially be achieved, particularly with a new installation [tm6 NOx Ind.duVerre].

Financial Considerations

The cost of SCR depends mainly on the size of the plant (waste gas volume to be treated) and the desired NOx reduction efficiency. In general, the technique is considered to have high investment costs and moderately high operating costs. Also because SCR is an integrated 3 - stage abatement system, the cost of the technique depends greatly on whether the cost of the EP and waste gas scrubber are included or not. In some cases it could be argued that without the installation of SCR the furnace might not require the de-dusting equipment, in other cases it may be argued as an existing requirement.

The available cost information is not always easy to interpret and is quite case specific. The information available at the time of writing is summarised below.

The most comprehensive data available is from the Euroglas float glass plant in France. The costs given below are based on an exchange rate of 6.6 French francs to the euro.

Capital costs of total system - 3.5 million Euros, of which the SCR stage was 1.3 million Euros. This was a new plant and so no retrofitting costs were incurred. Operating costs (based on a 4 year catalyst lifetime, assuming full dust recycle and excluding interest and depreciation) were 542000 Euros (ammonia 136000, energy 83000, lime 212000, catalyst replacement 76000, others 35000). This was for a gross production of 182500 tonnes of glass, with 156950 net production (nominal 500 tonnes per day production). Waste gas volume approximately 55000 Nm³/hour.

Schott-Ruhrglass in Mitterteich, Germany has operated an SCR unit since 1989, for 6 furnaces connected to one SCR system, with a total waste gas volume of 60000 Nm³/hour. Costs reported in 1990 quoted capital costs of 1.5 - 2.0 million Euros and operating costs of 450000 Euros (including depreciation and interest c.100000 Euros), both costs for the SCR stage only excluding the dust and acid gas treatment [tm32 Beerkens]. The capital costs of SCR have reduced in recent years due to increased competition from suppliers.

PLM in Bad Münden, Germany has run an SCR system serving 4 container glass furnaces since 1994. Costs are reported as 1.6 Euros (assuming 1Euro = 2DM, depreciation 13 years and interest 8 %) per tonne of glass produced, which equates to about 450000 Euro per year. In 1994 the capital cost was 2.3 million Euros. Both sets of costs relate to SCR only.

In a report to the EIPPCB [tm32 Beerkens] costs estimates are made for a range of furnaces. These figures are summarised below and compared with other techniques in Section 4.4.2.9. Costs given do not include interest or depreciation. Capital costs are estimated at plus or minus 15 % and operating costs at plus or minus 30 %.

Size tonnes/day	Gas Volume Nm ³ /hour	Capital cost (x1000) euros	Operating cost (x1000) euros per year
50 t/d Container	6400	990	74
100 t/d Container	11120	1500	108
300 t/d Container	23000	2420	200
450 t/d Container	33350	3100	260
600 t/d Float	70000	4550	470
100 t/d Glass Fibre	12000	2000 - 3000	139

Table 4.10: Costs of SCR with electrostatic precipitators and acid gas scrubbing [tm32 Beerkens]

Applicability

In principle, SCR can be applied to most processes in the Glass Industry and to both new and existing processes. However, there are a number of issues that severely limit the applicability of the technique in certain cases. These issues are summarised below.

The technique has not been used on heavy fuel oil fired plants due to the high levels of SO₂ in the flue gas, which can result in ammonium bisulphate formation and poisoning of the catalyst, and corrosion. This is potentially also true for gas fired furnaces with high sulphate levels. One of the key aspects of the costs of SCR is the catalyst lifetime, which could be significantly reduced if poisoning occurs. In [tm47 French Submission] a trial with a diesel engine using heavy fuel oil with high sulphur content and SCR is reported. A reduction of 90 % was demonstrated with no operational problems over 2500 running hours.

SCR has been used in the power industry to treat gases with high SO₂ concentrations, and the problem has been solved by the use of efficient flue gas desulphurisation techniques upstream of the equipment. The SO₂ removal efficiency of gas scrubbing systems currently used within the Glass Industry is unlikely to be adequate for SCR. More efficient SO₂ removal would add substantially to the costs and would make it difficult to recycle the collected material to the furnace, thus creating a further waste stream. Further information is given in Section 4.4.3.

SCR requires a lot of space particularly if the scrubbing and filter units are not already installed. On some existing plants where space is limited, this could add substantially to the cost of the technique or in some cases make it prohibitively expensive.

It is not generally practicable to use SCR in combination with a bag filter system, because the low operating temperature of the bag filter would usually make it necessary to reheat the waste gas. The cost of reheating the gas to around 400°C is generally prohibitively expensive. [tm32 Beerkens] estimates 800000 euros per year for 65000 Nm³/hour. Therefore, if an existing installation is fitted with bag filters they would have to be replaced with EPs, or the gas reheated, both adding greatly to the cost. Similarly, SCR also requires very low dust levels (<15 mg/m³ preferably < 10 mg/m³) and if the existing EP is not adequate it will require upgrading or replacement.

The technique has been proven for certain glasses containing high levels of boron (pharmaceutical borosilicate tubes - Schott-Ruhrglas, Mitterteich), but has never been tried for glass wool or continuous filament glass fibre. The potential problem for these processes is the presence of volatile boron containing substances (particularly boric acid) in the waste gases. These materials may condense to form salts or acidic materials down to 60°C, and at the temperatures of SCR are likely to be present in significant quantities. These materials could seriously affect the performance of the catalyst and would be difficult to remove by soot blowing.

Associated Considerations

For the Glass Industry apart from the limits of applicability described above, the overriding consideration for SCR is the cost compared with other techniques. Section 4.4.2.9 compares the costs of the various techniques for NO_x reduction. SCR is a relatively expensive technique compared to primary measures (including FENIX), the Pilkington 3R Process, SNCR and in some applications oxy-fuel firing. All of these techniques have developed substantially in recent years, and in many applications where unabated emissions were below 2500 mg/m³ (i.e. where nitrates are not added nor very high temperatures required) emission levels approaching those proven with SCR can be achieved. Therefore, except where inlet concentrations are very high SCR is not generally considered by the Glass Industry to be the most cost-effective technique.

The NH₃ reagent is injected under pressure into the flue gas upstream of the catalyst bed and either liquid ammonia or an aqueous solution (usually 25 %) can be used. Liquid NH₃ is a hazardous substance and there are important cost and safety issues associated with its storage and use. Most glass processes do not use these types of chemicals and operators prefer to use an aqueous solution, which also requires careful storage and handling.

Ammonia emissions are also a concern and can be a limiting factor on the efficiency of the technique. Several of the units currently in operation show that emissions of NH₃ can be kept below 10 mg/m³ and still maintain good efficiency levels.

<p><u>Advantages:</u></p> <ul style="list-style-type: none"> • Very high NOx reduction efficiency. • Reduces NOx from all sources in the furnace not only thermal NOx. • May form part of an integrated air pollution control system. • Several examples within the Glass Industry and many examples elsewhere. • Performance guarantees often available from suppliers. <p><u>Disadvantages:</u></p> <ul style="list-style-type: none"> • Technical issues still to be resolved in some applications (e.g. oil-fired plants and some boron containing glasses). • Ammonia is consumed and emitted, and the storage and handling of the material presents environmental and safety concerns. • Significant energy is consumed by the system. • Must be installed with dust abatement and acid gas scrubbing, low dust and SO₂ levels are required. • Relatively high capital cost, particularly for small plants. • High space requirement. • Relative cost benefit under erosion by developments in other cheaper techniques. • Concerns persist over catalyst lifetimes. • The operating temperature limits the possibilities for heat recovery. • Gas cooling may be required for recuperative furnaces.

Table 4.11: Main advantages and disadvantages of SCR

Example Installations

Plant name and location	Gas Volume Nm ³ /hour	Inlet mg/m ³	Outlet mg/m ³	% Reduction	NH ₃ mg/m ³
Schott-Ruhrglas, Mitterteich, Germany (Borosilicate glass)	60000	5000	1500	70	<20
Euroglas SA, Homburg, France (Float glass)	55000	2000	500	75	<5
PLM Bad Münden, Germany (Container glass)	60000	1300	<400	>70	<2
Schott Glas GmbH, Mainz, Germany (TV glass)	30000	3500 - 4500	650 - 850	70 - 80	<10
Philips, Aachen, Germany (TV glass)	30000	4000 - 5500	450 - 850	75 - 85	<30
Oberland Glas AG, Neuburg, Germany (Container glass – SCR unit no longer operated – permit level met with 1 ⁰ measures)	50000	1100	<500	55	<30

4.4.2.8 Selective Non-Catalytic Reduction (SNCR)

Description of Technique

In the selective non-catalytic reduction process (also known as Thermal DeNO_x) the oxides of nitrogen in the flue gas are reduced to nitrogen by reaction with ammonia or urea at high temperature. In the Glass Industry only ammonia and aqueous ammonia are used. The chemical reactions involved are the same as those for SCR described in Section 4.4.2.7 above. However, the reactions take place at higher temperature without the need for a catalyst. The operating temperature is within the range 800 - 1100°C, but most is effective around 950°C. In some applications it has been suggested that the addition of hydrogen to the waste gas can assist the reaction at lower temperatures. In SNCR the ammonia is injected closer to the furnace than in SCR, and usually involves a carrier gas. The efficiency of the technique depends on a range of factors, the main ones are:

- temperature;
- initial NO_x concentration;
- uniform reagent and flue gas mixing;
- ammonia to NO_x ratio; and
- reaction time (1 to 2 seconds required).

In particular, it is important to ensure the correct temperature range (too low leads to ammonia slippage and reduced efficiency, too high and further NO_x may be formed) and to ensure that the reagent is uniformly distributed in the flue gas. In achieving the correct temperature the positioning of the ammonia injectors is critical, but the zone with the correct temperature may not be accessible or may change with operating conditions (e.g. load changes). This change in location of the correct temperature zone can be catered for by the provision of further ammonia injectors, but this will add to the capital cost and will depend on the accessibility. Uniform distribution can be achieved by good ducting design and if necessary the use of baffle plates or other flow correction devices.

The technique suffers some of the same potential operating problems as SCR i.e.: ammonia slip; N₂O formation (higher with urea); and ammonium bisulphate formation. Ammonium bisulphate formation may be higher than in SCR because the operating temperature requires injection upstream of any filter and scrubbing system. There is no catalyst present but the ammonium bisulphate can cause caking problems.

Environmental Performance

NO_x reductions in the range of 30 - 70 % are commonly quoted for SNCR although figures above 80 % have been reported in some applications. The main influencing factor will be the degree to which the performance dependant factors can be optimised. In a modern well controlled process where the optimum conditions can be achieved reductions of 50 - 75 % are possible. In general, the technique is easier to implement with recuperative furnaces than with regenerative furnaces.

The final emission concentration will depend on the initial concentration and so the best results will be obtained where the technique is combined with primary reduction measures. For example, an initial concentration of 1100 mg/m³ could be reduced to between 275 and 770 mg/m³, depending on the process conditions. A high initial concentration of 4000 mg/m³ could be reduced to between 1000 and 2800 mg/m³.

In [tm35 SNCR] Vetropack report a reduction at 220 tonnes per day from 800 to approximately 200 mg/m³, and at 340 tonnes per day a reduction of about 60 %. In both cases ammonia slippage was low.

Financial Considerations

In a report to the EIPPCB [tm32 Beerkens] costs estimates are made for a range of furnaces. These figures are summarised below and compared with other techniques in Section 4.4.2.9. Costs given do not include interest or depreciation. Capital costs are estimated at plus or minus 15 % and operating costs at plus or minus 30 %.

Size tonnes/day	Gas Volume Nm ³ /hour	Capital cost (x1000) euros	Operating cost (x1000) euros per year
50 t/d Container	6400	190	23
100 t/d Container	11120	280	28
300 t/d Container	23000	450	73
450 t/d Container	33350	575	100
600 t/d Float	70000	1350	225

Table 4.12: Costs of SNCR
[tm32 Beerkens]

Applicability

In principle, the technique is applicable to all glass processes including new and existing plants. SNCR involves lower investment costs and requires less space than SCR, making it more attractive for processes where space is limited. Also the technique can be operated without gas scrubbing and dust removal equipment. If the correct process conditions exist SNCR is easier to retrofit to existing plants than SCR. However, the technique also has certain factors that limit its applicability within the Glass Industry. The most important of these is whether the reagent can be introduced at a point in the waste gas system where the correct temperature can be maintained for an adequate reaction time. This is of particular relevance in existing plants and for regenerative furnaces.

In existing plants the area where the correct temperature occurs may be difficult to access or be in a position where the gas flow makes it difficult to achieve good mixing with the reagent. In many cases these problems can be overcome or mitigated, but it can add significantly to the cost and can compromise the efficiency of NO_x reduction. In regenerative furnaces the correct temperature range usually occurs within the regenerators, which makes it very difficult to inject the ammonia effectively. This problem can be addressed by using split regenerators and injecting the ammonia in the connection. Split regenerators can be included in the design of a new plant, but for existing processes splitting the regenerators can involve substantial costs and can only be done at a rebuild.

In practice, SNCR is very unlikely to be used in existing regenerative furnaces, the costs and associated difficulties will usually lead the operator to choose an alternative means of reducing NO_x emissions. In smaller recuperative furnaces the relative costs of SNCR are quite high, and in many cases, industry are likely to favour other more cost-effective control measures. Although this will depend on the required performance level.

Associated Considerations

Advantages:

- SNCR can achieve good NO_x reduction efficiencies if correct conditions exist.
- Low capital cost compared to some alternatives.
- No catalyst required.
- Low energy requirements.

Disadvantages:

- Ammonia injection within the correct temperature window is essential, but sometimes difficult or impracticable to achieve (particularly for regenerative furnaces).
- Outside the operating temperature range NH₃ or increased NO_x emissions can result.
- Uniform mixing is important and can be difficult to achieve.
- Ammonia is consumed and emitted, and the storage and handling of the material presents environmental and safety concerns.
- Concern over possible damage to regenerator refractory material.

Table 4.13: Main advantages and disadvantages of SNCR

Example Installations

Vetropack AG, Bülach, Switzerland – Container Glass.

PPG Fresno, California, USA- Float Glass.

Schott Glas, Mainz, Germany – Special Glass.

Henkel, Dusseldorf, Germany – Water Glass.

Osram, Augsburg, Germany – Lighting Glass.

4.4.2.9 Comparison of NO_x Abatement Technique Costs

This section compares the costs of the main NO_x abatement techniques described in this chapter and also the costs of a filter and acid gas scrubbing system. The information presented here is based largely on a report prepared for the EIPPCB [tm32 Beerkens]. There is a wide range of installation specific issues that are impossible to include in a report of this type, for example:

- Energy prices (particularly electricity).
- Taxation.
- Material costs (e.g. lime, ammonia, etc).
- Incentive schemes provided by Member States.
- The details of negotiations between suppliers and process operators.
- Disposal costs for solid or liquid wastes.
- Installation infrastructure.

The costs of a particular technique may also vary widely between sectors, between glass types and between furnaces of different sizes. It is not possible within the scope of this document to cover all of the potential combinations of size and glass type. Also for certain parts of the Glass Industry there is very little information available publicly. Therefore, the information presented here can only be considered as a general indicative guide based on the information available and with a degree of interpretation and extrapolation. A more detailed in depth study would require a great deal of time and further information to be made available. This is not considered possible within the scope of this work.

Five typical cases are considered all of which are soda-lime furnaces, and where possible information is tentatively proposed for a continuous filament glass fibre furnace. These examples have been chosen because they represent the majority of glass production and because

most information is available for furnaces of these types. The examples given are for various production ranges, but care should be taken in making direct comparisons with other types of glass production. For example, a 100 tonne per day container furnace operating on 48 % cullet will be significantly smaller than a 100 tonne per day continuous filament glass fibre furnace. Therefore, the flue gas volumes of the examples are given and these will help in making comparisons with other sectors.

The five cases are:

1. Container glass production, 50 tonnes molten glass/day (recuperative).
2. Container glass production, 100 tonnes molten glass/day (recuperative).
3. Container glass production, 300 tonnes molten glass/day (regenerative).
4. Container glass production, 450 tonnes molten glass/day (regenerative).
5. Float glass production, 600 tonnes molten glass/day (regenerative).

The techniques considered are:

1. Low NO_x combustion systems and low NO_x combustion control.
2. SCR excluding costs of flue gas preconditioning (i.e. excluding filter and scrubber).
3. SNCR.
4. Pilkington 3R technique (excluding license costs and with and without allowance for modifications to regenerator refractories).
5. 100 % oxy-fuel firing.
6. SCR plus flue gas preconditioning (i.e. including filter and scrubber);
7. Filter + scrubber for particulate and acid gas emission reduction.

The costs for SCR with and without gas preconditioning are given to show costs for any application where the filter and scrubber are already fitted. However, there will clearly be costs associated with retrofitting. The capital and operating costs of the filter and scrubber are considered to be indicative of both bag filters and electrostatic precipitators within the range of confidence given.

The table below gives the indicative capital costs (plus or minus 15 %) of the various techniques for the example cases. Some further information is provided in the specific sections of this Chapter. The costs do not include interest charges or other costs of obtaining capital. The capital costs of oxygen production are incorporated in the operating costs. All figures are in euros. The negative cost for oxy-fuel is due to the savings on the recuperator or regenerator system. As discussed in Section 4.4.2.5 for regenerator systems this applies mainly to new plants and can be off-set to some degree if more expensive refractories are required for the furnace. The costs for 3R will depend greatly on whether regenerator repairs are envisaged or not. This issue is discussed in Section 4.4.2.6.1. In general repairs are not expected on float plants but potentially on some container glass or domestic glass furnaces, although this is thought extremely unlikely.

Capital costs in euros	50 TPD	100 TPD	300 TPD	450 TPD	600 TPD
	container	container	container	container	float
SCR	430000	615000	1000000	1300000	1800000
SNCR	190000	280000	450000	575000	1350000
LowNOx	100000	100000	180000	200000	550000
Oxy-Fuel	-200000	-300000	-1350000	-1750000	-4800000
3R incl. repairs etc			270000	350000	680000
3R excluding repairs			140000	170000	260000
SCR+filter	990000	1500000	2420000	3100000	4550000
filter+scrubber	565000	875000	1420000	1820000	2750000
Nm ³ flue gas/hr	6400	11120	23000	33350	70000

Table 4.14: Capital costs for abatement techniques
[tm32 Beerkens]

Table 4.15 below gives the indicative operating costs (plus or minus 30 %) of the various techniques for the example cases. Some further information is provided in the specific sections of this Chapter. The costs include reagents (e.g. ammonia and lime), flue gas monitoring, maintenance, and extra energy costs for fans etc. Interest on capital and depreciation are not included. For oxy-fuel melting the cost of oxygen (including capital and energy) is based on 0.055 euros/m³ for small users and 0.04 euros/m³ for larger users, these figures are comparable with those given in [tm6 NOx Ind.duVerre]. The costs also include the anticipated energy saving for oxy-fuel melting. The figures 25 - 30 % for recuperative furnaces and 10 - 15 % for regenerative furnaces have been used.

euros x 1000	50 TPD	100 TPD	300 TPD	450 TPD	600 TPD	100 TPD
	container	container	container	container	float	fibre
SCR	42	64	123	166	330	100
SNCR	23	28	73	100	225	23 - 35 ⁽¹⁾
LowNOx	15	21	35	46	72	21
3R with repairs			185	255	285	
3R without repairs			106	156	267	
Oxygen	135	190	530	1110	1900	227
SCR+filter	74	108	200	260	470	139
Filter plus scrubber	37	53	89	116	186	64

Table 4.15: Annual operating costs for abatement techniques
[tm32 Beerkens]

⁽¹⁾ Estimated costs

The table below gives the total costs of each technique (including depreciation 10 years and interest 7 %) in euros per tonne of glass.

Tonnes molten glass/day	m ³ flue / hr	Euros/tonne of glass							
		LowNOx	SCR	SNCR	3R + repairs	3R no repair needed	Oxy-Fuel	SCR +filter scrubber	filter+ scrubber
50	6400	2.36	7.01	3.65	3.96	3.18	6.17	14.25	7.97
100	11120	1.34	4.98	2.35	2.87	2.20	4.06	10.2	5.52
300	23000	0.72	2.83	1.49	2.28	1.35	5.05	5.75	3.01
450	33350	0.57	2.44	1.3	2.02	1.23	5.04	4.92	2.68
100 fibre	12000	1	5	1.5 - 2	4 - 4.5	2.50	7 - 8	13	9
600 float	70000	0.83	2.99	2.16	1.91	1.50	5.16	5.78	3.06

Table 4.16: Specific costs for the abatement techniques in euros/tonne glass
[tm32 Beerkens]

The NO_x reduction is based on a initial NO_x level of 1600 mg/m³ for recuperative furnaces and 2000 mg/m³ for float glass, and the reductions per technique as follows SCR (80 %), SNCR (50 %), low NO_x (50 %), 3R (65 %) and oxy-fuel (80 % by mass). The reduction levels for SNCR and particularly for 3R may be higher (up to 80 % for 3R).

The costs of oxy-fuel firing are notoriously difficult to predict and can vary widely depending on the energy saving achieved and the cost of oxygen. For example, these costs are calculated with a 25 - 30 % energy reduction for recuperative furnaces. In other sectors where cullet use is much less this could be 50 %. Similarly depending on installation specific negotiations the cost of oxygen/m³ may be significantly lower. This is particularly true where several furnaces are at the same installation. The table below gives an indication of the huge variation in cost per tonne of glass that can be experienced for the two likely limits of costs. There are also other economic factors that are potentially important in the choice of oxy-fuel melting, these are discussed in Section 4.4.2.5.

Tonnes/day Glass Melted	Extra costs /tonne of glass melted Oxygen 0.03 euros/m ³	Extra costs /tonne of glass melted Oxygen 0.06 euros/m ³
50	-0.47	7.5
100	-0.55	6.4
300	2.5	8.7
450	2.5	8.6
600	2.3	10.8

Table 4.17: Costs of oxy-fuel melting (euros/tonne of glass) for two oxygen prices
[tm32 Beerkens]

4.4.3 Oxides of Sulphur (SO_x)

The term oxides of sulphur (SO_x) includes sulphur dioxide (SO₂) and sulphur trioxide (SO₃), expressed as the SO₂ equivalent. Sulphur dioxide is by far the most prevalent oxide of sulphur in the Glass Industry and most of the following discussion relates to this species. Below about 200°C SO₃ is usually in the form of an acid mist or vapour. The two main sources of oxides of sulphur emissions are the oxidation of sulphur in fuels and the decomposition/oxidation of sulphur compounds in batch materials.

The retention of sulphur compounds in the glass is usually low (<0.35 % as SO₃, in most industrial glasses) and in general the majority of the sulphur entering the furnace is emitted to the atmosphere as SO_x. Some of the SO_x in the waste gas stream will react with other species to produce sulphates, which condense to form dust. The amount of sulphate in the dust varies depending on the glass type, but for soda lime glasses it is around 98 %. This issue is discussed in more detail in Section 4.4.1.

In electrically heated furnaces SO₂ emissions tend to be very low and arise only from raw material decomposition. In stone wool cupolas there is an overall reducing atmosphere and sulphur from the raw materials and fuel is emitted mainly as SO_x and hydrogen sulphide (H₂S). In EU installations the waste gases are usually treated in an afterburner system, which oxidises the H₂S to SO₂.

4.4.3.1 Fuel Selection

In oil fired processes the main source of SO_x is the oxidation of sulphur in the fuel. The amount of SO_x derived from the batch materials varies depending on the glass type but in general wherever fuel oil is burned the SO_x emissions from the fuel outweigh those from the batch materials. The most obvious way to reduce SO_x emissions is to reduce the sulphur content of the fuel. Fuel oil is available in various sulphur grades (<1 %, <2 %, <3 % and >3 %), and natural gas is essentially sulphur free. Fuel oils with sulphur levels up to 3.5 % are burned in some European glass furnaces, but in most Member States fuels with greater than 2 % sulphur are rarely used. In order to improve acidification control in the EU, at the time of writing discussions are underway on EU measures to control sulphur in fuel oil levels to 1 % or the equivalent following abatement. The table below shows some typical SO_x emissions from soda-lime glass with various fuel grades. The figures are indicative only and actual figures may vary significantly.

Fuel	SO _x (as SO ₂) mg/m ³
Natural gas	300 - 1000
1 % Sulphur fuel oil	1200 - 1800
2 % Sulphur fuel oil	2200 - 2800

Table 4.18: Indicative SO_x emissions in glass furnace waste gas for different fuels

The use of natural gas is increasing within the industry. For example, almost all fossil fuel fired glass wool furnaces, most continuous filament glass fibre furnaces, and around 50 % of all container furnaces are fired on natural gas. However, the main influencing factor is the fuel price differential between gas and oil. The general experience within the industry is that conversion to natural gas results in higher NO_x emissions, 25 - 40 %, although with increased experience the differential is narrowing. This issue is discussed in more detail in Section 4.4.2.1 (Fuel choice).

The conversion to a lower sulphur content fuel does not result in any increased costs except the higher fuel price. The conversion to gas firing requires different burners, the gas supply system to the burners, and modifications to burner and fuel ports. In some cases installations may not have access to a natural gas supply. The prices of the various fuels vary with time and between Member States, but in general a reduction in sulphur content in oil of 1 % carries approximately a 5 % price premium. In most Member States natural gas is more expensive than fuel oil, but in some (e.g. United Kingdom 1998) it can be significantly cheaper. In 1998 in France the various energy prices set at a base of 100 were: electricity (522); natural gas (122); 1 % sulphur oil (100); 2 % sulphur oil (94); and 3.5 % sulphur oil (87). In the United Kingdom in 1998 natural gas was 20 - 30 % cheaper than 2 % sulphur oil.

The table below shows the cost variations of the various energy sources based on estimates for 1 January 1998. The variations in the figures are expressed with the average for each energy type set to 100, the actual average prices are also given.

	Heavy Fuel Oil	Natural Gas	Electricity
Average – base 100 (actual average cost euros/GJ)	100 (300 euros/GJ)	100 (370 euros/GJ)	100 (1310 euros/GJ)
Maximum	122 (Netherlands)	150 (Sweden)	131 (Austria)
Minimum	72 (Belgium)	80 (UK)	64 (Finland)
Maximum/Minimum	1.69	1.87	2.04
EU Average (Base 100 = heavy fuel oil)	100	123	436

Table 4.19: Variations in EU energy prices – source (CPIV)

Hot blast cupolas used in stone wool production are heated by coke. The variation in the sulphur content of coke used by the sector is quite low (0.6 % to 0.9 %) and depends on the source. Coke derived SO₂ usually represents 30 - 70 % of the total emission, depending on the use of blast furnace slag and cement bonded waste. Low sulphur coke can be expensive to transport unless the plant is located close to a convenient source, and the reduction in emissions is likely to be disproportionate to the cost. The sector does not utilise high sulphur alternatives such as petroleum coke, and in many cases the coke sulphur content will have been reduced as far as economically practicable.

4.4.3.2 Batch Formulation

In conventional glass making, sulphates are the main source of SO_x emissions from batch materials. Sulphates are the most widely used fining agents and are also important oxidising agents. By far the most common sulphate used is sodium sulphate, which on melting dissociates to give gaseous SO_x, and Na₂O, which is incorporated into the glass. Sulphates of potassium and calcium are also widely used. In most modern glass furnaces the levels of batch sulphates have been reduced to the minimum practicable levels, which vary depending on the glass type. The issues surrounding the reduction of batch sulphates are discussed in Section 4.4.1.1 and the issues relating to the recycling of filter/EP dust are discussed in Section 4.4.3.3. Typical emissions associated with fining and oxidising agents are 200 - 800 mg/Nm³ and 0.2 - 1.4 kg/tonne of glass melted [tm29 Infomil].

In stone wool production important sources of SO₂ emission (in addition to coke) are the use of blast furnace slag and cement bound briquettes in the batch. Slag usually contains 0.6 - 1.5 % sulphur by weight and the vast majority of the sulphur will be released as H₂S and SO₂. If an afterburner is used then the emissions will be largely oxidised to SO₂. The options for purchasing blast furnace slag with low sulphur levels are few, and plants are usually restricted by their proximity to a very limited number of suppliers within economical transport distances.

The percentage of slag in the batch varies greatly from close to 100 % for slag wool to zero in many normal stone wool plants. In most cases where slag is used it composes around 30 % of the total batch (excluding coke). The only application where its use is necessary to the product is in the production of white fibres for applications such as gun sprayed fibres and ceiling boards. These applications represent only a small percentage of the total output of the sector, but certain plants may produce only these products. For a plant using around 30 % slag in the batch the unabated SO₂ emissions are in the region of 2 - 3 times higher than for a slag free batch. It is estimated [tm26 EURIMA] that at the time of writing approximately 30 % of European stone wool plants use blast furnace slag.

The beneficial effect on the SO₂ emissions of eliminating the use of slag is clear. However, the use of slag does convey a number of advantages, which are summarised below.

- Lower energy use and reduced CO₂ emissions, arising from the partial replacement of limestone by slag. Energy consumption and CO₂ emissions are typically 5 - 15 % lower than in a basalt-limestone charge.
- The charge contains less iron, which reduces the required tap out frequency and can improve yields. There are fewer interruptions to production and a slight reduction in solid waste.
- In some cases slag usage is claimed to improve the fiberising properties of the melt, which can contribute to improved process efficiencies and lower waste levels by reducing shot.
- Blast furnace slag is a waste material that if not utilised is more likely to be disposed of to landfill. Furthermore, it replaces natural stone and reduces demand for quarried materials.
- Slag is also generally cheaper than the materials it replaces.

It is possible that most of the advantages described above could also be achieved by the increased utilisation of recycled process waste. A site-specific assessment of the impact of slag usage on pollution of the environment as a whole may be appropriate in some cases. However in a general qualitative assessment, the advantages of using slag are unlikely to outweigh the emissions generated. If slag usage is required for product colour its use can be minimised by the use of recycled internal process waste. If secondary SO_x abatement measures are used the environmental balance for slag usage could change.

Cement bonded briquetted waste typically contains around 0.16 % sulphur and is used at up to 45 % of the batch. This results in approximately 75 % of the sulphur input from 0.7 % sulphur coke. If a comparison is made between 1 % sulphur slag at 30 % of the batch and 0.16 % sulphur briquettes at 45 % then the slag contributes around three times the sulphur as the briquettes. Developments are also underway to minimise the cement content of briquettes or replace it completely with other binder systems.

4.4.3.3 Dry or Semi-dry Scrubbing

Description of Technique

The reaction principles of dry and semi-dry scrubbing are the same. The reactive material (the absorbent) is introduced to and dispersed in the waste gas stream. This material reacts with the SO_x species to form a solid, which has to be removed from the waste gas stream by an electrostatic precipitator or bag filter system. The absorbents chosen to remove SO_x are also effective in removing other acidic gases, particularly halides (HCl and HF), but also some selenium compounds. In some applications the absorbent is injected directly into the waste gas ducting, but the techniques are substantially more efficient if a reaction tower (dry process) or reaction chamber (semi-dry process) are used.

In the dry process the absorbent is a dry powder (usually Ca(OH)₂, NaHCO₃, or Na₂(CO)₃ to which air can be added to assist dispersion. In the semi-dry process the absorbent (usually Na₂CO₃, CaO or Ca(OH)₂) is added as a suspension or solution and water evaporation cools the gas stream. In other industrial applications, the semi-dry process as described above is often referred as semi-wet. Within this document, the semi-dry term is used exclusively, as it is the usual term used within the Glass Industry.

The dry process is found more commonly in the glass industry than the semi-dry process. In general, the abatement rate depends strongly on the temperature, but at very different degrees for the different waste gas components. Furthermore, there is a different reactivity of waste gas pollutants with the various absorbents and competing reactions occur between the different species, especially if the ratio of reactant to acidic gases is relatively low. Therefore, the different absorption rates are dependent on the specific amount of absorption agent, waste gas composition (pollutants but also humidity and oxygen content) and reaction temperature. Moreover the absorption rates due to the nature of the gas/solid reaction are highly dependent

on the active specific area of the absorbent and the residence time. Therefore, it is normally necessary to have an over-stoichiometric ratio of absorbent. The specific amount of absorption agent is often expressed by the molar ratio which can be defined in two ways:

MR1= Molar ratio of absorbent over SO_x abated

MR2= Molar ratio of absorbent over total SO_x input.

Either the dry or the semi-dry process can be used in conjunction with electrostatic precipitators, but with bag filters the waste gasses will require cooling. The most common scrubbing process used in the Glass Industry is the dry process in conjunction with an electrostatic precipitator, with Ca(OH)₂ as the absorbent and operating at around 400°C. This is because Ca(OH)₂ achieves a relatively good abatement rate at this temperature, and because 400°C can be readily achieved in the waste gas without cooling and is within the operating range of an electrostatic precipitator.

Where bag filter systems are used the temperature has to be reduced to below 200°C. Cooling can be achieved by heat exchanger or cooling air, and is also assisted in the semi-dry process by the evaporation of water. As temperature decreases, the abatement rates for certain species (particularly HCl and SO₂) decrease drastically, and are at a minimum in the range between 200 and 280°C. At temperatures below 200°C, the preferred working range of bag filters, the abatement rates increase and can achieve good results for most pollutants, sometimes even better than at 400°C.

Environmental Performance

As mentioned above the reductions achieved with the techniques depend on a number of factors including waste gas temperature, the amount and type of absorbent added (or more precisely the molar ratio between reactant and pollutants) and the dispersion of the absorbent. The table and figures below give an estimation of efficiencies obtained with various absorbents and processes. The actual figures achieved will vary from case to case, both higher and lower figures have been experienced.

Due to the different absorption rates occurring within the cake on bag filters and the different operating temperatures associated with EP and bag filters, separate figures are given for the two types of filters in table 4.20. [tm41 VDI2578]

Pollutant	EP		Bag Filter
	~ 400 °C	200 – 280 °C	130 – 240 °C
SO ₂	50 %	10 %	10 %
SO ₃	80 %	90 %	95 %
HCl	70 %	35 %	80 %
HF	95 %	95 %	95 %
SeO ₂	90 %	70 %	90 %

Table 4.20: Dry absorption efficiencies for Ca(OH)₂ (Indicative figures)

More generally, reference [tm48 ADEME SO_x] gives the following results for the dry process with Ca(OH)₂.

Temperature	SO _x abatement rate	
	130 - 140°C	170 - 180°C
Molar ratio MR1 Ca/S =1	30 %	22 %
Molar ratio MR1 Ca/S =2	50 %	40 %
Molar ratio MR1 Ca/S =3	70 %	55 %

Table 4.21: SO_x abatement rates for dry scrubbing with Ca(OH)₂

An abatement rate of 65 % has been reported in the case of a float furnace using dry scrubbing plus an EP with a molar ratio MR1 of 4.4, using 180 kg/h of $\text{Ca}(\text{OH})_2$ at a temperature of around 400°C. All the dust is recycled in the furnace. (See Annex 1, Section 8.2, Furnace FG6)

Experiences of the dry process with Na_2CO_3 as the absorbent are summarised in the table below for the temperature range 300 °C to 400 °C. The abatement rate ranges given are again largely dependent on temperature and on the quantity of absorbent used.

Pollutant	SOx abatement rate
SO_2	< 50 %
SO_3	90 %
HCl	50 – 75 %
HF	10 – 40 %
SeO_2	30 – 60 %

Table 4.22: SOx abatement rates for dry scrubbing with Na_2CO_3

The results of the most recent experiences with NaHCO_3 as the absorbent are now becoming available. The indicative absorption rates can be summarised as very good especially for the lower temperature range, with up to 90 % SOx removal possible.

Only a few furnaces are equipped with semi-dry scrubbing devices. In combination with a bag filter and application of Na_2CO_3 solution as the absorbent very high abatement rates have been reported. These results are summarised in the table below. The SO_2 abatement of 95 % is the maximum possible. On current industrial operation the range of reduction obtained is more usually 80 - 90 %.

Pollutant	SOx abatement rate
SO_2	90 - 95 %
HCl	> 90 %
HF	> 85 %
SeO_2	> 90 %

Table 4.23: SOx abatement rates for semi-dry scrubbing with Na_2CO_3 solution

More generally in other industrial applications, reference [tm48 ADEME SOx] gives the following results in the table below for the semi-dry process with $\text{Ca}(\text{OH})_2$. However, semi-dry applications using lime are not commonly found in the glass industry.

	SOx abatement rate
Molar ratio MR1 Ca/S =1	80 %
Molar ratio MR1 Ca/S =1.5	90 %
Molar ratio MR1 Ca/S =2	92 %

Table 4.24: SOx abatement rates for semi-dry scrubbing with $\text{Ca}(\text{OH})_2$

An effect on NOx emissions has also been reported when using Na_2CO_3 or NaHCO_3 in the semi-dry process. For NaHCO_3 the optimal range is located between 120 - 160°C, and the efficiency of the reaction depends on the molar ratio SO_2/NOx . The abatement rate is favoured by a high SO_2/NOx ratio. At higher temperatures, the NOx emission reduction rate is much lower. Under normal representative conditions in the glass industry, only a moderate effect on NOx abatement rates has ever been observed.

In summary, the reduction achieved depends on a number of factors related to the process and absorbent. Under favourable conditions high abatement rates can be achieved, in the best case up to 95 % for total SO_x expressed as SO₂. The value for SO₃ abatement rate is generally greater than 80 %.

The actual emission concentration or mass/tonne of glass will depend on the inlet concentration and the desulphurisation efficiency. These inlet concentrations depends on the following factors:

1. Fuel sulphur input.
2. Glass type (colour, oxidation state and sulphur content).
3. Technological requirements for refining, quality and amount of sulphates.
4. Amount and type of cullet (internal or external, sulphur and contaminants content).
5. Filter dust composition and recycling rate.
6. Combustion conditions (close to stoichiometric combustion for NO_x reduction by primary measures may increase the SO₂ content in raw waste gas).

However, overall reduction of emissions requires the elimination (by internal or external recycling or landfill) of the solid waste stream of sulphated dust produced. In the case of landfill, the treatment cost can be estimated at between 0.5 and 1.5 euros/tonne of glass depending on the context.

In practice, the complete recycling of filter dust, including this sulphated waste, is very frequently considered to be a reasonable environmental and economic option, where this is technically possible. In this case, the overall reduction of SO_x emissions is limited (by mass balance considerations) to the reduction at source obtained by substituting sulphate in the raw materials by filter dust. Clearly this is in addition to other appropriate primary measures to reduce overall sulphur input to the melt by the optimisation of sulphur levels in all feed materials (including cullet) wherever practicable.

Therefore in order to reduce acid gas emissions, it may be necessary to consider an external disposal route for a portion of the collected material. An external option for recycling or reuse would be preferable to landfill. However, at the time of writing an economically viable external reuse of the material has not been identified. The determination of what represents the best protection of the environment as a whole can often be site-specific and may involve consideration of disposal of a solid waste stream. Where this is the case a process sulphur balance will be essential in determining emission levels commensurate with BAT.

With closed loop filter dust recycling, the SO_x emission levels observed today, are generally in the range of 200 - 800 mg/Nm³ for natural gas firing and 800 - 1600 mg/ Nm³ with a fuel oil with 1 % S depending on the above mentioned factors. Especially for glasses with a high cullet recycling rate and a low capacity for sulphur uptake (e.g. reduced glasses such as certain green and brown container glasses), values in the higher end of the range are expected. There are examples in the glass industry where the net desulphurisation efficiency is close to zero when the sulphur containing dust is fully recycled. However, in these situations the main goal was not desulphurisation, but removal of HCl, HF, metals and dust. Nevertheless, even in these cases, lower levels may be obtained with creation of a sulphated waste stream for external disposal.

Thus, when considering desulphurisation in the glass industry, it is important to take into account the possible counteracting effects and the jeopardising of other environmental targets. The most important environmental targets related to SO₂ abatement are:

- high cullet recycling rates
- minimisation of waste production through internal or external dust recycling
- waste heat recovery
- other atmospheric emission reduction

Cullet recycling is an important environmental target because of energy savings, waste reduction and reduction in consumption of natural resources. For instance, for container glass furnaces the legislative quota in Germany for cullet recycling is 72 %, and this quota is regularly exceeded. Where cullet is used with a higher sulphur content than the glass produced, the excess sulphur may result in increased SO_x emissions. This is, for example, the case in green and brown reduced glasses that use mixed post-consumer cullet. Mixed post-consumer cullet is in some cases the only available source of post-consumer cullet to the producers and its sulphur content is higher than the product due to the presence of oxidised glass (flint glass, flat glass, certain green glasses) in the cullet mixture. The progressive improvement in selective cullet collecting and sorting will improve the situation. However the oxidised coloured glass like certain green glasses can also have higher level of sulphur because of their oxidation state, and colour sorting will be less effective in reducing sulphur content in cullet when significant proportions of such glasses are present.

Filter dust recycling is also an important target for reasons of waste prevention. Recycling of filter dust implies the substitution of some of the sulphate contained in the batch material. In principle filter dust acts as a refining agent but it may be less effective in some cases and a 100 % substitution is not always possible. Depending on the different glass types (e.g. colour, oxidation state) the absorption of sulphate arising from filter dust sulphur is varying and sometimes limited. In respect of full filter dust recycling and in consideration of the above mentioned variations, particular care has to be given to the sulphur mass balance and the scrubbing equipment should be designed to enable an appropriate selection of scrubbing agents.

The majority of installed SO_x scrubbing systems operate with dry lime scrubbing at a temperature of around 400 °C which is the waste gas temperature obtained from an efficient regenerative type furnace. At these temperatures, an SO_x reduction of around 50 % can be achieved. An improved SO_x reduction rate can be reached at temperatures around 200 °C and with a humid atmosphere. This can be obtained by the injection of a water dissolved sorbent in connection with bag filters. However this semi-dry technology lowers the temperature of the waste gases to a level that is not generally compatible with secondary heat recovery or for downstream applications that require higher temperature levels (e.g. SCR or cullet preheating). In these cases consideration could also be given to the conventional (or “true”) semi-dry process, although there is currently very little experience of this technique in the Glass Industry. This stresses the need for an integrated analysis prior to the application of desulphurisation, taking into account all effects, side-effects, costs and priorities (e.g. acidification policy, energy policy, waste policy etc)

It must be noted that high stoichiometric rates of sulphur absorbent imply an increased load on downstream dust abatement equipment. In practice, the limited absorption improvement must be balanced against the technological requirement and any additional costs for an increased precipitator capacity.

Financial Considerations

The costs for scrubber systems in combination with EPs and bag filters are given in Sections 4.4.1.2 and 4.4.1.3. Sodium bicarbonate is substantially more expensive than the other absorbents and has been used less.

In [tm29Infomil] it is estimated that for a flow of 50000 Nm³/hr with an EP the capital costs are 2.5 - 3.5 million euros plus 150000 euros/year operating costs, excluding interest and depreciation.

For the stone wool sector capital costs of dry scrubbing in addition to the standard technique of bag filters are estimated at 0.6 to 1.4 million euros for a new plant and about 20 % higher for an existing plant.

Applicability

In principle, the techniques are applicable to all processes (including new and existing) with waste gases containing acidic substances. Due to the high dust loading dust removal is essential. The dry process is much more widely used within the Glass Industry, because it has been the most cost-effective way of achieving the prevailing technical and regulatory requirements. The most commonly used absorbent is Ca(OH)_2 , slaked lime.

The principles of these techniques are common regardless of the size of the installation. However, it should be remembered that the scale and therefore the actual cost, and possibly the cost effectiveness would vary significantly from application to application. In particular there is limited experience with semi-dry scrubbing for smaller processes.

Associated Considerations

The techniques are effective in removing certain other gaseous pollutants, namely fluorides, chlorides, and certain selenium compounds. The techniques could also have an effect on other acidic emissions but no information is available on the reduction levels.

In some current examples within the glass industry an important motivation for the installation of the techniques has been for the protection of dust abatement equipment or in some cases (e.g. continuous filament, frits) for the removal of fluoride emissions. The notable exception to this is stone wool production. In many cases if dust or fluoride abatement were not required, it would be more economical to switch to gas firing rather than install these techniques.

The techniques generate a significant amount of solid residue, but in most applications this material can be recycled to the furnace. Problems may be encountered particularly with oil-fired furnaces using high levels of cullet. If sodium carbonate is used as the absorbent it is more easily recycled in soda-lime glass, because of the substantial requirement for sodium sulphate and sodium carbonate.

At low levels of cullet the collected sulphate will usually be less than that required for refining, and it may also be possible to increase the uptake of the sulphur from the collected dust in the glass (i.e. higher SO_3 %). Overall, emissions are lowered and sodium sulphate consumption is reduced. If the sulphate collected is greater than the sulphate required in the batch then a solid waste stream is created for disposal off-site. Alternatively if all the material is recycled in greater quantities than required then the system becomes a closed loop reaching a dynamic equilibrium with the only sulphur sinks being the glass and the emissions to atmosphere. At high cullet levels the requirement for the sulphate fining agent is much lower and the potential for further uptake in the glass is very low. Therefore, unless a portion of the dust is removed the SO_x emissions increase and the overall benefit of SO_x reduction is greatly reduced. The problem is most evident in reduced glasses with high cullet levels.

In practice, if this was to occur, the costs of disposing of a dust that cannot be recycled can often be higher than the cost of lower sulphur fuels (e.g. low sulphur oil or natural gas). Therefore, in many circumstances an operator would choose to change fuels rather than create a solid waste stream for disposal. However, a high cost differential between low sulphur fuel (particularly natural gas) and other fuels may make such an option economically unattractive.

If calcium hydrate is used as the absorbent most glass compositions will have a limit to how much calcium can be recycled. Adjustments can normally be made to the batch composition to compensate for the filter dust, but in batches with high cullet levels the possibility to adjust the batch is limited. In high cullet batches the calcium content may be greater than can be tolerated in the glass, creating a solid waste. In such a case a solution can be a change of absorbent and a switch to sodium carbonate or bicarbonate, or a mixture of the different absorbents.

In regions that have high cullet recycling rates the system becomes even more of a closed loop as the levels of various compounds build up in the constantly recycling glass. This can be a problem for metals, fluorides and chlorides as well as sulphur.

Where the volume of the collected material presents a problem for recycling, techniques are available to reuse a portion of the absorbent reducing the overall volume. Problems of inconsistent formulation of the collected dust are not usually an issue. Such problems can be overcome by careful analysis and if necessary stockpiling and blending of the material before recycling.

In stone wool production the SO_x reduction must take place following the incinerator and before the filter system. In some current applications the filter system is positioned prior to the incinerator, which is designed to treat a clean gas. In these cases the installation of the technique on existing plants will require modifications to the incinerator or a second filter system. The economics of the options will depend on the configuration of the waste gas system. These modifications would add significantly to the cost and are reflected by the higher part of the cost range discussed above. The semi-dry process has not been proven as economically viable in this sector.

The recycling of the material back to the furnace is more difficult in stone wool than in other sectors because the process does not require the addition of sulphates and the uptake of sulphur in the melt is low. Therefore, the majority of the pollutant would be re-emitted. This means that the collected waste must be disposed of as a solid waste stream, or if possible valorised. The choice of absorbent for stone wool is also limited if recycling is considered. The product requires very low soda levels so sodium carbonate and sodium bicarbonate can only be used if the collected material is not recycled.

An alternative technique tried in the Netherlands was to absorb the SO_x to produce sulphuric acid, which could be sold as a by-product. The effective production of sulphuric acid requires a high concentration of SO₂ entering the catalyst system of the sulphuric acid plant. This was possible in this case because six cupolas were in operation at the site. Five were fitted with dry scrubbing and all the collected material was recycled in the sixth cupola, which was fitted with the sulphuric acid plant. This technique was abandoned after five years because persistent operational difficulties were encountered that led to unreasonably high costs (higher than the disposal costs). This was an innovative approach, which unfortunately proved impracticable in this case, and therefore cannot be considered as a currently available and technically proven technique in this application. However, the technical difficulties could probably be overcome for future applications, but the economic viability of the technique must be considered in detail.

In stone wool production an alternative to dry or semi-dry scrubbing could be the use of a venturi scrubber system. Good SO_x removal efficiencies (90 – 95 %) can be obtained but the technique is less effective than a bag filter for dust abatement. Also an aqueous waste is generated and the material is difficult to recycle. A small number of installations have been operating this technique successfully for over 20 years. Although it is generally accepted that these scrubbers would not be the preferred choice of technique today, where they exist their continued use is likely to represent BAT.

<p><u>Advantages</u></p> <ul style="list-style-type: none">• Substantial reductions in SO_x emissions can be achieved (depending on the specific sulphur balance and recycling).• Reduced emissions of other substances (chlorides, fluorides, selenium compounds, other acids e.g. boric acid).• In most cases the collected dust can be recycled, reducing the consumption of new raw materials. <p><u>Disadvantages</u></p> <ul style="list-style-type: none">• The technique consumes energy.• The technique results in the generation of a solid residue which if it cannot be recycled increases waste levels. In most cases it can be recycled but this requires adjustments to the process and can limit the overall SO_x reduction efficiency.• The technique involves substantial capital and operating costs.
--

Table 4.25: Main advantages and disadvantages of dry and semi-dry scrubbing

Example Installations

There are many examples of these techniques being used, particularly the dry-process in conjunction with an electrostatic precipitator or bag filter. Most of the furnaces in Germany where secondary dust abatement is fitted utilise these techniques.

4.4.4 Fluorides (HF) and Chlorides (HCl)

In this section all gaseous fluorides and chlorides are expressed as hydrogen fluoride (HF) and hydrogen chloride (HCl) respectively. The vast majority of the halides emitted are in these forms. Emissions of HF and HCl arise from impurities in the batch materials or from batch materials that are selected because they contain these species in sufficient quantities to impart desired product qualities.

4.4.4.1 Reduction at Source

In most processes HF and HCl emissions arise from impurities in the batch materials, which are emitted on melting. Many raw materials contain very low levels of fluorine and chlorine that have little impact on final emission levels. However, some raw materials contain significant levels of these elements as impurities, the main substances of this type include:

- Man-made soda ash, which has a residual NaCl content of approximately 0.05 - 0.15 %.
- Dolomite, which can contain significant fluoride impurities.
- Post consumer glass cullet, which can contain a range of impurities at significant levels, particularly chlorides, fluorides and metals. The amount of these substances varies depending on the purity of the cullet supply, but in regions with high recycling levels the species can gradually build up in the glass.
- Recycled dusts from abatement equipment contain fluoride and chloride salts, which can build up in the system.
- Some fuels (e.g. coke from certain sources) can contain chlorides.

The chloride emissions from those processes using high soda ash levels in the batch (mainly soda-lime glass) are significantly higher than from, for example, glass wool or continuous filament glass fibre (see Chapter 3). Of those processes that do not intentionally include these materials in the batch, the highest emissions of HCl and HF tend to come from flat and container glass processes.

The emission levels can be minimised by the careful selection of raw materials. The issues surrounding NaCl levels in soda ash are discussed in Section 4.4.1.1. A number of the other techniques discussed in Chapter 4 also have beneficial effects on HF and HCl emissions. These are mainly those techniques that reduce volatilisation by lowering temperatures, by reducing airflow and by minimising turbulence. These techniques include:

- Increased cullet usage, which lowers temperature and energy usage, and substitutes for soda ash with its associated chloride impurity. Potentially there is a paradoxical effect if cullet has high HCl or HF levels.
- Electric boost.
- Improved furnace design and geometry.
- Burner positioning.
- Reduced air fuel ratio.
- Low NO_x burner systems.
- Oxy-fuel melting.
- Electric melting.

A number of product types made within the Glass Industry use fluoride containing materials to impart specific properties to the material. The most important examples of this are discussed below.

Continuous Filament Glass Fibre

The production of continuous filament glass fibre generally requires fluoride. The fluoride is added to optimise surface tension and liquidity properties, to aid fiberisation and minimise filament breakage. These are important factors in the economic and environmental performance of the process. High breakage leads to reduced yield and increased waste. The main source of added fluoride is usually fluorspar (CaF₂), significant levels can also be present in china clay (alumina silicate).

A lot of effort has been put into developing formulations without added fluorine and in some cases this has been effective. Some companies have developed the methodology for using a non-fluorine batch formulation on many of their furnaces. Another company has developed in a similar way to use a no added fluorine or boron batch, and dust emissions below 50 mg/Nm³ and HF emissions in the range 10 - 50 mg/Nm³ have been achieved. The optimisation of these techniques can require modifications to the furnace design and may be most effectively implemented at a furnace rebuild.

The developments in low fluorine and low boron glasses are the result of expensive development work and the technology is closely guarded by the companies that have developed it. Therefore the technique is not available immediately to all operators. There are also lengthy and expensive product registration procedures that must be completed for new products with changes in the formulation.

Frit Manufacture

Emissions of fluorides are directly related to the use of fluoride compounds in the batch. Fluorides are predominantly used in the production of enamel frits and are not usually present to any significant extent in the raw materials used for ceramic frit manufacture. Some ceramic frit producers may, periodically, manufacture small quantities of enamel frits in the ceramic frit kilns, giving rise to fluoride emissions, but this constitutes a very small proportion of the operator's overall production. The emission of fluorides is probably the most significant environmental impact of enamel frit production.

Fluorides provide unique properties to the frit, such as improved thermal and chemical resistance, and reduced risk of blistering of the enamel coating. They are added to the batch as fluorspar, fluorosilicate, cryolite or sodium fluorosilicate. Most producers now offer some fluoride free or low fluoride enamels, and the availability of these products is increasing. At the time of writing fluoride free products represent less than 10 % of production, with low fluoride products at about 30 %. The fluoride in the batch cannot generally, be reduced sufficiently to achieve emission levels comparable with scrubbing techniques or other frit types.

Opaque Glasses

Opaque glasses are made in the Domestic, Special and occasionally the Container Glass Sectors. The addition of fluoride causes crystallisation in the glass giving the characteristic cloudy and opaque appearance. The majority of installations producing these products use dry scrubbing techniques to treat the HF emissions. No practicable alternatives are available that produce a comparable quality. In many cases opaque glass is melted in cold top electric furnaces. This lowers the emissions because a significant proportion of the fluoride is absorbed in the batch blanket and less fluoride is needed overall. Also the use of electric melting greatly reduces the volume of waste gas to be treated.

The Special Glass Sector also produces fluorine crown glass, which is an optical product with a very high fluoride content. The production level of this glass is very low and in the EU it is always carried out with waste gas treatment.

In general, measures to achieve reductions at source are preferable to waste gas treatment. With fluorine containing glasses measures to reduce fluorine levels can place severe restrictions on operating conditions and require substantial development resources. Where emission reductions are required by legislation, this has led many producers to favour waste gas treatment and particularly dry-scrubbing.

4.4.4.2 Scrubbing Techniques

The main scrubbing techniques applicable to these emissions are dry scrubbing and semi-dry scrubbing. These techniques and the emission levels achievable are discussed in Section 4.4.3.3 above. The choice of absorbent is important and is sometimes a trade-off between the reduction of SO₂ and the reduction of HF and HCl. In particular there is a competing reaction between HCl/HF and SO₂ with sodium carbonate. The optimum choice will depend on a number of issues including the relative levels of the different pollutants in the waste gas.

Another technique that could be technically and economically viable for very small scale processes (e.g. some frit furnaces) is wet scrubbing, using a packed bed scrubber circulating water or more effectively an alkali solution. The main drawback with this approach is that an aqueous waste stream is generated.

4.4.5 Oxides of Carbon

Oxides of carbon include carbon dioxide (CO₂) and carbon monoxide (CO). Carbon monoxide arises as a product of incomplete combustion and is rarely emitted from Glass Industry installations at a level to cause environmental concern. Significant levels are encountered in stone wool cupolas, but most plants are fitted with an afterburner to oxidise the emissions before release. Carbon dioxide arises from the combustion of fossil fuels or other organic materials, and from the decomposition of carbonate batch materials.

Carbonates such as soda ash and limestone are the main sources of alkali metal oxides and alkali earth metal oxides in glass making. The only real alternative sources of these oxides are post consumer waste and process waste. That is cullet for glass processes, and process wastes,

recycled product and slag (stone wool only) for mineral wool. The issues surrounding these materials are discussed elsewhere in this document, but generally the main factor limiting their use is the availability of adequate quantities of the materials of sufficient quality and consistency of supply. High utilisation of these materials is generally limited to container glass and stone wool.

Carbon dioxide has well known associated environmental effects, but it is not one of the main polluting substances listed in annex III of Directive 96/61/EC. The increasing use of recycled materials within the Glass Industry is driven by the need to save energy and to reduce waste, and the effect on substitution of carbonaceous materials is an added benefit. Similarly, the reduction in emissions of CO₂ derived from reduced fuel usage is driven by the need to reduce energy usage and operating costs, and by the pressure to lower NO_x emissions.

Many techniques discussed in this chapter have important implications for CO₂ emissions, but no techniques beyond those considered for energy and other pollutants are presented for consideration in determining BAT for Glass Industry installations.

4.5 Techniques for Controlling Emissions to Air from Non Melting Activities

This section covers those activities, which are not related to melting or to materials handling. These activities include product forming and any activities carried out on the products, which are generally considered to form part of the main process. In most of the activities in the Glass Industry the melting of the raw materials is the first major activity carried out and so the subsequent activities are sometimes also referred to in this document as “downstream” activities.

Due to the very sector specific nature of the downstream activities, the discussion is presented on a sectorial basis.

4.5.1 Container Glass

The main source of emissions to air from non-melting activities in container glass production is the hot end coating operation. The coating, a very thin layer of metal oxide, is applied by passing the hot containers from the forming machine, through a hood containing vapours of tin or titanium compounds. The most common materials used are anhydrous tin tetrachloride (SnCl₄), anhydrous titanium tetrachloride (TiCl₄), and monobutyl tin chloride (C₄H₉SnCl₃). The emissions consist of HCl, oxychlorides, tin and titanium oxides (SnO₂, TiO₂) as fine particulate, and any unreacted coating materials. Minor emissions of VOCs could also arise from cold coating operations. These emissions are not considered to be very significant and are not discussed further in this document.

The first step in reducing emissions is to minimise the usage of the coating commensurate with the product requirements. The use of the material can be further optimised by ensuring good sealing of the application areas to minimise losses.

There are currently four main options for dealing with the waste gas:

- (a) Extract and emit directly to atmosphere ensuring good dispersion.
- (b) Extract and treat by secondary techniques e.g. wet scrubbing.
- (c) Combine the waste gas with the waste gas from the furnace.
- (d) Combine the waste gas with furnace combustion air.

Option (a) does nothing to reduce the emissions and so is not considered further here. However, where emissions are very low this approach may be considered appropriate in some circumstances. Option (d) may limit some of the primary controls to minimise NO_x and dust emissions, and although not likely to be significant the effects on the glass chemistry may have to be considered. There are no known examples of this approach but it may be appropriate in certain circumstances.

Option (c) may be appropriate where secondary abatement of the furnace waste gas is applied. Where the collected material is recycled consideration may have to be given to the effects of the metals on the glass and to the build up of chloride in the system. These considerations may limit the recycling of the dust in some cases. Where secondary abatement is not applied the approach only represents a dilution of the emissions.

As discussed elsewhere in this document wet scrubbers can be effective in reducing gaseous emissions but their effectiveness in treating fine dusts is limited by the pressure drop across the system. The performance will depend on the inlet composition, but a single stage scrubber may be sufficient to achieve compliance with local requirements. If further reductions were desired then either a bag filter followed by packed bed scrubber, or a venturi scrubber followed by packed bed scrubber. These techniques could be expected to reduce HCl to less than 10 mg/Nm³, particulates to 5 - 10 mg/Nm³, and total metals to 1 - 5 mg/Nm³. Where HCl is present as an aerosol emissions of less than 30 mg/Nm³ could be expected. The costs of these alternatives will depend on the waste gas volume. Local circumstances may mean that comparable figures can be achieved with less sophisticated methods. If further reductions were desired then either a bag filter followed by packed bed scrubber, or a venturi scrubber followed by packed bed scrubber could be used.

4.5.2 Flat Glass

In general, the emissions to air from non-melting activities in flat glass production are very low and do not require abatement measures. If the float bath is correctly operated there are no appreciable emissions of tin vapours. SO₂ is used at the beginning of thelehr but again if the process is properly operated emissions are insignificant. The only other potential emissions are combustion products from natural gas heaters in thelehr. The exception to this is where on-line coating processes are carried out. The emissions from these processes are very case specific and an actual example is used here to describe the techniques that can be used.

The raw materials for this coating process are: tin tetrachloride (SnCl₄), hydrofluoric acid (HF), methanol (CH₃OH), and a silane (SiH₄). There are two separate coating stages a SiCO undercoat and a fluorine doped tin oxide topcoat. Emissions from the undercoat stage pass through a thermal incinerator to destroy any organics, the waste gas is cooled and the solids (amorphous silica) are removed by a bag filter. The collected material is recycled to the furnace.

In the top coating stage the waste gases, which contain halides and tin compounds, are passed through a high temperature reactor to oxidise the tin compounds. The solid tin oxide is removed by an electrostatic precipitator and the halides are removed in a packed bed chemical scrubber. The emission levels achieved are:

Particulates	15 mg/Nm ³
Hydrogen Chloride	5 mg/Nm ³
Fluorine and its gaseous compounds as HF	<1 mg/Nm ³
Metals	<5 mg/Nm ³

In general, the emissions from these types of activities can be controlled using a combination of the techniques listed below, in some cases other equally effective techniques may be appropriate.

- Dust abatement equipment bag filter or EP, although a bag filter is likely to give lower emissions (1 - 5 mg/Nm³).
- The techniques above can be combined with dry scrubbing.
- Wet chemical scrubbing.
- High temperature oxidation, thermal incineration or similar.

Costs are site specific but are not generally considered to be disproportionate to the results obtained.

4.5.3 Continuous Filament Glass Fibre

Emissions to air from non-melting activities in this sector arise from four main sources:

- Application of the coating to the fibres.
- Cake drying.
- Cutting and Milling.
- Secondary processing.

Emissions to air from the coating application are usually quite low due to the low volatility of the coating materials and the low glass temperatures at the point of application. An important aspect of this is the selection of coating materials with low levels of organic solvents. However, some volatile species will be present either as solvents or as by-products of the reactions. The coating materials used vary widely between products and installations, but material selection is the most effective method of reducing emissions. The high volumes of air necessary to cool the glass make it very difficult and expensive to control VOC emissions by secondary measures.

The high airflows result in some carry over of droplets and encourage volatilisation of any VOC present. Wet scrubbing systems are often used to control the waste gas but the effect on volatile substances will be limited to condensation. Wet electrostatic precipitators could also be used in this application but no examples of this are known. Costs of wet scrubbing and wet electrostatic precipitators will be similar to those quoted for the Mineral Wool Sector. The emission levels achieved will depend entirely on the case specific starting levels; some maximum figures are given in Chapter 3.

The wet cakes are usually dried in ovens and any species volatile at these temperatures will be emitted with the water vapour. In general, the molecular weights of the materials are quite high and a significant proportion of any volatile substances will have been emitted during coating application. Little information is available on emission levels (see Chapter 3) and currently the only technique used to minimise emissions is material selection. The waste gas volumes are quite small and standard control techniques could be used if significant releases were identified, for example, incineration, adsorption, and scrubbing. No cost information is available for these techniques in this application, but such techniques are readily available for low gas volumes. However, it will always be preferable to control such emissions by optimisation of the coating formulation before any abatement techniques are installed.

Dust emissions arising from cutting and milling can be readily treated by extraction to a filter system. This is the standard technique used throughout the sector and emissions in the range 1 - 5 mg/Nm³ can be achieved.

Secondary processing can involve the use of further coating or binder materials. The emissions are very case specific and standard abatement techniques for VOCs and trace gases can be used if primary measures do not achieve the required performance level.

4.5.4 Domestic Glass

In the majority of domestic glass processes there are no significant emissions to air from the activities downstream of the furnace. A number of burner systems are used to maintain the correct glass temperature, for fire polishing and in the annealing lehr, but there are no significant emissions requiring specific controls. The exception to this is the production of articles that require cutting and polishing, particularly full lead crystal, lead crystal and crystal glass.

Cutting involves carving precise patterns on the blank glass articles using diamond impregnated wheels, either by hand or automatically. Other cutting and grinding activities such as edge grinding can also be carried out. Water is usually used as a coolant for cutting and to prevent dust emissions. Extraction may also be provided to remove any mist from the coolant. Where these activities are carried out under a liquid coolant there are no appreciable emissions to air although a mist eliminator may be necessary on the extraction system. If dry cutting or grinding operations are carried out the dust can be extracted and passed through an efficient bag filter system to give dust emissions in the range 1 - 5 mg/Nm³.

Glass cutting produces a grey, unfinished surface on the glass. The glass surface is restored to its original appearance by immersion in a polishing bath of hydrofluoric and sulphuric acids. Fumes of HF and SiF₄ are released from the surface of the polishing bath. The most effective way of treating these emissions is usually wet scrubbing either with water or a chemical solution. During this operation, hexafluorosilicic acid (H₂SiF₆) is formed (up to 35 %), and the acidic scrubber liquor requires neutralisation. As an alternative, H₂SiF₆ can be recovered and, where feasible, used as a feedstock in the chemical industry.

Very low emissions levels can be achieved with wet scrubbers in these applications <5 mg/Nm³ of HF. Due to the very acidic nature of the emissions there is a high solubility in water and chemical scrubbing is unlikely to be necessary. Chemical scrubbing results in lower water usage but prevents the recovery of H₂SiF₆ from the effluent. Alternative techniques to acid polishing are under development, e.g. mechanical polishing, and high temperature polishing either with flames or lasers, but at the time of writing these techniques cannot be considered as available.

4.5.5 Special Glass

In general, there are no significant emissions to air from standard downstream activities in this sector. TV glass production involves grinding and polishing activities but these are carried out under a liquid medium and should not give rise to any emissions to air. If TV glass or any other products undergo any dry cutting, grinding or polishing, the emissions can be controlled by extraction to a bag filter system to give dust emissions in the range 1 - 5 mg/Nm³. This is a very diverse sector and there may be activities at some installations, which require site specific consideration.

4.5.6 Mineral Wool

Emissions from non-melting activities in the Mineral Wool Sector arise from four main activities: forming, curing, product cooling, and product machining and packaging. Chapter 3 shows that the emissions from forming and curing are the most significant. These emissions are largely related to the use of the phenolic resin based binder system.

The techniques in this section have been described separately for the forming area and the curing area, for convenience and because the nature of the waste gases differ. However, several of the techniques are applicable in both areas and, particularly in glass wool production, it can be advantageous to combine emissions for abatement. Where this is the case the techniques are described most thoroughly for the forming area section and cross-references made for curing.

There are several important differences between line emissions from glass wool and stone wool processes and these are discussed in the sections relating to the techniques to which they are most relevant.

4.5.6.1 Forming Area

In the forming area the glass or stone melt is fiberised and the binder is applied. The resin coated fibre is directed onto a collection belt that is under suction. In glass wool processes water is sprayed into the extraction ducting and into the fan. This performs two functions, the prevention of material build up in the ducting and the removal of some particulate and gaseous components from the gas stream. Stone wool processes vary in their use of in-duct water sprays some are comparable with glass wool plants but many use no water sprays at all. Stone wool cupola campaigns last only a few weeks, and so there is an opportunity to clean out the ducting, and water sprays are not always deemed necessary.

The forming area waste gas is likely to contain significant levels of particulate matter, phenol, formaldehyde and ammonia. The particulate matter consists of both inorganic and organic material, often sticky and with a very small particle size. Lower levels of VOCs and amines may also be detected if they are included in the binder system. Due to the nature of the process the gas stream is slightly above ambient temperature, has a high volume and (if in-duct water sprays are used) is saturated with water. These properties combined with the nature of the pollutants limit the number of abatement techniques that may be applied.

The releases can be affected significantly by a number of factors but particularly:

- binder system chemistry;
- fiberising technique;
- operating conditions (temperature, airflow and moisture);
- level of binder applied; and
- the method of binder application.

The optimisation of these parameters, in conjunction with in duct water sprays can significantly reduce process emissions. The chemistry of the binder system is one of the most important factors and has major implications for the process water system and for forming, curing and cooling emissions. The binder systems vary between operators and are not generally well understood outside of the sector. These systems can be very site specific and may need to be considered on an individual basis. The section below summaries some of the main issues.

Resin and Binder Chemistry Considerations

Optimisation of the chemistry of the binder system and the efficiency of the method of application can have a substantial effect on the releases to the environment. The binder also represents a high proportion of the cost of the final product. Therefore, the process operators consider developments in binder chemistry and application techniques to be highly confidential.

The binder is made up of water, phenolic resin, urea, ammonium sulphate, ammonia, silane, mineral oil, silicone oil and possibly other ingredients particular to the individual process. The resin is essentially a phenolic resole consisting of a mixture of trimethylol phenol, dimethylol phenol, formaldehyde, minor reaction products of phenol and formaldehyde, and traces of phenol. The resin is water based and is typically 50 % solids. An excess of formaldehyde is used in the reaction to achieve a low free phenol level.

Some resins are amine catalysed and can give rise to significant levels of gaseous amine in the waste gas. These emissions can be virtually eliminated by using other species as catalysts in resin production. A number of substances can be used but the precise details of optimised

systems are generally considered as proprietary knowledge. By using non-amine catalysed resin systems emission levels of less than 5 mg/Nm³ can be achieved. If a company does not have sufficient in-house expertise to develop a non-amine catalysed resin then such systems are readily available from specialist resin suppliers.

Urea is reacted with the resin to extend the resin, to reduce free formaldehyde levels and also has the effect of improving the fire resistance of the final product. The urea reacts with the free formaldehyde in the resin to form methylol ureas, which in turn will react with the active sites on the phenolic resin and take part in the cross-linking mechanism during curing. The urea is acting as a substitute for phenol and results in a cheaper binder. Therefore, there is an incentive for the operator to maximise the amount of urea in the resin, up to the point where product quality or processing parameters are adversely affected.

Urea has two main drawbacks, it reduces the solubility of the resin, and it can breakdown in both the forming area and the curing oven to form ammonia. Environmentally the maximisation of urea usage is beneficial because it reduces formaldehyde releases, it replaces phenol, and the urea breakdown products are preferential to the phenolic derivatives and partial combustion products that would otherwise be emitted.

Ammonia plays several important roles in the binder system and allows a degree of flexibility, which is important in optimising the process as a whole. Ammonia improves the solubility of the binder enabling more urea to be added and allowing the binder to be stored for longer. It also helps to maintain the system pH in the correct range and reacts with any free formaldehyde. The nature of the process is such that higher than normal releases of ammonia may occur for short periods. The effects of reducing the ammonia levels in the process can be disproportionate to the effects on the rest of the process, and higher ammonia release levels may result in lower overall emissions.

Ammonium sulphate is added to control the curing of the resin. Silane provides a vital interface between the inorganic glass and the organic binder. Silane hydroxyl groups interact with the glass oxides, and the organic functional group reacts with the resin to form a strong bond. Mineral and silicone oils are added to improve the product handling characteristics, to suppress dust formation, and to provide a degree of water repellence.

When the binder is applied to the hot glass in the forming area the volatile components (e.g. ammonia, formaldehyde, and phenol) will be vaporised and extracted to the release point. The level of volatile releases will be a function of the amount of unreacted volatile material in the binder, the dilution of the binder, the temperature in the forming hood and the temperature of the glass. The binder is applied as a fine spray and any droplets that are not retained on the mat will be released in the extracted air. The extent of binder retention on the product will depend on droplet size distribution, the mat thickness and the level of suction applied.

Several alternatives to phenolic resin based binders have been evaluated, but none have been found to give acceptable product quality.

4.5.6.1.1 Impact jets and cyclones

Description of technique

An important factor in considering appropriate abatement systems for the forming area is the water content of the gas stream. The continuous nature of glass wool production requires the use of a cleaning mechanism to prevent the build up sticky organic material and fibre in the extraction ducting and in the fan. The normal technique applied is in-duct water spraying, which can take various forms. The discontinuous nature of stone wool cupola production (campaigns of 1 to 3 weeks) provides the opportunity to clean the ducting if required. Also stone wool production involves relatively less binder usage per unit volume of product and so the build up

is slower. Some stone wool processes utilise water sprays in the forming area, but this is largely due to operator preference or to site specific operating requirements.

Where water sprays are used to clean ducting it is logical to optimise their use to also clean the waste gas. In this situation the two objectives are entirely complimentary, the more material removed from the waste gas, the more effective the cleaning function. The systems have generally been adapted beyond the minimum necessary to prevent unacceptable build up in the ducting. Within the sector the term impact jets is used to describe this optimised technique.

In order to optimise the efficiency of gas cleaning the systems can apply the water in high volume and at high pressure, but this does not produce a significant pressure drop. The design of the impact jets will differ between processes but is intended to optimise the efficiency of the technique, for both duct cleaning and waste gas scrubbing. To remove the entrained water from the waste gas impact jets are always combined with cyclones (or other devices), which also have an effect on particulate levels depending on the design as described in Section 4.4.1.4.

Particulate and droplet removal will occur by impaction/impingement and to a lesser extent by diffusion. Some systems may involve a narrowing of the duct to improve the removal efficiency, but the particulate removal efficiency is predominantly dependent on pressure drop, which is low for all these systems.

Gaseous substances will be partially absorbed by contact with the water. The efficiency of gas absorption depends on: the difference between the partial pressure of the gas in the waste gas stream and the vapour pressure of the gas in the liquid; the solubility of the gas in the liquid; the surface area for contact; and to a lesser extent the contact time. There will also be a condensation effect, which can be important if the waste gas is warm.

Process water is usually used for impact jets, which already contains most of the substances present in the gas stream in varying quantities. This will particularly affect the efficiency of gaseous substance removal. The recycling process water is filtered before it is reapplied but will contain significant levels of soluble materials. The system is a dynamic equilibrium, and the process water system is described later in this document.

Environmental Performance

Due to the low pressure drop the removal efficiency for fine particulate matter and droplets is quite low. However, in the forming area a significant amount of the solid material is quite large and fibrous, and is easily removed by the impact jets and cyclones. The final emissions are very dependent on the binder and process water chemistry, and on the amount of binder applied. The figures that are achieved using this technique are given in Table 4.29.

Financial considerations

Costs for this technique are given in Table 4.30 and depend largely on the airflow and plant size. The costs of the technique as an abatement measure are difficult to assess, because where impact jets are used some form of cleaning mechanism is an inherent requirement of the process. The costs given in the table represent the total cost for the system. There are no examples of systems being implemented just to clean ducting they are always installed for the dual purpose. It is estimated that the gas cleaning element represents 60 % of the total cost. However, this analysis is somewhat academic, because in most Member States completely unabated emissions would not be permitted and other abatement costs would be incurred.

Applicability

In principle this technique is applicable to all glass wool and stone wool processes. It is not used in many stone wool plants because it is not deemed necessary for process cleaning, and could

adversely affect other abatement techniques being used. For forming area emissions impact jets and cyclones are used in approximately 90 % of glass wool plants and 10 % of stone wool plants.

Associated considerations

Unless another technique such as packed bed scrubbing is used, cyclones (or sometimes an alternative device) are incorporated with impact jets to remove entrained water. This is necessary to reduce water consumption, and to achieve acceptable levels of plume visibility and dispersion. Where other wet techniques are used (e.g. wet EPs or packed bed scrubbing) impact jets are generally used upstream.

Example Installations.

This technique is so widely applied that it is not useful to specify example plants.

4.5.6.1.2 Wet scrubbers

Description of technique

Wet scrubbing systems can be used to control both gaseous and particulate emissions. Whilst the basic technology for both of these is similar, the design criteria for particulate or gas removal are very different. However, to keep down capital costs wet scrubbing systems are often used to control mixed emissions of particulates and gases. The design is inevitably a compromise, but may represent BAT where separate control systems are prohibitively expensive. Wet scrubbing is a well documented technique and only the main principles and the issues specific to this sector are discussed here.

Particle collection by liquid scrubbing occurs by three main mechanisms: inertial impaction, interception and diffusion. Trace gas removal by wet scrubbing occurs by absorption and to a lesser extent condensation. Absorption involves mass transfer between a soluble gas and a solvent in a gas-liquid contacting device.

The particle collection efficiency of wet scrubbers is strongly dependent on the total energy usage, particularly on the pressure drop across the collection zone. If the liquid is evenly dispersed within the scrubber, similar pressure drops will often give similar efficiencies on the same dust for quite different scrubber designs. Thus, it is not possible to design a wet scrubber which has high efficiencies on particles of 1 μm and below, and which does not have a high pressure drop. High energy scrubbers can give good collection efficiencies for particles of $<0.5 \mu\text{m}$, but the high running cost mean that alternative techniques may be more economical.

The efficiency of gas absorption depends on: the difference between the partial pressure of the soluble gas in the waste gas stream and the vapour pressure of the gas in the liquid; the solubility of the gas in the liquid; the surface area for contact; and to a lesser extent the contact time. There will also be a condensation effect, which can be important if the waste gas is warm. Solubility obviously depends on the gas and the liquid. Water is suitable for absorbing soluble acidic gases such as hydrogen chloride, hydrogen fluoride, silicon hexafluoride, and for ammonia. Alkaline or acid solutions are suitable for absorbing less soluble gases, and in some applications oxidising solutions can control organic odours. The surface area is determined by the packing material or droplet size.

Packed bed scrubbers consist of an outer shell containing a bed of packing material on support grids, liquid distributors, gas and liquid inlets and outlets, and a mist eliminator. Liquid is distributed continuously over the packing material forming a film, which provides a large surface area for gas/liquid contact. The dirty gas stream flows through the packed bed and the liquid and gas flow may be counter current, concurrent or cross current. There are various types

of packing material, which can be packed in random or regular arrangements. The liquid film over the packing material provides a large surface area for mass transfer. Counter current packed bed absorbers maximise the driving force for absorption because gas leaving the packed bed encounters fresh absorbing liquid. Packed beds can become blocked by insoluble particulate matter, scale and biological growth.

In some applications venturi scrubbers may be considered. The characteristic feature of a venturi scrubber is the constriction to the duct (venturi throat) causing an increase in gas velocity. Liquid is introduced to the scrubber and forms a film on the walls, which is atomised by the gas stream in the venturi throat. The efficiency of the venturi scrubber depends on the pressure drop, and consequently they have high power consumption and operating costs. Venturi scrubbers are generally the most efficient wet scrubbing devices for particle collection, because they are suitable for sub-micron particles. They can also be used for trace gas removal but efficiency is limited by low contact time.

The most commonly used wet scrubbers within the sector are packed bed scrubbers, usually with impact jets upstream. The impact jets remove the larger particulate matter and so help to prevent blocking of the packing. Some operators have installed ionising wet scrubbers (IWS), which are intended to combine the advantages of the low capital cost of wet scrubbers, with the low operating costs of electrostatic precipitators. The IWS is basically a packed bed scrubber maintained in a neutral charge condition and preceded by an ionising section to charge the particles. The bed is normally composed of plastic packing. Gas velocities through the bed are low so as to ensure that the particles spend as much time as possible close to the packing elements.

When the forming area waste gas comes into contact with water in an efficient scrubbing system the following events will occur:

- a proportion of the entrained particulate matter, predominantly the larger particles and droplets will be held in suspension;
- a proportion of any soluble resinous material will be absorbed by the water, and
- the volatile substances will form an equilibrium between the gaseous and aqueous phases.

Process water is the most commonly used scrubber liquor within the sector. This presents the potential problem of maintaining sufficiently low concentrations of volatile materials in the scrubbing medium to facilitate efficient absorption, and to prevent release back to the gas phase. The mineral wool manufacturing process is a net consumer of water, and the performance of the scrubber can be improved by introducing the clean water top up into the system in the scrubber. This benefit can be optimised by using a combined multi-stage scrubbing process with the water flowing from stage to stage counter-current to the gas stream. In this way the dirtiest water is used to scrub the incoming (dirtiest) gas stream and clean water is used in the final scrubbing stage.

A possible solution to the problem would be to separate the scrubbing medium from the process water system and either: use clean water with a sufficiently high purge to maintain efficient absorption; or chemically dose the scrubber liquor with substances that would react with the volatile species. However there are important limitations to both these approaches. To achieve substantially better performance by using a clean water system, the volume of the purge would be too great to recycle to the process water system, and would give rise to a new waste stream requiring separate treatment. The volume of water coming from the impact jets would exacerbate this problem.

The water content and resinous nature of the waste gas would cause blocking and scrubber liquor volume problems in a chemical scrubber unless a high volume purge was used. Due to the chemical content none of this could be recycled to the process water system, again giving rise to a new waste stream requiring separate treatment. A further complication is that the

chemical reagents necessary to remove phenol/formaldehyde and ammonia are incompatible and would require separate stages. Chemical scrubbing stages could be positioned in series with a process water scrubber, but this would greatly increase costs and unless it was extremely efficient would not overcome the problems discussed. Also, when the aqueous waste stream is considered the difference in overall emissions between such a technique and a process water scrubber with good process control is likely to be limited.

Multistage scrubbing either in a combined unit or in separate units is in theory a potential option for the forming area and for combined forming and curing oven emissions. However, no mineral wool processes are operating multistage scrubbers and so no information is available on environmental performance, costs or potential operating problems. Therefore, the technique cannot currently be considered to be fully available. It could however, be considered as an option if line emissions are very high at a particularly installation.

Environmental performance

The emission levels achievable with packed bed scrubbers (with process water as the scrubber liquor) in the mineral wool industry are given in Table 4.29. The performance is limited for particulate by the low pressure drop, and for gaseous substances by the use of process water as the scrubbing medium. Significantly lower emission levels for phenol, formaldehyde and ammonia would be expected with clean water scrubbing. The process water equilibrium is a critical factor and it is possible in some rare instances (e.g. low binder product following sustained period on high binder product) that the efficiency of the scrubber could be negative for gaseous components.

Several operators have used ionising wet scrubbers in recent years, but overall results have been disappointing. Improvements in efficiency over packed bed scrubbers have generally been less than 10 %.

There is no experience of chemical or multistage scrubbing in this sector but experience in the chemical industry suggests emissions below 10 mg/m³ could be readily achieved for phenol, formaldehyde and ammonia, if the associated problems could be overcome. Compared with the figures in Table 4.29 this only represents a significant improvement for ammonia.

Financial considerations

Costs for this technique are given in Table 4.30 and depend largely on air flow and plant size. Incorporation of an ionising stage as in the IWS involves an increase in capital costs of approximately 75 %, and an approximate 10 % increase in operating costs. Multistage chemical scrubbing could be expected to cost up to twice the figures given in the table. The cost of a combined multistage scrubber would probably be more comparable. However, it would be necessary to completely separate the stages, which would add to the cost, and more expensive corrosion resistant materials may be necessary.

Applicability

In principle packed bed scrubbers circulating process water are applicable to all processes within the sector. The technique is not limited to new plants or substantial modifications, but costs are likely to be higher for existing installations. In some applications, particularly stone wool, other techniques can be used to achieve similar or lower emission levels.

In glass wool production slightly less than 20 % of installations use packed bed scrubbers, either for combined forming area and curing oven emissions or just for the forming area. In stone wool production packed bed scrubbers are used for approximately 10 % of installations for forming area emissions and the same for the curing area. Emissions from the two areas are not generally combined in stone wool installations.

Associated considerations

An important consideration for wet scrubbers is the potential cross media effect of creating an aqueous waste stream that requires treatment. In the Mineral Wool Sector this problem has been avoided by using process water as the scrubbing medium, with 100 % recycling to the process water system. The use of clean water or chemical scrubbers would result in an aqueous waste stream.

A benefit of this technique is the opportunity to combine the forming area and curing oven emissions in a single treatment stage. The volume of the forming area waste gas is generally ten times greater than that of the curing oven. If implemented at the design stage the combination of the waste gases does not add substantially to the overall cost of the technique.

Example installations

Owens Corning Building Products (UK) Ltd, St Helens, UK.
Pfleiderer Delitzsch, Germany
Isover Orange, France

4.5.6.1.3 Wet electrostatic precipitators

Description of technique

The basic principles and operation of EPs are described in Section 4.4.1.2. In wet precipitators, the collected material is removed from the collector's plates by flushing with a suitable liquid, usually water, either intermittently or by continuous spray irrigation. The three main types plate and wire, plate and plate and tube and wire, can all be operated wet. In plate types the gas flow is horizontal, in tubular designs gas flow is vertical with the liquid flow counter current to the gas. In some more robust designs rods replace the wires. Some mechanism is usually installed to remove water droplets before discharge either a demister or sometimes the last field can be operated dry.

Whilst in general dry precipitation is preferable, wet precipitators are useful for removing dust from wet gases with temperatures close to the dew point and for collecting liquid aerosols and sticky materials such as resinous particles and tars. The performance of wet precipitators is less dependent on particle properties as the moisture present in the gas precipitates readily and will assist the precipitation of a difficult dust.

Tubular units are most commonly used in wet applications and it is easier to make them explosion resistant if tars are present. However, tubular units generally have only a single electrical field and are less suitable for achieving very high efficiencies. All three types have been used in mineral wool manufacturing but the plate and wire and tube and wire types are now preferred. Usually a deluge system is installed to extinguish fires.

At the entrance of the WEP, the exhaust gases must be well distributed to produce a uniform and low gas velocity between all elements. The waste gas is conditioned by the impact jets upstream of the EP, large fibrous material is removed and the gas is saturated and cooled. To ensure operation within the design parameters clean water is also used, it is sprayed at the entrance to the EP to ensure saturation and it is used to clean the electrodes. In glass wool processes the volume of this water is generally low enough to be discharged to the process water circuit, and may represent the main top up in the circuit. In most stone wool processes the evaporation potential from the forming process is much less and it is not possible to use such a volume of clean water.

Environmental performance

Wet EPs are efficient in removing particulate matter, aerosols and droplets in the size range 10 μ m to 0.01 μ m. Performance will depend on a number of factors particularly the gas velocity. A new purpose designed wet EP would achieve a removal efficiency of >98 % for total particulate matter >1 μ m in diameter, although removal efficiency falls off rapidly for particles <1 μ m. Performance may decline over the lifetime of the equipment and maintenance is very important.

In general, wet EPs show limited efficiency at removing gaseous substances. This depends very much on the product range, and the binder and process water chemistry. However, due to the high degree of saturation and the use of a substantial amount of clean water, some absorption of gaseous substances does occur.

The figures that can be achieved using this technique are given in Table 4.29.

Financial considerations

Costs for this technique are given in Table 4.30 and depend largely on air flow and plant size.

Applicability

In principle the technique is applicable to new and existing, glass and stone wool processes. The main disadvantage for stone wool is the potential difficulty of disposing of the aqueous effluent stream. The technique is suitable for both forming area and curing oven emissions, and for combined emissions. In 1997 approximately 30 % of glass wool installations were using this technique for either separate or combined forming and curing oven emissions. No stone wool plants were operating wet EPs.

Associated considerations

Advantages:

- Good removal efficiencies for particulates and for droplets/aerosols, <20 mg/m³ achievable.
- Absorption of gaseous substance is possible with high saturation and clean water use.
- Applicable to forming and curing emissions.
- Low pressure drop hence relatively low operating costs and energy usage.
- Blockages rare if impact jets used to remove large fibrous matter.
- Long operating life with low maintenance.

Disadvantages:

- Generation of aqueous effluent, this is generally recyclable in glass wool but less so in stone wool production.
- Energy is consumed, but this is relatively low compared to other process requirements.
- Relatively high capital costs.
- Substantial space requirements.
- Maintenance is low but critical; poor maintenance causes considerable drop in performance.
- High voltage imposes safety requirements.

Table 4.26: Main advantages and disadvantages of wet EPs

Example installations

Owens Corning Building Products (UK) Ltd, St Helens, UK.
G + H, Speyer, Germany
Isover Etten-Leur, Netherlands

4.5.6.1.4 Stone wool filters

Description of technique

Conventional passive filtration processes (e.g. bag filters) are unsuitable for treating the waste gases from forming area and curing oven operations. The adhesive and sometimes moist nature of the gas would lead to rapid blinding, even with intensive cleaning and maintenance. In stone wool activities, where forming processes are often dry, stone wool slab filters can be employed. These consist of a steel or concrete housing in which stone wool slabs mounted on cassettes act as a filtration medium. This type of filter has good removal efficiency for particulate matter and binder droplets, but has a low efficiency for the removal of gaseous components. The filtering medium needs to be exchanged periodically in order to maintain particulate removal efficiency and prevent increased resistance to the airflow. The used filter slabs can usually be recycled to the furnace if a briquetting process exists on site.

Operation can be on a semidry basis but overall efficiency is greatly improved if the operation is dry. Neither system generates an aqueous waste stream, and the moist filter slabs can also be readily recycled through a briquetting process.

An earlier version of this design was based on a tower filter with stone wool rolls as the filter medium. This technique is less efficient and has been largely superseded by the slabs mounted on cassettes design. The tower filter design was more suitable for more moist higher binder content waste gases but could not handle waste gases treated with impact jets.

Environmental performance

Stone wool filters are very efficient in removing particulate matter and droplets/aerosols. The emission figures that can be achieved using this technique are given in Table 4.29. The technique does not have a significant effect on gaseous substances, but in combination with primary controls (e.g. dry operation) and a low aerosol emission the levels shown in the table are achieved. This also leads to very low plume visibility from this type of filter.

Financial considerations

Costs for this technique are given in Table 4.30 and depend largely on air flow and plant size. Capital costs are particularly low, and the low pressure drop leads to low operating costs compared with other conventional filter systems.

Applicability

This technique has been mainly limited to stone wool process forming areas, although there are also some applications in stone wool curing ovens. The technique is applicable to both new and existing stone wool processes. 90 % of stone wool processes use this technique for treating forming area waste gases, and slightly less than 10 % use it for curing oven emissions. The limited use for stone wool curing ovens is partly due to the high temperature of the gas, but also due to the wide spread use of incineration.

There are no known applications of the technique in glass wool processes. The main reasons the technique is not used in glass wool processes are discussed below.

The continuous nature of glass wool production requires the use of a continuous cleaning mechanism to prevent material build up in the extraction ducting and in the fan. The normal technique applied is impact jets. These are not generally used in stone wool production, because the discontinuous nature of the process provides the opportunity to clean the ducting. Also stone wool production involves relatively less binder usage and so the build up of material is slower.

In the stone wool process fibre is usually collected as a mat of constant thickness, which is then layered on a separate forming conveyor, to give the desired product properties. The primary mat is thin, imposes only a small, constant pressure drop and enables a single relatively low volume extraction system to be used. In glass wool manufacturing a single conveyor forming system is used. The mat thickness increases along the forming conveyor and varies depending on the product. The change in differential pressure along the conveyor necessitates the use of several extraction systems of different capacity and the overall air extraction must be reasonably high pressure, variable and controllable. The level and distribution of extraction is an important process control tool, which is frequently varied by process operators. The variable higher volume and higher pressure conditions of the glass wool waste gas are not ideal for filtration systems.

The water saturated high binder content of glass wool forming area waste gas would cause the stone wool filter to block rapidly. This would necessitate frequent filter medium changes and would give rise to a high level of wet waste requiring recycling or disposal.

A further complication with the use of mineral wool filters in glass wool processes, is the greater difficulty in recycling the material to the furnace. Recycling fibrous wastes in mineral wool furnaces is discussed in Section 4.7.

Associated considerations

Advantages:

- Good removal efficiencies for particulates, <math><20 \text{ mg/m}^3</math> achievable.
- Used filter slabs can be recycled to the process, if facilities are available.
- No aqueous waste is generated.
- Low capital costs.
- Low pressure drop hence relatively low operating costs and energy usage.

Disadvantages:

- Energy is consumed, but this is relatively low compared to other secondary techniques.
- Limited removal efficiency for gaseous substances.
- Not considered applicable for glass wool processes.

Table 4.27: Main advantages and disadvantages of stone wool filters

Example installations

Rockwool Lapinus, Roermond, Netherlands.

Partek Rockwool, Hallekis, Sweden

4.5.6.2 Curing Oven.

The wet product mat enters the oven, which is at approximately 250°C. The moisture is driven off along with any volatile material, and the binder begins to cure. The temperature and residence time in the oven is critical. The binder must be adequately cross-linked but not over cured or the product quality will suffer. The emissions from the oven will consist of volatile binder materials, binder breakdown products and combustion products from the oven burners. In general, glass wool products contain relatively higher binder levels than stone wool products resulting in higher emissions. Oven emissions also tend to be odorous if not treated.

The oven is usually gas fired and under extraction. Oven emissions are sticky and represent a potential fire risk due to the deposition of combustible material in the extraction system, particularly in glass wool ovens. To prevent fires the gas stream must either be water scrubbed

or additional heat provided to destroy the sticky nature of the pollutants. In those processes without incineration water is usually sprayed into the extraction ducting to prevent the build up of resinous material, and to prevent fires. The water sprays will also remove some of the material entrained in the gas stream.

4.5.6.2.1 Impact jets and cyclones

Description of technique

The technique is described in Section 4.5.6.1.1 above, but there are several other issues that should be considered. The waste gas from the oven has a much lower volume and a higher temperature than the forming area waste gas. Therefore, particularly in glass wool processes the build up of resinous material in the ducting represents a risk of fire and even explosion. The water sprayed into the gas has a substantial cooling effect, and some substances are condensed from the waste gas. This does not necessarily mean the substances are removed and in the early parts of the system material will be volatilised from the dirty process water.

Environmental Performance

Due to the low pressure drop the removal efficiency for fine particulate matter is quite low. As in the forming area the system is a dynamic equilibrium and gaseous emissions are heavily dependent on the process water and binder chemistries. The figures that are achieved using this technique are given in Table 4.29.

Financial considerations

Costs for this technique are given in Table 4.30 and depend largely on air flow and plant size. The issues relating to how much of the cost can be considered as an abatement cost are the same as for the forming area.

Applicability

As for the forming area, in principle this technique is applicable to all mineral wool processes. It is not used in many stone wool plants because it is not deemed necessary for process cleaning, and could adversely affect the performance of other techniques. For curing oven emissions impact jets and cyclones are used in approximately 90 % of glass wool plants (often combined forming area and oven emissions), and in around 10 % of stone wool plants either separately or in combination with other wet techniques.

4.5.6.2.2 Wet scrubbers

The technique is described for the forming area in Section 4.5.6.1.2, and the discussion is equally applicable to oven emissions. The main considerations for curing oven emissions are that the volume is much smaller and pollutant concentrations differ; in general particulate is lower, phenol is comparable but ammonia and formaldehyde are significantly higher.

The emission levels achievable with packed bed scrubbers (with process water as the scrubber liquor) in the mineral wool industry are given in Table 4.29, see Section 4.5.6.1.2 for discussion. Oven emissions are relatively higher in gaseous emissions compared to forming area emissions, so the overall efficiency may be higher. Again this will depend on the amount of clean water used and the binder and process water chemistry.

The costs for this technique are given in Table 4.30 and depend largely on air flow and plant size. The costs given are for combined forming and curing emissions. Most examples of curing

oven emissions treated by wet scrubbers are for combined emissions, and due to the low volume the extra cost is usually low. The variation in the cost given is largely related to airflow, and a rough estimate for treating the curing oven emissions alone can be made by scaling down the cost, but the cost relationship is not linear.

In principle the technique is applicable to all plants, see Section 4.5.6.1.2 for discussion.

4.5.6.2.3 Wet electrostatic precipitators

The technique is described for the forming area in Section 4.5.6.1.3, and the discussion is equally applicable to oven emissions. The use of wet EPs to treat only oven emissions is not common, and usually systems are for combined emissions. Due to the higher relative concentrations of gaseous and odorous substances in oven waste gas the wet EP would not be the first choice of abatement technique for oven emissions alone. However, when combined with forming area emissions and the inherent dilution this involves, a wet EP can be a logical option.

The emission levels achieved with this technique are given in Table 4.29, and the costs in Table 4.30. In principle the technique is applicable to both new and existing installations.

4.5.6.2.4 Waste gas incineration

Description of technique

Incineration is widely used for controlling organic emissions from industrial processes. It has the disadvantages of destroying the material (preventing recovery), can often require energy addition and produces carbon dioxide and oxides of nitrogen. However, it can be designed to be energy efficient and may form an integrated part of the heat supply to drying or curing operations. Incinerators can be of two types thermal incinerators ($>750^{\circ}\text{C}$), or catalytic incinerators (350 to 400°C)

Thermal incineration destroys organic compounds by thermal oxidation to carbon dioxide, water, oxides of sulphur and nitrogen, and other combustion products. The main requirements for effective combustion are:

- Residence time in the combustion chamber must be sufficiently long to ensure complete combustion. Destruction efficiency of 99 % will usually require a residence time of 1 to 4 seconds at the relevant temperature.
- The operating temperature should be 200 - 400°C above the auto-ignition temperature of the most stable substance, typical operating temperatures are around 800°C . Where the gas stream contains chlorinated and aromatic substances, temperatures must be increased to 1100 – 1200°C , and rapid flue gas cooling is required to prevent the formation of dioxins.
- Turbulence is necessary to provide efficient heat and mass transfer in the combustion zone, and to prevent "cool spots". This is usually achieved by using burners that generate a swirling combustion flame, and by incorporating baffles in the combustion chamber.

Catalytic incineration is unlikely to be a practicable option in this sector, because the high particulate loading and the presence of resinous materials would lead to catalyst poisoning.

Environmental performance

Incineration is an extremely effective technique for removing organic substances from waste gas streams, but does not reduce inorganic particulate matter. Oxidation of organic material gives

rise to emissions of CO₂ and NO_x, which in the quantities emitted are considered to be preferable to the substances destroyed. The waste gas from curing ovens also contains ammonia and other nitrogen containing substances, which are partially or totally oxidised to produce NO_x. A well designed incinerator will reduce total organic compounds to below 10 mg/m³. The emission figures that can be achieved using this technique are given in Table 4.29.

Financial considerations

Costs for this technique are given in Table 4.30 and depend largely on air flow and plant size. The economics of incineration depend greatly on the opportunities for heat recovery. The costs depend on a number of factors, but particularly:

- volume of waste gas to be treated, which determines the dimensions of the combustion chamber;
- temperature of the waste gas, which affects the design of the combustion equipment and auxiliary fuel requirements;
- the calorific value of the gas, which affects the auxiliary fuel requirements;
- combustion temperature, which determines materials of construction;
- instrumentation;
- heat recovery options; and
- the installation requirements; indoor, outdoor, ground level, rooftop, etc.

Applicability

At the time of writing, the technique is only used to treat emissions from stone wool curing ovens, 60 - 70 % of installations use this technique. Due to the high volume, low concentration, low temperature, and sometimes high moisture content the technique is considered to be prohibitively expensive for the forming area waste gas. In principle the technique is equally applicable to new and existing processes.

Stone wool curing ovens are designed to operate with relatively high differential pressures due to the lower air permeability of the product. This leads to relatively sophisticated pressure control and results in a high temperature, low flow exhaust that is variable according to the product being manufactured, and makes incineration attractive.

Glass wool curing ovens require a lower differential pressure and do not require as great a range of control, and the waste gas generally has a higher volume and lower temperature. This make incineration a less attractive option, and combined with the availability of process water has led the industry to favour wet scrubbing instead of incineration. In glass wool processes there is usually the option to combine curing oven emissions with forming area emissions for treatment by a single technique, which is often much more economical. In principle there is no technical reason why glass wool curing oven emissions cannot be abated by incineration. However, it will generally be more expensive than in stone wool processes and may not represent the most cost-effective solution.

Associated considerations

<p><u>Advantages:</u></p> <ul style="list-style-type: none">• High efficiency for destruction of organic pollutants and odours.• No aqueous or solid waste is generated.• Relatively low costs in appropriate applications. <p><u>Disadvantages:</u></p> <ul style="list-style-type: none">• Energy is consumed because the calorific value of the gas is not sufficient to support combustion.• Carbon dioxide and oxides of nitrogen are emitted.• Poor removal efficiency for inorganic particulate matter.• Significantly higher costs for glass wool processes.

Table 4.28: Main advantages and disadvantages of incineration

Example installations

Rockwool Lapinus, Roermond, Netherlands.
Partek Rockwool, Hallekis, Sweden
Owens Corning, Queensferry, UK

4.5.6.3 Product Cooling.

A large quantity of air (typically 10000 to 40000 m³/hr) must be passed through the product to cool it to an acceptable temperature after leaving the oven. This gas is likely to contain fibre, particles of cured binder, and low levels of organic fume that may be odorous. This gas stream is not a major issue within the sector but it can cause local problems. There are three main methods for treating the gas, examples of all are found in the sector, and all are accepted as available and affordable. All three can achieve relatively low emission levels and the preferred option will depend on local circumstances. In some cases if emissions are very low secondary abatement may not be necessary.

- A filter system to remove dust combined with a sufficient discharge velocity and height to avoid ground level odours.
- A wet scrubbing system combined with adequate dispersion. A venturi type system would give the lowest particulate and fume emissions.
- Combination of the cooling air with the forming area or the curing oven waste gas treatment system.

The combination option is probably the most environmentally and economically efficient method.

4.5.6.4 Product Machining and Packaging

Mineral wool processes involve a number of product trimming, cutting and slitting operations, which generate dust emissions. The accepted way of treating these emissions is by efficient collection and extraction, and then the extracted air is passed through an efficient dust removal system, usually a bag filter. Packaging operations are also potential sources of dust releases and should be treated in the same way.

Gas volumes from these operations can vary widely (5000 to 70000 m³/hr). In order to minimise capital and operating costs of abatement equipment, the extracted air volumes should be reduced to the minimum commensurate with good dust collection.

4.5.6.5 Odours Arising from Mineral Wool Production

Technical odour assessment is difficult, expensive and potentially subjective, and there is little information available. However, mineral wool installations can be the source of odour complaints from local residents. This problem has declined in recent years due to improved operation and control, but is still an issue for many installations. This section discusses odours from all parts of the process including melting.

Conventional air-gas fired, and oxy-gas fired furnaces do not usually give rise to odour problems, even when recycled material is melted, due to the high temperatures. Cold top electric melters rarely cause odour problems, but can if mineral wool waste is being recycled. Binder materials can undergo partial thermal breakdown during the melting process, and some odorous substances may be emitted. This problem can be minimised by the addition of oxidising agents or pre-treatment of the fibre.

Cupola melting gives rise to significant emissions of odorous hydrogen sulphide. The accepted solution to this is combustion in an after burner system, which also deals with any other odorous emissions from recycled material or raw materials.

The main sources of odour are from the downstream operations, particularly forming and curing. Odours can also arise from the product cooling, particularly from dense or high binder products, or if a degree of over-curing has taken place. Odour from the individual chemicals used in the process is not considered to be very significant. Odour results predominantly from the chemical and thermal reactions of the organic binder used in the process. The characteristic smell is of 'burned Bakelite'. Complaints of formaldehyde or ammonia odours are very rare outside of the plant.

Most odours are thought to arise from the curing oven, where the main chemical reactions and thermal processes take place. The drying process will also give rise to a certain amount of steam distillation of binder compounds and intermediates. The inside of most curing ovens shows a build up of fibrous and resinous material which may also give rise to odorous compounds under the influence of the oven temperature. Small fires and localised instances of smouldering are also not uncommon in curing ovens and the smoke and fume emitted can be very odorous.

Instances of odour can be greatly reduced by good oven maintenance and cleaning, wet scrubbing systems, adequate dispersion and provision for the rapid extinguishing of any fires. Incineration of curing oven waste gases is a very effective solution to the problem.

The forming area activities can also result in the formation of odorous compounds particularly when the binder is sprayed onto the hot fibres. However, the atmosphere is cooler and therefore more moist than the curing oven, and the gas volumes are very much higher and concentrations of any odorous compounds are diluted. Although, a significant mass of odorous compounds can be emitted from the forming area an odour only "exists" if the compound is in a concentration above the odour threshold, and so forming area emissions are generally less odorous than curing oven emissions. If forming area emissions do give rise to odours they can be minimised by wet scrubbing and adequate dispersion. Problematic odours can be addressed by wet scrubbing using an oxidising agent, but this would have to be separate from the process water system. The issues of chemical wet scrubbing are discussed in Section 4.5.6.1.2.

Substance mg/Nm ³ (kg/tonne product)	Particulate	Phenol ⁽¹⁾	Formaldehyde ⁽¹⁾	Ammonia ⁽¹⁾	NO _x	CO ₂	VOC's ⁽¹⁾⁽²⁾	Amines ⁽¹⁾⁽⁴⁾
Fiberising and forming								
Primary measures	100 (3.6)	20 (0.8)	15 (0.5)	125 (4.0)			50 (2.2)	20 (0.7)
Stone wool filter	20 (0.7)	15 (0.5)	10 (0.4)	75 (2.5)			25 (1.0)	10 (0.4)
Impact scrubber + cyclone	50 (1.8)	15 (0.6)	8 (0.3)	65 (3.0)			30 (1.8)	15
Impact scrubber + cyclone + WEP	20 (1.2)	15 (0.6)	8 (0.3)	65 (3.0)			30 (1.8)	15
Impact scrubber + cyclone + PBS	50 (1.8)	12 (0.5)	5 (0.25)	50 (2.5)			25 (1.6)	10
Combined curing and forming								
Primary measures	100 (4.0)	20 (0.9)	15 (0.6)	125 (8.0)			50 (2.5)	20 (0.8)
Impact scrubber + cyclone	50 (2.0)	15 (0.7)	8 (0.4)	65 (5.0)			30 (2.0)	15 (0.6)
Impact scrubber + cyclone + WEP	20 (1.3)	15 (0.7)	8 (0.4)	65 (5.0)			30 (2.0)	15 (0.6)
Impact scrubber + cyclone + PBS	50 (2.0)	12 (0.6)	5 (0.3)	50 (4.0)			25 (1.7)	10 (0.4)
Curing alone								
Primary measures	30 (0.4)	25 (0.1)	25 (0.1)	400 (4.0)	150 (0.5)	60000 (200)	50 (0.3)	10 (0.03)
Incineration	20 (0.1)	5 (0.02)	5 (0.02)	100 (0.4)	200 ⁽³⁾ (0.6)	80000 ⁽³⁾ (230)	10 (0.04)	5 (0.02)
Impact scrubber + cyclone	30 (0.2)	10 (0.1)	8 (0.1)	65 (2.0)	150		20 (0.2)	5 (0.02)
Impact scrubber + cyclone + WEP	20 (0.1)	10 (0.1)	8 (0.1)	65 (2.0)	150	60000 (200)	20 (0.2)	5 (0.02)
Impact scrubber + cyclone + PBS	30 (0.2)	8 (0.1)	5 (0.1)	50 (1.5)	150		15 (0.1)	4

Table 4.29: General achievable values for line emissions to air (mg/Nm³)

Notes: WEP = Wet Electrostatic Precipitator; PBS = Packed Bed Scrubber; VOC = Volatile Organic Compound

- (1) The emission of binder related compounds is dependent upon binder formulation, process technology, running conditions, production rates, specific product demands, etc. These figures represent the emission levels that can be achieved on the vast majority of plants using these techniques. Primary measures consist mainly of modifications to the resin or the binder formulations, and these modifications cannot be applied to all products and all running conditions. Under unfavourable conditions the emissions may be significantly higher than these figures, particularly if only primary measures are used. However under favourable circumstances using secondary techniques emissions significantly below these figures have been achieved.
- (2) The number of measurements of VOCs is limited.
- (3) The upper value is higher than for Primary Measures due to the incineration.
- (4) **These figures show the effect of various techniques on an amine inlet concentration of around 20 mg/Nm³, but as discussed in Section 4.5.6.1 amine emissions of <5 mg/Nm³ can be achieved by resin/binder reformulation.**

Abatement Technique	Typical flow (Nm ³ /h)	Investment Cost for a new process (Meuros)	Investment Cost for an existing factory (Meuros)	Operating Cost (Meuros per year)
Forming and curing				
Primary measures	-	-	-	-
Impact scrubber + cyclone	200000 (-50000, +100000)	1.3 ± 30 %	1.6 ± 40 %	0.1 ± 0.02
Impact scrubber + cyclone + WEP	200000 (-50000, +100000)	3.8 ± 30 %	4.6 ± 40 %	0.12 ± 0.02
Impact scrubber + cyclone + PBS	200000 (-50000, +100000)	3.5 ± 30 %	4.2 ± 40 %	0.21 ± 0.02
Forming only				
stone wool slab filter	200000 (± 50000)	1.3 ± 30 %	1.5 ± 30 %	0.2 ± 0.1
Curing only				
Incinerator	20000 (-5000, +10000)	1.3 ± 40 %	1.6 ± 30 %	0.2 ± 0.1
Stack				
	250000 (-50000 +100000)	0.7 ± 40 %	0.8 ± 40 %	

Table 4.30: Investment and operating costs of abatement techniques

4.5.7 Ceramic Fibre

The principal environmental concern with ceramic fibre processes is the release to atmosphere of particulate matter, which may include ceramic fibres. In addition some secondary processing operations may give rise to VOC emissions, especially during drying and curing operations.

Particulate and fibre emissions can be generated from a number of areas within the process, these include: fiberisation and collection, needling, lubricant burn off, slitting, trimming, cutting, packaging, and areas of secondary processing. All areas where particulate or fibre releases may be generated can be served by an efficient extraction system that vents to a fabric filter system.

There are two approaches to the extraction and filtration of particulate laden air, namely:

- the provision of dedicated filter plants close to the source of the releases; and
- the extraction of air from a large number of sources to a common filter plant via a manifold system.

The most effective filtration system would consist of a primary filter followed by a high efficiency secondary filter, fitted with a pressure drop monitor and continuous monitoring of the emissions to air. High efficiency secondary filters result in lower releases and provide a safeguard in the event of the failure of the primary filter. Where a number of sources are extracted to a common system, the installation of a secondary filter is likely to be disproportionately expensive. The resultant high airflows and the high resistance of the secondary filter would necessitate a large powerful fan with high-energy requirements. A well designed and efficiently operated primary filtration system is capable of achieving emission levels in the range 1 - 5 mg/Nm³ (<1 mg/Nm³ for fibres).

Where a process relies on primary filters some form of bag failure device will provide a safeguard. Many plants are fitted with alarmed pressure drop monitors, but these cannot be relied on exclusively.

Filter systems with the extraction fan installed on the clean side of the fabric filter (negative pressure systems) are usually the preferred option. Positive pressure systems, with the fan on the dirty side, are potentially hazardous because any leaks in the system downstream of the fan will result in the release of material.

Cleaning cycles for fabric filters can be optimised to ensure maximum filtration efficiency. In some applications, particularly those involving fibrous releases, shaker mechanisms can be more effective than reverse jet systems. Due to the nature of the collected material it is important to ensure that it is handled and disposed of in a manner which prevents any release to atmosphere or to water. In some cases it may be possible to recycle the collected material to the furnace.

Organic releases can be generated during lubricant burn-off, or from curing or drying operations during secondary processing. Operational experience has shown that these releases tend to be very low. However, if emissions are significant (e.g. >100 g/hour) they can be controlled either by primary formulation measures or by standard abatement techniques, e.g. incineration or absorption.

4.5.8 Frits

Frits production does not present any significant specific emissions to air from downstream activities. Product grinding and milling is usually carried out wet, but dust control measures may be necessary if dry milling is carried out and potentially in dry product packaging areas. The most effective technique is likely to be extraction followed by a bag filter system.

4.6 Techniques for Controlling Emissions to Water

In general, emissions to the water environment are relatively low and there are few major issues that are specific to the Glass Industry. This document does not cover those general water pollution issues that are common to many industrial processes and which are discussed in great detail in the technical literature. This section briefly summarises these general issues and where appropriate provides further information on those issues that are specific to the Glass Industry. In general, water is used mainly for cleaning and cooling and can be readily recycled or treated using standard techniques. The main potential sources of water pollution are identified below.

- Surface water drainage.
- Spillages or leaks from raw material storage.
- Drainage water from areas contaminated with liquid or solid materials.
- Water used for product cleaning.
- Cooling water and cooling water blow down from closed circuit systems.
- Wet scrubber effluents.

Excluding domestic wastewater, discharges generally contain only glass solids, some oil contamination, some soluble glass making materials (e.g. sodium sulphate) and cooling water system treatment chemicals. Where any potentially harmful materials are used measures can be taken to prevent them entering the water circuit. Wherever practicable closed cooling systems can be used and blow down minimised. Standard pollution control techniques can be used to reduce emissions further if necessary. For example: settlement, screening, oil separators, neutralisation, and discharge to municipal wastewater schemes.

Standard good practice can be used to control emissions from storage of liquid raw materials and intermediates.

- Provision of adequately sized containment (bunding).
- Inspection/testing of tanks and bunding to ensure integrity.
- Overfill protection (cut off valves, alarms etc)
- Positioning of vents and filling points within the bund or other containment.

The issues considered specific to the Glass Industry are:

- Mineral wool process water systems.
- Continuous filament glass fibre effluent.
- Special glass (TV glass).
- Domestic glass (lead crystal, crystal glass).

Mineral Wool

Mineral wool processes are, under normal circumstances, net consumers of water, with substantial amounts of water vapour emitted to air from the forming and to a lesser extent the curing operations. There are no inherent wastewater discharges except the general issues mentioned above. Most processes operate a closed loop process water system (see Figure 2.11), and where practicable cooling water blow down and cleaning waters are fed into that system. Process cleaning waters and binder spillages are usually recycled to the process water circuit.

The process water system has a limited volume but can be designed to include a holding tank to accommodate volume overloads, which can then be bled back into the system. Most of the materials used in the process are compatible with the process water chemistry. Small amounts of contaminated wastewater may arise from chemical bunds, spillages and oil interceptors. Where such materials are not compatible with the process water system they can be routed to a holding tank. Due to the very low volumes of these materials they are usually disposed of to municipal wastewater sewer or sent for off-site disposal. The techniques listed in Table 4.31 could be used but are unlikely to be economical for these very small volumes.

The large volume of the process water system represents a potential for contamination of clean water circuits such as surface water and cullet quench water. Systems can be designed and operated to minimise this risk. For example, clean water systems should be sealed where they pass through areas where contamination may occur.

Continuous Filament Glass Fibre

Emissions arise from the forming area, binder preparation, cleaning, cooling, tissue/mat binder application, and from water based scrubbing systems. The main source of emission is the forming area. Due to the high speed of the winders and movement of the filaments during the forming process, a proportion of the applied binder is thrown off and squeezed out. The main pollutants in the untreated wastewater are the binder materials themselves. Careful handling procedures, particularly in the binder preparation area, can significantly reduce emission levels from other areas.

The pollutant species and concentrations will vary quite widely due to the variations in binder systems and operating practices. The wastewater pollutant concentrations are sometimes quite low due to the dilution by wash down water, but they usually contain high levels of organic pollutants arising from binder materials. The effluent will usually require treatment either by discharge to municipal sewers or by treatment on-site using an appropriate combination of the techniques listed in Table 4.31. If the effluent is to be disposed of directly to a watercourse the most effective on-site treatment is likely to be biological treatment. However, careful design and

operation of the treatment system is required, because the effectiveness of biological treatment is sometimes compromised due to low concentrations and the high proportion of polymeric species.

Special Glass

The Special Glass Sector is very diverse and it is not possible to identify all potential emissions to water and the abatement techniques that are appropriate. Most of the activities in this sector only involve the general wastewater issues described above. However, the manufacture of certain products, particularly TV glass, involves wet grinding or polishing operations. This gives rise to an aqueous stream containing the grinding and polishing aids, and fine glass that may contain lead. This waste stream can be treated by a combination of the standard solids removal techniques listed in Table 4.31 below. The lead in the glass is essentially insoluble and the total lead content will depend on the solids content.

Domestic Glass

In general, the Domestic Glass Sector has very low emissions to water. In common with other sectors of the industry, the major water uses include cooling and cleaning, and aqueous emissions will contain the cooling water system purges, cleaning waters and surface water run off. However, certain activities in particular the production of lead crystal and crystal glass have more specific associated emissions, namely:

- Water used in cutting operations contains any cutting aids and quantities of fine glass particles. This effluent can be treated using standard solids separation techniques. The water can be reused for cutting to minimise emissions levels, although a small volume would have to be bled off from the circuit. The lead contained in the glass is essentially insoluble.
- After dipping in acid the glass has a layer of lead sulphate on the surface. This is washed off with hot water which will become acidic and will contain soluble lead sulphate. This effluent can be treated by a combination of chemical and physical techniques. The lead sulphate can be reacted to precipitate out the lead (e.g. with calcium carbonate to give lead carbonate) which can then be removed, usually by coagulation and flocculation followed by a physical separation. Using these techniques it should be possible to reduce lead levels to <0.5 mg/l.
- The acidic waste from the wet scrubbers will require neutralisation before discharge. Alternatively hexafluorosilicic acid can be recovered and sold as a chemical feedstock.

<u>Physical/Chemical Treatment</u>	
<ul style="list-style-type: none">• Screening• Skimming• Settlement• Centrifuge• Filtration	<ul style="list-style-type: none">• Neutralisation• Aeration• Precipitation• Coagulation and Flocculation
<u>Biological Treatment</u>	
<ul style="list-style-type: none">• Activated sludge• Biofiltration	

Table 4.31: List of potential wastewater treatment techniques for use in the Glass Industry

4.7 Techniques for Minimising Other Wastes

A characteristic of the Glass Industry is that most of the activities produce relatively low levels of solid waste. Most of the processes do not have significant inherent by-product streams. The process residues consist of unused raw materials and waste glass that has not been converted into the product. The main process residues encountered in the glass industry and the techniques used to control them are discussed below.

Waste batch materials

These arise from material handling and storage and where quality requirements permit can be readily recycled to the process. In cases where material has built up it may not be of sufficient purity to recycle, but the amount of this type of material can be minimised by the techniques described in Section 4.3.

Dust collected from waste gas streams

In most cases this material can be recycled to the process. Where acid gas absorbents are used they can usually be chosen to be compatible with raw materials to enable recycling, although the batch composition may have to be adjusted. This issue is discussed further in Section 4.4.1.

In regenerative furnaces a substantial amount of dust is deposited in the regenerators during the furnace campaign. During the rebuild/repair this material is dug out and disposed of to an appropriately licensed site. It is not generally practicable to recycle this material.

Melt not converted into product

This waste stream arises mainly from interruptions to the forming processes, either malfunctions or product changes. The most commonly used and effective technique is to cool and shatter the melt in water and then to use the cullet formed in this way directly as a raw material. There are a number of examples where this is not practicable or is not practised.

In the float glass process the interruptions to production usually occur after the float bath and so the waste is usually a solid glass, which can also be broken and recycled as cullet. Similarly in continuous filament glass fibre production interruptions generally occur after fibre formation and the waste material is fibre. A further source of this type of waste is drain glass, which involves withdrawing a flow of molten glass is taken from the bottom of the channel to remove denser unmelted particles. If not removed these particles can cause fiberising problems, which could result in expensive damage and increased waste. The internal recycling of this material is not usually desirable, because it involves returning to the furnace the separated impurities that will flow back to the bushings. This could lead to a gradual build up of unmeltable material and potentially a higher level of waste due to fiberisation problems. In some cases it is possible to recycle this material in other parts of the Glass Industry.

In ceramic fibre there has been little financial incentive to recycle the waste melt but the practice is increasing as disposal costs rise.

In stone wool production fine materials cannot be recycled to the cupola, because they would disrupt the airflow within the material bed. This problem can be overcome by briquetting the waste material to form pieces of comparable size to the standard raw materials. This technique is now widely used and can be considered as proven both economically and technically, although the economics will vary with scale. Stone wool shot (see Section 3.8.4) can also be recycled in this way.

Waste product

This category includes out of specification material, edge trims, waste product from changeovers, breakages, and quality samples. Wherever possible measures to minimise this type of waste are preferable to recycling, for example edge trims can be reduced to the minimum width. These measures usually also result in economic benefits.

“Hard” waste for example flat glass edge trims and container glass rejects are readily recycled as cullet following crushing. In some installations this may not occur either because of variations in product formulation or simply because it is not considered as economically attractive. In theory all “hard” glass waste can be recycled in this way.

In the Mineral Wool Sector such product wastes are fibrous and so cannot be recycled directly to the furnace. The solution to this is to mill or grind the material and then recycle it as a powder to tank furnaces or via the briquetting process for stone wool cupolas. Although apparently simple in principle this technique is quite expensive and is only recently becoming economically viable due to increasing disposal costs. At the time of writing this technique is not commonly practised. A further problem in glass wool production is the organic content of the material, which must be oxidised in the furnace. This generally requires the increased use of nitrates that decompose to release NO_x. Wherever possible fibrous waste is processed and sold as blowing wool. Edge trim waste is usually shredded and recycled directly back to the fibre veil. There is a limit to the amount of waste that can be recycled in this way (edge trim only) and it can not usually be done for products with high strength requirements.

Fibrous waste from the Ceramic Fibre Sector involves the same issues as for Mineral Wool. At the time of writing no examples of the recycling of fibrous waste are known, although in principle it would be possible. The waste could be milled to produce a powder and then if necessary heated to burn off any organic material. The environmental and economic consequences of this approach do not make it an attractive option. Work in this area is continuing.

The production of continuous filament glass fibre involves very high quality requirements and at the time of writing there are no known full-scale examples of waste fibre being recycled to the furnace. The problem is apparently the organic component of the fibre.

Solid waste from wastewater systems

In general, waste separated from the process water systems is not recycled and is disposed of to landfill. In some sectors particularly domestic glass (lead crystal cutting sludge) initiatives are ongoing to recover and valorise these waste streams. In most sectors it is not financially viable to recover this waste either because of the low volumes or unpredictable/contaminated composition.

The recycling of post consumer waste (e.g. from bottle banks) is not discussed in this section, because it is not a process waste stream and so is outside of the scope of IPPC in this respect. However, its use does have important effects on the process and is considered in Sections 4.4 and 4.8. Furthermore, the practice reduces the consumption of virgin raw materials, which is a positive consideration under IPPC.

4.8 Energy

Glass making is a very energy intensive process and the choices of energy source, heating technique and heat recovery method are central to the design of the furnace and to the economic performance of the process. The same choices are also some of the most important factors affecting the environmental performance and energy efficiency of the melting operation. In general, the energy necessary for melting glass accounts for over 75 % of the total energy

requirements of glass manufacture. This section concentrates on techniques to reduce the energy requirements for melting activities.

The cost of energy for melting is one of the largest factors in operational costs for glass installations and there is a significant incentive for operators to reduce energy use. Economic savings have traditionally been the motivation for implementing energy saving techniques, but recently the environmental aspects of energy use have increased in importance. In fossil fuel fired furnaces the energy use also affects the emissions per tonne of glass of those substances which relate directly to the amount of fossil fuel burned, particularly CO₂, SO₂ and NO_x, but also particulate matter. These issues are discussed in the substance specific sections of this chapter.

Energy use and the main factors affecting the energy efficiency are discussed in Chapter 3. This chapter discusses techniques for improving furnace efficiency.

4.8.1 Melting Technique and Furnace Design

[tm18 CPIV, tm5 EEO, tm14 ETSU]

The choice of melting technique can have a great effect on the energy efficiency. The choice is largely determined by a range of economic considerations. The main factor is the desired production rate and the associated capital and operating costs over the life of the furnace. An important aspect of the operating costs is the energy usage, and in general the operator will choose the most energy efficient design possible.

In conventional fossil fuel fired furnaces the main difference in furnace design is whether the heat recovery system is based on regenerators or a recuperator. The differences in the design and operation are discussed in Chapter 2. One of the main factors in the choice is the furnace size, which is discussed further in Section 4.2.

Regenerative furnaces achieve a higher preheat temperature for the combustion gases, up to 1400°C compared with 800°C for recuperative furnaces, resulting in better melting efficiencies. The generally larger size of the regenerative furnaces also makes them more energy efficient than the smaller recuperative furnaces. This is because structural losses are inversely proportional to the furnace size, the main reason being the change in surface area to volume ratio. A modern regenerative container furnace will have an overall thermal efficiency of around 50 %, with waste gas losses around 20 %, and structural losses making up the vast majority of the remainder. The thermal efficiency of a recuperative furnace without heat recovery will be closer to 20 %.

Regenerative furnaces can be end-fired or cross-fired. The end-fired furnaces are more thermally efficient (up to 10 % higher), but combustion control is more limited and there is an upper limit to the furnace size (currently around 150m² for container glass). Float glass furnaces are less efficient than container glass furnaces, because the specific pull of a float furnace is much lower due to quality requirements.

The energy recovered by regenerators may be maximised by increasing the quantity of refractory bricks employed. In practice, these may be organised in enlarged regenerator chambers or in separate but connected structures, giving the term multi-pass regenerators. The law of diminishing returns applies, as the regenerator efficiency is approaching asymptotically its maximum limit. The principle limitations are the cost of the extra refractory bricks, and in the case of existing furnaces the limitation of available space and the additional cost of modification of furnace infrastructures. This principle is more commonly applied to end-fired furnaces due to their simple regenerator geometry, although some applications on cross-fired furnaces have been made. Modification of regenerator structures on existing furnaces (if this is technically and economically feasible given the plant layout) can only be made during furnace

reconstruction. Energy consumption may be reduced by up to 15 % with respect to the equivalent furnace with typical single pass regenerators.

The only negative impact is the increased volume of refractory materials to be handled at end of the furnace life. This negative impact is limited, as a significant proportion of the extra refractory bricks withstand two or more furnace campaigns, and solutions exist, and will continue to be developed, for recycling these materials. Although the increased air preheat temperatures of furnaces equipped with multiple pass regenerators is potentially a factor to increase flame temperature and hence NO_x formation, these furnaces do not, in practice, demonstrate high NO_x levels when appropriate measures of reduction at source are taken.

There are a variety of materials available for use as heat storage media and packing in regenerators. The simplest solution is to use refractory bricks stacked in an open or "basketweave" pattern and this will generally give a regenerator efficiency of around 50 % (heat recovered by air compared to heat contained in waste gas). However, heat transfer can be improved by using specially shaped packing and fusion cast materials. For example, fusion cast corrugated cruciforms will enhance the heat exchange efficiency compared to standard brick packing and typical fuel savings of 7 % are quoted. In addition, these materials are very resistant to chemical attack from volatiles in the waste gas stream and show very much reduced deterioration in performance (compared to bricks) throughout the campaign. So far, around 320 installations of corrugated cruciforms have been reported world-wide, of which 120 are within the EU.

The maximum theoretical efficiency of a regenerator is 80 % because the mass of waste gases from a furnace exceeds that of the incoming combustion air and the heat capacity of exhaust gases exceeds that of the combustion air. In practical terms the efficiency will be limited by cost, and structural losses become more significant as the size of the regenerators increases. It is difficult to conceive a cost effective regenerator design with an efficiency greater than 70 - 75 %.

Furnace geometry is constantly undergoing refinements to optimise thermal currents and heat transfer, both to improve glass quality and to save energy. The developments are often combined with developments in combustion systems to reduce emissions and save energy. Furnace geometry changes are only possible for new furnaces or rebuilds.

Electrical melting, either partial or 100 %, improves energy efficiency when considered at the site level, but when power generation efficiency and distribution losses are taken into consideration the situation is less clear. These techniques are described in more detail in Section 4.2. Oxy-fuel melting can also result in lower energy consumption, but this is a complex subject that is discussed in more detail in Section 4.4.2.5.

The advances in refractory materials over the past decades have allowed furnaces to operate with longer campaigns and with higher levels of insulation. The limitation of temperature to which the furnace superstructure could be subjected, was in the past a limiting factor for high insulation. Today, the insulation must be carefully designed according to the part of the furnace and the operating conditions (Temperature, type of glass, etc). Not all parts of the furnace can be insulated. The flux line and the throat must be left uninsulated and they will have to be cooled to extend furnace life. Most glass contact and superstructure refractories are fusion cast materials that are very dense with low porosity and can resist liquid glass and volatile compounds in the superstructure. They have high thermal conductivity and need in general, a good insulation level leading to substantial energy saving. In soda-lime glass the crown is in silica and heavily insulated. This material limits the temperature of the furnace to 1600 - 1620°C. Any increase in furnace temperature may also adversely affect emissions of NO_x and any emissions derived from volatile components of the batch.

Additional insulation can be applied to certain areas of the furnace with little risk of structural damage. Sprayed fibre insulation can significantly reduce heat losses when applied to the

regenerator structure. This simple cost-effective technique can reduce regenerator structural heat losses by up to 50 % and give energy savings in the region of 5 %. There is also the additional benefit that the material will effectively seal any cracks in the regenerator structure, thus reducing ingress of cold air and escape of hot air.

4.8.2 Combustion Control and Fuel Choice

[tm5 EEO, tm14 ETSU]

In recent decades the predominant fuel for glass making has been fuel oil, although the popularity of natural gas is increasing. Natural gas firing results in lower SO_x emissions but generally gives rise to higher NO_x emissions. This is because the natural gas flame is less radiant and has generally resulted in higher energy consumption, approximately 7 - 8 %. However, as experience of gas firing increases performance levels progressively approaching those associated with oil firing can be achieved. Natural gas has a higher ratio of hydrogen to carbon and its use reduces overall emissions of CO₂ by up to 25 % for a given pull rate.

The developments in low NO_x burner systems have also resulted in energy savings. By reducing the amount of combustion air to close to stoichiometric levels, less energy is lost in the waste gas. The improvements made to the combustion system, the heat transfer systems and general process control during developments intended for NO_x reduction, have in many cases also led to improvements in furnace operation and efficiency.

A technique frequently used in the past to improve energy efficiency and pull rate was oxygen enrichment of the combustion air. The reduced gas volumes and higher flame temperatures improve energy efficiency, but unless the technique forms part of a carefully controlled overall low NO_x combustion system NO_x levels can be substantially increased. The use of this technique in isolation is becoming less common due to these environmental concerns.

4.8.3 Cullet Usage

[tm29 Infomil, tm14 ETSU]

The use of cullet in a glass furnace can significantly reduce the energy consumption and its use is generally applicable to all types of furnace i.e. fossil fuel fired, oxy-fuel fired and electrically heated furnaces. Most sectors of the Glass Industry routinely recycle all internal cullet. The main exceptions are continuous filament glass fibre (where it is not considered possible due to quality constraints) and stone wool and frit production (where cullet as such is not produced). The base internal cullet level in the batch will usually be in the range of 10 to 25 %.

Cullet has a lower melting energy requirement than the constituent raw materials because endothermic chemical reactions associated with glass formation have been completed and its mass is 20 % lower than the equivalent batch materials. Therefore, increasing the cullet level in the batch has the potential to save energy, as a general rule each 10 % of extra cullet results in a 2.5 - 3.0 % reduction in furnace energy consumption. The use of cullet generally results in significant cost savings as a result of the reduction in both energy and raw material requirements.

Distinction should be made between internal cullet (recycled glass from the production line) and external cullet (recycled glass from consumer or external industrial sources). The composition of external cullet is less well defined and this limits its application. High final product quality requirements can restrict the amount of foreign cullet a manufacturer can use. However, the Container Glass Sector is uniquely placed to take advantage of using significant quantities of foreign cullet from bottle recycling schemes. At the time of writing, except where special schemes are established, the significant use of external cullet is restricted to the Container Glass Sector and some areas of the Mineral Wool Sector. Glass sectors with higher quality demands or

low availability of external cullet (e.g. flat glass) may try to contract large consumers to recycle the waste glass they generate.

Cullet use in container glass production varies from < 20 % to >90 %, with an EU average in the region of 48 %. Recycling rates vary widely between Member States depending on the material schemes for post-consumer glass collection. High quality container glass products have lower cullet levels than standard products.

In the Domestic Glass Sector, quality considerations generally prevent the use of external cullet in the process. Internal cullet usage is limited by the availability of cullet at the correct quality and composition. The average amounts of internal cullet used are 25 % for soda-lime products, and 35 % for lead crystal.

For the manufacture of flint (colourless glass) only very low levels of coloured cullet can be tolerated since coloured glass cannot be decolourised. Therefore, recycling schemes are more effective where colour separation is included. Throughout the Community there are ample supplies of green and brown cullet, however flint cullet tends to be less common and because of this situation furnaces melting coloured glass operate at higher cullet levels. The situation varies significantly between Member States due to regional differences, for example, it is a problem in the UK since the bulk of production is flint glass, yet a substantial proportion of cullet is coloured, from imported wine bottles. Consequently furnace cullet levels in the UK are on average lower.

In terms of furnace operation high cullet levels can also give other benefits such as low particulate emissions. Cullet is easier than batch to pre-heat. The output of the furnace can also be greatly increased, but there are a number of drawbacks to the manufacturer when operating at high cullet levels.

- Metallic impurities such as bottle caps or foils from wine bottles can cause serious refractory damage and shorten the furnace life. The metallics sink to the bottom where a phenomenon known as "downward drilling" takes place. Through chemical reaction the metallics effectively bore holes through the furnace bottom.
- Ceramic inclusions, such as earthenware or pottery that are insoluble in the glass melt will appear as "stones" in the final product and lead to rejects.
- At high cullet levels the control of composition and therefore the physical characteristics of the glass melt can be reduced possibly leading to final product quality problems. The variable content of organic matter (food residues, paper labels, plastics) in particular can cause problems of oxidation-reduction state leading to colour and refining difficulties.
- Aluminium caps and foils act as strong local reducing agents causing silica of the glass to reduce to silicon metal. The silicon forms into small beads, which significantly reduce the mechanical strength of the glass, due to stresses resulting from the high difference of thermal expansion coefficient between the glass and silicon.

In addition to the substantial energy savings possible with cullet usage, there are a number of other important associated environmental benefits. Emissions of CO₂, SO_x, NO_x and dust are greatly reduced due to reduced fuel usage and lower furnace temperatures. Emissions of other volatile substances may also be lower due to the reduced temperatures. However, impurities in the cullet may lead to higher emissions of HCl, HF and metals. This is particularly relevant in areas with high recycling rates where impurities can build up in the recycled material. Many raw materials in glass making are carbonates and sulphates, which release CO₂ and SO_x on melting. The increased cullet usage reduces these raw material derived emissions and reduces the consumption of virgin raw materials.

4.8.4 Waste Heat Boiler

The principle of this technique is to pass waste gases directly through an appropriate tube boiler to generate steam. The steam may be used for heating purposes (space heating and heating of fuel oil storage and piping) or, via a suitable steam motor or turbine to drive electricity generation equipment or plant items such as air compressors or IS machine ventilator fans.

Incoming gases from regenerators/recuperators are usually in the temperature range from 600°C to 300°C. The outlet temperature determines the available recoverable heat, which is limited to approximately 200°C due to the risk of condensation in the boiler and to ensure correct stack operation. Boiler tubes exposed to furnace waste gases can become coated with condensed materials (e.g. sodium sulphate, depending on the composition) and must be periodically cleaned to maintain recovery efficiency (less important for boilers operating downstream of dust removal devices). In-situ cleaning may be carried out automatically by steam, by mechanical means, or by periodic maintenance.

The applicability and economic feasibility of the technique is dictated by the overall efficiency that may be obtained (including effective use of steam generated). In practice waste heat boilers have only been considered to recover residual heat downstream from regenerator/recuperator systems and there is thought to be at least two examples with oxy-fuel fired furnaces. In many cases the quantity of energy recoverable is low for efficient power generation and is in general only a possibility for recuperative furnaces, for larger installations or where it is possible to group the waste gases from several furnaces. Waste heat boilers are in industrial use on some container glass facilities but most applications are with float glass furnaces. All float furnaces in Germany have waste heat boilers.

Investment costs can exceed 1 million euros with variable pay back periods depending on performance and prevailing energy prices. The ongoing improvements in primary energy efficiency are eroding the cost-effectiveness of waste heat boilers. In some applications there may not be an attractive pay back period, but this will vary from case to case. The 3R process can help to make existing waste heat boiler systems more effective, and would be likely to improve the economic performance of any new system proposed for installation. However, if for whatever reason the installation of a waste heat boiler is considered inappropriate or economically unattractive, the installation of the 3R process will not necessarily change this situation.

4.8.5 Batch and Cullet Preheating

[tm29 Infomil]

Description of Technique

Batch and cullet is normally introduced cold into the furnace, but by using the residual heat of the waste gases to preheat the batch and cullet, significant energy savings can be possible. This only applies to fossil fuel fired glass furnaces. In the stone wool industry, predominantly cupola furnaces are used, which have a design that preheats the raw materials intrinsically.

Batch/cullet preheaters have been developed and installed by GEA/Interprojekt (direct preheating), Zippe (indirect preheating) and Sorg (direct preheating). Recently, a combined direct cullet preheater and electrostatic precipitator was developed and installed by Edmeston. The three available systems are described below.

Direct preheating

This type of preheating involves direct contact between the flue gas and the raw material (cullet and batch) in a cross-counter flow. The waste gases are supplied to the preheater from the waste

gas duct behind the regenerator. They pass through the cavities in the preheater, thereby coming into direct contact with the raw material. The outlet temperature of the cullet is up to 400 °C. The system incorporates a bypass that allows furnace operation to continue when preheater use is either inappropriate or impossible. Direct preheaters are developed and installed by Interprojekt (formerly by GEA) and by Sorg.

Indirect preheating

The indirect preheater is in principle a cross-counter flow, plate heat exchanger, in which the material is heated indirectly. It is designed in a modular form and consists of individual heat exchanger blocks situated above each other. These blocks are again divided into horizontal waste gas and vertical material funnels. In the material funnels the material flows from the top to the bottom by gravity. Depending on the throughput, the material reaches a speed of 1 - 3 m/h and will normally be heated up from ambient temperature to approximately 300°C. The flue gases will be let in the bottom of the preheater and flow into the upper part by means of special detour funnels. The waste gases flow horizontally through the individual modules. Typically the flue gases will be cooled down by approximately 270°C – 300°C. The indirect cullet preheater is developed by Zippe.

Edmeston EGB Filter

The Edmeston electrified granulate bed (EGB) filter system is a hybrid system between an electrostatic precipitator for dust removal and a direct cullet preheater. The hot waste gas enters the top of the system and passes through an ionising stage, which imparts an electrical charge to the dust particles. The gas then passes into a bed of granular cullet, which is polarised by a high voltage electrode. The charged dust particles are attracted to the cullet where they are deposited. The cullet is in a shaft and is constantly added at the top and removed from the bottom. The preheated cullet (up to 400°C) and the attached particulates are charged into the furnace.

Environmental Performance

These techniques have a number of environmental effects, which can vary from case to case. In general, the following benefits have been experienced.

- Energy savings between 10 to 20 %.
- Reduction in NO_x emission (due to lower fuel requirements and lower furnace temperatures).
- In the case of direct preheating, reduction of acidic compounds, SO₂, HF, and HCl, of 60 %, 50 % and 90 % respectively have been found (difference before and after cullet bed).

Financial Considerations

The economics of batch/cullet preheaters are strongly dependent on the capacity of the furnace and the preheater. As an indicative example for costs, an indirect preheater for a 370 tonnes/day container furnace had a total capital cost (including EP) of 2.5 million euros. Of this 0.8 million euros was for the preheater. If significant energy savings can be achieved a pay back of 3 - 10 years may be achieved. This can be less if electric boosting can be significantly reduced. At the time of writing, the majority of container glass producers in the EU do not consider cullet preheating to be economically attractive. However, the position can vary from region to region and is constantly under review as energy prices and other factors (e.g. emissions limits) change.

Applicability

Cullet/batch preheating systems can theoretically be installed at any existing glass melting furnace with greater than 50 % cullet in the batch. Preheating of only batch has been problematic and is not considered as proven technology. The use of a direct preheater causes

increased emissions of particulate matter (up to 2000 mg/Nm³) and secondary particulate abatement is necessary. The collected dusts can normally be recycled into the furnace.

In order to keep the loss of heat of the transport system below the heat exchanger as low as possible the preheater should be located as close to the doghouse as possible. The ideal location would be directly above the batch charger. For economic reasons the temperature of the waste gas available should at least be 400 - 450°C. Furthermore, a cooling of the flue gases by at least 200 - 250°C is needed. To prevent material agglomeration the maximum entry temperature of the flue gases should not exceed 600°C.

Associated Considerations

The technique can give an increase in furnace capacity by 10 % - 15 % without compromising the furnace life. If the pull rate is not increased a small increase in furnace life may be possible. By getting more heat into the furnace the technique can also reduce the requirement for electric boosting.

In some cases, problems with odour generation from the preheater have arisen, due to organic fumes released during pre-drying of the cullet. The problems are caused by burning of food particles and other organics in the external cullet. Solutions to these problems (e.g. incineration) are being developed.

Material preheating consumes electric energy, particularly for direct heating which requires an EP. This offsets a portion of the energy saving but it is not substantial.

There is a possibility that direct preheating might lead to dioxin emissions, particularly if HCl-containing waste gases from the hot-end coating are included. However, there is currently no evidence to support this.

Example Installations

(All container Glass)

Direct preheating:

Four furnaces at Nienburger Glas, Nienburg, Germany.
Gerresheimer Glas, Dusseldorf, Germany.
Wiegand Glas, Stein am Wald, Germany.
Gerresheimer Glas, Budenheim, Germany.

Indirect preheating:

PLM Glasindustrie Dongen BV, Dongen, Netherlands.
PLM Glass Division, Bad Münden, Germany.
Vetropack, St. Prex, Switzerland – no longer operating.

Edmeston EGB Filter:

Irish Glass, Dublin, Ireland.
Leone Industries, New Jersey, USA (oxy-fuel fired furnace).

5 BAT CONCLUSIONS

5.1 Introduction

In understanding this chapter and its contents, the attention of the reader is drawn back to the preface of this document and in particular the fifth section of the preface: “How to understand and use this document”. The techniques and associated emission and/or consumption levels, or ranges of levels, presented in this chapter have been assessed through an iterative process involving the following steps:

- identification of the key environmental issues for the sector, in this case emissions to air from furnaces;
- examination of the techniques most relevant to address those key issues;
- identification of the best environmental performance levels, on the basis of the available data in the European Union and world-wide;
- examination of the conditions under which these performance levels were achieved; such as costs, cross-media effects, main driving forces involved in implementation of the techniques;
- selection of the best available techniques (BAT) and the associated emission and/or consumption levels for this sector in a general sense all according to Article 2(11) and Annex IV of the Directive.

Expert judgement by the European IPPC Bureau and the relevant Technical Working Group (TWG) has played a key role in each of these steps and in the way in which the information is presented here.

On the basis of this assessment, techniques, and as far as possible emission and consumption levels associated with the use of BAT, are presented in this chapter that are considered to be appropriate to the sector as a whole and in many cases reflect current performance of some installations within the sector. Where emission or consumption levels “associated with best available techniques” are presented, this is to be understood as meaning that those levels represent the environmental performance that could be anticipated as a result of the application, in this sector, of the techniques described, bearing in mind the balance of costs and advantages inherent within the definition of BAT. However, they are neither emission nor consumption limit values and should not be understood as such. In some cases it may be technically possible to achieve better emission or consumption levels but due to the costs involved or cross media considerations, they are not considered to be appropriate as BAT for the sector as a whole. However, such levels may be considered to be justified in more specific cases where there are special driving forces.

The emission and consumption levels associated with the use of BAT have to be seen together with any specified reference conditions (e.g. averaging periods).

The concept of “levels associated with BAT” described above is to be distinguished from the term “achievable level” used elsewhere in this document. Where a level is described as “achievable” using a particular technique or combination of techniques, this should be understood to mean that the level may be expected to be achieved over a substantial period of time in a well maintained and operated installation or process using those techniques.

Where available, data concerning costs have been given together with the description of the techniques presented in the previous chapter. These give a rough indication about the magnitude of costs involved. However, the actual cost of applying a technique will depend strongly on the specific situation regarding, for example, taxes, fees, and the technical characteristics of the installation concerned. It is not possible to evaluate such site-specific factors fully in this document. In the absence of data concerning costs, conclusions on economic viability of techniques are drawn from observations on existing installations.

It is intended that the general BAT in this chapter are a reference point against which to judge the current performance of an existing installation or to judge a proposal for a new installation. In this way they will assist in the determination of appropriate "BAT-based" conditions for the installation or in the establishment of general binding rules under Article 9(8). It is foreseen that new installations can be designed to perform at or even better than the general BAT levels presented here. It is also considered that existing installations could move towards the general BAT levels or do better, subject to the technical and economic applicability of the techniques in each case.

While the BREFs do not set legally binding standards, they are meant to give information for the guidance of industry, Member States and the public on achievable emission and consumption levels when using specified techniques. The appropriate limit values for any specific case will need to be determined taking into account the objectives of the IPPC Directive and the local considerations.

This chapter discusses BAT for the main emissions for each sector of the Glass Industry separately in Sections 5.3 to 5.10. In most of the sectors these are restricted to emissions to air, because these are seen as the priority for the Glass Industry. Within each of these sector specific sections emissions are discussed separately for each substance from melting and then more generally for downstream activities. Aqueous emissions are in most instances relatively low and not specific to the Glass Industry. General consideration for aqueous emissions and other wastes are discussed in Sections 5.11 and 5.12.

5.2 General

An important characteristic of many installations in the Glass Industry is the periodic rebuild of the furnaces. There are two major categories of rebuild, the normal rebuild and the complete rebuild, which are described in Section 4.1. For a number of the techniques discussed in Chapter 4 it may be both technically beneficial and more cost-effective to delay implementation until a rebuild. For some techniques implementation may only be possible at a rebuild (either normal or complete), but for other techniques such a delay may offer little benefit. These issues are discussed further in Section 4.1 and in the specific considerations of the techniques described in Chapter 4.

Another important factor in the decision of what is appropriate at a particular installation, is the age of the furnace. The appropriate course of action for a furnace that is expected to run for a further 8 to 12 years may be very different than for a furnace which requires rebuilding in 1 or 2 years time. This can particularly affect the balance between, for example, a technique requiring a major change of technology (e.g. oxy-fuel firing) that can only be implemented at a rebuild, and a secondary technique that can be retrofitted to an existing plant.

For certain parameters, and in particular for NO_x in some sectors, the potential for primary techniques has not been fully developed. In Directive 96/61/EC preference is given to measures which prevent pollution, and if these primary techniques are developed further they might more appropriately represent BAT than some of the secondary techniques discussed in this Chapter. In many cases in the Glass Industry the implementation of the full range of techniques discussed in this chapter represents a very substantial investment; and the associated costs could be untenable unless implemented over a reasonable time period.

Unless stated otherwise the reference conditions for the figures presented in this chapter are:

- For combustion gases: dry, temperature 0°C (273K), pressure 101.3 kPa, 8 % oxygen by volume (continuous melters), 13 % oxygen by volume (discontinuous melters). For oxy-fuel fired systems the expression of the emissions corrected to 8 % oxygen is of little value, and emissions from these systems should be discussed in terms of mass.

- For others gases (including emissions from curing and drying ovens without tail gas incineration): temperature 0 °C (273K), pressure 101.3 kPa with no correction for oxygen or water vapour concentration.

The emission level figures given in this chapter are based on average figures, not on maximum, short-term peak values, which could be expected to be higher. The emission levels given are based on a typical averaging period of not less than 30 minutes and not greater than 24 hours.

Conversion Factors

Emission levels associated with BAT are presented as ranges for both emission concentration (mg/m^3) and mass emission (kg/tonne of glass melted). This dual approach allows comparison between furnace techniques and provides an indication of the relative impact on the environment of the atmospheric emissions. For emissions from fossil fuel fired furnaces the relationship between emission concentration and the mass emitted per tonne of glass melted depends predominantly on the specific energy consumption for melting:

$$\text{Mass emission [kg/tonne of glass]} = \text{conversion factor} \times \text{emission concentration [mg/Nm}^3\text{]}$$

where: conversion factor = $(Q/P) \times 10^{-6}$

and Q= waste gas volume in Nm^3/h

P= pull rate in tonne of glass/h

The waste gas volume depends mainly on energy consumption, type of fuel, and the combustive (air or O_2). The energy consumption is a complex function of (predominantly) the type of furnace, the type of glass and the cullet percentage.

However, a range of factors can influence the relationship between concentration and specific mass flow, including:

- type of furnace (air preheating temperature, melting technique)
- type of glass produced (energy requirement for melting)
- energy mix (fossil fuel/electric boosting)
- type of fossil fuel (oil, gas)
- type of combustive (oxygen, air, oxygen enriched air)
- cullet percentage
- batch composition
- age of the furnace
- furnace size

Thus, there is no straightforward way to define overall conversion factors. Therefore, in this Chapter, emission concentrations (mg/Nm^3) are given as the prime basis of the emission levels associated with BAT. To give ranges for mass emission (kg/tonne of glass melted) which “generally equate” to these emission concentrations, a range of conversion factors have been developed corresponding to new and energy efficient air-fuel furnaces. Optimised energy consumption is thus assumed and, in this way, energy consumption is taken into account in the consideration of BAT. These conversion factors are given in the table below.

In many instances, higher energy consumption figures may be observed, but in these cases the performances should be compared with the emission levels associated with BAT expressed as concentrations.

In some cases (electric furnaces, oxy-fuel firing), it is necessary to evaluate the performances only in terms of specific mass emissions (kg/tonne of glass melted).

		Indicative factors to convert mg/Nm ³ to kg/tonne of glass melted
Flat glass		2.5 x 10 ⁻³
Container glass	General case	1.5 x 10 ⁻³
	Specific cases ⁽²⁾	3.0 x 10 ⁻³
Continuous filament glass fibre		4.5 x 10 ⁻³
Domestic glass	Soda lime	2.5 x 10 ⁻³
	Specific cases ⁽³⁾	Case by case study (often 3.0 x 10 ⁻³)
Mineral wool		2 x 10 ⁻³
Stone wool cupola		2.5 x 10 ⁻³
Special glass TV Glass-Panel		3 x 10 ⁻³
Special glass TV Glass-Funnel		2.5 x 10 ⁻³
Borosilicate (tube)		4 x 10 ⁻³
Glass ceramics		6.5 x 10 ⁻³
Water glass		1.5 x 10 ⁻³
Lighting glass (soda-lime)		2.5 x 10 ⁻³

Table 5.1: Indicative conversion factors for mg/m³ to kg/tonne of glass melted ⁽¹⁾

1. This table relates only to full air-fuel fired furnaces.
2. Specific cases correspond to less favourable cases (small special furnaces with a pull generally below 100 t/day and a cullet rate below 30 %). This category represents only 1 or 2 % of the container production.
3. Specific cases corresponding to less favourable cases and/or non-sodalime glasses: borosilicates, glass ceramic, crystal glass and infrequently lead glass.

5.2.1 Materials Storage and Handling

The techniques described in Chapter 4 for the storage and handling of materials can be used in a combination appropriate to a particular installation to ensure that any emissions from these activities are insignificant. If problems exist at a particular installation the proper application of these techniques can usually provide a solution.

5.2.2 Particulate Matter

In general, BAT for controlling dust emissions from furnaces in the Glass Industry is considered to be the use of either an electrostatic precipitator or bag filter system, operating where appropriate, in conjunction with a dry or semi-dry acid gas scrubbing system. The performance associated with these techniques is discussed in Chapter 4.

Some representatives of the Glass Industry on the Technical Working Group have stated that in their opinion the environmental benefits of secondary techniques compared with primary measures may not justify the higher costs for soda-lime glass production in all cases. This point has been made particularly strongly for small capacity soda-lime furnaces that already achieve relatively low levels of dust, and low levels of metals.

It may be that the cost-effectiveness of primary measures (costs per kg dust reduced) is better than for secondary abatement techniques. However, in general, it is considered that the balance with regard to the definition of “best” in the IPPC Directive, meaning “most effective in achieving a high general level of protection of the environment as a whole”, supports the selection of secondary techniques as BAT. Determining factors are the better environmental performance of secondary abatement techniques with regard to dust, metals, fine particulate matter and gaseous emissions, and the widespread use of these techniques under normal economic conditions in furnaces of all types and all capacities.

Furthermore, it is generally considered that economies of scale do not play the decisive role in the determination of BAT for even the smallest furnaces falling under IPPC.

The pros and cons of primary and secondary techniques are discussed in Section 4.4.1.7. However, in this chapter it is considered that on balance secondary dust abatement represents BAT for most glass furnaces, unless equivalent emissions can be achieved with primary measures.

5.2.3 Oxides of Sulphur

In most glass formulations the sulphate levels in the batch are already minimised commensurate with the glass formulation and product quality requirements. It is envisaged that in most instances BAT for dust emissions will involve the use of a dust abatement system, which will often include acid gas scrubbing. The sulphated waste produced can generally be recycled with the furnace raw materials to avoid the generation of a solid waste stream. Where appropriate this is taken into account in the proposed emission levels associated with BAT. The principle factors affecting emissions of SO_x are therefore, the choice of fuel, the glass type and the abated dust recycling considerations. The scrubbing system also can be optimised to reduce other acid gases, and the figures discussed in the following sections are generally based on the use of such a system.

Where batch sulphate levels are very low (or even zero) and natural gas is used as the fuel an acid gas scrubbing system may not be necessary. However, in these circumstances SO_x emissions will generally be lower than the figures for sulphate containing batches with acid gas scrubbing.

The choice between gas and fuel oil is very dependent on the prevailing economic conditions and it is considered outside the scope of this document to specify which of these fuels represents BAT. Where a natural gas supply is accessible and where economic conditions permit, the use of natural gas will generally result in lower SO_x emissions. Where fuel oil is used then a sulphur content of 1 % or less is considered to represent BAT. However, a higher sulphur content fuel may also be acceptable if this is combined with a scrubbing system to achieve an equivalent emission level, and if an appropriate disposal route is identified for the collected material. It is recognised that in some Member States there are economic factors that make the use of low sulphur oil more difficult.

5.2.4 Other Substances

For the purposes of this document the classifications in the table below apply to metals and metal compounds. Those metals, which fall outside of these groupings are either specified individually, due to their higher toxicity, or covered only within the category of dust, because their low toxicity, generally, does not justify specific consideration.

Where emission levels for metals are given in this document, these include metals present in gas phase and bound to dust (see 4.4.1.7).

Group 1 metals and their compounds	Group 2 metals and their compounds
Arsenic	Antimony
Cobalt	Lead
Nickel	Chromium III
Selenium	Copper
Chromium VI	Manganese
	Vanadium
	Tin

Table 5.2: Classifications of metals and their compounds

5.3 Container Glass

5.3.1 Dust

In general in this sector, BAT for dust is considered to be the use of an electrostatic precipitator or bag filter operating, where appropriate, in conjunction with a dry or semi-dry acid gas scrubbing system. The BAT emission level associated with these techniques is 5 - 30 mg/Nm³ which generally equates to less than 0.1 kg/tonne of glass melted. Values in the lower part of the range given would generally be expected for bag filter systems. In some cases, the application of BAT for metals emissions may result in lower emission levels for dust.

5.3.2 Oxides of Nitrogen

The Container Glass Sector utilises a wide range of furnace types and sizes, and there are many primary and secondary techniques available that can achieve good NO_x reduction efficiencies. There are also a number of techniques, which can achieve very low NO_x levels, but which may only be applicable in certain circumstances. These are discussed in Chapter 4, for example, the LoNO_x melter, the Flex melter, or electric melting. There are also techniques that are more widely applicable but which may not represent the most appropriate option in all circumstances, for example oxy-fuel firing and batch/cullet preheating.

The selection of techniques that represents BAT will depend very much on the site-specific issues. The main techniques (or combinations thereof) likely to represent BAT in this sector are primary measures (combustion modifications), 3R/Reburning (for regenerative furnaces), oxy-fuel firing, SNCR or SCR. It is considered that the emission level for oxides of nitrogen (expressed as NO₂) associated with the techniques that will generally constitute BAT is 500 - 700 mg/Nm³ which generally equates to 0.5 - 1.1 kg/tonne of glass melted. The lowest figures in this range generally relate to secondary abatement or oxy-fuel melting. However, where other techniques can achieve values within the range and are both technically and economically viable, they may also represent BAT.

Where the most appropriate techniques for a given situation require a delay until the next rebuild (e.g. oxy-fuel or revised furnace geometry) such levels may not be achievable until after the rebuild. With only the use of primary measures emission levels of 600 - 850 mg/Nm³ which generally equates to 0.9 - 1.3 kg/tonne of glass melted could be expected for many air-fuel fired furnaces.

For those processes that require substantial use of nitrate compounds in the batch, the emission levels identified above may be difficult to achieve without secondary abatement. If the use of nitrates is very frequent or permanent, or if very high emissions arise, then secondary techniques may be necessary. In this sector only specialist products (e.g. some perfume bottles) would fall in this category, representing less than 1% of production. Except in very exceptional circumstances the emission level associated with BAT would be expected to be less than 1000 mg/Nm³ which generally equates to less than 3.0 kg/tonne of glass melted. If the use of nitrates is infrequent then the costs of secondary measures (where they would not otherwise be required) may not be justified. Wherever practicable the first step should be to minimise the use of nitrates in the batch before considering secondary abatement.

5.3.3 Oxides of Sulphur

For the emission levels given below the use of secondary abatement for dust is assumed, with dry or semi-dry acid gas scrubbing where appropriate. Therefore in general in this sector, the

emission levels associated with BAT for oxides of sulphur (expressed as SO₂) are considered to be:

- For natural gas firing 200 - 500 mg/Nm³ which generally equates to 0.3 to 0.75 kg/tonne of glass melted.
- For oil firing 500 - 1200 mg/Nm³ which generally equates to 0.75 to 1.8 kg/tonne of glass melted.

These values correspond to situations where the priority is reducing SO_x emissions and they allow for full dust recycling in many cases. However, when from an integrated environmental approach waste minimisation by filter dust and cullet recycling are considered of high priority and from associated mass balance evaluation this does not enable these values to be obtained, the following emission levels may represent the levels associated with BAT:

- For natural gas firing up to 800 mg/Nm³ which generally equates to 1.2 kg/tonne of glass melted
- For oil firing up to 1500 mg/Nm³ which generally equates to 2.25 kg/tonne of glass melted

These aspects are discussed in sections 4.4.3.3 and 5.2.3, and in the sulphur balance annex.

5.3.4 Other Emissions from Melting

In general in this sector, BAT is considered to be raw material selection to minimise emissions, combined with acid gas scrubbing, where appropriate. Acid gas scrubbing may not always be necessary either to protect the abatement equipment or to achieve the figures given above for SO_x. Where this is the case, acid gas scrubbing is considered to constitute BAT if the levels identified below cannot be achieved by primary measures. The emission levels associated with BAT for the pollutants specified below are considered to be:

- Chlorides (expressed as HCl) <30 mg/Nm³
- Fluorides (expressed as HF) <5 mg/Nm³
- Metals (Group 1 + 2) <5 mg/Nm³
- Metals (Group 1) <1 mg/Nm³

Classifications for metals and their compounds are given in Table 5.2.

5.3.5 Downstream Processes

The main potential source of emissions from downstream processes is hot end coating treatment. A number of techniques described in Chapter 4 can be used to treat emissions and the techniques chosen will depend on installation specific issues. The emission levels associated with BAT for the pollutants specified below are considered to be:

- Chlorides (expressed as HCl) <30 mg/Nm³
- Particulates <20 mg/Nm³
- Tin <5 mg/Nm³
- Organotin <1 mg/Nm³

Hot end treatment fumes may also be treated with the furnace waste gases in a common acid gas/dust abatement system.

5.4 Flat Glass

5.4.1 Dust

In general in this sector, BAT for dust is considered to be the use of an electrostatic precipitator or bag filter operating, where appropriate, in conjunction with a dry or semi-dry acid gas scrubbing system. The BAT emission level associated with these techniques is 5 - 30 mg/Nm³ which generally equates to less than 0.1 kg/tonne of glass melted. Values in the lower part of the range given would generally be expected for bag filter systems. In some cases, the application of BAT for metals emissions may result in lower emission levels for dust.

5.4.2 Oxides of Nitrogen

In general in this sector, the emission level associated with BAT for oxides of nitrogen (expressed as NO₂) is considered to be 500 - 700 mg/Nm³ which generally equates to 1.25 - 1.75 kg/tonne of glass melted. This is based primarily on the use of primary techniques or 3R/Reburning combined with primary techniques. However, where appropriate other techniques (e.g. SCR and SNCR) can also be used to achieve these levels and may be considered as BAT. Where 3R/Reburning or SCR are used emission levels towards the lower end of the range would be expected.

Where the most appropriate techniques for a given situation require a delay until the next rebuild (e.g. oxy-fuel or revised furnace geometry) such levels may not be achievable until after the rebuild. With only the use of combustion modifications emission levels of less than 850 mg/Nm³ which generally equates to less than 2.2 kg/tonne of glass melted could be expected for many air-fuel fired furnaces. The 3R technique can usually be applied during a furnace campaign.

For those processes that require substantial use of nitrate compounds in the batch, the emission levels identified above may be difficult to achieve without secondary abatement. If the use of nitrates is very frequent, or if very high emissions arise, then secondary techniques may be necessary. In such applications the emission level associated with BAT is considered to be less than 850 mg/Nm³ which generally equates to less than 2.2 kg/tonne of glass melted. If the use of nitrates is infrequent then the costs of secondary measures (where they would not otherwise be required) may not be justified. Wherever practicable the first step should be to minimise the use of nitrates in the batch before considering secondary abatement.

5.4.3 Oxides of Sulphur

For the emission levels given below the use of secondary abatement for dust is assumed, with dry or semi-dry acid gas scrubbing where appropriate. Therefore in general in this sector, the emission levels associated with BAT for oxides of sulphur (expressed as SO₂) are considered to be:

- For natural gas firing 200 - 500 mg/Nm³ which generally equates to 0.5 to 1.25 kg/tonne of glass melted.
- For oil firing 500 - 1200 mg/Nm³ which generally equates to 1.25 to 3 kg/tonne of glass melted.

These values correspond to situations where the priority is reducing SO_x emissions and they allow for full dust recycling in many cases. However when from an integrated environmental approach waste minimisation by filter dust and cullet recycling are considered of high priority

and from associated mass balance evaluation this does not enable these values to be obtained, the following emission levels may represent the levels associated with BAT:

- For natural gas firing up to 800 mg/Nm³ which generally equates to 2 kg/tonne of glass melted
- For oil firing up to 1500 mg/Nm³ which generally equates to 3.75 kg/tonne of glass melted

These aspects are discussed in sections 4.4.3.3 and 5.2.3, and in the sulphur balance annex.

5.4.4 Other Emissions from Melting

In general in this sector, BAT is considered to be raw material selection to minimise emissions, combined with acid gas scrubbing in association with dust abatement. Therefore, the emission levels associated with BAT for the pollutants specified below are considered to be:

- Chlorides (expressed as HCl) <30 mg/Nm³
- Fluorides (expressed as HF) <5 mg/Nm³
- Metals (Group 1 + 2) <5 mg/Nm³
- Metals (Group 1) <1 mg/Nm³

Classifications for metals and their compounds are given in Table 5.2.

5.4.5 Downstream Processes

A number of techniques described in Chapter 4 can be used to treat downstream emissions and the techniques chosen will depend on installation specific issues. The emission levels associated with BAT for the pollutants specified below are considered to be:

- Chlorides (expressed as HCl) <30 mg/Nm³
- Fluorides (expressed as HF) <5 mg/Nm³
- Particulates <20 mg/Nm³
- Metals (Group 1 + 2) <5 mg/Nm³
- Metals (Group 1) <1 mg/Nm³

Classifications for metals and their compounds are given in Table 5.2.

5.5 Continuous Filament Glass Fibre

5.5.1 Dust

In general in this sector, BAT for dust is considered to be the use of an electrostatic precipitator or bag filter operating, where appropriate, in conjunction with a dry or semi-dry acid gas scrubbing system. The BAT emission level associated with these techniques is 5 - 30 mg/Nm³ which generally equates to less than 0.14 kg/tonne of glass melted. Values in the lower part of the range given would generally be expected for bag filter systems. In some cases, the application of BAT for metals emissions may result in lower emission levels for dust.

In this sector the nature of the dust means that the cooling of the waste gas and the positioning of the abatement system are very important in optimising abatement efficiency. In some cases abatement equipment may have already been installed which meets the requirements of BAT in its general design but which may have been installed to meet a less demanding target and so not positioned ideally. If existing equipment is capable of achieving an emission level of 50

mg/Nm³, rather than 30 mg/Nm³ as described above, then the costs of replacement or major modifications prior to the next rebuild could be disproportionate to the advantages gained.

Certain advanced formulations can result in emission levels approaching those given above without secondary abatement. Where this is the case a site-specific assessment must be made regarding BAT.

5.5.2 Oxides of Nitrogen

At the time of writing this sector is going through a transition period in NO_x control, which makes it difficult to form firm conclusions regarding BAT. Emissions levels are generally higher than 1000 mg/Nm³ and greater than 4.5 kg/tonne of glass melted. A certain amount of work has been carried out with combustion modifications and some good results have been achieved. However, due to certain sector specific issues, such as high energy requirements, it is not envisaged that emissions levels significantly below 800 mg/Nm³ which generally equates to 3.6 kg/tonne of glass melted could be achieved for most processes with conventional combustion modifications alone.

There are no known examples of SNCR or SCR in this sector. It is considered that SCR is unlikely to be applicable in the near future due to concerns over borate condensation in the catalyst. There do not appear to be any substantial technical obstacles to the use of SNCR in this sector, and if installed the technique could be expected to result in reductions of 40 - 70 %, depending on the precise application.

There are currently 6 oxy-fuel melters in Europe (out of 26) and several further examples elsewhere in the world. The number of oxy-fuel melters is increasing and there are no overriding technical obstacles to its implementation. However, there is still some uncertainty over the economic implications of the technique and also concerns over the effect on refractory life. The technique is used more widely in other sectors and is gradually gaining more general acceptance. When applied in this sector the technique can be expected to achieve 0.5 - 1.25 kg/tonne of glass melted.

In general in this sector, BAT for oxides of nitrogen (expressed as NO₂) is considered likely to be oxy-fuel melting; and the emission level associated with BAT is considered to be 0.5 - 1.5 kg/tonne of glass melted. This statement is not a firm conclusion, rather a balanced judgement based on the information available at the time of writing. It is acknowledged that the technique still carries an element of financial risk, but it is expected that the technique will become more widely accepted as BAT in the medium term. Many operators are scheduling the technique for rebuilds and for most applications in this sector there is currently no other technique capable of producing the same emission levels for comparable costs. Where other techniques are practicable a comparable BAT emission level is considered to be 500 - 700 mg/Nm³.

5.5.3 Oxides of Sulphur

For the emission levels given below the use of secondary abatement for dust is assumed, with dry or semi-dry acid gas scrubbing where appropriate. Therefore in general in this sector, the emission levels associated with BAT for oxides of sulphur (expressed as SO₂) are considered to be:

- For natural gas firing less than 200 mg/Nm³ which generally equates to less than 0.9 kg/tonne of glass melted. Where sulphates are used as refining agents this concentration could be up to 800 mg/Nm³ which generally equates to less than 3.6 kg/tonne of glass melted.

- For oil firing 500 - 1000 mg/Nm³ which generally equates to 2.25 to 4.5 kg/tonne of glass melted.

The figures in the upper parts of these ranges relate to where collected dust is recycled to the furnace. If dust is not recycled then the emissions would be expected to be less than the maximums indicated.

5.5.4 Other Emissions from Melting

In general in this sector, the BAT is considered to be either primary measures or acid gas scrubbing combined with dust abatement, the emission levels associated with BAT for the pollutants specified below are considered to be:

- Chlorides (expressed as HCl) <30 mg/Nm³
- Fluorides (expressed as HF) 5 - 15 mg/Nm³
- Metals (Group 1 + 2) <5 mg/Nm³
- Metals (Group 1) <1 mg/Nm³

Classifications for metals and their compounds are given in Table 5.2.

Some low fluoride and fluoride free formulations can, without secondary abatement, result in emission levels for HF approaching, but not necessarily achieving those given above. Where this is the case a site-specific assessment must be made regarding BAT.

5.5.5 Downstream Processes

The emissions associated with downstream processing can be very variable and a wide range of primary and secondary techniques can be used. The emission levels associated with BAT are considered to be 5 - 20 mg/Nm³ for particulate matter, and 5 - 50 mg/Nm³ for volatile organic compounds.

5.6 Domestic Glass

In general and where it is economically viable, predominantly electrical melting is considered BAT for lead crystal, crystal glass and opal glass production, since this technique allows efficient control of potential emissions of volatile elements. Where crystal glass is produced with a less volatile formulation, other techniques may be considered when determining BAT for a particular installation.

5.6.1 Dust

In general in this sector, BAT for dust is considered to be the use of an electrostatic precipitator or bag filter operating, where appropriate, in conjunction with a dry or semi-dry acid gas scrubbing system. The BAT emission level associated with these techniques is 5 - 30 mg/Nm³ which generally equates to less than 0.1 kg/tonne of glass melted. Values in the lower part of the range given would generally be expected for bag filter systems. In some cases, the application of BAT for metals emissions may result in lower emission levels for dust.

For soda-lime formulations reference should also be made to Section 5.2.2 above and to Section 4.4.1.7. These issues are particularly relevant for this sector because of its specific nature, which is outlined in Section 5.6.2 below.

5.6.2 Oxides of Nitrogen

At the time of writing there is relatively little information available concerning NO_x abatement in this sector, which makes it difficult to form firm conclusions regarding BAT. NO_x emissions for air-fuel fired furnaces are generally in the range 1500 - 2000 mg/Nm³ which generally equates to 3.75 - 5 kg/tonne of glass melted.

The nature of the sector gives rise to a number of issues that can affect the options for NO_x control. For example, if this sector is compared with the Container Glass Sector there are a number of significant differences based mainly on product quality requirements and lower production volumes. Furnaces are on average substantially smaller (<160 tonnes/day), only internal cullet is usually used, more oxidising conditions are required (therefore, higher levels of nitrates are used), the furnace is usually run slightly hotter and residence time is up to 50 % longer. All of these factors lead to higher specific energy consumption and increase the potential for NO_x formation.

A significant amount of work has been carried out with combustion modifications and in certain cases substantial NO_x reductions have been achieved. However, the scale of reductions seen in some sectors has not been achieved in Domestic Glass, and it is anticipated that further developments are possible. Based on experience in other sectors the rigorous application of primary combustion measures could be expected to yield reductions in NO_x emissions of 20 - 40 %, i.e. in the region of 1000 - 1500 mg/Nm³ which generally equates to 2.5 - 3.75 kg/tonne of glass melted.

A number of electrically heated furnaces are used in this sector, but there is an upper limit to economic viability. In general where electrical melting (either 100 % or predominantly electrical) is economically viable, and particularly for lead crystal, crystal glass and opal glass production the technique is considered BAT. NO_x emissions are limited to nitrate breakdown and the emission level associated with BAT would generally be 0.2 - 1.0 kg/tonne of glass melted, depending on the level of nitrates used. As discussed above, for less volatile crystal glass formulations other techniques may be considered when determining BAT for a particular installation.

There are no known examples of SCR, SNCR or 3R/Reburning in this sector. There are some examples of oxy-fuel firing on Domestic Glass furnaces, but not generally at a scale representative of typical air-fuel fired plants i.e. 50 - 160 tonnes/day. There are no overriding obstacles to the implementation of these techniques and it is likely that most of the difficulties could be overcome with time and operational experience.

As stated above it is difficult to form firm conclusions on what constitutes BAT for NO_x emissions in the Domestic Glass Sector. Where electrical melting is not economically viable a number of other techniques could be used. The sector utilises a wide range of furnace types and selection of the most appropriate technique will depend on the features of the particular installation. It is envisaged that given the necessary time for development and implementation of techniques, the emission level for oxides of nitrogen (expressed as NO₂) associated with BAT will be 500 - 700 mg/Nm³ which generally equates to 0.5 - 1.75 kg/tonne of glass melted. The main techniques (or combinations thereof) likely to represent BAT in this sector are primary measures (combustion modifications), 3R/Reburning (for regenerative furnaces), oxy-fuel firing, SNCR or SCR. It is claimed that, in a small number of cases, the use of 3R/Reburning could necessitate an upgrade of the refractory material that would add to the overall cost, and potentially affect the choice of BAT. For smaller melters consideration could also be given to innovative designs such as the Flex melter.

It is acknowledged that these performance levels represent a significant improvement over current performance for many installations, and therefore would generally represent medium

term proposals. It is strongly recommended that work is carried out to determine the potential for NO_x reduction by primary measures for air-fuel furnaces.

For those processes that require substantial use of nitrate compounds in the batch, the emission levels identified above may be difficult to achieve without secondary abatement. If the use of nitrates is very frequent or permanent, or if very high emissions arise, then secondary techniques may be necessary. If the use of nitrates is infrequent or the costs of further secondary measures are not economically viable then a higher emission level may represent BAT. Wherever practicable nitrate use should be minimised as far as possible. Except in very exceptional circumstances the emission level associated with BAT would be expected to be less than 1500 mg/Nm³ which generally equates to less than 3 kg/tonne of glass melted.

5.6.3 Oxides of Sulphur

For the emission levels given below the use of secondary abatement for dust is assumed, with dry or semi-dry acid gas scrubbing where appropriate. Therefore in general in this sector, the emission levels associated with BAT for oxides of sulphur (expressed as SO₂) are considered to be:

- For natural gas firing 200 - 500 mg/Nm³ which generally equates to 0.5 – 1.25 kg/tonne of glass melted, where low levels of sulphates are used this figure is less than 200 mg/Nm³ which generally equates to less than 0.5 kg/tonne of glass melted.
- For oil firing 500 - 1300 mg/Nm³ which generally equates to 1.25 – 3.25 kg/tonne of glass melted.

The figures in the upper parts of these ranges relate to where collected dust is recycled to the furnace. If dust is not recycled then the emissions could be expected to be less than the maximums indicated.

5.6.4 Other Emissions from Melting

In general in this sector, BAT is considered to be raw material selection to minimise emissions, combined with acid gas scrubbing. Acid gas scrubbing may not be necessary either to protect the abatement equipment or to achieve the figures given above for SO_x. Where this is the case, acid gas scrubbing is considered to constitute BAT if the levels identified below cannot be achieved by primary measures. The emission levels associated with BAT for the pollutants specified below are considered to be:

- Chlorides (expressed as HCl) <30 mg/Nm³
- Fluorides (expressed as HF) <5 mg/Nm³
- Metals (Group 1 + 2) <5 mg/Nm³
- Metals (Group 1) <1 mg/Nm³

Classifications for metals and their compounds are given in Table 5.2.

For lead crystal and crystal glass production the figures of <5 mg/Nm³ and <1 mg/Nm³ for metals generally implies the use of bag filters or a high efficiency EP.

5.6.5 Downstream Processes

Potential emissions from downstream processes consist mainly of dust and acid gas fumes from lead crystal and crystal glass production. For potentially dusty activities BAT is considered to be cutting under liquid where practicable, and if dry cutting or grinding is carried out then

extraction to a bag filter system. Where acid gases or fumes are generated BAT is considered to be wet scrubbing. The emission levels associated with BAT for the pollutants specified below are considered to be:

- Fluorides (expressed as HF) <math><5 \text{ mg/Nm}^3</math>
- Particulates <math><10 \text{ mg/Nm}^3</math>
- Metals (Group 1 + 2) <math><5 \text{ mg/Nm}^3</math>

Within this sector there are potentially important emissions to water, these are discussed in Chapters 3 and 4 and the emission levels associated with BAT for these activities are given in Section 5.11.

5.7 Special Glass

For this sector the conversion factors given in Table 5.1 range from 1.5×10^{-3} (water glass) to 6.5×10^{-3} (glass ceramics). In this section it would be confusing to give the mass emissions which generally equate to the concentration emission for each of the six separate conversion factors. Therefore, emission levels are presented only as concentrations and reference should be made to Table 5.1 to determine the corresponding mass emission for each product type.

5.7.1 Dust

In general in this sector, BAT for dust is considered to be the use of an electrostatic precipitator or bag filter operating, where appropriate, in conjunction with a dry or semi-dry acid gas scrubbing system. The BAT emission level associated with these techniques is 5 - 30 mg/Nm^3 . Values in the lower part of the range given would generally be expected for bag filter systems. In some cases, the application of BAT for metals emissions may result in lower emission levels for dust.

5.7.2 Oxides of Nitrogen

In general in this sector, the emission level associated with BAT for oxides of nitrogen (expressed as NO_2) is considered to be 500 - 700 mg/Nm^3 . This figure is based primarily on the use of oxy-fuel melting and SNCR, or SCR. The Special Glass Sector utilises a wide range of furnace types and sizes. There are other techniques for reducing NO_x emissions to comparable levels and the most appropriate technique will depend very much on site specific issues. There are also a number of techniques, which can achieve levels below those given; however, these techniques may not be applicable to all installations. Where high levels of nitrates are used consideration should also be given to minimising their use as far as practicable within the constraints of the process and product requirements.

In general for water glass production, the emission level associated with BAT for oxides of nitrogen (expressed as NO_2) is considered to be 500 - 700 mg/Nm^3 . This figure is based on the use of primary or secondary techniques. Where the most appropriate techniques for a given situation require a delay until the next rebuild (e.g. oxy-fuel or revised furnace geometry) such levels may not be achievable until after the rebuild. With only the use of primary measures emission levels of 600 - 850 mg/Nm^3 could be expected for air-fuel fired furnaces.

5.7.3 Oxides of Sulphur

For the emission levels given below the use of secondary abatement for dust is assumed, with dry or semi-dry acid gas scrubbing where appropriate. Therefore in general in this sector, the emission levels associated with BAT for oxides of sulphur (expressed as SO₂) are considered to be:

- For natural gas firing 200 - 500 mg/Nm³, where low levels of sulphates are used this figure is less than 200 mg/Nm³.
- For oil firing 500 - 1200 mg/Nm³.

The figures in the upper parts of these ranges relate to where collected dust is recycled to the furnace. If dust is not recycled then the emissions could be expected to be less than the maximums indicated.

5.7.4 Other Emissions from Melting

In general in this sector, BAT is considered to be raw material selection to minimise emissions, combined with acid gas scrubbing. Acid gas scrubbing may not always be necessary either to protect the abatement equipment or to achieve the figures given above for SO_x. Where this is the case, acid gas scrubbing is considered to constitute BAT if the levels identified below cannot be achieved by primary measures. The emission levels associated with BAT for the pollutants specified below are considered to be:

- Chlorides (expressed as HCl) <30 mg/Nm³
- Fluorides (expressed as HF) <5 mg/Nm³
- Metals (Group 1 + 2) <5 mg/Nm³
- Metals (Group 1) <1 mg/Nm³

Classifications for metals and their compounds are given in Table 5.2.

5.7.5 Downstream Processes

The emissions associated with downstream processing can be very variable and a wide range of primary and secondary techniques can be used. For potentially dusty activities BAT is considered to be dust minimisation by cutting, grinding or polishing under liquid, or where dry operations are carried out extraction to a bag filter system. Where acid gases or fumes are generated BAT is considered to be wet scrubbing. The emission levels associated with BAT for the pollutants specified below are considered to be:

- Fluorides (expressed as HF) <5 mg/Nm³
- Particulates <5 mg/Nm³
- Metals (Group 1 + 2) <5 mg/Nm³
- Metals (Group 1) <1 mg/Nm³

Classifications for metals and their compounds are given in Table 5.2.

Within this sector there are potentially important emissions to water, which are discussed in Chapters 3 and 4 and the emission levels associated with BAT for these activities are given in Section 5.11.

5.8 Mineral Wool

5.8.1 Dust

In general in this sector, BAT for dust is considered to be the use of an electrostatic precipitator or bag filter. In glass wool production the use of a dry or semi-dry acid gas scrubbing system is not generally considered necessary to protect the equipment, because almost all furnaces are gas fired or electrically heated. The BAT emission level associated with these techniques is 5 - 30 mg/Nm³ which generally equates to less than 0.1 kg/tonne of glass melted. Values in the lower part of the range given would generally be expected for bag filter systems. In some cases, the application of BAT for metals emissions may result in lower emission levels for dust. Hot blast cupolas will generally be fitted with bag filters rather than electrostatic precipitators due to the risk of explosion.

In glass wool production the nature of the dust means that the cooling of the waste gas and the positioning of the abatement system are very important in optimising abatement efficiency. In some cases abatement equipment may have already been installed which meets the requirements of BAT in its general design but which may have been installed to meet a less demanding target and so not positioned ideally. If existing equipment is capable of achieving an emission level of 50 mg/Nm³, rather than 30 mg/Nm³ as described above, then the costs of replacement or major modifications prior to the next rebuild could be disproportionate to the advantages gained.

5.8.2 Oxides of Nitrogen

In general for glass wool production, BAT for oxides of nitrogen (expressed as NO₂) is considered to be the use of oxy-fuel firing or predominantly electrical melting. The emission level associated with BAT is considered to be 500 - 700 mg/Nm³ which generally equates to 0.5 - 1.4 kg/tonne of glass melted. In most applications oxy-fuel firing or predominantly electrical melting could be expected to achieve emissions below 1kg/tonne of glass melted. However, conventional air-gas systems may be able to achieve emissions within the ranges indicated with primary or secondary measures. Where this is the case such systems may also be judged to represent BAT.

Where significant quantities of nitrates are required in the batch (e.g. for recycling material with a high organic component) the emission levels identified above may be difficult to achieve without secondary abatement or conversion to oxy-fuel or electric melting. If the use of nitrates is very frequent or permanent, or if very high emissions arise, then such techniques are likely to constitute BAT and could be expected to achieve less than 700 mg/Nm³ which generally equates to less than 1.4 kg/tonne of glass melted.

Stone wool cupolas do not generally give rise to substantial NO_x emissions and emissions less than 0.5 kg/tonne of melt can be achieved without specific controls. Where tank furnaces are used the emission level associated with BAT is considered to be equivalent to glass wool production.

5.8.3 Oxides of Sulphur

In general for glass wool production, emissions of oxides of sulphur (expressed as SO₂) tend to be very low. Almost all furnaces are gas fired or electrically heated and only very low levels of sulphate are used. In these circumstances SO_x emissions would be expected to be below 50 mg/Nm³ which generally equates to less than 0.1 kg/tonne of glass melted, without any specific abatement measures. If furnaces are oil fired then acid gas scrubbing will usually be necessary to protect the dust abatement equipment, in which case the emission level associated with BAT

is considered to be 300 - 1000 mg/Nm³ which generally equates to 0.6 - 2.0 kg/tonne of glass melted.

For stone wool production, the emission level associated with BAT for oxides of sulphur (expressed as SO₂) is considered to be less than 600 mg/Nm³ which generally equates to less than 1.5 kg/tonne of glass melted. These values correspond to situations where the priority is for the recycling of process wastes and the prevention of further solid waste streams for disposal. However, when from an integrated environmental approach the priority is for the reduction of SO_x emissions, and from associated mass balance evaluation this does not enable these values to be obtained, the use of acid gas scrubbing may represent BAT. These systems entail significant costs and in general the collected material cannot be effectively recycled giving rise to a solid waste stream for disposal. Where acid gas scrubbing is considered to represent BAT then dry scrubbing is likely to be the most cost effective technique. In such cases the emission level associated with BAT for oxides of sulphur (expressed as SO₂) is considered to be less than 200 mg/Nm³ which generally equates to less than 0.5 kg/tonne of glass melted.

The levels given above relate principally to melting with stone charges, but where the charge contains cement bound briquettes there is a contribution from the sulphur in the cement binder. The effect on the SO₂ emissions will clearly depend on the amount of material recycled as briquettes. For example, at 45 % substitution of briquettes for stone the emission level associated with BAT would be less than 1100 mg/Nm³ which generally equates to less than 2.7 kg/tonne of glass melted. Where SO₂ reduction is the priority, acid gas scrubbing is generally considered to represent BAT and the associated emission level would be less than 350 mg/Nm³ which generally equates to less than 0.8 kg/tonne of glass melted. Substitution at greater than 45 % is rare, and for each installation a sulphur balance should be produced in order to determine appropriate emission levels commensurate with the BAT.

If the briquettes also contain recycled dust collected from abatement equipment this will add a further sulphur contribution. The sulphur concentration in the collected dust will vary significantly from installation to installation, generally 0.05 - 0.28 %. The emission levels associated with BAT are given below. As discussed above for each installation a sulphur balance should be produced in order to determine appropriate emission levels commensurate with the BAT.

- Where waste minimisation is the priority, 1400 mg/Nm³ which generally equates to 3.4 kg/tonne of glass melted.
- Where SO₂ reduction is the priority, 400 mg/Nm³ which generally equates to 1.0 kg/tonne of glass melted.

The use of blast furnace slag is not generally considered to form part of BAT, and where its use is required for product or process reasons BAT is considered to include dry scrubbing.

5.8.4 Other Emissions from Melting

Emissions of halides and metals tend to be very low from these processes and the emission levels indicated below can usually be achieved by raw material selection. Stone wool cupolas can give rise to high emissions of hydrogen sulphide and carbon monoxide. BAT for hydrogen sulphide emissions is considered to be raw material selection or thermal oxidation. BAT for carbon monoxide emissions is considered to be thermal oxidation. In general in this sector, the emission levels associated with BAT for the pollutants specified below are considered to be:

- Chlorides (expressed as HCl) <math><30 \text{ mg/Nm}^3</math>
- Fluorides (expressed as HF) <math><5 \text{ mg/Nm}^3</math>
- Hydrogen sulphide (H₂S) <math><5 \text{ mg/Nm}^3</math>
- Carbon Monoxide (CO) <math><200 \text{ mg/Nm}^3</math>
- Metals (Group 1 + 2) <math><5 \text{ mg/Nm}^3</math>
- Metals (Group 1) <math><1 \text{ mg/Nm}^3</math>

Classifications for metals and their compounds are given in Table 5.2.

5.8.5 Downstream Processes.

Forming area and combined forming and curing emissions

Following optimisation of primary measures BAT is considered to be the use of either a wet electrostatic precipitator, a packed bed scrubber, or a stone wool filter (generally stone wool processes only). The performance of these different techniques varies. The wet electrostatic precipitator and the stone wool filter are more effective at removing solid particles and droplets, and the packed bed scrubber is more effective in removing gaseous substances. These issues and the relevant performance of each technique are described in Chapter 4. It is not considered practicable to use both techniques. The emission levels associated with BAT for the pollutants specified below are considered to be:

- Total particulate matter $20 - 50 \text{ mg/Nm}^3$
- Phenol $5 - 15 \text{ mg/Nm}^3$
- Formaldehyde $5 - 10 \text{ mg/Nm}^3$
- Ammonia $30 - 65 \text{ mg/Nm}^3$
- Amines <math><5 \text{ mg/Nm}^3</math>
- Total volatile organic compounds $10 - 50 \text{ mg/Nm}^3$

In general, emissions at the higher end of all of the ranges would not be expected. Where a wet electrostatic precipitator or a stone wool filter are used total particulate matter emissions towards the bottom of the range would be expected; and where a packed bed scrubber is used gaseous emissions towards the bottom of the range would be expected.

Curing oven emissions

In glass wool production, BAT and the associated emission levels are generally considered to be as given above, except for phenol emissions where the associated emission level is 5 - 10 mg/Nm³.

In general, for stone wool processes BAT is considered to be the use of a thermal incineration unit, and the emission levels associated with BAT for the pollutants specified below are considered to be:

- Total particulate matter $5 - 30 \text{ mg/Nm}^3$
- Phenol <math><5 \text{ mg/Nm}^3</math>
- Formaldehyde <math><5 \text{ mg/Nm}^3</math>
- Ammonia <math><20 - 65 \text{ mg/Nm}^3</math> or <math>< 0.4 \text{ kg/tonne of finished product}</math> (up to a maximum of 100 mg/Nm³).
- Amines <math><5 \text{ mg/Nm}^3</math>
- Volatile organic compounds <math><10 \text{ mg/Nm}^3</math>

The emission levels associated with BAT given above for forming area and curing oven emissions may not be achievable with these techniques under all circumstances. If high density

products or products with high binder contents are produced, the levels achieved with the techniques generally considered as BAT for the sector could be significantly higher. If these types of products represent the majority of the production from a given installation then consideration should be given to other techniques.

For both forming area and curing oven emissions the figure given for amines ($<5 \text{ mg/m}^3$) is based on the use of amine free binders and non-amine catalysed resins.

Emissions from product cooling can be treated separately or combined with forming or curing emissions. Where they are treated separately the emission levels associated with BAT are considered to be the same or lower than those for the forming area. BAT for particulate matter from other downstream activities such as machining and packaging is considered to be the use of a bag filter system. The emission level associated with BAT is considered to be less than 5 mg/Nm^3 .

5.9 Ceramic Fibre

5.9.1 Melting

BAT for melting in this sector is considered to be electric melting in conjunction with a bag filter system. The emission levels associated with BAT for the pollutants specified below are considered to be:

- Particulate matter $<10 \text{ mg/Nm}^3$.
- Oxides of nitrogen (as NO_2) $<0.1 - 0.5 \text{ kg/tonne melt}$.
- Oxides of sulphur (as SO_2) $<0.1 - 0.5 \text{ kg/tonne melt}$.
- Chlorides (expressed as HCl) $<10 \text{ mg/Nm}^3$
- Fluorides (expressed as HF) $<5 \text{ mg/Nm}^3$
- Metals (Group 1 + 2) $<5 \text{ mg/Nm}^3$
- Metals (Group 1) $<1 \text{ mg/Nm}^3$

Classifications for metals and their compounds are given in Table 5.2.

5.9.2 Downstream Processing

BAT for all areas where dust may arise in this sector is considered to be collection and extraction to a bag filter system. The emission levels associated with BAT for the pollutants specified below are considered to be:

- Particulate matter 5 mg/Nm^3 .
- Ceramic fibre (Note 1) 1 mg/Nm^3 .
- Volatile organic compounds $10 - 20 \text{ mg/Nm}^3$.

Note 1

A fibre in this context is defined as an object of length greater than $5 \mu\text{m}$, breadth less than $3 \mu\text{m}$ and having a length/breadth ratio greater than 3:1.

5.10 Frits

5.10.1 Dust

In general in this sector, BAT for dust is considered to be the use of an electrostatic precipitator or bag filter operating, where appropriate, in conjunction with a dry or semi-dry acid gas scrubbing system. The BAT emission level associated with these techniques is 5 - 30 mg/Nm³ which generally equates to less than 0.1 kg/tonne of glass melted. Values in the lower part of the range given would generally be expected for bag filter systems. In some cases, the application of BAT for metals emissions may result in lower emission levels for dust.

It is acknowledged that these performance levels represent a significant improvement over current performance for many continuous furnaces, and therefore could represent medium term proposals for such furnaces. There are no overriding technical obstacles to the achievement of 30 mg/Nm³, and given the necessary time for the development and implementation of the appropriate techniques this figure should be achievable.

5.10.2 Oxides of Nitrogen

In general in this sector, the BAT for oxides of nitrogen (expressed as NO₂) is considered to be the use of oxy-fuel melting. The emission level associated with BAT is considered to be 0.5 - 1.5 kg/tonne of glass melted or alternatively 500 - 700 mg/Nm³, if conventional air-gas systems are able to achieve this level with primary or secondary measures.

It is acknowledged that these performance levels represent a significant improvement over current performance for many continuous furnaces, and therefore could represent medium term proposals for such furnaces. There are no overriding technical obstacles to the achievement of the emission levels stated above, and given the necessary time for the development and implementation of the appropriate techniques this figure should be achievable.

5.10.3 Oxides of Sulphur

In general for frit production, the BAT for oxides of sulphur (expressed as SO₂) is considered to be fuel selection (where practicable) and control of batch composition. The emission level associated with BAT is considered to be 0.1 - 0.5 kg/tonne of glass melted which generally equates to less than 200 mg/Nm³. If oil firing is used or the batch contains significant levels of sulphate the emission level associated with BAT is 500 - 1000 mg/Nm³.

5.10.4 Other Emissions from Melting

In general in this sector, the emission levels associated with BAT for the pollutants specified below are considered to be:

- Chlorides (expressed as HCl) <10 mg/Nm³.
- Fluorides (expressed as HF)(Note1) <5 mg/Nm³.
- Metals (Class 1 + 2) <5 mg/Nm³
- Metals (Class 1) <1 mg/Nm³

Classifications for metals and their compounds are given in Table 5.2.

Note1

Where batch materials contain significant levels of fluorides, this level is based on the use of an acid gas scrubbing system.

5.10.5 Downstream Processes.

The only likely emission from these activities is dust and BAT is considered to be the use of a bag filter system. The emission levels associated with BAT are considered to be 5 - 10 mg/Nm³ for particulate and <5 mg/Nm³ for Metals (Class 1 + 2).

5.11 Emissions to Water

Aqueous emissions from the activities in the glass industry are generally low and not specific to the industry. However, a number of activities can give rise to more significant aqueous emissions. The emission levels given below are generally considered to be appropriate to protecting the water environment and are indicative of the emission levels that would be achieved with those techniques generally considered to represent BAT. They do not necessarily represent levels currently achieved within the industry but are based on the expert judgement of the TWG.

• Suspended solids	<30 mg/l
• Chemical oxygen demand (Note1)	100 - 130 mg/l
• Ammonia (Kjeldahl)	<10 mg/l
• Sulphate	<1000 mg/l
• Fluoride	15 - 25 mg/l
• Arsenic	<0.3 mg/l
• Antimony	<0.3 mg/l
• Barium	<3.0 mg/l
• Cadmium	<0.05 mg/l
• Chromium (Total)	<0.5 mg/l
• Copper	<0.5 mg/l
• Lead (Note 2)	<0.5 mg/l
• Nickel	<0.5 mg/l
• Tin (Note 3)	<0.5 mg/l
• Zinc	<0.5 mg/l
• Phenol	<1.0 mg/l
• Boric acid	2 - 4 mg/l
• pH	6.5 - 9
• Mineral oil	<20 mg/l

(Note 1) - For the continuous filament glass fibre sector this figure is considered to be 200 mg/l. In general, chemical oxygen demand is quite low and the actual level associated with BAT may depend on the receiving water. If the receiving water is particularly sensitive levels below this figure may be required.

(Note 2) - For domestic glass installations utilising significant amounts of lead compounds, 1.0 mg/l is currently considered to be more appropriate. There are no overriding technical obstacles to the achievement of 0.5 mg/l, and given the necessary time for the development and implementation of appropriate techniques this figure will be achievable.

(Note 3) - For container glass processes utilising aqueous scrubbers for treating downstream emissions an emission level of <3 mg/l is more appropriate.

Discharge to a sewage treatment works or to other off-site treatment may also constitute BAT. Where this approach is proposed consideration should be given to the suitability of the receiving facility.

5.12 Other Wastes

Wherever practicable, the prevention or where that is not practicable, the minimisation of waste by primary means is considered to constitute BAT.

Wherever practicable, the recycling of cullet or other process waste back to the process is considered BAT. Fine material to be recycled to a hot blast cupola generally requires treatment such as briquetting. In the Continuous Filament Glass Fibre Sector the recycling of process wastes has proven difficult and further development work is recommended.

The recycling of particulate matter collected from waste gas streams to the process wherever practicable is considered to constitute BAT (this does not include regenerator waste). In most melting operations, where dry collection systems are used, this will involve a simple adjustment of the batch formulation to allow for the composition of the collected material. The difficulties associated with recycling collected material from dry scrubbing systems are discussed in Chapter 4. In some circumstances a compromise may have to be made between achieving the levels discussed for emissions to air and minimising the generation of a solid waste stream. Where this situation arises it must be considered on an installation specific basis, and on the relative priorities for the minimisation of pollution to the environment as a whole.

Where conditions allow, the maximised use of cullet and recycled waste (both internal and external) is considered as complementary to BAT, this is based on:

- Reduced waste (on site only).
- Generally improved energy efficiency.
- Contribution to minimising certain other emissions.
- Reduced consumption of natural resources.

6 EMERGING TECHNIQUES

The Glass Industry can be very innovative in its products and applications, especially in the low volume, high value areas of the industry. The innovations in the melting operations tend to be more gradual and incremental, and are sometimes based on the adaptation of existing concepts. The investments in glass furnaces are substantial and modifications are difficult before the next rebuild. If problems occur during the campaign lost production time and repairs can be very costly, especially if the furnace has to be allowed to cool. Therefore, major modifications carry quite a high risk and companies need to be quite confident of performance before they implement new designs and technology. Similarly the effects of any new technology can only be fully assessed over the period of a full campaign.

The increasing pressure to improve environmental performance has proven to be a strong stimulus for innovation, particularly in developing alternatives to potentially expensive conventional secondary abatement equipment. For example:

- The 3R process was developed from the chemical reduction by fuel principle, which has been conventionally used in large combustion plants. Although it is based on the adaptation of an existing principle, substantial development and innovation was required to apply the principle successfully to glass furnaces.
- The FENIX system is an optimisation of the combustion conditions in the furnace based on burner modifications and a detailed knowledge of the factors that affect NO_x formation and how they interact in the furnace environment.
- Low NO_x burner systems that were originally developed for other applications have been modified specifically for glass furnaces.
- The Sorg LoNO_x melter is an innovative redesign of a conventional glass furnace to minimise NO_x formation and maximise heat recovery.

There are no major breakthroughs in technology expected in the medium term, but a number of techniques are undergoing constant developments to optimise their benefits, which may make them more attractive to industry in the long term. There are also a number of completely new concepts under development, but these are not expected to find application in the industry within the foreseeable future.

This chapter briefly discusses those techniques that are available and cannot be considered as emerging but which are likely to undergo further developments (Sections 6.1 to 6.6), and also those more innovative long-term techniques that are still at pilot scale.

6.1 Low NO_x Burner Systems

New burner systems are still undergoing developments and further incremental advances can be anticipated. The application of these new burners combined with advanced combustion control methods, using exhaust gas analytical methods shows a potential for further reduction in NO_x formation. Also furnaces are being designed to optimise the geometry to the new combustion systems. However, there are some technological issues to be considered as the developments continue, for example:

- there is a potential risk of refractory damage by the reducing parts of flames touching the combustion chamber refractories; and
- the reducing conditions above the melt or batch blanket could affect glass quality and may cause early sulphate decomposition requiring extra sulphate to be added to assure complete fining, which may lead to increased SO_x emissions.

6.2 Oxy-fuel melting

This cannot be considered as an emerging technique and is described in detail in Chapter 4. However, it is certainly still undergoing development even in those sectors where it is well established. Most of the early full-scale furnaces are still less than 10 years old, but the most recent furnaces have incorporated modifications based on the experience to date. There have also been developments with the burner systems to apply the benefits of low NO_x burners.

The existing installations are still based on a conventional recuperative style cross-fired furnace. As mathematical modelling techniques are applied and experience grows further developments are likely with this technique, particularly in regard to furnace geometry. Also with time it will become clearer to which applications the technique is most suited, and in which applications it offers little or indeed no overall benefits. As discussed in Chapter 4 a further area of potential development is the use of heat recovery systems with oxy-fuel melting.

6.3 Cullet and Batch Preheating

The main examples of these techniques are described in Chapter 4 and again are not considered as emerging techniques, but they are undergoing significant development. It is anticipated that the use of these techniques will become more widespread as operating problems are solved and experience increases. Many sectors are working on initiatives to increase the use of post consumer and secondary processor waste. If these developments continue as expected then the applicability of these techniques may increase further.

6.4 Batch Formulations

There are currently a number of interesting developments regarding batch formulation and these are summarised below

As discussed in Section 4.4.1.1, glass formulations that, in combination with other techniques, reduce dust emissions are being developed within the soda-lime glass sectors of the Glass Industry. It is claimed that emission levels in the range 70 - 100 mg/m³ could be possible in many applications.

In Germany and the Netherlands research projects have been initiated for the development of new selenium raw materials with a lower volatility and an improved decolourising efficiency. Application of these new selenium raw materials could limit selenium emissions in the future during production of tableware and flint glass. No further information is currently available.

A new glass composition for continuous filament glass fibre has been developed by one producer. This glass composition addresses two main air emission components typical of E-glass melting i.e. particulates and fluorides. This glass composition does not include boron or added fluorine. The fluoride emission reduction is due to the fact that, having no added fluorides in the glass composition, fluoride emissions are limited to the tramp fluorides present in raw materials, resulting in fluoride emissions below 50 mg/m³. The particulate formation mechanism in standard E-glass formulations is governed by the volatilisation of borate species. Over 85 % of the particulate matter emitted from the furnace is related to boron and the removal

of the borate species from the glass results in a substantial reduction in particulate formation to generally below 50 mg/m³.

The elimination of boron and added fluoride render this glass more difficult to melt (higher melting temperature) and to fiberise, and can lead to some increase in energy requirements. More experience is necessary to determine the long term resistance of furnace refractories. The implementation of this glass formulation also requires the qualification of the various product types and modifications to the melting and forming operations. It is, however, considered as a promising route to achieve significant emission reductions by primary means. This technique has been developed by one company and is covered by patents, and therefore is not generally available within the sector.

6.5 Integration of Frit Processes

A technique has been patented in Spain, which involves the designing of multi-furnace frit installations on a modular basis to group together similar types of operations. The approach allows the use of recuperators to preheat combustion air and also can make dust abatement and recycling more economical.

6.6 Flue Gas Recirculation

Waste gas from the furnace could in principle be re-injected into the flame to reduce the oxygen content and therefore the temperature and the NO_x formation efficiency. This kind of process is widely used in combustion technology, including more recently in the metallurgical industry. For the Glass Industry, it seems to raise potential difficulties regarding flame stability, combustion efficiency as well as CO, unburned hydrocarbons and solids emissions. The stability of the refractories of the checkers could also be a source of problems for application in regenerative furnaces. Encouraging results were obtained at lab scale and on a pilot furnace, but difficulties have been encountered when applying this technique at industrial scale, and more research still seems necessary to fully evaluate the potential of this technology.

The recent concept of "synthetic air", based on the combination of flue gas recirculation and the use of oxygen firing, is also potentially a valuable emerging technique. At the time of writing there is no practical experience of this process.

6.7 Glasulin Research Program

This is a joint project between 17 glass companies and 4 research institutes and has the objective of developing new methods for the reduction of sulphate levels in the batch. This work involves using sulphur sensors, improving understanding of the sulphate fining process and controlling the redox state (which allows lower addition of sulphate but retaining the required fining efficiency). The reduction of SO₂ emissions that can be achieved by controlling sulphate addition and redox state, depend very much on the cullet quality, the cullet/batch ratio, the required glass quality and the type of fuel used. In some case SO₂ emissions could be reduced by as much as 30 - 40 %.

Nitrates are often added to glass melting processes using antimony oxides or arsenic oxides as fining agents. Nitrates (as oxidants) are also added to the batches that contain scrap or other recycled materials rich in organic components. The nitrates oxidise the organic compounds in the batch blanket between about 500 - 900°C. More research is necessary to optimise the redox state of batches without the excessive use of nitrates. Some companies have developed incinerator or pyrolysis techniques to burn off organic components before recycling the internal

scrap (waste wool or fibres) into the glass melting furnace, thus limiting the amount of required nitrates.

6.8 New Melter Designs

6.8.1 The Seg-Melter

The segmented melting concept seeks to capitalise on the different melting requirements of the two main raw materials used in container glass manufacture, batch and cullet. Pure batch is melted at approximately 1400°C with a dwell time of 24 hours, while cullet requires a melting temperature of only 1100°C and a dwell time of 1 - 2 hours.

Batch is charged into an all-electric pre-melting furnace capable of converting 75 % of the raw material into glass. The pre-melted batch then moves via a throat into an enlarged doghouse where cullet is added (cullet comprises at least 60 % of the raw material). The batch/cullet mix then enters the second melting chamber. This is gas or oil-fired, uses oxy-fuel burners, and has a glass depth which is less than that of the pre-melting section.

The system potentially offers a number of advantages:

- emissions during the all-electric pre-melt stage are almost eliminated;
- fuel consumption in the second melting chamber is lower because cullet melts at a lower temperature than the batch;
- the use of oxy-fuel burners minimises NO_x emissions from the second melting chamber;
- the second melting chamber can be smaller in size because of the reduced dwell time required.

For a 230 tonne/day furnace converted to a Seg-melter, thermal efficiencies are more than 25 % higher than those achieved using conventional melting. Maintenance requirements, however, can be higher. Although a complete campaign has been estimated at 15 years, the electric melting section of the Seg-melter is expected to require repairs approximately every three years, with the fuel-fired section continuing to operate at reduced load. [tm5 EEO]

6.8.2 The Advanced Glass Melter

The Advanced Glass Melter (AGM), which is currently under development, employs a totally different concept for batch pre-heating and melting. Batch materials are injected into the reaction zone of the flame in a natural gas-fired combustor. Rapid heating occurs while the materials are in suspension, and both the products of combustion and the heated batch materials are then discharged via a high velocity nozzle into the melt chamber and on to a “centre body”, off which the molten glass flows into a reservoir. Because the flame temperature is quenched by the presence of the batch in the flame, one major advantage of this system is its potential for low NO_x emissions.

6.8.3 The Plasma Melter

The British Glass Research Group is currently developing a rapid melting process, which makes use of the electrical conductivity of molten glass. The system comprises three electric arc torches positioned at 120 °C to one another. These are fed with a supply of high purity argon gas that is ionised and forced out of the torch nozzles in the form of a low energy plasma flame. An insulating crucible containing molten glass is situated below the torches. Batch or cullet is fed into this melting bath from above, while molten glass is continuously drawn from the base.

The system can operate as either a pre-melter or a final melter. Pre-melting on non-conducting glass cullet and batch is achieved when the torches are brought into close proximity. Current is transferred from one torch to another through the ionised plasma jet, and convective heat from the expanding gas and radiative heat from the plasma combine to create a molten pool of glass. In final melting mode the torches are repositioned so that the plasma current flows from torch to torch via the molten glass. The resistance of glass is sufficiently low at these high temperatures to permit this mode of operation.

The system offers a number of potential benefits:

- batch and cullet can be melted in minutes to produce partly refined glass;
- the furnace can be turned on and off at will;
- the composition and colour of the glass can very rapidly be altered;
- operation is virtually pollution free - SO_x, NO_x and dust emissions are negligible.

This type of melting could be available for very small-volume melts within the next few years. It is not expected to be a viable technique for melting more than 20 tonnes a day within the foreseeable future.

7 CONCLUDING REMARKS

This chapter outlines the conclusions and recommendations of the information exchange on best available techniques in the Glass Industry. It does not cover the conclusions regarding BAT which are given in Chapter 5.

7.1 Information Exchange

The work on this document began in January 1998 with the preparation of papers outlining proposals for the scope of the work and the key issues. The first meeting of the Technical Working Group (the “kick off” meeting) was held on 29 and 30 January 1998. During this meeting agreement was reached on the document structure, the scope of the work, and the basic methodology for the exchange of information. The key environmental issues and the priorities for the work were identified, and various submissions were made by Member States and Industry.

From January to October 1998 information was collected for chapters 1 to 4 and chapters 1 to 3 were drafted. Key features of the information exchange at this stage were site visits and meetings of the subgroups of the Technical Working Group (TWG). In November 1998 a draft document covering chapters 1 to 3 was issued for consultation. During the period November 1998 to February 1999 further information was collected and the first full draft of the document was prepared incorporating the comments on chapters 1 to 3. Consultation on this draft took place during March and April. The consultation responses were considered by the EIPPCB and a second full draft was issued in September 1999 for consideration before the second TWG.

A great deal of information was made available by most industry sectors and by Member States, in particular Netherlands, France, Germany, Italy and Austria. Information regarding Frits and Ceramic Fibre only became available later in the project and was generally less detailed. The majority of the information on Frits was supplied by the Spanish industry.

The information was validated by site visits, consultation with TWG members and by scrutiny within the EIPPCB. Information was generally of a very high quality and was refined further as the information exchange progressed. However, there are a number of gaps in the information and areas where more detail would be beneficial. These issues are discussed in Section 7.3 below.

The second TWG was held 17 to 19 November 1999. A range of issues, but particularly those relating to Chapter 5 were discussed in detail and a good level of consensus was obtained. A small number of important issues were discussed further in a number of working groups which had a mandate from the main TWG to reach a consensus on the remaining issues in Chapter 5. The results of these working groups have been incorporated into the revised document and there are no major issues outstanding on which the TWG was not able to reach consensus.

7.2 General Conclusions

The information exchange on best available techniques in the Glass Industry was generally very successful, and a high degree of consensus was reached following the second TWG meeting. A great deal of information was made available and there was a high degree of participation by most sectors of the Industry and by most Member States. The TWG provided a forum for established experts to exchange views and information, and to discuss issues in an impartial environment.

It was very clear from the beginning of this work that the Glass Industry as identified by Sections 3.3 and 3.4 of Annex 1 of the Directive, was extremely diverse, both in scale and the technologies used. One of the most important conclusions was that due to this diversity it is often inappropriate to specify particular techniques to be applied as BAT across all processes and sectors. The general approach taken in this document is to identify levels of performance which are indicative of the use of BAT and then to identify those techniques which are most likely to be appropriate for a given sector. Throughout Chapter 5 it is acknowledged that the most appropriate way of achieving these performance levels can differ from process to process.

A great deal has been achieved in recent years to improve the environmental performance of the industry. This trend is continuing and further improvements are expected. As explained in Chapter 6 improvements in performance are anticipated from the further development of primary techniques and more conventional secondary techniques, rather than completely novel new techniques.

As the expectations and requirements for environmental performance increase the industry is faced with potentially high costs of compliance. This provides an incentive for industry to develop more cost-effective methods of achieving these performance levels and the Glass Industry has been quite successful in meeting this challenge. The most cost-effective techniques are often primary techniques, which prevent the emission of pollutants rather than treating the substances emitted. When considering the overall impact on the environment primary techniques are generally preferable where they can achieve equivalent emission levels. Particular successes have been with the use of primary techniques, including oxy-fuel firing, to control emissions of NO_x. However, for particulate emissions primary techniques are not generally capable of achieving emission levels comparable to secondary techniques.

7.3 Recommendations for Further Work

As discussed above the quality of the information supplied was generally very high, but a number of areas were identified where further information would be helpful in refining the determination of BAT. The objective of this project was the co-ordination and reporting of the exchange of information on BAT. It was not within the scope of this work to carry out new research to fill these information gaps. However, there are examples where the EIPPCB or members of the TWG have collected or correlated new information. The recommendations for areas for further work and areas that should be reviewed when this document is revised are discussed below.

Further work would be useful to provide a more in depth understanding of cross media issues. In particular it would be beneficial to develop a methodology for assessing the relative effects on the environment taken as a whole of emissions to different media. For example, a major consideration for some installations is the potential conflict of priorities for waste minimisation and the reduction of SO₂ emissions to air, where dry or semi-dry scrubbing could be used but there is a limited potential for internal recycling of the collected material.

Equally important would be a methodology for assessing the relative effects of emissions of different substances to the same medium. For example, the conversion from oil to gas firing will reduce SO₂ emission but may in some cases result in slightly higher NO_x emissions and slightly increased fuel usage. There is also a potential that in reducing excess oxygen levels to reduce NO_x formation the redox state of the glass could be altered resulting in higher SO₂ emissions.

A further complication in determining BAT can be the assessment of the environmental impact of off-site activities. For example, electric melting will substantially reduce emissions from the furnace. However, an assessment of the environmental impact of the generation and distribution of the electricity relative to the reduced emissions would be beneficial to determine the option that provides the best protection for the environment taken as a whole.

A more detailed consideration of the financial costs of the various techniques would be beneficial when this document is revised. Much of the financial information given in Chapter 4 is indicative rather than precise. This is inevitable due to the variations in the installations considered, the commercial sensitivity of financial information, and in many cases the very limited number of available examples. Professor Beerkens of TNO prepared a report for the EIPPCB [tm32 Beerkens] summarising the available information, and much of the financial data is based on this report. A possible improvement would be to use a series of case studies to compare the cost and effectiveness of various options at a particular installation. This could potentially overcome some of the difficulties of comparing costs at different installations, but would require information that is not currently available.

Further work would be useful in assessing the techniques to be considered in determining BAT for emissions to the water environment, and for energy usage. Due to resource and time constraints these aspects were not considered in as much detail as some other issues in the BREF.

Some of the techniques discussed in this document were in a developing situation and further information is expected to become available over the next few years. Any revision of this work should consider such developments and how any further information affects the conclusions of this document.

The application of oxy-fuel firing is at a relatively early stage and although many of the technical issues have been resolved there are still some issues that that can only be assessed with information from the long-term use of the technique. In particular, with further operating experience the effect of oxy-firing on refractory life should be assessed. This is important to the economic viability of the technique in some sectors and currently represents an element of financial risk, which is deterring some operators from applying the technique. Also the direct costs of the technique should be reassessed particularly with regard to the balance between energy savings and the cost of oxygen. This is can be a critical issue in the economic attractiveness of the technique and the situation currently varies widely across Europe.

There are also a number of other techniques where some issues are unproven or contested either for the industry as a whole or for certain applications. For example, SCR, SNCR, Reburning and cullet/batch preheating. Developments in these areas should also be reviewed following further operating experience.

For the Domestic Glass and Continuous Filament Glass Fibre Sectors it was difficult to reach firm conclusions on BAT for emissions of NO_x. When this document is revised the position for these sectors and the progress with the suggested techniques should be reviewed.

It is recommended that this document be reviewed in 4 years time.

8 ANNEX I: EXAMPLE INSTALLATION EMISSION DATA

This information is presented to supplement the information given in Chapter 3. These plants are real examples and the data represents actual measured emissions. Most of the data relates to 1997. These examples are presented as being representative or typical examples from around the EU they are **not** presented as indicative of BAT. The majority of the fossil fuel furnaces have provision for electric boosting.

8.1 Container Glass Sector

The data presented is generally for a single furnace in each installation. Most container glass installations have 2 or more furnaces. Abatement systems are generally common to more than one furnace; in this case (e.g. CG6) the emission data is also common to other furnaces.

Furnace	Furnace Type	Fuel	Capacity (tonnes/day)	Cullet (%)	Abatement Techniques/Comments
CG 1	Cross-fired regenerative	Gas	370	72	Cullet/batch preheater, Primary NOx measures, Electrostatic precipitator
CG 2	Cross-fired regenerative	Gas	370	28	
CG 3	Cross-fired regenerative	Oil	400	50	Low NOx burners Switch to low sulphur FO planned
CG 4	End-fired regenerative	Oil	70	41	High quality flint glass for perfumery
CG 5	End-fired regenerative	Gas	244	10	Recent switch to natural gas firing
CG 6	End-fired regenerative	Oil	300	80	Acid gas adsorption tower, electrostatic precipitator, waste heat boiler (system common to another furnace).
CG 7	Unit melter oxygen fired	Gas	80	38	Borosilicate glass for pharmacy No batch sulphate Electrostatic precipitator
CG 8	Recuperative	Gas	400	not known	Primary measures – low NOx burners
CG 9	Unit melter oxygen fired	Gas	350	65	Bag filter and waste heat boiler
CG 10	Unit melter oxygen fired	Gas	310	84	Indirect cullet preheater, bag filter and waste heat boiler

Furnace	Melting Energy (GJ/tonne)	Dust mg/Nm ³ (kg/tonne)	NOx as NO ₂ mg/Nm ³ (kg/tonne)	SOx as SO ₂ mg/Nm ³ (kg/tonne)	HCl mg/Nm ³ (kg/tonne)	HF mg/Nm ³ (kg/tonne)
CG 1	3.49	24 (0.032)	708 (0.955)	402 (0.542)	7.2 (0.010)	ND
CG 2	4.12	127 (0.22)	772 (1.31)	645 (1.10)	NM	NM
CG 3	4.54	169 (0.29)	1080 (1.9)	2640 (4.3)	62 (0.106)	1 (0.002)
CG 4	7.16	175 (0.56)	700 (2.2)	950 (3.0)	NM	NM
CG 5	5.35	160 (0.28)	1528 (2.7)	198 (0.4)	25 (0.045)	2 (0.004)
CG 6	3.94	3 (0.005)	800 (1.25)	1300 (2.04)	11 (0.017)	0.3 (0.0005)
CG 7	5.98	< 5 (< 0.005)	2158 (0.61)	ND	NM	NM
CG 8	5.22	100 (0.22)	360 (0.8)	810 (1.8)	NM	NM
CG 9	3.35	NM	(0.7)	(0.8)	NM	NM
CG 10	3.35	(0.0006)	(0.5)	(0.6)	(0.013)	(0.0007)

ND = < detection limit

NM = not measured

8.2 Flat Glass Sector

These plants are all float glass furnaces.

Furnace	Furnace Type	Fuel	Capacity (tonnes/day)	Abatement Techniques/Comments
FG 1	Cross-fired Regenerative	Oil (<2 %S)	600	1° NOx (FENIX), 1998 data. Waste heat boiler
FG 2	Cross-fired Regenerative	Oil (2.3 %S)	450	1° NOx Reduction to 2.4 % S oil
FG 3	Cross-fired Regenerative	Gas or oil (1 %S)	650	1° NOx, EP + dry scrubber with 100 % dust recycle Waste heat boiler
FG 4	Cross-fired Regenerative	Gas	600	1° Controls
FG 5	Cross-fired Regenerative	Gas	810	1° NOx and 3R (only 2/6 ports with 3R), EP + dry scrubber with 100 % dust recycle Waste heat boiler
FG 6	Cross-fired Regenerative	Gas	500	SCR, EP + dry scrubber with 100 % dust recycle
FG 7	Cross-fired Regenerative	50:50 Gas and oil	550	Bag filter with dry scrubbing (soda ash)

Furnace	Melting Energy GJ/tonne	Dust mg/Nm ³ (kg/tonne)	NOx as NO ₂ mg/Nm ³ (kg/tonne)	SOx as SO ₂ mg/Nm ³ (kg/tonne)	HCl mg/Nm ³ (kg/tonne)	HF mg/Nm ³ (kg/tonne)
FG 1	5.4	196 (0.43)	510 (1.1)	3381 (7.57)	39 (0.087)	4.8 (0.011)
FG 2	7.74	213 (0.68)	1473 (4.22)	2400 (6.87)	19 (0.062)	0.06 (0.0002)
FG 3	6.16	15 (0.04) average	1300 (2.7) average	830 (2.1)	30 (0.082)	4 (0.011)
FG 4		156 (0.41)	2578 (6.82)	748 (1.98)	<10 (<0.03)	<1 (<0.003)
FG 5		11 (0.024) average	1294 (2.94) ⁽¹⁾ average	545 (1.24) average	9 (0.02) average	0.4 (0.0008) average
FG 6	6.14	<10 (0.02)	495 (1.12)	295 (0.67)	<5	<1
FG 7	NM	<10 (<0.03)	2200 (6)	200 (0.56)	<30 (<0.08)	<5 (<0.02)

(1) 3R was only operational on 2 out of 6 ports. If all ports had been operating with 3R the emission level would have been <500 mg/Nm³ and < 1.0 kg/tonne of glass melted.

8.3 Continuous Filament Glass Fibre Sector

Furnace	Furnace Type	Fuel	Capacity (tonnes/day)	Abatement Techniques/Comments
CF 1	Cross-fired recuperative	Gas	>40	No 2 ^o abatement, added fluoride batch.
CF 2	Cross-fired recuperative	Gas	>40	No 2 ^o abatement, "reduced" added fluoride batch.
CF 3	Cross-fired recuperative	Gas	>40	No 2 ^o abatement, no added fluoride batch
CF 4	Cross-fired recuperative	Gas	>75	1 ^o NOx, wet scrubber with alkaline reagents, no added fluoride batch.
CF 5	Cross-fired recuperative	Gas	>40	No 2 ^o abatement, new proprietary no added fluoride or boron.
CF 6	Cross-fired recuperative	Gas	>55	1 ^o NOx, EP, no added fluoride.
CF 7	Cross-fired recuperative	Gas	>75	No 2 ^o abatement, added fluoride batch.
CF 8	Cross-fired recuperative	Gas	50	EP/Bag filter with lime injection?

Furnace	Melting Energy GJ/tonne	Dust mg/Nm ³ (kg/tonne)	NOx as NO ₂ mg/Nm ³ (kg/tonne)	SOx as SO ₂ mg/Nm ³ (kg/tonne)	HCl mg/Nm ³ (kg/tonne)	HF mg/Nm ³ (kg/tonne)
CF 1	14.9	158 (1.22)	1009 (7.8)	136 (1.31)	3 (0.03)	123 (0.94)
CF 2	18.2	218 (1.23)	968 (5.5)	133 (0.85)	3 (0.02)	93 (0.53)
CF 3	13	300 (1.2)	1140 (4.6)	56 (0.22)	4 (0.02)	17 (0.07)
CF 4	10.5	20 (0.22)	1100 (12.44)	270 (1.85)	0	0
CF 5	18.2	13 (0.05)	1070 (3.9)	135 (0.5)	5 (0.02)	21 (0.08)
CF 6	8.75	9.5 (0.04)	1350 (6.8)			
CF 7		294 (1.6)	672 (3.52)			258 (1.42)
CF 8	16.2	4.1 (0.02)	1020 (5.0)	620 (3.0)		1.0 (0.0005)

8.4 Domestic Glass Sector

Furnace	Furnace Type	Fuel	Capacity (tonnes/day)	Abatement Techniques/Comments
DG 1	Regenerative end-fired.	Mainly gas, can use oil.	165	1° NOx
DG 2	Regenerative end-fired.	Gas	65	1° NOx
DG 3	Recuperative mixed melter	Gas and electricity	30	Bag filter.
DG 4	Electric melter	Electricity	28	Bag filter
DG 5	Regenerative end-fired. Extra white soda-lime glass.	Gas	165	Primary NOx control, 1998 data
DG 6	100 % Electrical Opal Glass	Electricity	65	Cold top electrical melting with bag filter and optimised batch formulation.
DG 7	100 % Electrical Crystal Glass	Electricity	32	Lead free crystal glass. 35 % cullet.
DG 8	100 % Electrical Soda-lime extra white	Electricity	48	Wet scrubber 405 cullet
DG 9	Recuperative	Gas	34	EP

Furnace	Melting Energy GJ/tonne	Dust mg/Nm ³ (kg/tonne)	NOx as NO ₂ mg/Nm ³ (kg/tonne)	SOx as SO ₂ mg/Nm ³ (kg/tonne)	HCl mg/Nm ³ (kg/tonne)	HF mg/Nm ³ (kg/tonne)
DG 1	4.8	109 (0.23)	2314 (4.9)	186 (0.58)		
DG 2	6.5	171 (0.7)	2087 (8.7)	3.1 (0.01)		
DG 3	9.5	<1.0 (<0.003)	1400 (3.5)			
DG 4	4.1	0.6 (<0.01)				
DG 5	4.96	108 (0.25)	1243 (2.9)	126 (0.29)		
DG 6	3.42	(0.02)	(1.0)	(0.02)		(0.001)
DG 7	3.8	1.7 (0.035)	11 (0.23)	0.36 (0.007)	0.42 (0.008)	0.05 (0.001)
DG 8	3.7	2.3 (0.02)	117 (1.07)	1.3 (0.011)	1.0 (0.009)	0.15 (0.0014)
DG 9		<1.0				

8.5 Special Glass Sector

Furnace	Furnace Type	Fuel	Capacity (tonnes/day)	Abatement Techniques/Comments
SG 1	Cross-fired Regenerative TV Panel Glass	Gas or oil	230	EP and SCR
SG 2	Cross-fired Regenerative TV Funnel Glass	Gas or oil	180	Bag filter
SG 3	Cross-fired Regenerative Borosilicate Glass	Gas up to 40 % light oil	50	Non-sulphate refining, EP with lime injection, SCR
SG 4	100 % Electrical Borosilicate Glass	Electricity	40	Cold top electric melter, nitrate refining, bag filter. 1998 data.
SG 5	Recuperative Borosilicate Lighting Glass	Gas	34	Emissions from these two furnaces are combined and treated in a 4 stage EP and SNCR. 1 ⁰ NOx controls are also applied to SG 6.
SG 6	Cross-fired Regenerative Soda-lime Lighting Glass	Gas	150	
SG 7	Cross-fired Regenerative Water Glass	Gas and oil 50:50	320	EP and SNCR
SG 8	Cross-fired Regenerative CRT Panel Glass	Gas	220	EP and SCR
SG 9	Cross-fired Oxy- gas CRT Funnel and Panel	Gas	420	EP and oxy-gas firing
SG 10	Cross-fired Oxy- gas CRT Funnel	Gas	280	EP, oxy-gas firing and SNCR

Furnace	Melting Energy GJ/tonne	Dust mg/Nm ³ (kg/tonne)	NOx as NO ₂ mg/Nm ³ (kg/tonne)	SOx as SO ₂ mg/Nm ³ (kg/tonne)	HCl mg/Nm ³ (kg/tonne)	HF mg/Nm ³ (kg/tonne)
SG 1	7.7	10 (0.033)	800 (2.7)	70 (0.082)	1 (0.003)	0.6 (0.001)
SG 2	5.8	3 (0.006)	4300 (12)	50 (0.07)	2 (0.009)	0.3 (0.001)
SG 3	17.0	45 (0.47)	900 (9.44)	<1 (<0.01)	1 (0.01)	4.5 (0.05)
SG 4	7.99	10 (0.06)	85 (0.54)	<1 (<0.01)	10 (0.06)	0.5 (0.003)
SG 5	9.55	5 (0.02)	800 (3.33)	50 (0.2)	8 (0.03)	2 (0.01)
SG 6	6.01					
SG 7	1020	10 (0.016)	500 (0.8)	350 - 500 (0.56 - 0.8)	15 (0.02)	-
SG 8	1400 - 1800	<<15 (<<0.06)	360 (1.5)	<10 (<0.04)	<<30 (<<0.1)	<<5 (<<0.02)
SG 9 19 % O ₂	1556 Panel 1389 Funnel	1 (0.003)	1800 (5)	2 (0.005)	0.4 (0.001)	0.4 (0.001)
SG 10 20 % O ₂	1388	0.9 (0.004)	510 (2.08)	3.2 (0.014)	1.6 (0.007)	0.4 (0.002)

8.6 Mineral Wool Sector

Most forming and curing operations in glass wool have impact jets and cyclones in addition to primary measures and the abatement techniques described.

Furnace	Furnace Type	Fuel	Capacity (tonnes/day)	Abatement Techniques/Comments
GW 1	Oxy-fuel tank	Oxy-gas	82 - 165	EP and oxy-gas for melting. Wet scrubber for cooling.
GW 2	Electrical melt	Electricity	165 - 274	Bag filter with dust recycling on furnace. Wet scrubbers on forming and curing. Furnace has >70 % foreign cullet.
GW 3	Electrical melt	Electricity	165 - 274	EP on furnace, venturi scrubber on curing. No foreign cullet.
GW 4	Recuperative (end-fired)	Gas	27 - 82	Venturi scrubber on curing.
GW 5	Recuperative	Gas	82 - 165	EP on furnace, wet EP on forming and curing.

Furnace	Particulate mg/Nm ³ (kg/t)	NOx as NO ₂ mg/Nm ³ (kg/t)	SOx as SO ₂ mg/Nm ³ (kg/t)	HCl mg/Nm ³ (kg/t)	HF mg/Nm ³ (kg/t)	Phenol mg/Nm ³ (kg/t)	Formalde -hyde mg/Nm ³ (kg/t)	Ammonia mg/Nm ³ (kg/t)
GW 1 Melting Forming/ Curing	7.5 (0.004) 15.7(0.078)	102 (0.63)	18 (0.035)	1.2(0.002)	0.2(0.0003)	2.1(0.164)	2 (0.141)	28 (2.16)
GW 2 Melting Forming/ Curing	1 (0.002) 25 (1.5)	30 (2.0)				12 (0.3)	2 (0.1)	60 (3.5)
GW 3 Melting Forming/ Curing	5 (0.02) 41 (2.61)	59 (0.14)			0.01	5.3 (0.34)		87 (5.56)
GW 4 Melting Forming/ Curing	1065 (7.51) 2548 (50)	704 (4.96)	1.5 (0.01)	70 (0.49)	0.8(0.005)	761 (21.7)	89 (1.75)	3046 (68)
GW 5 Melting Forming/ Curing	293 (0.373)	1706 (6.5) 371 (7.7)	0.9(0.004)	19 (0.081)	1 (0.005)	16 (1.114)	4.3(0.306)	43 (3.116)

Furnace	Furnace Type	Fuel	Capacity (tonnes/day)	Abatement Techniques/Comments
SW 1	Tank	Natural gas	82 - 165	EP with dust recycle on furnace. Wet EP on forming and curing.
SW 2	Tank	Electricity		Incinerator and bag filter on furnace Stone wool filter on forming and incinerator on curing.
SW 3	Cupola	Coke		Cyclone on furnace, stone wool filter on combined forming and curing.
SW 4	Cupola	Coke	>165	Incinerator, bag filter and dry scrubbing on furnace. Filter on forming and incinerator on curing.
SW 5	Cupola	Coke	82 - 165	Incinerator and bag filter on furnace Stone wool filter on forming and incinerator on curing.
SW 6	Cupola	Coke	82 - 165	Incinerator and bag filter on furnace Stone wool filter on forming and incinerator on curing. Slag in charge.

Furnace	Particulate mg/Nm ³ (kg/t)	NOx as NO ₂ mg/Nm ³ (kg/t)	SOx as SO ₂ mg/Nm ³ (kg/t)	HCl mg/Nm ³ (kg/t)	HF mg/Nm ³ (kg/t)	Phenol mg/Nm ³ (kg/t)	Formalde -hyde mg/Nm ³ (kg/t)	Ammonia mg/Nm ³ (kg/t)
SW 1 Melting Forming/ Curing	30 (0.1)	1210 (2.9)	165 (0.3)	1 (0.002)	0.4(0.001)	28 (6.9)		14(0.4)
SW 2 Melting Forming Curing	10 (0.002) 10 (0.3)	150 (0.03) 30 (0.15)	3000 (0.6)			30 (0.9) 0.2(0.002)	3 (0.1) 0.4(0.002)	60 (1.8) 20 (0.1)
SW 3 Melting Forming/ Curing	2600 (3.6) 12 (0.4)	300 (0.45) 4 (0.16)	930 (1.4) 2 (0.07)	H ₂ S 300 (0.4)		30 (1.1)	3 (0.1)	18 (0.7)
SW 4 Melting Forming Curing	6 (0.02) 19.5 (0.5)	159 (0.5) 160 (0.3)	385 (1.4)	15 (0.05)	2 (0.01)	18 (0.4) 7 (0.01)	7 (0.15) 7 (0.01)	55 (1.3) 45 (0.1)
SW 5 Melting Forming Curing	12.7 (0.02) 14.4(0.33) 13.2 (0.02)	169 (0.23) 89 (0.14)	1046 (1.4)		1 (0.001)	5 (0.11) 1 (0.002)	2 (0.05) 1 (0.002)	60 (1.4) 90 (0.15)
SW 6 Melting Forming Curing	57 (0.1) 44.5 (0.8) 14 (0.04)	175 (0.32)	1951 (3.6)	1.9(0.003)	1.1(0.002)	3.3 (0.06) 0.9(0.002)	10.9 (0.2) 2.8(0.005)	43 (0.78) 172 (0.31)

9 ANNEX II: EXAMPLE SULPHUR BALANCES FOR INDUSTRIAL GLASS FURNACES

In Chapters 4 and 5 references are made to the use of sulphur balances for the determination of installation specific conditions, or as the basis of comparisons between various process options. This annex provides two examples of sulphur balances and explains the related issues for these examples. The examples chosen are soda-lime furnaces (1 flat glass, 1 container glass) with complete and partial internal recycling of collected dust from a filter unit incorporating acid gas scrubbing. The figures used are examples only, and in particular the emission levels given in the examples should not be taken to be indicative of BAT.

The total recycling of filter dust depends on the type of glass, its oxidation state, its ability to absorb the SO_3 and more generally on the furnace running conditions (in particular the content of sulphur in the fuel). The best way to illustrate these aspects is to examine a complete sulphur balance as given in the figures below. For a specific case, the flow can be given in kg/h of a coherent unit (SO_2 , SO_3 , or S) or alternatively as mg/Nm^3 of SO_2 , because for a specific furnace it is straight forward to calculate the conversion factor between concentration and mass flow.

For the furnace sulphur balance, inputs are:

- Sulphur input by batch material
- Sulphur input by cullet (internal + external)
- Sulphur input by the fuel
- Sulphur input by recycled filter dust

Outputs are:

- Sulphur in glass pull
- Sulphur in the flue gas ($\text{SO}_2 + \text{SO}_3$)
- Sulphur contained in dust
- Sulphur in the dust deposited in regenerators and flues (estimated to be 1 to 5 %)

The overall sulphur balance must include the sulphur balance for the pollution control unit, i.e. outputs at the stack and the filter dust. If the filter dust quantity is not compatible with the type of glass, an external disposal route (generally landfill) must be used for at least part of the dust. Alternatively in order to minimise waste disposal, the sulphur content of the fuel can be reduced. This latter option is generally the preferred choice both in terms of protection of the environment as a whole and on economic grounds.

Recycling of filter dust implies the substitution of sodium sulphate or gypsum in the batch material. The potential amount of dust that can be recycled depends on the sulphate quantity required for refining and the possibility of substituting this sulphate by the filter dust. The dust properties and potential for recycling will depend on the running conditions and the type of absorbent (scrubbing material) used. Recycling is generally more difficult with lime injection because the abatement efficiency is lower and the dust is less oxidised. Dust arising from scrubbing with sodium carbonate or sodium bicarbonate is generally easier to recycle.

The external cullet and its average composition will also influence the SO_3 input. If the furnace is oil fired, the oil will give rise to about 1200 mg/Nm^3 of SO_2 per 1 % of sulphur in the oil. The quantity of sulphur that can be absorbed into the glass varies from almost zero for some reduced glasses, up to about 500 to 700 mg/Nm^3 for oxidising flint glasses. These figures are indicative only.

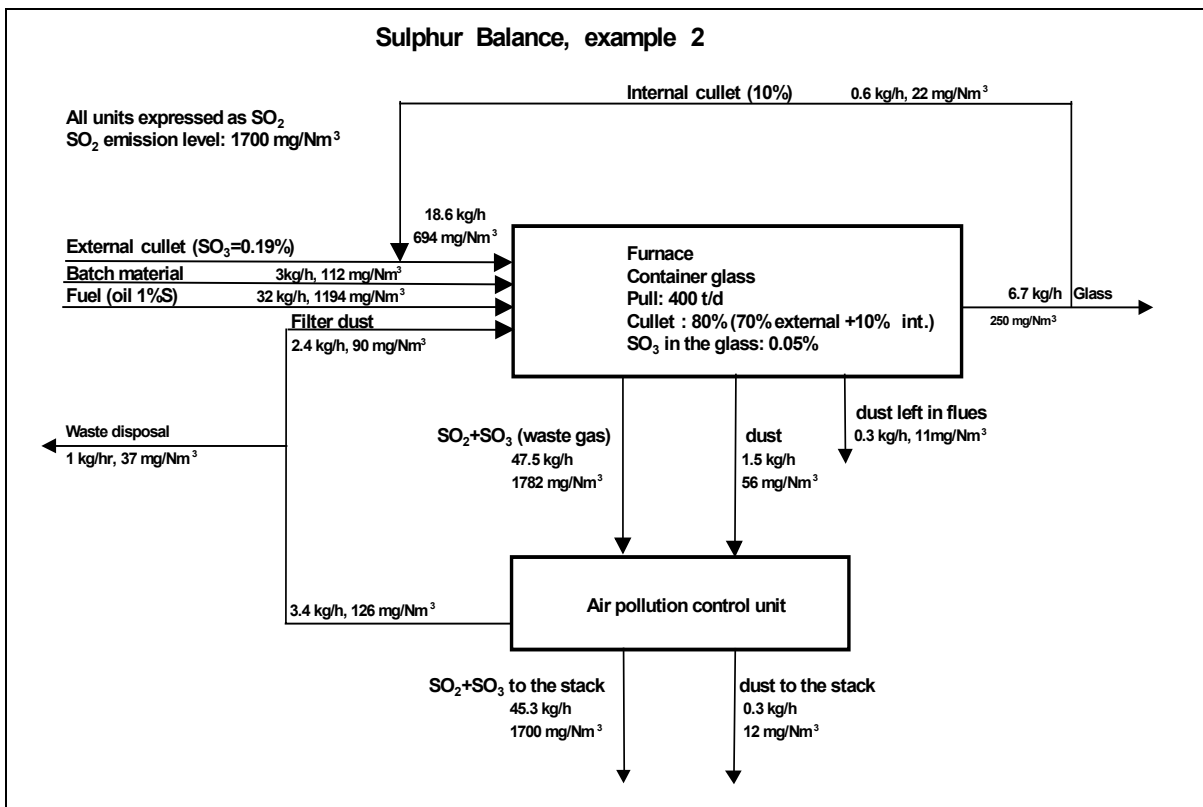
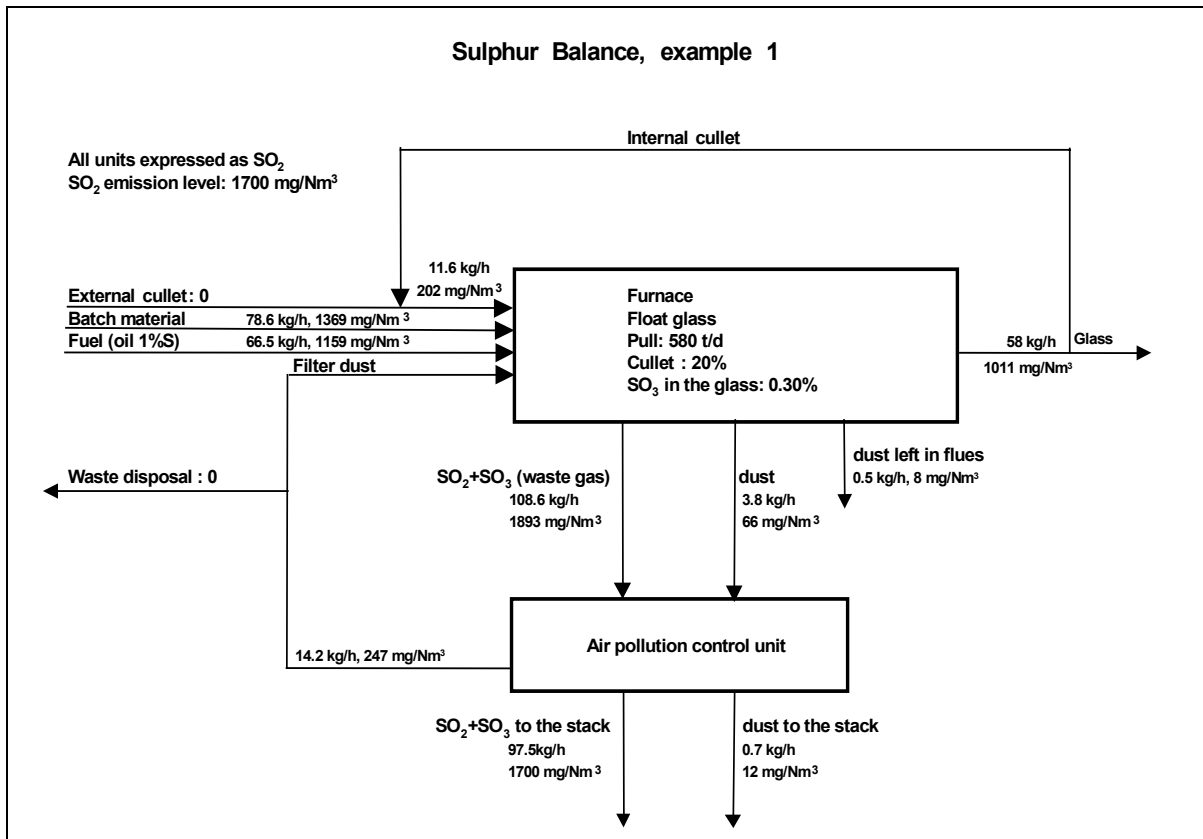

10 ANNEX III: EMISSION MONITORING

This annex gives general recommendations for the measurement of emissions from glass production processes, in order to obtain representative and comparable results. A number of national and international methods and procedures can be applied for the measurement of emissions but their use can lead to significantly different results due to the inappropriate application of general methods to a very specific case like the glass manufacturing process.

10.1 Main Pollutants

The main source of pollution from the Glass Industry is atmospheric emissions from the melting process. However, in some sectors the downstream activities can also give rise to substantial emissions. A summary of the main pollutants, indicated for the sectors identified within the Glass Industry, is given in the following Table:

Sector/Activity	Pollutants
Container Glass	
Materials handling	Dust, crystalline silica
Melting process	Dust, CO, NO _x , SO _x , HF, HCl, Heavy metals
Hot-end coating or treatment	Dust, organic and inorganic tin, HCl, SO _x
Flat Glass	
Materials handling	Dust, crystalline silica
Melting process	Dust, CO, NO _x , SO _x , HF, HCl, heavy metals (for coloured glasses)
Surface treatment	SO _x
Continuous Glass Filament	
Materials handling	Dust, crystalline silica
Melting process	Dust, CO, NO _x , SO _x , HF, HCl, gaseous boron compounds
Downstream activities	Dust, VOC, formaldehyde, ammonia, waste water
Domestic Glass	
Materials handling	Dust, crystalline silica, heavy metals
Melting process	Dust, CO, NO _x , SO _x , HF, HCl, heavy metals
Downstream activities	HF, waste water (from polishing and grinding)
Special Glass	
Materials handling	Dust, crystalline silica, heavy metals
Melting process	Dust, CO, NO _x , SO _x , HF, HCl, heavy metals, boron compounds
Downstream activities	Dust, waste water (from polishing and grinding)
Mineral Wool	
Materials handling	Dust, crystalline silica
Melting process	Dust, CO, NO _x , SO _x , HF, HCl, gaseous boron compounds, H ₂ S
Downstream processes	Dust, VOC, phenols, amines, ammonia, formaldehyde, VOC, NO _x (curing), waste water
Ceramic Fibre	
Materials handling	Dust, crystalline silica
Melting process	Dust, CO, NO _x , SO _x , H ₂ S, HF, HCl
Downstream activities	Dust, fibres, waste water
Frits	
Materials handling	Dust, crystalline silica, heavy metals
Melting process	Dust, CO, NO _x , SO _x , HF, HCl, heavy metals, boron compounds
Downstream activities	Dust, waste water

Table 10.1: Main pollutants likely to be considered for measurement in the Glass Industry

10.2 Monitoring of Emissions

Emission monitoring is universally used for ensuring compliance with permit emission limits. The mode and the frequency should be related to the extent of emissions to be verified and to the control technology being used. The methods most commonly applied are the following:

- Monitoring of abatement technique performance (e.g. bag filter pressure drop)
- Continuous monitoring of pollutants
- Discontinuous measurements of pollutants;
- Mass balance calculation.

Monitoring of abatement technique performance

In general, this is the minimum requirement imposed for emission monitoring. In some cases, (e.g. a well understood stable emission situation) the assessment of abatement technique performance could be sufficient to determine the compliance with the requirement of a permit. In many cases, automatic techniques capable of detecting the failure or malfunction of the abatement equipment are applied (e.g. measurement of pressure drop, temperature, pH, etc.).

Continuous and/or discontinuous measurement of pollutants

Emission monitoring requires the determination of all relevant parameters capable of influencing the measurement of the different pollutants, or the interpretation and reporting of results. In addition to the regulated substances (Dust, NO_x, SO_x, HCl, HF, etc.) it is necessary to determine the characteristic parameters of the emitting source e.g.:

- Flue gas velocity and mass flow
- Temperature
- Humidity
- Oxygen concentration
- Carbon dioxide concentration
- Carbon monoxide concentration

The measurement of emissions can be affected by several factors, some of which are particularly important in the case of glass melting processes. In most cases, the critical parameters can be identified as follows:

- Waste gas temperature
- Size distribution of dust
- Waste gas velocity
- Waste gas moisture
- Gaseous and particulate form of pollutants
- Sampling time
- Reference conditions

Waste gas temperature

The flue gas temperature from the furnace can vary substantially (generally 100 to 850 °C at the stack), depending on the heat recovery system (regenerators, recuperators or gas quenching) and the abatement technique applied. The higher temperatures generally correspond to recuperative type furnaces and/or oxy-fuel melting. The lower temperatures are typical of highly diluted waste gases (discontinuous furnaces, all electric melting, some furnaces with abatement

equipment, etc.). The possible measuring errors due to the waste gas temperature can be minimized as follows:

- Use of appropriate filters and probes for dust measurements (quartz or glass fiber filters without organic binders, high temperature gaskets, etc.).
- Appropriate conditioning of the filters before use at high temperature. A previous conditioning phase at temperature up to 400 - 600 °C is recommended in order to avoid further weight losses during the measurements.
- Use of heated probes and filters at low waste gas temperatures, particularly in the presence of high humidity, in order to avoid acid and water condensation.

Size distribution of dust

The particle diameter of dust generated by the melting process is normally very small (less than 1 µm, and generally 0.02 - 0.5µm). During sampling the particles easily agglomerate and, when alkaline filtering materials are used, tend to react with the acid gaseous substances present in the flue gas. In order to avoid the phenomena, chemically inert filters should be selected for sampling. When particulate matter is measured continuously, the fine particles can be difficult to remove from the optical parts of the measuring equipment, leading to erroneous results of dust concentration. A suitable cleaning system should be applied.

Waste gas velocity

Although dust emitted from the glass melting process is made up of extremely fine particles, the measurements should be carried out isokinetically. The geometry of the duct and the position of the sampling point should be selected in order to allow a correct measurement of the flue gas velocity.

Waste gas moisture

The presence of high percentages of water in the waste gases is very common in the case of oxy-fuel melting and air/gas furnaces when water is used as the coolant prior to abatement equipment. The determination of the gas dew point should be carried out in order to avoid condensation during sampling. Gaseous pollutants should be measured by using heated probes any time there is a risk of condensation, especially in SO₃-rich flue gases. This is also the case for some downstream processes employing wet scrubbers, such as for continuous glass filament, glass fibre, etc. Where water condensation does occur, the resulting liquid should be checked to determine the possible absorption of gaseous pollutants, e.g. oxides of sulphur.

Gaseous and particulate form of pollutants

Some pollutants can be released into the atmosphere in both particulate and gaseous form. This is the case for some substances from the melting process, e.g. certain boron compounds (particularly, boric acid), selenium, arsenic, mercury (if cullet from lighting is used), but also tin chloride from the hot-end coating activities for container glass. Boric acid is mainly released into the atmosphere in its gaseous form, due to its high vapour pressure and low condensation temperature (below 160 °C). Selenium used for colouring or decolouring the glass can result in a high gaseous emission, due to the formation of extremely volatile compounds, with condensation temperatures as low as 60 - 100 °C. In these cases, in order to avoid evaluating errors, the sampling train should be equipped with a combined system for the simultaneous collection of both particulate and gaseous components.

Sampling time

In case of regenerative furnaces, in addition to the standard procedures, which require an adequate sampling time for collecting a representative sample, a good practice should take into consideration the reversal cycle of the regenerators. In fact, emissions from the melting process can vary substantially with the temperature cycle of the chambers, which increases during the cycle. In order to carry out measurements with comparable results the sampling time should cover an even number of firing cycles. This can also be an issue with cleaning cycles on abatement equipment.

Reference conditions

Normally, the emission limit values are given in concentration, referred to 0 °C, 101.3 kPa and other specific conditions e.g.:

- Continuous melting furnaces: 8 % oxygen by volume, dry
- Discontinuous furnaces: 13 % oxygen by volume, dry
- Other sources of emissions: no correction for oxygen or water vapour

In general, the concentration of pollutants is used to define compliance with the emission limit values. This is because it is directly measured and does not require the acquisition of additional information concerning the production process, which is usually needed for the definition of the emission factors or specific emissions (e.g. kg emission per tonne of molten glass). However, emission limit values are sometimes given both in concentration (mg/m^3) and emission factor (kg/tonne glass, kg/h, g/h). This is particularly the case for highly diluted waste gases (e.g. electric furnaces) and, in general, in the presence of high percentages of oxygen (oxy-fuel combustion). The correction to 8 or 13 % oxygen would yield results that would not be comparable with furnaces using fossil fuels and air instead of oxygen for the melting process.

Continuous monitoring

The application of continuous monitoring is generally limited to the emissions generated by the melting furnace, it being the most relevant mass flow and having a relatively constant level of emissions. Continuous monitoring of emissions can be carried out by “in situ” or extractive measuring equipment. “In situ” measurements are performed across the stack/chimney, at flue gas temperature and the humidity of the sampling point. Extractive measurements are based on the conditioning of the flue gas sample and subsequent determination of the pollutant concentration on dry gas. Both systems require careful maintenance and periodic calibration by means of discontinuous measuring methods. In particular, measurements carried out by “in situ” instruments can be affected by colour and particulate size distribution, which vary according to the different glass produced in the furnace (green, brown, half-white) and the type of fuel used for combustion.

The parameters that could be measured continuously and the suggested methods are given in the table below.

Parameter	Method
Oxygen	Paramagnetic, zirconium oxide cell
Dust	Light opacity, light scattering
Nitrogen Oxide (NO)	Infrared or UV photometry, chemi-luminescence
Nitrogen Oxides (NO + NO ₂)	Infrared or UV photometry, chemi-luminescence equipped with converter (NO ₂ to NO)
Sulphur Dioxide	Infrared or UV photometry
Carbon Monoxide	Infrared photometry
Total Hydrocarbons	Flame Ionization Detector (FID)

Table 10.2: Continuous monitoring techniques

Other pollutants could be measured continuously, such as HF and HCl by potentiometry and IR photometry respectively or by the potentiometric method. However, these measurements are not easy to perform and require frequent re-calibration of the analyzers. Continuous monitoring of these pollutants could be appropriate for particular glass processes that imply the use of chlorine and fluorine compounds in the batch composition, and result in emissions after the abatement system.

In some Member States, national legislation requires continuous monitoring of emissions to be applied for mass flows higher than the following values:

Substance	Mass flow (kg/h)
Dust	2 - 25
Sulphur Dioxide	50 - 150
Nitrogen Oxides, as NO ₂	30 - 150
Carbon Monoxide, for evaluating the efficiency of combustion	5
Carbon Monoxide, all other cases	100
Fluorine compounds, as HF	0.5
Chlorine compounds, as HCl	3 - 20

Note: The ranges indicated in the table are examples of German and French legislative requirements, the lower values being the German requirements.

Table 10.3: Mass flows for continuous monitoring (France and Germany)

Discontinuous measurements

Individual measurements may be carried out by separating the different pollutants (generally dust, SO_x, HCl, HF, metals) on appropriate filtering materials or in adsorbing solutions, or with the use of continuous extractive measuring instruments (e.g. IR, UV photometry for NO_x, SO₂, etc.). The number of measurements required is generally established on the basis of the emission variability and the length of the operation to be controlled. In some cases, the operation is carried out in a limited amount of time that only allows a single measurement (e.g. raw materials handling). However, in most cases for a continuous process characterized by stable emissions, a minimum of three separate measurements is required, and for variable emissions five separate measurements. In special cases, up to 8 - 10 measurements can be necessary.

A general indication of the most common methods used is given in the table below.

Pollutant/Parameter	Method
Dust	Filtration and gravimetric determination
Nitrogen Oxides (NO + NO ₂)	IR or UV photometry, chemi-luminescence. Absorption in suitable solution and chemical determination (colorimetry, ion chromatography, etc.)
Sulphur Dioxide (SO ₂)	IR or UV photometry
Oxides of Sulphur (SO ₂ + SO ₃)	Absorption in suitable solution and chemical determination (titration, ion chromatography, ICP)
Sulphur Oxide (SO ₃)	Absorption in suitable solution and chemical determination (titration, ion chromatography)
Metals (As, Pb, Cd, Se, Cr, Cu, V, Mn, Ni, Co, Sb, etc.)	Filtration and/or absorption in suitable solution. Determination by AAS, ICP.
Chlorides as HCl	Filtration and absorption in suitable solution. Determination by ion chromatography, titration
Fluorides, as HF	Filtration and absorption in suitable solution. Determination by ion specific electrode, ion chromatography
Hydrogen Sulphide	Filtration and absorption in suitable solution. Ion chromatography, colorimetric determination or back titration
Formaldehyde	Absorption in suitable solution. Colorimetric or HPLC determination
Phenol	Absorption in suitable solution. Gas (liquid) Chromatography or colorimetric determination
Ammonia	Absorption in suitable solution. Ion chromatography, colorimetric or ion selective electrode determination
Amines	Absorption in suitable solution or silica gel. GC, HPLC or GC-MS determination
Volatile Organic Compounds	Flame Ionisation Detector (FID)
Oxygen	Paramagnetic, zirconium oxide cell
Carbon Monoxide	IR photometry
Carbon Dioxide	IR photometry

Note: The techniques listed are examples and do not cover all the analytical techniques that might be used for the determination of the different pollutants in the Glass Industry.

Table 10.4: Discontinuous monitoring techniques

In general, national and international standardized methods (ISO, CEN, VDI, EPA, etc.) are available for measuring most of the relevant emission parameters. However, for a number of substances there is no such standardized methodology. This is the case for most organic substances (phenol, formaldehyde, amines, etc.) but also for many inorganic compounds that can be released to the atmosphere in both particulate and gaseous form (e.g. boron compounds). As already indicated, good common practice suggests performing combined sampling (filtration and adsorption) in order to identify and quantify the different fractions.

Mass balance calculation

In some cases, and for certain pollutants, a mass balance calculation can provide a good evaluation of process emissions. When the input and output of a specific substance in a process step (e.g. the melting process), together with any chemical and/or physical changes are known with sufficient accuracy, the mass balance can be used as a quantitative method to evaluate emissions. For example this might be the case for SO₂ arising from melting, HF in opal glass production, or selenium in bronze or flint glass production. In general, the mass balance calculation is used to make a comparison with the measured emissions level.

Interpretation and reporting of measurement results

To give a reasonable standard of interpretation in reporting the results of emission measurements, it is important to specify the following information, as a minimum:

- the monitoring method applied;
- the precision of the method applied;
- the relevant operating conditions (process data);
- the reference conditions (humidity, temperature at measuring point, etc.); and
- the results of all separate measurements or, in the case of continuous monitoring, the frequency distribution of all half-hourly, hourly or daily average concentrations.

Conclusions

This annex does not attempt to give any standard methodology for the monitoring of emissions in the Glass Industry. Where appropriate established methods are normally available and should be evaluated for each application. The objective of this annex is to give general information and to point out the potential sources of erroneous evaluation of the emission levels that can be obtained by the application of different BAT.

11 ANNEX IV: NATIONAL LEGISLATION

The following is the legislation as it was submitted by Member States. No editing work was made on the information received.

11.1. Luxembourg legislation

Emission limit values for float glass furnaces based on permits:

Pollutant	Plant 2	Unit	Average period
Dust	50	mg/Nm ³	daily average
SO ₂	500	mg/Nm ³	hour average
NO _x	500*	mg/Nm ³	daily average
HCl	30	mg/Nm ³	hour average
HF	5	mg/Nm ³	hour average

* target value to be respected after rebuilt of furnace and optimisation of 3R.

Reference conditions:

0 °C, 1013 mbar, dry, 8 % O₂

Measuring interval:

- dust and NO_x: continuously
- all other substances: once per year

11.2. Relevant Dutch legislation and regulation

Framework legislation

The Netherlands has two main framework environmental acts, being the “Environmental Management Act” and the “Surface Water Pollution Act”. These acts together provide the framework for environmental permitting and allow for setting conditions to the permit. The acts comply with the requirements of the IPPC Directive and integrated permitting is guaranteed by a co-ordinated licensing procedure from the competent authorities.

Both framework acts govern a number of Decrees and Regulations that provide requirements with regard to potentially polluting activities.

Regulations

Netherlands emission regulations (NeR)

The Netherlands Emission Regulations (NeR) are concerned with process emissions to air and apply as guidelines for the issuing of licences or for the adjustment of licensing conditions. The NeR should be used for guidance in the granting of licences from 1 May 1992.

The NeR follows the same basic concept as the German TA-Luft, except that the classification of some substances has been adjusted in the light of recent toxicological findings. In addition, the emission standards for some classes of substance have been adjusted in line with current knowledge with regard to best available techniques.

In the NeR, concentration standards for different substances are given, which constitute upper limits for distinct point sources, depending on mass flow. The “special regulations” comprise measures to limit emissions from incidental discharges or diffuse sources. Furthermore, in the “special regulations” rules departing from the “general emission standards” for certain industries or specific installations are given.

Both the glass industry and the mineral wool industry are covered by a special regulation. The special regulation for the mineral wool industry was issued in May 1992. It requires the following:

“Oxides of sulphur

The emission of sulphur dioxide from melting furnaces must be reduced depending on the SO₂ concentration. For concentrations below 1500 [mg/Nm³], lime injection is a possibility.

For concentrations above 1000 [mg/Nm³], conversion to sulphuric acid should be considered as an alternative. The concentration of SO₂ in emitted waste gases may not exceed 400 [mg/m³] after treatment.

Particulates:

The emission of particulates must be controlled by the use of fabric filters or some other technique by which a comparable residual concentration can be achieved.

Organic substances:

The general standards of the NeR, including the cumulation rule, are applicable to the emission of organic substances”.

The special regulation for the glass industry was issued in December 1993. A full translation of the “Special regulation for the glass industry” is found in the Dutch Notes on BAT for the Glass and Mineral Wool Industry. This regulation is not applicable to flat glass, continuous filament fibre and glass wool. However, the regulation states that “in order to control emissions arising from these processes, the technologies mentioned in this regulation are, in principle, applicable with the exception of oxy-fuel in sheet glass manufacture”.

The essentials of the special regulation for the glass industry lie in the fact that there are two possible routes to be followed by the glass industry. One route implies the introduction of oxy-fuel technology before 2003 and introduction of dedusting and absorbent injection before 2010. The other route implies introduction of dedusting and absorbent injection before 2003 and NO_x-abatement before 2010. Here an essential citation of the regulation is given:

Package of measures 1) utilisation of an electrostatic filter \ absorbent injection in conjunction with burner measures in accordance with existing technology, followed by measures aimed at controlling NO_x emissions

As soon as possible, and in any case before the year 2003 at the latest, utilisation of an electrostatic filter with absorbent injection in conjunction with improved burner technology. During the subsequent furnace overhaul, and in any case before the year 2010, implementation of measures to limit NO_x emissions. The choice of which measures are to be implemented to limit NO_x emissions will depend on technological developments.

Non-normative indication of the trend in emission factors resulting from package of measure 1:

component	present level		until 2003	until 2010
NO _x (kg/tonne molten glass)	5.0	(- 20 %)	4.0	p.m.
SO ₂ (kg/tonne molten glass)	2.5	(- 60 %)	1.0	1.0

p.m.: The reduction in emissions that can be achieved using measures against NO_x during the period 2003-2010 depends very much on technological developments and will be specified later.

Package of measures 2) utilisation of oxy-fuel technology, followed by measures aimed at SO₂, dust, fluorine and chlorides

As soon as possible, and in any case before the year 2003 at the latest, switch-over to the oxy-fuel process. After 2003, or as soon as possible, and in any case before the year 2010, state-of-the-art control technology, for example an electrostatic filter with absorbent injection, or an equivalent emission-limiting technology, must be implemented.

Non-normative indication of the trend in emission factors resulting from package of measures 2:

component	present level	until 2003		until 2010
NO _x (kg/tonne molten glass)	5	1		1
SO ₂ (kg/tonne molten glass)	2.5	2.5	(- 60 %)	1
dust (kg/tonne molten glass)	0.4	0.3		0.1

The consequence of first implementing the oxy-fuel process as a means of limiting emissions is that the deadline by which the other emissions (particularly lead, HF and HCl) have to fulfil the general requirements and conditions of the Dutch Emission Guidelines must be in line with the implementation schedule of the measures to be introduced in a second phase.

The implementation of the aforementioned measures will - in view of the developments in technology being made - have to be evaluated by the competent authority in more and more detail when the time comes to overhaul the furnaces and/or review the permits. Moreover, situations may arise in individual glass furnaces that enable accelerated and/or combined implementation of measures in the shorter term. Generally speaking, if the results of practical research show that, for example, essential cost factors of the technologies studied deviate from present knowledge (in a positive sense), this will give rise to a re-assessment of the feasibility of combined measures before the year 2003.

The emissions standards in the NeR are not legally binding and the NeR does not replace existing binding agreements. However, if the licensing authority wishes to depart from the NeR, the reasons for doing so must be stated explicitly in the preamble to the licence.

Voluntary agreements

Voluntary agreements or covenants (in Dutch: "Convenanten") are declarations of intent on the implementation of environmental policy for certain industrial sectors. The declarations of intent are agreements between the authorities and the industry. The participation in a covenant gives the advantage for both competent authorities and companies of a more transparent, coherent and predictable path of environmental improvement and investments. The covenants are nowadays applied in three fields:

- General environmental performance on 'traditional' pollutants.
- Energy efficiency
- CO₂ reduction

General environmental performance on 'traditional' pollutants

In the declaration of intent of this voluntary agreement, the authorities have drawn up an Integral Environmental Target Plan (IETP), based on the National Environmental Policy Plan (NEPP), the Memorandum on Water Management, the North Sea Action Plan, The Rhine Action Programme, the Memorandum on Energy Conservation and other official plans at the time of signature.

The Integral Environmental Target Plan is concerned with environmental pollution of the 'traditional' pollutants (SO_x, NO_x, VOC, heavy metals, PAH, etcetera) caused by the relevant industrial sector. The IETP has been drawn up for the years 1994/1995, 2000 and 2010.

Apart from the reduction in emissions into the air, water and soil, the IETP also incorporates policy with regard to energy conservation, water conservation, soil clean up, hazard risk, odour nuisance, noise and internal management systems. However, especially for energy conservation and CO₂ reduction, two other covenants have been agreed upon.

For the "chemical industry", a declaration of intent was signed on 2nd April 1993. A significant factor is the understanding that in view of the wide range of disparate companies in the chemical industry, the contribution of each individual company to the implementation of the IETP in the industry may vary. The responsibility of individual companies to contribute to the implementation of the IETP in the industry requires that these companies take an active stance. The contribution of a company will be defined in Company Environmental Plans ("BMP's"), which are drawn up by each company. These BMP's are renewed every four years and must be agreed upon by the licensing authority.

Energy efficiency: Long-Term Agreements on Energy Efficiency

In the Netherlands, "Long-Term Agreements on Energy Efficiency (MJA's)" have been made between the Ministry of Economic Affairs and representative organisations of many industrial sectors. The most important aspect of the MJA's is the target value for improvement of energy efficiency in the relevant industrial sector within a certain time frame. For the elaboration of the MJA's, bilateral agreements are made between the individual companies and the facilitating agency, which is NOVEM. In the Netherlands, "Long-Term Agreements on Energy Efficiency" (in Dutch: MJA's) have been made between the Ministry of Economic Affairs and representative organisations of many industrial sectors.

The most important aspect of the MJA's is the target value for improvement of energy efficiency in the relevant industrial sector within a certain time frame.

For the collaboration of the MJA's, bilateral agreements are made between the individual companies and the facilitating agency, which is the Dutch Agency for Energy and Environment (in Dutch: NOVEM).

For the glass industry, an MJA was signed on 17 July 1992 and the agreed improvement of energy efficiency was 20 % over the period 1989 - 2000 [78]. The improvement of the energy efficiency was founded by the technological long-range plan 1990 - 2010 of the Dutch glass producing industry [7]. In this plan the following energy saving measures were proposed to be carried out in the period 1990 - 2000:

- batch and cullet preheating;
- raising the cullet percentage in the raw materials;
- new furnace designs with a lower energy consumption;
- burners with a better heat exchange;
- increase of product quality (less production loss);
- light-weight products
- oxy-fuel combustion systems.

It is expected that the agreed 20 % improvement of energy efficiency will lead to extra investments of approximately 45 million EUR₁₉₉₈ in the period 1989 - 2000 [7]. Currently, negotiations are being made for the second generation of long-term agreements on energy efficiency. Both the targets and the scope are not yet fixed and there might also be some glass companies that join the 'benchmarking covenant' (see next item) instead of the long-term agreement.

CO₂ reduction: Benchmarking covenant

In the light of the Kyoto agreements, the Netherlands has to reduce the emission of CO₂. Improvement of the energy efficiency is one of the most important measures to reduce the CO₂ emissions. The Benchmarking covenant is an agreement between the Dutch authorities and the Dutch energy intensive industry. The industry agrees to belong to the world top in energy

efficiency and the authorities will then refrain from impairing additional CO₂ reduction measures. The agreement is open to all companies with an energy use of 0.5 PJ per year or more.

The principle agreement was signed on 6 July 1999 between the industrial organisations and the authorities. Now that the principle agreement has been signed, the agreement is open to individual companies to sign in on the covenant.

For those companies that do not want to join or that have an energy use of < 0.5 PJ per year, the 'traditional' long-term agreements on energy-efficiency route (see above) will be followed [43,44]

11.3. Current legislation – Austria

Emissions to air are regulated by an ordinance (Federal Legal Gazette No. 498/1994) which contains emission limit values for the different processes, fuels and raw materials. Furthermore it states how often monitoring reports have to be provided to the local authorities.

Dust in total: 50mg/Nm³

Therefrom solid and gaseous substances:

Cd: 0.1 mg/Nm³

As: 0.1 mg/Nm³, exception for lead glass: As: 0.5 mg/Nm³

Co, Ni, Se each 1.0 mg/Nm³ but As, Cd, Co, Ni, Se in total 1mg/Nm³

Sb, Pb, Cr, Cu, Mn each 5,0 mg/Nm³, but total metals : 5mg/Nm³

SO₂ : 500 mg/Nm³

HCl: 30 mg/Nm³

HF: 5 mg/Nm³

NO_x when mass emission 2.5 kg/h or more:

1500mg/Nm³ for end fired and cross fired glass tanks with regenerative preheating
or ceramic recuperative preheating

900mg/Nm³ for cross fired glass tanks with other recuperative preheating

800mg/Nm³ for day tanks and

500mg/Nm³ for other melting technologies

- Monitoring of emissions has to comply with VDI Guidelines;
- waste gas volume is restricted to unavoidable waste gas stream;
- Compliance Monitoring for gaseous emissions: Average of three half hour mean values – one measured at operating conditions referring to a maximum of emissions, all measured at regular operating conditions
- Already permitted installations must ensure compliance five years after announcement (coming in force) of the ordinance

Emissions to water: emission limit values as well as monitoring methods are set by a comprehensive ordinance (Federal Legal Gazette No. 888/1995) dealing with the different types of glass products and related processes.

Usually cooling water and process water are kept in separate circuits. Cooling water systems are operated in closed circuits, with a low demand of make-up water. Process water can be recirculated several times and is treated on site (oil separator, sedimentation) before being discharged to the river (running water) or to a municipal waste water treatment plant. There are different emission limits for both cases.

Waste Glass (Post Consumer Cullet)

In Austria the recycling rate of waste glass is about 77-79 %. This means that 200000t of waste glass are recycled in the container glass production.

- The sorting of the post consumer cullet in Austria is done on site.

Preheating of the cullet

In the Austrian plants the cullet is not preheated.

But there are plants in Germany and Switzerland, where cullet or cullet and batch (mixed raw materials) are preheated.

Are there problems with waste in the post consumer cullet?

- Organic wastes in the cullet lead to increasing demand of oxygen in the melting process and to emissions of organic substances to air.
- The separation of ceramics and stones in the waste glass is done automatically by optical methods. The amount of ceramics/stones broken with the cullet and brought into the melting tank depends on the efficiency of these optical inspection devices. This leads to an increasing number of rejected articles. Quality is determined by the number of inclusions per tonne glass.

Are there problems with heavy metals in the waste glass?

With a few exceptions, the limit of 250ppm lead in container glass as laid down in Directive 94/62/EC (concerning packing materials) can be met. The limit of 100 ppm lead in the glass, which will be valid from June 30th 2001 can not be guaranteed with the high recycling quotes of more than 50% as currently achieved in Austrian container glass production.

Emissions and Monitoring

Emissions to air are regulated by an ordinance (Federal Legal Gazette No. 498/1994) which contains emission limit values for the different processes, fuels and raw materials. Furthermore it states how often monitoring reports have to be provided to the local authorities.

Continuous monitoring of the following emissions to air is carried out in some of the glass production plants in Austria: dust, NO_x, SO₂,
Oxygen is also continuously monitored for process regulation.

In addition, Discontinuous monitoring of following parameters is done:
HCl, HF, heavy metals

Emissions to water: emission limit values as well as monitoring methods are set by a comprehensive ordinance (Federal Legal Gazette No. 888/1995) dealing with the different types of glass products and related processes.

Usually cooling water and process water are kept in separate circuits. Cooling water systems are operated in closed circuits, with a low demand of make-up water. Process water can be recirculated several times and is treated on site (oil separator, sedimentation) before being discharged to the river (running water) or to a municipal waste water treatment plant. There are different emission limits for both cases.

Wastes: filter dust, regenerator dust, oil separator waste, waste from refractories

Electric furnaces

In Austria there are currently three tanks with an electric furnace.

Capacity of the tanks:
2 tanks with about 20 - 30 tonnes per day
1 tank with about 75 tonnes per day

Products: lead glass (domestic glass, table ware)
glass wool
special glass for automobil industry

Providers of electric furnaces for glass melting tanks (companies' names):
Sorg, Grob, Horn

Reasons for the use of electric furnaces given by the operators:

- tank geometry,
- feeding of the glass-batch (cold top / cold crown),
- ratio: electricity consumption/price,
- specific energy consumption,
- air emissions (NO_x emissions)

NO_x Emission Values

Emission Limit Value for regenerative or ceramic recuperative horseshoe fired and cross fired glass tanks in Austria: 1500mg/Nm³, (8% O₂) as laid down in the Federal Legal Gazette No. 498/1994:

emission value for regenerative horseshoe fired, glass tanks applying only primary reduction measures: 900 – 1100 mg NO_x/Nm³ (discontinuous monitoring);

emission value for regenerative horseshoe fired glass tanks applying only primary reductions measures: 1100 – 1300 mg NO_x/Nm³ (continuous monitoring);
a pilot test for further reduction of NO_x emissions by applying “staged combustion” is planned by the operator

NO_x emissions from electric furnaces: 15 mg/Nm³ #)

NO_x emissions from electric furnaces using sodium nitrate as a refining agent:
(lead glass): 240 mg/Nm³ #)

average of several (minimum 3) half hourly mean values, discontinuous monitoring.

11.4. Legislation and regulation in Finland

There is no specified regulation concerning glass manufacturing in Finland.

The environmental permits are based on case-by-case consideration. A starting point for determining permit conditions are the local circumstances such as geographical location and the local environmental conditions.

The environmental legislation is composed of a number of individual acts. A new Environmental Protection Act is currently under preparation and will combine the environmental acts according to the requirements of the Council Directive 96/61/EC of September 1996 concerning integrated pollution prevention and control. The new act will be valid since 1.3.2000.

Presently, the integrated approach is included in the two separate permit procedures: the environmental permit procedure according to the Environmental Permit Procedure Act (735/1991) and Decree (772/1992) and the water discharge permit procedure according to the Water Act (264/1961) and Decree (282/1962).

Already at the moment The Environmental Permit Procedures Act combines the permit procedures of the Air Pollution Control Act and Decree, the Waste Act and Decree, the Health Protection Act and Decree and the Adjoining Properties Act. An application for permit including the documents and emissions are public and the persons and organisations affected by the project have a right to comment on them.

HELCOM Recommendation 14/3, 1993 (The Baltic Sea Area Commission, Helsinki Convention) is used when writing the environmental permits. Some environmental permits to glass manufacturer are made before HELCOM Recommendation came in force. Mostly the permits for the glass industry are rather old and they will be reconsidered along with the new Environmental protection act. Emission limits used in permits are:

Glass furnaces

Dust	50 mg/Nm ³
NOx	2.5-4 kg/tonne

Downstream Processing in Mineral Wool

Phenol	0.7 kg/tonne
Fomaldehyde	015 kg/tonne
Ammonia	1.5 kg/tonne

In all environmental permits the obligatory monitoring is included. Generally the regular measurement concerning all the emissions are obliged to do every one or three years. In addition the installations are obliged:

- to minimize the hazards to human health and to the environment from toxic, persistent and bioaccumulative substances.
- to substitute hazardous substances as far as possible
- to minimize the amount of waste and recycle the waste as much as possible
- to recirculate the process waters if possible
- to keep registers of the emissions and waste
- to report about the emissions and waste to the competent authority every year.

11.5. French legislative and regulatory framework

The French legislative framework is based on the 9 July 1976 act, called the act on registered installations for environment protection, and its two application decrees.

The decree of 21 September 1977 specifies the procedure which has to be followed to obtain an operation permit.

The second decree indicates the type of installations or plants needing a permit.

It depends on the sector and the activity level.

This text defines also if a site-specific permit (authorisation procedure) or a general procedure (declaration procedure) is required.

Some activities do not need any authorisation because of a negligible environmental impact.

The site-specific permit is delivered by the local authorities (the prefect of the department where the plant is located) after a public inquiry.

The permit which defines operating conditions, emission limit values and monitoring requirements takes into account:

- national regulations issued for a specific activity or a group of sectors,
- the local environmental impact of the plant.

The site-specific permit, elaborated by an integrated approach, can only be more stringent than the national regulations.

For the glass industry, a national regulation issued in 1993. The ordinance of the 14 may 1993 applies to the plants having a production capacity of more than 5 t/day for sodalime glass and 0.5 t/day for special glasses. These plants need also a specific permit.

The ordinance of the 14 may 1993 is joined in annex 1 and the main requirements for air pollution control are given below.

One of the two emission limit values expressed in concentration (mg/Nm³ of dry gases with an oxygen content of 8 %) or in mass per tonne of glass produced (kg/tv) has to be respected.

Dust (for glass production capacity higher than 50 tonnes per day)

- 0.2 kg/tv or 50 mg/Nm³
- 0.35 kg/tv or 50 mg/ Nm³ for special glasses

SO_x (in SO₂)

Non-oxidized glasses:

- 1 kg/tv or 500 mg/ Nm³ for gas firing
- 3 kg/tv or 1500 mg/ Nm³ for liquid fuel firing

Oxidized glass

- 1.5 kg/tv or 750 mg/ Nm³ for gas firing
- 3.6 kg/tv or 1800 mg/ Nm³ for liquid fuel firing
- 0.5 kg/tv or 250 mg/ Nm³ for electric furnaces

NO_x (in NO₂):

- Regenerative furnaces:

End fired furnaces

- 3 kg/tv or 1500 mg/ Nm³ for gas firing
- 2.6 kg/tv or 1300 mg/ Nm³ for liquid fuel firing

Cross fired furnaces

- 4 kg/tv or 2000 mg/ Nm³ for gas firing
- 3 kg/tv or 1500 mg/ Nm³ for liquid fuel firing

- Recuperative furnaces:

- 2.7 kg/tv or 900 mg/ Nm³ for gas firing
- 2.1 kg/tv or 700 mg/ Nm³ for liquid fuel firing

- Electric furnaces:

- 1 kg/tv or 500 mg/ Nm³

For special glasses and glasses oxidized by nitrate compounds NO_x emission limit values are doubled.

The application of these emission limit values are scheduled as indicated below.

New installations		Date of installation
Capacity extension over 25%		Date of extension
Increase of emissions over 10%		Date of emission increase
Old installations	SOx	9 July 1998
	NOx	9 July 2001
	Dust	9 July 2003

The 14 May 1993 ordinance also stipulates requirements concerning heavy metals, HCl HF ... and water pollution, noise...

This text has an integrated approach to prevent and control glass industry pollution. This ordinance was modified in 1996.

If a furnace can respect the following NOx emission limit values:

- Recuperative furnaces: 1 kg/tv or 500 mg/Nm³,
- Regenerative furnaces:
 - End-fired furnaces: 1.5 kg/tv or 700 mg/ Nm³
 - Cross-fired furnaces: 2 kg/tv or 1100 mg/ Nm³

the dust emission limit values permitted are 0.35 kg/tv or 150 mg/ Nm³ until 2004.

A tax on atmospheric pollution completes this legislative and regulatory framework.

The first air pollution tax was created in 1985, for a 5 year period. At first, it only concerned sulphur oxides. Then it was renewed twice, once in 1990 and then again in 1995.

Only the installations submitted to an authorization procedure are -concerned by the tax.

The sources presently taxed are:

- combustion installations of more than 20 MW,
- municipal solid waste incinerators of more than 3 t/h,
- other types of registered installations emitting more than 150 t/year of SO₂ (or H₂S expressed as SO₂), NOx, counted in equivalent NO₂ equivalent, HCl or non methanic VOCs.

The present tax rate is 180 FF/tonne of SO₂, H₂S (expressed as SO₂), HCl, NOx (as NO₂), N₂O and VOCs. Since January 1st 1998, the rates for NOx and VOCs have been raised to 250 FF/tonne.

The tax revenue is about 250 MFF/year

The tax on atmospheric pollution is a redistribution tax.

- 60%, at least of the collected funds are used to subsidize the installation of prevention or treatment equipment.

Only those industries concerned by the above criteria are eligible for these subsidies. They are required either to reach emissions far below national or EU ELV'S or to carry out modifications significantly before the date of enforcement of national or EU ELV'S. The rate of the subsidy depends on the efficiency and the innovation of the techniques.

The amount of collected funds, which are not redistributed for the prevention of atmospheric pollution (a maximum of 40 % of the collected money) can be used in order to:

- support applied research and development initiatives in the field of measurement or abatement techniques (prevention or treatment),
- finance the air quality monitoring networks (equipment and operating costs),
- carry out technical or economic studies related to emission. inventories, development strategies, ...

The tax rate is not high enough to be incitative (it is generally less costly to pay for the tax than to install an efficient abatement technique). However, due to the rather high rate of subsidies allowed (particularly in the past) this redistribution tax system has proved to be an efficient and flexible tool, as a complement to the regulations encouraging the installation of the best available technologies.

11.6. Italian legislation

The legislation in force is based on Environment Ministry Decree of July 12, 1990, concerning existing plants.

General emission limit values, applied to most industrial sectors:

For carcinogenic substances:

Substances of Class 1: normally not present in the glass industry.
If mass flow ≥ 0.5 g/h the emission limit is 0.1 mg/m^3 .

Substances of Class 2: Arsenic, Chromium (VI), Cobalt, Nickel, etc.
If mass flow ≥ 5 g/h the emission limit is 1 mg/m^3 .

Substances of Class 3: normally not present in the glass industry.
If mass flow ≥ 25 g/h the emission limit is 5 mg/m^3 .

For inorganic substances in particulate form:

Substances of Class 1: Cadmium, mercury, etc.
If mass flow ≥ 1 g/h the emission limit is 0.2 mg/m^3 .

Substances of Class 2: Selenium, etc.
If mass flow ≥ 5 g/h the emission limit is 1 mg/m^3 .

Substances of Class 3: Antimony, Chromium (III), Lead Quartz, Copper, Tin, Vanadium.
If mass flow ≥ 25 g/h the emission limit is 5 mg/m^3 .

For inorganic substances in the gaseous form

Substances of Class 1: normally not present in the glass industry
If mass flow ≥ 10 g/h the emission limit is 1 mg/m^3 .

Substances of Class 2: Fluorides as HF, etc.
If mass flow ≥ 50 g/h the emission limit is 5 mg/m^3 .

Substances of Class 3: Chlorides as HCl, etc.
If mass flow ≥ 0.3 Kg/h the emission limit is 30 mg/m^3 .

Substances of Class 4: Ammonia.
If mass flow ≥ 2 Kg/h the emission limit is 250 mg/m^3 .

Substances of Class 5: Nitrogen oxides as NO₂; Sulphur oxides as SO₂
 If mass flow ≥ 5 Kg/h the emission limit is 500 mg/m³.

For organic substances in gaseous and particulate form

Substances of Class 1: methylacrilate, Isocyanate, etc.
 If mass flow ≥ 25 g/h the emission limit is 5 mg/m³.

Substances of Class 2: Phenols, Formaldehyde, etc
 If mass flow ≥ 0.1 Kg/h the emission limit is 20 mg/m³.

Substances of Class 3: Iso butyl alcohol, etc.
 If mass flow ≥ 2 Kg/h the emission limit is 150 mg/m³.

Substances ≥ 3 Kg/h the emission limit is 300 mg/m³.

Substances of Class 5: Acetone, etc.
 If mass flow ≥ 4 Kg/h the emission limit is 600 mg/m³.

Dust

If mass flow ≥ 0.5 Kg/h the emission limit is 50 mg/m³.
 If mass flow ≥ 0.1 Kg/h and < 0.5 Kg/h, the emission limit is 150 mg/m³.

Specific emission limit values, applied to furnaces for the production of glass

Nitrogen Oxides as NO₂

	Fuel oil mg/m ³	Natural gas mg/m ³
Pot furnaces	1200	1200
Continuous tanks with recuperative heat recovery	1200	1400
Day tanks	1600	1600
Regenerative furnaces, end fired (U-flame)	1800	2200
Regenerative furnaces, cross fired	3000	3500

The use of nitrates in the batch, due to quality reasons, allows to double the limit value.

Sulphur Oxides as SO₂

Day tanks and pot furnaces 1100 mg/m³

Continuos glass tanks 1800 mg/m³

Total dust

If pull ≥ 250 t/day, the emission limit is 80 - 100 mg/m³

If pull < 250 t/day and mass flow ≥ 0.1 Kg/h, the emission limit is 150 mg/m³

For glass fiber, continuous filament, borosilicate tube the emission limit is 350 mg/m³.

The values are referred to dry gas volumes, at 8 % oxygen for continuous glass tanks at 13 % oxygen for discontinuous furnaces

Note: The emission limit values are applied for existing plants.

Normally, a furnace running at emission levels lower than the official limits, is required to maintain those values. For specific areas and/or reasons, lower values may be applied.

For new plants, regional authorities can decide to use the same limits (quite rare) or, normally, stricter limits are applied, based on the “best available technologies”.

11.7. STANDARD EMISSION LIMITS FOR GLASS INDUSTRY IN WALLOON REGION OF BELGIUM (VOLUNTARY AGREEMENT)

		Container and Flat Glass Capacity ≥ 5 t/day				Glass Fibre and Special Glass					
		Capacity ≥ 5 t/day		Capacity ≥ 50 t/day		Capacity ≥ 50 t/day		0.5 t/day < Capacity < 50 t/day			
DUST		5 \leq --- \leq 50 t/day		> 50 t/day		50		5 < ----> 10 t/day < ----> 50			
		mg/Nm ³		50		50					
		kg/t. melt		0.2		0.35		14 < ----> 1.1 < ----> 0.35			
SO _x											
Sulphates = 0		Fuel	Gas			Fuel	Gas	Fuel	Gas		
		g/Nm ³				1.5 0.5		1.5 0.5			
		kg/t. melt				3 1		3 1			
Sulphates > 0		Fuel	Gas		Elect	Fuel	Gas	Elect.	Fuel	Gas	Elect.
		g/Nm ³			0.25	1.8 0.75		0.25	1.8 0.75		0.25
		kg/t. melt			0.5	3.6 1.5		0.5	3.6 1.5		0.5
NO _x		CF	EF	R	E			R			
Nitrates = 0		Fuel/Gas	Fuel/Gas	Fuel/Gas				Fuel/Gas			
(*)		g/Nm ³		1.5/2.0 1.3/1.5 0.7/0.9		0.5		0.7/0.9		0.7/0.9	
(*)		kg/t. melt		3.0/4.0 2.6/3.0 2.1/2.7		1		2.1/2.7		2.1/2.7	
Nitrates > 0		Fuel/Gas	Fuel/Gas	Fuel/Gas				Fuel/Gas			
(**)		g/Nm ³		3.0/4.0 2.6/3.0 1.4/1.8		1.0		1.4/1.8		1.4/1.8	
(**)		kg/t. melt		6.0/8.0 5.2/6.0 4.2/5.4		2		4.2/5.4		4.2/5.4	
HCl (***)		mg/Nm ³		50/100		50/100		50/100		50/100	
		kg/t. melt		0.175/0.350		0.175/0.350		0.175/0.350		0.175/0.350	
HF (***)		mg/Nm ³		5.0/2.0		5.0/2.0		5.0/2.0		5.0/2.0	
		kg/t. melt		0.035/0.14		0.035/0.14		0.035/0.14		0.035/0.14	
		mg/Nm ³		50		50		50		50	
NH ₃ (****)		mg/Nm ³		kg/t. melt		mg/Nm ³		kg/t. melt		mg/Nm ³	
HEAVY METALS (*****)						0.2		0.0014		0.2 0.0014	
Cd						1		0.007		1 0.007	
As _{soil} , Co, Ni, Se, Cr ⁶⁺						3		0.021		3 3 0.021	
Sb						5		0.035		5 0.035	
As _{gas} , Cr _{tot} , Pb, V											
(Cr ⁶⁺ +Pb+Cd+Sb+Ni+Co+Se+V)		≤ 5		≤ 0.035		≤ 5		≤ 0.035		$\leq 5 \leq 0.035$	
(Cr _{tot} +Pb+Cd+Sb+Ni+Co+Se+V)											

< --->: Lin. interpolation; CF=Cross-Fired furnaces; EF=End-Fired furnaces (Regenerative); R=Unit Melter, pot furnaces (Recuperative); E=Electrical Melters.

Emission limit values: at 20.8 % O₂ (electrical melters), 13 % O₂ (pot furnaces) or 8 % O₂ (others), to be complied with either (mg or g)/Nm³ or kg/t.melt.

(*) Not for Glass Fibre.

(**) For Glass Fibre only, use yyy in xxx/yyy

(***) Raw materials without Cl or F / with Cl or F.

(****) For denitrification.

(*****) Container and Flat Glass > 50 t/day using fuel, with recycling > 80 wt% raw materials, (Sum elements) ≤ 10 mg/Nm³ or 0.07 kg/t.melt.

GLOSSARY

Abbreviations			
ac.pol.	acid polishing/polished	IPPC	Integrated Pollution Prevention and Control
BAT	Best Available Techniques	IS	Individual Section
BOD	Biological Oxygen Demand	NL	Netherlands
COD	Chemical Oxygen Demand	RCF	Refractory Ceramic Fibre
CPIV	Comité Permanent des Industries du Verre	SCR	Selective Catalytic Reduction
CRF	Chemical Reduction by Fuel	SNCR	Selective Non Catalytic Reduction
CRT	Cathode Ray Tube	tpd	tonnes per day
CVD	Chemical Vapour Deposition	TV	Television
EC	European Commission	UK	United Kingdom
EP	Electrostatic Precipitator	USA	United States of America
EU	European Union	VOC	Volatile Organic Compound(s)
EURIMA	European Insulation Manufacturers Association	WEP	Wet Electrostatic Precipitator

Elements			
Ag	Silver	Li	Lithium
Al	Aluminium	Mg	Magnesium
Ar	Argon	Mn	Manganese
As	Arsenic	Mo	Molybdenum
B	Boron	N	Nitrogen
Ba	Barium	Na	Sodium
Be	Beryllium	Ni	Nickel
Bi	Bismuth	O	Oxygen
C	Carbon	P	Phosphorus
Ca	Calcium	Pb	Lead
Cd	Cadmium	Pd	Palladium
Ce	Cerium	Pt	Platinum
Cl	Chlorine	S	Sulphur
Co	Cobalt	Sb	Antimony
Cr	Chromium	Se	Selenium
Cs	Cesium	Si	Silicon
Cu	Copper	Sn	Tin
F	Fluorine	Sr	Strontium
Fe	Iron	Ti	Titanium
H	Hydrogen	V	Vanadium
Hg	Mercury	W	Tungsten (Wolfram)
K	Potassium	Zn	Zinc
		Zr	Zirconium

Chemical formula commonly used in the document			
Al ₂ O ₃	Aluminium oxide, alumina	MgCO ₃	Magnesium carbonate
B ₂ O ₃	Boron trioxide,	MgO	Magnesium oxide, magnesia
CaCO ₃	Calcium carbonate, limestone	N ₂	Molecular nitrogen
CaF ₂	Calcium fluoride, fluorspar	Na ₂ CO ₃	Sodium carbonate, soda ash
CaO	Calcium oxide, lime	Na ₂ O	Sodium monoxide
Ca(OH) ₂	Calcium hydroxide, slaked lime	Na ₂ SO ₄	Sodium sulphate,
CaSO ₄	Calcium sulphate	N ₂ O	Nitrous oxide
CO	Carbon monoxide	NO	Nitric oxide
CO ₂	Carbon dioxide	NO ₂	Nitrogen dioxide
Fe ₂ O ₃	Iron oxide, ferric oxide	NO _x	Oxides of nitrogen (NO and NO ₂ only)
HCl	Hydrogen chloride	PbO	Lead oxide, yellow lead, litharge
HF	Hydrogen fluoride	Pb ₃ O ₄	Lead oxide, red lead, minium, lead tetroxide
H ₂ S	Hydrogen sulphide	SiO ₂	Silicon dioxide
H ₂ SiF ₆	Hexafluorosilicic acid	SO ₂	Sulphur dioxide
H ₂ SO ₄	Sulphuric acid	SO ₃	Sulphur trioxide
K ₂ CO ₃	Potassium carbonate, potash	SO _x	Oxides of sulphur (SO ₂ and SO ₃)
K ₂ O	Potassium oxide		

Units			
euro	Currency unit of EU (participating Member States)	kWh	kilowatt hour
kPa	kiloPascal	J	Joule
°C	Degree centigrade/Celsius	GJ	Gigajoule
g	gram	s	second
kg	kilogram	h	hour
t	metric tonne (1000kg)	d	day
mm	millimetre	y	year
cm	centimetre	t/d	tonnes per day
m	metre	t/y	tonnes per year
m ²	square metre		
m ³	cubic metre		
Nm ³	m ³ at 273K, 101.3kPa, dry		

Prefixes			
η	nano 10 ⁻⁹	M	mega 10 ⁶
μ	micro 10 ⁻⁶	G	giga 10 ⁹
m	milli 10 ⁻³	T	tera 10 ¹²
c	centi 10 ⁻²	P	peta 10 ¹⁵
k	kilo 10 ³		

REFERENCES

[96/61/EC]

Directive 96/61/EC concerning integrated pollution prevention and control (10/10/96)

[tm1, UKDoE]

Pollution Control at Large Glass Works, UK Department of the Environment, Environmental Resources Limited, March 1991, gls/tm/1.

[tm2 3R]

3R Process, NO_x Control Technology from Pilkington, Pilkington company publication, September 1994, gls/tm/2.

[tm3 NO_xEPA]

Alternative Control Techniques Document – NO_x Emissions from Glass Manufacturing, United States Environmental Protection Agency, June 1994, gls/tm/3.

[tm4 VDI88]

Verein Deutscher Ingenieure Guidelines (VDI 2578) Emission Control Glassworks, 1988.

[tm5 EEO]

Energy Efficient Environmental Control in the Glass Industry, Good Practice Guide 127, UK Energy Efficiency Office, 1995, gls/tm/5.

[tm6 NO_x Ind.duVerre]

Reduction des Emissions d'Oxydes d'Azote dans L'Industrie du Verre, Comité de Suivi du Verre, Arrêté du 14 mai 1993, July 1996, gls/tm/6.

[tm7 HMIP]

Technical and Economic Review of Technique to Control Emissions from Non-asbestos mineral fibres and Frit Manufacturing Processes, Environment Agency (England and Wales), August 1996, gls/tm/7.

[tm8, S2 3.03]

IPC Guidance Note S2 3.03, Manufacture of glass fibres, other non-asbestos mineral fibres, glass frit, enamel frit and associated processes, Environment Agency, HMSO, September 1996, ISBN 0-11-310121-X, gls/tm/8.

[tm9 BATNEEC4.3]

BATNEEC Guidance Note – Glass Production (Draft), Irish Environmental Protection Agency, 1996, gls/tm/9.

[tm10 BATNEEC4.2]

BATNEEC Guidance Note – Manufacture of Glass Fibre or Mineral Fibre (Draft), Irish Environmental Protection Agency, 1996, gls/tm/10.

[tm11 SO_x]

Prévention et traitement des émissions d'oxydes de soufre, Actes du Colloque, Colloque National, 4 et 5 Dé1997, Le Havre, gls/tm/11.

[tm12 desulf]

Les techniques de desulfuration des procedes industriels (Draft Version) 1998, gls/tm/12.

References

[tm13 Ademe NOx]

Comment réduire les émissions d'oxydes d'azote d'origine industrielle?, Recueil des conférences des journées techniques organisées à Angers les 25 et 26 septembre 1996, Ademe, gls/tm/13.

[tm14 ETSU]

Energy Technology in the Glass Industry Sector (Thermie), ETSU, AEA Environment and Energy, March 1992.

[tm15 Italy]

Reference Document for the Application of IPPC 96/61/EC to the Italian Glass Industry, Edited B Scalet, Stazione Sperimentale del Vetro, January 1998.

[tm16 USEPA]

EPA Office of Compliance Sector Notebook Project, Profile of the Stone, Clay, Glass, and Concrete Products Industry, US Environmental Protection Agency, September 1995, gls/tm/16.

[tm17 Ercole]

Oxycombustion: The Problems and Perspectives for Development of its Use in Glass Containers Production, P Ercole, Paper presented at US Ceramic Society congress on glass, San Francisco, July 1998, gls/tm/17.

[tm18 CPIV]

CPIV BAT Reference Document for the European Glass Industry, January 1998
Comité Permanent des Industries du Verre, gls/tm/18 Including supplements

[tm19 5yrsLoNOx]

Five years of operational experience with the SORG LoNOx Melter, Ehrig, Wiegand and Neubauer, Glastech. Ber. Glass Sci. Technol. 68 (1995) No2, gls/tm/19.

[tm20 SORG]

Optimierung einer großen Glasschmelzwanne durch Primärmaßnahmen, um eine emissionsarme und energiesparende Betriebsweise zu ermöglichen, Niklaus Sorg GmbH & Co, 1997, gls/tm/20.

[tm21, Schott]

Schott Guide to Glass second Edition, Ed HG Pfaender, Chapman & Hall, 1996
ISBN 0-412-71960-6. gls/tm21.

[tm22 BOC]

Environmental Technologies for Glass, A Guide to Green Glass Manufacturing, Lehman and Umeza, BOC Gases, 1996, gls/tm/22.

[tm23 SCRPLM]

First practical experiences with an SCR deNOx facility in a container glassworks, Schmalhorst and Ernas, Glastech. Ber. Glass Sci. Technol. 68 (1995) No5, gls/tm/23.

[tm24 FENIX]

Saint-Gobain Vitrage Réduit les Rejets de NOx du Float D'Aniche à près de 500 mg/Nm³ par des Mesures Primaires, Brulin, Delacroix, Laffont and Tackels, L'Industrie Céramic & Verrière-No938-6-7/98, 1998, gls/tm/24.

[tm25 Special]

Reference Document of the European Special Glass Industry for the implementation of Directive 96/61/EC, Comité Permanent des Industries du Verre, May 98, gls/tm/25. Including supplements.

[tm26, EURIMA]

EURIMA BAT Reference note on insulation wool production, October 1998
European Insulation Manufacturers Association, gls/tm/26. Including supplements

[tm27, Domestic]

Reference Document of the European Tableware and Domestic Glass Industry for the implementation of Directive 96/61/EC, Comité Permanent des Industries du Verre (European Domestic Glass Sector), April 98, gls/tm/27. Including supplements.

[tm28, EMPA]

Life Cycle Inventories for the Production of Sodium Silicates, EMPA, Bericht Nr. 241, M Fowler, 1997.

[tm29, Infomil]

Dutch Notes on BAT for the Glass and Mineral Wool Industry, Infomil for Dutch Ministry of Environment (Directorate for Air and Energy), December 1998.

[tm30 Dust]

An examination of the low environmental impact of dust emitted by soda-lime glass furnaces, CPIV, 1998, gls/tm/30.

[tm31 69/493/EEC]

Council Directive 69/493/EEC on the approximation of laws of the Member States relating to crystal glass, 1969, Official Journal of the European Communities, gls/tm/31.

[tm32 Beerkens]

Abatement of glass furnace emissions techniques, performance, costs and possible combinations of abatement techniques, RGC Beerkens, February 1999, gls/tm/32.

[tm33 1^0 NO_x]

Primary measures for the NO_x reduction on glass melting furnaces, Sieger, Glastech. Ber. 62 (1989) Nr.5, gls/tm/33.

[tm34 SCRCG]

Experience with an SCR DeNO_x plant for container glass furnaces, Schmalhorst, Ernas and Jeschke, Glastech. Ber. Glass Sci. Technol. 70 (1997) No11, gls/tm/34.

[tm35 SNCR]

Noncatalytic removal of nitrogen in a recuperative container glass furnace, Pabst, Glastech. Ber. Glass Sci. Technol. 67 (1994) No.3, gls/tm/35.

[tm36 FENIXpat.]

Patent publication number WO 98/02386, Method and Device for Reducing NO_x Emission in a Glass Furnace, Saint-Gobain Vitrage, 1998, gls/tm/36.

[tm37 3Rpat.]

Patent publication number 0 599 548 A1, Pilkington Glass Limited, gls/tm/37.

[tm38 3Rpat.b]

Patent publication number 0 599 547 A1, Pilkington Glass Limited, gls/tm/38.

[tm39 3Rupdate]

Pilkington 3R Technology: An Update, Shulver and Quirk, Ceram. Eng. Sci. Proc. 18 [1] (1997), gls/tm/39.

References

[tm40 ECFIA]

ECFIA Information Report on Environmental Performances of RCF Manufacturing Plants in Europe, ECFIA, December 1998, gls/tm/40.

[tm41 VDI 2578]

Verein Deutscher Ingenieure Guidelines (VDI 2578) Emission Control Glassworks (DRAFT), November 1997.

[tm42 filterdust]

Recycling of cullet and filter dust in the German glass industry, Schaeffer, Glastechn. Ber. Glass Sci. Technol. 69 (1996) No. 4, gls/tm/42.

[tm43 SORGecon]

Comparison of ecological and economic aspects of a modern regenerative end-fired furnace and the second generation Sorg LoNOx Melter, Pieper, Platzer and Becher, Glastechn. Ber. Glass Sci. Technol. 68 (1995) No. 7, gls/tm/43.

[tm44 Frits]

Ceramic Decorating Materials-Aspects of Product Stewardship, ANFFECC / CERAMICOLOR / EPSOM / VdMi, 1998, gls/tm/44.

[tm45 Illy]

Processes for heat recovery and energy savings in oxy-fired glass furnaces: a technology survey, Illy, Borders, Joshi, Zucchelli, Jurcik, International Glass Journal (1998) – No 96, gls/tm/45.

[tm46 ANFFECC]

Reference Document of the Spanish Frits Industry for the Implementation of the Directiva IPPC 96/61/EC, February 1999, gls/tm/46.

[tm47 BAT France]

BAT Reference document submitted to the EIPPC Bureau, French Ministry of Environment, February 1998, gls/tm/47.

[tm48 ADEME SO_x]

Les techniques de désulfuration des procédés industriels, ADEME, 1999, gls/tm/48.

[tm50 HMIP Frit]

Pollution Control at Glass and Enamel Frit Plants, HMIP, September 1991, gls/tm/50.

[tm51 UBA]

Stand der Technik bei der glasherstellung, Umweltbundesamt - Austria, 1999, gls/tm/51.

[tm52 Karlsruhe]

Emission Control at stationary Sources in the Federal Republic of Germany Vol I +II – NO_x, SO_x and heavy metals, FGIER University of Karlsruhe (TH), August 1996, gls/tm/52.

[tm53 Gas Reburning]

Application of Gas Reburning Technology to Glass Furnaces for NO_x Emissions Control, Moyeda Energy and Environmental Research Corporation, Irvine California, gls/tm/53.

[tm54 Gas Reburning2]

Glass Furnace NO_x Control with Gas Reburn, Koppang and Moyeda, Energy and Environmental Research Corporation, Irvine California, gls/tm/54.

[tm55 Field Test]

Glass Furnace NO_x Control with Gas Reburn The Field Test (draft article), Koppang, Marquez and Moyeda, Energy and Environmental Research Corporation, Irvine California, gls/tm/55.

[tm56 GazdeFrance]

Le Reburning: un bon moyen de réduction des émissions d'oxydes d'azote dans les fours de fusion de verre, Project Reburning Gaz, Gaz de France, December 1996, gls/tm/56.

[CPIV stats]

CPIV statistics presented to European Commission Joint Meeting May 1998, Comité Permanent des Industries du Verre.

[EURIMA stats]

EURIMA Statistics report provided to European IPPC Bureau May 1998
European Insulation Manufacturers Association

[SORG Flex]

SORG Brochure on Flex Melter – “Discontinuous Production Constant Quality”, Nikolaus SORG GmbH & Co KG.

[SORG LoNOx]

SORG Brochure on LoNOx Melter, Nikolaus SORG GmbH & Co KG.

[ANFFECC]

BREF Support Document for the Spanish Frits Industry (Draft1), ANFFECC, October 1998.