



EUROPEAN COMMISSION

Integrated Pollution Prevention and Control (IPPC)

**Reference Document on Best Available Techniques for
the Textiles Industry**

July 2003

This document is one of a series of foreseen documents as below (at the time of writing, not all documents have been drafted):

Full title	BREF code
Reference Document on Best Available Techniques for Intensive Rearing of Poultry and Pigs	ILF
Reference Document on the General Principles of Monitoring	MON
Reference Document on Best Available Techniques for the Tanning of Hides and Skins	TAN
Reference Document on Best Available Techniques in the Glass Manufacturing Industry	GLS
Reference Document on Best Available Techniques in the Pulp and Paper Industry	PP
Reference Document on Best Available Techniques on the Production of Iron and Steel	I&S
Reference Document on Best Available Techniques in the Cement and Lime Manufacturing Industries	CL
Reference Document on the Application of Best Available Techniques to Industrial Cooling Systems	CV
Reference Document on Best Available Techniques in the Chlor – Alkali Manufacturing Industry	CAK
Reference Document on Best Available Techniques in the Ferrous Metals Processing Industry	FMP
Reference Document on Best Available Techniques in the Non Ferrous Metals Industries	NFM
Reference Document on Best Available Techniques for the Textiles Industry	TXT
Reference Document on Best Available Techniques for Mineral Oil and Gas Refineries	REF
Reference Document on Best Available Techniques in the Large Volume Organic Chemical Industry	LVOC
Reference Document on Best Available Techniques in the Waste Water and Waste Gas Treatment/Management Systems in the Chemical Sector	CWW
Reference Document on Best Available Techniques in the Food, Drink and Milk Industry	FM
Reference Document on Best Available Techniques in the Smitheries and Foundries Industry	SF
Reference Document on Best Available Techniques on Emissions from Storage	ESB
Reference Document on Best Available Techniques on Economics and Cross-Media Effects	ECM
Reference Document on Best Available Techniques for Large Combustion Plants	LCP
Reference Document on Best Available Techniques in the Slaughterhouses and Animals By-products Industries	SA
Reference Document on Best Available Techniques for Management of Tailings and Waste-Rock in Mining Activities	MTWR
Reference Document on Best Available Techniques for the Surface Treatment of Metals	STM
Reference Document on Best Available Techniques for the Waste Treatments Industries	WT
Reference Document on Best Available Techniques for the Manufacture of Large Volume Inorganic Chemicals (Ammonia, Acids and Fertilisers)	LVIC-AAF
Reference Document on Best Available Techniques for Waste Incineration	WI
Reference Document on Best Available Techniques for Manufacture of Polymers	POL
Reference Document on Energy Efficiency Techniques	ENE
Reference Document on Best Available Techniques for the Manufacture of Organic Fine Chemicals	OFC
Reference Document on Best Available Techniques for the Manufacture of Specialty Inorganic Chemicals	SIC
Reference Document on Best Available Techniques for Surface Treatment Using Solvents	STS
Reference Document on Best Available Techniques for the Manufacture of Large Volume Inorganic Chemicals (Solids and Others)	LVIC-S
Reference Document on Best Available Techniques in Ceramic Manufacturing Industry	CER

EXECUTIVE SUMMARY

INTRODUCTION

This reference document on best available techniques in the textile industry reflects an information exchange carried out according to Article 16(2) of Council Directive 96/61/EC. The document has to be seen in the light of the preface, which describes the objective of the document and its use.

This document covers the industrial activities specified in section 6.2 of Annex I of the IPPC Directive 96/61/EC, namely: “Plants for pretreatment (operations such as washing, bleaching, mercerisation) or dyeing of fibres or textiles where the treatment capacity exceeds 10 tonnes per day”.

In addition, the BREF contains a number of annexes, which provide supplementary information about textile auxiliaries, dyes and pigments, textile machinery, typical recipes, etc.

The objective of this executive summary is to summarise the main findings of the document. However, since it is impossible to reflect all its complexities in a short summary, only the main text in its entirety should be used as a reference in the determination of BAT for any particular installation.

THE TEXTILE INDUSTRY

The textile industry is one of the longest and most complicated industrial chains in manufacturing industry. It is a fragmented and heterogeneous sector dominated by SMEs, with a demand mainly driven by three main end-uses: clothing, home furnishing and industrial use.

Italy is by far the leading European producer for textiles, followed by Germany, the UK, France and Spain (in that order), together accounting for over 80 % of the production in the EU. Belgium, France, Germany and the UK are the main European producers in the carpets sector.

In 2000 the European textile and clothing industry represented 3.4 % of the EU manufacturing industry's turnover, 3.8 % of the added value and 6.9 % of the industrial employment.

The textile industry is composed of a wide number of sub-sectors, covering the entire production cycle from the production of raw materials (man-made fibres) to semi-processed (yarn, woven and knitted fabrics with their finishing processes) and final products (carpets, home textiles, clothing and industrial use textiles). As the scope of the document is confined to those activities that involve wet processes, three main sub-sectors have been identified: wool scouring, textile finishing (excluding floor-covering) and the carpet sector.

APPLIED PROCESSES AND TECHNIQUES

The textile chain begins with the production or harvest of raw fibre. The so-called “finishing processes” (i.e. pretreatment, dyeing, printing, finishing and coating, including washing and drying) represent the core of the applied processes and techniques in this BREF. Upstream processes such as, for example, synthetic fibre manufacturing, spinning, weaving, knitting, etc. are also briefly described in the document as they may have a significant influence on the environmental impact of the subsequent wet processing activities. The “finishing processes” can take place at different stages of the production process (i.e. on fabric, yarn, loose fibre, etc.), the sequence of treatments being very variable and dependent on the requirements of the final user.

Firstly the finishing treatments are described as unit processes without considering the possible sequences in which they can be applied. Later in Chapter 2, some typical categories of industries have been identified within the wool scouring, the textile finishing and the carpet sector and the process sequences briefly described.

ENVIRONMENTAL ISSUES AND CONSUMPTION & EMISSION LEVELS

The main environmental concern in the textile industry is about the amount of water discharged and the chemical load it carries. Other important issues are energy consumption, air emissions, solid wastes and odours, which can be a significant nuisance in certain treatments.

Air emissions are usually collected at their point of origin. Because they have long been controlled in different countries, there are good historical data on air emissions from specific processes. This is not the case with emissions to water. The various streams coming from the different processes are mixed together to produce a final effluent whose characteristics are the result of a complex combination of factors such as, the types of fibres and make-ups processed, the techniques applied and the types of chemicals and auxiliaries used.

Since data available about water effluents from specific processes is very poor, it has proved appropriate to identify narrow categories of textile mills and to compare the overall mass streams between mills belonging to the same category. This approach allows a preliminary rough assessment in which, by comparing the specific consumption and emission levels of mills within the same category, it is possible to verify given data and identify macroscopic differences between the different activities. Input/output considerations are therefore addressed in the BREF for a number of typical categories of mills, starting from overviews of the overall mass streams and ending in a more detailed analysis of single processes when data is available. The key findings about some processes of particular concern are reported in this summary.

Wool scouring with water leads to the discharge of an effluent with a high organic content (2 to 15 l/kg of greasy wool at about 150 - 500g COD/kg of wool) and variable amounts of micro-pollutants resulting from the pesticides applied on the sheep. The most common pesticides are organophosphorous (OP), synthetic pyrethroids (SP) and insect growth regulators (IGR). Organochlorine (OC) pesticides are still found on wool from certain grower countries.

A large percentage of the total emission load from textile industry activities is attributable to substances that are already on the raw material before it enters the finishing mill (e.g. impurities and associated materials for natural fibres, preparation agents, spinning lubricants, sizing agents, etc.). All these substances are usually removed from the fibre during the pretreatment process before colouring and finishing. The removal of auxiliaries such as, spinning lubricants, knitting oils and preparation agents by wet treatment may lead to the discharge not only of hard-to-biodegrade organic substances such as mineral oils, but also of hazardous compounds such as polyaromatic hydrocarbons, APEO and biocides. Typical COD loads are in the order of 40 - 80 g/kg fibre. When the substrate is submitted to a dry process (heat-setting) before washing, the auxiliaries present on the substrate become airborne (emission factors of 10 - 16 g C/kg are typical of mineral oil-based compounds).

The washing water from the desizing of cotton and cotton-blend fabrics may contain 70 % of the total COD load in the final effluent. The emission factor can well be in the order of 95 g COD/kg of fabric, with COD concentrations often above 20000 mg COD/l.

Sodium hypochlorite bleaching gives rise to secondary reactions that form organic halogen compounds commonly measured as AOX (trichloromethane accounts for the bulk of the compounds formed). For the combined application of hypochlorite (1st step) and hydrogen peroxide (2nd step) values of 90 - 100 mg Cl/l of AOX have been observed from the exhausted NaClO-bleaching bath. Concentrations up to 6 mg Cl/l can still be found in the spent H₂O₂-bleaching bath, due to the carry over of the substrate from the previous bath.

Compared to sodium hypochlorite, the amount of AOX formed during chlorite bleaching is much lower. Recent investigations have shown that the formation of AOX is not caused by the sodium chlorite itself, but rather by the chlorine or hypochlorite present as impurities or are used as activating agents. The handling and storage of sodium chlorite needs particular attention because of toxicity, corrosion and explosion risks.

In hydrogen peroxide bleaching the environmental concerns are associated with the use of strong complexing agents (stabilisers).

A strong alkaline effluent (40 - 50 g NaOH/l) is produced if the rinsing water after mercerising is not recovered or re-used.

Apart from a few exceptions (e.g. the thermosol process, pigment dyeing, etc.), most of the emissions originating from the dyeing process are emissions to water. Water-polluting substances can originate from the dyes themselves (e.g. aquatic toxicity, metals, colour), auxiliaries contained in the dye formulation (e.g. dispersing agents, anti-foaming agents, etc.), basic chemicals and auxiliaries used in dyeing processes (e.g. alkali, salts, reducing and oxidising agents, etc.) and residual contaminants present on the fibre (e.g. residues of pesticides on wool, spin finishes on synthetic fibres). Consumption and emission levels are strongly related to the type of fibre, the make-up, the dyeing technique and the machinery employed.

In batch dyeing, the concentration levels vary greatly in the dyeing sequence. Generally, spent dye baths have the highest concentration levels (values well above 5000 mg COD/l are common). The contribution of dyeing auxiliaries (e.g. dispersing and levelling agents) to the COD load is especially noticeable when dyeing with vat or disperse dyes. Operations like soaping, reductive aftertreatment and softening are also associated with high values of COD. Rinsing baths show concentrations 10 - 100 times lower than the exhausted dyeing bath and water consumption 2 to 5 times higher than for the dyeing process itself.

In continuous and semi-continuous dyeing, the water consumption is lower than in batch dyeing processes, but the discharge of highly concentrated residual dyeing-liquors can result in higher pollution load when short runs of material are processed (COD attributable to the dyestuffs may be in the order of 2 - 200 g/l). The padding technique is still the most commonly applied. The quantity of liquor in the padder can range from 10 - 15 litres for modern designs to 100 litres for conventional padders. The residual amount in the preparation tank can range from a few litres under optimised control conditions to up to 150 - 200 l. The total quantity of residual liquor increases with the number of batches per day.

Typical emission sources in printing processes include printing paste residues, waste water from wash-off and cleaning operations and volatile organic compounds from drying and fixing. Losses of printing pastes are particularly noticeable in rotary screen printing (losses of 6.5 - 8.5 kg per colour applied are common for textiles). With short runs (i.e. less than 250 m) the amount of losses may be higher than the quantity of paste printed on the textile substrate. Water consumption levels for cleaning of the equipment at the end of each run are in the order of about 500 l (excluding water for cleaning the printing belt). Printing pastes contain substances with high air emission potential (e.g. ammonia, formaldehyde, methanol and other alcohols, esters, aliphatic hydrocarbons, monomers such as, acrylates, vinylacetate, styrene, acrylonitrile, etc.).

Since most continuous finishing processes do not require washing operations after curing, water emissions are restricted to the system losses and to the water used to clean the equipment. The amount of residual liquors is in the range of 0.5 to 35 % of the total amount of finishing liquor prepared (the lower value is for integrated mills, whereas higher values are typical of textile mills processing small lots and different types of substrates). Too often these liquors are drained and mixed with other effluents. The COD concentration can easily be in the range of 130 - 200 g/l. Often the ingredients of the finishing formulations are non-biodegradable, non-bioeliminable and sometimes also toxic (e.g. biocides). In the drying and curing operations, air emissions are associated with the volatility of the ingredients of the formulations and with the carry-over from upstream processes (e.g. textiles previously treated with chlorinated carriers or perchloroethylene).

Water washing processes contribute to water and energy consumption. The polluting load of the washing water is related to the pollutants carried by the water stream (e.g. impurities removed from the fabric, chemicals from previous processes, detergents and other auxiliaries used during washing). The use of organic halogenated solvents (persistent substances) for dry cleaning may give rise to diffuse emissions, resulting in groundwater and soil pollution and may also have negative effects on the air emissions from high-temperature downstream processes.

TECHNIQUES TO CONSIDER IN THE DETERMINATION OF BAT

General good management practices

General good management practises range from staff education and training to the definition of well-documented procedures for equipment maintenance, chemical storage, handling, dosing and dispensing. Improved knowledge of the inputs and outputs of the process is also an essential part of good management. This includes inputs of textile raw material, chemicals, heat, power and water, and outputs of product, waste water, air emissions, sludge, solid wastes and by-products. Monitoring process inputs and outputs is the starting point for identifying options and priorities for improving environmental and economic performance.

Measures for improving the quality and quantity of chemicals used include regular revision and assessment of the recipes, optimal scheduling in production, use of high quality water in wet processes, etc. Systems for automated control of process parameters (e.g. temperature, liquor level, chemicals feed) allow a tighter control of the process for improved right-first-time performance, with minimum surplus of applied chemicals and auxiliaries.

Optimising water consumption in textile operations starts with controlling water consumption levels. The next step is reducing water consumption, through a number of often-complementary actions. These include improving working practices, reducing liquor ratio in batch processing, increasing washing efficiency, combining processes (e.g. scouring and desizing) and re-using/recycling water. Most of these measures allow significant savings not only in water consumption, but also in energy consumption because energy is used to a great extent to heat up the process baths. Other techniques are specifically focused on optimising the use of energy (e.g. heat-insulation of pipes, valves, tanks and machines, segregation of hot and cold waste water streams and recovery of heat from the hot stream).

Quality management of incoming fibre

Information about textile raw materials is the first step to tackle pollution carried over from upstream processes. Information from the supplier should include not only the technical characteristics of the textile substrate, but also the type and amount of preparation agents and sizing agents, residual monomers, metals, biocides (e.g. ectoparasiticides for wool) present on the fibre. Various techniques are available that can significantly reduce the environmental impact originating from upstream processes.

As for pesticides residues on raw wool fibre, a number of organisations maintain information on the pesticides content of greasy and scoured wool. Manufacturers can use this information to minimise at source any legally used pesticides such as OP and SP ectoparasiticides, and to avoid processing wool contaminated with the most hazardous chemicals, such as OC pesticides, unless an analytical certificate is provided. In the absence of information, samples should be assayed to confirm their pesticide content, but this option entails higher costs for the manufacturer. Currently co-operation programmes between trade associations and leading grower countries have resulted in a progressive reduction of the average OP and SP residues on wool, along with the development of low-residue certification schemes.

Improvements are also possible for auxiliaries, such as, preparation agents, spinning lubricants and knitting oils. Substitutes for mineral oils are now available for most applications. Alternative compounds have a high level of biodegradability or at least bioeliminability; they are also less volatile and more thermally stable than mineral oils. This helps to reduce odour nuisance and air emissions, which can occur when the substrate is submitted to high-temperature treatments such as thermofixation.

The combination of low add-on techniques such as pre-wetting of the warp yarns or compact spinning, with the targeted selection of sizing agents helps to reduce the environmental impact of the desizing process. It is now accepted that readily biodegradable or bioeliminable compounds are available, covering all needs. Moreover, latest generation-polyacrylates are highly efficient with lower add-on and can be completely and easily removed from the fabric.

In general, integrated mills have the means to control the source of their raw material and chemicals applied on the fibre. For non-integrated companies (particularly for commission companies), it is more difficult to influence the up-stream suppliers. Conventional formulations are typically cheaper. Raw material suppliers (e.g. spinning, knitting mills) look mainly at the economic aspects and at the performance of the given substance in their own process, rather than at the environmental problems produced in the downstream processes (at the finishing mill). In these cases it is necessary to work with clients to eliminate these materials from the supply chain.

Selection and substitution of chemicals used

A number of schemes for ecotoxicological assessment and classifications of chemicals have been proposed by the TWG for consideration in the determination of BAT. Based on these tools, substitution of the harmful substances is often an available option to reduce the environmental impact of a process.

Surfactants are used for many different purposes in the textile industry (e.g. detergents, lubricants, etc.). Some surfactants are considered problematic because of their poor biodegradability and toxicity to aquatic species. Concerns currently focus on APEO and in particular NPE. The main alternatives for APEO are fatty alcohol ethoxylates, but also for other surfactants substitutes are often available that are readily biodegradable or bioeliminable in the waste water treatment plant and that do not form toxic metabolites.

Complexing agents can often be avoided. Nevertheless, when they need to be used, compounds are available as an alternative to conventional sequestering agents that are readily biodegradable or at least bioeliminable and that do not contain N or P in their molecule (e.g. polycarbonates, polyacrylates, gluconates, citrates and some sugar-acrylic acid copolymers). Costs are comparable, although higher quantities may be necessary in some cases.

Antifoaming agents are often based on mineral oils. Typical active ingredients in mineral oil-free products are silicones, phosphoric esters, high molecular alcohols, fluorine derivatives and mixtures of these components. Silicones are eliminated only by abiotic processes in waste water and above certain concentrations they hinder the transfer/diffusion of oxygen into the activated sludge. Tributylphosphates are odour intensive and strongly irritant and high molecular-weight alcohols are odour intensive and cannot be used in hot liquors.

Wool scouring

The implementation of dirt removal/ grease recovery loops allows water and energy savings (net specific water consumption figures of 2 - 4 l/kg greasy wool have proven to be achievable for coarse and fine wool). Additionally, a valuable by-product is obtained (25 to 30 % of the grease estimated to be present in the wool scoured), along with a significant reduction of the organic load sent to the effluent treatment plant. If the dirt removal/ grease recovery loop is combined with evaporation of the effluent and incineration of the sludge, with full recycling of the water and energy, additional environmental benefits are achieved in terms of water savings and amount of solid waste to be disposed of. Nevertheless, the technology is complex and is reported to involve very high capital costs and high running costs.

Wool scouring with organic solvents avoids the use of water in the actual cleaning process. The only source of water emission is moisture introduced with the wool, steam used in vacuum ejectors and moisture recovered from air drawn into the equipment. This water is contaminated with perchloroethylene (PER). To avoid any risk of diffuse emissions, the water stream is treated in two steps, comprising a solvent air stripping unit and a residual solvent destruction

unit. Since pesticides partition strongly to the solvent and are removed with the grease, the clean wool is reported to be pesticide free. This has beneficial implications for the downstream processes where the wool is finished. Another positive effect of this technique is the reduced energy consumption, due to the low latent heat of an organic solvent compared to water.

Pretreatment

Water-soluble synthetic sizing agents such as PVA, polyacrylates and CMC can be recovered from washing liquor by UF and re-used in the process. Recently, it has been confirmed that modified starches such as carboxymethyl starch can also be recycled. However, re-use in the weaving plant is not always without problems. To date, the weavers' acceptance of recovered sizes is still limited. Furthermore, long-distance shipments cancel out any ecological advantages because the liquor needs to be transported in adequate conditions in insulated tankers. For these reasons, sizing agents are usually only recovered in integrated mills which have a weaving and a finishing section at the same site.

For non integrated mills that deal with many different types of fabrics and find it more difficult to have a direct control on the source of the raw fabric, a viable option is the oxidative route. Under specific conditions (i.e. above pH 13), H₂O₂ will generate free radicals which efficiently and uniformly degrade all sizes and remove them from the fabric. The process produces shorter and less branched pre-oxidised molecules, which are easier to wash out (with a reduced amount of water) and easier to degrade in the waste water treatment plant. It is desirable to combine alkaline peroxide bleaching with scouring and regulate the counter-current flow of alkali and peroxide through the different pretreatment steps, so as to save water, energy and chemicals.

Hydrogen peroxide is now the preferred bleaching agent for cotton and cotton blends as a substitute for sodium hypochlorite, although it is claimed that sodium hypochlorite is still necessary for high whiteness and for fabrics that are fragile and would suffer from depolymerisation. In these cases, a two-stage process first with hydrogen peroxide and then with sodium hypochlorite can be applied, in order to reduce AOX emissions (the impurities on the fibre – which act as precursors in the haloform reaction – are removed in the first step). A two-stage bleaching process using only hydrogen peroxide is also possible today, which completely avoids the use of hypochlorite. This option is however reported to be from two to six times more expensive.

There is also increasing support for peroxide bleaching under strong alkaline conditions, which can achieve a high degree of whiteness after careful removal of catalysts by a reduction/extraction technique. The additional advantage claimed is the possible combination of scouring and bleaching. The reduction/extraction followed by a strong oxidative combined bleaching/scouring step is applicable for bleaching highly contaminated textiles in all make-ups and on all types of machines (discontinuous and continuous).

Chlorine dioxide (from sodium chlorite or chlorate) is an excellent bleaching agent for synthetic fibres and for flax, linen and other bast fibres that cannot be bleached using peroxide alone. Recent technologies (using hydrogen peroxide as the reducing agent of sodium chlorate) are now available to produce ClO₂ without generation of AOX (elemental chlorine-free bleach).

The rinsing water after the mercerising treatment (so-called “weak lye”) can be recycled in the process after being concentrated by evaporation.

Dyeing

Well-known PES dyeing carriers can be avoided (except for PES/WO and elastane/WO blends) by dyeing under high-temperature conditions. Another attractive option is the use of non-carrier dyeable PES fibres, such as polytrimethylene terephthalate (PTT) polyester fibres. However, due to differences in physical and mechanical properties, these fibres do not cover exactly the same product market and cannot be regarded as “substitutes” for PET-based polyester fibres. When carriers cannot be avoided, conventional active substances - based on chlorinated aromatic compounds, o-phenylphenol, biphenyl and other aromatic hydrocarbons - can be replaced with less harmful compounds such as, benzylbenzoate and N-alkylphthalimide.

In order to avoid the use of sodium hydrosulphite in PES after-treatment, two different approaches are proposed: the use of reducing agents based on a special short-chain sulphonic acid derivatives or the use of disperse dyes that can be cleared in alkaline medium by hydrolytic solubilisation instead of reduction. Short-chain sulphonic acid derivatives are biodegradable, non-corrosive, have very low toxicity and, unlike hydrogen hydrosulphite, they can be applied in acidic conditions without the need for repeated bath changes and shifts in pH (water and energy savings). With alkali-clearable dyes the use of hydrosulphite or other reducing agents can be avoided altogether.

Dispersing agents typically present in disperse, vat and sulphur dye formulations have been improved by: 1) their partial substitution with optimised products based on fatty acid esters, or 2) the use of mixtures of modified aromatic sulphonic acids. The first option is only applicable for liquid formulations of disperse dyes (the dyestuff palette is currently limited). These dispersing agents are bioeliminable and their amount in the formulation can be significantly reduced compared to conventional formulations. The dispersing agents indicated in the second option show a higher degree of bioelimination compared to the conventional condensation products of naphthalene sulphonic acid with formaldehyde. They can be used both for disperse and vat dyes (solid and liquid formulations).

Pre-reduced sulphur dyestuffs (liquid formulations with sulphide content <1 %) or non-pre-reduced sulphide-free dyestuffs are available in various different forms (water-soluble in the oxidised, powder, liquid form, or in stable suspension). All these dyestuffs can be reduced without any sodium sulphide, using glucose alone (only in one case) or in combination with dithionite, hydroxyacetone or formamidine sulphonic acid. Stabilised non-pre-reduced sulphide-free dyestuffs are reported to be more expensive than the other types of sulphur dyes.

Poor dye fixation has been a long-standing problem with reactive dyeing in particular in batch dyeing of cellulose fibres, where a significant amount of salt is normally added to improve dye exhaustion. With the use of sophisticated molecular engineering techniques it has been possible to design bifunctional and low-salt reactive dyes that can attain >95 % fixation rate even for cellulosic fibres, with considerably higher performance (reproducibility and level dyeing) than traditional reactive dyes. Hot rinsing avoids the use of detergents and complexing agents in the rinsing and neutralisation steps after dyeing. Substituting cold rinsing with hot rinsing leads to higher energy consumption, unless thermal energy from the rinsing effluent is recovered.

The use of sodium silicate in pad-batch dyeing of cellulosic fabrics can be avoided thanks to silicate-free highly concentrated aqueous solutions, which are ready-made products easily applicable with modern dosing systems. An alternative process is also described, which doesn't require the addition of substances such as urea, sodium silicate and salt, or long dwell-time to fix the dyes. The process itself is simple and highly versatile and is applicable to a wide variety of fabrics, regardless of the size of the lot. Significant savings can be achieved thanks to higher productivity, reduced consumption of chemicals and energy and the reduced waste water pollution to treat. Nevertheless due to the initial high capital investment, this technique fits better in new installations and in those seeking to replace equipment.

Quite recently, new reactive dyestuffs have come on the market that can provide very good levels of fastness, even equivalent with those achievable with chrome dyes, even for dark shades. However, the importance of reactive dyes is only slowly increasing due to a number of reasons, including difficulties of the operators accepting radical changes to a well-established procedure. Moreover, some finishers still consider that chrome dyes are the only ones that can guarantee the level of fastness required for overdyeing. When chrome dyes are used, low-chrome and ultra-low stoichiometric chrome dyeing techniques can be adopted to minimise the amount of residual chromium in the final effluent. With ultra-low chroming an emission factor of 50 mg chromium per kg of wool treated is achieved, which corresponds to a chromium concentration of 5 mg/l in the spent chroming bath when a 1:10 liquor ratio is used.

In general, with pH-controllable dyes (e.g. acid and basic dyes) it is advantageous to dye at isothermal conditions imposing a pH profile. One of the advantages over temperature-controlled dyeing processes is that maximum exhaustion of dyes and insect resist agents can be achieved with only a minimum use of organic levelling agents. When dyeing wool with metal-complex dyes, higher levels of exhaustion and fixation rate can be achieved by controlling the pH and by using special auxiliaries with high affinity for the fibre and dyestuff. The higher exhaustion rate directly correlates with the reduced residual chromium levels in the spent dye bath (10 - 20 mg/kg of treated wool, corresponding to 1 - 2 mg/l of chromium in the spent dye bath with 1:10 L.R.). The referenced technique has been designed for dyeing loose wool fibre and combed tops, but the same performances can also be achieved with other make-ups by using pH-controlled methods to maximise final bath exhaustion.

Various techniques are described in the BREF aimed at improving the environmental performance of batch and continuous dyeing processes in general. A distinct trend has developed among batch dyeing machinery manufacturers toward reducing bath ratios. Moreover, an outstanding feature of modern machines is that they can be operated at approximately constant liquor ratio whilst being loaded much below their nominal capacity. This is especially advantageous for commission companies, who typically need high production flexibility. Furthermore, various functions typical of continuous processing have been transferred to batch machines, which allow maximum cut-off between different batches and thereby open up further options for re-use of the dye bath and improved treatment of the concentrated streams.

As for continuous dyeing processes, reduction of system losses can be achieved by carrying out the impregnation step in a nip or by minimising the capacity of the dip trough (e.g. flex-shaft, U-shaft). Additional improvements are obtained by dispensing the dyestuff and auxiliaries as separate streams and by dosing the padding liquor based on measurement of the pick-up. The amount of dyeing liquor consumed is measured by reference to the quantity of processed fabric. The resulting values are automatically processed and used for the preparation of the next comparable batch in order to minimise residues of unused dyeing liquor. This system, however, cannot avoid the presence of residual dye liquor in the feeding tank. The rapid batch dyeing technique represents a further improvement because, rather than being prepared in a single step (for the whole batch) before starting the dyeing batch, the dyestuff solution is prepared just in time, in several steps, based on on-line measurement of the pick-up.

Printing

Minimising the volume of the printing paste supply system (i.e. diameters of pipes and squeegees) has major effects in reducing printing paste losses in rotary-screen printing. A further reduction can be achieved by improving paste recovery from the supply system itself. A recent technique consists in inserting a ball in the squeegee, before filling the system. At the end of a print run, the ball is pressed back, thus pumping the printing paste in the supply system back into the drum for re-use. Today, computer-assisted systems offer more opportunities for recycling printing pastes. Printing paste recovery and recycling systems are applied in textile finishing mills (for flat fabrics), but not for carpets. The main reason is that guar-gum (the most common thickener used for carpets) has a limited shelf-life (biodegradable compound) and therefore it cannot be stored for a long time before re-use.

Screens, buckets and the print paste feed systems need careful cleaning before being used for new colours. There are several inexpensive ways of reducing water consumption (e.g. start/stop control of cleaning of the printing belt, re-use of the rinsing water from the cleaning of the printing belt, etc.).

An alternative to analogue printing is the use of digital techniques, which are gaining importance in the textile and in the carpet sector. In digital printing the selected dyes are dosed on-demand, based on computed requirements. This avoids printing paste residues at the end of each run.

Digital ink-jet printing is suitable for flat fabrics. However, production speeds are still too low to allow this technique to replace traditional analogue printing. Nevertheless ink-jet printing can already offer significant advantages over analogue printing in the production of short runs.

The latest improvement in jet printing machines for carpet and bulky fabrics is now represented by machines in which the colour is injected with surgical precision deep into the face of the fabric without any machine parts touching the substrate. Here, the control of the quantity of liquor applied to the substrate (which may vary for example from lightweight articles to heavy quality fabrics) is achieved by varying not only the “firing time” but also the pumping pressure.

Urea content in reactive printing paste can be up to 150g/kg paste. Urea can be substituted in the one-step process by controlled addition of moisture either by the foaming technique or by spraying a defined quantity of water mist. However, for silk and viscose articles, it is not possible to avoid the use of urea with the spraying system. The technique is not reliable enough to ensure a uniform dosage of the low moisture add-on required for these fibres.

The foaming technique, on the contrary, has proven successful for viscose in complete elimination of urea. This technique should in principle be technically viable also for silk, although it has not yet been proven. Silk is known to be less problematic as a fibre than viscose, but it is typically processed in smaller runs. Without using the foam technique, the amount of urea consumed can be reduced to about 50 g/kg of printing paste for silk and 80 g/kg for viscose.

Another option for avoiding the use of urea, although more complex and slower, is the two-step printing method.

Although water-in-oil thickeners seem no longer to be applied in Europe and half-emulsion printing pastes (oil in water) are only occasionally used, hydrocarbons (predominantly aliphatic) are still found in exhaust air, mainly arising from mineral oils contained in synthetic thickeners. Their emission potential can be up to 10 g Org.-C/kg textile. New generation thickeners contain minimal amounts of volatile organic solvents, if any. Furthermore, optimised printing pastes are APEO-free, have a reduced ammonia content and contain formaldehyde-poor binders.

Finishing

In order to reduce pick-up, so-called minimum application techniques (e.g. kiss-roll, spray and foaming application systems) are gaining importance as substitutes for padding systems.

In addition, various techniques are available for reducing energy consumption in stenter frames (e.g. mechanical dewatering equipment to reduce water content of the incoming fabric, optimising control of exhaust airflow through the oven, installation of heat recovery systems).

For each finishing process there are techniques for the reduction of the environmental impact associated with the specific substances used. The BREF focuses only on a few finishing processes. In easy-care treatments, emissions of formaldehyde (suspect carcinogenic) can be significantly reduced with low-formaldehyde or formaldehyde-free products (<75 mg/kg textile, or even lower than 30 ppm for consumer requirement).

General techniques to minimise emissions of mothproofing agent include handling procedures to minimise spillage during dispensing and transport of mothproofing agent concentrates within the dyehouse, as well as special operating techniques to achieve lowest residues of active substance in the spent dyeing liquor and rinse water. Two effective measures are 1) to ensure that a pH<4.5 is reached at the end of the dyeing process (when and if this is not possible, apply the insect resist agent in a separate step with re-use of the bath) and 2) to avoid the use of dyeing auxiliaries that exert a retarding action on the uptake of insect resist agents, (e.g. levelling agent, PA blocking agent).

Other techniques include proportional overtreatment, application of the mothproofers from the low-volume bowl at the end of the yarn scouring line, application of the IR agent directly to the pile of the carpet during back-coating or latexing operation, etc. The application of these techniques is specific for each of the three identifiable routes for yarn manufacture, i.e. by the “dry spinning route”, “loose fibre dyed/ yarn scoured production” and “yarn dyed production”.

The application of softeners by pad mangles or by spraying or foaming application systems give better environmental performance than batch softening directly in the dyeing machine after dyeing. The use of cationic softening agents can be avoided and any chemical loss can be reduced to a few percent. Another advantage is that it is then possible to re-use the dyeing or rinse baths as there is no longer a problem with the presence of residual cationic softeners, which would otherwise limit the adsorption of the dye in the subsequent dyeing process.

Washing

“Drain and fill” and “smart rinsing” are both more efficient batch washing techniques than conventional overflow rinsing. Moreover, modern machines are equipped with time-saving devices and other special systems in order to avoid typical limitations of the traditional “drain and fill” method (e.g. longer production cycle time, etc.). With both “smart rinsing” and “drain & fill” it is possible to keep the exhausted concentrated dye liquor and the rinsing waters as separate streams (waste streams segregation and water and energy recovery).

In continuous washing, water and energy conservation should start from the application of simple good housekeeping measures. These can range from the definition of the optimum flow by means of flow control devices on washers, to the installation of stop valves that shut off the water flow as soon as a stoppage occurs. Further improvements can be achieved by increasing the washing efficiency, mainly by counter-current washing and reduction of carry-over (e.g. vacuum extractors). Installing heat recovery equipment on a continuous washer is usually a simple and effective measure.

New installations for washing with halogenated organic solvents are fitted with closed-loop active charcoal filters, thereby avoiding any air-stream exhaustion to the outside environment. In order to minimise emissions of water contaminated with PER, most of the water-dissolved PER is extracted and recovered through a two-stage process involving air-stripping and absorption on active charcoal (PER <1 mg/l in the final effluent). Since the water flow is fairly low ($\leq 0.5 \text{ m}^3/\text{h}$) advanced oxidation processes (e.g. the Fenton process) are suitable for treating this effluent on site. Furthermore the complete redesign of the main distilling section has drastically reduced the solvent residue in the sludge (1 % by weight compared to over 5 % in conventional installations).

Waste water treatment

Hardly-biodegradable compounds can still be degraded in biological plants under low food-to-mass-ratio (F/M) conditions, but non-biodegradable substances are not degraded in biological plants. Concentrated waste water streams containing such compounds should be treated at source. For the textile finishing industry, advanced oxidation with a Fenton-like reaction is proposed as a viable pretreatment technique (depending on the type of effluent, COD removal can reach 70 – 85 % and the residual COD, which is largely biodegradable because of the modification of the compounds, is suitable for biological treatment). However, very strong residues such as residual printing paste and padding liquors can more conveniently be kept out of the waste water stream altogether and other disposal routes used.

For waste water containing pigment printing paste or latex from carpet backing, precipitation/flocculation and incineration of the resulting sludge is a viable alternative to chemical oxidation. Moreover, for azo-dyes, anaerobic treatment of padding liquor and printing pastes before a subsequent aerobic treatment is effective for colour removal.

The following techniques are proposed in order to achieve equivalent performance when treating a mixed effluent:

- tertiary treatments following the biological treatment process, such as adsorption on activated carbon with recycling of the activated carbon to the activated sludge system and destruction of the adsorbed non-biodegradable compounds by incineration or radical treatment of the excess sludge (biomass and spent activated carbon)
- combined biological physical and chemical treatments with the addition of powdered activated carbon and iron salt to the activated sludge system with reactivation of the excess sludge by “wet oxidation” or “wet peroxidation” (if hydrogen peroxide is used)
- ozonation of recalcitrant compounds prior to the activated sludge system.

For wool scouring waste water a number of different scenarios are discussed. The environmental performance of an evaporation plant is far superior to that of a flocculation plant. However, the initial cost of the evaporation plant seems to be much higher and payback (versus discharge to sewer) takes 4 – 5 years for small mills (3500 t/yr of wool). For medium-sized mills (15000 t/yr of wool), evaporation is slightly cheaper than flocculation over 10 years. The use of a dirt removal/grease recovery loop in combination with evaporation makes evaporation even more attractive because a smaller evaporator can be installed, which thereby reduces initial capital outlay. The use of a recovery loop also allows a reduction in running costs thanks to the proceeds from the sales of the grease (this effect is more significant for fine wool scouring mills).

The combination of a dirt removal/ grease recovery loop with evaporation of the effluent and incineration of the sludge with full recycling of water and energy is the best option from an environmental point of view. However, the complexity of the technique and the initial capital cost make it more suitable for 1) new installations, 2) existing installations with no on-site effluent treatment and 3) installations seeking to replace life-expired effluent treatment plant.

In the case of effluent treatment by biological processes it is known that there are scourers in Europe (particularly in Italy) using biological processes as their main methods of effluent treatment. However, no precise information has been submitted.

Wool scour sludge has been proven to have excellent technical properties when mixed with clay for brick-making. The economics are greatly dependent on the deal between the scourer and the brick-maker. According to reported information, the technique should be cheaper than landfilling, composting and incineration. No information is submitted in the BREF about other recycling options available.

GENERIC BAT (WHOLE TEXTILE INDUSTRY)

Management

It is recognised that technology improvements need to go together with environmental management and good housekeeping. Management of an installation that uses potentially polluting processes requires the implementation of many of the elements of an Environmental Management System (EMS). The implementation of a monitoring system for process input and output is a prerequisite for identifying priority areas and options for improving environmental performance.

Dosing and dispensing of chemicals (excluding dyes)

BAT is to install automated dosing and dispensing systems which meter the exact amounts of chemicals and auxiliaries required and deliver them directly to the various machines through pipework without human contact.

Selection & use of chemicals

BAT is to follow certain general principles in selecting chemicals and managing their use:

- where it is possible to achieve the desired process result without the use of chemicals, then avoid their use altogether
- where this is not possible, adopt a risk-based approach to selecting chemicals and their utilisation mode in order to ensure the lowest overall risk.

There are a number of lists and classification tools for chemicals. Modes of operation that ensure the lowest overall risk include techniques such as closed-loops and the in-loop destruction of pollutants. Of course, it is essential that due recognition be given to relevant Community legislation.

Following these principles, a number of detailed BAT conclusions arise in particular for surfactants, complexing and antifoaming agents. More details are found in Chapter 5.

Selection of incoming fibre raw material

It is recognised that knowledge of the quality and quantity of substances (e.g. preparation agents, pesticides, knitting oils) applied on the fibre during the upstream processes is essential to enable the manufacturer to prevent and control the environmental impact resulting from these substances. BAT is to seek collaboration with upstream partners in the textile chain in order to create a chain of environmental responsibility for textiles. It is desirable to exchange information on the type and load of chemicals that are added and remain on the fibre at each stage of the product's life cycle. A number of BAT were identified for different raw materials:

- man-made fibres: BAT is to select material treated with low-emission and biodegradable/bioeliminable preparation agents
- cotton: the main issues are the presence of hazardous substances such as PCP and the quality and quantity of sizing agents used (selection of material sized with low add-on techniques and high-efficiency bioeliminable sizing agents). Preference should be given to organically grown cotton when market conditions allow
- wool: emphasis is given to using available information and to encouraging collaboration initiatives between competent bodies in order to avoid processing wool contaminated with OC pesticides and minimise at the source any legally used sheep ectoparasiticides. The selection of wool yarn spun with biodegradable spinning agents instead of formulations based on mineral oils and/or containing APEO is also part of BAT.

All measures assume that the fibre raw materials for textile processing are produced with some sort of quality assurance scheme, so that the finisher can get the appropriate information about the types and amounts of contaminants.

Water & energy management

Water and energy savings are often related in the textile industry because the main use of energy is to heat up the process baths. BAT starts from the monitoring of water and energy consumption in the various processes along with improved control of process parameters. BAT includes the use of machinery with reduced liquor ratio in batch processing and low add-on techniques in continuous processing, applying the latest techniques to improve washing efficiency. BAT is also to investigate possibilities for water re-use and recycling by a systematic characterisation of quality and volume of the various process streams.

WOOL SCOURING

Wool scouring with water

BAT is to use recovery loops for grease and dirt. BAT-associated values for water consumption are 2 to 4 l/kg of greasy wool for medium and large mills (15000 tonnes/year of greasy wool) and 6 l/kg for small mills. Associated values for grease recovery range between 25 and 30 % of the grease estimated to be present in the scoured wool. Likewise, BAT-associated values for energy consumption are 4 - 4.5 MJ/kg greasy wool processed, comprising approximately 3.5 MJ/kg thermal energy and 1 MJ/kg electrical energy. However, due to the lack of data it is

not possible to define whether the above-mentioned BAT associated values for water and energy consumption are also applicable to extra-fine wool (fibre diameter typically in the order of 20µm or less).

Wool scouring with organic solvent

Scouring with organic solvent is determined as BAT, provided that all measures are taken to minimise fugitive losses and prevent any possible contamination of groundwater arising from diffuse pollution and accidents. Details about these measures are described in Section 2.3.1.3.

TEXTILE FINISHING AND CARPET INDUSTRY

Pretreatment

Removing knitting lubricants from fabric

BAT is to do one of following:

- select knitted fabric that has been processed using water-soluble and biodegradable lubricants instead of the conventional mineral oil-based lubricants (see Section 4.2.3). Remove them by water washing. With knitted fabrics made of synthetic fibres the washing step needs to be carried out before thermofixation (to remove the lubricants and avoid them being released in the form of air emissions)
- carry out the thermofixation step before washing and treat the air emissions generated from the stenter frame by dry electrofiltration systems that allow energy recovery and separate collection of the oil. This will reduce the contamination of the effluent (see Section 4.10.9)
- remove the non-water soluble oils using organic solvent washing. The requirements described in Section 2.3.1.3 are then taken, along with provisions for the in-loop destruction of the persistent pollutants (e.g. by advanced oxidation processes). This will avoid any possible contamination of groundwater arising from diffuse pollution and accidents. This technique is convenient when other non water-soluble preparation agents, such as silicone oils, are present on the fabric.

Desizing

BAT is to do one of the following:

- select raw material processed with low add-on techniques (e.g. pre-wetting of the warp yarn, see 4.2.5) and more effective bioeliminable sizing agents (see 4.2.4) combined with the use of efficient washing systems for desizing and low F/M waste water treatment techniques (F/M <0.15 kg BOD₅/kg MLSS·d, adaptation of the activated sludge and temperatures higher than 15 °C – see 4.10.1) to improve the bioeliminability of the sizing agents
- adopt the oxidative route when it is not possible to control the source of the raw material (see Section 4.5.2.4)
- combine desizing/scouring and bleaching in one single step, as described in Section 4.5.3.
- recover and re-use the sizing agents by ultrafiltration as described in Section 4.5.1.

Bleaching

BAT is to:

- use hydrogen peroxide bleaching as preferred bleaching agent combined with techniques for minimising the use of hydrogen peroxide stabilisers, as described in Section 4.5.5, or using biodegradable/bioeliminable complexing agents described in Section 4.3.4
- use sodium chlorite for flax and bast fibres that cannot be bleached with hydrogen peroxide alone. A two-step hydrogen peroxide-chlorine dioxide bleaching is the preferred option. It must be ensured that elemental chlorine-free chlorine dioxide is used. Chlorine-free chlorine dioxide is produced using hydrogen peroxide as the reducing agent of sodium chlorate (see Section 4.5.5)
- limit the use of sodium hypochlorite only to cases in which high whiteness has to be achieved and to fabrics that are fragile and would suffer depolymerisation. In these special cases, to reduce the formation of hazardous AOX, sodium hypochlorite bleaching is carried out in a two-step process in which peroxide is used in the first step and hypochlorite in the second. Effluent from hypochlorite bleaching is kept separate from the other streams and mixed effluents in order to reduce formation of hazardous AOX.

Mercerising

BAT is to either:

- recover and re-use alkali from mercerising rinsing water as described in Section 4.5.7
- or re-use the alkali-containing effluent in other preparation treatments.

Dyeing

Dosage and dispensing of dye formulations

BAT is to do all the following:

- reduce the number of dyes (one way to reduce the number of dyes is by using trichromatic systems)
- use automated systems for dosage and dispensing of dyes, only considering manual operation for dyes that are used infrequently
- in long continuous lines where the dead volume of the distribution line is comparable with the volume in the padder, give preference to decentralised automated stations that do not premix the different chemicals with the dyes before the process and that are fully automatically cleaned.

General BAT for batch dyeing processes

BAT is to:

- use machinery fitted with: automatic controllers of fill volume, temperature and other dyeing cycle parameters, indirect heating & cooling systems, hoods and doors to minimise vapour losses
- choose the machinery that is most fitted to the size of the lot to be processed to allow its operation in the range of nominal liquor ratios for which it is designed. Modern machines can be operated at approximately constant liquor ratio whilst being loaded at a level as low as 60 % of their nominal capacity (or even 30 % of their nominal capacity with yarn dyeing machines) (see Section 4.6.19)
- select new machinery according as far as possible to the requirements described in Section 4.6.19:
 - low- or ultra-low liquor ratio
 - in-process separation of the bath from the substrate
 - internal separation of process liquor from the washing liquor
 - mechanical liquor extraction to reduce carry-over and improve washing efficiency
 - reduced duration of the cycle.
- substitute overflow-flood rinsing method in favour of drain and fill or other methods (smart rinsing for fabric) as described in Section 4.9.1
- re-use rinse water for the next dyeing or reconstitution and re-use the dye bath when technical considerations allow. This technique (see Section 4.6.22) is easier to implement in loose fibre dyeing where top-loading machines are used. The fibre carrier can be removed from the dyeing machine without draining the bath. However, modern batch dyeing machines are equipped with built-in holding tanks allowing for uninterrupted automatic separation of concentrates from rinsing water

BAT for continuous dyeing processes

Continuous and semi-continuous dyeing processes consume less water than batch dyeing, but highly concentrated residues are produced.

BAT is to reduce losses of concentrated liquor by:

- using low add-on liquor application systems and minimising volume capacity of the dip trough when using pad dyeing techniques
- adopting dispensing systems where the chemicals are dispensed on-line as separate streams, being mixed only immediately before being fed to the applicator
- using one of the following systems for dosing the padding liquor, based on measurement of the pick up (see 4.6.7):
 - measure the amount of dyeing liquor consumed by reference to the quantity of processed fabric (length of the fabric multiplied by its specific weight); the resulting values are automatically processed and used for the preparation of the next comparable batch
 - use the rapid batch dyeing technique, where rather than being prepared for the whole batch before starting the dyeing batch, the dyestuff solution is prepared just in time, in several steps, based on on-line measurement of the pick up. This second technique is preferred when economic considerations allow (see 4.6.7)
- increase washing efficiency according to the principles of counter-current washing and reduction of carry-over described in Section 4.9.2.

PES & PES blends dyeing with disperse dyes

BAT is to:

- avoid the use of hazardous carriers by (in order of priority):
 - using non-carrier dyeable polyester fibres (modified PET or PTT-type) as described in Section 4.6.2, when product market considerations allow
 - dyeing in HT conditions without use of carriers. This technique is not applicable to PES/WO and elastane/WO blends
 - substituting conventional dye carriers with compounds based on benzylbenzoate and N-alkylphthalimide, when dyeing WO/PES fibres (see Section 4.6.1)
- substitute sodium dithionite in PES aftertreatment, by applying one of the two proposed techniques (as described in Section 4.6.5):
 - replace sodium dithionite with reducing agent based on sulphinic acid derivatives. This should be combined with measures in order to ensure that only the strict amount of reducing agent needed to reduce the dyestuff is consumed (e.g. by using nitrogen to remove oxygen from the liquor and from the air in the machine)
 - use of disperse dyes that can be cleared in alkaline medium by hydrolytic solubilisation instead of reduction (see Section 4.6.5)
- use optimised dye formulations that contain dispersing agents with high degree of bioeliminability as described in Section 4.6.3.

Dyeing with sulphur dyes

BAT is to (see 4.6.6):

- replace conventional powder and liquid sulphur dyes with stabilised non-pre-reduced sulphide-free dyestuffs or with pre-reduced liquid dye formulations with a sulphide content of less than 1 %
- replace sodium sulphide with sulphur-free reducing agents or sodium dithionite, in that order of preference
- adopt measures to ensure that only the strict amount of reducing agent needed to reduce the dyestuff is consumed (e.g. by using nitrogen to remove oxygen from the liquor and from the air in the machine)
- use hydrogen peroxide as preferred oxidant.

Batch dyeing with reactive dyes

BAT is to:

- use high-fixation, low-salt reactive dyes as described in Sections 4.6.10 and 4.6.11
- avoid the use of detergents and complexing agents in the rinsing and neutralisation steps after dyeing, by applying hot rinsing integrated with recovery of the thermal energy from the rinsing effluent (see Section 4.6.12).

Pad-batch dyeing with reactive dyes

BAT is to use dyeing techniques that perform at equivalent levels to those described in Section 4.6.13. The technique described is more cost effective than pad-batch dyeing in terms of total processing costs, but the initial capital investment in switching to the new technology is significant. However, for new installations and those seeking to replace equipment the cost factor is not so significant. In all cases, BAT is to avoid the use of urea and to use silicate-free fixation methods (see Section 4.6.9).

Wool dyeing

BAT is to:

- substitute chrome dyes with reactive dyes or, where not possible, use ultra-low chroming methods that fulfil all the following requirements as defined in Section 4.6.15:
 - an emission factor of 50 mg chromium per kg of wool treated is achieved, which corresponds to a chromium concentration of 5 mg/l in the spent chroming bath when a 1:10 liquor ratio is used
 - no chromium (VI) is detectable in the waste water (using a standard method able to detect Cr VI at concentrations <0.1 mg/l)
- ensure minimum discharge of heavy metals in the waste water when dyeing wool with metal complex dyes. BAT associated values are emission factors of 10 - 20 mg/kg of treated wool, which correspond to 1 - 2 mg/l of chromium in the spent dye bath when a 1:10 liquor ratio is used. These performances can be achieved by:
 - using auxiliaries that enhance dye uptake like, for instance, the process described in Section 4.6.17 for loose wool and tops
 - using pH control methods to maximise final bath exhaustion for other make-ups
- give preference to a pH-controlled process when dyeing with pH-controllable dyes (acid and basic dyes) so that level dyeing is obtained with maximum exhaustion of dyes and insect resist agents and minimum use of organic levelling agents (see Section 4.6.14).

Printing

Process in general

BAT is to:

- reduce printing paste losses in rotary screen printing by:
 - minimising the volume of printing paste supply systems (see 4.7.4)
 - recovering printing paste from the supply system at the end of each run by adopting the technique described in Section 4.7.5
 - recycling residual printing paste (see Section 4.7.6)
- reduce water consumption in cleaning operations by a combination of (see Section 4.7.7):
 - start/stop control of cleaning of the printing belt
 - re-use of the cleanest part of the rinsing water from the cleaning of the squeegees, screens and buckets
 - re-use of the rinsing water from cleaning of the printing belt
- use digital ink-jet printing machines for the production of short runs (less than 100 m) for flat fabrics, when product market considerations allow (see Section 4.7.9). It is not considered BAT to flush with solvent to prevent blocking while the printer is not in use
- use digital jet printing machines described in Section 4.7.8 for printing carpet and bulky fabrics, except for resist and reserve printing and similar situations.

Reactive printing

BAT is to avoid the use of urea by either:

- the one-step process with the controlled addition of moisture, where the moisture is applied either as foam or by spraying a defined quantity of water mist (see Section 4.7.1)

OR

- the two-steps printing method (see 4.7.2).

For silk and viscose, with the one-step process, the spraying technique is not reliable due to the low moisture add-on required for these fibres. The foaming technique with complete elimination of urea is proven for viscose, but not yet for silk. There is a high initial investment cost of about 200000 euros for a foaming machine related to a production capacity of up to about 80000 linear metres per day. The technique has been operated under economically viable conditions in plants of capacity of about 30000, 50000 and 140000 linear metres per day. There is a question whether the technique is economically viable for smaller plants.

Where the foam technique is not used, the amount of urea consumed can be reduced to about 50 g/kg of printing paste for silk and to 80 g/kg for viscose.

Pigment printing

BAT is to use optimised printing pastes that fulfil the following requirements (see 4.7.3):

- thickeners with low-emission of volatile organic carbon (or not containing any volatile solvent at all) and formaldehyde-poor binders. The associated air emission value is <0.4 g Org.-C/kg textile (assuming 20 m³ air/kg textile)
- APEO-free and high degree of biodegradability
- reduced ammonia content. Associated emission value: 0.6 g NH₃/kg textile (assuming 20 m³ air/kg textile).

Finishing

Process in general

BAT is to:

- minimise residual liquor by:
 - using minimal application techniques (e.g. foam application, spraying) or reducing volume of padding devices
 - re-using padding liquors if quality is not affected
- minimise energy consumption in stenter frames by (see Section 4.8.1):
 - using mechanical dewatering equipment to reduce water content of the incoming fabric
 - optimising exhaust airflow through the oven, automatically maintaining exhaust humidity between 0.1 and 0.15 kg water/kg dry air, considering the time taken to reach equilibrium conditions
 - installing heat recovery systems
 - fitting insulating systems
 - ensuring optimal maintenance of the burners in directly heated stenters
- use low air emission optimised recipes. An example for classification/ selection of finishing recipes is the “Emission factor concept” described in Section 4.3.2.

Easy-care treatment

BAT is to use formaldehyde-free cross-linking agents in the carpet sector, and formaldehyde-free or formaldehyde-poor (<0.1 % formaldehyde content in the formulation) cross-linking agents in the textile industry (see 4.8.2).

Mothproofing treatments

- Process in general

BAT is to:

- adopt appropriate measures for material handling as described in Section 4.8.4.1
- ensure that 98 % efficiency (transfer of insect resist agent to the fibre) is achieved
- adopt the following additional measures when the insect resist agent is applied from a dye bath:
 - ensure that a pH<4.5 is reached at the end of the process and if this is not possible, apply the insect resist agent in a separate step with re-use of the bath
 - add the insect resist agent after dye bath expansion in order to avoid overflow spillages
 - select dyeing auxiliaries that do not exert a retarding action on the uptake (exhaustion) of the insect-resist agent during the dyeing process (see Section 4.8.4.1).

- Mothproofing of yarn produced via the dry spinning route

BAT is to use one or both of these techniques (described in Section 4.8.4.2):

- combine acid aftertreatment (to increase the uptake of mothproofing active substance) and re-use of the rinse bath for the next dyeing step
- apply proportional over-treatment of 5 % of the total fibre blend combined with dedicated dyeing machinery and waste water recycling systems to minimise active substance emissions to water.

- Mothproofing of loose fibre dyed / yarn scoured production

BAT is to (see Section 4.8.4.3):

- use dedicated low-volume application systems located at the end of the yarn scouring machine
- recycle low-volume process liquor between batches and use processes designed specifically to remove active substance from spent process liquor. These techniques may include adsorptive or degradative treatments
- apply mothproofing directly to the carpet pile (when mothproofing during carpet manufacture) using foam application technology.

- Mothproofing of yarn dyed production

BAT is to (see Section 4.8.4.4):

- use a separate aftertreatment process to minimise emissions from dyeing processes which are carried out under less than optimum conditions for mothproofing uptake
- use semi-continuous low-volume application machinery or modified centrifuges
- recycle low-volume process liquor between yarn batches and processes designed specifically to remove active substance from spent process liquor. These techniques may include adsorptive or degradative treatments
- apply mothproofing directly to the carpet pile (when mothproofing during carpet manufacture) using foam application technology.

- Softening treatments

BAT is to apply the softening agents by pad mangles or better, by spraying and foaming application systems, instead of carrying out this treatment by exhaustion directly in the batch dyeing machine (see Section 4.8.3).

Washing

BAT is to:

- substitute overflow washing/rinsing with drain/fill methods or “ smart rinsing” techniques as described in Section 4.9.1
- reduce water & energy consumption in continuous processes by:
 - installing high-efficiency washing machinery according to the principle described in Section 4.9.2. The associated values for high-efficiency continuous washing of cellulosic and synthetic fabric in open-width are reported in Table 4.38
 - introducing heat recovery equipment
- when halogenated organic solvent cannot be avoided (e.g. with fabrics that are heavily loaded with preparations such as silicone oils that are difficult to remove with water), use fully closed-loop equipment. It is essential that the equipment fulfil the requirements described in Section 4.9.3 and provisions be taken for in-loop destruction (e.g. by advanced oxidation processes) of the persistent pollutants in order to avoid any possible contamination of groundwater arising from diffuse pollution and accidents.

Waste water treatment

Waste water treatment follows at least three different strategies:

- central treatment in a biological waste water treatment plant on site
- central treatment off site in a municipal waste water treatment plant
- decentralised treatment on site (or off site) of selected, segregated single waste water streams

All three strategies are BAT options when properly applied to the actual waste water situation. Well-accepted general principles for waste water management and treatment include:

- characterising the different waste water streams arising from the process (see Section 4.1.2)
- segregating the effluents at source according to their contaminant type and load, before mixing with other streams. This ensures that a treatment facility receives only those pollutants it can cope with. Moreover, it enables the application of recycling or re-use options for the effluent
- allocating contaminated waste water streams to the most appropriate treatment
- avoiding the introduction of waste water components into biological treatment systems when they could cause malfunction of such a system
- treating waste streams containing a relevant non-biodegradable fraction by appropriate techniques before, or instead of, a final biological treatment.

According to this approach, the following techniques are determined as general BAT for the treatment of waste water from the textile finishing and carpet industry:

- treatment of waste water in an activated sludge system at low food-to-micro organisms ratio as described in Section 4.10.1, under the prerequisite that concentrated streams containing non-biodegradable compounds are pretreated separately
- pretreatment of highly-loaded (COD>5000 mg/l) selected and segregated single waste water streams containing non-biodegradable compounds by chemical oxidation (e.g. Fenton reaction as described in Section 4.10.7). Candidate waste water streams are padding liquors from semi-continuous or continuous dyeing and finishing, desizing baths, printing pastes, residues from carpet backing, exhaust dyeing and finishing baths.

Certain specific process residues, such as residual printing pastes and residual padding liquors are very strong and, where practicable, should be kept out of waste water streams.

These residues should be disposed of appropriately; thermal oxidation can be one suitable method because of the high calorific value.

For the specific cases of waste water containing pigment printing paste or latex from carpet backing, precipitation/flocculation and incineration of the resulting sludge is a viable alternative to chemical oxidation (as described in Section 4.10.8).

For azo-dyes, anaerobic treatment of padding liquor and printing pastes as described in Section 4.10.6 before a subsequent aerobic treatment can be effective for colour removal.

If concentrated water streams containing non-biodegradable compounds cannot be treated separately, additional physical-chemical treatments would be required to achieve equivalent overall performance. These include:

- tertiary treatments following the biological treatment process. An example is adsorption on activated carbon with recycling of the activated carbon to the activated sludge system: this is followed by destruction of the adsorbed non-biodegradable compounds by incineration or treatment with free-radicals (i.e. process generating OH^* , O_2^{*-} , CO_2^{*-}) of the excess sludge (biomass along with the spent activated carbon) (see plant 6 in Section 4.10.1)
- combined biological, physical and chemical treatments with the addition of powdered activated carbon and iron salt to the activated sludge system with reactivation of the excess sludge by “wet oxidation” or “wet peroxidation” (if hydrogen peroxide is used), as described in Section 4.10.3
- ozonation of recalcitrant compounds prior to the activated sludge system (see plant 3 in Section 4.10.1).

For effluent treatment in the wool scouring sector (water-based process)

BAT is to:

- combine the use of dirt removal / grease recovery loops with evaporative effluent treatment, with integrated incineration of the resulting sludge and full recycling of water and energy for: 1) new installations 2) existing installations with no on-site effluent treatment 3) installations seeking to replace life-expired effluent treatment plant. This technique is described in Section 4.4.2
- use coagulation/flocculation treatment in existing mills already using it in conjunction with discharge to sewerage system employing aerobic biological treatment.

Whether or not biological treatment can be considered as BAT must remain an open question until better information on its costs and performance can be assembled.

Sludge disposal

For sludge from waste water treatment of wool scouring effluent

BAT is to:

- use sludge in brick-making (see 4.10.12) or adopt any other appropriate recycling routes
- incinerate the sludge with heat recovery, provided that measures are taken to control emissions of SO_x, NO_x and dust and to avoid emissions of dioxins and furans arising from organically bound chlorine from pesticides potentially contained in the sludge.

CONCLUDING REMARKS

The main general conclusions are:

- the information exchange was successful and a high degree of agreement was reached following the second meeting of the TWG
- due to the nature of the textile industry (very complex and variegated sector) the impact of the implementation of the BAT identified will depend on the characteristics of each mill. The speed of implementation will therefore be a particularly sensitive issue for this industry
- mindful of the current difficulties that certain companies may have in controlling/ selecting the source of the fibre raw material, it was recognised that a quality assurance system for incoming textile material is necessary in order to produce an adequate application for an IPPC permit. BAT is therefore to seek collaboration with upstream partners in the textile chain, not only at site-specific level, but also at industry sector level, in order to create a chain of environmental responsibility for textiles.

The main recommendations for future work are:

- more systematic collection of data is needed about the current consumption and emission levels and about the performance of techniques to be considered in the determination of BAT, especially for water effluents
- a more detailed assessment of the costs and savings associated with techniques is needed to further assist the determination of BAT
- the collection of information about areas that have not been properly covered by the BREF due to a lack of information. More details about specific areas in which data and information are lacking are mentioned in Chapter 7.

The EC is launching and supporting, through its RTD programmes, a series of projects dealing with clean technologies, emerging effluent treatment and recycling technologies and management strategies. Potentially these projects could provide a useful contribution to future BREF reviews. Readers are therefore invited to inform the EIPPCB of any research results which are relevant to the scope of this document (see also the preface of this document).

PREFACE

1. Status of this document

Unless otherwise stated, references to “the Directive” in this document means the Council Directive 96/61/EC on integrated pollution prevention and control. As the Directive applies without prejudice to Community provisions on health and safety at the workplace, so does this document.

This document forms part of a series presenting the results of an exchange of information between EU Member States and industries concerned on best available techniques (BAT), associated monitoring, and developments in them. It is published by the European Commission pursuant to Article 16(2) of the Directive, and must therefore be taken into account in accordance with Annex IV of the Directive when determining “best available techniques”.

2. Relevant legal obligations of the IPPC Directive and the definition of BAT

In order to help the reader understand the legal context in which this document has been drafted, some of the most relevant provisions of the IPPC Directive, including the definition of the term “best available techniques”, are described in this preface. This description is inevitably incomplete and is given for information only. It has no legal value and does not in any way alter or prejudice the actual provisions of the Directive.

The purpose of the Directive is to achieve integrated prevention and control of pollution arising from the activities listed in its Annex I, leading to a high level of protection of the environment as a whole. The legal basis of the Directive relates to environmental protection. Its implementation should also take account of other Community objectives such as the competitiveness of the Community’s industry thereby contributing to sustainable development.

More specifically, it provides for a permitting system for certain categories of industrial installations requiring both operators and regulators to take an integrated, overall look at the polluting and consuming potential of the installation. The overall aim of such an integrated approach must be to improve the management and control of industrial processes so as to ensure a high level of protection for the environment as a whole. Central to this approach is the general principle given in Article 3 that operators should take all appropriate preventative measures against pollution, in particular through the application of best available techniques enabling them to improve their environmental performance.

The term “best available techniques” is defined in Article 2(11) of the Directive as “the most effective and advanced stage in the development of activities and their methods of operation which indicate the practical suitability of particular techniques for providing in principle the basis for emission limit values designed to prevent and, where that is not practicable, generally to reduce emissions and the impact on the environment as a whole.” Article 2(11) goes on to clarify further this definition as follows:

“techniques” includes both the technology used and the way in which the installation is designed, built, maintained, operated and decommissioned;

“available” techniques are those developed on a scale which allows implementation in the relevant industrial sector, under economically and technically viable conditions, taking into consideration the costs and advantages, whether or not the techniques are used or produced inside the Member State in question, as long as they are reasonably accessible to the operator;

“best” means most effective in achieving a high general level of protection of the environment as a whole.

Furthermore, Annex IV of the Directive contains a list of “considerations to be taken into account generally or in specific cases when determining best available techniques ... bearing in mind the likely costs and benefits of a measure and the principles of precaution and prevention”. These considerations include the information published by the Commission pursuant to Article 16(2).

Competent authorities responsible for issuing permits are required to take account of the general principles set out in Article 3 when determining the conditions of the permit. These conditions must include emission limit values, supplemented or replaced where appropriate by equivalent parameters or technical measures. According to Article 9(4) of the Directive, these emission limit values, equivalent parameters and technical measures must, without prejudice to compliance with environmental quality standards, be based on the best available techniques, without prescribing the use of any technique or specific technology, but taking into account the technical characteristics of the installation concerned, its geographical location and the local environmental conditions. In all circumstances, the conditions of the permit must include provisions on the minimisation of long-distance or transboundary pollution and must ensure a high level of protection for the environment as a whole.

Member States have the obligation, according to Article 11 of the Directive, to ensure that competent authorities follow or are informed of developments in best available techniques.

3. Objective of this Document

Article 16(2) of the Directive requires the Commission to organise “an exchange of information between Member States and the industries concerned on best available techniques, associated monitoring and developments in them”, and to publish the results of the exchange.

The purpose of the information exchange is given in recital 25 of the Directive, which states that “the development and exchange of information at Community level about best available techniques will help to redress the technological imbalances in the Community, will promote the world-wide dissemination of limit values and techniques used in the Community and will help the Member States in the efficient implementation of this Directive.”

The Commission (Environment DG) established an information exchange forum (IEF) to assist the work under Article 16(2) and a number of technical working groups have been established under the umbrella of the IEF. Both IEF and the technical working groups include representation from Member States and industry as required in Article 16(2).

The aim of this series of documents is to reflect accurately the exchange of information which has taken place as required by Article 16(2) and to provide reference information for the permitting authority to take into account when determining permit conditions. By providing relevant information concerning best available techniques, these documents should act as valuable tools to drive environmental performance.

4. Information Sources

This document represents a summary of information collected from a number of sources, including in particular the expertise of the groups established to assist the Commission in its work, and verified by the Commission services. All contributions are gratefully acknowledged.

5. How to understand and use this document

The information provided in this document is intended to be used as an input to the determination of BAT in specific cases. When determining BAT and setting BAT-based permit conditions, account should always be taken of the overall goal to achieve a high level of protection for the environment as a whole.

The rest of this section describes the type of information that is provided in each section of the document.

Chapters 1 and 2 provide general information on the industrial sector concerned and on the industrial processes used within the sector. Chapter 3 provides data and information concerning current emission and consumption levels reflecting the situation in existing installations at the time of writing.

Chapter 4 describes in more detail the emission reduction and other techniques that are considered to be most relevant for determining BAT and BAT-based permit conditions. This information includes the consumption and emission levels considered achievable by using the technique, some idea of the costs and the cross-media issues associated with the technique, and the extent to which the technique is applicable to the range of installations requiring IPPC permits, for example new, existing, large or small installations. Techniques that are generally seen as obsolete are not included.

Chapter 5 presents the techniques and the emission and consumption levels that are considered to be compatible with BAT in a general sense. The purpose is thus to provide general indications regarding the emission and consumption levels that can be considered as an appropriate reference point to assist in the determination of BAT-based permit conditions or for the establishment of general binding rules under Article 9(8). It should be stressed, however, that this document does not propose emission limit values. The determination of appropriate permit conditions will involve taking account of local, site-specific factors such as the technical characteristics of the installation concerned, its geographical location and the local environmental conditions. In the case of existing installations, the economic and technical viability of upgrading them also needs to be taken into account. Even the single objective of ensuring a high level of protection for the environment as a whole will often involve making trade-off judgements between different types of environmental impact, and these judgements will often be influenced by local considerations.

Although an attempt is made to address some of these issues, it is not possible for them to be considered fully in this document. The techniques and levels presented in Chapter 5 will therefore not necessarily be appropriate for all installations. On the other hand, the obligation to ensure a high level of environmental protection including the minimisation of long-distance or transboundary pollution implies that permit conditions cannot be set on the basis of purely local considerations. It is therefore of the utmost importance that the information contained in this document is fully taken into account by permitting authorities.

Since the best available techniques change over time, this document will be reviewed and updated as appropriate. All comments and suggestions should be made to the European IPPC Bureau at the Institute for Prospective Technological Studies at the following address:

Edificio Expo, Inca Garcilaso s/n, E-41092 Seville, Spain
Telephone: +34 95 4488 284
Fax: +34 95 4488 426
e-mail: eippcb@jrc.es
Internet: <http://eippcb.jrc.es>

Reference Document on Best Available Techniques for the Textiles Industry

EXECUTIVE SUMMARY	I
PREFACE	XXI
SCOPE	XXXVII
1 GENERAL INFORMATION	1
1.1 Wool scouring sector	3
1.1.1 Sector organisation	3
1.1.2 Production and economics.....	3
1.2 Textile finishing sector (excluding floor covering)	5
1.2.1 Sector organisation	5
1.2.2 Production and economics.....	6
1.3 Carpet	7
1.3.1 Sector organisation	7
1.3.2 Production and economics.....	9
1.4 Main environmental issues	11
2 APPLIED PROCESSES AND TECHNIQUES	15
2.1 Raw materials	16
2.1.1 Fibres.....	16
2.1.2 Chemicals & auxiliaries	21
2.1.3 Materials handling and storage.....	22
2.2 Fibre manufacturing: chemical (man-made) fibres.....	22
2.3 Fibre preparation: natural fibres	24
2.3.1 Wool.....	24
2.3.2 Cotton and flax	34
2.3.3 Silk	34
2.4 Yarn manufacturing	34
2.4.1 The wool spinning process	34
2.4.2 The cotton spinning process	34
2.4.3 Environmental issues.....	35
2.5 Cloth production	35
2.5.1 Woven textiles.....	36
2.5.2 Knitted textiles	37
2.5.3 Textile floor-coverings	37
2.5.4 Non-woven textiles	40
2.6 Pretreatment.....	41
2.6.1 Pretreatment of cotton & cellulose fibres	41
2.6.2 Wool preparation before colouring	49
2.6.3 Pretreatment of silk	53
2.6.4 Pretreatment of synthetic material.....	56
2.7 Dyeing	57
2.7.1 General principles of dyeing	57
2.7.2 Dyeing processes.....	58
2.7.3 Cellulose fibres dyeing.....	61
2.7.4 Wool dyeing.....	67
2.7.5 Silk dyeing	69
2.7.6 Synthetic fibres dyeing.....	69
2.7.7 Fibre blends dyeing	73
2.7.8 Environmental issues.....	77
2.8 Printing	86
2.8.1 Printing processes.....	86
2.8.2 Printing technology	90
2.8.3 Environmental issues.....	96
2.9 Finishing (functional finishing)	99
2.9.1 Finishing processes	99
2.9.2 Chemical finishing treatments.....	100
2.9.3 Environmental issues.....	103
2.10 Coating and laminating.....	105

2.10.1	Coating and laminating processes.....	105
2.10.2	Environmental issues.....	106
2.11	Carpet back-coating.....	107
2.12	Washing.....	113
2.12.1	Washing with water.....	113
2.12.2	Dry cleaning.....	113
2.13	Drying.....	115
2.13.1	Loose fibre drying.....	116
2.13.2	Hanks drying.....	116
2.13.3	Yarn packages drying.....	117
2.13.4	Fabric drying.....	117
2.14	Textiles industry categories.....	119
2.14.1	Wool Scouring Mills.....	120
2.14.2	Mills finishing yarn and/or floc.....	120
2.14.3	Mills finishing knitted fabric.....	121
2.14.4	Mills finishing woven fabric.....	123
2.14.5	The Carpet industry.....	126
3	EMISSION AND CONSUMPTION LEVELS.....	137
3.1	Introduction.....	137
3.2	Wool scouring mills.....	137
3.2.1	Cleaning and washing with water.....	137
3.2.2	Cleaning and washing with solvent.....	152
3.3	Textile finishing industry.....	153
3.3.1	Mills finishing yarn and/or floc.....	153
3.3.2	Mills finishing knitted fabric.....	162
3.3.3	Mills finishing woven fabric.....	176
3.4	Carpet industry.....	207
3.4.1	Wool and wool-blend carpet yarn dyehouses.....	207
3.4.2	Integrated carpet manufacturing companies.....	217
3.5	General issues concerning odour nuisances in the textile industry.....	223
3.6	General issues concerning solid & liquid wastes generated in the textile industry.....	224
4	TECHNIQUES TO CONSIDER IN THE DETERMINATION OF BAT.....	227
4.1	General good management practices.....	227
4.1.1	Management and good housekeeping.....	227
4.1.2	Input/output streams evaluation/inventory.....	231
4.1.3	Automated preparation and dispensing of chemicals.....	236
4.1.4	Optimising water consumption in textile operations.....	239
4.1.5	Insulation of High Temperature (HT) machines.....	242
4.2	Quality management of incoming fibre.....	243
4.2.1	Man-made fibre preparation agents with improved environmental performance.....	243
4.2.2	Mineral oils substitution in wool spinning lubricants.....	246
4.2.3	Mineral oils substitution in knitted fabric manufacturing.....	247
4.2.4	Selection of sizing agents with improved environmental performance.....	249
4.2.5	Minimising sizing agent add-on by pre-wetting the warp yarns.....	253
4.2.6	Use of techniques that allow reduced load of sizing agents on the fibre (compact spinning).....	254
4.2.7	Minimising residues of organochlorine ectoparasiticides in the raw material by substitution.....	256
4.2.8	Minimising residues of organophosphate and synthetic pyrethroid ectoparasiticides in the raw material by substitution.....	258
4.3	Selection/ substitution of chemicals used.....	260
4.3.1	Selection of textile dyes and auxiliaries according to their waste water relevance.....	260
4.3.2	Emission factor concept (emissions to air).....	262
4.3.3	Substitution for alkylphenol ethoxylates (and other hazardous surfactants).....	264
4.3.4	Selection of biodegradable/bioeliminable complexing agents in pretreatment and dyeing processes.....	267
4.3.5	Selection of antifoaming agents with improved environmental performance.....	270
4.4	Wool scouring.....	272
4.4.1	Use of integrated dirt removal/grease recovery loops.....	272
4.4.2	Use of integrated dirt removal/grease recovery loops combined with evaporation of the effluent and incineration of the sludge.....	275

4.4.3	Minimising energy consumption in wool scouring installations	280
4.4.4	Wool scouring with organic solvent	282
4.5	Pretreatment	283
4.5.1	Recovery of sizing agents by ultrafiltration	283
4.5.2	Application of the oxidative route for efficient, universal size removal	288
4.5.3	One-step desizing, scouring and bleaching of cotton fabric	290
4.5.4	Enzymatic scouring	291
4.5.5	Substitution for sodium hypochlorite and chlorine-containing compounds in bleaching operations	293
4.5.6	Minimising consumption of complexing agents in hydrogen peroxide bleaching	295
4.5.7	Recovery of alkali from mercerising	298
4.5.8	Optimisation of cotton warp yarn pretreatment	300
4.6	Dyeing	302
4.6.1	Exhaust dyeing of polyester and polyester blends with carrier-free dyeing techniques or with use of environmentally optimised carriers	302
4.6.2	Use of non-carrier dyeable PES fibres	304
4.6.3	Dispersing agents with higher bioeliminability in dye formulations	306
4.6.4	One-step continuous vat dyeing in pastel to pale shades	308
4.6.5	Aftertreatment in PES dyeing	309
4.6.6	Dyeing with sulphur dyes	313
4.6.7	Minimisation of dye liquor losses in pad dyeing techniques	315
4.6.8	Enzymatic after-soaping in reactive dyeing	317
4.6.9	Silicate-free fixation method for cold pad batch dyeing	318
4.6.10	Exhaust dyeing of cellulosic fibres with high-fixation polyfunctional reactive dyestuffs	320
4.6.11	Exhaust dyeing with low-salt reactive dyes	323
4.6.12	Omitting the use of detergents in afterwashing of cotton dyed with reactive dyes	324
4.6.13	Alternative process for continuous (and semicontinuous) dyeing of cellulosic fabric with reactive dyes	326
4.6.14	pH-controlled dyeing techniques	329
4.6.15	Low-chrome and ultra-low-chrome afterchroming methods for wool	332
4.6.16	Chromium-free dyeing of wool	335
4.6.17	Emission reduction in dyeing wool with metal-complex dyestuffs	340
4.6.18	Use of liposomes as auxiliaries in wool dyeing	342
4.6.19	Equipment optimisation in batch dyeing	343
4.6.20	Equipment optimisation applied to winch beck dyeing machines	346
4.6.21	Equipment optimisation applied to jet dyeing machines	348
4.6.22	Water re-use/recycling in batch dyeing processes	355
4.7	Printing	357
4.7.1	Urea substitution and/or reduction in reactive printing	357
4.7.2	Reactive two-step printing	359
4.7.3	Pigment printing pastes with optimised environmental performance	360
4.7.4	Volume minimisation of printing paste supply systems in rotary screen printing machines	362
4.7.5	Recovery of printing paste from supply system in rotary screen printing machines	364
4.7.6	Recycling of residual printing pastes	366
4.7.7	Reduction of water consumption in cleaning operations	368
4.7.8	Digital jet printing of carpet and bulky fabric	370
4.7.9	Ink-jet digital printing for flat fabric	371
4.8	Finishing	373
4.8.1	Minimisation of energy consumption of stenter frames	373
4.8.2	Formaldehyde-free or formaldehyde-poor easy-care finishing agents	376
4.8.3	Avoiding batch softening	379
4.8.4	Minimisation of emissions in the application of mothproofing agents	380
4.9	Washing	394
4.9.1	Water & energy conservation in batch washing and rinsing	394
4.9.2	Water & energy conservation in continuous washing and rinsing	397
4.9.3	Use of fully closed-loop installations for fabric washing (scouring) with organic solvent	399
4.10	Final effluent/emission abatement techniques	405
4.10.1	Treatment of textile waste water in activated sludge system with low food-to-micro organisms ratio (F/M)	405
4.10.2	Treatment of mixed waste water with about 60 % water recycling	414

4.10.3	Combined biological physical and chemical treatment of mixed waste water effluent ..	419
4.10.4	Recycling of textile waste water by treatment of selected streams with membrane techniques	422
4.10.5	Treatment and recovery of waste water containing pigment paste	425
4.10.6	Anaerobic removal of residual dyestuff from padding liquors and printing paste residues	426
4.10.7	Treatment of selected and segregated, non-biodegradable waste water stream by chemical oxidation	428
4.10.8	Waste water treatment by flocculation/precipitation and incineration of the resulting sludge.....	430
4.10.9	Air emission abatement techniques	431
4.10.10	Waste water treatment in wool scouring installations.....	434
4.10.11	Disposal of wool scouring sludge to agricultural land.....	440
4.10.12	Use of wool scour sludge in brick-making	442
5	BEST AVAILABLE TECHNIQUES	445
5.1	Generic BAT (whole textile industry).....	446
5.2	Process-integrated measures for unit processes and operations	449
5.2.1	Wool scouring.....	449
5.2.2	Textile finishing and carpet industry	450
5.3	Effluent treatment and waste disposal	456
6	EMERGING TECHNIQUES	459
7	CONCLUDING REMARKS.....	465
7.1	Timing of the work.....	465
7.2	Source of information.....	465
7.3	Level of consensus	465
7.4	Recommendations for future work.....	466
7.5	Suggested topics for future R & D projects.....	467
	REFERENCES.....	469
	GLOSSARY	475
8	ANNEX I TEXTILE AUXILIARIES.....	481
8.1	Surfactants.....	481
8.2	Auxiliaries and finishing agents for fibre and yarn manufacturing	482
8.2.1	Spinning solution additives, spinning additives and spinning bath additives	486
8.2.2	Preparation agents for primary spinning	486
8.2.3	Preparation agents for secondary spinning (conditioning agents and spinning lubricants)	488
8.2.4	Coning oils, warping and twisting oils.....	489
8.2.5	Knitting oils	489
8.3	Sizing agents	490
8.4	Detergents/ wetting agents	493
8.5	Auxiliaries containing sequestering agents	494
8.6	Dyeing auxiliaries	494
8.6.1	General characteristics and environmental aspects.....	494
8.6.2	Wetting, penetrating and de-aerating agents.....	495
8.6.3	Dispersing agents.....	495
8.6.4	Levelling agents.....	496
8.6.5	Acid donors.....	497
8.6.6	Antifoaming agents.....	497
8.6.7	Carriers	497
8.7	Printing auxiliaries	498
8.7.1	Auxiliaries for dye printing.....	498
8.7.2	Auxiliaries for pigment printing	498
8.8	Finishing auxiliaries.....	499
8.8.1	Easy-care finishing agents	499
8.8.2	Biocides	501
8.8.3	Antistatic agents.....	501
8.8.4	Flame-retardants	502
8.8.5	Hydrophobic/ Oleophobic agents	506

8.8.6	Softeners.....	508
8.9	Coating compounds and auxiliaries.....	509
9	ANNEX II DYES AND PIGMENTS	511
9.1	Acid dyes.....	511
9.2	Basic (cationic) dyes.....	513
9.3	Direct (substantive) dyes.....	515
9.4	Disperse dyes.....	517
9.5	Metal-complex dyes.....	518
9.6	Mordant dyes (chrome dyes).....	520
9.7	Naphthol dyes (azoic dyes developed on the fibre).....	522
9.8	Reactive dyes.....	525
9.9	Sulphur dyes.....	529
9.10	Vat dyes.....	531
9.11	Pigments.....	534
10	ANNEX III WET PROCESSES: MACHINERY AND TECHNIQUES.....	535
10.1	Loose fibre.....	535
10.1.1	Autoclave.....	535
10.2	Yarn.....	536
10.2.1	Hank dyeing machines.....	536
10.2.2	Package dyeing machines.....	537
10.3	Fabric in rope form.....	538
10.3.1	Batch processes.....	538
10.3.2	Continuous processes.....	542
10.4	Fabric in open-width.....	543
10.4.1	Batch processes.....	543
10.4.2	Semi-continuous and continuous processes.....	544
11	ANNEX IV: TYPICAL RECIPES (WITH SOME ASSOCIATED EMISSION FACTOR) IN THE TEXTILE SECTOR.....	549
11.1	Pretreatment.....	549
11.1.1	Cotton and cotton blends.....	549
11.1.2	Viscose.....	555
11.1.3	Man-made fibres (woven and knit fabric).....	556
11.1.4	Wool.....	557
11.2	Dyeing.....	560
11.3	Printing.....	561
11.4	Finishing.....	561
12	ANNEX V: TYPICAL POLLUTANTS (AND POTENTIAL SOURCES) IN AIR EMISSIONS FROM TEXTILE PROCESSES	569
13	ANNEX VI: AUXILIARIES CLASSIFICATION TOOLS	571
13.1	Tegewa scheme.....	571
13.2	SCORE System.....	574
13.3	Dutch General Policy Scheme.....	578
14	ADVANCED OXIDATION PROCESSES (FENTON REACTION).....	585

List of tables

Table 1.1: Share of the EU-15 textile-clothing industry in the manufacturing industry (only companies with 20 employees or more).....	1
Table 1.2: Country breakdown of the EU-15 textile and clothing industry in 2000	2
Table 1.3: Wool production and wool scouring production in EU Member States.....	4
Table 1.4: Basic structure of the carpet manufacturing industry.....	8
Table 1.5: Sector Location and number of trading entities within the EU	9
Table 1.6: Main charging loads from textile industry in Europe.....	11
Table 2.1: Chemical composition of cotton fibre.....	21
Table 2.2: Discontinuous dyeing equipment and liquor ratios.....	60
Table 2.3: Semi-continuous and continuous dyeing processes and equipment.....	61
Table 2.4: Salt concentration required for reactive dyes.....	62
Table 2.5: Summary of the most common dyestuffs and dyeing techniques applied for cellulose fibres..	66
Table 2.6: Summary of the most common dyestuffs and dyeing techniques for wool fibre	68
Table 2.7: Summary of the most common dyestuffs and dyeing techniques for polyamide fibres.....	70
Table 2.8: Summary of the most common dyestuffs and dyeing techniques for polyester fibres.....	71
Table 2.9: Summary of the most common dyestuffs and dyeing techniques for polyacrylic fibres.....	72
Table 2.10: Summary of dyestuff and dyeing techniques for polyester-cellulose blends	74
Table 2.11: Overview of the typical emissions generated in dyeing processes.....	77
Table 2.12: Percentage of non-fixed dye that may be discharged in the effluent for the principal classes of dyes	78
Table 2.13: List of carcinogenic amines	81
Table 2.14: Ecological properties of dye formulations additives	82
Table 2.15: Proportion of additives and dye in powder and liquid dyes	82
Table 2.16: Amount of salt employed in cotton batch dyeing processes with reactive and direct dyes.....	84
Table 2.17: Pollutants that are more likely to be encountered in waste water from printing processes	98
Table 3.1: Wool scouring process mass streams overview (fine wool)	138
Table 3.2: Wool scouring process mass streams overview (coarse wool).....	139
Table 3.3: Wool scouring process mass streams overview (extra fine wool).....	140
Table 3.4: Overview of effluent treatment processes and associated output of COD and sludge	146
Table 3.5: Average organochlorine, organophosphate and synthetic pyrethroid biocide content of the wools processed by 12 scourers	148
Table 3.6: Performance of effluent treatment plants in removing wool grease, COD, suspended solids and ectoparasiticides from wooll scour effluent.....	149
Table 3.7: Sheep treatment chemical residues in incoming greasy wool and in scouring effluent discharged to sewer at six mills.....	149
Table 3.8: Estimated process input and output in the Wooltech cleaning system.....	152
Table 3.9: Concentration values and textile substrate specific emission factors for waste water from two mills mainly finishing floc material consisting of CV, PES, PAC or CO	154
Table 3.10: Overview of consumption and emission levels from four mills finishing WO tops/yarn	155
Table 3.11: Concentration values and textile substrate specific emission factors for waste water from four mills mainly finishing yarns consisting of CO	156
Table 3.12: Concentration values and textile substrate specific emission factors for waste water from eight mills mainly finishing yarns consisting of PES.....	157
Table 3.13: Concentration values and textile substrate specific emission factors for waste water from seven mills mainly finishing yarns consisting of WO/PAC/CV	159
Table 3.14: Sequence of discharged baths from exhaust dyeing of CV yarn with reactive dyestuffs along with values for COD, pH, conductivity, temperature and colour (spectral absorption coefficients, SAC)	160
Table 3.15: Sequence of discharged baths from exhaust dyeing of PES yarn with disperse dyestuffs along with values for COD, pH, conductivity, temperature and colour (spectral absorption coefficients, SAC)	160
Table 3.16: Sequence of discharged baths from exhaust dyeing of CO yarn with vat dyestuffs along with values for COD, pH, conductivity, temperature and colour (spectral absorption coefficients, SAC).....	161
Table 3.17: Water & energy consumption levels in loose fibre dyeing processes	162
Table 3.18: Water & energy consumption levels in yarn dyeing processes	162
Table 3.19: Concentration values and textile substrate specific emission factors for waste water from seventeen mills mainly finishing knitted fabric consisting of cotton	164

Table 3.20: Concentration values and textile substrate specific emission factors for waste water from twelve mills finishing knitted fabric consisting mainly of CO with a significant printing section	166
Table 3.21: Concentration values and textile substrate specific emission factors for waste water from mills finishing knitted fabric consisting mainly of synthetic fibres.....	168
Table 3.22: Concentration values and textile substrate specific emission factors for waste water from one mill finishing knitted fabric mainly consisting of wool.....	169
Table 3.23: Typical recipe for the continuous bleaching/washing of cotton knitted fabric.....	170
Table 3.24: Consumption of chemicals and associated COD values for a continuous pretreatment process (bleaching/washing) of cotton knit fabric	171
Table 3.25: Data for COD, pH and L for exhausted bleaching bath and rinsing water from pre- and full-bleaching with H ₂ O ₂ of cotton knitted fabric; the specific waste water flow for the whole process including rinsing is 30 - 50 l/kg	172
Table 3.26: Data for COD, AOX, pH and conductivity for exhausted bleaching bath and rinsing water from combined bleaching of cotton knit fabric with NaOCl/H ₂ O ₂ (L.R. = 1:15) – “ITV, 1992”; the overall specific waste water flow (for the whole process including rinsing is 30 - 50 l/kg)	172
Table 3.27: Typical input factors for exhaust dyeing of cotton knitted fabric with reactive dyestuffs.....	173
Table 3.28: Sequence of discharged baths from exhaust dyeing (light shade) of cotton knitted fabric with reactive dyestuffs along with values for COD, pH, conductivity and colour (spectral absorption coefficients, SAC) L.R. = 1:25; specific water consumption for the whole process: 142 l/kg (including water consumed when loading the material and direct cooling after dyeing).....	174
Table 3.29: Sequence of emitted baths from exhaust dyeing (dark shade) of cotton knit fabric with reactive dyestuffs along with values for COD, pH, conductivity and colour (spectral absorption coefficients, SAC) L.R. = 1:8.2; specific water consumption for the whole process: 71 l/kg .	174
Table 3.30: Sequence of discharged baths from exhaust dyeing of cotton knitted fabric with direct dyestuffs (light shade) along with values for COD, AOX, pH, conductivity and colour (spectral absorption coefficients, SAC).....	174
Table 3.31: Sequence of discharged baths from exhaust dyeing of cotton knitted fabric with sulphur dyestuffs (dark shade) along with values for COD, AOX, pH, conductivity and colour (spectral absorption coefficients, SAC).....	175
Table 3.32: Typical input and calculated output factors for exhaust dyeing of PES knitted fabric with disperse dyestuffs.....	175
Table 3.33: Concentration values and textile substrate specific emission factors for waste water from mills mainly finishing woven fabric consisting mainly of CO	180
Table 3.34: Concentration values and textile substrate specific emission factors for waste water from mills mainly finishing woven fabric consisting mainly of CO, with a significant printing section..	182
Table 3.35: Concentration values and textile substrate specific emission factors for waste water from six mills finishing woven fabric consisting mainly of wool.....	183
Table 3.36: Concentration values and textile substrate specific emission factors for waste water from six mills finishing woven fabric consisting mainly of synthetic fibres	185
Table 3.37: Data on emissions to air from singeing facilities in five textile finishing mills.....	187
Table 3.38: Possible sources of air emissions during heat-setting of grey fabrics or inefficiently washed fabrics	188
Table 3.39: Heat-setting: process specific emission data (measured values)	191
Table 3.40: Specific input for water, steam and chemicals in a modern continuous pretreatment line, including desizing, scouring (padding of scouring liquor, steam treatment, washing, drying), bleaching (padding of the bleaching liquor, steaming, washing and drying).....	194
Table 3.41: Air emission data from drying and fixation after printing (measurements carried out at two finishing mills).....	197
Table 3.42: Standard recipe for the finishing of cotton woven fabric with reactive non-iron compounds	197
Table 3.43: Typical finishing recipe for crease and shrink resistance	198
Table 3.44: Two examples for the calculation of air emission factors	199
Table 3.45: Thermal treatments after finishing treatments: process-specific emission data (measured data)	202
Table 3.46: Air emission factors from drying carrier-dyed textiles.....	203
Table 3.47: Air emission levels during drying/fixation of carrier-dyed fabrics.....	204
Table 3.48: Emission values from perchloroethylene-cleaned fabrics	205
Table 3.49: Air emission data from coating (measurements carried out in five finishing mills).....	206
Table 3.50: Overview of emission and consumption levels for three typical loose fibre dyehouses.....	208
Table 3.51: Concentrations of compounds present on raw loose fibres, which contribute to the waste water COD load	209

Table 3.52: Annual average pesticide content of scoured wool processed at six reference sites	211
Table 3.53: Overview of emission and consumption levels for four typical carpet yarn dyehouses.....	212
Table 3.54: Literature values for practical energy requirements in yarn dyeing.....	213
Table 3.55: Concentration of compounds present on raw fibre, which contribute to the waste water load	214
Table 3.56: Concentration values and textile substrate-specific emission factors for waste water from two carpet finishing mills.....	217
Table 3.57: Overview of the composition of the off gases of two typical carpet backing lines (textile backing and foam backing). Analysis was performed by GC/MS	219
Table 3.58: Example of process-specific emission data (measured data) from carpet baking lines.....	222
Table 3.59: Odour-intensive substances in the textile industry	223
Table 3.60: Typical examples of odour concentrations in some textile processes (OU: odour unit)	224
Table 3.61: Solid and liquid wastes from textile industry.....	225
Table 4.1: Form for the listing of textile auxiliaries for dyeing and printing.....	233
Table 4.2: Payback periods for heat insulation of dyeing units.....	243
Table 4.3: Emission factors and corresponding organic-C concentration in the off-gas.....	244
Table 4.4: COD reduction after replacement of conventional sizing agent by alternative recipe based on polyacrylates	251
Table 4.5: Comparison between conventional and high-efficiency sizing agents.....	252
Table 4.6: Organochlorine pesticide concentrations in the River Calder below Dewsbury Sewage Treatment Works (UK). Data for 2 years to June 2000.....	257
Table 4.7: Textile auxiliaries sold in Germany from 1997 to 2000: number, quantity and percentage of textile auxiliaries in classes I, II, III, according to TEGEWA.....	261
Table 4.8: Qualitative assessment of commercially available complexing agents.....	268
Table 4.9: Effectiveness of complexing agents.....	269
Table 4.10: Estimate of the economic benefits achievable with the installation of integrated dirt removal/ grease recovery loops.....	274
Table 4.11: Emissions to water at Mill N, 1982-1995: production specific values.....	278
Table 4.12: Incinerator flue gas emissions at Mill N: concentrations	278
Table 4.13: Solid wastes at Mill N, 1982-1995: production-specific values.....	278
Table 4.14: Energy savings from operating the last bowl at optimum temperature (65°C).....	281
Table 4.15: Typical example of annual savings achievable when introducing recovery of sizing agents.....	287
Table 4.16: Environmental benefits achieved with an enzymatic scouring process.....	291
Table 4.17: Optimisation of warp yarn scouring/bleaching: absolute and specific water consumption and waste water discharge before and after process optimisation.....	300
Table 4.18: Optimisation of warp yarn scouring/bleaching: recipe and operating conditions for the optimised process.....	301
Table 4.19: Sulphur and sulphite concentration and load in the mixed effluent from typical processes using sodium dithionite or sulphinic acid based reducing agents.....	311
Table 4.20: Comparison of the sequence steps between a conventional and an enzymatic after-soaping treatment (exhaust dyeing).....	317
Table 4.21: Quantities of salt required for dyeing 1000 kg of fabric to a medium depth of shade	323
Table 4.22: Comparison between a conventional pad-batch process and the referenced technique applied to mercerised 100 % cotton twill, 300 g/m, 75 % pick-up	329
Table 4.23: Composition and ecological information of six commercial reactive dyestuffs for wool.....	335
Table 4.24: Composition and ecological information of two auxiliaries to be applied with "Lanasol Dyes"	336
Table 4.25: Comparative analysis of the features of chrome dyes and reactive dyes for wool dyeing	336
Table 4.26: Assessment of the economic aspects involved when changing over from chrome to reactive dyes	339
Table 4.27: Environmental benefit associated with optimisation of batch dyeing machines.....	345
Table 4.28: Comparison of specific input data for cotton dyeing with reactive dyestuffs in a conventional jet (L.R. 1:8 – 1:12) and in the airflow machine described above.....	350
Table 4.29: Comparison of the performance for cotton dyeing with reactive dyestuffs in a conventional machine, a "new generation machine" (typified by having charge tanks, pumped drain & fill options and continuous rinsing systems) and the referenced soft-flow machine.....	352
Table 4.30: Comparison of the performance for cotton dyeing with reactive dyestuffs in a conventional machine (L.R. 1:10 – 1:12), a "new generation machine" (L.R. 1:8 and equipped with latest time-saving devices) and the single-rope machine described above (L.R. 1:6)	354
Table 4.31: Volatile organic carbon emissions in pigment printing.....	361
Table 4.32: Volume of conventional and optimised printing paste supply systems in rotary screen printing machines for textiles.....	362

Table 4.33: Amount of printing paste required for printing various lengths of fabric at different degrees of coverage.....	363
Table 4.34: Calculation of savings achievable in a typical textile mill by installing the referenced printing paste recovery system (the number of changes as well as the number of printing pastes per design may be higher in industrial practice).....	366
Table 4.35: Return on investment for different processes (textiles drying and heat setting), heat recovery systems (air/water and air/air) and number of shifts per day.....	375
Table 4.36: Overview of formaldehyde release potential of most important cross-linking agents.....	377
Table 4.37: Indicative emissions from loose fibre dyeing.....	383
Table 4.38: Achievable specific water consumption levels for continuous washing processes during finishing of open width woven fabric consisting of cotton or viscose and their blends with synthetic fibres.....	398
Table 4.39: Consumption data: aqueous system and solvent system.....	404
Table 4.40: Hourly cost figures: aqueous system and solvent system.....	404
Table 4.41: Characteristics of waste water parameters (input and output) for six treatment plants.....	413
Table 4.42: Typical characteristics of the different water streams (mean values) at the treatment plant Schiesser, D-Niederfrohna.....	417
Table 4.43: Measures emission values: off-gas from the thermal regeneration plant.....	417
Table 4.44: Elemental analysis of fresh and regenerated lignite coke.....	418
Table 4.45: Capital and operating costs of the Schiesser plant; costs are calculated for the design flow of 2500 m ³ /d and 600000m ³ /yr, respectively.....	418
Table 4.46: Waste water treatment techniques: Environmental performance – coarse wool.....	435
Table 4.47: Waste water treatment techniques: Environmental performance – fine wool.....	436
Table 4.48: Unit costs.....	438
Table 4.49: Costs of effluent treatment options for a scouring mill processing 3500 t/yr of coarse wool.....	439
Table 4.50: Costs of effluent treatment options for a scouring mill processing 15000 t/yr of coarse wool.....	439
Table 4.51: Composting and maturation times, capital and treatment costs, for three types of in-vessel composting plant.....	442
Table 5.1: BAT for selection of incoming fibre raw material.....	448
Table 6.1: Enzymatic processes in textile finishing.....	459
Table 8.1: Overview of the loads of auxiliary agents applied on the fibre and yarn during the production process.....	485
Table 8.2: Load of preparation agents on non-texturised filament yarns (flat yarns).....	486
Table 8.3: Load of preparation agents applied on texturised filament yarns (texturised yarns).....	487
Table 8.4: Load of preparation agents applied on chemical staple fibres.....	487
Table 8.5: Load of conditioning agents and lubricants applied on cotton, viscose (staple fibres) and wool.....	489
Table 8.6: Amounts of sizing agents applied on different types of substrates.....	492
Table 8.7: Specific COD and BOD ₅ values for the most common sizing agents.....	493
Table 8.8: Typical compounds used as detergents/ wetting agents.....	493
Table 8.9: Typical compounds encountered in levelling agents.....	496
Table 9.1: Overview of the ecological properties of acid dyes.....	513
Table 9.2: Overview of the ecological properties of direct dyes.....	516
Table 9.3: Overview of the ecological properties of disperse dyes.....	518
Table 9.4: Overview of the ecological properties of metal complex dyes.....	520
Table 9.5: Overview of the ecological properties of chrome dyes.....	522
Table 9.6: Overview of the ecological properties of naphthol dyes.....	525
Table 9.7: Typical anchor systems for cellulose fibres.....	526
Table 9.8: Typical anchor systems for wool and polyamide fibres.....	527
Table 9.9: Overview of the ecological properties of reactive dyes.....	529
Table 9.10: Overview of the ecological properties of sulphur dyes.....	531
Table 9.11: Overview of the ecological properties of vat dyes.....	534

List of figures

Figure 1.1: Estimates of the amounts of greasy wool scoured during 1997 in the 15 EU Member States ...	5
Figure 1.2: EU Textile Finishing Production	6
Figure 1.3: Worldwide production of carpets and rugs in 1999	9
Figure 1.4: Carpet production and consumption in some EU Member States	10
Figure 1.5: European carpet and rug production in 1995 for the major producers of carpets and rugs in Europe	10
Figure 1.6: Total carpet and rug production in Europe in 1995	10
Figure 1.7: Auxiliaries pattern usage in a typical finishing mill	12
Figure 2.1: General diagram of processes in the textile industry	15
Figure 2.2: Simplified process sequences for manufacturing of continuous filaments (flat and texturised) and staple fibres.....	23
Figure 2.3: Conventional wool scouring arrangement	24
Figure 2.4: Schematic diagram showing a scour line, integrated waste handling process and on-site effluent treatment plant	26
Figure 2.5: Simplified scheme of the Wooltech process	33
Figure 2.6: Cross-section of a tufted carpet	38
Figure 2.7: Simplified representation of a tufting plant	39
Figure 2.8: A: Level loop pile; B: Cut and loop pile.....	39
Figure 2.9: Manufacture of needle-felt carpet.....	40
Figure 2.10: Representation of the production process for woven carpets.....	40
Figure 2.11: Example of Mercerising equipment for woven fabric	44
Figure 2.12: Example of Mercerising equipment for knitted fabric in tubular form.....	44
Figure 2.13: Representation of a conventional carbonising installation.....	50
Figure 2.14: "Carbosol" system.....	51
Figure 2.15: Schematic representation of discharge printing.....	88
Figure 2.16: Schematic representation of resist printing.....	89
Figure 2.17: Screen printing with automatic squeegee system.....	90
Figure 2.18: Representation of a flat-screen printing machine	91
Figure 2.19: Representation of "Mechanised screen printing machine with stationary screens mounted in a frame"	91
Figure 2.20: Representation of the rotary-screen printing process.....	92
Figure 2.21: Representation of a rotary-screen printing machine	93
Figure 2.22: Printing-paste feeding system for a rotary-screen printing machine.....	93
Figure 2.23: Roller printing machine	94
Figure 2.24: More recent example of roller printing machine	94
Figure 2.25: Schematic representation of the Millitron system.....	95
Figure 2.26: Schematic representation of the TAK system.....	96
Figure 2.27: Schematic representation of the Hercosett process.....	103
Figure 2.28: Pre-coated tufted carpet	108
Figure 2.29: Pre-coating application by sloop-padding	108
Figure 2.30: Pre-coating application by doctor-blade technique.....	108
Figure 2.31: Foam-coated tufted carpet	109
Figure 2.32: Representation of the SBR foam coating process.....	109
Figure 2.33: PU foam coating	110
Figure 2.34: Textile backing	111
Figure 2.35: Textile backing by means of the laminating glue process	111
Figure 2.36: Textile backing by means of the powder lamination (melting glue).....	112
Figure 2.37: Carpet manufactured with the AdBac process.....	112
Figure 2.38: Representation of the heavy coating process	113
Figure 2.39: Solvent washing: representation of the solvent circuit	114
Figure 2.40: Solvent washing: representation of the air circuit in an open-loop washing machine	115
Figure 2.41: Solvent washing: representation of the air circuit in a closed-loop washing machine.....	115
Figure 2.42: Typical process sequence for the finishing of knitted fabric mainly consisting of cotton ...	122
Figure 2.43: Typical process sequence for the finishing of knitted fabric consisting mainly of man-made fibres.....	123
Figure 2.44: Typical process sequence for the finishing of woven fabric mainly consisting of cotton....	124
Figure 2.45: Typical process sequence for the finishing of woven fabric mainly consisting of wool.....	125
Figure 2.46: General process flow diagram for wool and wool-blend carpet yarn production	126
Figure 2.47: Schematic layout of a hank-scouring machine	130
Figure 2.48: Schematic diagram of a "Package to Package" yarn scouring installation	131

Figure 3.1: Net specific water consumption plotted against production volume.....	141
Figure 3.2: Relationship between the detergent feed rate and the rate of discharge of effluent to treatment	143
Figure 3.3: Energy and water consumption in 11 UK scouring mills.....	144
Figure 3.4: Energy consumption plotted against water consumption for 11 UK scouring mills	144
Figure 3.5: Water consumption against throughput for 11 UK scouring mills.....	144
Figure 3.6: Diagram showing the ranges of inputs to and outputs from the scouring processes and effluent treatment plants (on- and off-site) at the mills surveyed.....	151
Figure 3.7: Example of composition of the COD load for a mill finishing knitted fabric consisting mainly of polyamide	167
Figure 3.8: Composition of the COD load of a mill finishing woven fabric consisting mainly of cotton; semi-continuous and continuous dyeing is carried out with sulphur, vat and reactive dyestuffs	177
Figure 3.9: Analysis of thermal and electric energy consumption for the finishing of viscose fabric.....	178
Figure 3.10: Analysis of thermal and electric energy consumption for the finishing of viscose/PES fabric	179
Figure 3.11: Composition of the COD load of a mill finishing woven fabric consisting of polyamide mainly	184
Figure 3.12: Typical continuous process for pretreatment of cellulosic fibres, including desizing (first two compartments), scouring (padding of scouring liquor, steam treatment, washing, drying), bleaching (padding of the bleaching liquor, steaming, washing and drying).....	193
Figure 3.13: Waste water: fibre partition coefficients for OC, OP and SP pesticides in wet processing..	215
Figure 3.14: Diagram showing the ranges of inputs to and indicative output from wool and wool-blend carpet fibre wet processing	216
Figure 4.1: Scheme for annual input/output overview at site level.....	232
Figure 4.2: Example of automated systems for dispensing chemicals.....	236
Figure 4.3: Bioelimination curves in the modified Zahn-Wellens Test (EN 29888) of seven combinations of different sizing agents which are bioeliminated to more than 80 % after 14 days	251
Figure 4.4: Residues on Australian fleece wool 1996 to 1999	259
Figure 4.5: Average pesticide residues in New Zealand greasy wool 1994 to 2000	260
Figure 4.6: Chemical structure of some N- or P- containing complexing agents	267
Figure 4.7: Chemical structure of some N- and P-free complexing agents	268
Figure 4.8: Schematic diagram of the effluent and waste management system at Mill N.....	276
Figure 4.9: Recovery of sizing agents by ultrafiltration	284
Figure 4.10: Representative example of mass balance for sizing agents and water with and without recovery	285
Figure 4.11: Production of the peroxide radical ion by scavenging hydroxyl radicals (OH [*]) using hydrogen peroxide	297
Figure 4.12: Representation of the caustic soda recovery process by evaporation followed by lye purification.....	298
Figure 4.13: Comparison between the composition of conventional and new liquid formulations of liquid disperse dyes, before and after biological treatment (the (%) in the y axis indicates the percentage of dispersing agents related to the overall formulation)	307
Figure 4.14: Comparison of the bioelimination rates of conventional and modified dispersing agents, both based on condensation products of naphthalenesulphonic acid with formaldehyde	307
Figure 4.15: Representation of a U-shaft (A) and nip (B) dye liquor application systems.....	315
Figure 4.16: Dosing curve for ready-made alkali solution	319
Figure 4.17: Two examples of polyfunctional dyestuffs	321
Figure 4.18: Basic chemicals consumption per 10 million metres with pad-dry-pad-steam, pad-batch, pad- dry-thermofix and the reference technique	327
Figure 4.19: Fabric temperature and humidity during the dyeing process using the referenced technique	328
Figure 4.20: Structure of a typical bifunctional reactive dyestuff for wool of the bromo-acrylamide type	335
Figure 4.21: Dyeing curve for the application of reactive dyestuffs for wool exhaust dyeing	337
Figure 4.22: Dyeing of loose wool fibre and combed tops: comparison between the dyeing curve for the conventional process (whole curve) and the optimised process (Lanaset TOP process) (dotted part of the curve).....	341
Figure 4.23: Supraflor Carpet Winch	347
Figure 4.24: Illustration of an airflow dyeing machine with indication of air circulation and injection of the bath	349
Figure 4.25: Illustration of the rinsing step in an airflow dyeing machine with indication of the open valve to achieve continuous rinsing	349

Figure 4.26: Representation of the single-rope dyeing machine	353
Figure 4.27: Recovery of printing paste from the paste supply system by back-pumping an inserted ball	365
Figure 4.28: Chemical structure of cross-linking agents.....	377
Figure 4.29: Process Map for Mothproofing Dry-Spun Production.....	385
Figure 4.30: Process map for mothproofing stock dyed – yarn scoured production	390
Figure 4.31: Process map for mothproofing yarn dyed production.....	393
Figure 4.32: General layout of a conventional solvent scouring installation	400
Figure 4.33: General layout of a modern solvent scouring installation.....	401
Figure 4.34: Plant 1 – combined treatment of textile effluent and municipal waste water	406
Figure 4.35: Daily average COD concentration measured on the final effluent from Plant 1 in the year 2000.....	407
Figure 4.36: Plant 2 – combined treatment of textile effluent and municipal waste water	408
Figure 4.37: Daily average COD load measured on the final effluent from Plant 2 in 1999	409
Figure 4.38: Plant 3 – combined treatment of textile effluent and municipal waste water	409
Figure 4.39: Plant 4 – combined treatment of textile effluent and municipal waste water	410
Figure 4.40: Plant 5 –treatment of waste water from one textile finishing mill with 5 % water recycling	411
Figure 4.41: Plant 6 –treatment of waste water from one textile finishing mill.....	412
Figure 4.42: On-site treatment of mixed textile waste water with partial recycling of the treated effluent	415
Figure 4.43: Thermal treatment of excess sludge from the activated sludge treatment and sludge from flotation	416
Figure 4.44: Treatment of selected segregated waste water streams using a series of membrane techniques (ultrafiltration, nanofiltration and reverse osmosis) – the cut-offs are expressed in Dalton (D)	422
Figure 4.45: Layout of a plant for treatment and recycling of waste water from pigment printing paste preparation kitchen (water from scrubbers is treated in the same plant)	425
Figure 4.46: Scheme of the reactor for treatment by catalytic oxidation with O ₂ /H ₂ O ₂ of some segregated highly concentrated streams; on the left, illustration of the reactor at Schoeller AG, CH-Sevelen in operation since 1996.....	429
Figure 4.47: Capital cost of recent composting plant start-ups in UK. (Source: The Composting Association, UK).....	442
Figure 9.1: Examples of acid dyes	511
Figure 9.2: Examples of typical basic dyes.....	514
Figure 9.3: Examples of typical direct dyes.....	516
Figure 9.4: Examples of molecular structures typical of 1.1 metal-complex dyes.....	519
Figure 9.5: Molecular structure typical of 1.2 metal-complex dyes.....	519
Figure 9.6: Representation of possible ionic and coordination bonds between wool and chrome dyes... ..	521
Figure 9.7: Examples of typical coupling components for naphthol dyes.....	523
Figure 9.8: Examples of typical developing agents (fast colour base) for naphthol dyes	524
Figure 9.9: Examples of typical fast colour salts	524
Figure 9.10: Reactive Black 5	526
Figure 9.11: Examples of typical vat dyes	532
Figure 10.1: Schematic layout of a conical pan loose fibre dyeing machine	536
Figure 10.2: Schematic diagram of a Hussong type hank dyeing machine.....	537
Figure 10.3: Schematic layout of a package dyeing machine	538
Figure 10.4: Schematic representation of a winch beck dyeing machine.....	539
Figure 10.5: Schematic representation of a jet dyeing machine.....	540
Figure 10.6: Schematic representation of an overflow dyeing machine.....	541
Figure 10.7: Schematic representation of jet dyeing machine.....	542
Figure 10.8: Example of continuous process for knitted fabric in rope form.....	543
Figure 10.9: Schematic representation of a beam dyeing machine	543
Figure 10.10: Schematic representation of a jigger.....	544
Figure 10.11: Foulard types	545
Figure 10.12: Illustration of some of the most important dye/finish applicators	546
Figure 10.13: Schematic layout of a pad-batch plant.....	547
Figure 10.14: Schematic representation of a pad-steam plant (wet steam) for dyeing with vat dyes.....	548

SCOPE

This document covers the industrial activities specified in Section 6.2 of Annex 1 of Directive 96/61/EC, namely:

"Plants for the pretreatment (operations such as washing, bleaching, mercerisation) or dyeing of fibres or textiles where the treatment capacity exceeds 10 tonnes per day".

Particular attention is given to the following processes:

- fibre preparation
- pretreatment
- dyeing
- printing
- finishing.

Upstream processes which may have a significant influence on the environmental impact of the subsequent wet processing activities are also briefly described.

The backing of carpets is included in this document because it is an intrinsic part of carpet manufacturing and has the potential to pollute the environment.

All main textile fibre types, namely natural fibres, man-made fibres derived from natural polymers such as viscose and cellulose acetate as well as man-made fibres derived from synthetic polymers are described, including their blends.

1 GENERAL INFORMATION

The textile industry is one of the longest and most complicated industrial chains in manufacturing industry. It is a fragmented and heterogeneous sector dominated by a majority of Small and Medium Enterprises, with a demand largely driven by three main end-uses: clothing, home furnishing and industrial use.

The importance of the textile (and clothing) industry in the European economy is shown in Table 1.1. The figures in the table cover only a part of the total number of manufacturing companies in 2000 (i.e. they only cover companies with more than 20 employees).

This part of the industry represented:

- 3.4 % of EU manufacturing
- 3.8 % of the added valued and
- 6.9 % of industrial employment.

2000	Turnover EUR Billion	Added value at f.c. EUR Billion	Employment Million	Turnover %	Added value %	Employment %
Textile	100.5	31.2	0.89	2.1	2.4	3.8
Clothing	61.5	18.2	0.73	1.3	1.4	3.1
Total Textile & cloth.	162	49.4	1.62	3.4	3.8	6.9
Total Manufacturing	4756.8	1308.0	23.62	100	100	100
f.c. : factor costs						
Source: [315, EURATEX, 2002]						

Table 1.1: Share of the EU-15 textile-clothing industry in the manufacturing industry (only companies with 20 employees or more)

In reality, in 2000 the EU textile and clothing industry actually achieved a turnover of 198 billion euros, involving 114000 companies, who employed about 2.2 million people.

The textile industry's activities are distributed right across Europe, but mainly concentrated in only a few EU states. Italy is the leading European producer, far ahead of Germany, the UK, France and Spain (in that order). These five countries together account for over 80 % of the Community textile and clothing industry [113, EURATEX, 1997].

	Textile % in 2000	Clothing % in 2000	Textile & Clothing % in 2000
Germany	14.4	13.1	13.8
France	13.1	13.0	12.9
Italy	29.7	30.8	30.1
Netherlands	2.0	0.8	1.5
Belgium	5.6	2.2	4.2
United Kingdom	12.5	14.3	13.4
Ireland	0.7	0.5	0.6
Denmark	1.0	1.1	1.1
Spain	8.4	11.4	9.6
Greece	2.1	2.5	2.3
Portugal	6.1	7.9	6.9
Austria	2.8	1.2	2.1
Finland	0.8	1.0	0.9
Sweden	0.8	0.2	0.6
Luxembourg	0	0	0
EU-15	100	100	100
Source: [315, EURATEX, 2002]			

Table 1.2: Country breakdown of the EU-15 textile and clothing industry in 2000

The textile and clothing chain is composed of a wide number of sub-sectors covering the entire production cycle from the production of raw materials (man-made fibres) to semi-processed materials (yarns, woven and knitted fabrics with their finishing process) and final/consumer products (carpets, home textiles, clothing and industrial use textiles).

The complexity of the sector is also reflected in the difficulty of finding a clear-cut classification system for the different activities involved. The old nomenclature system (old NACE 1995) still classified textile industry's activities as follows:

- man-made fibres industry
- wool
- cotton
- silk
- flax/jute
- knitting
- finishing
- carpets
- other textiles
- household linen.

The new nomenclature system (NACE 1997) identifies the following categories:

- yarn and thread
- woven fabric
- textile finishing
- home textiles
- industrial & other textiles (this includes Carpets and Wool Scouring)
- knitted fabrics & articles.

The old nomenclature reflects the historical subdivision of the textile industry's activities according to the fibre processed. This stems from the fact that historically the only textile fibres available were natural fibres, with a predominance of wool and cotton, which resulted in the development of two main sectors, wool and cotton. Because of the different physico-chemical characteristics of these two fibres, different machinery and different techniques were developed. Nowadays, with the proliferation of man-made fibres these two historical sectors now both

process all available fibres and it has become impractical to classify textile activities by reference to the fibre.

As for the scope of this document, it is confined to those activities in the textile industry that involve wet processes. This means primarily activities falling within the following new NACE classifications:

- textile finishing
- industrial and other textiles (including Carpets and Wool Scouring)
- home textiles.

Because of its very specialised nature, carpet manufacturing has always been considered as a stand-alone sector, even though many of the operations carried out are very close to those carried out elsewhere in textile finishing. This document follows that tradition, hence carpets are the only sector where the end-product is taken as the point of reference.

Some general information is given below about the three sub-sectors of wool scouring, textile finishing (excluding floor-coverings) and carpets.

1.1 Wool scouring sector

1.1.1 Sector organisation

Wool is processed to yarn mainly via two systems: woollen and worsted. Scourers tend to specialise in wools for one system or the other. Woollen system scourers normally only scour the wool, though some may blend it before despatch to the customer. Worsted system scourers (referred to as combers) scour, card and comb the wool and their product is called top.

Within Europe, significant quantities of wool are obtained from the skins of slaughtered animals by fellmongering. Fellmongers normally sell the wool they produce to merchants, who have it scoured on commission. In France there are several fellmongers who also scour the wool they produce.

The wool scouring and combing business in Western Europe is largely carried out on commission. There are a few exceptions to this system, notably in the UK, where three carpet yarn manufacturers have their own wool scouring plants.

1.1.2 Production and economics

Table 1.3 shows estimates of the amounts of wool produced and scoured in the various Member States along with the number of existing scouring mills.

Country	Domestic production of greasy wool	Wool scoured for worsted processing (clean weight)	Wool scoured for woollen processing (clean weight)	Total wool scoured (clean weight)	Total wool scoured (approx. greasy equivalent) (c)	Estimated number of scouring mills
Austria	^(a)	0	0	0	0	0
Belgium	^(a)	1.8	2.0	3.8	5.4	1
Denmark	^(a)	0	0	0	0	0
Finland	^(a)	0	0	0	0	0
France	20	56.3	9.1	65.4	93.4	n.d.
Germany	13	34.2	9.2	43.4	62.0	1 ^(d)
Greece	9	0	0	0	0	0
Ireland	25	0	0	0	0	0
Italy	11	73.6	2.4	76.0	108.6	8 – 9
Luxembourg	^(a)	0	0	0	0	0
Netherlands	^(a)	0	0	0	0	0
Portugal	9	3.3	2.0	5.3	7.6	2
Spain	36	13.5	12.7	26.2	37.4	n.d.
Sweden	^(a)	0	0	0	0	0
UK	65	29.1	50.4	79.6	113.7	13
Other western Europe	10 ^(b)	0	0	0	0	0
TOTAL	198	211.8	87.8	299.7	428.1	>25

Source: [187, INTERLAINE, 1999]

Notes:

Unit: '000 tonnes/year

^(a) Included in "Other western Europe".

^(b) Austria, Belgium, Denmark, Finland, Iceland, Luxembourg, Malta, Netherlands, Norway, Sweden and Switzerland.

^(c) Assuming an average yield of 70 %.

^(d) A second scouring/combing mill in Germany is not believed to be operational.

Table 1.3: Wool production and wool scouring production in EU Member States [187, INTERLAINE, 1999]

As it is possible to see from the reported data, ca. 90 % of the EU scouring activity is concentrated in France, Germany, Italy and UK, while eight EU Member States have no scouring plants.

The UK scouring and combing industry is the largest in Europe, though only slightly larger than that of Italy. About two thirds of the UK scouring production comprises coarse wools for woollen spun carpet yarn.

Figure 1.1 shows the amounts of wool scoured in the 15 EU Member States in terms of greasy wool weight. This is the unit most often used by scourers to express their throughput.

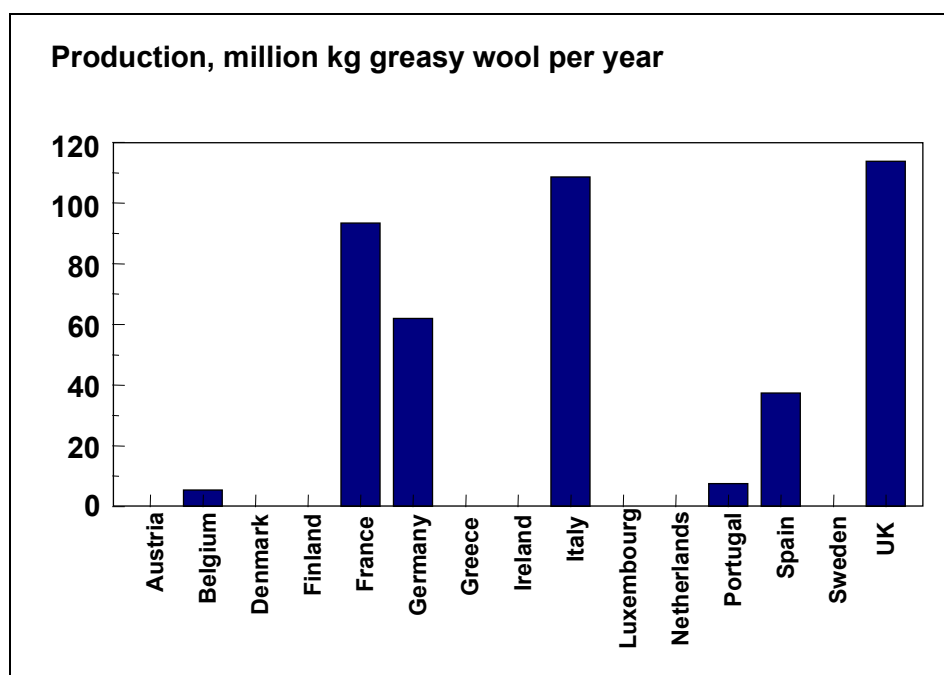


Figure 1.1: Estimates of the amounts of greasy wool scoured during 1997 in the 15 EU Member States
[187, INTERLAINE, 1999]

During the period from 1993 to 1997 the total production in EU Member States has declined almost 10 % from 326 million kg (clean wool) in 1993 to 300 million kg (clean wool) in 1997. Within this overall trend a steeper decline has been observed in northern Europe (Belgium, France, Germany and UK) alongside an increase in production in Italy and Spain. Although the overall decline in production in the European scouring sector has been relatively slow, there have been significant structural changes. The competitive nature of the industry and the cost and technical difficulties of complying with increasingly stringent environmental legislation have been the driving force behind these changes. Several large and small scouring mills have been forced beyond the limits of commercial and economic viability and have ceased trading. In most cases, their market share has been absorbed by competitors, so that now there are fewer companies in the sector, which on average process larger amounts of wool. This tendency towards consolidation is especially true in the UK, where a large part of the scouring industry's trade is the processing of UK and Irish wools. Almost 80 %¹ of the British and Irish wool production, totalling 90000 tonnes is scoured in the UK and this trade is unlikely to be lost to competitors in other countries [187, INTERLAINE, 1999].

1.2 Textile finishing sector (excluding floor covering)

The following information is taken from [278, EURATEX, 2002].

1.2.1 Sector organisation

The essence of textile finishing is giving fabrics the visual, physical and aesthetic properties which consumers demand. The main processes involved are bleaching, dyeing (of yarn, fabric, ready-made garments), printing, coating / impregnating and the application of various functional finishings.

¹ A survey of UK wool scourers, carried out by ENco in 1997, showed that they processed 71 million kg (greasy) of British and Irish wool during the previous year.

In most cases, the textile finishing process is combined with a manufacturing process, which gives the final product its particular shape. The main product categories cover clothing textiles, interior textiles (furnishing fabrics, curtains and carpets, which are discussed in Section 1.3), household textiles (bed / bath and table linen) and technical textiles (automotive fabrics, geo- and medical textiles).

Most companies in the textile finishing sector specialise in one type of process, although there are companies with several production processes. The following main types of companies can be distinguished:

- commission or merchant yarn dyers
- commission or merchant fabric dyers
- commission or merchant printers
- integrated companies, incorporating spinning and / or weaving plus finishing processes.

1.2.2 Production and economics

The total turnover of the EU-textile finishing industry amounted to nearly 11000 million euros in 2000, with more than 117000 employees. The majority of EU textile finishing companies are SMEs. The importance of the Textile Finishing Industry in EU Member States is shown in Figure 1.2.

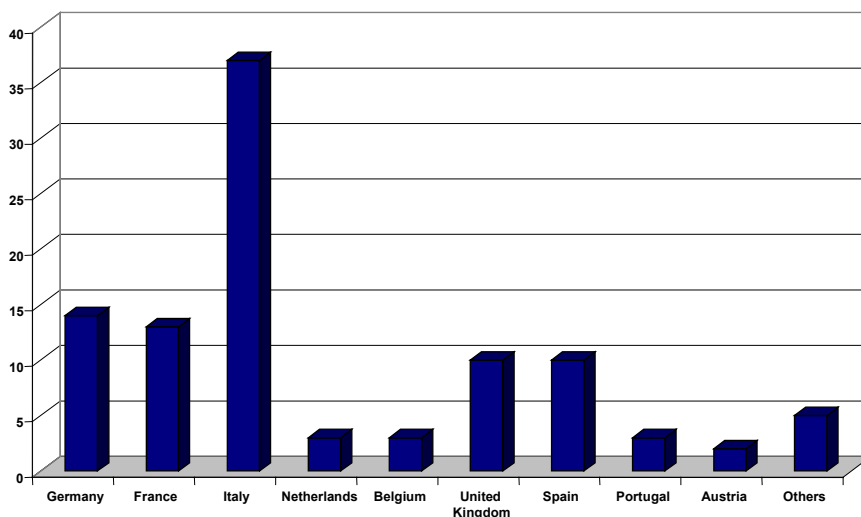


Figure 1.2: EU Textile Finishing Production [278, EURATEX, 2002]

The share of the main types of fibres used in the textile finishing industry is [315, EURATEX, 2002]:

- cotton	45
- wool	8
- polyester	14
- silk	2
- viscose	12
- acrylic	4
- others	15
Total	100 %

The fibres end up in processed goods, the main categories in percentage being:

- clothing textiles	45
- household textiles	20
- interior textiles	10
- technical textiles	18
- others	7
Total	100 %

1.3 Carpet

1.3.1 Sector organisation

The strong specialisation of this well integrated sector has already been mentioned. The carpet manufacturing, carpet yarn spinning and associated dyeing industry can be divided into a number of basic sub-sectors, although there may be considerable variations. All sectors may process combinations of 100 % synthetic fibre, 100 % natural fibre and/or blends of the two, as many of the processes and techniques used are not fibre specific.

As Table 1.4 shows there are five main different categories of companies where wet processes are normally carried out (in italics in the table):

- commission loose fibre dyehouses
- commission yarn dyehouses
- integrated yarn manufacturing mills, which in addition to the dyeing processes perform on-site conversion of the loose fibre to yarn, selling the finished yarn as end-product
- commission piece dyeing mills
- integrated carpet manufacturing mills, which carry out all the mechanical processes, dyeing and finishing operations required to convert natural and synthetic fibres into finished carpet.

Sub-Sector	Main Characteristics and Principal Wet Processes (in italics)	End-Product
Commission Loose Fibre Processing	<ul style="list-style-type: none"> • <i>Loose fibre dyeing</i> 	Dyed loose fibre for yarn manufacture
Commission Yarn Processing	<ul style="list-style-type: none"> • <i>Yarn scouring and chemical finishing</i> • <i>Yarn dyeing</i> 	Dyed yarn for carpet manufacture
Yarn Manufacture	Raw material (fibre) purchase or production on site Conversion to yarn <ul style="list-style-type: none"> • Dyeing/wet processing carried out on commission Marketing of finished yarn	Coloured and ecru yarn for carpet manufacture
Integrated Yarn Manufacture (may be on several sites)	Raw material (fibre) purchase or production on site <ul style="list-style-type: none"> • <i>Loose fibre dyeing</i> • <i>Yarn scouring and chemical finishing</i> • <i>Yarn dyeing and chemical finishing</i> • <i>Yarn setting</i> Marketing of finished yarn	Coloured and ecru yarn for carpet manufacture
Commission Tufting, Weaving and Backing	Conversion of yarn to carpet <ul style="list-style-type: none"> • Backing and mechanical finishing 	Finished carpet
Commission Piece Dyeing	<ul style="list-style-type: none"> • <i>Dyeing and/or printing</i> • Backing and mechanical finishing • <i>Chemical finishing</i> 	Finished carpet
Carpet Manufacturing	Dyed and finished yarn purchase Conversion to carpet <ul style="list-style-type: none"> • Foam applied chemical treatment • Backing and mechanical finishing Marketing of finished carpet	Carpet for contract and retail sale
Integrated Carpet Manufacturing (may be on several sites)	Raw material (fibre) purchase/manufacture <ul style="list-style-type: none"> • <i>Raw wool scouring</i> ⁽¹⁾ • <i>Loose fibre dyeing</i> Conversion to yarn <ul style="list-style-type: none"> • <i>Yarn scouring and chemical finishing</i> • <i>Yarn dyeing and chemical finishing</i> • <i>Yarn setting</i> Conversion to carpet <ul style="list-style-type: none"> • <i>Carpet piece colouration</i> • Foam applied chemical treatments • Backing and mechanical finishing Marketing of finished carpet	Carpet for contract and retail sale
Note ⁽¹⁾ Raw wool scouring may be carried out within the group or on commission		

Table 1.4: Basic structure of the carpet manufacturing industry
[32, ENco, 2001]

Table 1.5 indicates the locations of trading entities within the EU. Note that individual units may be part of a larger group, providing services to other members of the same organisation. In a similar way, a yarn spinning company with its own dyeing facilities may, if production schedules require, also have work carried out by a commission dyer or may carry out commission work for other companies if spare capacity is available.

Country	Carpet ^(a) Manufacturers	Yarn ^(b) Spinners	Commission ^(c) Dyers
Austria	4		
Belgium	64	12	9
Denmark	12	2	
Finland	4	1	1
France	16	1	1
Germany	38	4	2
Greece	2		
Ireland	4	1	
Italy	9	1	
Netherlands	34	1	3
Portugal	2	1	
Spain	3		
Sweden	2		
United Kingdom	87	30	9
Luxembourg			
Sources: ^(a) International Carpet Yearbook 2000 – includes all, product types and fibres ^(b) International Carpet Yearbook 2000 & Wools of New Zealand – includes spinners with dyehouses ^(c) ENco and Wools of New Zealand – includes all fibres			

Table 1.5: Sector Location and number of trading entities within the EU
[32, ENco, 2001]

1.3.2 Production and economics

As Figure 1.3 shows, European carpet industry accounts for 38 % of world production (after the United States, with 58 %).

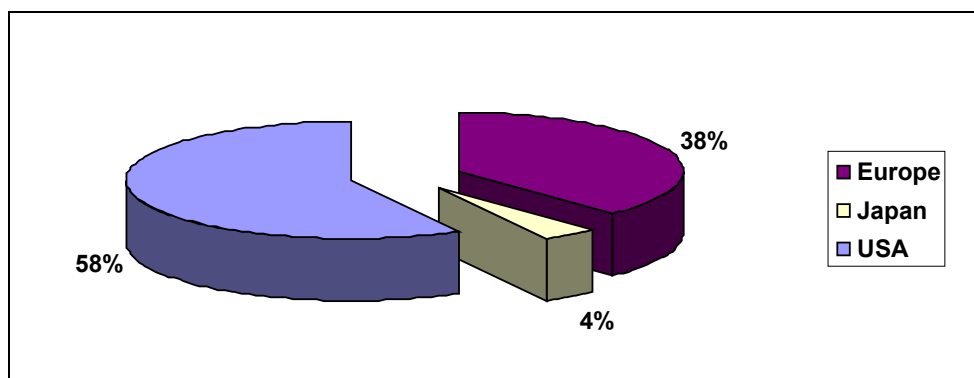


Figure 1.3: Worldwide production of carpets and rugs in 1999
[63, GuT/ ECA, 2000]

Belgium, France, Germany, the Netherlands and the United Kingdom are all major producers for both internal EU consumption and world export markets. European carpet production exceeds carpet consumption by a significant margin (Figure 1.4), indicating the importance of export markets to the European industry.

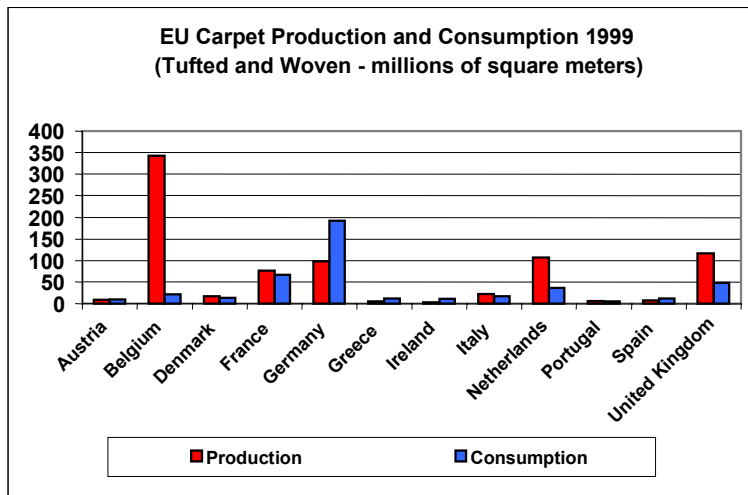


Figure 1.4: Carpet production and consumption in some EU Member States [32, ENco, 2001]

Among the three typical end-products of the carpet manufacturing industry - tufted carpet, woven carpet and needle felts - tufted carpets account for 66 % of EU production. This is shown in the 1995 production below in Figure 1.5 and Figure 1.6.

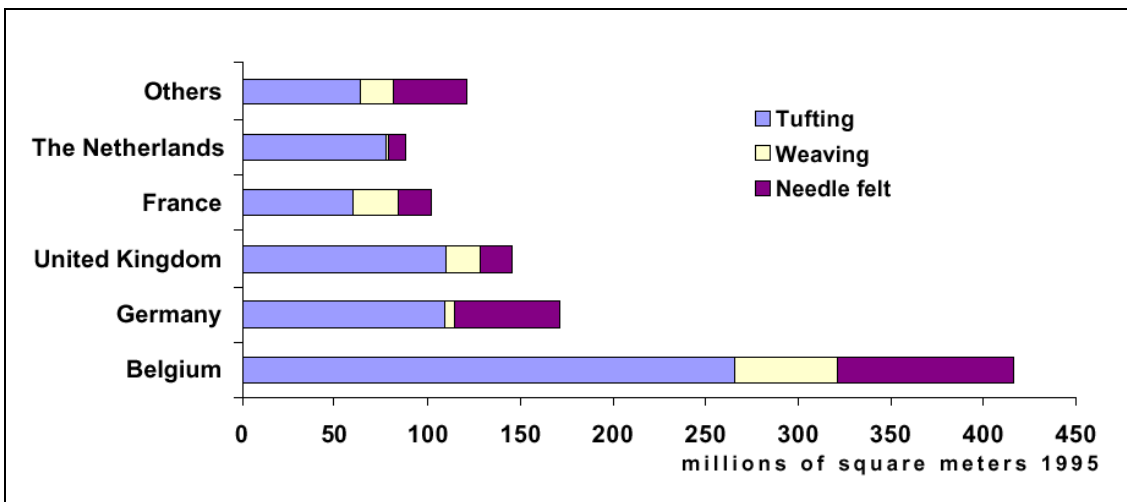


Figure 1.5: European carpet and rug production in 1995 for the major producers of carpets and rugs in Europe [63, GuT/ ECA, 2000]

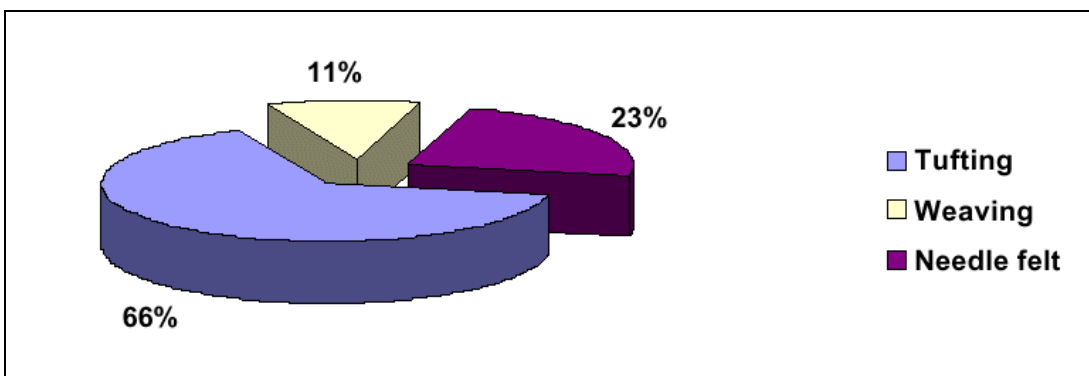


Figure 1.6: Total carpet and rug production in Europe in 1995 [63, GuT/ ECA, 2000]

1.4 Main environmental issues

The main environmental issues arising from the activities in the textile industry which are covered in this document regard primarily emissions to water and air and energy consumption.

Among these, water is the most important concern. The textile industry uses water as the principal medium for removing impurities, applying dyes and finishing agents, and for the generation of steam.

Losses to the product are negligible, therefore, apart from a minor amount of water which is evaporated during drying, the bulk is discharged as aqueous effluent. The main concern is therefore about the amount of water discharged and the chemical load it carries.

An overview of these environmental loads is given in Table 1.6. The reported data have been extrapolated to European level from the results of a research study in Germany and Austria.

Substances	Environmental load (t/yr)
Salts	200000 - 250000
Natural fibres impurities (including biocides) and associated material (e.g. lignin, sericine, wax, etc.)	50000 - 100000
Sizing agents (mainly starch, starch derivatives, but also polyacrylates, polyvinylalcohol, carboxymethylcellulose and galactomannans)	80000 - 100000
Preparation agents (mainly mineral oils, but also ester oils)	25000 - 30000
Surfactants (dispersing agents, emulsifiers, detergents and wetting agents)	20000 - 25000
Carboxylic acids (mainly acetic acid)	15000 - 20000
Thickeners	10000 - 15000
Urea	5000 - 10000
Complexing agents	<5000
Organic solvents	n.d.
Special auxiliaries with more or less ecotoxicological properties	<5000
Source: [77, EURATEX, 2000]	

Table 1.6: Main charging loads from textile industry in Europe

From the reported figures it appears that a large percentage of the total emission load from textile industry activities is attributable to substances that are already on the raw material before it enters the finishing process sequence. Typically these are:

- sizing agents
- preparation agents
- natural fibres impurities and associated material.

Sizing agents are used to assist the weaving process. They are removed from the woven fabric before the finishing process, thus producing high levels of organic load in the water.

Preparation agents and spinning oils, are applied to fibres in various steps of the process, from the manufacture of the fibre itself (for synthetic fibres only) to the formation of the yarn. These organic substances are removed during pretreatment at the finishing mill either through wet processing (washing) or through dry processing (heat-setting). In the former case they contribute to the increase of the organic load of the final water effluent, in the latter case they become airborne.

All natural fibres contain a percentage of impurities and associated material. Associated materials are an essential part of natural fibres (e.g. grease for wool, pectin and hemicellulose for cotton, lignin for flax and sericine for silk). Impurities are metals, mineral and pesticides. All these substances have to be removed from the fibre before it can undergo finishing processes. They therefore also have the potential for considerable environmental impact.

The input of chemicals and auxiliaries added at the finishing mills can be up to 1 kg per kg of processed textiles, which appears to be high. The range of these substances is very extensive: the latest issues of TEGEWA lists more than 7000 auxiliaries. However, as shown in Figure 1.7, in a typical finishing mill, 80 % of the annual consumption is covered by only 20 % of the product types used.

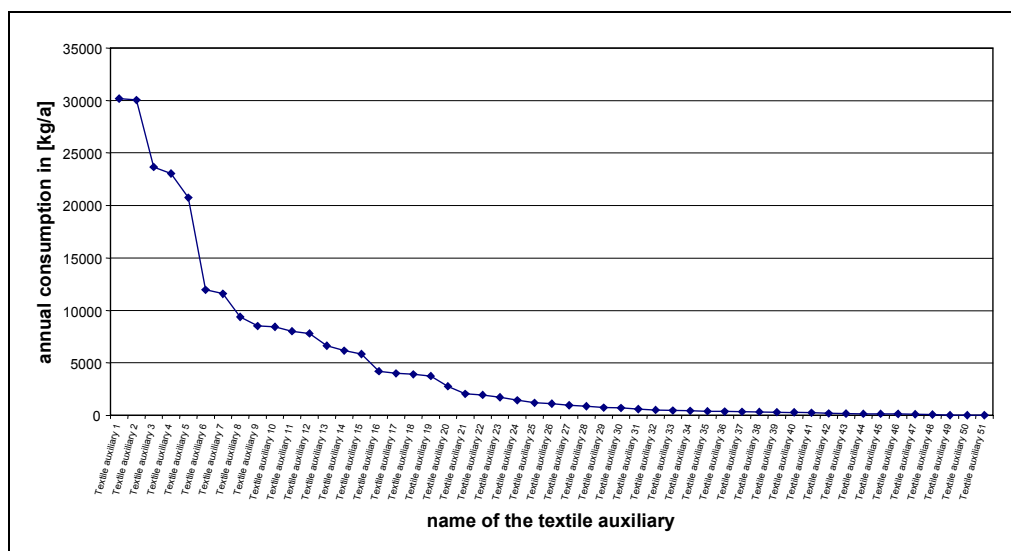


Figure 1.7: Auxiliaries pattern usage in a typical finishing mill
[179, UBA, 2001]

On the basis of the data reported in Table 1.6, among the products applied during the process, the highest environmental loads arise from salts, detergents and organic acids (in that order).

Dyestuffs are not mentioned in the table because they do not represent a significant load compared to other substances used in the process. Nevertheless they are responsible for the colour of the effluent – which is mainly an aesthetic problem, although high doses of colour may also reduce light transmission to aquatic plants. Their presence in the water is therefore important, not only because of the colour, but also in relation with other environmental concerns (e.g. difficult-to-eliminate organic load, AOX, metals), particularly for certain classes of dyestuffs.

A number of chemicals that may be used in the textile process are worth specifically mentioning for their potential negative effects on the environment. These are:

- alkyl phenol ethoxylates (detergents, wetting agents, levelling agents, etc.): their metabolites (octyl- and nonyl phenols) are highly toxic to aquatic life and are reported to disturb the reproduction of aquatic species by disrupting the endocrine system (octyl and nonylphenol are on the list of “Priority Substances” targeted for priority action under the Water Framework Directive 2000/60/EC, in particular nonylphenol is identified as “Priority Hazardous Substance”)
- polybrominated diphenyl ethers and chlorinated paraffins (flame retardants), halogenated phenols and benzenes (reagents in the production of flame retardants): some members of these classes of substances (e.g. pentabromodiphenylether, C₁₀₋₁₃ chloroparaffines) have already been identified as “Priority Hazardous Substances” for their toxicity, persistency and liability to bioaccumulate or they have been evaluated under the scope of Regulation (EEC) 793/93 on the evaluation and control of the risks of existing substances. For other members of these classes the debate about their potentially negative effects on the environment is still on-going (see Section 8.8.4)
- mothproofing agents based on permethrin and cyfluthrin (carpet sector) and other biocides: these are highly toxic to aquatic life
- sequestering agents such as EDTA and DTPA and NTA: these are capable of forming very stable complexes with metals (EDTA and DTPA are also poorly bioeliminable)
- chlorine and chlorine-releasing compounds such as sodium hypochlorite (bleaching agent) and sodium dichloroisocyanurate (wool anti-felting agent): these are capable of reacting with organic compounds to form adsorbable organic halogens (AOX)
- metal-containing compounds such as potassium dichromate
- substances with carcinogenic potential, such as a number of aromatic amines, formed by cleavage of some azo dyes (see Section 2.7.8.1), or vinylcyclohexene and 1,3-butadiene, which can be present in polymer dispersions due to an incomplete reaction during polymerisation
- carriers such as trichlorobenzene, o-phenylphenol, etc.

It is reported that [77, EURATEX, 2000]:

- more than 90 % of the organic chemicals and auxiliaries in pretreatment and dyeing operations does not stay on the fibre, whereas the reverse is true in the finishing treatment
- nearly 90 % of the organic raw material load entering the textile process ends up in the waste water, the remaining amount being released to air.

With regard to emissions to air, volatile organic compounds are released from particular activities such as:

- printing processes, in cases when organic solvents are used (e.g. they are contained in pigment printing pastes)
- cleaning with organic solvents
- heat treatments (e.g. thermofixation, drying, curing) when the textile materials contain substances that evaporate or degrade thermally (for example, oils, plasticisers, finishing agents and residues from upstream processes). Emissions of formaldehyde and uncombusted methane can be particularly significant in poorly maintained, directly heated stenters
- vulcanisation of the backing layers (carpet sector).

Moreover, emissions of CO₂, SO_x, NO_x and particulates associated with the on-site burning of fossil fuels to produce thermal energy are also to be taken into account.

Energy is consumed primarily in raising the temperature of the baths (e.g. pretreatment, dyeing, etc.) and in drying and curing operations. To this aim steam is produced on-site. Electrical energy is required for driving the machinery.

2 APPLIED PROCESSES AND TECHNIQUES

The textile chain begins with the production or harvest of raw fibre. The basic steps in this chain are schematically represented in the following diagram and will be described in this chapter.

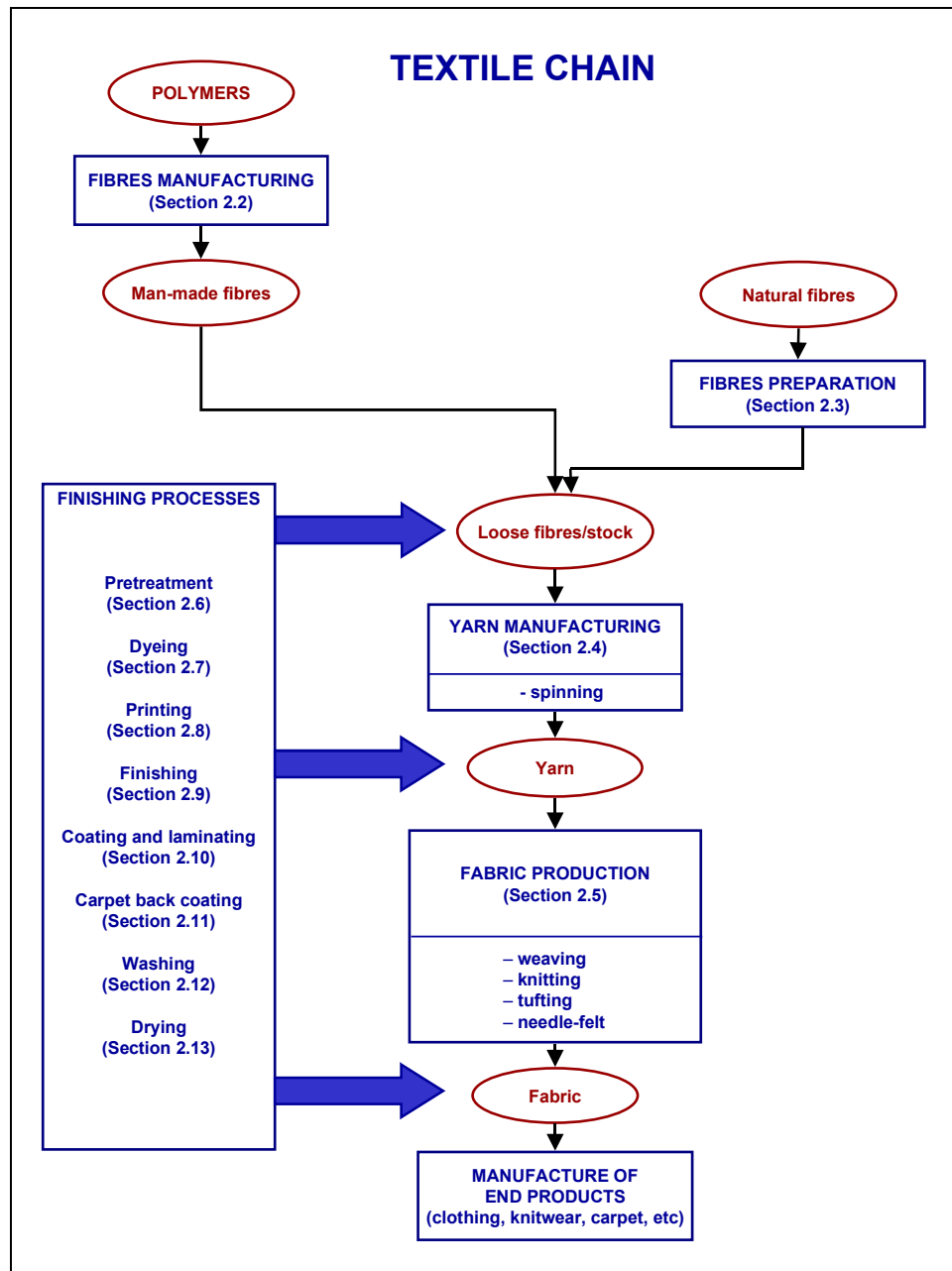


Figure 2.1: General diagram of processes in the textile industry

The main part of this chapter will describe those treatments that are broadly referred to as "finishing processes" (that is pretreatment, dyeing, printing, finishing and coating, including washing and drying). As the diagram shows, they can take place at different stages of the production process: the substrates for finishing can be fabrics, yarns or loose fibres.

"Textile finishing" cannot be defined as a standard sequence of treatments, but rather is a combination of unit processes that can be applied within the production of a textile product, depending on the requirements of the final user. For this reason finishing treatments will be described (from Section 2.6 to Section 2.11) as unit processes without considering the possible sequences in which they can be applied.

In the second part of this chapter (see Section 2.14) a distinction has been made between the carpet finishing sector and the rest of the finishing industry. Some typical categories of industries have been identified within each sector. The wool scouring industry has also been identified as a stand-alone sector. These categories have typical features that are described in brief.

As well as fibres, the raw materials of the textile industry include a wide range of chemicals and auxiliaries. These chemicals and auxiliaries are often not process-specific and can be found in different steps within the process cycle. For this reason it has been considered more practical to report the description of these issues in separate annexes (ANNEX I Textile Auxiliaries and ANNEX II Dyes and Pigments). Only general information about textile raw materials, including common procedures for storage and handling is given in this chapter.

In the same way, because most of the machines have a multifunctional use within the production cycle, equipment is also described in a specific annex (ANNEX III Wet Processes: Machinery and Techniques).

2.1 Raw materials

2.1.1 Fibres

Two general categories of fibres are used in the textile industry: natural and man-made. Man-made fibres encompass both purely synthetic materials of petrochemical origin, and regenerative cellulosic materials manufactured from wood fibres. A more detailed classification of fibres is:

- Natural origin fibres
 - Animal origin
 - Raw wool
 - Silk fibre
 - Hair
 - Vegetable origin
 - Raw cotton fibre
 - Flax
 - Jute
 - Mineral origin
 - Asbestos (not used in the textile industry)
- Chemical fibres (man-made)
 - Natural polymer fibres
 - Viscose, Cupro, Lyocell
 - Acetate
 - Triacetate
 - Synthetic polymer fibres
 - Inorganic polymer
 - Glass for fibre glass
 - Metal for metal fibre
 - Organic polymer
 - Polyester (PES)
 - Polyamide (PA)
 - Acrylic (PAC)
 - Polypropylene (PP)
 - Elastane (EL)

Fibres included in this document are described in more detail below, highlighting in particular the typical impurities present on them. Part of these impurities will enter the textile process and will influence the associated emissions.

2.1.1.1 Polyester fibres (PES)

Polyester fibres (PES) are made of linear macromolecules containing at least 85 % of an ester in the chain. To date three polyester polymers are commercially available:

- poly(ethylene terephthalate) (PET), which is based on ethylene glycol
- poly(butylene terephthalate) (PBT), which is based on butyl glycol
- and poly(trimethylene terephthalate) (PTT), which is based on trimethylene glycol.

However, only one of these three polymers, poly(ethylene terephthalate), also known as PET, has so far been widely applied in the textile industry. Therefore in the following sections, unless otherwise specified, the term PES is used to indicate standard polyester fibres based on PET.

PET fibres have a very high degree of crystallinity, which allows for excellent heat-resistance and other mechanical properties. On the other hand, this compact structure inhibits the diffusion of the colourants into the fibre during dyeing. As a result, PET fibres cannot be dyed below 100 °C, unless dyeing accelerants (so-called carriers) are used. Carriers are harmful for the environment and in many cases are toxic for humans. Their use is now in decline, but it has been common practice for many years (see also Sections 2.7.8.1 and 8.6.7).

Carrier-free dyeable PES fibres are now available on the market. They include the “*modified PES fibres*” and the PTT fibres (see list above). “Modified PES fibres” are based on PET. Thanks to physical and chemical alterations made to the structure of the fibre during the manufacturing process, they show lower crystallinity, which makes them easier to dye without need for carriers. Because of their high cost, however, these fibres are applied only in specific segments of the market.

As concerns PTT, this aromatic polyester (poly(trimethylene terephthalate)) is made by the polycondensation of 1,3-propanediol and terephthalic acid. The high cost of synthesis of 1,3-propanediol has for many years prohibited the commercialisation of this fibre. Recently Shell pursued a new lower-cost synthesis route for the production of this monomer, which has led to renewed interest for PTT polymers [178, VITO, 2001]. More information about these fibres is reported in Section 4.6.2.

On polyester fibres in general, it is also worth mentioning that during the polycondensation reaction, cyclic oligomers with very low water-solubility can be formed (1 - 3 % on the weight of the fibre [77, EURATEX, 2000]). These oligomers tend to migrate to the surface of the fibre during dyeing, thus negatively affecting level dyeing and rub-fastness properties.

2.1.1.2 Polyamide fibres (PA)

The starting polymer comes from the polycondensation reaction between a diamine and a dicarboxylic acid. According to the number of carbon atoms of the end-product one can speak of PA 6,6 or PA 6.

PA 6,6 is made by thermal polycondensation of equimolecular amounts of adipic acid and 1,6-hexamethylenediamine. The equilibrium condensate contains small amounts of monomers and cyclic dimers (2 %).

PA 6 is made by polymerisation of the cyclic monomer epsilon-caprolactame. The caprolactame content in the polymer can be reduced to 0.2 % by extraction with hot water. During the melting process for the production of the fibre (melt spinning), the caprolactame content rises again and is partially emitted during the following thermal treatments.

2.1.1.3 Acrylic fibres (PAC)

The polymer is obtained by radical polymerisation of acrylonitrile in aqueous emulsion or in solvent. The obtained polymer, made of 100 % acrylonitrile (also called PAN), gives fibres with insufficient dye-binding capability, due to the high glass transition temperature (above 100 °C). For this reason this polymer is no longer used in the textile industry. Acrylic fibres (PAC), commonly found on the market today, are anionic copolymers containing 85 – 89 % of acrylonitrile, 4 – 10 % of a non-ionic comonomer (vinyl chloride, vinyl acetate, methyl acrylate) and 0.5 – 1 % of ionic comonomers containing sulphonic or sulphate groups.

Dry and wet-spinning techniques can be used for the production of the fibre. When dry spinning is used the polymer is dissolved in dimethylformamide (DMF). If the fibre is manufactured through wet spinning, besides DMF, dimethylacetamide, dimethylsulphoxide, ethyl carbonate and aqueous solutions of inorganic salts or acids are also used. Residues of these solvents (0.2 - 2 % of the weight of the fibre) are found in the waste water from pretreatment.

2.1.1.4 Polypropylene fibres (PP)

The isotactic polymer is used for fibre production. Due to the tertiary carbon atom, PP is very sensitive to high temperature and oxidation. Alkylated phenols or p-xylols, together with sulphides or thio-derivatives (dilauryl- or distearyl thiopropionate) are used as stabilizers. Substances with benzotriazol groups, Ni complexes, anthrachinon derivatives and steric hindered diamines are used as UV-absorbents. These low molecular weight substances remain in the PP fibres and are considered as possible emission-relevant substances.

2.1.1.5 Elastane (EL)

Elastane fibres are made out of an elastomer containing at least 85 % of polyurethane (PU). For the production of the fibre (dry spinning) the polymer is dissolved in dimethylacetamide. Residues of this solvent remain in the fibre (<1 % on the weight of the fibre) and are found in the waste water from pretreatment.

To reduce the high adhesive characteristics and to guarantee sufficient gliding properties during processing, preparation agents are applied to the fibre (approximately 6 – 7 % add-on). These auxiliaries contain 95 % silicone oils and 5 % surfactants. The high percentage of silicone oils will cause environmental concerns during pretreatment of the textile material, when these substances have to be removed.

2.1.1.6 Viscose (CV)

The starting material is the cellulose that is extracted from coniferous timber and supplied to the fibre manufacture in sheets about 1cm thick. The wood contains ca. 40 – 50 % cellulose that is useable to make viscose. The cellulose is first allowed to swell in a NaOH solution. The white flakes obtained are then treated with carbon disulphide until the sodium cellulose xantogenate is formed. The xantogenate is soluble in diluted sodium hydroxide and the formed solution (pulp) is already called viscose. The pulp then needs to be spun. Spinning consists in coagulating the xantogenate solution at the outlet of the spinneret in an acid bath containing sulphuric acid, sodium sulphate and zinc sulphate.

2.1.1.7 Cupro (CU)

Cellulose (wood pulp) can also be dissolved in an aqueous solution of ammonia and copper sulphate. Cupro fibres are produced by wet spinning.

- Synthetic pyrethroids insecticides (SPs)
 - Cypermethrin
 - Deltamethrin
 - Fenvalerate
 - Flumethrin
 - Cyhalothrin
- Insect growth regulators (IGRs)
 - Cyromazine
 - Dicyclanil
 - Diflubenzuron
 - Triflumuron

The organochlorines are hazardous due to their persistence and bioaccumulability. They are thus likely to have long-range effects (in terms of both distance from the source and time after release). γ -Hexachlorocyclohexane (also called lindane) is the most toxic (and also the most active as pesticide) of the hexachlorocyclohexane isomers (α - and β -HCHs). The technical crude product contains α - and β -HCH, the β -isomer being the most persistent. Lindane and DDT compounds are well-studied substances with demonstrated endocrine disrupting capacity.

The synthetic pyrethroid insecticides show high aquatic toxicity (predicted no-effect concentration for cypermethrin is estimated at 0.0001 $\mu\text{g/l}$, while the corresponding value for the OPs diazinon and propetamphos is 0.01 $\mu\text{g/l}$ – UK environmental quality standards expressed as annual average). Organophosphates have lower aquatic toxicity than synthetic pyrethroids and are less persistent than organochlorines. Nevertheless they have high human toxicity (problems may therefore arise for example, for dyers with steam volatile OPs) [279, L. Bettens, 2001].

All major grower countries have banned the use of organochlorine pesticides for sheep treatment, but there is evidence that wool from some former Soviet Union States and South America contain lindane at detectable concentrations. This would suggest that either their grazing is heavily contaminated or that this compound continues to be used occasionally for sheep treatment against ectoparasites.

Wool from the majority of grower nations contains residual sheep treatment medicines which are used legally to control infestations of lice, ticks and mites. These materials may be organophosphates, typically diazinon, propetamphos and trans-chlorfenvinphos, synthetic pyrethroids, typically cypermethrin and insect growth regulators such as cyromazine. The incidence of these materials on wool is variable and depends on the permitted legal use pattern in each country.

Manufacturers can use a database containing quantitative information on the OC, OP and SP content of wool from major producing countries. ENco maintains one such database. Manufacturers use these data to avoid processing wool from suspect sources. The system is of immediate benefit to manufacturers who purchase and process wool from known sources. Commission processors of either loose fibre or yarn may be not aware of the origin of the fibre they are processing and so find it more difficult to control their raw material inputs using this approach.

More information regarding ectoparasiticides is reported in Section 2.3.1 where the wool scouring process is discussed.

2.1.1.10 Silk

Silk accounts for only 0.2% of the total fibre production. Nevertheless, this fibre is very important for specific "niche" articles such as ladies' shirts, jackets and scarves.

Silk is derived from the silk worm, which spins a cocoon around itself. It is a protein fibre like wool and it is the only natural filament fibre to be used with success in the textile industry (the length of the thread is in the range of 700 to 1500m).

The silk fibre is composed of fibroin filaments wrapped with sericine (silk gum), which has to be removed during the pretreatment.

2.1.1.11 Cotton and flax

Cotton fibre consists mainly of cellulose and some other components, as shown below.

Substance	Content
Cellulose	88 - 96 %
Pectin substances	0.7 - 1.2 %
Wax	0.4 - 1.0 %
Proteins	1.1 - 1.9 %
Ash	0.7 - 1.6 %
Other organic components	0.5 - 1.0 %
Source: [186, Ullmann's, 2000]	

Table 2.1: Chemical composition of cotton fibre

Cotton production may use chemicals such as pesticides, herbicides and defoliant and these may remain as a residue on raw cotton fibres that reach the textile mill. However, this is of little concern for the textile industry (the problem is rather with the growers). In fact, tests of cotton samples from around the world, performed from 1991 to 1993, reported levels of pesticides below the threshold limit values for foodstuffs [11, US EPA, 1995].

Other sources ([207, UK, 2001]) report that a few years ago bails of cotton were found to be contaminated with pentachlorophenol from its use not only as a defoliant, but also as a fungicide applied on the bales of cotton during transport.

Flax is a bast fibre. Many economic factors have contributed to this fibre losing much of its previous importance. Nevertheless flax remains a noble fibre with a wide range of applications.

2.1.2 Chemicals & auxiliaries

A huge number of organic dyestuffs/pigments and auxiliaries are applied in the textile industry. In this document they will be divided into the following categories:

- dyestuffs and pigments
- basic chemicals (also known as “Commodities”), which include all inorganic chemicals and organic reducing and oxidising agents as well as the aliphatic organic acids
- auxiliaries, which comprise all textile auxiliaries containing mainly organic compounds except organic reducing and oxidising agents and organic aliphatic acids. They are also known as “Specialities” - blends and proprietary formulations whose composition is not fully disclosed.

To give an idea of the variety of products available on the market (in particular, auxiliaries), it is worth noting that in the "2000 Textile Auxiliaries Buyers' Guide" more than 7000 commercial products are reported, based on 400 to 600 active components. They are classified according to the well-established TEGEWA nomenclature, according to their functional use in the production process, although the chemical nature of these products is too varied to allocate them unequivocally to one category.

For practical reasons the information about dyestuffs and textile auxiliaries is reported in this document in separate annexes (see Section 8 and Section 9).

2.1.3 Materials handling and storage

Basic fibrous raw materials arrive on site in press-packed bales and are stored in covered warehousing, which may also be used to store and dispatch finished goods to customers.

Basic chemical intermediates, acids, alkalis and bulk auxiliary chemicals are normally held within a bound or contained storage area. Large bulk containers may be situated in the open. High value and moisture- or environmentally-sensitive materials are normally transferred directly to the preparation area ("colour kitchen") from where they are dispensed.

Some synthetic organic colourants are regarded as a potential health hazard. Therefore colour kitchens are normally equipped with air extraction and filter systems to suppress dust levels in the workplace during dispensing.

The chemicals (dyestuffs, pigments, basic chemicals and auxiliaries) are metered out either in powder form or as solutions. This operation can be done manually or with computer-aided metering devices.

The required measured amounts of products must in general be dispersed, diluted or mixed before being fed to the finishing machinery. Various systems are found in the industry, ranging from completely manual procedures to fully automatic ones. In the case of manual systems the prepared chemicals are added directly into the machine or in a storage container near the equipment, from which they are then pumped into the machine. In larger companies the chemicals are usually mixed in a central mixing station, from which they are supplied to the various machines through a network of pipes. The quantities and the addition of chemicals and auxiliaries are normally called up automatically according to predetermined programmes (further details about dosing and dispensing systems are given in Section 4.1.3).

2.2 Fibre manufacturing: chemical (man-made) fibres

Man-made fibres are typically extruded into continuous filaments. The continuous filaments can then be:

- used directly (in general, following further shaping or texturing)
- cut into staple length and then spun in a process resembling the one used for wool or cotton (see Section 2.4).

Three main methods are used to produce the continuous filaments (primary spinning):

- melt spinning
- dry spinning
- wet spinning.

Melt spinning: The polymer is melted in a melt-extruder. The liquid is forced through the spinner opening under pressure and cooled by a jet of air to form the filament. A spinning preparation (spin finish) is generally applied at the bottom of the spinning duct. The melting process is suitable for thermoplastic fibres such as polyester, polyamide, polyolefins (e.g. polypropylene) and glass fibre.

Dry spinning: The polymer is dissolved in a solvent. The dissolved polymer is extruded through a spinneret into a chamber of heated air or gas where the solvents evaporates and the filament forms. This filament is further after-treated with a spin finish. The dry spinning process is principally used for acetate, triacetate and polyacrylonitrile.

Wet spinning: The polymer is dissolved in solution. The solution is forced under pressure through an opening into a liquid bath in which the polymer is insoluble. As the solvent is dissipated the fibre forms. The solvent can be dissipated through extraction or by means of a chemical reaction between the polymer solution and a reagent in the spinning bath (reactive spinning). The residual solvent can be extracted by simple washing. After the thread is formed and the solvent is washed out, a spin finish can be applied. Wet spinning produces viscose, acrylic fibres.

Following primary spinning, the applied treatments vary, depending on the final product and the processed fibre. Two simplified process sequences can be identified for this stage:

1. process for the manufacturing of continuous filament in flat or texturised form
2. process for the manufacturing of staple fibres.

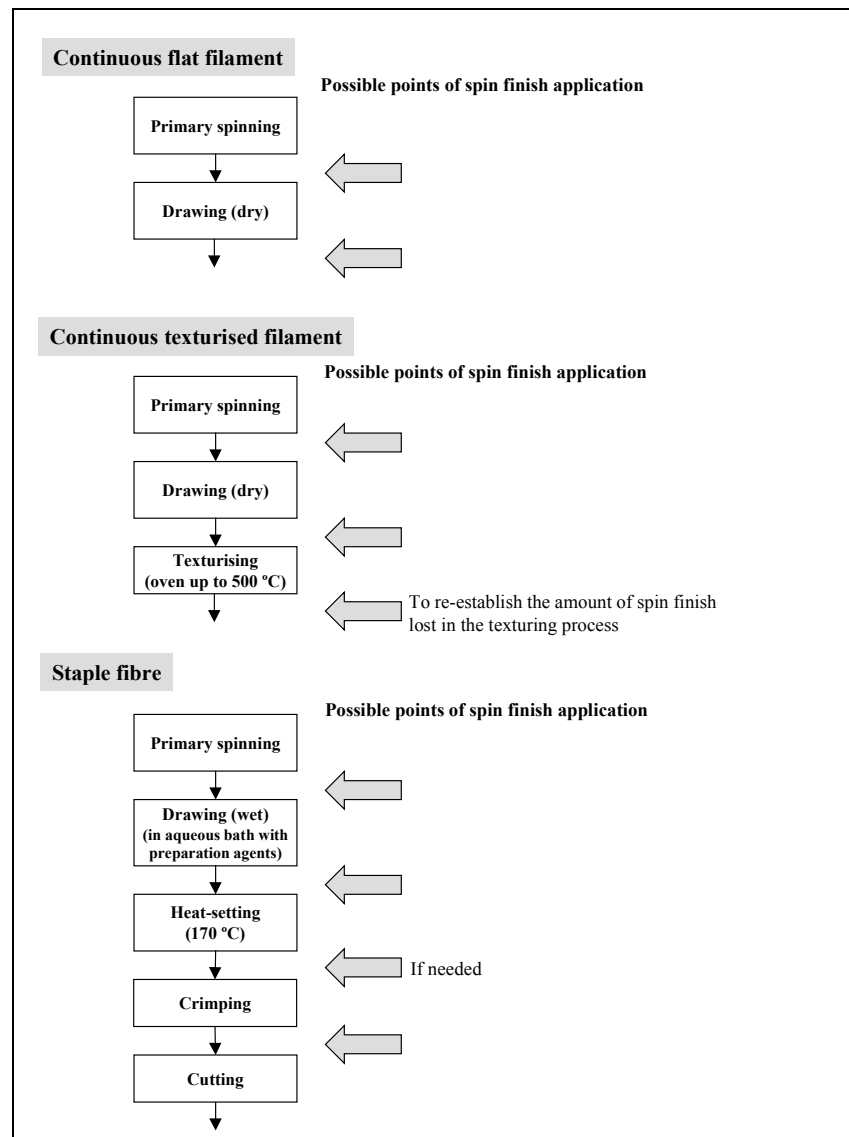


Figure 2.2: Simplified process sequences for manufacturing of continuous filaments (flat and texturised) and staple fibres

As shown in the diagrams above, preparation agents can be applied at various stages during the manufacture of the chemical fibres. Application of preparation agents in primary spinning (fibre manufacturing) is usually followed by further additions during secondary spinning, when the yarn is manufactured, including operations such as coning, twisting, warping, etc.

The preparation agents need to be removed to ensure uniform penetration of dyes and finishing agents and to avoid reaction or precipitation with them. Due to their high organic content and their often-low biodegradability, these substances are responsible for waste water pollution and air emission in the subsequent fibre pretreatment. Particularly relevant in this respect is the production of continuous filaments destined for the production of knitted fabric and the manufacturing of elastomeric fibres, because in this case the amount of preparation agents applied is higher.

The amount of preparation agents applied varies according to the fibre (e.g. PES, PA, etc.) and make-up (flat or texturised filament, staple fibre). Information about the chemistry of the preparation agents and the amount applied on the fibre is given in Section 8.2.

2.3 Fibre preparation: natural fibres

2.3.1 Wool

Wool is usually opened and de-dusted before it is fed to the scour. This is a mechanical process designed to shake out dirt from the wool and to open the fleeces in order to improve the efficiency of the scour in removing contaminants. The process also roughly blends the wool and produces a layer of fibres suitable for presentation to the scour. The opening and de-dusting processes vary considerably in severity depending on the characteristics of the particular wool being processed. The process produces a solid waste comprising dirt, sand, fibre fragments and vegetable matter.

The object of subsequent raw wool scouring processes is to remove contaminants from the wool fibre and to make it suitable for further processing.

Almost all of the scouring plants are based upon aqueous washing. Solvent scouring is much less widely practised. There are world-wide only about five companies that degrease with organic solvents [18, VITO, 1998].

2.3.1.1 Cleaning and washing with water

A conventional wool scouring set is shown in Figure 2.3. The process is carried out by passing the wool through a series of 4 – 8 wash bowls, each followed by a mangle or squeeze press which removes excess scouring liquor from the wool and returns it to the bowl. Clean water is added at the last bowl and passes via a counter-flow system from bowl to bowl with final discharge from the first bowl in a controlled manner to drain.

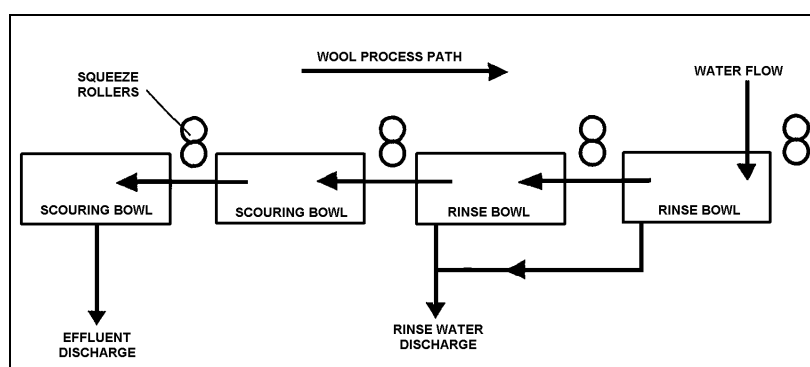


Figure 2.3: Conventional wool scouring arrangement
[8, Danish EPA, 1997]

In the scouring bowls, suint is removed from the wool by dissolution, grease by emulsification and dirt by suspension.

For merino wools, the first bowl may be charged with water only and, in that case, its purpose is the removal of water-soluble suint before the wool enters the scouring process proper (this bowl is usually called “de-suint”).

In order to achieve grease emulsification, the scouring bowls are charged with detergent and often with sodium carbonate, or other alkali, which acts as a detergent builder. Concentrations of detergent and builder are usually highest in the first scour bowl and they decrease in subsequent bowls.

Detergents used by scourers are mainly synthetic non-ionic surfactants, namely alcohol ethoxylates and alkylphenol ethoxylates. Some scourers also report the use of "solvent-assisted detergents" for the removal of marking fluids from fleeces.

Finally, the wool is rinsed by passing it through bowls containing water only.

In coarse wool scouring plants the final bowl of the scouring train is sometimes used for chemical treatments. In this case, it is isolated from the countercurrent liquor flow system and may also be isolated from the drain if the chemical treatment uses ecotoxic chemicals. The most commonly used treatment is bleaching, in which hydrogen peroxide and formic or acetic acid are added to the bowl. Other treatments sometimes applied include mothproofing, using a synthetic pyrethroid insecticide and acetic or formic acid, and sterilisation (of goat hairs) using formaldehyde.

Wool grease has a melting point around 40 °C. Since removal of solid grease from wool by detergents is slow and difficult, 40 °C is the lowest temperature at which aqueous scouring liquors are effective for removing grease. In addition, non-ionic detergents lose efficiency rather rapidly below 60 °C, which means that scour and rinse bowls are typically operated at 55 - 70 °C.

After leaving the final squeeze roller the wool will contain 40 to 60 % moisture. It is therefore dried by convection in a hot-air drier. The drier is usually heated either by closed steam pipes or by direct gas firing. The heat supply to the drier may be controlled by a signal from a device which senses the humidity of the drier atmosphere or the moisture content of the wool at the output end, thus saving energy and avoiding overdrying the wool.

The mechanical design of wool scours and the arrangements for circulating the scour and rinse liquors vary widely. Since these matters have a direct influence on energy and water usage, as well as the partial removal of contaminants from the effluent, it is important to illustrate them in more detail.

New generation scouring plants like the one illustrated in Figure 2.4 have an integrated system for grease and dirt recovery.

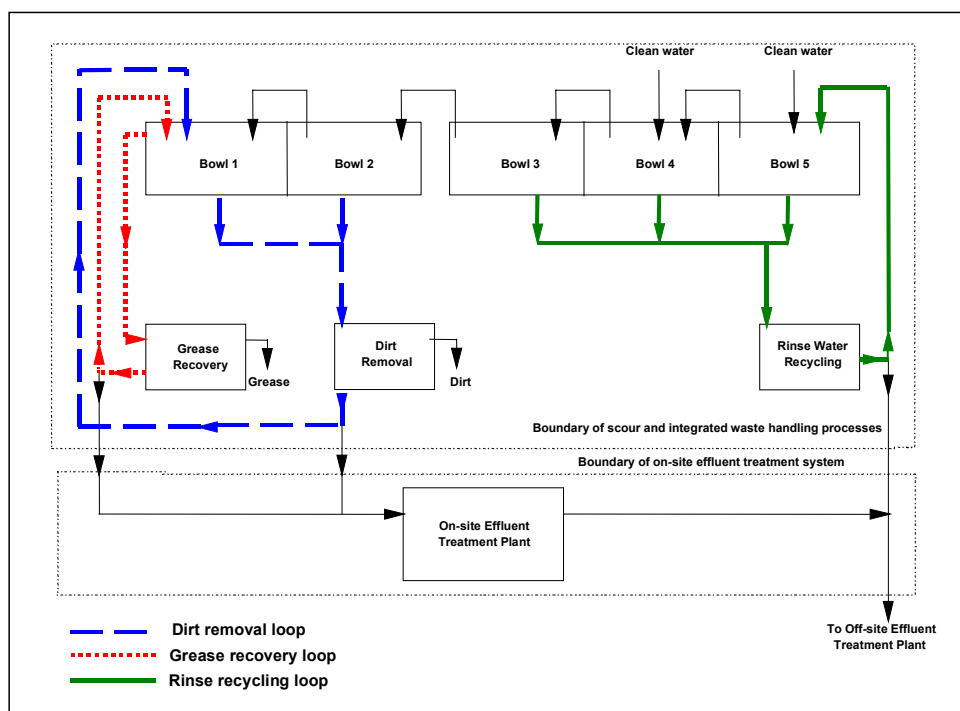


Figure 2.4: Schematic diagram showing a scour line, integrated waste handling process and on-site effluent treatment plant
[187, INTERLAINE, 1999]

The dirt tends to settle at the bottom of the bowl and modern scour bowls usually have hopper-shaped bottoms from which the sludge is removed by gravity through a valve. Opening of the valve may be under the control of a timer or may respond to a signal from a turbidity meter which senses the thickness of the dirt suspension in the hopper bottom. The discharge from the scour bowl hopper bottoms is led to a heavy solids settling tank where it is gravity-settled and the settled liquor partly recycled to scour bowl 1 and partly discharged. Flocculant may be added to the heavy solids settling tank to assist the separation of dirt, or a decanter centrifuge or hydrocyclone may be used in preference to gravity settling for dirt removal.

For grease recovery, modern scour bowls have a side tank in which the grease-rich liquors removed from the wool by the squeeze press are collected. From here, part of the flow may be pumped to the previous bowl or, in the case of bowl 1, to a primary grease centrifuge. The centrifuge separates the liquor into three phases. The top phase, referred to as the cream, is rich in grease and passes to secondary and possibly tertiary centrifuges for further dewatering, finally producing anhydrous grease; the bottom phase is rich in dirt and goes to the heavy solids settling tank; the middle phase is impoverished in both grease and dirt compared with the input and this is split, part being recycled to scour bowl 1 and part being discharged.

In a commonly used variation of the above recycling arrangements, the dirt and grease removal and recycling loops may be combined. In this case, scouring liquor may be removed from the bottoms of the bowls only, or from top and bottom, and passed first through the dirt removal equipment, then through the primary grease centrifuge.

Some scourers recycle rinse water (see Figure 2.4). The flowdown from the first rinse bowl can be treated to make it suitable for addition to the feed to the final rinse bowl. Normally, this is accomplished by removing dirt in a hydrocyclone and processing the water through a membrane filtration plant to remove other impurities.

It is normally necessary to purge dirty liquors which collect at the bottoms of the rinse bowls, but this is not always the case.

Purging of rinse bowls will depend upon the efficiency of the bowls. Some modern scours have rinse bowls discharge controlled by solid detectors, but generally rinse bowls merely have a timed discharge of bottom liquor which operates automatically whatever the state of the liquor [208, ENco, 2001].

The dirt removal and grease recovery loops described above serve several purposes. They save water, by recycling effluent to the scour, and they act as a process-integrated partial effluent treatment. The recovered wool grease can be sold, although the market for this by-product has been variable in most recent years. Finally, since the discharges from the loops are the only points at which heavily contaminated scour liquors are discharged, valves and meters at these points can be used to control the rate of water usage in the scouring section.

For more information about the performance of the dirt removal and grease recovery loops, see Sections 3.2.1, 4.4.1 and 4.4.2.

2.3.1.2 Environmental issues associated with wool scouring (with water)

This section discusses the environmental issues associated with the overall scouring process including the treatment of the process effluent.

The main environmental issues associated with the wool scouring process arise from emissions to water, but solid waste and the air emissions also need to be taken into account.

Potential for pollution of water

The removal of contaminants present on the raw fibre leads to the discharge of an effluent in which the main polluting contributors are:

- highly concentrated organic material in suspension and in solution, along with dirt in suspension
- micro-pollutants resulting from the veterinary medicines applied to protect sheep from external parasites.

There are also detergents in the discharged water, which contribute to the increase of the chemical oxygen demand of the effluent. The detergent is recycled via the grease recovery/dirt removal loop. As a result, low efficiency in this recovery system is associated with higher amounts of detergent in the effluent. Compared to the chemical oxygen demand attributable to wax, dirt, etc., the detergents can be considered minor contributors to water pollution, but this is not the case when harmful surfactants such as alkylphenol ethoxylates are used as detergents (for more detail on environmental issues regarding detergents, see Section 8.1).

As to the organic matter coming from wax and dirt, according to "Stewart, 1988" the COD of effluent and of greasy wool can be calculated using the following equation:

$$\text{COD}(\text{mg}/\text{kg}) = (8267 \times \text{suint}(\%)) + (30980 \times \text{oxidised grease}(\%)) + (29326 \times \text{top grease}(\%)) + (6454 \times \text{dirt}(\%)) + 1536.$$

Since the coefficients for top grease and oxidised grease² in this equation are similar and since approximately equal quantities of top grease and oxidised grease are present in many wools, it is possible to combine the two grease terms in the above equation as follows:

$$\text{COD}(\text{mg}/\text{kg}) = (8267 \times \text{suint}(\%)) + (30153 \times \text{total grease}(\%)) + (6454 \times \text{dirt}(\%)) + 1536$$

It is then possible to calculate the COD content of "typical" merino and crossbred wools:

² Top grease is unoxidised grease which is readily separated from scour liquors by centrifuging; oxidised grease is less hydrophobic and is less readily separated.

- Merino wool: suint = 8 %; grease = 13 %; dirt = 15 %

$$\text{COD} = (8.267 \times 8) + (30.153 \times 13) + (6.454 \times 15) + 1.536 = 556 \text{ g/kg greasy wool}$$

- Crossbred wool: suint = 8 %; grease = 5 %; dirt = 15 %

$$\text{COD} = (8.267 \times 8) + (30.153 \times 5) + (6.454 \times 15) + 1.536 = 315 \text{ g/kg greasy wool.}$$

These high levels of oxygen-depleting substances must be removed from the effluent before it can be discharged to the environment without potential for harmful effects.

Organohalogen, organophosphorus compounds and biocides are among the priority substances listed for emission control in the IPPC Directive.

Worldwide, the most common ectoparasiticides used for treating sheep are diazinon (OP), propetamphos (OP), cypermethrin (SP) and cyromazine (fly-specific IGR), for control of blowfly. Insect growth regulators such as dicyclanil, diflubenzuron and triflumuron are registered only in Australia and New Zealand. Organochlorine pesticides (in particular, hexachlorocyclohexane) are still found on wool coming from the former Soviet Union, the Middle East and some South American countries [187, INTERLAINE, 1999] (see also Section 2.1.1.9).

Concerning the fate of ectoparasiticides when they enter the scouring process, a distinction has to be made between lipophilic and hydrophylic compounds such as cyromazine. The lipophilic compounds – OCs, OPs and SPs – associate strongly with the wool grease and are removed with it during scouring (although a fraction – up to 4 % – is retained by the fibre and will be released in the subsequent finishing wet processes). This behaviour applies also to diflubenzuron (IGR). Recent studies have shown that triflumuron (IGR) associates partially with the dirt and partially with the grease. As a result, compared to other lipophilic compounds, a higher proportion of this pesticide is likely to be retained on-site (on the wool fibre and on the recovered wool grease and dirt) and not be discharged in the aqueous effluent [103, G. Savage, 1998]. On the contrary, IGRs such as cyromazine and dicyclanil are appreciably water-soluble (11 g/l at 20 °C, for cyromazine), which means that they are not removed in wool grease recovery systems.

In the waste water treatment systems an additional fraction of the pesticide residues is removed. Physico-chemical separation techniques remove the biocide residue at approximately the same rate as the grease and the dirt with which they are associated. On the other hand, evaporation systems remove OCs and SPs in significant quantities, but up to 30 % of the OPs may appear in the condensate because they are steam volatile. The water-soluble compounds, such as the IGR cyromazine are probably not removed from the effluent stream except by evaporating treatments [187, INTERLAINE, 1999].

Despite these treatments, the removal of pesticides is often incomplete and there is potential for pesticides to enter the aquatic environment when the effluent is discharged. The environmental concentrations of ectoparasiticides in the receiving water depend greatly on local circumstances, in particular, the amount of scouring activity concentrated in a given catchment and the dilution available between scouring discharges and the river which receives the treated effluent.

In areas of Europe with a high concentration of scouring activity, there is a risk of high concentration levels of pesticides in the receiving water. In this case, it is preferable to define discharge limits on the basis of risk assessment models. In UK for example, statutory environmental quality standards (EQS) for the OCs and non-statutory standards for the OPs and cypermethrin have been defined. Discharge limits are set up for processing mills by comparing the given EQS targets with predicted environmental concentrations based on tonnage of wool processed and typical effluent treatment systems.

The control of the discharge limits at the scouring mills is carried out by using data from the ENco Wool & Hair Pesticide database (to define the initial amount of residues on the incoming wool) in combination with the above-mentioned water-grease partition factors for the different pesticides. For more detailed information see also Sections 2.1.1.9 and 3.2.1 (“Ectoparasiticides”).

Potential for pollution of land

Two main "wastes", grease and sludge, are produced as a consequence of the scouring activities (and related effluent treatment).

Depending on its oxidation extent, it may be possible to recover from 20 to 40 % of the grease initially present on the raw wool. This is to be regarded as a by-product rather than a waste, since it can be sold to lanolin refiners for the production of high-value products in the cosmetic industry. However, high levels of pesticides residues in the grease can also be a problem for the lanolin refiners, especially for the production of lanolin-based pharmaceuticals and cosmetics, since more expensive and sophisticated techniques have to be used to reduce the pesticides to acceptable levels. Acid-cracked grease has no market value and has to be landfilled.

The sludge produced as a result of physico-chemical treatment of waste water also contains grease, dirt and the portion of pesticides which are strongly associated with either grease or dirt. Concentrates and sludges from evaporation or membrane filtration may also contain suint, which is mainly potassium chloride and potassium salts of fatty acids. Suint is a by-product which can be used in agriculture.

Sludge and concentrate disposal may follow several routes:

- incineration (with heat recovery)
- pyrolysis/gasification
- brick manufacturing
- composting or co-composting with other organic material
- landfill.

The first three sludge disposal routes destroy the organic material in the sludge, including grease and pesticides. The ash from incineration may contain potassium salts, derived from suint, and heavy metals characteristic of the soil on which the sheep producing the wool have grazed. The ash is normally disposed of to landfill. The characteristics of the char from pyrolysis/gasification are unknown and this char is also typically disposed of to landfill. The use of wool scour sludges in brick manufacture results in no residues for immediate disposal. These three sludge disposal methods probably have the least potential to pollute land.

Wool scour sludges cannot be composted alone, but require the addition of carbon-rich organic material. Green waste from agriculture or horticulture has been used. Composting is not yet regarded as a fully developed, fail-safe technique and only partly degrades the pesticides present in the sludge. However, since the pesticides present in the sludge are there because of their lipophilicity or their strong propensity to absorb onto solids, they are likely to be immobile in soil, and spreading of compost derived from wool scour sludges on agricultural land is unlikely to pose an environmental risk of any significance.

Landfill is the simplest and often cheapest method of disposal of sludges. In the longer term, however, landfill is not believed to be either economically or environmentally sustainable. The fate of wool scour sludges in landfill is not known, but there is a small potential for the ectoparasiticides present to arise in leachate. Anaerobic degradation of the organic material in the sludge will give rise to methane emissions [187, INTERLAINE, 1999].

Potential for pollution of air

Air pollution is not a main issue for wool scouring processes. Nevertheless two issues can be mentioned.

Hot acid cracking, which involves heating the scour effluent with sulphuric acid, when used near residential areas, has been the subject of odour complaints.

Incineration is used in conjunction with evaporation of the effluent because the surplus heat from the incinerator can be used in the evaporation process. Incineration of wool scour sludges has potential for air pollution. Since sludges contain relatively high levels of chloride (from suint) as well as organically bound chlorine from ectoparasiticides etc., there is potential for the production of polychlorodibenzodioxins and furans, when they are incinerated (catalytic and high temperature incinerators are now available to prevent these emissions). The sludges also contain relatively high levels of sulphur and nitrogen and the combustion process therefore produces SO_x and NO_x . Dust and odours should also be taken into account.

2.3.1.3 Cleaning and washing with solvent

Various solvent processes exist that use a non-aqueous solvent for scouring wool.

The Wooltech wool cleaning system involves the use of trichloroethylene and does not use any water in the washing process. A schematic layout of the process is shown in Figure 2.5.

The following information was submitted by [201, Wooltech, 2001].

Wash bowls

Wool is received in bales, unpacked and then fed into the reception area. This wool is lightly broken up and fed through a series of solvent wash bowls (typically 3 or 4) and washed with a countercurrent flow of solvent. Up to 10 kg of solvent is added for the production of 500 kg of clean wool, however this is a function of plant management and maintenance, the exact plant arrangement, and the quality of wool being processed.

Clean, solvent saturated wool is taken from the last wash bowl to a centrifuge where the solvent concentration is reduced to around 4 wt%. A centrifuge has been found to be particularly effective in this duty owing to the low surface tension and significant density of trichloroethylene. The wool with a small quantity of solvent is taken to a dryer where warm air is used to evaporate the last quantity of solvent. The processing area from the wash bowls through to the centrifuge and the dryer is all fully enclosed and is kept under a slight negative pressure by evacuating air to a vapour recovery system.

The solvent from the first washing bowl is processed through high-speed centrifuge equipment to remove solid particles and recycled back to bowl 1. A proportion of the fluid is drawn off for grease removal and upgrading for recycling.

Dirt separation

The dirt slurry from the Dirt Separation stage is sent to an indirect heated Dirt Dryer, where the solvent is evaporated off (and recovered), leaving a warm, dry, and solvent free dirt stream.

Expected pesticide analysis of dirt will result in no organochlorines (OC), less than 1 ppm organophosphates (OP) and less than 0.1 ppm synthetic pyrethroids (SP). Further reducing these levels requires the relatively simple modification of fitting a small Solid Bowl Centrifuge, such that the dirt slurry, on its way to the dirt dryer, is rinsed with fresh solvent. This will remove the grease-associated pesticides from the dirt and send these back to the evaporator where they will leave with the grease stream.

Solvent evaporation system

Solvent is recycled by various stages of evaporation in the Solvent Evaporation System. The first stage of evaporation is a multiple effect evaporator, which does the bulk of the solvent recovery work. It boils the spent solvent from a concentration of typically 2 wt% grease up to 20 wt% grease (i.e. 90 % recovery of solvent). To recover all possible solvent from the grease, it has been found necessary to use three stages of evaporation – each at progressively lower pressure and higher temperature. It has been found practical to evaporate the grease down to containing <1 wt% solvent, corresponding to a 99.98 % recovery of solvent through the evaporation stage.

Vapour recovery unit

Other areas where solvent is recovered include when the vapour leaves the dirt dryer, when the solvent laden air leaves the wool dryer, and when the air saturated with solvent is extracted from the wash bowl area/ wool centrifuge/ wool dryer area. The combined stream from these areas is sent to a Vapour Recovery Unit. This consists of a refrigerated primary collection system followed by activated carbon adsorption recovery system.

Solvent destruction

As discussed, the Wooltech wool cleaning system does not use any water in the washing process. There is, however, a small flow of water into the solvent system. This is due to moisture in the wool, moisture in the air and some input from vacuum raising equipment (steam ejectors). This water, referred to as fleece and steam moisture, is separated from the clean solvent in the solvent recovery section by gravity. Whilst the solubility of the solvent in this water is low, it is nevertheless saturated in solvent, which is thus removed in a two step process.

In the first step, most of the small proportion of solvent in fleece and steam moisture is removed by heating the water and stripping it with air in the Solvent Air Stripping Unit. The small flow of solvent is recovered by condensing it and then by passing it through the Vapour Recovery Unit.

In the second step, a free radical process based on Fenton's reaction (a redox reaction between iron and hydrogen peroxide) is used to remove the traces of solvent left after stripping in fleece and steam moisture. Using an improved Fenton effect, the Residual Solvent Destruction Unit is effective in eliminating all traces of solvent from water by oxidizing/de-halogenating, thereby destroying the solvent molecules. The solvent is broken down into chloride ions, carbon dioxide and water upon treatment with hydrogen peroxide. Provision is allowed to ensure the water is neutralized prior to discharge. The fine detail of the destruction process is confidential, however processes that use the improved Fenton Effect are well established.

Another source of waste in the Wooltech plant is contaminated liquids from maintenance activities or as a result of recovered spills. These fluids are treated in a very similar manner to process water. The first step of Maintenance/Spill Recovery and Recycle is the recovery of the bulk of the solvent, which is performed by boiling most of the solvent from the water. Finally, the mildly contaminated water is treated in the Residual Solvent Destruction Unit.

It is expected that the Enhanced Fenton Process Residual Solvent Destruction Unit will reduce hazardous substances in water (including solvents, breakdown products and water-solubilized pesticides) to near zero. This is consistent with the long-term objectives (2020) set by OSPAR (protection of the marine environment) and the European Water Framework Directive (for surface waters).

Air emissions

Stack emissions of trichloroethylene (TCE) in air will meet new VOC directives of <2ppm using a scrubbing fluid comprising of activated carbon slurry in water. This fluid will then be treated as outlined above in the Residual Solvent Destruction Unit. It should be noted, however, that TCE is very unstable and is readily broken down by free radicals that are photo-induced in the air by ultraviolet radiation (the Photo-Fenton effect). The hydroxyl radicals involved in the destruction are the same as used in the liquid treatment described above.

Auxiliary water

A small boiler unit is also used as a separate utility with a boiler blowdown of approximately 11 kg/h. The water quality in the boiler is directly related to the characteristics of the local water sources.

Energy consumption

The consumption of electricity in the cleaning process (not including treatment of emissions) is 0.243 kWh/kg of greasy wool. Natural gas consumption is 0.79 MJ/kg of greasy wool.

2.3.1.4 Environmental issues associated with wool scouring (with organic solvent)

The Wooltech system described above, uses trichloroethylene as solvent. Trichloroethylene is a non-biodegradable and persistent substance (trichloroethylene is on the EPER list). Unaccounted losses of this solvent arising from spills, residues on the fibre, etc., if not adequately treated to destroy the solvent, may lead to diffuse emissions resulting in serious problems of soil and groundwater pollution.

As far as water and energy consumptions are concerned, the Wooltech system shows lower consumption levels compared to a typical scouring process using water. A more accurate balance of the inputs and outputs in this process is reported in Section 3.2.2.

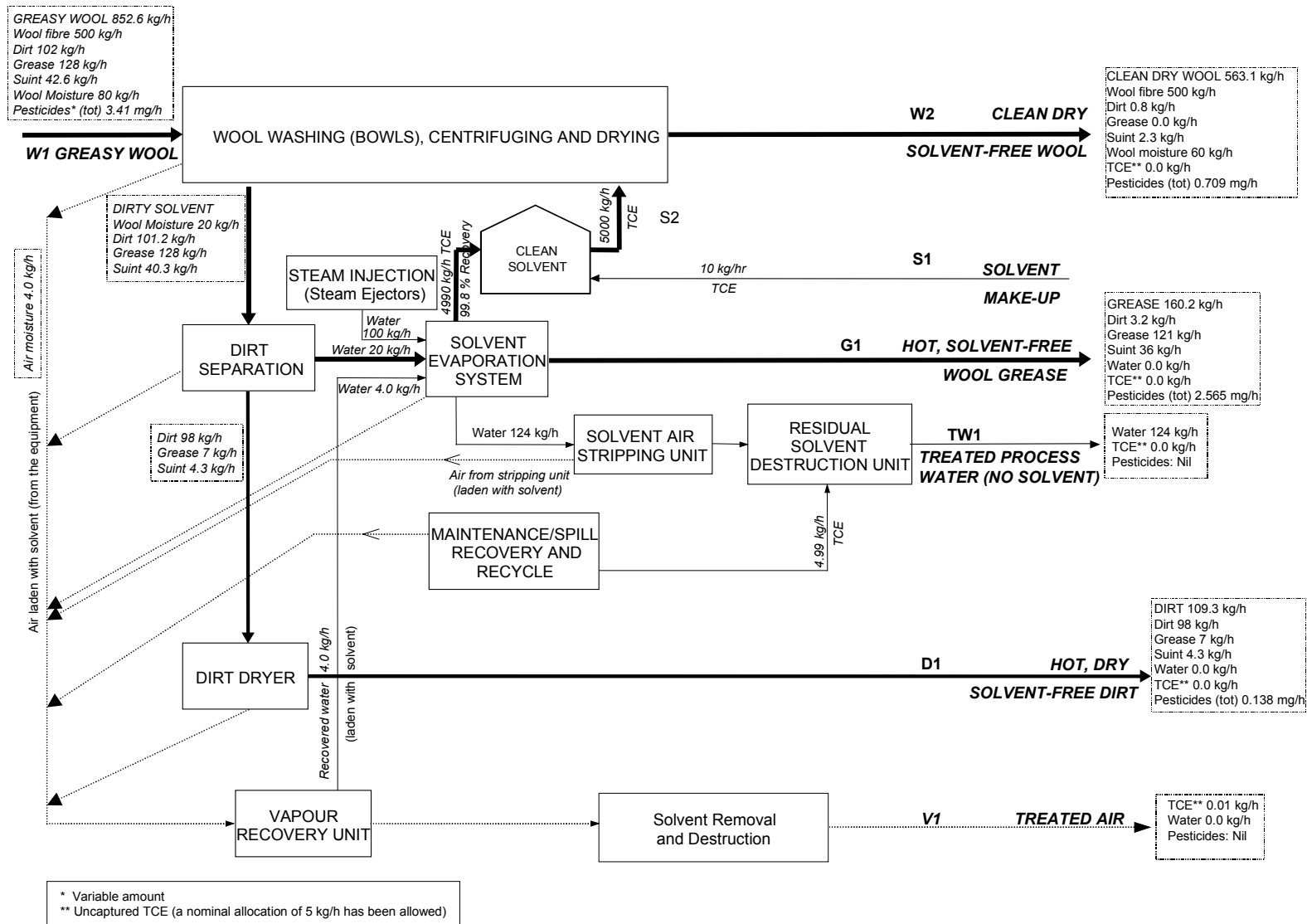


Figure 2.5: Simplified scheme of the Wooltech process

2.3.2 Cotton and flax

Raw cotton is a much cleaner raw fibre than wool and initial operations are mainly dry. The fibres are supplied to the spinning mill in compressed bales. The fibres are sorted by grade, cleaned to remove particles of dirt and blended with fibres from different bales to improve the consistency of the fibre mix. Sorting and cleaning is performed in machines known as openers.

With flax, the isolation of the fibre from the flax stem is done in different steps. After crop (plucking) the flax is retted (dew retting, water retting, enzymatic, microbiotic, steam or chemical retting). Retting is a wet process that can result in waste water with high contents of COD and BOD: pectinic and hemicellulosis substances are degraded in this step. Rovings are produced by further mechanical treatment before spinning.

2.3.3 Silk

For silk production the silk worm is killed with steam and the filament is unwound directly from the cocoon. The filament is submitted to pretreatment processes to remove the silk gum and other organic impurities (see Section 2.6.3).

2.4 Yarn manufacturing

Almost all textile apparel products are made from spun yarns of 100 % natural fibres, 100 % man-made staple fibres or blends. Only a few apparel products, for instance smooth sportswear, are made exclusively of filament yarns (although increasing use is being made of fabrics that contain multifilament yarns, generally textured, and one or more staple fibre yarns).

Secondary spinning is the process by which staple fibres are transformed into yarn suitable for the textile industry. There are two main spinning processes:

- the wool spinning process
- the cotton spinning process.

2.4.1 The wool spinning process

The wool spinning process is mainly used to produce wool and wool-blend yarns. A distinction is made between the worsted and woollen process. In worsted spinning, higher-quality and longer fibres are processed and the result is a fine yarn which is used to produce worsted fabric. In the woollen spinning system, shorter fibres are processed.

In the worsted process the fibres are paralleled in a combing machine and are then drawn and spun. In the woollen system the fibres are only carded and then spun. The resulting yarn is then twisted (if required) and finally prepared for the subsequent treatments (dyeing, weaving, tufting, etc) through an operation called winding.

In both the woollen and worsted systems the various fibres (e.g. wool fibres from different sources, different types of synthetic fibres) are combined during the blending operation. In order to allow efficient mechanical processing in the subsequent operations, spinning lubricants are applied to the fibres at this stage (or later, before or after carding, depending on the system applied).

2.4.2 The cotton spinning process

The cotton spinning process is generally used for cotton and man-made fibres. As has already been described in Section 2.3.2, cotton fibres are first submitted to opening and cleaning operations. The following steps, which are the same for cotton and man-made fibres, are:

- carding
- combing
- drawing
- roving
- spinning
- twisting (if required)
- winding.

2.4.3 Environmental issues

The preparation agents (conditioning agents and spinning lubricants) applied to the fibre during the spinning process have significant environmental implications for the subsequent finishing steps of the textile chain. Since these auxiliaries, together with spin finishes added in primary spinning (in the case of man-made staple fibres), need in general to be completely removed before dyeing, they are found either in the exhaust air from the high-temperature processes or in the water from wet treatments. In the first case they give rise to air pollution, whereas in the second they contribute to the organic load of the final effluent.

Spinning lubricants may be responsible for the emission not only of hard-to-biodegrade organic substances such as mineral oils, but also of hazardous compounds such as polyaromatic hydrocarbons, APEO and biocides.

The resulting pollution depends on the type and amount of lubricant applied to the fibre. In the wool spinning process, for example, a distinction must be made between fabric derived from carded yarn (woollen process) and fabric manufactured using combed yarn (worsted process). There is a substantial difference, in fact, not only from a mechanical point of view, but also in the quantity of lubricants applied. This is approximately 5 % in the woollen process and is always less than 2 % in the worsted process (this consideration only holds for textiles, because in the woollen process for carpet yarn, the amount of lubricants ranges from 1 to 1.5 %).

As regards synthetic fibres (staple fibres), the amount of preparation agents applied at the yarn manufacturing stage is especially relevant in the case of elastomeric fibres where the final content of preparation agents (mainly silicone oils) can be in the order of 7 % of the weight of the fibre.

Additional information about the composition of spinning oils is given in Section 8.2. It is, however, difficult to analyse in detail the environmental aspects associated with the use of these substances because of the large variety of commercial products. Spinning mills usually buy lubricants from dealers, who buy chemical products from large petrochemical producers, and mix them according to the specific needs of each spinning mill. This makes even more difficult the identification of the chemical substances present on the yarn when this enters the finishing mill.

2.5 Cloth production

Raw materials for cloth production are spun yarns and filament yarns. These raw materials can then be converted into:

- woven textiles
- knitted textiles
- floor-coverings and non-woven fabrics.

The last item covers a number of different end-products which are typical of the carpet industry.

2.5.1 Woven textiles

2.5.1.1 Warping

Before weaving, warp yarns are wound onto beams in a process called warping. During this operation there is no consumption of auxiliary agents that could have a negative influence on the emissions from the subsequent finishing processes.

In some cases (wool mills) the warp yarn is not sized, but treated with liquid paraffin.

2.5.1.2 Sizing

In order to lubricate and protect the warp yarn during weaving, sizing agents (in the form of water solutions or water dispersions) are applied after warping. The main sizing agents can be grouped into two classes:

Sizing agents based on native polysaccharides:

- starch
- starch derivatives such as carboximethyl starch or hydroxyethyl starch ether
- cellulose derivatives, especially carboximethyl cellulose (CMC)
- galactomannans
- protein derivatives.

Fully synthetic polymers

- polyvinyl alcohols (PVA)
- polyacrylates
- polyvinyl acetate
- polyester

The ratio of synthetic sizing agents to native sizing agents is variable (e.g. about 1:3 in Germany [179, UBA, 2001], 1:4 – 1:5 in Spain [293, Spain, 2002]).

It is important to bear in mind that:

- the type of sizing agent applied varies according to the fibres to be processed, the weaving technique adopted and the demands of any system used for recycling the sizing agents
- sizing agent formulations are usually mixtures of the substances mentioned above.

With cotton, additional auxiliaries are present in the sizing mixtures. These are mainly [186, Ullmann's, 2000]:

- viscosity regulators: complex formation between borax and the hydroxyl groups of starch increases the viscosity of the paste, while urea reduces it. Important viscosity regulators include starch-degrading agents such as peroxodisulphates, peroxosulphates that act by oxidative cleavage of the macromolecules
- sizing fats: are used to improve the weaving behaviour of the warp. Suitable materials include sulphated fats and oils and mixtures of fatty acid esters with non-ionic and anionic emulsifiers
- antistatic agents (mainly based on polyglycol ethers)
- wetting agents: fatty alcohols poly(glycol ethers) with a low degree of ethoxylation.
- de-foaming agents: their addition is often necessary when the sizing agents tend to produce foam (e.g. with PVA) or if wetting agents are added. Suitable products are based on paraffin oils, phosphoric esters, fatty acid esters or silicone oils
- preservatives: for sizing liquors that are stored for long periods and contain degradable components such as starch and starch derivatives, fungicides and/or bacteriocides are added. Typical preservatives include formaldehyde, phenol derivatives, heterocyclic compounds of the isothiazoline type.

Sizing agents used for synthetic fibres (e.g. polyacrylates, polyesters) do not contain these auxiliaries, except for the preservatives, which are always to prevent bacteria attack present when aqueous systems are used.

Sizing agents are introduced by the weaving firm, but have to be removed by the finisher (during the operation called desizing). This desizing process results in high waste water loads. In the case of woven fabric, sizing agents can represent 30 – 70 % of the total COD load in waste water. The lower percentage is for finishing of woven fabric mainly consisting of flat filament yarns and the higher for staple fibres, especially for cotton and in case of native sizing agents. Therefore it is important to know the COD of these substances and their characteristics in terms of biodegradability and bioeliminability. Note that additives present in the formulations (e.g. the preservatives) also influence the aquatic toxicity and biodegradability of the resulting emissions (toxicity and biodegradability cannot be discriminated by using only COD measurements).

Section 8.3 gives more details about:

- characteristics of the chemical substances commonly used as sizing agents and specific COD and BOD₅ values
- typical amounts applied on the various fibres.

2.5.1.3 Weaving

Weaving is the process by which yarns are assembled together on a loom and a woven fabric is obtained. The process only requires electricity. Lubricants and oils are used to lubricate the loom, but in particular cases they may contaminate the fabric.

2.5.2 Knitted textiles

2.5.2.1 Waxing

The yarn specially made for the knitting industry is lubricated or waxed (generally with paraffin wax) to allow knitting at higher speed and protect the yarn from mechanical stresses. Waxing may be done while re-winding the yarn onto bobbins, in which case the process is normally called “preparation for knitting”.

2.5.2.2 Knitting

Like weaving, knitting is a mechanical process and involves knotting yarn together with a series of needles. Mineral oils are widely used to lubricate the needles and other parts of the knitting machinery. The quantity of oils used depends on the technology of the machine and on the speed of the needles. The value ranges between 4 and 8 % of the weight of the fabric (when mineral oils are used the amount may rise to 10 %).

The oil and the wax that remain on the final fabric will be washed out during the finishing treatments. Their contribution to the total pollution load coming from finishing mills may be significant.

Additional information about knitting oils is reported in Section 8.2.5.

2.5.3 Textile floor-coverings

Textile floor-covering is a collective noun for articles having a usable surface of textile material. This particular class of cloths can be schematically described as composite substrates made up of the following layers:

- a *carrier layer*, which is mainly made of polypropylene strips of fabric (75 %), PP or PES webs (16 % and 8 %, respectively) and less commonly of jute fabric (1 %) [18, VITO, 1998]
- a *pile yarn (or more generically a face fibre)*, which can equally well be made from filament or staple fibre yarns (mainly polypropylene, polyamide, polyester, wool, acrylic fibres).
- a *pre-coating layer*, which is typical of tufted carpet and whose function is to anchor the pile onto the carrier layer. This coating layer is made from synthetic rubber or an artificial dispersion based on carboxylated styrene-butadiene rubber latex.
- a *coating layer*, which is an additional layer applied to the bottom side of the carpet. It is possible to distinguish between foam coating, textile back coating and heavy coating methods. The purposes of this final layer are various. Mainly, it is intended to strengthen the attachment of the pile, improve dimensional stability of the carpet and provide the carpet with properties such as anti-slip, heat insulation, stepping elasticity, or even flame retardancy (carpet coating techniques are described in more detail under the finishing treatments in Section 2.11).

This is, however, a very general definition. In fact, the characteristics of the end-product and the applied manufacturing techniques can vary significantly. The principal methods of manufacturing carpet/floor-coverings are tufting, weaving and needling (other methods are knotting, bonding, knitting, etc.). The best way to describe these techniques is probably to describe the different types of carpets.

2.5.3.1 Tufted carpet

As the figure below shows, tufted carpets are made up of the following different components:

- the face yarn (pile), which can be made from either staple fibres (PA, PP, PES, PAC, wool and cotton) or synthetic filaments
- the primary backing (carrier layer)
- the pre-coating layer
- the back-coating layer (which can consist of a textile back-coating or of a foam coating layer).

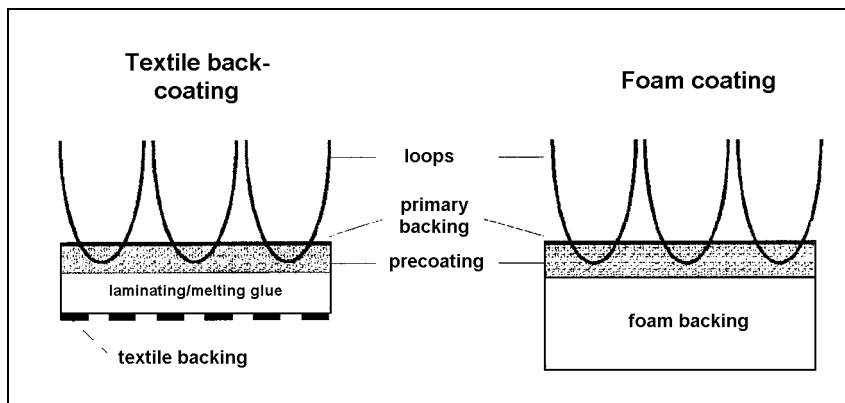


Figure 2.6: Cross-section of a tufted carpet
[63, GuT/ ECA, 2000]

In the tufting process, pile yarns (face) are inserted by needles into a woven or non-woven carrier material (primary backing), made of polypropylene, polyester or jute, across the entire width of the substrate (up to 5m). During subsequent manufacturing processes the base of the pile yarn is anchored in the back of the carpet by means of an applied coating.

Figure 2.7 is a simplified representation of a tufting plant.

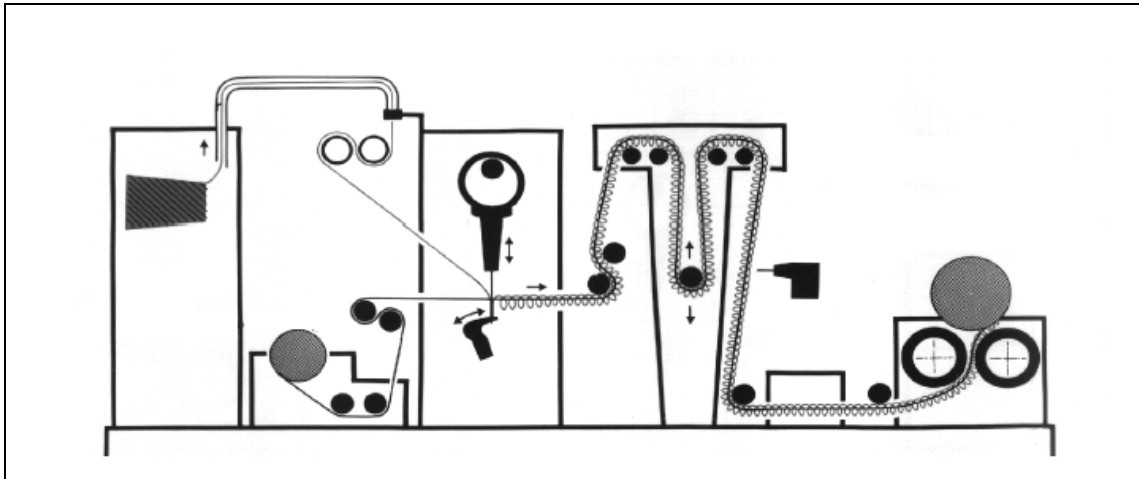


Figure 2.7: Simplified representation of a tufting plant
[63, GuT/ ECA, 2000]

Through variations of the tufting technique, different three-dimensional pile structure can be produced as well as patterned carpets (e.g. level loop pile, multi-level loop pile, cut and loop, velvet and velour, saxony).

Figure 2.8 shows two examples of carpet styles.

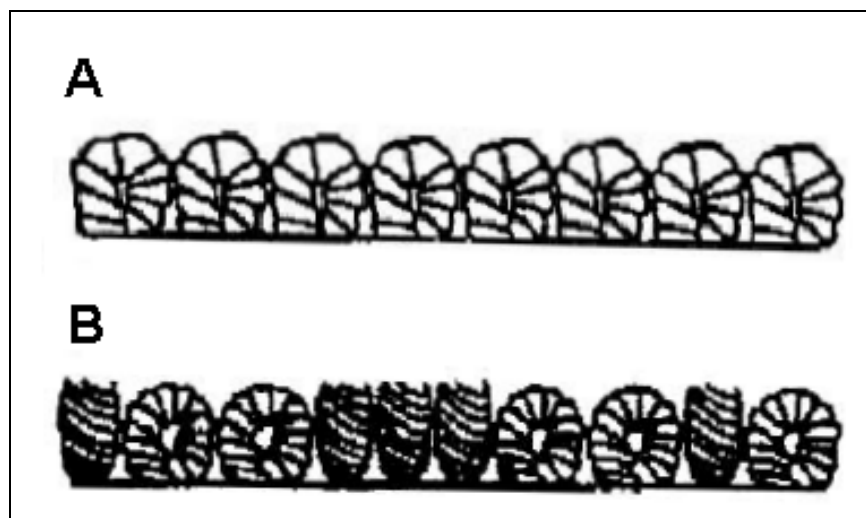


Figure 2.8: A: Level loop pile; B: Cut and loop pile
[63, GuT/ ECA, 2000]

2.5.3.2 Needle-felt carpet

Figure 2.9 shows the manufacturing process for needle felt carpets. The fibres lie criss-cross to each other and are compressed with needles. This compression is fixed with binding agents [18, VITO, 1998]. Needle-pile carpets can consist of one or several layers, with or without a carrier layer. They may be equipped with various types of backings (textile backing, foam, heavy coating). For lasting binding of the fibres, the needled substrate is subsequently subjected to further thermal or chemical treatment (chemical reinforcement).

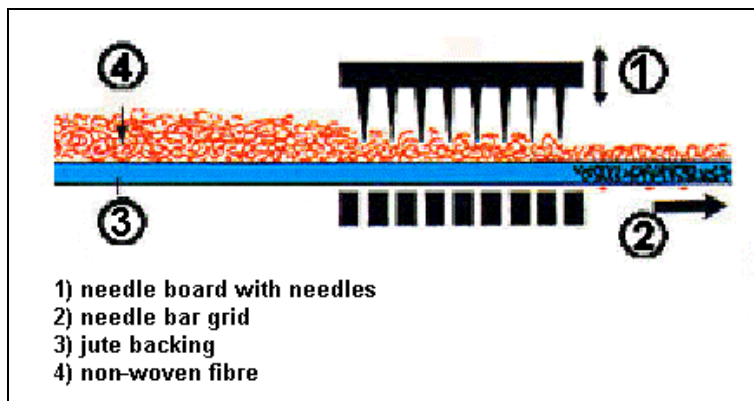


Figure 2.9: Manufacture of needle-felt carpet
[63, GuT/ ECA, 2000]

Almost all fibres may be used for the production of needle felts; however, man-made fibres are mostly used (PP, PA, PES, PAC, wool, jute/sisal, viscose).

2.5.3.3 Woven carpet

The manufacturing process for woven carpets is similar to the manufacturing of any other woven good. Since coarse types of yarns are used for woven carpets, the warp is normally not sized. A scheme of the production process for woven carpets is reported in Figure 2.10.

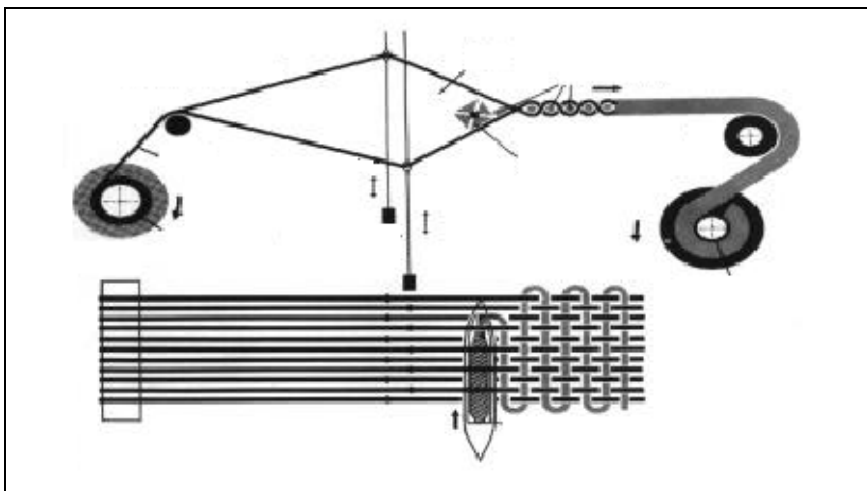


Figure 2.10: Representation of the production process for woven carpets
[63, GuT/ ECA, 2000]

As a rule, woven carpets are provided with a stabilising back-coating. Only in rare cases is an additional heavy coating (e.g. PVC or bitumen) applied.

2.5.4 Non-woven textiles

Textiles manufactured without an intermediate yarn-processing step are called non-wovens. The application of these textiles is quite broad ranging from backings for coatings, filters, geotextiles and other technical textiles to dishcloths, etc.

In the fabrication of non-woven textiles the only significant environmental impact is normally associated with the off-gases emitted during the thermal and chemical bonding steps. The volatile compounds mainly originate from fibre inherent monomers (especially caprolactame), monomers in the bonding polymers, etc.

2.6 Pretreatment

Pretreatment processes should ensure:

- the removal of foreign materials from the fibres in order to improve their uniformity, hydrophilic characteristics and affinity for dyestuffs and finishing treatments
- the improvement of the ability to absorb dyes uniformly (which is the case in mercerising)
- the relaxation of tensions in synthetic fibres (without this relaxation of tension, unevenness and dimension instabilities can occur).

The position of pretreatment within the production scheme is closely related to the position of dyeing in the sequence. The point is that pretreatment comes immediately before dyeing (and printing).

Pretreatment processes and techniques depend:

- on the kind of fibre to be treated: for raw goods made of natural fibres such as cotton, wool, flax and silk the technical task is more difficult than for those made of synthetic and artificial fibres. Natural fibres in fact are accompanied by a higher amount of substances that can interfere with later processing. Man-made fibres, in turn, usually contain only preparation agents, water-soluble synthetic size and soil
- on the form of the fibre (flock, yarn, woven or knitted fabrics)
- on the amount of material to be treated (for example, continuous methods are more efficient, but are economically viable only for large production capacities).

Pretreatment operations are often carried out in the same type of equipment used for dyeing (in batch processing, in particular, the material is most often pretreated in the same machine in which it is subsequently dyed). For ease of reading of this part of the document, machines that are not specific to a given treatment are described in a separate annex (see Section 10).

2.6.1 Pretreatment of cotton & cellulose fibres

2.6.1.1 Principal manufacturing processes

Cotton pretreatment includes various wet operations, namely:

- singeing
- desizing
- scouring
- mercerising (and caustification)
- bleaching.

Some of these treatments are obligatory steps only for certain make-ups (e.g. desizing is carried out only on woven fabric).

Moreover some of these treatments are often combined together in one single step in order to respond to the need to reduce production time and space as much as possible. Nevertheless, for practical reasons they will be described as separate treatments, leaving the discussion about possible process sequences for specific make-ups to the following sections.

Singeing

Singeing can be carried out both on yarns and woven fabrics, but it is more common on fabrics, especially on cotton, cotton/PES and cotton /PA substrates.

Protruding fibre ends at the fabric surface disturb the surface appearance and produce an effect known as "frosting" when dyed. It is therefore necessary to remove the surface fibres by passing the fabric through a gas flame. The fabric is passed over a row of gas flames and then immediately into a quench bath to extinguish the sparks and cool the fabric. The quench bath

often contains a desizing solution, in which case the final step in singeing becomes a combined singeing and desizing operation.

Before singeing, the fabric is combed under aspiration to eliminate remaining dust and fibres.

Singeing has no effect on the effluents because only cooling water is necessary. During singeing relatively strong odours and emissions of dust and organic compounds are observed [209, Germany, 2001]. Odorous substances can be destroyed using catalytic oxidation techniques (see Section 4.10.9).

Desizing

Desizing is used for removing from woven fabric sizing compounds previously applied to warp (see Section 2.5.1.2) and is usually the first wet finishing operation performed on woven fabric.

Desizing techniques are different depending on the kind of sizing agent to be removed.

Currently applied techniques can be categorised as follows:

1. techniques for the removal of starch-based sizing agents (water-insoluble sizes)
2. techniques for the removal of water-soluble sizes
3. techniques for the removal of water soluble and insoluble sizes.

1. *Techniques for the removal of starch-based sizes*

Starch-based sizes are difficult to remove and require either catalytic action of an enzyme (catalytic degradation) or other chemical treatment in order to be converted into a washable form. This chemical degradation is mainly achieved by either enzymatic or oxidative desizing.

Enzymatic desizing is the most widely used method for the removal of starch, amylases being particularly suitable. The advantage in the use of enzymes is that starches are decomposed without damaging cellulose fibre.

In order to reduce the number of steps in the pretreatment process, it is common practice to combine desizing with cold bleaching in a single step. In this case the process is also called "*oxidative desizing*". The fabric is impregnated in a bath containing hydrogen peroxide and caustic soda, together with hydrogen peroxide stabilisers and complexing agents. Persulphate is also usually added to the solution.

Due to the action of NaOH, this treatment, beside a desizing/bleaching effect, also serves as a pre-scouring treatment. Furthermore, oxidative desizing is particularly useful when the textile contains enzyme poisons (fungicides) or when sizes are present that are difficult to degrade. However, because starch scarcely differs from cellulose in the cross-linking of the cellulose rings, chemical oxidation, if not well controlled, can damage the fibre.

Desizing is usually carried out in pad-batch, but discontinuous (e.g. jigger) and continuous (pad-steam) processes can also be applied. In the case of enzymatic desizing, pad-steam is applied only for big lots and with enzymes that are stable under steaming conditions. After the reaction time, the fabric is thoroughly washed in hot water (95 °C).

2. *Techniques for the removal of water soluble sizes*

The removal of water-soluble sizes such as PVA, CMC and polyacrylates, theoretically only requires washing with hot water and sodium carbonate. However, the washing efficiency can be increased by:

- adding suitable auxiliaries (wetting agents) to the desizing liquor (with some restrictions in case of size recovery)
- allowing adequate time for immersion in the desizing liquor (this ensures maximum liquor pick-up and adequate time for the size to swell)
- washing thoroughly with hot water in order to remove the solubilised size.

In this case the process is carried out in normal washing machines. Continuous washers are often used, but sometimes the treatment time may be too short to allow complete desizing. Pad-batch and pad-steam or discontinuous processes for prolonging the residence time are therefore also in use.

3. *Techniques for the removal of water soluble and insoluble sizes*

The “oxidative desizing” technique mentioned above is applicable not only for water insoluble sizing agents, but also for water soluble ones. This technique is particularly useful for textile finishers dealing with many different types of fabrics and therefore sizing agents (see also Section 4.5.2).

Mercerising

Mercerising is carried out in order to improve tensile strength, dimensional stability and lustre of cotton. Moreover an improvement in dye uptake is obtained (a reduction of 30 – 50 % of dyestuff consumption can be achieved thanks to the increased level of exhaustion).

Mercerising can be carried out on yarn in hanks, woven and knitted fabric through one of the following different treatments:

- mercerising with tension
- caustification (without tension)
- ammonia mercerising.

Mercerising with tension

Caustic soda mercerising is the most commonly applied mercerising technique (it is not applied to flax). Cotton is treated under tension in a solution of concentrated caustic soda (270 - 300g NaOH/l, which means also 170 – 350 g NaOH/kg) for approximately 40 - 50 seconds.

During mercerising the temperature is adjusted at low values (5 - 18 °C) when the lustre is the priority and at slightly higher levels when the improvement of the other characteristics is preferred. Because the reaction between caustic soda and cellulose is exothermic, cooling systems are applied to keep down the temperature of the bath.

Beside the conventional cold treatment, a hot mercerising process is also now increasingly applied (for hanks and fabric). The material is soaked in a solution of caustic soda close to boiling point. After hot stretching, the fabric is cooled down to ambient temperature and washed under tension.

In order to ensure a homogeneous penetration of the liquor, especially when operating at ambient temperature, wetting agents are employed. Sulphonates mixed with non-ionic surfactants and phosphoric esters are the most commonly used.

Caustification

In the caustification process, the material is treated at 20 – 30 °C with caustic soda at lower concentration (145 – 190 g/l) without applying tension. The material is allowed to shrink, thus improving the dye absorption.

Ammonia mercerising

Cotton yarn and fabric can be treated with anhydrous liquid ammonia as an alternative to caustic soda. Effects similar to mercerising are obtained, although the lustre grade is inferior to caustic soda mercerising. Traces of ammonia have to be removed, preferably with dry heat treatment followed by steaming.

This method is not widely used. Only a few plants are reported to use ammonia mercerising in Europe.

Two examples of mercerising machines respectively for woven fabric (Figure 2.11) and for knitted fabric in tubular form (Figure 2.12) are reported below.

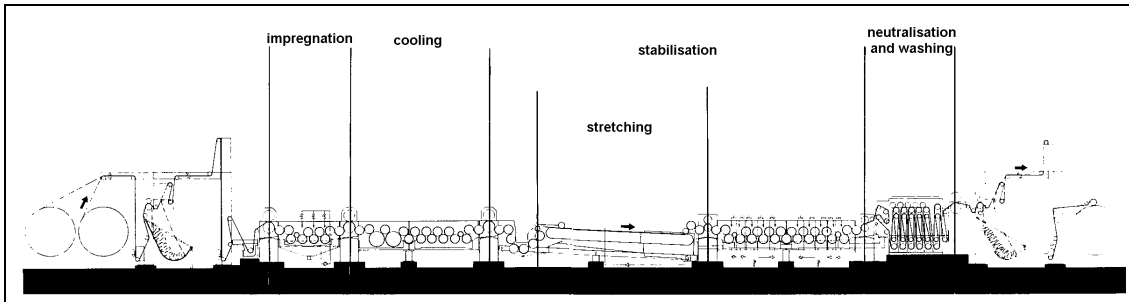


Figure 2.11: Example of Mercerising equipment for woven fabric
[69, Corbani, 1994]

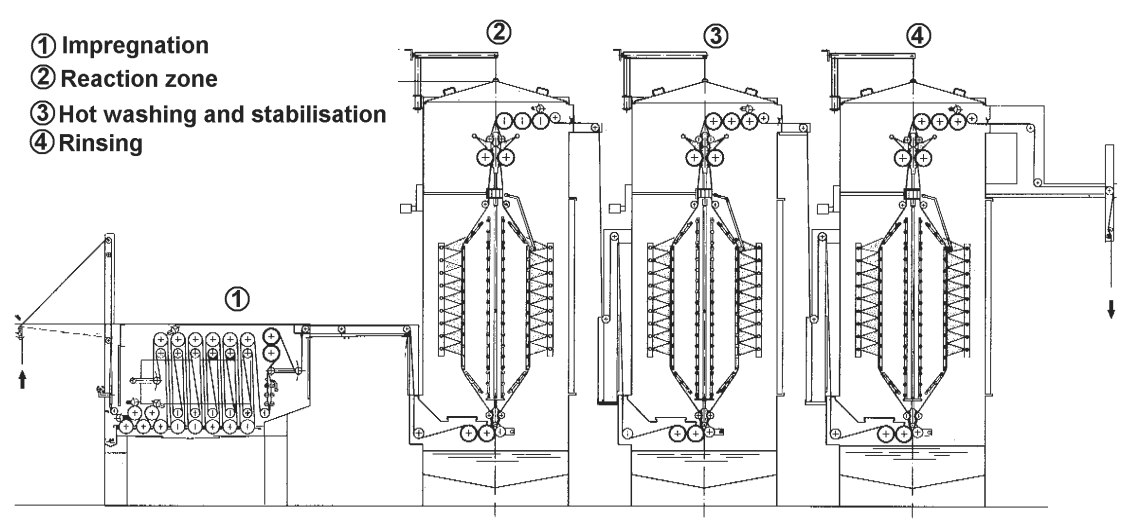


Figure 2.12: Example of Mercerising equipment for knitted fabric in tubular form
[318, Sperotto Rimar, 2002]

Scouring

Scouring (also known as boiling-off or kier boiling) is aimed at the extraction of impurities present on the raw fibre or picked up at a later stage such as:

- pectins
- fat and waxes
- proteins
- inorganic substances, such as alkali metal salts, calcium and magnesium phosphates, aluminium and iron oxides
- sizes (when scouring is carried out on woven fabric before desizing)
- residual sizes and sizing degradation products (when scouring is carried out on woven fabric after desizing).

Scouring can be carried out as a separate step of the process or in combination with other treatments (usually bleaching or desizing) on all kind of substrates: woven fabric (sized or desized), knitted fabric and yarn.

For yarn and knitted fabric, scouring is usually a batch process which is carried out in the same equipment that will subsequently be used for dyeing (mainly autoclaves or hank dyeing machines for yarn and overflows, jets, etc. for knitted fabric). Woven fabric is scoured in continuous mode using the pad-steam process.

The action of scouring is performed by the alkali (sodium hydroxide or sodium carbonate) together with auxiliaries that include:

- non-ionic (alcohol ethoxylates, alkyl phenol ethoxylates) and anionic (alkyl sulphonates, phosphates, carboxylates) surfactants
- NTA, EDTA, DTPA, gluconic acid, phosphonic acids as complexing agents, which are used to remove metal ions (and, in particular, iron oxides, which catalyse the degradation reaction of cellulose when bleaching with hydrogen peroxide)
- polyacrylates and phosphonates as special surfactant-free dispersing agents
- sulphite and hydrosulphite as reducing agents (to avoid the risk of formation of oxycellulose when bleaching with hydrogen peroxide).

Bleaching

After scouring, cotton becomes more hydrophilic. However, the original colour stays unchanged due to coloured matter that cannot be completely removed by washing and alkaline extraction.

When the material has to be dyed in dark colours it can be directly dyed without need of bleaching. On the contrary, bleaching is an obligatory step when the fibre has to be dyed in pastel colours or when it will need to be subsequently printed. In some cases, even with dark colours a pre-bleaching step may be needed, but this is not a full bleaching treatment.

Bleaching can be performed on all kinds of make-ups (yarn, woven and knitted fabric).

The most frequently used for cellulosic fibres are oxidative bleaches, namely:

- hydrogen peroxide (H_2O_2)
- sodium hypochlorite (NaClO)
- sodium chlorite (NaClO_2).

Apart from these, peracetic acid is also applicable [7, UBA, 1994]. Also optical brightening agents are commonly used to obtain a whitening effect.

Bleaching with hydrogen peroxide

Bleaching can be carried out as a single treatment or in combination with other treatments (e.g. bleaching/scouring or bleaching/scouring/desizing can be carried out as single operations).

The textile is treated in a solution containing hydrogen peroxide, caustic soda and hydrogen peroxide stabilisers at pH 10.5 – 12 (the optimal pH for scavenging of the OH^* radical is 11.2, as described in Section 4.5.6). Recent investigations ([210, L. Bettens, 1995]) have shown that the bleaching agent of peroxide is not the anion HOO^- , but the dioxide radical anion OO^{*-} (also known as superoxide). In competition with the formation of the bleaching agent, the OH^* radical is formed, which is responsible for attacking and depolymerising the cellulose fibre. The formation of the OH^* radical is catalysed by metals such as iron, manganese and copper. The prevention of catalytic damage as a consequence of uncontrolled formation of OH^* is mostly taken care of by using complex formers that inactivate the catalyst (stabilisers). Sodium silicate together with Mg salts (MgCl_2 or MgSO_4) and sequestering/complexing agents (EDTA, DTPA, NTA, gluconates, phosphonates and polyacrylates) are commonly used as stabilisers (see also

Section 8.5 for more information about stabilisers and Sections 4.3.4 and 4.5.6 for alternative techniques).

Other auxiliaries used in hydrogen peroxide bleaching are surfactants with emulsifying, dispersing and wetting properties. Employed surfactants are usually mixtures of anionic compounds (alkyl sulphonates and alkyl aryl sulphonates) with non-ionic compounds such as alkylphenol ethoxylates or the biologically degradable fatty alcohol ethoxylates [186, Ullmann's, 2000].

Operating temperatures can vary over a wide range from ambient to high temperature. Nonetheless, a good bleaching action occurs when operating at around 60 – 90 °C.

Bleaching with hydrogen peroxide in neutral conditions (pH range of 6.5 – 8) is also possible in some cases (e.g. when treating cotton in blends with alkali-sensitive fibres such as wool). At these pH conditions activators are required to give bleaching activity. Note that below pH 6.5 H_2O_2 decomposes into H_2O and O_2 by $\text{HOO}^* / \text{O}_2^*$ disproportionation. Under these conditions hydrogen peroxide is wasted (production of inactive O_2 gas).

A wide range of bleaching processes can be used, including cold pad-batch, bleaching under steaming conditions and bleaching processes in long bath.

Because the bleaching agent of peroxide is anionic in nature (hydrophilic behaviour), it is not possible with this bleaching method to destroy selectively the coloured hydrophobic material present on natural fibres without attacking the polymer itself.

Bleaching with sodium hypochlorite

The high reactivity of this bleaching agent imposes softer operative conditions than hydrogen peroxide (pH 9 - 11 and temperatures not above 30 °C). Otherwise there is a risk of damage to the cellulose fibre.

The bleaching stage is followed by an anti-chlorine treatment in order to eliminate completely the hypochlorite and decompose the chloroamines generated during bleaching.

Bleaching with sodium hypochlorite can be carried out in batch (e.g. overflow, jet, jigger, winch beck), semi-continuous (pad-batch) or continuous mode. A two-stage process is also in use in which hypochlorite and hydrogen peroxide are used.

The use of hypochlorite as bleaching agent is in decline for ecological reasons. It is still applied for yarn and knitted fabric when a high degree of whiteness is required, for articles that remain white (e.g. linen), or require a white background or in processes where the ground-dye is discharged with a bleach treatment (see also Section 4.5.5 for alternative techniques).

Bleaching with sodium chlorite/ chlorate

Chlorite/chlorate bleaching, although in decline, is still applied for synthetic fibres, cotton, flax and other cellulosic fibres, often in combination with hydrogen peroxide.

The bleaching agent is the chlorine dioxide gas (ClO_2), which follows a completely different working mechanism compared to hydrogen peroxide. Whereas the superoxide radical ion in hydrogen peroxide is hydrophilic and therefore works preferentially in the hydrophilic region of the fibre (attack of the fibre polymer), ClO_2 absorbs preferentially on the hydrophobic associated material, such as the woody part of bast fibres. For this reason it is an excellent bleaching agent (ensuring a high degree of whiteness and no risk of damage of the fibre) especially for synthetic fibres and for bast fibres such as flax where, compared to cotton, there is a higher percentage of hydrophobic impurities.

Because chlorine dioxide is unstable as a gas and can only be stored as a solution of approximately 1 % in water, it must be generated on-site as an aqueous solution. There are two ClO_2 precursor chemicals in present general industrial use, namely sodium chlorite and sodium chlorate. Although sodium chlorate is considerably less expensive than sodium chlorite, it is more difficult and expensive to convert to ClO_2 , which explains why it is less commonly used.

Both sodium chlorite and sodium chlorate are used in strong acid conditions (pH 3.5 – 4 by formic or acetic acid). Chlorine dioxide solutions have a great corrosive action on construction materials including stainless steel. Sodium nitrate is used as a corrosion inhibitor to protect the stainless steel parts of equipment. It is also necessary to select detergent/wetting agents that can resist acid conditions. On the other hand, sequestering agents are not necessary because the oxalic acid used for acidification also serves for sequestering metals. The order of introduction of the different auxiliaries has to be controlled to avoid direct contact between the concentrated sodium chlorite/ chlorate solution and acids.

The textile material is bleached by padding or in long bath processes. The temperature is normally kept at 95 °C, but cold procedures have also been developed to diminish toxicity and corrosion problems, using formaldehyde as an activator for sodium chlorite.

The advantages of chlorine dioxide bleaching are the high degree of whiteness and the fact that there is no risk of damage to the fibre. The main disadvantages are the high stresses to which the equipment is subjected and the chlorine residues that may be left on the fibre, depending on the way chlorite (or chlorate) is produced and activated. Recent technologies using hydrogen peroxide as the reducing agent of sodium chlorate are now available to produce ClO_2 without generation of AOX (see also Section 4.5.5).

Bleaching with peracetic acid

Peracetic acid is produced from acetic acid and hydrogen peroxide. It can be purchased as ready-made product or produced in-situ. Its optimal bleaching action is reached only in a very narrow pH range between 7 and 8. Below pH 7 the degree of whiteness decreases sharply and above pH 9 depolymerisation of the fibre with consequent damage of the fibre occurs.

Peracetic acid is sometimes applied for synthetic fibres (e.g. polyamide) where hydrogen peroxide cannot be used.

2.6.1.2 Environmental issues

The main environmental issues associated with cotton pretreatment arise from emissions to water.

The characteristics of the emissions vary according to a number of factors: the make-up, the sequence adopted, the fact that some treatments are often combined in a single step, etc.

The most relevant issues are highlighted below for the various operations involved in pretreatment.

Desizing and scouring

In a typical mill processing cotton or cotton-blend woven fabric, desizing represents the main emission source in the overall process. As already stated in Section 2.5.1.2, the washing water from desizing may contain up to 70 % of the total COD load in the final effluent, especially in the case of native sizing agents. Neither enzymatic nor oxidative desizing allows size recovery, while for some synthetic sizing agents size recovery is technically feasible, but difficult to apply for commission companies (see also Section 4.5.1).

Compared to woven cotton fabric, the removal of impurities from yarn and knitted fabric is less significant in terms of pollution load. Nevertheless, consideration must be given to the COD load associated with the removal of knitting oils (for knitted fabric), spinning oils and preparation agents (when cotton is in blend with synthetic fibres) and the biodegradability of these compounds. Substances such as synthetic ester oils are readily emulsified or soluble in water and easily biodegraded. More problems are posed by the presence of substances that are difficult to emulsify and poorly biodegradable such as silicone oils, which are found in elastane blends with cotton or polyamide.

Mercerising

Mercerising is responsible for a large amount of strong alkali that is discharged in waste water and needs to be neutralised. The corresponding salt is formed after neutralisation. In this respect, the cold process involves higher emission loads than the hot one. In order to allow the required retention time and make possible the cooling of the bath in continuous mode, a portion of the bath needs to be taken out and cooled down in continuous mode. This means that higher volumes of bath are necessary in cold mercerising, which result also in higher emissions if the caustic soda is not recovered. Mercerising baths are usually recovered and re-used. When this is not possible, they are used as alkali in other preparation treatments (caustic soda recovery is discussed in Section 4.5.7).

Bleaching with hydrogen peroxide

The decomposition of hydrogen peroxide, which takes place during the bleaching reaction, forms only water and oxygen. However, environmental concerns associated with the use of stabilisers have to be taken into account (see Section 8.5). These products may contain complexing agents such as EDTA and DTPA with poor bio-eliminability, which may pass undegraded through the waste water treatment systems. Their ability to form very stable complexes with metal makes the problem even more serious because they can mobilise heavy metals present in the effluent and release them in the receiving water (see also Section 4.3.4 and 4.5.6 for alternative techniques).

It has been reported ([77, EURATEX, 2000]) that, depending on concentration, pH, time and temperature, effluents containing inorganic chlorides (e.g. NaCl from dyeing and printing, MgCl₂ from finishing) can be oxidised to their chlorites/hypochlorites when they are mixed with hydrogen peroxide bleach waste water. In this way AOX may be found in waste water even if bleaching is carried out without chlorine-based bleaching agents. However, experimental measurements have shown that this does not play an important role, if any [7, UBA, 1994].

Bleaching with sodium hypochlorite

For ecological reasons the use of sodium hypochlorite is now limited in Europe to just a few particular cases, connected with knitted fabric and, in some cases, bleaching of yarn when a high degree of whiteness is required. Bleaching with sodium hypochlorite leads, in fact, to secondary reactions that form organic halogen compounds, commonly quantified as AOX.

Trichloromethane (which is suspected of being carcinogenic) accounts for the bulk of the compounds formed, but other chlorinating subsidiary reactions might occur, besides haloform reaction (see also Section 4.5.5).

When bleaching with hypochlorite, air emissions of chlorine may also occur (although only under strong acid conditions [281, Belgium, 2002]).

According to the Institute of Applied Environmental Research (Stockholm University), in 1991 – 1992 dioxins were found in sludge from a textile plant that bleached with sodium hypochlorite. Further investigations showed that pentachlorophenol was present in the hypochlorite [316, Sweden, 2001].

Bleaching with sodium chlorite

Sodium chlorite bleaching may also be responsible for AOX generation in the waste water. However, compared to sodium hypochlorite, the amount of AOX formed during chlorite bleaching is much lower (on average only 10 % to a maximum of 20 % of the amount of AOX generated by hypochlorite) and it is not correlated with sodium chlorite concentration or with temperature [7, UBA, 1994]. Recent investigations have shown that the formation of AOX is not originated by the sodium chlorite itself, but rather by the chlorine or hypochlorite that are present as impurities or are used as activating agent. Recent technologies (using hydrogen peroxide as the reducing agent of sodium chlorate) are now available to produce ClO₂ without generation of AOX (see also Section 4.5.5).

As already mentioned earlier, handling and storage of sodium chlorite need particular attention because of toxicity and corrosion risks. Mixtures of sodium chlorite with combustible substances or reducing agents can constitute an explosion hazard, especially when they are subject to heat, friction or impact. Sodium chlorite forms chlorine dioxide when put in contact with acids. Moreover, sodium chlorite decomposition produces oxygen, which supports combustion.

2.6.2 Wool preparation before colouring

Typical preparation wet treatments applied on wool fibre before dyeing are:

- carbonising
- washing (scouring)
- fulling
- bleaching.

Other possible treatments are those that go under the definition of anti-felt and stabilisation treatments. Although they are often carried out before dyeing, they are not obligatory preparation steps. For this reason they have been described under finishing operations (Section 2.9.2.8).

2.6.2.1 Principal manufacturing processes

Carbonising

Sometimes scoured wool contains vegetable impurities that cannot be completely removed through mechanical operations. Sulphuric acid is the chemical substance used for destroying these vegetable particles and the process is called carbonising.

Carbonising can be carried out on floc/loose fibre or on fabric (this operation is not applied in the carpet sector).

Loose fibre carbonising is performed only on fibres that are later used to produce fine fabric for garments (worsted fabrics) and usually takes place at the scouring mill.

In typical equipment for carbonisation of loose fibre, the still damp scoured wool is soaked in a solution containing 6 – 9 % of mineral acid (generally sulphuric acid). Excess acid and water are removed by pressing or by centrifugation until on average 5 – 7.5 % of sulphuric acid and 50 – 65 % of water remain. The fibres are then dried at 65 – 90 °C to concentrate the acid and baked at 105 – 130 °C (carbonising).

As soon as the wool is dried, it is fed into a machine, which consists of two counter-rotating rolls. These rolls crush the carbonised particles into very small fragments, which are then easily removed. The addition of small quantities of detergent to the sulphuric acid improves the yield

and reduces the attack on the wool. In order to prevent the fibre from being gradually degraded, the pH is finally set to 6 by neutralisation with sodium acetate or ammonia.

Sulphuric acid can be replaced by gaseous HCl or by aluminium chloride. The latter releases HCl when it is heated: this method is useful for the carbonisation of wool/synthetic fibres mixtures such as wool/PES, that are too sensitive to sulphuric acid.

After carbonising, the fibre can be carded and then spun before being dyed or it can be dyed directly in floc form.

Fabric carbonising is typical of woollen fabrics. The operation can be carried out by either the traditional or the more modern "Carbosol" system.

The conventional procedure is substantially similar to that used for loose fibre. The fabric can be previously soaked in a water or solvent bath and squeezed, but this step is optional. Then it is impregnated in a concentrated sulphuric acid solution (acidification) and squeezed (hydro-extraction) before passing through the carbonising chamber. The carbonised particles are then removed by mechanical action and subsequent washing. In modern carbonising plants all these steps are carried out in continuous mode.

The "Carbosol" process, licensed by SPEROTTO RIMAR, uses an organic solvent instead of water. The equipment consists of three units. In the first one the fabric is impregnated and scoured with perchloroethylene, in the second the material is soaked in the sulphuric acid solution and in the third, carbonising and solvent evaporation take place. At this stage the perchloroethylene is recovered by distillation in a closed loop.

The "Carbosol" system is reported to have several technical advantages over the traditional process. The level of acidity of the fabric after carbonising is much lower and the risk of damage to the wool fibre is reduced. Thanks to full recovery of the organic solvent, the process can also be considered more efficient from the environmental point of view.

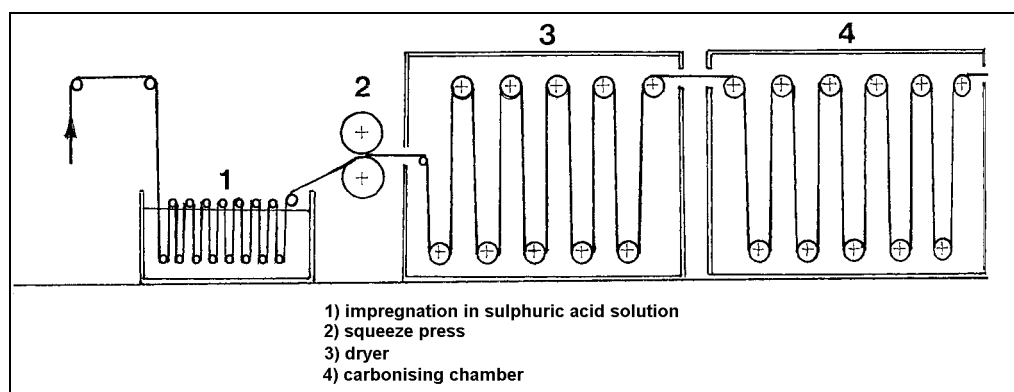


Figure 2.13: Representation of a conventional carbonising installation
[71, Bozzetto, 1997]

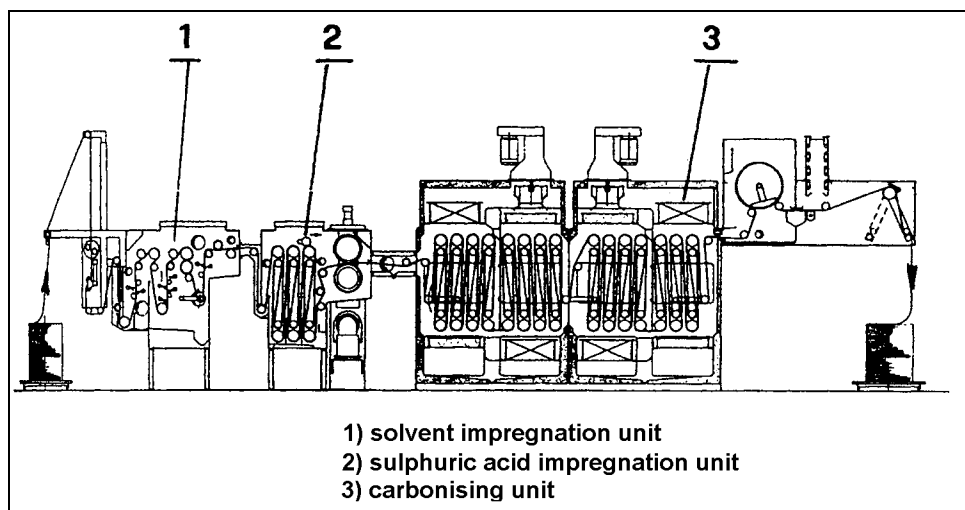


Figure 2.14: "Carbosol" system
[71, Bozzetto, 1997]

Scouring

Both *yarn* and *fabric* contain, besides accidental impurities, a certain amount of spinning oils and in some cases also sizing agents such as CMC and PVA. All these substances are usually removed before dyeing in order to make the fibre more hydrophilic and allow the penetration of the fibre by dyestuffs. However, this operation is not always necessary. In some cases, if the preparation agents are applied in low amounts and they do not interfere with the dyeing process, a separate scouring/ washing step can be omitted.

As pointed out in Section 2.4.1, the percentage of spinning oils on woollen wool is quite relevant and it is always above 5 %, while on worsted wool it never reaches 2 %.

Typical substances that have to be removed by scouring can be classified as:

- soluble in water
- insoluble in water, but emulsifiable thanks to the action of surfactants
- insoluble in water and non-emulsifiable (or difficult to emulsify) with surfactants. These substances can be removed only by using organic solvents (in general, halogenated solvents like perchloroethylene).

As a result the material can be washed (scoured):

- with water or
- with solvent (dry cleaning)

Water washing is carried out in neutral or weakly alkaline conditions (by sodium carbonate or bicarbonate) in the presence of detergents. Commonly used detergents are mixtures of anionic and non-ionic surfactants such as alkyl sulphates, fatty alcohols and alkylphenol ethoxylates. In wool carpet yarn production the scouring process can include simultaneous chemical setting of yarn twist with reductive agents (sodium metabisulphite) and/or application of insect-resist agents (see also Section 2.14.5.1).

Water scouring is normally a batch operation which is carried out in the equipment in which the textile material will be subsequently dyed. This means that an autoclave is the commonly used equipment for yarn, while jets and overflows are the machines typically applied for fabric. In this respect, the carpet sector is an exception. Wool yarn for carpet is scoured on continuous or semi-continuous basis in tape scouring machines (hanks) or in package-to-package scouring machines (package yarn), where the yarn is passed through a series of interconnected bowls (see Section 2.14.5.1.2).

Dry cleaning is less common and is applied when the fabric is heavily soiled and stained with oils from the weaving or knitting process. The most widely used solvent is perchloroethylene. In some cases water and surfactants are added to the solvent to provide a softening effect.

Solvent washing can be carried out either in discontinuous mode in a tumbler (generally for knitted fabric) or in continuous mode in open-width (for woven and knitted fabric). Impurities are carried away by the solvent, which is continuously purified and recycled in a closed loop (see also Section 2.12.2).

Fulling

This treatment takes advantage of the felting tendency typical of wool fibre when it is submitted to friction under hot humid conditions and is a typical pretreatment for woollen fabric.

It is usually carried out after carbonising, but in some cases (e.g. heavy woollen fabrics) it can be done directly on raw fabric. The material is kept in circulation in a bath containing fulling auxiliaries. Both acids (pH <4.5) and alkali (pH >8) speed up the fulling process. Fulling auxiliaries available on the market, however, also produce excellent results under neutral conditions. As a result, fulling either in acid or alkaline conditions is becoming less common. After fulling, the fabric is washed.

Machines specially designed for this process are still in use. However, today they have been largely replaced by multifunctional machines, where both fulling and washing can be carried out by simply adjusting the set-up of the equipment.

Bleaching

Wool is bleached with hydrogen peroxide (sodium hypochlorite may discolour and damage the wool). An additional reductive bleaching is, however, indispensable for achieving high levels of whiteness (full bleach). A typical reductive bleaching agent is sodium dithionite (hydrosulfite), which is often used in combination with optical brighteners to enhance its effect.

In the oxidative bleaching step, hydrogen peroxide is applied in the presence of alkali and stabilisers, which slow down the decomposition of the hydrogen peroxide (see also Section 8.5).

When wool has been previously submitted to an anti-felt treatment it is preferable to use hydrogen peroxide in weakly acid conditions.

2.6.2.2 Environmental issues

Wool pretreatment gives rise mainly to water emissions, although there are also specific operations (e.g. carbonising with the “Carbosol” system and dry cleaning) where halogenated (mainly perchloroethylene) solvents are employed. The use of halogenated organic solvents can produce not only emissions to air, but also contamination of soil and groundwater if their handling and storage is not done using the necessary precautions. Preventive and end-of-pipe measures include closed-loop equipment and in-loop destruction of the pollutants by means of advanced oxidation processes (e.g. Fenton reaction). See Sections 4.4.4, 4.9.3 and 4.10.7 for more detailed information. The process also involves the generation of exhausted active carbon from the solvent recovery system. This solid waste has to be handled separately from other waste material and disposed of as hazardous waste or sent to specialised companies for regeneration.

Due to the predominantly batch nature of wool pretreatment operations for all types of make-ups, the resulting emissions will be discontinuous and with concentration levels largely influenced by the liquor ratios used. An exception is represented by carpet yarn which can be scoured/ bleached and mothproofed on tape or “package to package” scouring machines (see Section 2.14.5.1.2) giving rise to continuous flows.

The pollutants that can be found in the waste water, originate in part from the impurities that are already present on the fibre when it enters the process sequence and in part from the chemicals and auxiliaries used in the process.

Pollution originating from impurities present on the raw material

Residues of pesticides used to prevent the sheep becoming infested with external parasites can still be found on scoured wool in amounts which depend on the efficiency of the scouring process. These are mainly organophosphates (OPs) and synthetic pyrethroid (SPs) insecticides and insect growth regulators (IGRs), but detectable residues of organochlorine pesticides (OCs) can be observed. They partition between the fibre and the water according to their stronger or weaker lipophilic character and, as a consequence, traces of these compounds are released in the waste water. More information about ectoparasiticides can be found in Sections 2.1.1.9 and 2.3.1.2. The partition factors of the different classes of pesticides are discussed in more detail for the carpet sector in Sections 3.4.1.1 and 3.4.1.2.

Note that because of their steam volatility some pesticides (OPs) end up in the air emissions from open machines. This must be taken into account in input/output balances.

Spinning lubricants (see 8.2.3), knitting oils (see 8.2.5) and other preparation agents also represent an important issue in wool pretreatment. These substances are removed during the scouring process, contributing to the COD load and aquatic toxicity in the final effluent. The main concerns are about:

- poorly refined mineral oils (content of aromatic hydrocarbons)
- APEO (non-biodegradable and giving rise to toxic metabolites)
- silicones (non-biodegradable and difficult to remove without scouring assistants)
- biocides (toxic to aquatic life).

The dry spinning route in the carpet sector, described in Section 2.14.5.1, represents one exception because in this case spinning lubricants do not reach the water effluent.

Pollution originating from chemicals and auxiliaries used in the process

Considerable amounts of surfactants are used in pretreatment as detergents, wetting agents, etc. Surfactants with good biodegradability with acceptable performance are now available (see Section 4.3.3). Nevertheless, the use of alkylphenol ethoxylates is still common in some companies due to their low cost. Alkylphenol ethoxylates (APEOs) and in particular nonylphenol ethoxylates (NPEs) are under pressure due to the reported negative effects of their metabolites on the reproduction system of aquatic species. The environmental issues arising from surfactants in common use are discussed in Section 8.1.

Other pollutants of concern that may be found in water effluent from pretreatment activities are:

- reducing agents from bleaching treatments and chemical setting of carpet wool yarn (sodium metabisulphite): they contribute to oxygen demand in the waste water
- poorly bio-eliminable complexing agents (e.g. EDTA, DTPA, phosphonates) from hydrogen peroxide stabilisers, etc.
- AOX from sodium hypochlorite bleaching
- insect-resist agents in wool carpet yarn production.

More details regarding environmental issues associated with the above-mentioned substances are given elsewhere in this document, in particular in Section 2.6.1.2 and Section 8.5.

2.6.3 Pretreatment of silk

The following information has been submitted by Italy [206, Italy, 2001]

Scouring

To prepare a silk yarn for dyeing and silk fabrics for dyeing and printing, it is necessary to partially or completely remove sericin, as well as natural oils and organic impurities. Depending on the percentage of sericin removed during scouring (sericin is present in raw silk in a ratio between 20 % to 25 %), the end-product is defined as unscoured (used only for shirts and suits), 'souple' or degummed.

Scouring can be carried out either on the yarn or on the fabric. It is easier to remove sericin more evenly by performing the operation on the yarn itself. Nevertheless, the operation is generally carried out on the fabric, in order to exploit the protective action of this "natural size" against possible damage during weaving.

The scouring treatment can be carried out in a neutral, acid or alkaline solution, depending on the desired results. At the industrial level, treatment in alkaline conditions is by far the most common. It is extremely important to control the temperature.

Scouring baths present a high total organic charge; the concentration of nitrogen organic components in particular is high.

"Unscoured" silk

The process to produce "unscoured" silk consists in removing from raw silk fabrics all residual substances from previous operations, with a minimal elimination of sericin (1 % - 2 %), so that the fabric keeps the characteristic stiff-handle. The operation is carried out in a slightly alkaline soap bath at low temperature.

"Souple" silk

The process is carried out on weft yarns under acid conditions. The loss of weight is approximately 10 %.

Degummed silk

This treatment is carried out on both yarns and fabrics and ensures a complete elimination of sericin, as well as substances added in previous operations, without modifying the fibroin.

Hydrolytic degradation of the sericin protein macromolecule can be obtained by simply using soaps, by using synthetic surfactants or mixtures of soaps and synthetic surfactants, by means of an enzymatic treatment, or by treating the silk in water at high temperature and under pressure.

In the *degumming process with soap*, yarn and fabric are plunged into two baths (degumming baths). Each bath contains green soap at different concentrations. The treatment is followed by washing with ammonia and rinsing. The process temperature varies between 95 °C and 98 °C. The soap concentration in the degumming bath varies between 10 g/l and 15 g/l. On average the entire treatment lasts for 2 hours. It is possible to re-use exhausted baths after appropriate addition of soap.

Degumming with synthetic detergents implies the partial or total replacement of soap with synthetic non-ionic surfactants (e.g. ethoxylate fatty alcohol). It is also possible to combine a degumming treatment with an oxidizing or reducing bleaching and, in some cases, even with dyeing, thus improving water and energy saving. Generally, alkali and detergent mixtures are used at temperatures around 95 °C - 98 °C. Such a treatment is suited to continuous processing.

Degumming under pressure at high temperature is a specific treatment essentially used to degum yarns. It is necessary to prepare an aqueous bath without surfactants and the temperature should be between 110 °C and 140 °C. A post-treatment washing is required to eliminate substances used in previous processes.

Weighting

The weighting operation is carried out mostly on yarns to promote recovery of the weight loss after the removal of the sericin. The treatment consists in the deposition of tin salts or in grafting polymer chains to the functional groups of the fibroin protein chain.

Weighting is defined as “equal” if the final substrate weight is the same as it was before degumming, and as “higher” if the weight is higher. Weighted silk is different in touch and in draping. The most frequently applied procedure is a “mix weighting” process.

Weighting with minerals

The silk yarn undergoes a treatment using tin tetrachloride in baths at different concentrations (strong or weak baths) in an acid medium. In a strong bath, silk can increase its weight by about 10 % simply by absorbing the salt. The procedure is followed by accurate washing cycles to eliminate unfixed salt and to hydrolyse the salt present on the fibre. Such operations can be repeated to further increase the silk weight. To ensure fixation of tin salts, weighting is completed with a treatment in a sodium phosphate bi-basic solution, followed by a second treatment in sodium silicate.

Disadvantages of this procedure are the long processing time and the high water and energy consumption. The high amount of tin in the waste water is an environmentally undesirable effect of this process.

Weighting with vinyl monomers

Grafting vinyl monomers onto silk represents an alternative to the traditional mineral weighting. Such a method not only allows the desired weight increase to be achieved, but also improves silk characteristics and performance. Co-polymerization with vinyl monomers is carried out using radical activation methods (redox systems, UV, γ rays and so on).

Methacrylamide (MAA) is one of the most frequently applied monomers at the industrial level. MAA weighting is a simple application. Radical activation is obtained through ammonia or potassium persulphate. Other radical activators, which consist of redox systems described in the literature, are not currently applied at the industrial level.

Silk dyeing behaviour can be modified through the weighting treatment. Studies prove how the dyeing affinity of silk weighted with MAA towards the most widely used dyes changes according to the percentage of acquired weight. They also show that wet fastness is reduced in dyeing after weighting.

For the weighting of silk for ties, methacrylamide is the only technique used by industry; at present no MAA substitute is available on the market.

Mix weighting

To achieve a hybrid of the final characteristics of compounds submitted to mineral or MAA weighting, a fairly widely used weighting process on the industrial level is mix weighting with tin/MAA.

2.6.4 Pretreatment of synthetic material

2.6.4.1 Principal manufacturing processes

Typical operations before colouring are washing and thermofixing (heat-setting).

Washing is necessary to remove from the yarn the preparation agents that have been applied to its surface in the previous treatments (usually 2 – 3 %, but can be up to 4 % of the weight of the fibre). Most preparation agents (about 95 %) are removed at this stage (ethoxylated fatty alcohols are commonly used as emulsifying agents). Elastomeric fibres (elastan) are an exception because they contain preparation agents mainly made up of silicone oils in the order of 6 - 7 %. Silicones are more difficult to remove and partly still remain on the fibre (40 % of the initial add-on) after washing. To improve their removal it is common practice to use ethoxylated nonylphenols.

When pretreating woven fabric the removal of sizing agents is a crucial step. The extraction of these substances is achieved thanks to the synergistic action of:

- surfactants (non-ionic or mixtures of non-ionic and anionic): they act as wetting and emulsifying agents and promote the solubilisation of the size
- complexing agents (e.g. phosphonates): they are used when there is a risk of re-precipitation of the components of the sizing agents. An increase in hardness level can occur, particularly, in continuous lines when processing synthetic blends with cellulose fibres (characterised by the presence of Ca, Fe and Mg salts as natural impurities)
- alkali (caustic soda or sodium carbonate): the alkali is chosen according to the sizing agent employed (for example for the removal of sizing agents based on polyacrylates ammonium salts the use of caustic soda is obligatory, while a polyester sizing agent would precipitate in the same pH conditions).

Thermofixation is also another important operation in synthetic fibres pretreatment. Its position within the process can be different, depending on the make-up and the fibre. As a result the following possible sequences are possible:

1. thermofixation – washing – dyeing
2. washing – thermofixation – dyeing
3. washing - dyeing - thermofixation.

If white fabrics are to be produced, bleaching of the fabric may be necessary after thermofixation.

2.6.4.2 Environmental issues

Potentially harmful impurities and additives are already present on synthetic fibres before they are processed at the finishing mill and they account for a large fraction of the pollution load coming from pretreatment.

Some of these impurities are produced during the manufacture of the fibre. They are polymer synthesis by products such as unreacted monomers (for example caprolactame, in the production of PA 6) low-molecular-weight oligomers, and residual catalysts and they are emitted to air during thermal treatments.

Other substances are intentionally added to the fibre to improve subsequent processing. These are the preparation agents used in fibre and yarn manufacturing and the sizing agents.

The average amount of preparation agents applied on man-made fibres (except for elastomeric, where the load can be much higher) ranges between 2 and 4 % of the weight of the fibre (see also Section 8.2).

When the textile is washed, about 80 % of these substances are released to the waste water and the remaining 20 % can be emitted to exhaust air in the subsequent high temperature treatments (drying and thermofixation). Conversely, when thermofixation is carried out on the grey material before washing (which is the case when fine woven and knitted fabric are processed), the main percentage of pollution load is found in the exhaust air.

During high-temperature treatments the lower molecular weight components of the preparation agents (basically lubricants and surfactants) either decompose — resulting in smaller, more volatile molecules — or they react with each other, forming tar. Volatility and tar are undesirable effects because they lead to air emissions and damage to the yarn.

However, thanks to considerable technological improvements achieved by the technology in the field of synthetic fibres, the fibres/filaments leaving the primary spinning process (fibre production) no longer cause fuming. The remaining problems today are connected with those cases where, after the fibre/filament production, lubricants such as coning oils are added to the fibre at a rate of over 2 or even 3 % of the yarn weight [48, VITO, 2001].

The main concerns, as regards waste water, arise from the discharge of poorly or non-biodegradable substances such as mineral oils, EO/PO adducts, silicone oils, hard surfactants, etc. Furthermore, biocides, which are normally contained in the aqueous formulations, contribute to aquatic toxicity of the waste water.

Likewise for air emissions, as for water emissions, the main charging load in waste water again comes from the preparation agents (coning oils, overspray, etc.) that are applied to the fibre/filament after the primary spinning stage. These substances (secondary spinning agents) are applied in significantly higher amounts than primary spinning agents. Moreover, they usually have low affinity with water and are therefore difficult to remove.

For woven fabric, sizing agents also have to be considered. Sizing agents do not give rise to air emissions during HT treatments, but they may be responsible for poorly biodegradable substances and aquatic toxicity.

Information about alternative preparation agents for man-made fibres is given in Section 4.2.1.

2.7 Dyeing

In the following sections the general principles of dyeing and the most commonly used dyeing techniques for the different fibres are described. For practical reasons, detailed information concerning dyeing auxiliaries, dyestuffs and dyeing equipment is given in specific annexes (namely, Sections 8.6, 9 and 10).

2.7.1 General principles of dyeing

Dyeing is a method for colouring a textile material in which a dye is applied to the substrate in a uniform manner to obtain an even shade with a performance and fastness appropriate to its final use. A dyestuff is a molecule which contains a chromophoric group (conjugated system) capable of interacting with light, thus giving the impression of colour.

Textile dyeing involves the use of a number of different chemicals and auxiliaries to assist the dyeing process. Some of them are process-specific, while others are also used in other operations. Some auxiliaries (e.g. dispersing agents) are already contained in the dyestuff formulation, but more commonly auxiliary agents are added at a later stage to the dye liquor. Since auxiliaries in general do not remain on the substrate after dyeing, they are ultimately found in the emissions.

Various dyeing techniques exist:

- mass dyeing/gel dyeing, in which a dye is incorporated in the synthetic fibre during its production (this technique is the most commonly applied process for PP fibres and is of interest also for PAC, but will not be described in this document)
- pigment dyeing, in which an insoluble pigment, without affinity for the fibre, is deposited onto the textile substrate and then fixed with a binder
- dyeing processes which involve the diffusion of a dissolved or at least partially dissolved dye into the fibre.

This last group of processes is the one that will be discussed in more detail in the following sections. From a molecular point of view, four different steps are involved:

1. first, the dye, previously dissolved or dispersed in the dye liquor, diffuses from the liquor to the substrate
2. the second step consists in the accumulation of the dye on the surface of the textile material. This process is controlled by the affinity (substantivity) of the colourant for the fibre
3. the dye diffuses/migrates into the interior of the fibre until this is uniformly dyed. This step is much slower than the transport of the dissolved dye within the dye bath. The penetration of the dye into the fibre requires that the fibre itself is accessible. In the case of hydrophilic fibres the dye penetrates through the available micro-pores, while in hydrophobic fibres, whose molecular structure does not allow a continuous water phase, cavities need to be developed in order to make the penetration of the dye possible. In general, access to the fibre is enhanced by temperature. Hydrophobic fibres can only be penetrated by the dye above the glass transition temperature, which sometimes lies above 100 °C. During the diffusion into the micro-pores an electrostatic barrier, which develops on the surface of the fibre, still has to be overcome. In some cases large amounts of salt have to be added to the dyeing bath in order to reduce the electrostatic forces on the surface of the fibre and promote an even penetration of the dye
4. the dye must be anchored (fixation) to suitable places within the substrate. Different mechanisms of fixation are known, ranging from chemical reaction of the dye with the fibre to form a covalent bond (reactive dyes) to formation of Van der Waals and other short range forces between the fibre and the dye (direct dyes). An important role is also played by hydrogen bonding responsible for long-, medium-, short-distance interactions between fibre and dyestuff, dyestuff to dyestuff, water to fibre and water to soluble substances present in the liquor, such as surfactants. This is more fully explained in Section 9.

2.7.2 Dyeing processes

Textiles can be coloured at any of several stages of the manufacturing process so that the following colouring processes are possible:

- flock or stock dyeing
- top dyeing: fibres are shaped in lightly twisted roving before dyeing
- tow dyeing: it consists in dyeing the mono-filament material (called tow) produced during the manufacture of synthetic fibres
- yarn dyeing
- piece (e.g. woven, knitted and tufted cloths) dyeing
- ready-made goods (finished garments, carpet rugs, bathroom-sets, etc.).

Dyeing can be carried out in batch or in continuous/semi-continuous mode. The choice between the two processes depends on the type of make-up, the chosen class of dye, the equipment available and the cost involved. Both continuous and discontinuous dyeing involve the following steps:

- preparation of the dye
- dyeing
- fixation
- washing and drying.

Batch- dyeing

In batch dyeing (also called exhaustion dyeing) a certain amount of textile material is loaded into a dyeing machine and brought to equilibrium with a solution containing the dye and the auxiliaries over a period of minutes to hours.

The dyeing process starts with the absorption of the colourant onto the external surface of the fibre, then the diffusion and migration of the colourant through the fibre takes place. The use of chemicals and controlled temperatures accelerates and optimises exhaustion and fixation (rate/level) of the dye. When the dyeing is judged to be the right shade, the spent dye bath is drained and the textile material is washed to remove unfixed dyes and chemicals. Washing is usually carried out in the same equipment. However, separate washing machines can also be used in the case of fabric.

All these operations can be carried out with different degrees of automatisation. In fully automated dyehouses all steps going from the preparation of recipes and laboratory trials to dyestuffs and chemicals feeding, material transportation, loading and unloading of the machines and control of dyeing parameters (e.g. level, heating, injection at selected speed, pH, temperature, etc.) are performed under computer guidance.

In a manual regime the dyestuffs and chemicals are dosed and fed to the machines manually. A manual dyeing approach used for wool is to carry out trial laboratory dyeing on a sample of the particular fibre and then to apply 5 – 10 % less dye in the full scale dyeing. The final shade is achieved by adding additional dye in small portions to achieve the final shade. Depending on the dyestuffs, it may be necessary to cool the dye bath for each of these additions in order to promote even migration of the added dye. Shade matching is carried out by eye, the dyer comparing the dyed material with a reference pattern under standard illumination.

Dyeings which are “overshade” can be corrected by stripping dyestuff from the fibre using an excess of levelling agent or reducing conditions, and then adding further colour to achieve the correct shade. This is a very costly and polluting practice and is only used as a last resort in most dyehouses.

An important parameter in discontinuous dyeing is the *liquor ratio* of the equipment. This is the weight ratio between the total dry material and the total liquor. So, for example, a liquor ratio of 1:10 means 10 litres of water on 1 kg textile material.

This parameter not only influences the amount of water and energy consumed in the dyeing process, but also plays an important role in the level of exhaustion of the dye and in the consumption of chemicals and auxiliaries.

The liquor ratio is related to the exhaustion level of the bath through the equation: $E = K/(K+L)$, where:

K (affinity) = 50 to 1000 for various dye/fibre combinations

L (liquor ratio) = 5 to 50 for various machines

E (exhaustion) = 0.5 to 1 (50 to 100 % exhaustion)

From this equation it can be inferred that when L increases, E decreases and less dye is absorbed onto the fibre when the equilibrium is reached. The effect is more pronounced on low-affinity dyes.

As stated earlier, the liquor ratio also has an influence on the consumption levels of chemicals and auxiliaries. Most are dosed on the basis of the amount of bath (o.w.b) rather than the weight of the fibre (o.w.f). For example, in a 1:5 bath ratio, 50 g/l of salt will mean 250g/kg of fibre, but at 1:40 liquor ratio, the same 50 g/l of salt correspond to 2 kg/kg of fibre.

Dyeing machines vary greatly in their liquor ratios, depending also on the type of substrate to be dyed and its hydrophilicity. Equipment manufacturers provide a range of nominal liquor ratios for each type of machine. This is defined as the range of liquor ratios at which the machine can be operated when it is loaded at its optimum/ maximum capacity. In each range the lowest values normally refer to synthetic fibres (PES is usually taken as reference), while the highest figures apply to cotton. This is due to the lower amount of liquor retained by synthetic fibres compared to cotton.

Table 2.2 shows typical ranges of nominal liquor ratios for each type of machine. It should also be noted that each type of machine has its own limitations and range of applicability.

The features of a number of typical machines are described in more detail in Sections 10.1 to 10.4.1.2, whereas the latest developments in selected types of machines are reported in Sections 4.6.19 to 4.6.21.3.

Make-up		Process	Equipment	Liquor ratio
Loose/stock fibre (also card sliver and tow)		Loose stock dyeing	Autoclave (loose stock dyeing)	1:4 - 1:12 ⁽¹⁾
Yarn	Bobbins/ cones	Yarn dyeing	Autoclave (package dyeing)	1:8 - 1:15 ⁽²⁾
	Hank	Hank dyeing	Hank dyeing machines	1:12 - 1:25 ⁽³⁾
Woven and knitted fabric, tufted carpet	Rope	Piece dyeing in rope form	Winch beck	1:15 - 1:40 ⁽⁴⁾
			Overflow	1:12 - 1:20 ⁽²⁾
			Jet - for fabric - for carpet	1:4 - 1:10 ⁽⁴⁾ 1:6 - 1:20 ⁽⁴⁾
			Airflow	1:2 - 1:5 ⁽⁵⁾
	Open-width	Piece dyeing in open-width form	Winch (only for carpet)	1:15 - 1:30 ⁽⁴⁾
			Beam dyeing	1:8 - 1:10 ⁽⁶⁾
			Beam + washing machine	1:10 - 1:15 ⁽⁷⁾
			Jig dyeing	1:3 - 1:6 ⁽⁶⁾
Ready-made goods (e.g. garments, rugs, bathroom-sets, etc.)	Piece dyeing	Paddle	1:60 (not exceptional)	
		Drum	Very variable	

Source:
⁽¹⁾ [32, ENco, 2001]
⁽²⁾ [294, ETAD, 2001]
⁽³⁾ The typical range is 1:15 – 1:25 as reported in the Comment from BCMA [208, ENco, 2001]. A L.R. of 1:12 has been reported for hank carpet wool (semi-worsted) [281, Belgium, 2002]
⁽⁴⁾ [171, GuT, 2001]
⁽⁵⁾ According to one major supplier (THEN) and textile finishing companies [209, Germany, 2001]
⁽⁶⁾ [3, RIZA, 1998]
⁽⁷⁾ [293, Spain, 2002]

Table 2.2: Discontinuous dyeing equipment and liquor ratios

Continuous and semi-continuous dyeing

In continuous and semi-continuous dyeing processes, the dye liquor is applied to the textile either by impregnation (by means of foulards) or by using other application systems. Most commonly, textiles are fed continuously in open width through a dip trough filled with dye

liquor. The substrate absorbs an amount of dye solution before leaving the dip trough through rollers that control the pick-up of the dye. Surplus stripped dye flows back into the dye bath. In the carpet industry (and for open goods that must pick-up and retain large volumes of liquor), thickening agents are added to the pad liquor to prevent dye migration. Moreover, special application systems are also encountered, where the dyestuff is poured, jet-sprayed, injected or applied in the form of foamed liquor (see Section 10.4.2).

Dye fixation is usually achieved in a subsequent stage using chemicals or heat (steam or dry heat). The final operation is washing, which is usually carried out in washing machinery at the end of the same line.

The only difference between continuous and semi-continuous processes is the fact that in semi-continuous dyeing the application of the dye is performed continuously by padding, while fixation and washing are discontinuous.

In general, dyes with low affinity are favoured in continuous dyeing to prevent tailing (attributable to undesirable exhaustion of the padding solution) and to make washing-off of the unfixed dye easier.

In continuous and semi-continuous processes the liquor ratio is not of practical importance and it is not used as a parameter. In these processes the factor to be taken into account is the *wet pick-up* % (grams of liquor picked up by 100 grams of substrate) and the concentration of the dye.

An overview of the most common techniques and machinery utilised in continuous and semi-continuous processes is given in Table 2.3.

Make-up		Process		Equipment
Woven & knitted fabric, tufted carpet	Rope	Continuous		Padding machine for piece in rope form + J-box or conveyor + washing machine
	Open-width	Semi-continuous	Pad-batch (or Carp-O-Roll for carpet)	Padding machine + washing machine
			Pad-roll (or Carp-O-Roll for carpet)	Padding machine + washing machine
			Pad-jig	Padding machine + jigger + washing machine
		Continuous	Pad-steam	Padding machine ⁽¹⁾ + steamer + washing machine
			Pad-dry	Padding machine ⁽¹⁾ + stenter frame + washing machine
			Thermosol	
	Notes:			
(1) different applicators are used to dye carpets on continuous ranges (see also Section 10.4.2)				

Table 2.3: Semi-continuous and continuous dyeing processes and equipment

2.7.3 Cellulose fibres dyeing

Cellulose fibres can be dyed with a wide range of dyestuffs, namely:

- reactive
- direct
- vat
- sulphur
- azoic (naphtol).

Reactive dyes

One third of dyes used for cellulose fibres today are reactive dyes. They are mostly applied according to the pad-batch and continuous processes for woven fabric, while batch processes are the most common for knitted fabric, loose stock and yarn.

In *batch dyeing*, dye, alkali (sodium hydroxide or sodium carbonate or bicarbonate) and salt are added to the dye bath in one step, at the start of the process, or stepwise. In the stepwise process the alkali is added only after the dye has absorbed to the fibre. Its amount is determined by the reactivity of the system and the desired depth of shade (cold dyers are applied at lower pH compared to warm and hot dyers). Salt is added to improve bath exhaustion: the concentration employed depends on the substantivity of the dye and on the intensity of the shade. Higher concentrations are required for deep shades and low-affinity dyes, as shown in the table below.

Shade	High-affinity dyes	Low-affinity dyes
<0.5 %	10 - 30 g/l NaCl	Up to 60 g/l NaCl
>4 %	~50 g/l NaCl	Up to 80 - 100 g/l NaCl
Source: [186, Ullmann's, 2000], [11, US EPA, 1995]		

Table 2.4: Salt concentration required for reactive dyes

After dyeing, the liquor is drained off and the material is rinsed and then washed off with the addition of auxiliaries.

In *pad dyeing processes* dye and alkali can be added together to the dye liquor or in separate steps into two separate padders (or other types of application systems). When all the chemicals are applied in one step, the stability of the pad liquor is important. In fact with increasing reactivity of the dye there is a risk that the dye, after a long dwell time in the pad box, is hydrolysed by the alkali, before reacting with the fibre. For this reason dye and alkali are commonly metered separately into the padder. In addition, pad boxes are now constructed so that the liquor volume is as low as possible, so that it is replaced on average within 5 minutes [186, Ullmann's, 2000].

Among *semi-continuous processes* the cold pad-batch is by far the most important one for reactive dyes. After the textile has been padded with dye and alkali, it is rolled up into batches. Fixing takes place during storage.

In *continuous processes*, padding, fixing, washing-off and drying are carried out in the same process line. Fixation is commonly achieved either by dry-heating or by steaming. The following processes are commonly used:

- pad-steam processes (one common method is the pad-dry-pad-steam process which includes dye application by padding - intermediate drying - alkali application by padding - dye fixation with saturated steam - washing - drying)
- pad-dry thermofix processes (dye and alkali are padded at the same time; then the material can be dried and fixed in a single step or it can be thermofixed after an intermediate drying stage).

In all cases, after fixation the material is always carefully washed off in open width or in a rope washing machine to remove completely the hydrolysed colourant and is then dried.

In pad-dry thermofix processes, urea is usually added to the padding liquor to act as a solvent for the dye during fixation. Urea melts at 115°C and binds water above 100 °C. It can therefore be used as solvent for the dye in dry heat. A recently developed dyeing process is now available that does not require the addition of urea (see Section 4.6.13).

Urea is also sometimes used in pad-batch processes as dyeing solvent to increase the solubility of the dye. As early as 1992 the use of urea as dyeing solvent was already in decline [61, L. Bettens, 1999]. New highly soluble reactive dyes have been introduced in the market which do not need urea even for deep dyeing in highly concentrated dye liquor.

Direct dyes

Direct dyes are also quite important in cellulose fibres dyeing: 75 % of the total consumption of these colourants is used, in fact, to dye cotton or viscose substrates [186, Ullmann's, 2000].

Direct dyes are applied directly from the dye bath together with salt (sodium chloride or sodium sulphate) and auxiliary agents, which ensure a thorough wetting and dispersing effect. Mixtures of non-ionic and anionic surfactants are used for this purpose.

In the *batch process* the dye is made into paste, then dissolved in hot water and added to the dye bath. The electrolyte is then added to the dye bath. After the dye bath has been drained, the fabric is washed with cold water and generally subjected to after-treatment.

Pad processes encompass the following techniques:

- pad-steam
- pad-roll
- cold pad-batch
- pad-jig process (the material is padded with the dye and then passed through a salt liquor in a jigger).

In all processes the material is rinsed at the end with cold water.

With increasing depth of colour the wet fastness can decrease to such an extent that after-treatment must generally be carried out [186, Ullmann's, 2000]. Two methods exist:

1. removing the unfixed dye by washing with complexing agents or surfactants with a dispersing effect
2. reducing the solubility of the dye by blocking the hydrophilic groups (“enlargement of the molecule”).

Various techniques can be applied to achieve this enlargement of the molecule. Namely, the dyed textile can be treated with:

- fixative cationic agents: these are complex substances that form with the anionic dye a salt-like compound less soluble than the original dye. Quaternary ammonium compounds with long hydrocarbon chains, polyamines and polyethyleneimine derivatives can be used for this purpose
- metal salts: copper sulphate and potassium dichromate can form with certain azo dyes metal-complex with higher light fastness
- agents based on formaldehyde condensation products with amines, polynuclear aromatic phenols, cyanamide or dicyandiamide (the use of these condensation products leads to the formation of sparingly soluble adducts with the dye molecules)
- diazotised bases: after dyeing, the material is submitted to diazotisation and is then coupled with aromatic amines or phenols that must not contain hydrosolubilising groups [186, Ullmann's, 2000].

Environmental concerns arise when after-treating with formaldehyde condensation products or metal salts. The method using fixative cationic agents is, therefore, the most frequently applied. However, quaternary ammonium compounds are often non-biodegradable, fish-toxic and contain nitrogen.

Vat dyes

Vat dyes have excellent fastness properties when properly selected and are often used for fabrics that will be subjected to severe washing and bleaching conditions (towelling, industrial and military uniforms, etc.).

Vat dyes are normally insoluble in water, but they become water-soluble and substantive for the fibre after reduction in alkaline conditions (vatting). They are then converted again to the original insoluble form by oxidation and in this way they remain fixed into the fibre.

When applying vat dyes in batch processes the textile is dyed very rapidly and unevenly due to the high affinity of the dye. Nevertheless, level dyeing can be achieved by:

- adding levelling agents
- increase of the temperature under a controlled profile ("High Temperature" process and "Semi-pigmentation" method)
- impregnation of the textile with the dye as water-insoluble dispersion, followed by addition of the reductive agent in a subsequent step (pre-pigmentation process).

In all cases, oxidation and after-treatment follow. After-treatment consists in washing the material in a weakly alkaline bath with a detergent at boiling temperature.

Continuous processes are used almost exclusively for dyeing woven fabrics and to only a small extent for knitwear. The most commonly applied continuous process is the pad-steam process. The textile is padded with the aqueous dye dispersion in the presence of anti-migrant (polyacrylates, alginates, etc.) and dispersing/wetting agents, if required. After drying, the fabric is passed through a chemical padder, which contains the required amount of alkali and reducing agent and is fed immediately to a steamer. The material is finally rinsed, oxidised and soaped in an open-width washing machine.

A more rapid, one-step process is also possible (see Section 4.6.4), but only for pastel to pale shades.

Voluminous open fabrics can be dyed according to a wet-steam process. Unlike the pad-steam process, this process does not require intermediate drying before steaming.

The following chemicals and auxiliaries are applied in vat dyeing:

- reducing agents: mainly sodium dithionite (hydrosulphite) and sulphonylic acid derivatives (Zn-sulphoxylate). The latter, in particular, is used when the pad-steam process is applied. Sulphur-free organic reducing agents such as hydroxyacetone are also now available for some applications
- oxidising agents, such as hydrogen peroxide, perborate, or 3-nitrobenzenesulphonic acid
- alkali (caustic soda)
- salt
- dispersing agents: they are already present in the dye formulation and are further added in the subsequent steps of the dyeing process
- levelling agents: they form adducts with the dye, thus retarding its absorption onto the fibre.

Sulphur dyes

Sulphur dyes are used in piece dyeing (cellulose and cellulose-polyester blends), yarn dyeing (sewing thread, warp yarn for denim fabric, yarn for coloured woven goods), dyeing of flock, card sliver (wool-man-made fibres blends) [186, Ullmann's, 2000].

Like vat dyes, sulphur dyes are insoluble in water, and, under alkaline conditions, are converted into the leuco-form, which is water-soluble and has a high affinity for the fibre. After adsorption into the fibre the colourant is oxidised and converted to the original insoluble state. The

reducing agent, salts, alkali and unfixed dye are finally removed from the fibre by rinsing and washing.

Mostly continuous dyeing methods are applied, although batch dyeing (in jigger, jet, and winch beck) is also possible.

In *continuous processes* the material is impregnated with dye, reducing agent and wetting agent through a one-bath or a two-bath procedure. With the one-bath procedure (pad-steam process) the reducing agent and the dye are added at the same time. With the two-bath procedure (pad-dry/pad-steam) the material is padded in the liquor containing the dye and the wetting agent, while the reducing agent is applied, if necessary, in a second step, after intermediate drying. The material is then submitted to air-free steaming. After that, rinsing, oxidation and re-rinsing are carried out.

Because the exhaustion is not too high, it is possible to re-use dyeing baths in continuous processes.

Chemicals and auxiliaries applied to the substrate during the dyeing process are:

- reducing agents: sodium sulphide, sodium hydrogensulphide and thiourea dioxide are the most commonly employed (although their use has decreased over the past decade [281, Belgium, 2002]). Binary systems made of glucose and sodium dithionite, hydroxyacetone and glucose or formamidine sulphinic acid and glucose are also used as alternative reducing agents (see Section 4.6.6)
- alkali (caustic soda)
- salt
- dispersing agents (they are necessary in the process steps in which the pigment has not yet been reduced or has been re-formed by oxidation)
- complexing agents: EDTA or polyphosphates are used in some cases, especially in circulating-liquor dyeing to avoid the negative effects of alkaline-earth ions on dyeing
- oxidising agents: mainly hydrogen peroxide and halogen-containing compounds such as bromate, iodate and chlorite.

Azoic dyes (naphthol dyes)

Naphthol AS dyes allow colours with outstanding fastness, but their popularity has declined because of application costs and the complexity of the process for the preparation of the colourant [77, EURATEX, 2000].

Dyeing with azoic colourants is a complex process which involves a number of delicate steps:

- preparation of the naphtholate solution by the hot solution process (the naphthol is dissolved by boiling with caustic soda) or by the cold solution process (the naphthol is solubilised with alcohol or cellosolve, caustic soda and cold water). For certain naphthols the addition of formaldehyde is also necessary to prevent the formation of free naphthol
- application of the naphtholate to the fibre by batch or padding techniques
- preparation of the diazotized base by reaction with sodium nitrite and hydrochloric acid (this step can be avoided when using fast colour salts)
- formation of the azoic dye into the fibre, by passing the textile, previously impregnated with the naphtholate solution, through a bath containing the diazotized base or the fast colour salt (addition of buffering agents is necessary to control the pH, in order to increase the coupling capacity)
- after-treatment by rinsing the material to remove the excess naphthol from the fibre.

Dyestuff	Chemicals and auxiliaries/ typical application conditions	Technique
Reactive	<ul style="list-style-type: none"> - pH 9.5 - 11.5 by addition of sodium carbonate and/or sodium hydroxide - Salt is used to increase dye bath exhaustion: higher concentrations are used for low-affinity dyes and for deep shades - Application temperatures vary from 40 °C to 80 °C depending on the class of the dyestuff - In padding processes urea or cyanoguanidine is usually added to the pad liquor (the Econtrol® process described in Section 4.6.13 does not need urea) - After dyeing, the material is soaped and then washed off with addition of surfactants to remove unfixed dye 	Batch
		Pad-batch
		Pad-steam
		Pad-dry
Direct	<ul style="list-style-type: none"> - Salt is used to increase bath exhaustion - Mixtures of non-ionic and anionic surfactants are used as wetting/dispersing agents - After-treatment is usually necessary to improve wet-fastness (possible use of fixative cationic agents, formaldehyde condensation products) 	Batch
		Pad-batch
		Pad-jig
		Pad-steam
Vat	<ul style="list-style-type: none"> - Alkali and reducing agents (sodium dithionite, sulphylic acid derivatives, thiourea dioxide, and other organic reducing agents) are applied to convert the dye to the sodium leuco form - Poorly degradable dispersants are present in the dye formulation and are further added in other steps of the process - Levelling agents are sometimes necessary - Temperature and the amount of salt and alkali required vary according to the nature of the dye (IK, IW, IN) - Dye is fixed to the fibre by oxidation, generally using hydrogen peroxide, but halogen-containing oxidising agents can also be used - After-treatment takes place in a weakly alkaline detergent liquor at boiling temperature - In continuous processes, anti-migration and wetting agents are used 	Batch
		Pad-steam
Sulphur	<ul style="list-style-type: none"> - Reducing agents (Na₂S, NaHS, glucose-based combination of reducing agents) and alkali are applied to convert the dye into soluble form, unless ready-for-use dyes are used - Dispersants and complexing agents are used in batch dyeing - In batch dyeing, the dye generally absorbs at 60 - 110 °C, while in the pad-steam process the material is padded at 20 - 30 °C and then subjected to steaming at 102 - 105 °C - Oxidation is carried out mainly with hydrogen peroxide, bromate and iodate 	Batch
		Pad-steam
		Pad-dry/ pad-steam
Azoic	<ul style="list-style-type: none"> - Preparation of the naphtholate (caustic soda and, in some cases, addition of formaldehyde is required to stabilise the naphthol on the fibre) - Impregnation of the naphtholate by exhaustion or padding processes - Preparation of the diazotised base (with NaNO₂ and HCl) - Developing stage (the textile is passed through the cold developing bath or the developing solution is circulated through the stationary textile in the dyeing machine) 	Batch
		Padding methods

Table 2.5: Summary of the most common dyestuffs and dyeing techniques applied for cellulose fibres

2.7.4 Wool dyeing

Wool can be dyed with the following dyestuffs:

- acid (metal-free)
- chrome
- 1:1 and 1:2 metal complex
- reactive.

Acid dyes

Acid dyes are typically applied in acidic conditions, but the pH range used varies depending on the type of acid dye. The greater the affinity of the dyestuff for the fibre, the more the hydrophobic interaction must be repressed by applying the dye at higher pH.

Therefore *level-dyeing colourants* are applied under strongly acidic conditions (1 – 3 % formic acid) in the presence of sulphate ions (5 – 10 % sodium sulphate) to assist migration and levelling. HCOOH and HSO_4^- compete with the sulphonated dyes acting as levelling agents. As a result, other levelling agents are not generally required and the rate of dye uptake is controlled initially by increasing the temperature of the dye bath slowly (1 °C/min.) and then extending the time at the boil to allow the dye to migrate from areas of high initial uptake.

Fast acid dyes (also known as half-milling dyes or perspiration-fast dyes) exhibit superior fastness properties to level-dyeing acid dyes, while retaining some of the migration properties. Application is from a moderately acidic dye bath (1 – 3 % acetic acid) in the presence of sodium sulphate (5 – 10 %) and levelling agent to assist migration.

Acid milling dyes (including 1:2 metal-complex dyes mentioned later) have good affinity for the fibre and do not migrate well at the boil. They are therefore applied at more neutral pH (5 - 7.5 with acetic acid) in the presence of sodium acetate (2g/l) or ammonium sulphate (4 %) and levelling agent (1 – 2 %). Sodium sulphate is usually avoided as it has little effect on migration and can promote uneven dye adsorption.

Levelling agents play an important role in acid dyeing. A number of non-ionic, cationic, anionic and amphoteric surfactants belong to this category.

Chrome dyes

A number of techniques have been developed for the application of chrome dyes. The *Chrome mordant* process relies on chroming the fibre prior to dyeing with a chromable dye; the *Metachrome* process applies both dye and chromium salt simultaneously. Both processes have been largely superseded by the *Afterchrome* process in which the dye is applied first and the fibre is then chromed in a separate step, utilising the exhausted dye bath and thus conserving water.

Application of the dyestuff takes place from a moderately acid dye bath (1 % acetic acid) often with an addition of formic acid towards the end of the boiling period to promote exhaustion of the dye. The dye bath is then cooled back from the boil to approx. 80 °C, the pH is lowered to approx. 3.5 with formic acid and the pre-dissolved chromium salt added. The dye bath is then returned to the boil and boiling continued for 20 - 30 minutes. Chromium is added to the dye bath as either sodium or potassium dichromate. In solution the chroming species present vary according to pH, with the dichromate anion $\text{Cr}_2\text{O}_7^{2-}$ predominating at pH between 3 and 7. Although it is the chromium (VI) anion which is initially adsorbed by the wool, the dye complex is formed with chromium (III), formed by the action of reducing groups in the fibre itself. Strong acids have an activating effect on this process; organic acids (tartaric, lactic, formic acid) or thiosulphate can also be used to enhance the degree of conversion of Cr VI (see also Section 4.6.15).

Metal-complex dyes

Application of *1:1 metal-complex dyes* is carried out at pH 1.8 - 2.5 with sulphuric acid or at pH 3 – 4 with formic acid, in the presence of sodium sulphate (5 - 10 %) and other organic levelling agents. Owing to these particular operative conditions, this class of dyestuffs is particularly suitable for piece-dyeing of carbonised wool.

1:2 metal-complex dyes form the most important group in this class and may be divided into two sub-groups: weakly polar and strongly polar 1:2 complexes. Application is usually carried out in moderately acidic conditions:

- pH range 4 - 7 (acetic acid) in the presence of ammonium acetate, for weakly polar complexes
- pH range 5 - 6 (acetic acid) in the presence of ammonium sulphate, for strongly polar complexes.

The use of levelling agents is very common when dyeing with metal-complex dyes. The groups of substances used for acid dyes also apply in this case.

Reactive dyes

Reactive dyes are generally applied at pH values of between 5 and 6, depending on the depth of shade, in the presence of ammonium sulphate and specialised levelling agents (amphoteric substances, which form complexes with the dye at low dye bath temperatures and then break down as the dyeing temperature increases).

The dyeing method may include a temperature hold step at 65 – 70 °C, during which the dye bath is maintained at this temperature for 30 minutes in order to allow the dye to migrate without fibre reaction. When dyeing of the very highest fastness is required, the fibre is rinsed under alkali conditions (pH 8–9 with ammonia) to remove unreacted dyestuff.

Dyestuff	Chemicals and auxiliaries/ typical application conditions	Technique
Acid dyes (metal-free)	<ul style="list-style-type: none"> - Strongly acidic conditions for equalising dyes (by formic acid) - Moderately acidic conditions for half-milling dyes (by acetic acid) - More neutral conditions for milling dyes (by acetic acid and sodium acetate or ammonium sulphate) - Salt: sodium sulphate or ammonium sulphate - Levelling agents other than sulphate and formic acid are not necessary for level-dyeing colourants 	Batch dyeing
Chrome dyes (mordant)	<ul style="list-style-type: none"> - pH 3 to 4.5 - sodium sulphate - organic acids: acetic and formic acid (tartaric and lactic acids can also be used) - reducing agent: sodium thiosulphate - after-chrome with Na or K dichromate 	Batch dyeing (After-chrome method)
1:1 metal-complex dyes	<ul style="list-style-type: none"> - pH 1.8 to 2.5 (pH 2.5 in the presence of auxiliary agents such as alkanolethoxylates) - sulphuric or formic acid - salt: sodium sulphate - ammonia or sodium acetate can be added to the last rinsing bath 	Batch dyeing
1:2 metal-complex dyes	<ul style="list-style-type: none"> - pH 4.5 to 7 - ammonium sulphate or acetate - levelling agents (non-ionic, ionic and amphoteric surfactants) 	Batch dyeing
Reactive dyes	<ul style="list-style-type: none"> - pH 4.5 to 7 - formic or acetic acid - levelling agent - after-treatment with ammonia for highest fastness 	Batch dyeing

Table 2.6: Summary of the most common dyestuffs and dyeing techniques for wool fibre

2.7.5 Silk dyeing

Silk is dyed with the same dyes as wool, excluding 1:1 metal complex dyes. In addition, direct dyes can be used. The dyeing pH is slightly higher than with wool. For reactive dyeing 20 - 60 g/l of salt and 2 - 5g/l of soda ash is needed for fixation [294, ETAD, 2001].

For more a detailed description, reference is made to the “Wool dyeing” section.

2.7.6 Synthetic fibres dyeing

2.7.6.1 Polyamide fibres

Polyamide fibres (PA 6 and PA 6,6) are easily dyed with various types of dyes. Due to their hydrophobic characteristics, they can be dyed with disperse dyes (non-ionic), whereas thanks to the presence of the groups NH-CO- and NH₂- in the polymer chain, acid, basic, reactive and 1:2 metal-complex dyes (ionic) can also be used. However, in practice acid levelling dyes are increasingly used.

Before dyeing, fabrics must generally be pre-fixed to compensate for material-related differences in affinity and to reduce the sensitivity to creasing during the dyeing process. Pre-fixing can be performed in a stenter frame.

Disperse dyes

Disperse dyes used for polyamide fibres are mainly azo compounds and anthraquinones. They are applied especially for lighter shades.

The material is dyed in acidic conditions (pH 5) by acetic acid. A dispersing agent is always added to the liquor.

Acid dyes

As with acid dyeing of wool, with increasing dye affinity, the hydrophobic interaction in the initial phase must be repressed to achieve uniform absorption. This means that for high-affinity dyes the liquor must be sufficiently alkaline at the start and then slowly decreased to optimise exhaustion. The level of acidity of the liquor is regulated either by dosing with acids during dyeing or by adding acid-donors (e.g. ammonium sulphate, sodium pyrophosphate or esters of organic acids) at the start of the process (see also Section 4.6.14).

Optimal exhaustion and uniform dyeing can also be achieved by controlling the temperature profile.

Auxiliary agents (anionic, cationic, non-ionic surfactants) are normally used to improve the levelling effect.

The wet-fastness of dyeing with acid dyes on polyamide fibres is often unsatisfactory. After-treatment with syntans (synthetic tanning agents) is often necessary. The syntans are added to the exhausted bath or to fresh liquor at pH 4.5 by formic or acetic acid. The material is treated at 70 - 80 °C and is then rinsed.

Metal-complex dyes

Among 1:2 metal-complex dyes, molecules containing sulphonic groups are the most suitable for polyamide fibres.

The absorption of the dye increases with decreasing pH. Dyeing conditions vary from weakly acidic by addition of ammonium sulphate and acetic acid to neutral or moderately alkaline for

high-affinity dyes. For high-affinity dyes amphoteric or non-ionic levelling agents are usually added.

Reactive

In principle, the reactive dyes used for wool are also suitable for polyamide. The dyeing process is carried out in weakly acidic conditions (pH 4.5 - 5). The process is started at 20 – 45 °C and then temperature is increased near to boiling. Non-ionic surfactants and sodium bicarbonate or ammonia are used in the after-treatment step.

Dyestuff	Chemicals and auxiliaries/ typical application conditions	Technique
Disperse	<ul style="list-style-type: none"> - PH 5 by acetic acid - dispersing agents (sulphoaromatic condensation products or non-ionic surfactants) - dyeing is conducted at near-boiling temperature 	Batch
Acid dyes	<ul style="list-style-type: none"> - pH conditions from acid to neutral depending on the affinity of the dye - optimal bath exhaustion and level dyeing are achieved by either pH or temperature control methods (levelling agents are also used) - in the acidic range, electrolytes retard the exhaustion - with levelling dyes, wet-fastness is often unsatisfactory and after-treatment with synthanes can be necessary 	Batch
1:2 metal-complex dyes	<ul style="list-style-type: none"> - dyes containing sulphonic groups are preferred because they are more water-soluble and produce better wet-fastness - to improve absorption of low-affinity dyes (especially for disulphonic) dyeing is carried out in weakly acidic conditions using acetic acid - high-affinity dyes are applied in neutral or weakly alkaline medium using amphoteric or non-ionic levelling agents 	Batch
Reactive dyes	<ul style="list-style-type: none"> - in principle the reactive dyes used for wool are also suitable for PA - dyeing is conducted at near-boiling temperature in weakly acidic conditions - after-treatment is performed at 95 °C using a non-ionic surfactant and sodium bicarbonate or ammonia 	Batch

Table 2.7: Summary of the most common dyestuffs and dyeing techniques for polyamide fibres

2.7.6.2 Polyester fibres

Articles made of pure PES are dyed almost exclusively using batch dyeing techniques and among these, dyeing under high-temperature conditions is the most commonly applied.

Dyeing polyester fibres under atmospheric conditions (below 100 °C) was also frequently done in the past with the aid of carriers. Since these substances are ecologically harmful (see Section 2.7.8.1 and 8.6.7), dyeing below 100 °C is no longer in use today for pure PES fibres, unless *carrier-free dyeable* fibres are employed (see Section 4.6.2).

Concerning high-temperature dyeing, the process is usually carried out in acidic conditions (pH 4 - 5) with addition of acetic acid under pressure at 125 – 135 °C. In these conditions levelling agents are necessary to prevent excessively rapid absorption.

Provided that alkali-stable dyes are used, dyeing in alkaline medium (pH 9 - 9.5) is also possible. This technique has been developed in order to counteract the migration and deposition of oligomers typical of PES fibres (see Section 2.1.1.1). In fact, oligomeric components (cyclic trimers of ethylene terephthalate are especially harmful) tend to migrate out of the fibre during dyeing, thus forming with the dye agglomerates that can deposit on the textile or on the dyeing equipment. To achieve level effects, ethoxylated products are used as levelling agents.

The thermosol process is another applied technique, although it is primarily used for PES/cellulose blends. The dye is padded on the textile together with an anti-migration agent. A drying step at 100–140 °C is carried out. Then the dye is fixed (200–225 °C for 12 - 25 seconds).

For light shades, the material needs only to be rinsed or soaped after dyeing. For dark shades, in order to ensure high light fastness, an after-clearing step is normally necessary. This usually consists of an alkaline reductive treatment followed by post-rinsing in weakly acidic conditions. Information about alternative processes is reported in Section 4.6.5.

PES fibres can be dyed with cationic dyestuffs, provided that acidic components (e.g. sulphated aromatic polycarboxylic acid) are used as co-monomers during the manufacturing of the fibre (creation of anionic sites).

Dyestuff	Chemicals and auxiliaries/ typical application conditions	Technique
Disperse	<ul style="list-style-type: none"> - pH 4 - 5 by acetic acid - levelling agents (aliphatic carboxylic esters, ethoxylated products, combinations of alcohols, esters or ketones with emulsifying agents) - possible addition of complexing agents (EDTA) for dyes sensitive to heavy metals 	Batch dyeing at 125 - 135 °C under pressure (HT)
	<ul style="list-style-type: none"> - this techniques requires the use of carriers unless modified polyester fibres are employed 	Batch dyeing below 100 °C
	<ul style="list-style-type: none"> - pH 4 - 5 by acetic acid - thickeners such as polyacrylates and alginates are added to the padding liquor in order to prevent migration of the dye during drying - after-treatment with a solution containing sodium hydrosulphite and sodium hydroxide (dispersing agents are added to the last washing bath) 	Thermosol process

Table 2.8: Summary of the most common dyestuffs and dyeing techniques for polyester fibres

2.7.6.3 Acrylic fibres

So called PAC fibres are hydrophobic and contain anionic groups in the molecule. As a result, they can be dyed with disperse and cationic dyes. With the introduction of cationic co-monomers in the polymer, the fibre can also be dyed with acid dyes.

Batch dyeing is commonly applied for cable or stock (package dyeing), yarn in hank form or packages and for fabric. Piece dyeing can be performed on beam, overflow, paddle (for knitwear, ready-made bath sets), or drum (socks).

Stock, cable and top can be also dyed on special machine, using the pad-steam process, preferably with pressurised steam to obtain short fixing times. Piece goods, especially upholstery material (velour), are also dyed according to the pad-steam process, but in this case fixing is carried out with saturated steam. This implies longer fixing times, which means that rapidly diffusing cationic dyes and dye solvents are required.

Disperse dyes

Disperse dyes are used to produce light to medium-deep shades. The dyeing techniques correspond to those used on polyester fibres. However, dyeing can be performed at temperatures <100 °C without carriers. Furthermore, due to the good migration properties of disperse dyes, levelling agents are not required.

Cationic dyes

Typical recipes used in *batch dyeing* include an electrolyte (sodium acetate or sodium sulphate), acetic acid, a non-ionic dispersant and a retarding agent. Dyeing is conducted by controlling the temperature in the optimum range for the treated fibre. Finally the bath is cooled down and the material is rinsed and submitted to after-treatment.

Continuous processes commonly applied are:

- pad-steam process (fixation with pressurised steam at more than 100 °C) - this process has the advantage of reducing fixing time. Pad liquor typically contains a steam-resistant cationic dye, acetic acid and a dye solvent
- pad-steam process (fixation with saturated steam at 100 - 102 °C) - this process requires a longer fixing time. Rapidly diffusing cationic dyes and dye solvents, which exhibit a carrier effect, are required.

When dyeing with basic dyes, special levelling agents (also called retarding agents) are widely used to control the absorption rate of the colourant on the fibre, thus improving level dyeing.

Dyestuff	Chemicals and auxiliaries/ typical application conditions	Technique
Disperse	- dyeing conditions correspond to those used for polyester - addition of carriers is not required	
Cationic	- Acetic acid (pH 3.6 - 4.5) - Salt (sodium sulphate or sodium acetate) - Retardant auxiliaries (usually cationic agents) - Non-ionic dispersing agents	Batch
	- Acetic acid (pH 4.5) - Dye solvent - Steam-resistant, readily-soluble dyes (usually liquid) are required	Pad-steam process with pressurised steam
	- Dye solvent - Rapidly diffusing dyes are required	Pad-steam process with saturated steam

Table 2.9: Summary of the most common dyestuffs and dyeing techniques for polyacrylic fibres

2.7.6.4 Cellulose acetate (CA) and cellulose triacetate (CT)

In contrast to the other regenerated cellulose fibres, CA and CT are hydrophobic and therefore they can be dyed with disperse dyes under conditions which are very similar to those applying to PES fibres.

Cellulose acetate is dyed by the exhaustion method with disperse dyes in the presence of non-ionic or anionic dispersing agents in weakly acidic conditions (pH 5 - 6). Dyeing is normally done at 80 – 85 °C. However, a series of less wetfast dyes already absorb onto the fibre at 50 - 60 °C, whereas more wetfast dyes require temperatures up to 90 °C.

Compared to CA, CT dyeing and finishing characteristics are more similar to purely synthetic fibres. CT, like CA, is dyed with disperse dyes in a weakly acidic medium in the presence of levelling auxiliaries. Applied dyeing techniques for CT are:

- batch dyeing process, usually at 120 °C, but if these conditions are not possible a dyeing accelerant (based on butyl benzoate or butyl salicylate) is required
- thermosol process.

2.7.7 Fibre blends dyeing

Natural/synthetic fibre blends are becoming more and more important in the textile industry because this allows combining the favourable technological properties of synthetic fibres with the pleasant feel of natural fibres.

Of the worldwide consumption of PES fibres, 55 – 60 % is used in blends with cellulose fibres or wool. About 40 % of polyamide is used in blends, while 50 % of polyacrylic fibres is used especially in blends with wool for knitwear [186, Ullmann's, 2000].

Fibre blends can be produced according to three different methods:

- fibres of different types in the form of staple fibres are mixed at the yarn manufacturing stage, during spinning
- fibres of different types are separately spun and the resulting yarns are wound together to give a mixed yarn
- fibres of different types are separately spun and combined together only at the weaving stage where one or more fibre yarns are used as warp and the other ones as weft.

Dyeing of blend fibres is always longer and more difficult as an operation compared to pure fibre dyeing. Despite these disadvantages, dyeing tends to be placed as close as possible towards the end of the finishing process. In fact this enables the dyer to satisfy the requests of the market without the need to store large amounts of material already dyed in flock or yarn form in all available shades.

When dyeing blend fibres, the following methods can be applied:

- the two fibres are dyed in the same tone ("tone on tone") or in two different shades using the same dyes
- only one fibre is dyed (the colourant is not absorbed by the other ones)
- the different fibres are dyed in different tones.

For "tone on tone" dyeing, it is sometimes possible to use the same dye for the different fibres. When dyes of different classes have to be employed, the dyeing process is easier to control when the selected colourants have affinity only for one fibre and not for the other one. In reality, however, this situation is exceptional and the dyeing of fibre blends remains a complex operation.

Blend fibres dyeing can be done in batch, semi-continuous and continuous processes. Batch processes include:

- dyeing in one bath and one step (all dyes are added in the same bath in one single step)
- dyeing in one bath and in two steps (dyes are added to the same bath in subsequent steps)
- dyeing in two baths (dyes are applied in two steps in two different baths).

The most common fibre blends will be discussed in the following sections.

Polyester-cellulose blends

A large part of the entire production of PES (ca. 45 %) is used to make this mixture. Polyester-cellulose blends are used for all types of clothing and for bed linen. The cellulose component is usually cotton, but viscose staple fibres and occasionally linen are also used. The preferred mixing ratio is 67:33 PES: cellulose (for textiles worn close to the skin), 50:50 and 20:80 [186, Ullmann's, 2000].

In dyeing PES-cellulose mixtures, disperse dyes are used for the polyester component, while the cellulose portion is usually dyed with reactive, vat and direct dyes. Pigment dyeing is also commonly used for light shades.

Disperse dyes stain cellulose fibres only slightly and they can easily be removed by subsequent washing or, if necessary, by reductive aftertreatment. Most of the dyes used for cellulose stain PES only slightly or not at all.

PES-cellulose blends are commonly dyed in continuous processes. Nevertheless, for yarn and knitwear, batch dyeing is of major importance.

In *batch dyeing*, the application of dyes can be done in one or two steps in one bath or in two different baths in subsequent stages. The disperse dye is generally applied at high-temperature (HT) conditions without the use of carriers.

In the one-bath/ one-step procedure, special auxiliaries, so-called acid donors, are used, which lower the pH when the temperature is increased. In this way, it is possible to fix the reactive dyes in alkaline conditions and then reach the optimal dyeing conditions (pH 5 - 6) for disperse dyes by increasing the temperature. Alternatively, it is advantageous to operate at pH 8 - 10 using alkali-stable disperse dyestuffs, which also avoid oligomer problems.

The one-bath/ one-step procedures are preferred, being more economic, but present more difficulties. For example, the presence of salt increases the tendency of disperse dyes to stain the cotton fibre of the blend. Recently developed low-salt reactive dyes are claimed to show good performance and high reproducibility in this application (see Section 4.6.11).

In *continuous processes* the dyes are usually applied in one bath. The fabric is subsequently dried and disperse dye is fixed to the PES component by the thermosol process. Afterwards, the second dye is developed according to the procedure typical of each class, using in general pad-steam, pad-jig or pad-batch processes.

Table 2.10 presents a summary of the most frequently applied processes is presented. Dyes are applied according to application conditions typical of their class. For more details regarding a given class of colourant, see the specific section.

Technique		Disperse /vat	Disperse/ reactive	Disperse /direct	Pigment
Batch	One-bath process			Y K	W ⁽¹⁾
	Two-bath process			Y K	
	One-bath two-step process		Y K	Y K	Y K
Continuous	I stage	II stage			
	Application of all dyes in one bath by padding + drying followed by:	Thermosol + pad-jig		W	
		Thermosol + pad-batch			W
		Thermosol +pad-steam		W	W
Y = yarn W = woven fabric K = knitted fabric ⁽¹⁾ Pigment dyeing includes padding with the pigment, a binder and auxiliaries, drying and polymerisation at 140 °C for 5 min.					

Table 2.10: Summary of dyestuff and dyeing techniques for polyester-cellulose blends

Polyester-wool blends

Polyester-wool blends are widely used, especially for woven goods and knitwear. The most frequently found ratio is 55:45 PES: wool.

Wool cannot be dyed at the high temperatures typical of the HT dyeing process for PES fibres and PES-cellulose blends. The dyeing time should also be as short as possible so that the wool is not damaged. For large productions it is therefore preferable to dye wool and PES separately in top, blending the two fibres at the yarn manufacturing stage. However, quick changes in fashion and short-term planning frequently do not allow separate dyeing.

When dyeing polyester-wool blends, disperse dyes are used for polyester and anionic (acid and metal-complex dyes) for wool.

Only disperse dyes that stain wool as slightly as possible or are easily removed by washing can be used for dyeing wool-polyester blends. Disperse dyes, in fact, tend to stain wool and a reductive after-treatment is not always possible (appropriately stable dyes are required).

PES-wool blends are typically dyed according to the following batch processes:

- at boiling temperature with carriers
- at 103 – 106 °C with little carrier
- at 110 – 120 °C with the addition of formaldehyde as a wool protective agent and with low amounts of carriers or none at all (HT conditions).

Because of the environmental concerns associated with the use of carriers (see Sections 8.6.7 and 2.7.8.1), the first dyeing technique is avoided when possible. In this respect, carrier-free dyeable fibres are also available, which can be dyed at boiling temperature without the use of carriers (see Section 4.6.2 for more information about carrier-free dyeable fibres and Section 4.6.1 for environmentally optimised carriers).

The one-bath process method is preferred in practice; the two-bath process is applied when deep shades and high fastness are required. The material is first dyed with disperse dyes. A reductive intermediate treatment may be applied before dyeing the wool part. In both dyeing methods, after dyeing, an after-treatment is applied to remove any disperse dye attached to the wool, if the dye used for wool can withstand it. The material is treated with ethoxylated fatty amine in weakly acid liquor at 60 °C.

Polyamide-cellulose blends

Since PA fibres have an affinity for almost all dyes used for cellulose, different possibilities are available for dyeing this blend:

- direct and disperse dyes (pH 8)
- acid or 1:2 metal-complex dyes (pH 5 - 8)
- vat dyes (exhaust and pad-steam process are used)
- reactive dyes.

Application conditions are those typical of each class of dye. They have already been described in the specific sections.

Polyamide-wool blends

Blends with polyamide/ wool ratios varying from 20:80 to 60:40 are used. This blend is particularly important in the carpet sector. More detailed information is therefore reported in the specific section dedicated to this sector (see Section 2.14.5).

As general information about the dyeing processes suitable for this type of blend, both fibres have affinity for acid and 1:2 metal-complex dyes. However, since PA is more accessible to the dye than wool, it is dyed more deeply, particularly in the case of light colours. To counteract this effect, special levelling agents (also called PA reserving/ blocking agents) are used (mainly aromatic sulphonates). These auxiliaries have a relatively high affinity for the PA fibre and retard the absorption of the colourant on this part of the blend.

Dyeing is performed in the presence of acetic acid and sodium sulphate. Due to limited fastness of acid dyes, 1:2 metal-complex dyes are required for dark shades [186, Ullmann's, 2000].

Acrylic-cellulose blends

PAC-cellulose blends are used for household textiles (drapery and table linen) and imitation fur ("peluche", in which the pile consists of PAC fibres and the back is made of cotton). The percentage of PAC in the mixtures varies between 30 and 80 %.

PAC can be dyed with cationic or disperse dyes, while direct, vat or reactive dyes can be used for the cellulose component.

The following methods are the most commonly used for dyeing this blend:

- *continuous dyeing* with cationic and direct dyes according to the pad-steam process (to avoid precipitation of cationic and anionic dyes present in the pad liquor at relatively high concentration, combination of anionic and non-ionic surfactants are added to the solution)
- *batch dyeing* (usually according to the one-bath, two-steps method) with cationic and vat dyes or with cationic and reactive dyes.

Acrylic-wool blends

Among synthetic fibres, PAC fibres are the most suitable for obtaining blends with wool that keep a wool-like character. This makes this blend widely used, especially for knitwear and household textiles. The blending ratio of PAC to wool varies from 20:80 to 80:20.

Metal-complex, acid and reactive dyes are the dyestuffs typically used for the wool part, while PAC is dyed with cationic dyes.

Cationic dyes stain wool fibre. As a matter of fact cationic dyes attach first to wool and then migrate to PAC fibre at higher temperature. Even if well-reserving dyes are selected, dyeing must be conducted for a sufficiently long time (from 60 to 90 minutes) in order to obtain good wool reserve [186, Ullmann's, 2000].

PAC-wool blends can be dyed using the following exhaustion methods:

- one-bath one-step
- one-bath two-step
- two-bath.

The first one allows shorter dyeing times and lower consumption of water. However, it is not always applicable because the simultaneous presence in the dye bath of anionic and cationic compounds can produce the precipitation of the formed adducts on the fibre. Precipitation can be prevented using dispersing agents and selecting adequate dyes.

When dyeing with the one-bath, two-step method the use of reserve agents is not necessary. In fact, wool absorbs the cationic dye and slowly releases it, acting as a retarding agent (exerting a retardant effect on PAC).

2.7.8 Environmental issues

Potential sources and types of emissions associated with dyeing processes are summarised in the following table.

Operations	Emission sources	Type of emission
Colour kitchen operations	Dye preparation	Discontinuous, low-concentration water emission at the end of each batch (cleaning step)
	Auxiliaries preparation	Discontinuous, low-concentration water emission at the end of each batch (cleaning step)
	Dispensing of dyes and auxiliaries (manual)	Indirect pollution from inaccurate dosing and handling of chemicals (spillage, poor shade repeats, etc.)
	Dispensing of dyes and auxiliaries (automatic)	No emission, provided that the system is regularly calibrated and verified for accuracy
Batch dyeing	Dyeing	Discontinuous, low-concentration water emission at the end of each cycle
	Washing and rinsing operations after dyeing	Discontinuous, low-concentration water emission at the end of each cycle
	Cleaning of equipment	Discontinuous, low concentration water emission
Semi-continuous and continuous dyeing	Application of the colourant	No emission from the process unless dye bath is drained
	Fixation by steam or dry-heat	Continuous emission to air (generally not significant, except for specific situations such as, for example, the thermosol process, drying of carrier-dyed fabrics, etc.)
	Washing and rinsing operations after dyeing	Continuous, low concentration water emission
	Discharging of leftovers in the chassis and feed storage container	Discontinuous, concentrated water emission at the end of each lot
	Cleaning of equipment	Discontinuous, low concentration water emission (it can contain hazardous substances when reductive agents and hypochlorite are applied)

Table 2.11: Overview of the typical emissions generated in dyeing processes

As the table shows, most of the emissions are emissions to water. Due to the low vapour pressure of the substances in the dye bath, emissions to air are generally not significant and can be regarded more as problems related to the workplace atmosphere (fugitive emissions from dosing/dispensing chemicals and dyeing processes in “open” machines). A few exceptions are the thermosol process, pigment dyeing and those dyeing processes where carriers are employed. In pigment dyeing the substrate is not washed after pigment application and therefore the pollutants are quantitatively released to air during drying. Emissions from carriers are to air and water.

In the first part of the following discussion the environmental issues related to the substances employed will be described, while in the second part the environmental issues related to the process will be mentioned.

2.7.8.1 Environmental issues related to the substances employed

Water-polluting substances in the above-mentioned emissions may originate from:

- the dyes themselves (e.g. toxicity, metals, colour)
- auxiliaries contained in the dye formulation
- basic chemicals (e.g. alkali, salts, reducing and oxidising agents) and auxiliaries used in dyeing processes
- contaminants present on the fibre when it enters the process sequence (residues of pesticides on wool are encountered in loose fibre and yarn dyeing and the same occurs with spin finishes present on synthetic fibres).

Dyes

Spent dye baths (discontinuous dyeing), residual dye liquors and water from washing operations always contain a percentage of unfixed dye. The rates of fixation vary considerably among the different classes of dyes and may be especially low for reactive dyes (in the case of cotton) and for sulphur dyes. Moreover, large variations are found even within a given class of colourants. This is particularly significant in the case of reactive dyes. Fixing rates above 60 % cannot be achieved, for example, in the case of copper (sometimes nickel) phthalocyanine reactive dyes especially used for turquoise-green and some marine shades. In contrast, the so-called double anchor reactive dyes can achieve extremely high rates of fixation (see Sections 4.6.10 and 4.6.11).

The degree of fixation of an individual dye varies according to type of fibre, shade and dyeing parameters. Therefore fixation rate values can be given only as approximations. However, they are useful to give an idea of the amount of unfixed dyes that can be found in waste water. Information from different authors is given in the table below.

Dyestuffs	EPA	OECD	ATV	Bayer ⁽¹⁾	Euratex	Spain
Acid dyes - for wool - for polyamide	10 20	}7 - 20	}7 - 20	-	}5 - 15	5 - 15
Basic dyes	1	2 - 3	2 - 3	2	-	0 - 2
Direct dyes	30	5 - 20	5 - 30	10	5 - 35	5 - 20
Disperse dyes - for acetate - for polyester 1 bar - for polyester HT	25 15 5	}8 - 20	}8 - 20	}5	}1 - 15	}0 - 10
Azoic dyes	25	5 - 10	5 - 10	-	10 - 25	10 - 25
Reactive dyes ⁽²⁾ - for cotton - for wool	}50 - 60	}20 - 50	}5 - 50	}5 - 50	20 - 45 3 - 10	}10 - 35
Metal-complex	10	2 - 5	2 - 5	5	2 - 15	5 - 15
Chrome dyes	-	-	1 - 2	-	-	5 - 10
Vat dyes	25	5 - 20	5 - 20	-	5 - 30	5 - 30
Sulphur dyes	25	30 - 40	30 - 40	-	10 - 40	15 - 40
Source: [11, US EPA, 1995], [77, EURATEX, 2000] and [293, Spain, 2002] EPA: US Environmental Protection Agency OECD: Organisation for Economic Co-operation and Development ATV: Abwasser Technische Vereinigung (Waste Water Technical Association) Notes: ⁽¹⁾ Now Dystar (including BASF) ⁽²⁾ New reactive dyestuffs with higher fixation rates are now available (see Section 4.6.10 and 4.6.11)						

Table 2.12: Percentage of non-fixed dye that may be discharged in the effluent for the principal classes of dyes

As stated earlier, as a consequence of incomplete fixation a percentage of the dyestuff used in the process ends up in the waste water.

Dyestuffs are not biodegradable in oxidative conditions, although some of them may degrade under other conditions (e.g. azo dyes may cleave under anoxic and anaerobic conditions). Less water-soluble dyestuffs molecules (typically, disperse, vat, sulphur, some direct dyestuffs and pigments) can be largely bio-eliminated from waste water by coagulation/ precipitation or absorption/ adsorption to the activated sludge. The quantity of activated sludge in the waste water treatment plant and the quantity of dyestuff to be eliminated are key factors in determining the efficiency of removal of a dyestuff from the effluent.

Another factor to take into consideration is the colour strength of the colourant. For example, with reactive dyestuffs a lower amount of colourant is needed to achieve a given shade compared to other classes of dyes (e.g. direct, vat and sulphur dyes). As a result a lower amount of dyestuff will need to be removed from the waste water.

Dyestuffs that are poorly bio-eliminable (unless they are submitted to destructive treatment techniques) will pass through a biological waste water treatment plant and will ultimately end up in the discharged effluent. The first noticeable effect in the receiving water is the colour. High doses of colour not only cause aesthetic impact, but can also interrupt photosynthesis, thus affecting aquatic life. Other effects are related to organic content of the colourant (normally expressed as COD and BOD, but could be better expressed as organic carbon, using TOC, DOC as parameters), its aquatic toxicity and the presence in the molecule of metals or halogens that can give rise to AOX emissions.

These issues are discussed in more detail for each class of dyestuff in Section 9. Only some general key issues are considered in this section.

AOX emissions

Vat, disperse and reactive dyes are more likely to contain halogens in their molecule.

The content of organically bound halogen can be up to 12 % on weight for some *vat dyes*. Vat dyes, however, usually show a very high degree of fixation. In addition, they are insoluble in water and the amount that reaches the effluent can be eliminated with high efficiency in the waste water treatment plant through absorption on the activated sludge.

Reactive dyes, on the contrary, may have low fixation degrees (the lowest level of fixation is observed with phthlocyanine in batch dyeing) and their removal from waste water is difficult because of the low biodegradability and/or low level of absorption of the dye onto activated sludge during treatment. The halogen in MCT (monochlorotriazines) reactive groups is converted into the harmless chloride during the dyeing process. In calculating the waste water burden it is therefore assumed that the MCT reactive groups react completely by fixation or hydrolysis so that they do not contribute to AOX emissions. However, many commonly used polyhalogenated reactive dyes, such as DCT (dichlorotriazine), DFCP (difluorochloropyrimidine) and TCP (trichloropyrimidine) contain organically bound halogen even after fixation and hydrolysis. Bound halogen is also found in discharges of dye-concentrate (pad, kitchen) and non-exhausted dye baths that may still contain unreacted dyestuff.

For the other classes of colourants the AOX issue is not relevant because, with few exceptions, halogen content is usually below 0.1 %.

PARCOM 97/1 recommends strict limits for AOX. Even stricter limits are set by the EU-Ecolabel and German legislation. Extensive investigation of AOX in textile effluents was performed, but AOX as an indicator remains a matter of discussion.

Dyestuffs containing organically bound halogens (except fluorine) are measured as AOX. The only way to limit AOX from dyeing is by dye selection, by more efficient use of dyes or by treating the resulting effluent by decolouration. Effluent decolouration can be achieved using destructive techniques, such as the free radical oxidation or non-destructive techniques (e.g. coagulation, adsorption).

However, it should be noted that AOX from dyes do not have the same effect as the AOX derived from chlorine reactions (haloform reaction, in particular) arising from textile processes such as bleaching, wool shrink-resist treatments, etc.

Dyestuffs are not biodegradable compounds and the halogens in their molecule should not give rise the haloform reaction (main cause of hazardous AOX).

In this respect it is interesting to consider that PARCOM 97/1 does not set a general discharge limit value for AOX, but rather allows discrimination between hazardous and non-hazardous AOX [50, OSPAR, 1997].

Heavy metals emissions

Metals can be present in dyes for two reasons. First, metals are used as catalysts during the manufacture of some dyes and can be present as impurities. Second, in some dyes the metal is chelated with the dye molecule, forming an integral structural element.

Dye manufacturers are now putting more effort into reducing the amount of metals present as impurities. This can be done by selection of starting products, removal of heavy metal and substitution of the solvent where the reaction takes place.

ETAD has established limits in the content of heavy metal in dyestuffs. The values have been set to ensure that emission levels from a 2 % dyeing and a total dilution of the dye of 1:2500, will meet the known waste water requirements [64, BASF, 1994].

Examples of dyes containing bound metals are copper and nickel in phthalocyanine groups, copper in blue copper-azo-complex reactive dyes and chromium in metal-complex dyes used for wool silk and polyamide. The total amount of metallised dye used is decreasing, but there remain domains (certain shades such as greens, certain levels of fastness to light) where phthalocyanine dyes, for example, cannot be easily substituted.

The presence of the metal in these metallised dyes can be regarded as a less relevant problem compared to the presence of free metal impurities. Provided that high exhaustion and fixation levels are achieved and that measures are taken to minimise losses from handling, weighing, drum cleaning, etc., only a little unconsumed dye should end up in the waste water. Moreover, since the metal is an integral part of the dye molecule, which is itself non-biodegradable, there is very little potential for it to become bio-available.

It is also important to take into account that treatment methods such as filtration and adsorption on activated sludge, which remove the dye from the waste water, also reduce nearly proportionally the amount of bound metal in the final effluent. Conversely, other methods such as advanced oxidation, may free the metal.

Toxicity

Dyestuffs showing aquatic toxicity and/ or allergenic effects are highlighted in Section 9. Here it is also important to mention that about 60 % to 70 % of the dyes used nowadays are azo dyes [77, EURATEX, 2000]. Under reductive conditions, these dyes may produce amines and some of them are carcinogenic. A list of carcinogenic amines that can be formed by cleavage of certain azo dyes is shown in the Table 2.13.

1	4-aminodiphenyl
2	Benzidine
3	4-chloro-o-toluidine
4	2-naphthylamine
5	o-aminoazotoluene
6	2-amino-4-nitrotoluene
7	p-chloroaniline
8	2,4-diaminoanisol
9	4,4'-diaminodiphenylmethane
10	3,3'-dichlorobenzidine
11	3,3'-dimethoxybenzidine
12	3,3'-dimethylbenzidine
13	3,3'-dimethyl-4,4'-diaminodiphenylmethane
14	p-cresidine
15	4,4'-methylene-bis-(2-chloraniline)
16	4,4'-oxydianiline
17	4,4'-thiodianiline
18	o-toluidine
19	2,4-diaminotoluene
20	2,4,5-trimethylaniline
21	4-aminoazobenzene
22	o-anisidine

Table 2.13: List of carcinogenic amines

The use of azo-dyes that may cleave to one of the 22 potentially carcinogenic aromatic amines listed above is banned according to the 19th amendment of Directive 76/769/EWG on dangerous substances.

However, more than 100 dyes with the potential to form carcinogenic amines are still available on the market [77, EURATEX, 2000].

Auxiliaries contained in dye formulations

Depending on the dye class and the application method employed (e.g. batch or continuous dyeing, printing) different additives are present in the dye formulations. Since these substances are not absorbed/ fixed by the fibres, they are completely discharged in the waste water. Typical additives are listed in the table below.

Additive	Chemical composition	COD mg O ₂ /kg	BOD ₅ mg O ₂ /kg	TOC elimination (1)
Dispersants	- Lignin sulphonates - Naphthalene sulphonates condensation products with formaldehyde - Ethylene oxide/ propylene oxide copolymers	1200 650	50 50	15 % 15 %
Salts	Sodium sulphate, sodium chloride			
Powder binding agents	Mineral- or paraffin oils (+ additives)			
Anti-foaming agents	Acetyl glycols			
Anti-freeze agents	- Glycerine - Glycols	1200 1600	780 10	90 % 95 %
Thickening agents	- Carboxymethyl cellulose - Polyacrylates	1000	0	30 %
Buffer systems	Phosphate, Acetate			
Source [18, VITO, 1998] Notes: (1) Statistical elimination test (Zahn-Wellens Test) Blank cells mean that data are not available				

Table 2.14: Ecological properties of dye formulations additives

While these additives are not toxic to aquatic life, they are in general poorly biodegradable and not readily bioeliminable. This applies in particular to the dispersants present in the formulations of vat, disperse and sulphur dyes. These dyes are water-insoluble and need these special auxiliaries in order to be applied to the textile in the form of aqueous dispersions. These dispersants consist mainly of naphthalene sulphonate-formaldehyde condensation products and lignin sulphonates, but sulphomethylation products derived from the condensation of phenols with formaldehyde and sodium sulphite can also be found. Other not readily eliminable additives are acrylate and CMC-based thickeners and anti-foam agents.

The difference between liquid and powder formulations should also be mentioned. Dyes supplied in liquid form contain only one third of the amount of dispersing agent normally contained in powder dyes (see Table 2.15). The reason for this difference stems from the manufacturing process of powder dyes: the very small particles generated during grinding must be protected during the subsequent drying process and this is possible only by adding high proportions of dispersing agents.

Formulation component	Powder formulation	Liquid formulation
Dye	30 - 50 %	20 - 40 %
Dispersing agent	40 - 60 %	10 - 30 %
Salts	0 - 20 %	-
Powder binding agents	0 - 5 %	-
Anti-foaming agents	0 - 5 %	0 - 5 %
Anti-freeze agent	-	10 - 15 %
Thickening agent	-	0 - 5 %
Water	5 - 10 %	40 - 60 %
Source [18, VITO, 1998]		

Table 2.15: Proportion of additives and dye in powder and liquid dyes

Note that liquid formulations include liquid dispersions and true solutions (solutions without solubilising aids), whereas powder dyes can be supplied as dusting, free-flowing, non-dusting powders or granulates.

Basic chemicals and auxiliaries used in the dyeing process

Regarding the environmental concerns associated with the chemicals and auxiliaries used in dyeing processes it is worth mentioning the following key issues.

Sulphur-containing reducing agents

Waste water from sulphur dyeing contains sulphides used in the process as reducing agents. In some cases the sulphide is already contained in the dye formulation and in some other cases it is added to the dye bath before dyeing. In the end, however, the excess of sulphide ends up in the waste water. Sulphides are toxic to aquatic organisms and contribute to increasing COD load. In addition, sulphide anions are converted into hydrogen sulphide under acidic conditions, thereby giving rise to problems of odour and corrosivity.

Sodium hydrosulphite (also called sodium dithionite) is another sulphur-containing reducing agent, which is commonly used not only in sulphur and vat dyeing processes, but also as reductive after-cleaning agent in PES dyeing. Sodium hydrosulphite is less critical than sodium sulphide. However, during the dyeing process sodium dithionite is converted into sulphite (toxic to fish and bacteria) and in some cases this is further oxidised into sulphate.

In the waste water treatment plant sulphite is normally oxidised into sulphate, but this can still cause problems. Sulphate, in fact, may cause corrosion of concrete pipes or may be reduced under anaerobic conditions into hydrogen sulphide.

Hydroxyacetone, although it produces an increase in COD load, is recommended to lower the sulphur content in waste water, but it cannot replace hydrosulphite in all applications. New organic reducing agents with improved reducing effects have been developed (see Section 4.6.5 and Section 4.6.6 for further details).

Consumption of the reducing agent by the oxygen present in the machine (partially-flooded dyeing machines) needs also to be taken into account. Instead of applying only the amount of reducing agent required for the reduction of the dyestuff, a significant extra amount of reducing agent often needs to be added to compensate for the amount consumed by the oxygen contained in the machine. This obviously increases oxygen demand of the effluent.

Oxidising agents

Dichromate should no longer be used in Europe as an oxidising agent when dyeing with vat and sulphur dyes, but it is still widely used for the fixation of chrome dyes in wool dyeing. Chromium III exhibits low acute toxicity, while chromium VI is acutely toxic and has been shown to be carcinogenic towards animals. During the dyeing processes with chrome dyes, Cr VI is reduced to Cr III if the process is under control. Nevertheless, emissions of Cr VI may still occur due to inappropriate handling of dichromate during dye preparation (care must be taken as dichromate is carcinogenic and may cause health problems for workers handling it). Emissions of trivalent chromium in the waste water can be minimised (see Section 4.6.15), but cannot be avoided, unless alternative dyestuffs are applied (see Section 4.6.16).

The use of bromate, iodate and chlorite as oxidising agents in vat and sulphur dyeing processes and the use of hypochlorite as stripping agent for decolouring faulty goods or for cleaning dyeing machines (e.g. before subsequent lighter-coloured dyeing) may produce AOX emissions. However, only hypochlorite and elemental-chlorine-containing compounds (e.g. certain chlorite products that contain Cl₂ or use chlorine as activator for formation of chlorine dioxide gas) are likely to give rise to hazardous AOX.

Salt

Salts of various types are used in dyeing processes for different purposes (e.g. to promote level dyeing or increase dye exhaustion). In particular, large amounts of salt are used in cotton batch dyeing processes with reactive dyes. The amount of salt employed is quite significant compared to other classes of dyestuffs, for example direct dyes (Table 2.16) and efforts have been made by dye manufacturers to solve this problem (see Section 4.6.11).

Shade	Dye o.w.f	Amount of salt applied with direct dyes	Amount of salt applied with reactive dyes
Paste/light	<1.5 %	2.5 - 7.5 g/l	30 - 60 g/l
Medium	1.0 - 2.5 %	7.5 - 12.5 g/l	70 - 80 g/l
Dark	>2.5 %	12.5 - 20 g/l	80 - 100 g/l
Source [11, US EPA, 1995]			

Table 2.16: Amount of salt employed in cotton batch dyeing processes with reactive and direct dyes

In addition to the use of salt as a raw material, neutralisation of commonly employed acids and alkalis produces salts as a by-products.

Salts are not removed in conventional waste water treatment systems and they are therefore ultimately discharged in the receiving water. Although the mammalian and aquatic toxicity of the commonly employed salts are very low, in arid or semi-arid regions their large-scale use can produce concentrations above the toxic limit and increase the salinity of the groundwater.

Countries have set emission limits at 2000 ppm or below. River quality standards must also be taken into account.

Carriers

The use of these auxiliaries, which were widely employed in the past, has now been reduced due to ecological and health problems. They are still an issue in dyeing of polyester in blend with wool.

Carriers may already be added to the dyes by manufacturers. In this case textile finishers will have little knowledge of the loads discharged ([4, Tebodin, 1991] and [61, L. Bettens, 1999]).

Carriers (see Section 8.6.7) include a wide group of organic compounds, many of them steam volatile, poorly biodegradable and toxic to humans and aquatic life. However, as the active substances usually have high affinity for the fibre (hydrophobic types), 75 – 90 % are absorbed by the textile and only the emulsifiers and the hydrophilic-type carriers such as phenols and benzoates derivatives are found in the waste water. The carriers that remain on the fibre after dyeing and washing, are partially volatilised during drying and fixing operations and can give rise to air emissions. Traces can still be found on the finished product, thus representing a potential problem for the consumer.

Alternative options are described in Sections 4.6.1 and 4.6.2.

Other auxiliaries of environmental interest

Other substances that may be encountered in the dyeing auxiliaries and that may give rise to water pollution are:

- fatty amine ethoxylates (levelling agent)
 - alkylphenol ethoxylates (levelling agent)
 - quaternary ammonium compounds (retarders for cationic dyes)
 - polyvinylpyrrolidone (levelling agent for vat, sulphur and direct dyes)
 - cyanamide-ammonia salt condensation products (auxiliaries for fastness improvement)
 - acrylic acid-maleic acid copolymers (dispersing agent)
 - ethylenediamine tetraacetate (EDTA)
 - diethylenetriaminepentaacetate (DTPA)
 - ethylenediaminetetra(methylenephosphonic acid) (EDTMP)
 - diethylenetriaminepenta(methylenephosphonic acid) (DTPMP)
- } complexing agents

These are water-soluble hard-to-biodegrade compounds which can pass untransformed or only partially degraded, through waste water treatment systems.

In addition, some of them are toxic (e.g. quaternary amines) or can give rise to metabolites which may affect reproduction in the aquatic environment (APEO).

2.7.8.2 Environmental issues related to the process

Both water and energy consumption in dyeing processes are a function of the dyeing technique, operating practices and the machinery employed.

Batch dyeing processes generally require higher water and energy consumption levels than continuous processes. This is due to a number of different factors.

The higher *liquor ratios* involved in batch dyeing represent one of these factors. As previously mentioned in Section 2.7.2, higher liquor ratios mean not only higher water and energy uses, but also a higher consumption of those chemicals and auxiliaries that are dosed based on the volume of the bath.

Consistently with the quality of the different types of substrates, all equipment manufacturers now can offer machines with reduced liquor ratios. Terms like “low liquor ratio” and “ultra-low liquor ratio” are now commonly used to define the performance/ features of modern machines.

For dyeing fabric in rope form nominal reference values for “*low liquor ratio machines*” are in the range of 1:5 - 1:8 for cotton and correspondingly 1:3 - 1:4 for PES. The liquor ratio can be higher for other types of substrates/fibres.

The term “*Ultra-low liquor ratio*” is used to define machines that can be operated at liquor ratios as low as the minimum volume required to completely wet out the substrate and avoid cavitations of the pumps. This term applies only to machines for dyeing fabric in rope form.

It is important to show the difference between the *nominal* and the *real* liquor ratio. As already stated in Section 2.7.2, the nominal liquor ratio is the liquor ratio at which a machine can be operated when it is loaded at its maximum/ optimal capacity. It is often the case that the machine is underloaded compared to its optimal capacity. This often occurs in commission companies where a high production flexibility is required to serve variable lot sizes according to customer’s demands. Modern machines can still be operated at approximately constant liquor ratio whilst being loaded at a level as low as 60 % of their nominal capacity (or even 30 % of their nominal capacity with yarn dyeing machines – see Section 4.6.19). In this way the same benefits achievable with low liquor ratios can be kept even with reduced loading. It is obvious however, that when a machine is loaded far below its optimal capacity (e.g. below 60 % of its nominal capacity for fabric dyeing machines) the *real liquor ratio* will differ greatly from the nominal liquor ratio. This will result not only in lower environmental performances (higher water, energy and chemicals consumptions), but also in higher operating costs.

In conclusion, the use of low liquor ratio machinery, or selection of the most adequate machine for the size of the lot to be processed, is fundamental to the resultant environmental performance of the process.

Having said that, high energy and water consumption in batch dyeing is not only the result of high liquor ratios.

Another factor to take into consideration is the *discontinuous nature of the batch dyeing operating mode*, especially with regard to operations such as *cooling, heating, washing and rinsing*.

Furthermore, shade matching can be responsible for higher water and energy consumption, especially when dyeing is carried out without the benefit of laboratory instruments. In a manual regime the bulk of the dyestuff is normally applied in the first phase to obtain a shade which is close to that required in the final product. This is followed by a number of matching operations, during which small quantities of dye are applied to achieve the final shade. Shades which are difficult to match may require repeated shade additions with cooling and reheating between each addition [32, ENco, 2001].

Increased energy and water consumption may also be caused by inappropriate *handling techniques* and/or poorly performing *process control systems*. For example, in some cases displacement spillage may occur during immersion of the fibre in the machine, while the potential for overfilling and spillage exists where the machines are only equipped with manual control valves, which fail to control the liquor level and temperature correctly (see also Section 4.1.4).

Continuous and semi-continuous dyeing processes consume less water, but this also means a higher dyestuff concentration in the dye liquor. In discontinuous dyeing the dye concentration varies from 0.1 to 1 g/l, while in continuous processes this value is in the range of 10 to 100 g/l. The residual padding liquor in the pads, pumps and pipes must be discarded when a new colour is started. The discharge of this concentrated effluent can result in a higher pollution load compared with discontinuous dyeing, especially when small lots of material are processed. However, modern continuous dyeing ranges have steadily improved in recent years. The use of small pipes and pumps and small pad-bath troughs help to reduce the amount of concentrated liquor to be discharged. In addition, it is possible to minimise the discard of leftovers, by using automated dosing systems, which meter the dye solution ingredients and deliver the exact amount needed (see also Sections 4.1.3 and 4.6.7 for more detailed information about recent improvements).

In both continuous and batch dyeing processes, final washing and rinsing operations are water-intensive steps that need to be taken into consideration. Washing and rinsing operations actually consume greater quantities of water than dyeing itself (see Sections 4.9.1 and 4.9.2 for water and energy conservation techniques in batch and continuous processing and Sections 4.1.4 and 4.6.19 for equipment optimisation in batch processing).

2.8 Printing

2.8.1 Printing processes

Printing, like dyeing, is a process for applying colour to a substrate. However, instead of colouring the whole substrate (cloth, carpet or yarn) as in dyeing, print colour is applied only to defined areas to obtain the desired pattern. This involves different techniques and different machinery with respect to dyeing, but the physical and chemical processes that take place between the dye and the fibre are analogous to dyeing.

A typical printing process involves the following steps:

- colour paste preparation: when printing textiles, the dye or pigment is not in an aqueous liquor, instead, it is usually finely dispersed in a printing paste, in high concentration
- printing: the dye or pigment paste is applied to the substrate using different techniques, which are discussed below
- fixation: immediately after printing, the fabric is dried and then the prints are fixed mainly with steam or hot air (for pigments). Note that intermediate drying is not carried out when printing carpets (too much energy would be needed for removing the highly viscous liquor)
- after-treatment: this final operation consists in washing and drying the fabric (it is not necessary when printing with pigments or with other particular techniques such as transfer printing).

When describing the different printing techniques, a distinction should be made between printing with pigments, which have no affinity for the fibre, and printing with dyes (reactive, vat, disperse, etc.).

2.8.1.1 Printing with pigments

Pigment printing has gained much importance today and for some fibres (e.g. cellulose fibres) is by far the most commonly applied technique. Pigments can be used on almost all types of textile substrates and, thanks to increased performance of modern auxiliaries, it is now possible to obtain high-quality printing using this technique.

Pigment printing pastes contain a thickening agent, a binder and, if necessary, other auxiliaries such as fixing agents, plasticizers, defoamers, etc.

White spirit-based emulsions, used in the past as thickening systems, are used only occasionally today (mainly half-emulsion thickeners). More information regarding the characteristics of the auxiliaries used can be found in Section 8.7.2

After applying the printing paste, the fabric is dried and then the pigment is normally fixed with hot air (depending on the type of binder in the formulation, fixation can also be achieved by storage at 20 °C for a few days). The advantage of pigment printing is that the process can be done without subsequent washing (which, in turn, is needed for most of the other printing techniques).

2.8.1.2 Printing with dyes

Printing paste preparation

The process traditionally starts with the preparation of the paste. Compared to pigment printing, the composition of the pastes is more complex and variable, being determined not by the dye used, but by the printing technique, the substrate, the application and the fixation methods applied.

Apart from the dye, printing pastes contain a thickening agent (see also Section 8.7.1) and various other auxiliaries, which can be classified according to their function as follows:

- oxidising agents (e.g. m-nitrobenzenesulphonate, sodium chlorate, hydrogen peroxide)
- reducing agents (e.g. sodium dithionite, formaldehyde sulphonylates, thiourea dioxide, tin(II) chloride)
- discharging agents for discharge printing (e.g. anthraquinone)
- substances with a hydrotropic effect, like urea
- dye solubilisers, which are polar organic solvents like glycerine, ethylen glycol, butyl glycol, thiodiglycol, etc.
- resists for reactive resist printing (e.g. sulphonated alkanes)
- defoamers, (e.g. silicon compounds, organic and inorganic esters, aliphatic esters, etc.).

All the necessary ingredients are metered (dosed) and mixed together in a mixing station. Since between 5 and 10 different printing pastes are usually necessary to print a single pattern (in some cases up to 20 different pastes are applied), in order to reduce losses, due to incorrect measurement, the preparation of the pastes is done in automatic stations. In modern plants, with the help of special devices, the exact amount of printing paste required is determined and prepared in continuous mode for each printing position, thus reducing leftovers at the end of the run.

It is common practice in many printing houses to filter the printing pastes before application, using for example a filter cloth. This operation is especially important for thickeners to prevent free particles from blocking the openings of the screens.

Printing (paste application)

After preparation, the paste is applied to specific areas of the textile using one of the following techniques:

- direct printing (which also includes digital and transfer printing)
- discharge printing
- resist printing.

In the case of *direct printing* the dye is applied to specific areas of a pretreated textile substrate, which can be white or pre-dyed (in light colours).

It is possible to speak of *discharge printing*, if in the fixation process that follows the application of the printing paste there is local destruction of a dye applied previously. If the etched (discharge), previously dyed area becomes white, then the process is called *white discharge*. If, on the contrary, a coloured pattern has to be obtained in the etched area after the destruction of the previously applied dye, then the process is called *coloured discharge*. In this case the printing paste must contain a reduction-resistant dye along with the chemicals needed to destroy the previous one. As a result the pre-dyed background is destroyed according to a pattern and the dye, which is resistant to reduction, takes its place.

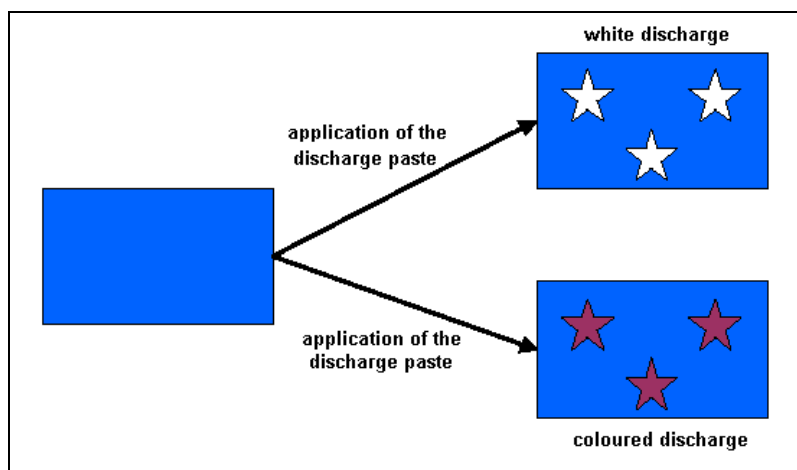


Figure 2.15: Schematic representation of discharge printing
[63, GuT/ ECA, 2000]

In the case of *resist printing*, a special printing paste (called “resist”) is printed onto certain areas of the fabric to prevent dye fixation. In the case of *physical resist* the material is printed with a difficult-to-wet resin that inhibits the penetration of a dye applied in a second stage. On the other hand, with a *chemical resist*, dye fixation is prevented by a chemical reaction. Depending on the way the process is carried out, one can speak of pre-printing, intermediate or over-printing resists. One common procedure is the wet-on-wet process in which the resist paste is initially printed, then the material is overprinted with full cover screen and finally fixed and

washed. Over-printing resists can be applied only if the dye, already present in the previously dyed and dried fabric, is still in its unfixed form, as in the case of developing dyes.

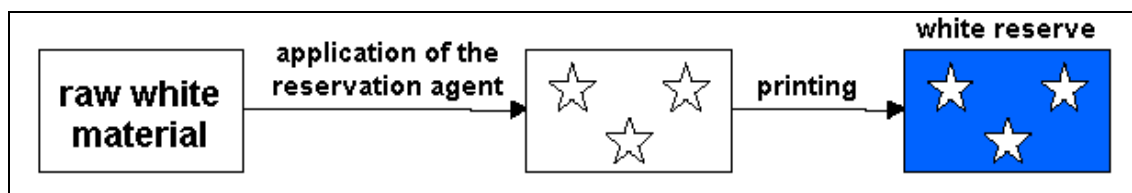


Figure 2.16: Schematic representation of resist printing
[63, GuT/ ECA, 2000]

The difference between *transfer printing* and the techniques described earlier is that with this technique the surface of the fabric is not directly printed. Instead, the pattern is first created on an intermediate carrier (e.g. paper) using selected disperse dyes and then it is transferred from there to the fabric. The dye is usually fixed by placing the printed paper in contact with the fabric into a thermal pressure system. Under the influence of the heat the dye sublimates and diffuses from the carrier into the fibre of the textile substrate. There is no need for further treatment such as steaming, washing, etc. This technique is applied for polyester, polyamide and some acrylic fibres, using selected disperse dyestuffs according to the specific type of fibre.

Fixation

After printing, the fabric is dried. Water evaporation leads to an increase in dye concentration and at the same time prevents the colours from smearing when the fabric is transported over the guide rollers. At this stage the dye is not yet fixed.

The aim of the subsequent fixation step is to transport as much as possible of the dye, which is retained by the thickener, into the fibres. This is especially important with dyes, such as vat dyes, for example, that are printed in the insoluble form and are converted into the corresponding soluble state only after reaction with the reducing agents during the fixation process.

Fixation is usually carried out with steam. Water vapour condenses on the printed material, swells up the thickener, heats the print and provides the necessary transport medium for the diffusion of the dye. The distribution of the dye between fibre and thickener is an important factor in determining the fixation degree of the dye, which is called the "retaining power" of the thickener. The thickener, in fact, is often composed of polysaccharides and therefore competes with cellulose in retaining the dye. This is the main reason why the fixation rate of a given dye is 10 % lower in printing than in dyeing.

After-treatment

The last step of the printing process consists in washing and drying the fabric. When printing with insoluble dyes such as vat dyes this operation also serves as a means to re-convert the dye to the original oxidised state. In this case, after an initial rinsing with cold water, the printed material is treated with hydrogen peroxide. The process is completed with a soap treatment with sodium carbonate at the boiling point.

As already explained, washing is not necessary with pigment printing and transfer printing. This holds for any dyeing/ printing system where thickeners are not needed and where the dyestuff is (nearly) completely fixed (e.g. printing carpet tiles with digital jet printing techniques, see Section 4.7.8)

Ancillary operations

At the end of each batch and at each colour change various cleaning operations are carried out:

- the rubber belt, to which the fabric is glued during printing (see description below), is cleaned in continuous mode with water to remove excess adhesive and printing paste. Some machines are equipped with water re-circulation systems
- the printing gears (all systems responsible for feeding and applying the paste to the substrate) are cleaned by first removing as much as possible of the paste residues and then rinsing with water. In some companies the paste residues are directed back to the appropriate printing paste batch containers for re-use
- the remaining paste in the containers, in which the paste is prepared (paste vats), are in general previously cleaned up by means of sucking systems before being washed out with water. The residual printing paste collected in this manner is then disposed of.

2.8.2 Printing technology

A variety of different machines can be used for printing fabrics. The most commonly used are described below.

Flat-screen printing

Flat-screen and rotary-screen printing are both characterised by the fact that the printing paste is transferred to the fabric through openings in specially designed screens. The openings on each screen correspond to a pattern and when the printing paste is forced through by means of a squeegee, the desired pattern is reproduced on the fabric. A separate screen is made for each colour in the pattern.

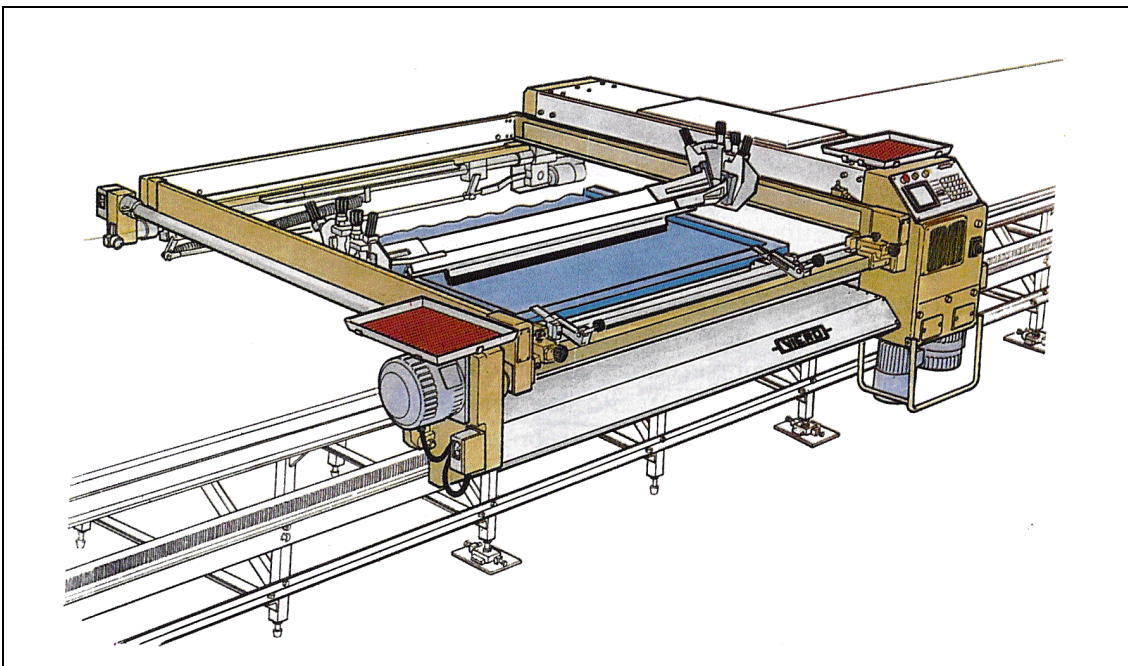


Figure 2.17: Screen printing with automatic squeegee system
[69, Corbani, 1994]

Flat-screen printing machines can be manual, semi-automatic or completely automatic. One type of machine, which is still commonly found in printing houses, can be described as follows. The fabric is first glued to a moving endless belt. A stationary screen at the front of the machine, is lowered onto the area that has to be printed and the printing paste is wiped with a

squeegee. Afterwards the belt, with the fabric glued on it, is advanced to the pattern-repeat point and the screen is lowered again. The printed fabric moves forward step by step and passes through a dryer. The machine prints only one colour at a time. When the first colour is printed on the whole length of the fabric, the dried fabric is ready for the second cycle and so on until the pattern is completed.

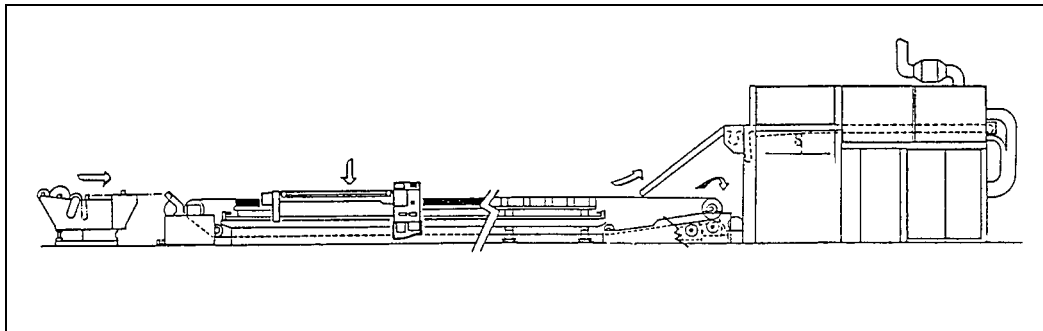


Figure 2.18: Representation of a flat-screen printing machine

In other fully mechanised machines all the colours are printed at the same time. A number of stationary screens (from 8 to 12, but some machines are equipped with up to 24 different screens) are placed along the printing machine. The screens are simultaneously lifted, while the textile, which is glued to a moving endless rubber belt, is advanced to the pattern-repeat point. Then the screens are lowered again and the paste is squeezed through the screens onto the fabric. The printed material moves forward one frame at each application and as it leaves the last frame it is finally dried and it is ready for fixation.

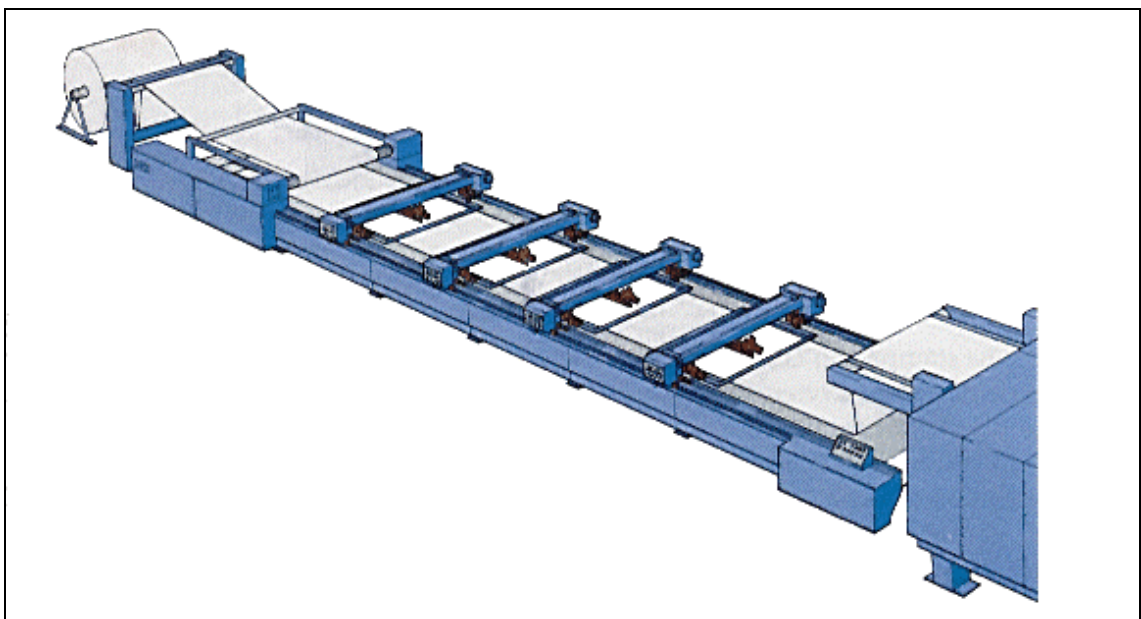


Figure 2.19: Representation of "Mechanised screen printing machine with stationary screens mounted in a frame"
[69, Corbani, 1994]

In both machines the continuous rubber belt, after pulling away the fabric, is moved downward in continuous mode over a guide roller and washed with water and rotating brushes to remove the printing paste residues and the glue, if necessary. After this, the belt is sent back to the gluing device. In some cases the glue is applied in liquid form by a squeegee, while in other machines the belts are pre-coated with thermoplastic glues. In this case the textile is heated and

then it is squeezed by a roller or simply pressed against the rubber-coated belt, causing the glue to soften and instantly adhere.

After printing, the screens and the application system are washed out. It is common practice to squeeze the colour from the screens back into the printing paste mixing containers before washing them.

Rotary-screen printing

Rotary-screen printing machines use the same principle described earlier, but instead of flat screens, the colour is transferred to the fabric through lightweight metal foil screens, which are made in the form of cylinder rollers. The fabric moves along in continuous mode under a set of cylinder screens while at each position the print paste is automatically fed to the inside of the screen from a tank and is then pressed through onto the fabric. A separate cylinder roller is required for each colour in the design.

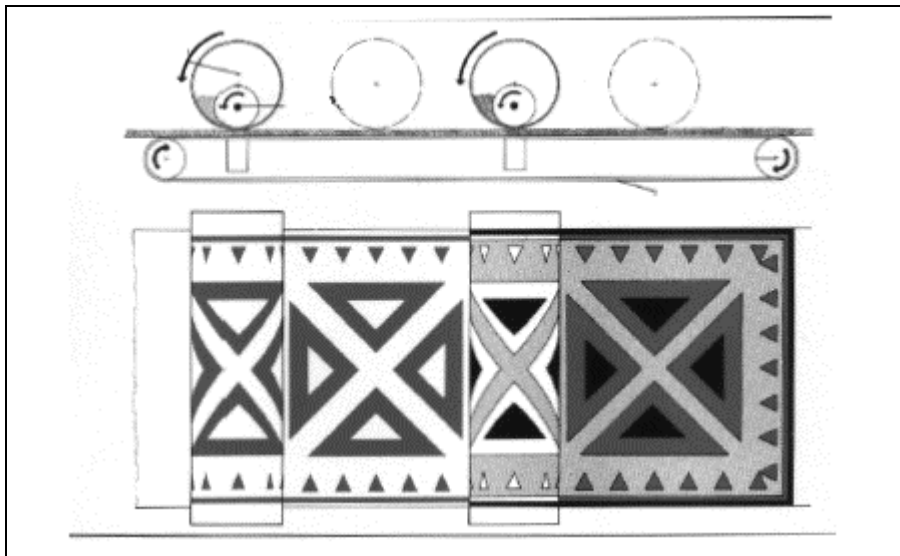


Figure 2.20: Representation of the rotary-screen printing process [63, GuT/ ECA, 2000]

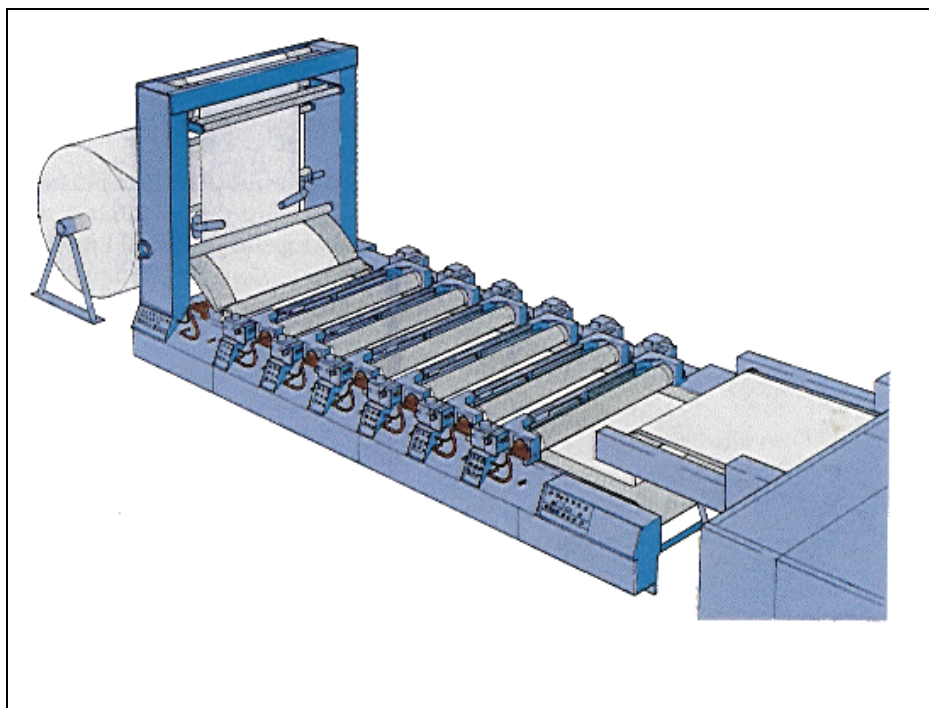


Figure 2.21: Representation of a rotary-screen printing machine
[69, Corbani, 1994]

A conventional paste feeding system for rotary-screen printing machines is represented in Figure 2.22. A suction pipe leads from the paste vat to a pump, from where a printing hose leads to the squeegee (dye pipe with squeegee). From here the paste is directed inside the cylinder roller. The fill volume of this so-called printing paste input system is quite high and as a consequence the amount of paste residue that has to be removed at each colour change is also fairly significant. Various systems have been introduced in order to lower the volume configuration of this equipment, which also reduces the amount of such wastes (see Section 4.7.4). Another possibility, which has also already been implemented in some companies, is to recover and re-use these residues for making up new recipes (see Sections 4.7.5 and 4.7.6).

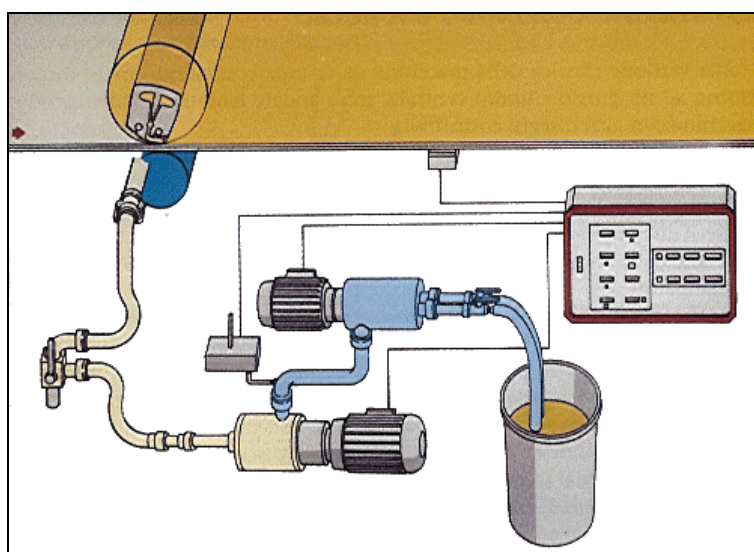


Figure 2.22: Printing-paste feeding system for a rotary-screen printing machine
[69, Corbani, 1994]

Rotary-screen printing machines are equipped with both gluing and washing devices analogous to those described earlier for flat-screen printing. The belt is washed in order to remove the residues of paste and adhesive. Not only the belt, but also the screens and the paste input systems (hoses, pipes, pumps, squeegees, etc.) have to be cleaned up at each colour change.

Roller printing

In roller printing, the print paste is supplied from reservoirs to rotating copper rollers, which are engraved with the desired design. These rollers contact a main cylinder roller that transports the fabric. By contacting the rollers and the fabric the design is transferred to the fabric. As many as 16 rollers can be available per print machine, each roller imprints one repeat of the design. As the roller spins, a doctor blade in continuous mode scrapes the excess of paste back to the colour trough. At the end of each batch the paste reservoirs are manually emptied into appropriate printing paste batch containers and squeezed out. The belt and the printing gear (roller brushes or doctor blades, squeegees and ladles) are cleaned up with water.

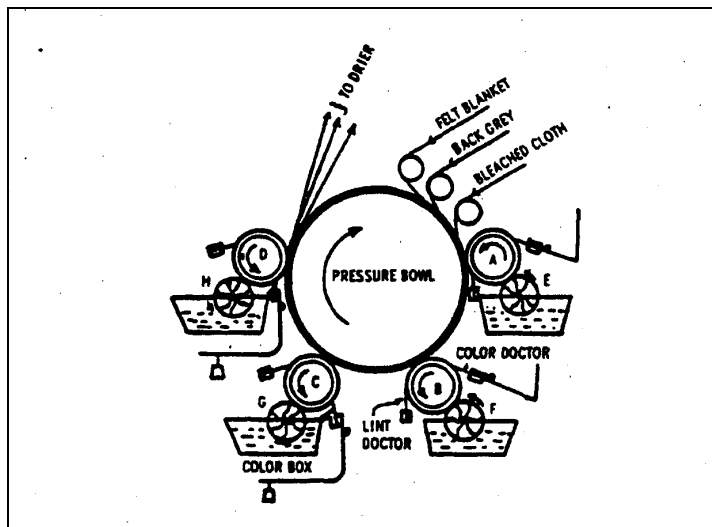


Figure 2.23: Roller printing machine [4, Tebodin, 1991]

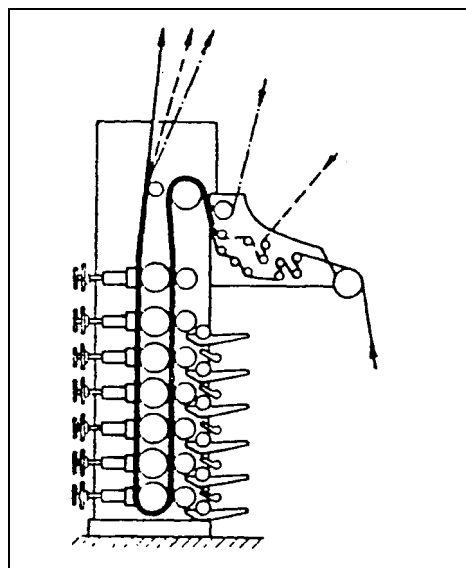


Figure 2.24: More recent example of roller printing machine [7, UBA, 1994]

Jet printing

Jet printing is a non-contact application system originally developed for printing carpets, but now increasingly used in the textile sector.

The first commercial jet printing machine for carpets was the Elektrocolor, followed by the first Millitron machine. In the Millitron printing system, the injection of the dye into the substrate is accomplished by switching on and off a dye jet by means of a controlled air stream. As the carpet moves along, no parts of the machine are in contact with the face of the substrate. Air streams are used to keep continuously flowing dye jets, deflected into a catcher or drain tray. This dye is drained back to the surge tank, filtered and re-circulated. When a jet is requested to fire, the air jet is momentarily switched off, allowing the correct amount of dye to be injected into the textile substrate. The dye is supplied in continuous mode to the main storage tank to compensate for the amount of dye consumed.

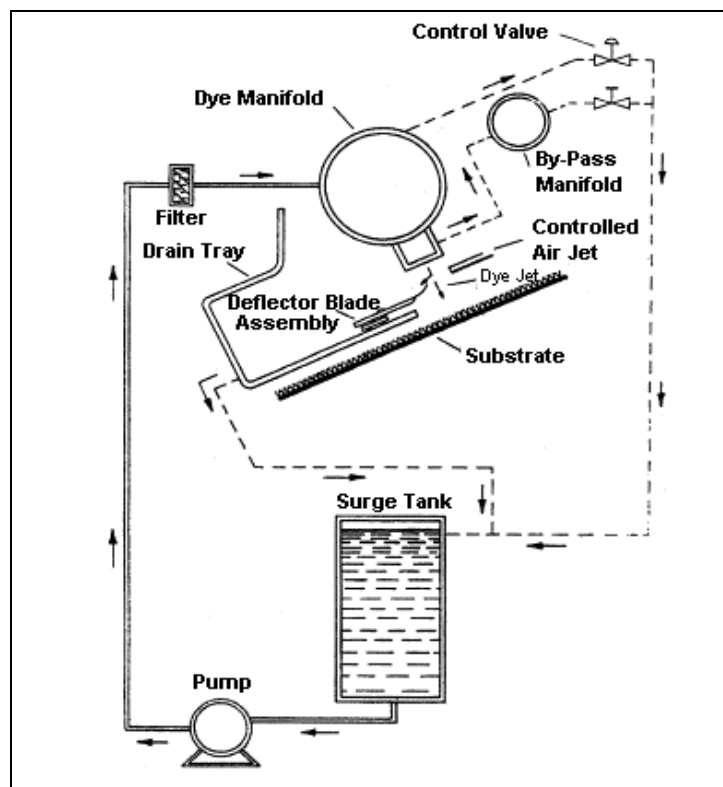


Figure 2.25: Schematic representation of the Millitron system
[63, GuT/ ECA, 2000]

Spray printing systems and first generation jet printing methods cannot be controlled to produce a pre-specified pattern. Thus the equipment must first be employed to produce a wide range of effects and only then can selections be made from these by the designer or marketing staff.

An early improvement was made by the first digital carpet printers (Chromotronic and Titan by Zimmer and Tybar Engineering, respectively). These machines are based on the so-called “drop on demand principle”, namely the use of switchable electromagnetic valves placed in the dye liquor feed tubes to allow the jetting of discrete drops of dye liquor in a predetermined sequence according to the desired pattern.

In these machines, although the amount of dye applied can be digitally controlled at each point of the substrate, further penetration of the dye into the substrate is still dependent on capillary

action of the fibre and fibre surface wetting forces. This can lead to problems of reproducibility (e.g. when the substrate is too wet) and means that it is still necessary to use thickeners to control the rheology of the dye liquor.

The latest improvement in jet printing of carpet and bulky fabrics is now represented by machines in which the colour is injected with surgical precision deep into the face of the fabric without any machine parts touching the substrate. Here, the control of the quantity of liquor applied to the substrate (which may vary for example from lightweight articles to heavy quality fabrics) is achieved by varying not only the “firing time” but also the pumping pressure.

This system can be likened to an “injection dyeing” process. The name “injection dyeing” is used as a commercial name to define the technology applied on the latest Milliken’s Millitron machine. Another digital jet printing machine commercially available is Zimmer’s Chromojet. In the Chromojet system, the printing head is equipped with 512 nozzles. These are magnetically controlled and can open and close up to 400 times a second (see also Section 4.7.8).

The carpet is accumulated into a J-box, and is then steamed and brushed. When it reaches the printing table it is stopped. The jets are mounted on a sliding frame that can itself be moved in the direction of the warp while the carpet remains stationary during the printing process.

Ink-jet printing is another digital printing technique with its origins in paper printing technology that is now also increasingly used in the textile industry. In ink-jet printing, colour is applied to the surface of the substrate without variation in firing time, pressure or velocity. For this reason it can only be applied for flat light fabrics, especially silk (see also Section 4.7.9).

The TAK printing system can still be found in the carpet industry. With this technique irregular patterns can be produced. The carpet, previously dyed with a ground shade, is provided with coloured spots through dripping. The size and the frequency of the coloured spots can be varied by adjusting the overflow groove placed along the carpet width.

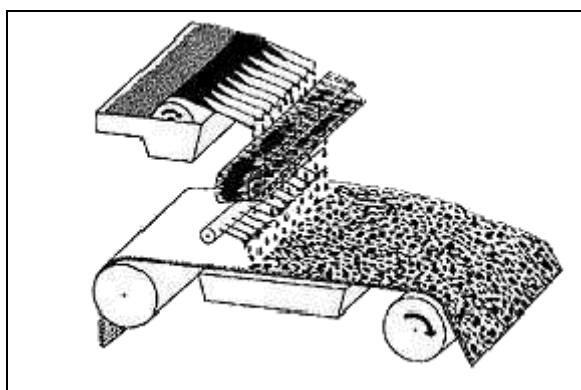


Figure 2.26: Schematic representation of the TAK system
[63, GuT/ ECA, 2000]

2.8.3 Environmental issues

Emission sources typical of printing processes are:

- printing paste residues
- waste water from wash-off and cleaning operations
- volatile organic compounds from drying and fixing.

Printing paste residues

Printing paste residues are produced for different reasons during the printing process and the amount can be particularly relevant (Section 3.3.3.5.5 provides information about consumption and emission levels). Two main causes are, for example, incorrect measurements and the common practice of preparing excess paste to prevent a shortfall.

Moreover, at each colour change, printing equipment and containers (dippers, mixers, homogenizers, drums, screens, stirrers, squeegees, etc.) have to be cleaned up. Print pastes adhere to every implement due to their high viscosity and it is common practice to use dry capture systems to remove them before rinsing with water. In this way these residues can at least be disposed of in segregated form, thus minimising water contamination.

Another significant, but often forgotten source of printing paste residues is the preparation of sample patterns. Sometimes they are produced on series production machines, which means high specific amounts of residues produced.

There are techniques available that can help to reduce paste residues (see Section 4.7.4) and techniques for recovery/re-use of the surplus paste (see Sections 4.7.5 and 4.7.6). Their success is, however, limited due to a number of inherent technological deficiencies of analogue printing technology. Most of these deficiencies are related to the analogue transfer of the pattern, the unavoidable contact between the surface of the substrate and the applicator (screen) and the need for thickeners in the formulation (paste rheology), which limits the ultimate potential for paste re-use. Digital printing offers a solution to these problems (see Sections 4.7.8 and 4.7.9).

Waste water from wash-off and cleaning operations

Waste water in printing processes is generated primarily from final washing of the fabric after fixation, cleaning of application systems in the printing machines, cleaning of colour kitchen equipment and cleaning of belts.

Waste water from cleaning-up operations accounts for a large share of the total pollution load, even more than water from wash-off operations.

Emission loads to water are mainly attributable to dyestuff printing processes because in the case of pigment printing, although considerable amounts of waste water arise from cleaning operations, pigments are completely fixed on the fibre without need for washing-off.

Pollutants that are likely to be encountered in waste water are listed in the table below.

Pollutant	Source	Remarks
Organic dyestuff	Unfixed dye	The related environmental problems depend on the type of dyestuff concerned (these are discussed in Section 9)
Urea	Hydrotropic agent	High levels of nitrogen contribute to eutrophication
Ammonia	In pigment printing pastes	High levels of nitrogen contribute to eutrophication
Sulphates and sulphites	Reducing agents by-products	Sulphites are toxic to aquatic life and sulphates may cause corrosion problems when concentration is >500 mg/l
Polysaccharides	Thickeners	High COD, but easily biodegradable
CMC derivatives	Thickeners	Hardly biodegradable and hardly bioeliminable
Polyacrylates	Thickeners Binder in pigment printing	Hardly biodegradable, but >70 % bioeliminable (OECD 302B test method)
Glycerin and polyols	Anti-freeze additives in dye formulation Solubilising agents in printing pastes	
m-nitrobenzene sulphonate and its corresponding amino derivative	In discharge printing of vat dyes as oxidising agent In direct printing with reactive dyes inhibits chemical reduction of the dyes	Hardly biodegradable and water-soluble
Polyvinyl alcohol	Blanket adhesive	Hardly biodegradable, but >90 % bioeliminable (OECD 302B test method)
Multiple-substituted aromatic amines	Reductive cleavage of azo dyestuff in discharge printing	Hardly biodegradable and hardly bioeliminable
Mineral oils / aliphatic hydrocarbons	Printing paste thickeners (half-emulsion pigment printing pastes are still occasionally used)	Aliphatic alcohols and hydrocarbons are readily biodegradable Aromatic hydrocarbons are hardly biodegradable and hardly bioeliminable

Table 2.17: Pollutants that are more likely to be encountered in waste water from printing processes

Volatile organic compounds from drying and fixing

Drying and fixing are another important emission source in printing processes. The following pollutants may be encountered in the exhaust air [179, UBA, 2001]:

- aliphatic hydrocarbons (C₁₀-C₂₀) from binders
- monomers such as acrylates, vinylacetates, styrene, acrylonitrile, acrylamide, butadiene
- methanol from fixation agents
- other alcohols, esters, polyglycols from emulsifiers
- formaldehyde from fixation agents
- ammonia (from urea decomposition and from ammonia present, for example, in pigment printing pastes)
- N-methylpyrrolidone from emulsifiers
- phosphoric acid esters
- phenylcyclohexene from thickeners and binders.

A more comprehensive list of pollutants potentially present in the exhaust air from heat treatment after printing, with an indication of the potential source, is given in Section 12.

2.9 Finishing (functional finishing)

2.9.1 Finishing processes

The term "finishing" covers all those treatments that serve to impart to the textile the desired end-use properties. These can include properties relating to visual effect, handle and special characteristics such as waterproofing and non-flammability.

Finishing may involve mechanical/physical and chemical treatments. Moreover, among chemical treatments one can further distinguish between treatments that involve a chemical reaction of the finishing agent with the fibre and chemical treatments where this is not necessary (e.g. softening treatments).

Some finishing treatments are more typical for certain types of fibre (for example, easy-care finishes for cotton, antistatic treatment for synthetic fibres and mothproofing and anti-felt treatments for wool). Other finishes have more general application (e.g. softening).

In this document particular attention is given to chemical finishes because these are the processes with the most significant polluting potential.

In the case of fabric (including carpets in piece form), the finishing treatment often takes place as a separate operation after dyeing. However, this is not a rule: in carpets, for example, mothproofing can be carried out during dyeing and, in pigment dyeing, resin finishing and pigment dyeing are combined in the same step by applying the pigment and the film-forming polymer in the dyeing liquor.

In more than 80 % of cases, the finishing liquor, in the form of an aqueous solution/dispersion, is applied by means of padding techniques. The dry fabric is passed through the finishing bath containing all the required ingredients, and is then passed between rollers to squeeze out as much as possible of the treating solution before being dried and finally cured. Washing as final step, tends to be avoided unless absolutely necessary.

In order to reduce the pick-up, other so-called minimum application techniques are gaining importance. These are topical application methods like:

- kiss-roll (or slop-padding) application (the textile is wetted by means of a roller, which is immersed in a trough and which applies a controlled amount of liquor on only one side of the textile)
- spray application
- foam application.

In the case of foulard application the pick-up is approximately 70 %, while with minimum application systems this can be about 30 %. In the minimum application techniques, however, the liquors are more concentrated by a factor of 2 to 3 in order to allow the same amount of active ingredient to be applied.

In the wool yarn carpet sector the functional finishes are applied to the yarn or to the loose fibre either during the dyeing process or in the subsequent rinsing or finishing bath.

Apart from particular cases where there are problems of incompatibility between the different auxiliaries, both with padding and long liquor application techniques (batch processes), all the finishing agents necessary to give the textile material the desired properties are applied in a single bath rather than in different steps.

2.9.2 Chemical finishing treatments

2.9.2.1 Easy-care treatments

Easy-care finishings are applied to cellulose-containing fibres to impart characteristics such as easy-to-wash, creasing resistance during wash and wear, no ironing or minimum ironing. These properties are now required for cellulose fibres to allow them to compete with synthetic fibres such as polyamide and polyester.

Easy-care recipes consist of various ingredients:

- cross-linking agent
- catalyst
- additives (softeners, hand builder most commonly, but also water-repellents, hydrophilizing agents, etc.)
- surfactants as wetting agent.

Information about the typical substances used can be found in Section 8.8.1. In the easy-care process the fabric, after being padded, is dried in open-width in a stenter frame and is finally cured. The most common curing method is the dry cross-linking process, in which the fabric is cured in a dry state in a curing apparatus or on the stenter immediately after drying.

2.9.2.2 Water-repellent treatments (hydrophobic treatments)

Water-repellent treatments are applied to fabrics for which waterproofing properties are required but which also need air and water-vapour permeability.

This may be obtained by:

- precipitation of hydrophobic substances such as paraffin emulsions together with aluminium salts (e.g. wax-based repellents)
- chemical transformation of the surface of the fibre by addition of polymers that form a cross-linked water-repellent film (e.g. silicone repellents, resin-based repellents, fluorochemical repellents).

The characteristics of the substances used as water-repellents are described in Section 8.8.5.

2.9.2.3 Softening treatments

Softeners are used not only in finishing processes, but also in batch dyeing processes, where they are applied in the dyeing baths or in the subsequent washing baths.

The application of softening agents does not involve curing processes. In continuous or semi-continuous processes the impregnated fabric is dried in the stenter frame.

The substances used as softening agents are described in Section 8.8.6.

2.9.2.4 Flame-retardant treatments

Flame-retardant finishing has become more and more important and is compulsory for some articles. Flame-retardant treatments should protect the fibre from burning, without modifying the handle, the colour or the look of the fabric.

They are generally applied to cotton and synthetic fibres (e.g. they are important in the furniture sector for upholstery fabric). In some specific cases, in particular in the carpet sector (e.g. contract market, aviation), they can also be required for wool, even though this fibre is already inherently flame resistant.

Flame-retardant properties are achieved by the application of a wide range of chemicals, which either react with the textile or are used as additives. Substances that are usually used as flame-retardant finishing treatments are described in Section 8.8.4.

There are other approaches available to produce textile products with flame-retardant properties including:

- the addition of specific chemicals in the spinning solution during fibre manufacturing
- the development of modified fibres with inherent flame-retardant properties
- back-coating of finished textile-covered articles (e.g. furniture, mattresses), whereby a fire-resistant layer is attached to one side of the finished textile.

2.9.2.5 Antistatic treatments

The process consists in treating the fabric with hygroscopic substances (antistatic agents) which increase the electrical conductivity of the fibre, thus avoiding the accumulation of electrostatic charge.

These finishing treatments are very common for synthetic fibres, but they are also applied to wool in the carpet sector for floorcoverings that have to be used in static-sensitive environments.

The substances commonly used as antistatic agents are described in Section 8.8.3.

2.9.2.6 Mothproofing treatments

The mothproofing of wool and wool-blends is mainly restricted to the production of textile floorcoverings, but some high-risk apparel is also treated (for example military uniforms). For apparel application, mothproofing is usually carried out in dyeing. Floorcoverings may be mothproofed at different stages of the production processes, such as during raw wool scouring, spinning, yarn scouring, dyeing, finishing or later in the backing line.

The biocides used in the mothproofing treatments are described in Section 8.8.2.

2.9.2.7 Bactericidal and fungicidal treatments

These finishes may be applied to chemicals (to preserve auxiliaries and dye formulations) and to apparel, for example in odour suppressant for socks and for the treatment of floorcoverings for the healthcare sector and to provide anti dust-mite finishes. Close analysis shows that more and more textile products (clothing and underwear) are being treated with anti-microbial agents.

The products used are biocides: they are mentioned in Section 8.8.2.

2.9.2.8 Anti-felt treatments

Anti-felt finishing is applied in order to provide anti-felt properties to the good. This will prevent shrinking of the finished product when it is repetitively washed in a laundry machine.

Two treatments, which are also complementary, are applied:

- oxidising treatment (subtractive treatment)
- treatment with resins (additive treatment).

These treatments can be applied at any stage of the process and on all different make-ups. They are most commonly applied on combed tops for specific end-products (e.g. underwear).

Oxidising treatments

In the oxidising treatment the specific chemicals used attack the scales of the cuticles and chemically change the external structure of the fibre.

This treatment has traditionally been carried out using one of the following chlorine-releasing agents:

- sodium hypochlorite
- sodium salt dichloroisocyanurate
- active chlorine (no longer used).

The oldest process is the one using sodium hypochlorite. However, since the development of active chlorine is difficult to control, wool fibre characteristics can be deeply changed, also giving irregular results. Dichloroisocyanurate is more advantageous here because it has the ability to release chlorine gradually, thereby reducing the risk of fibre damage.

The process with dichloroisocyanurate (Basolan process licensed by BASF) consists in impregnating the material in a bath (35°C) containing the oxidant, sodium sulphate and an auxiliary (surfactant). After 20 - 30 min the material is rinsed, then it is submitted to an anti-chlorine treatment with 2 – 3 % of sodium bisulphite and rinsed again.

All these chlorine-based agents have recently encountered restrictions because they react with components and impurities (soluble or converted into soluble substances) in the wool, to form absorbable organic chlorine compounds (AOX).

Alternative oxidising treatments have therefore been developed. In particular, peroxysulphate, permanganate, enzymes and corona discharge come into consideration. However, the only alternative to chlorine-based agents readily available today is peroxysulphate.

The process with peroxysulphate compounds is quite similar to the chlorine treatment, but does not involve the use of chlorine and does not generate chloroamines. The material is treated with the oxidising agent in acid liquor at room temperature until the active oxygen has been largely consumed.

Both with chlorine-based agents and peroxysulphate, sodium sulphite is then added as an anti-oxidant to the same liquor at slightly alkaline pH. This is a reductive aftertreatment to avoid damage and yellowing of the wool fibre at alkaline pH.

The goods are subsequently rinsed. If necessary, they are treated with a polymer (see treatments with resins below).

Treatments with resins (additive processes)

In additive processes, polymers are applied to the surface of the fibre with the aim of covering the scales with a "film". However, this treatment must be regarded as a pseudo felt-free finishing process, as it is not the felting propensity that is reduced, but merely the effect thereof.

The polymer must have a high substantivity for wool. Cationic polymers are the most suitable for this treatment because, after the previous oxidative and reductive pretreatment, the wool surface becomes anionic.

The polymer may be, in some case, sufficiently effective on its own to make pretreatment unnecessary. However, the combination of subtractive and additive processes has the greatest technical effect.

Combined treatments: Hercosett process

The oldest combination process is the so called Hercosett process (by C.S.I.R.O), which consists in chlorine pretreatment followed by application of a polyamide-epichloridrine resin.

Whilst the Hercosett process can be carried out in batch or continuous mode, the latter is predominant nowadays.

The continuous process consists of the following steps (see Figure 2.27):

1. chlorine treatment in acid medium (using chlorine gas or sodium hypochlorite)
2. reduction of chlorine using sulphite in the same bath
3. rinsing
4. neutralisation with sodium carbonate
5. rinsing
6. resin application
7. softener application
8. drying and polymerisation.

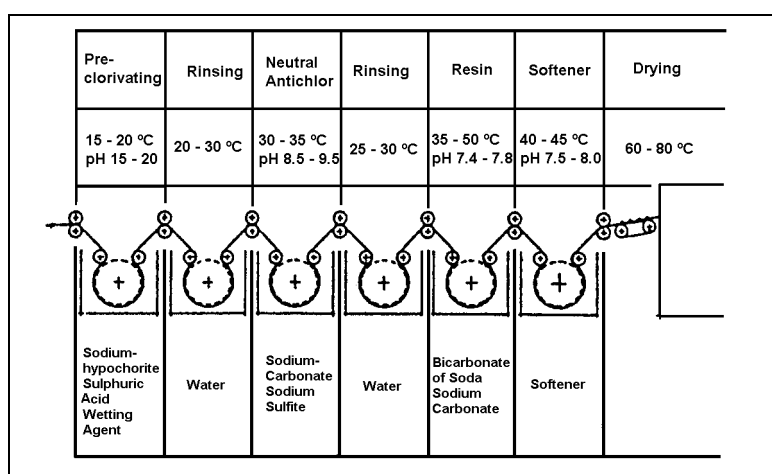


Figure 2.27: Schematic representation of the Hercosett process
[7, UBA, 1994]

The Hercosett process has been widely used for years as anti-felt finishing of wool in different states (loose fibre, combed top, yarn, knitted and woven fabric) due to its low cost and high quality effects. However, the effluent shows high concentrations of COD and AOX. The formation of AOX is attributable not only to the oxidant, but also to the resin. In fact, the typical resin applied in the Hercosett process is a cationic polyamide whose manufacturing process involves the use of epichloridrine, which is another source of the chlorinated hydrocarbons in the effluent.

Alternative resins have been developed, based on polyethers, cationic aminopolysiloxanes, synergic mixtures of polyurethanes and polydimethylsiloxanes, but they all have some limitations concerning their applicability.

New processes have also been developed, but so far the results achieved with the Hercosett process cannot be fully matched by any alternative, which is why it is still the preferred process particularly for treatments such as the anti-felt finishing of combed tops.

2.9.3 Environmental issues

Among textile finishing processes, the chemical ones are those that are more significant from the point of view of the emissions generated. As in dyeing, the emissions are quite different between continuous and discontinuous processes. Therefore this distinction will be used in the

discussion of the main environmental issues associated with finishing. Anti-felt treatments represent a peculiar type of finishing both in terms of applied techniques and emissions. The environmental issues related to this process are therefore discussed in Section 2.9.2.8 together with the description of the process itself.

Environmental issues associated with continuous finishing processes

With some exceptions (e.g. application of phosphor-organic flame-retardant), continuous finishing processes do not require washing operations after curing. This means that the possible emissions of water pollution relevance are restricted to the system losses and to the water used to clean all the equipment. In a conventional foulard, potential system losses at the end of each batch are:

- the residual liquor in the chassis
- the residual liquor in the pipes
- the leftovers in the batch storage container from which the finishing formulation is fed to the chassis.

Normally these losses are in the range of 1–5 %, based on the total amount of liquor consumed; it is also in the finisher's interest not to pour away expensive auxiliaries. However, in some cases, within small commission finishers, losses up to 35 or even 50 % may be observed. This depends on the application system (e.g. size of foulard chassis) and the size of the lots to be finished. In this respect, with application techniques such as spraying, foam and slop-padding (to a lower extent due to high residues in the system) system-losses are much lower in terms of volume (although more concentrated in terms of active substance).

Residues of concentrated liquors are re-used, if the finishing auxiliaries applied show sufficient stability, or otherwise disposed of separately as waste destined to incineration. However, too often these liquors are drained and mixed with other effluents.

Although the volumes involved are quite small when compared with the overall waste water volume produced by a textile mill, the concentration levels are very high, with active substances contents in the range of 5–25 % and COD of 10 to 200 g/litre. In the case of commission finishing mills working mainly on short batches, the system losses can make up a considerable amount of the overall organic load. In addition, many substances are difficult to biodegrade or are not biodegradable at all and sometimes they are also toxic (e.g. biocides have a very low COD, but are highly toxic).

The range of pollutants that can be found in the waste water varies widely depending on the type of finish applied. The typical pollutants and the environmental concerns associated with the use of the most common finishing agents are discussed in Section 8.8. In particular, the release of the following substances in the environment gives rise to significant concerns:

- ethylene urea and melamine derivatives in their “not cross-linked form” (cross-linking agents in easy-care finishes)
- organo-phosphorous and polybrominated organic compounds (flame retardant agents)
- polysiloxanes and derivatives (softening agents)
- alkyphosphates and alkyletherphosphates (antistatic agents)
- fluorochemical repellents.

In the drying and curing operation air emissions are produced due to the volatility of the active substances themselves as well as that of their constituents (e.g. monomers, oligomers, impurities and decomposition by-products). Furthermore air emissions (sometimes accompanied by odours) are associated with the residues of preparations and fabric carry-over from upstream processes (for example, polychlorinated dioxins/furans may arise from the thermal treatment of textiles that have been previously treated with chlorinated carriers or perchloroethylene).

The emission loads depend on the drying or curing temperature, the quantity of volatile substances in the finishing liquor, the substrate and the potential reagents in the formulation. The range of pollutants is very wide and depends on the active substances present in the formulation and again on the curing and drying parameters. In most cases, however, the emissions produced by the single components of the finishing recipes are additive. As a result, the total amount of organic emissions in the exhaust air (total organic carbon and specific problematic compounds such as carcinogenic and toxic substances) can easily be calculated by means of emission factors given for the finishing recipes by manufacturers (see also Section 4.3.2). Note however, that Germany is the only Member State where there is a fully developed system in which the manufacturers provide the finisher with such information on the products supplied.

Another important factor to consider regarding air emissions is that the directly heated (methane, propane, butane) stenters themselves may produce relevant emissions (non-combusted organic compounds, CO, NO_x, formaldehyde). Emissions, for example, of formaldehyde up to 300 g/h (2 - 60 mg/m³) have been observed in some cases, which were attributable to inefficient combustion of the gas in the stenter frame [179, UBA, 2001]. It is therefore obvious – when speaking about air emissions – that the environmental benefit obtained with the use of formaldehyde-free finishing recipes is totally lost if the burners in the stenter frames are poorly adjusted and produce high formaldehyde emissions.

The active substances in the most common finishing agents and the possible associated air emissions are discussed in Section 8.8. Moreover a more comprehensive list of pollutants that can be found in the exhaust air from heat treatments in general, is reported in Section 12.

Environmental issues associated with discontinuous processes

The application of functional finishes in long liquor by means of batch processes is used mainly in yarn finishing and in the wool carpet yarn industry in particular. Since the functional finishes are generally applied either in the dye baths or in the rinsing baths after dyeing, this operation does not entail additional water consumption with respect to dyeing. For the resulting water emissions, as with batch dyeing, the efficiency of the transfer of the active substance from the liquor to the fibre is the key factor which influences the emission loads. The efficiency depends on the liquor ratio and on many other parameters such as pH, temperature and the type of emulsion (micro- or macro-emulsion). Maximising the efficiency is particularly important when biocides are applied in mothproofing finishing. As mothproofing agents are not water-soluble they are applied from emulsions. The degree of emulsification and the pH are critical in the application of mothproofing agents (i.e. the efficiency of the process is higher when the active substance is applied from micro-emulsions and at acidic pH). Note here that the finishing agents are dosed based on the weight of the fibre and not on the amount of bath (in g/litre).

The pollutants that may be encountered in waste water vary depending on the finishing agents applied; Section 8.8 gives more details. The main issues worth mentioning are the application of mothproofing agents (emissions of biocides) and the low level of exhaustion of softeners (emissions of poorly biodegradable substances).

2.10 Coating and laminating

2.10.1 Coating and laminating processes

Usually, coated and laminated textiles consist of a textile substrate - typically a woven, knitted, or non-woven textile fabric - combined with a thin, flexible film of natural or synthetic polymeric substances.

A coated fabric usually consists of a textile substrate on which the polymer is applied directly as a viscous liquid. The thickness of the film is controlled by applying it via a blade or similar aperture.

A laminated fabric usually consists of one or more textile substrates, which are combined with a pre-prepared polymer film or membrane by adhesives or heat and pressure.

The basic techniques for coating/laminating fabrics require the following conditions:

- the fabric to be coated/laminated is supplied full width on a roll
- the fabric is fed under careful tension control to a coating or laminating heat zone
- after application of the coating auxiliaries, the fabric is passed through an oven to cure the composite and remove volatile solvents before cooling and rolling up.

In the textile industry the flame lamination of foams is a widely used technique: a pre-prepared thin, thermoplastic foam sheet is exposed to a wide slot flame burner located before the laminating rolls. No drying or curing oven is required in this process. Air emissions produced during this treatment are highly irritant and may trigger allergic reaction in susceptible persons.

The typical coating compounds and auxiliaries used are described in Section 8.9

2.10.2 Environmental issues

The main environmental concerns in coating/laminating operations relate to air emissions arising from solvents, additives and by-products contained in the formulations of the coating compounds. A distinction must therefore be made between the various products available (the following information is taken from [179, UBA, 2001]).

Coating powders

The emission potential of coating powders is in most cases negligible with the exception of polyamide 6 and its copolymers (the residual monomer epsilon-caprolactam is released at standard process temperatures). In some cases softeners (often phthalates) can be found in the emissions.

Coating pastes

The emissions from the coating pastes result mainly from the additives (except in the case of PA 6, which is mentioned above). These are mainly:

- fatty alcohols, fatty acids, fatty amines from surfactants
- glycols from emulsifiers
- alkylphenoles from dispersants
- glycol, aliphatic hydrocarbons, N-methylpyrrolidone from hydrotropic agents
- aliphatic hydrocarbons, fatty acids/salts, ammonia from foaming agents
- phthalates, sulphonamides/esters ex softeners/plasticisers
- acrylic acid, acrylates, ammonia, aliphatic hydrocarbons from thickeners

Polymer dispersions (aqueous formulations)

The emission potential of polymer dispersions is quite low compared to coating pastes. Components that are responsible for air emissions are the dispersing agents, residual compounds from the polymerisation (especially t-butanol used as catalyst in radically initialised polymerisation reactions) and monomers arising from incomplete reaction during polymerisation. The latter are particularly relevant to the workplace atmosphere and odour nuisances. They include:

- acrylates as acrylic acid, butylacrylate, ethylacrylate, methylacrylate, ethylhexylacrylate and vinylacetate
- carcinogenic monomers like acrylonitrile, vinylchloride, acrylamide, 1,3-butadiene and vinylcyclohexene.

Vinylcyclohexene is not often identified in the exhaust air. However it is always formed (2 + 2 cycloaddition-product) if 1,3-butadiene is used.

Acrylamide in the exhaust air is often related to formaldehyde emissions (reaction products of methylolacrylamide).

Melamine resins

Melamine resins are widely applied. Melamine resins are produced by the reaction of melamine and formaldehyde and subsequent etherification mostly with methanol in aqueous medium. The products can contain considerable amounts of free formaldehyde and methanol. During their application the cross-linking reaction of the resin with itself or with the fabric (e.g. cotton) is initiated by an acid catalyst and/or temperature, releasing stoichiometric amounts of methanol and formaldehyde.

Polymer dispersions (organic solvent-based formulations)

Solvent coating is not very common in the textile finishing industry. When this technique is applied, exhaust air cleaning equipment based on thermal incineration or adsorption on active carbon is normally installed.

2.11 Carpet back-coating

The backing process is an important production step which is applied to improve the stability of textile floor-coverings. Moreover, backing may have a positive influence on properties such as sound-proofing, stepping elasticity and heat insulation.

One can distinguish the following types of coatings:

- pre-coating
- foam coating
- textile back-coating
- heavy coating
- reinforcement
- back finish.

Pre-coating

A common feature of tufted carpets is that they are pre-coated after tufting to permanently anchor the needled pile loops in the carrier layer (Figure 2.28). The pre-coating material used consists of:

- x-SBR latex, which is a dispersion containing a copolymer produced from styrene, butadiene and carbonic acid
- fillers
- water
- additives (e.g. thickeners, anti-foam, foam-stabilisers, etc.).

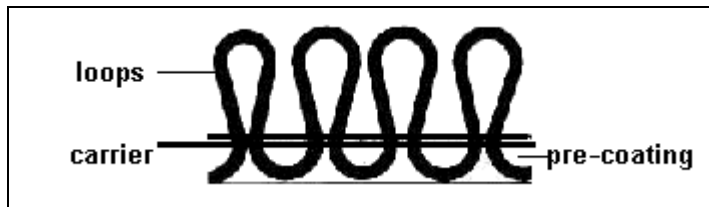


Figure 2.28: Pre-coated tufted carpet
[63, GuT/ ECA, 2000]

The pre-coating can be applied:

- unfoamed, by means of slop-padding (Figure 2.29)
- foamed, by means of the doctor-blade technique (Figure 2.30).

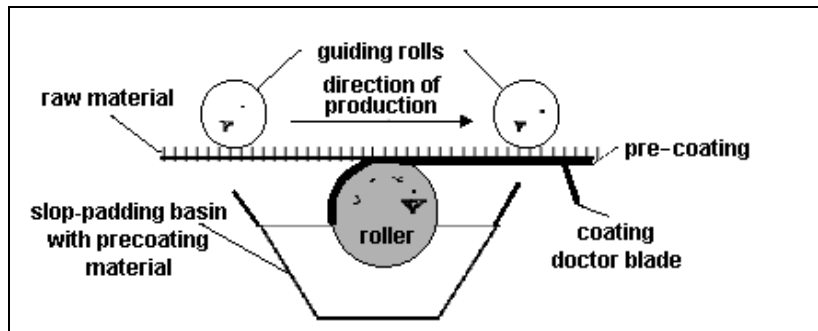


Figure 2.29: Pre-coating application by slop-padding
[63, GuT/ ECA, 2000]

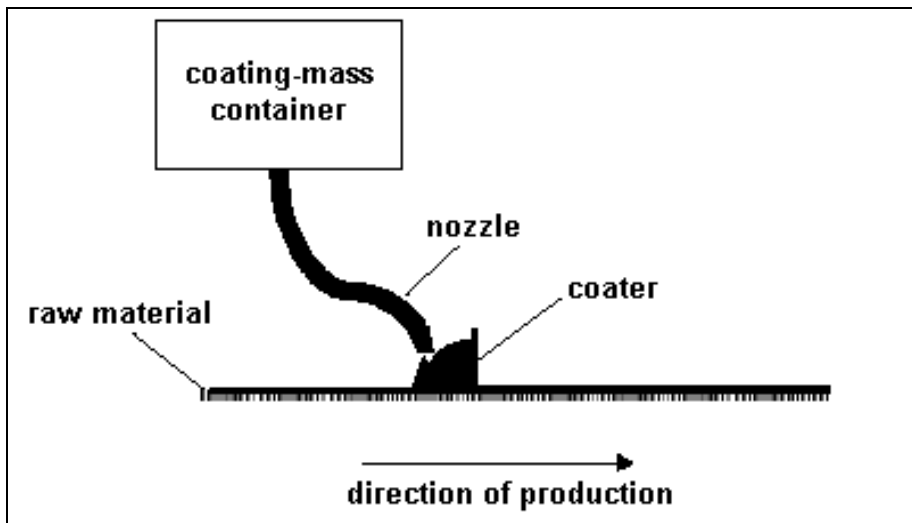


Figure 2.30: Pre-coating application by doctor-blade technique
[63, GuT/ ECA, 2000]

During the subsequent drying stage, thanks to the formation of hydrogen bonds, the polymer chains are netted into a three-dimensional web and an elastic plastic layer is produced.

SBR foam coating

Foam coating methods consist in the application of a foam layer onto a pre-coated carpet, as the following figure shows.

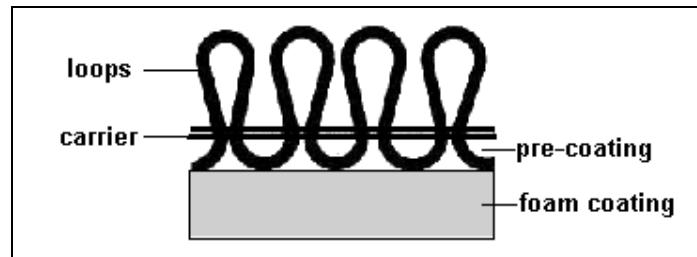


Figure 2.31: Foam-coated tufted carpet

The foam finish is carried out in two steps: foam application and foam solidification through drying. The lattice is foamed with air and then applied by means of a doctor-blade onto the pre-coated carpet.

The SBR foam must be stabilised until it is solidified in the vulcanisation oven. For this stabilisation, two methods are used:

- the non-gel process, which uses surfactants as foam stabilisers
- the gel process, which uses ammonium acetate (AA gel system) or silicium fluoride (SF gel system) as gelling agents.

The overall process is schematised in Figure 2.32.

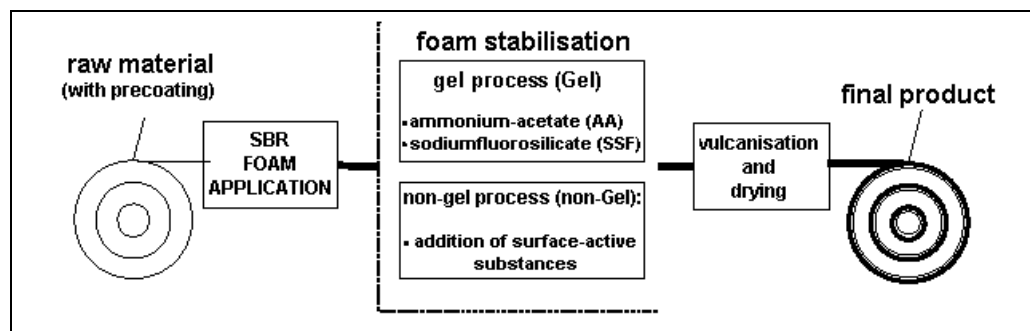


Figure 2.32: Representation of the SBR foam coating process [63, GuT/ ECA, 2000]

The foam is composed of:

- the SBR colloidal dispersion
- a paste, which contains a number of active additives
- inactive fillers (mainly chalk, which is added to the ready-compounded paste)
- water
- thickeners (e.g. polyvinyl alcohol, methyl cellulose, polyacrylates)
- colourants and pigments
- anti-oxidants and ozone stabilisers.

Some of the active components of the paste are responsible for the environmental impact of this coating method. In order to identify better the emission sources they can be divided as follows:

Polymerisation additives:

	Remarks
- Foam stabilisers	
- Cross-linkers	Usually sulphur, but also peroxides
- Vulcanisation accelerators	- Mercaptobenzothiazoles (e.g. zinc mercaptobenzothiazole) - Dithiocarbamates, such as zinc diethyldithiocarbamate or zinc dibenzylthiocarbamate or zinc dibutyldithiocarbamate (the most commonly used one)
- Activators	Usually combination of ZnO and stearic acid (one source reports that ZnO is not necessary for non-gel and some SF applications [281, Belgium, 2002])

Processing additives:

	Remarks
- Foaming agents and stabilisers	Surfactants
- Gelling agent	e.g. Ammonium acetate (AA gel system) or silicium fluoride (SF gel system)
- Hydrophobic substances in order to improve the foam surface and the water-repellent properties	Paraffin dispersions and silicon emulsions
- Complexing agents, to chelate metal ions (they behave as catalysts for ageing the foam layer)	e.g. EDTA, DTPA, polyphosphates
- Antioxidants	
- Thickeners	Organic polymers based on polyacrylates and cellulose (e.g. CMC)

Functional additives:

- UV stabilisers
- antistatic agents
- flame retarding agents (e.g. Al₂O₃).

PU foam coating

Polyurethane is another method for foam coating. The ICI polyurethane coating process is the most commonly applied. The carpet is prepared by steaming and then reaches the spray chamber where the components of the polyurethane (diisocyanate and an alcohol) are sprayed. The CO₂ produced during the chemical reaction is embedded into the foam. The coating is reinforced in an infrared heating field and in a subsequent reaction field. The process is schematically represented in the following diagram.

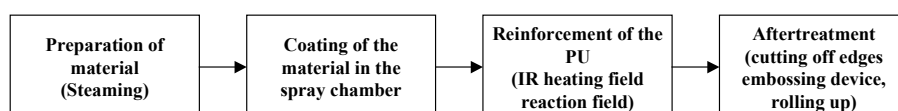


Figure 2.33: PU foam coating
[63, GuT/ ECA, 2000]

Textile back coating

Textile backing consists in the application of a textile fabric onto the pre-coated carpet. The connection between the carpet and the textile fabric is obtained through the application of a layer of:

- laminating glue
- melting glue.

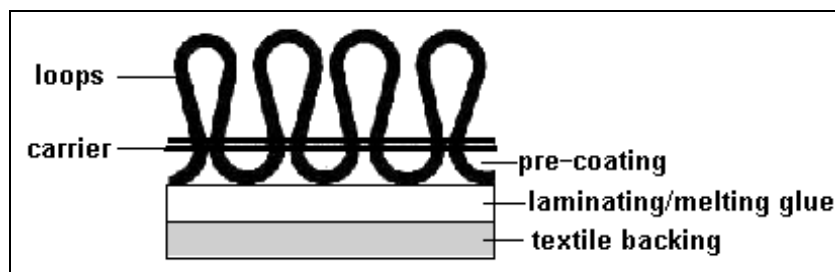


Figure 2.34: Textile backing
[63, GuT/ ECA, 2000]

Laminating glue

In this process an x-SBR latex is applied to the carpet by sloop-padding. After the application of the textile fabric, the final reinforcement of the latex is carried out by means of heat treatment (Figure 2.35). The latex composition is similar to that used for pre-coating, with a higher share of polymer dispersion in order to allow a higher adhesive power.

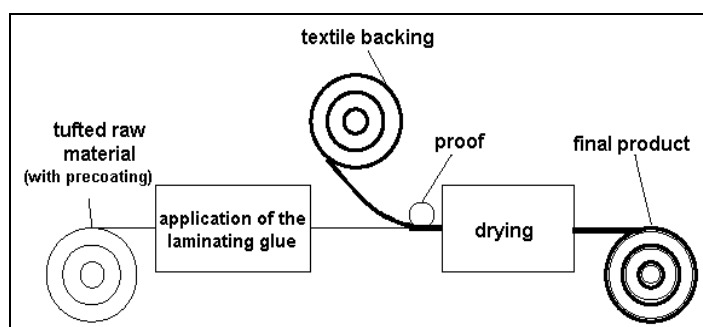


Figure 2.35: Textile backing by means of the laminating glue process
[63, GuT/ ECA, 2000]

Melting glue

This system uses thermoplastic polymers (mainly polyethylene) which are meltable by means of heat. In powder lamination (and in particular in powder scattering lamination) polyethylene powder is evenly sprinkled onto the back of the carpet. Subsequently the polymer is melted in an infrared field. In the next stage the fabric is pressed into the melting glue. Through subsequent cooling, the melting glue becomes permanently connected between the textile fabric and the bottom side of the carpet. The process is represented in Figure 2.36.

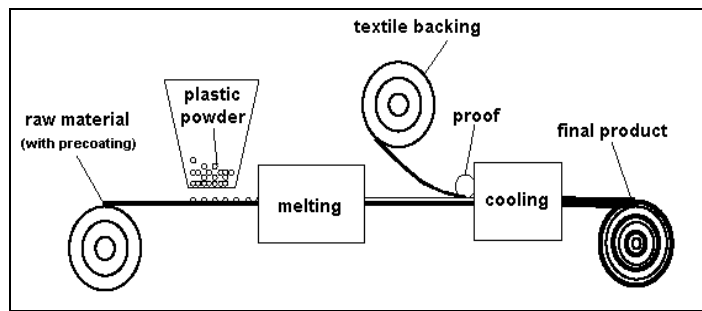


Figure 2.36: Textile backing by means of the powder lamination (melting glue)
[63, GuT/ ECA, 2000]

Another textile backing process by means of melting glue is the so-called AdBac process. In this case the carpet is constructed using a primary cloth (carrier layer) with low melting point additives. In the next stage the secondary cloth (also with a low melting point) is brought into contact with the back of the carpet before this enters the heating zone. The higher temperature melts the cloths, which are then forced together by nip rolls at the exit of the heating zone. The carpet is then cooled. A scheme of a carpet produced with the AdBac process is reported in Figure 2.37.

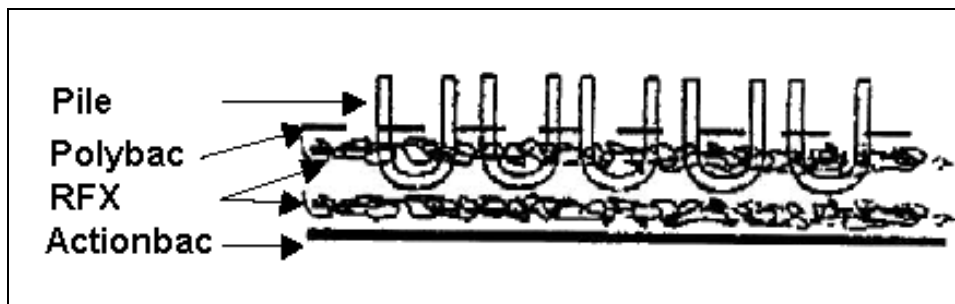


Figure 2.37: Carpet manufactured with the AdBac process
[63, GuT/ ECA, 2000]

Heavy coating

Heavy coating is mainly used for the coating of self-lying (SL) tiles. The coating process consists in the application of the coating material by means of sloop-padding or doctor blade and subsequent reinforcement. In most cases the coating material is applied into layers (two-coat technique). After the first layer, which may also serve as a pre-coating layer, a glass-fibre web may be added. The second coating application follows. The following coating materials are used:

- APO (abbreviation for “atactical polyolefin”)
- bitumen (enriched with inorganic and organic additives)
- PVC (polyvinylchloride)
- EVA (ethylen vinyl acetate).

The process principle is schematised in Figure 2.38.

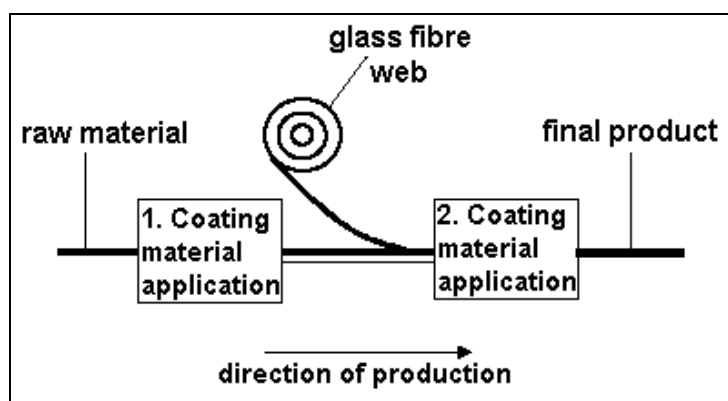


Figure 2.38: Representation of the heavy coating process
[63, GuT/ ECA, 2000]

2.12 Washing

2.12.1 Washing with water

Important factors in washing are:

- water characteristics
- choice of soaps and detergents
- hydromechanical action
- temperature and pH
- rinsing stage.

Washing is normally carried out in hot water (40 – 100 °C) in the presence of wetting agent and detergent. The detergent emulsifies the mineral oils and disperses the undissolved pigments. The choice of the surfactants may vary also depending on the type of fibre. Mixtures of anionic and non-ionic surfactants are commonly used. An important factor in the selection of a surfactant is its effectiveness in strong alkaline conditions.

Washing always involves a final rinsing step to remove the emulsified impurities.

Fabric washing can be carried out in rope form or open-width, and both in discontinuous or in continuous mode. The most commonly used technique is continuous mode in open-width.

2.12.2 Dry cleaning

Industrial solvent washing is sometimes necessary especially for delicate fabrics. In this case the impurities are carried away by the solvent, which is usually perchloroethylene. In the same step, softening treatments may also be carried out. In this case, water and surfactant-based chemicals are added to the solvent.

Solvent washing may be carried out continuously in full width (for woven or knitted fabric) or discontinuously with yarn or fabrics in rope form (generally for knitted fabric).

Solvent plants have a built-in solvent treatment and recovery system in which the solvent is purified by distillation and re-used for the next washing process. Residual sludge from distillation must be disposed of as hazardous waste in case of high concentration of solvent.

After distillation, the solvent must be cooled before re-use and thus high amounts of cooling water are required. This water is never contaminated by solvent and can therefore be re-used. In mills having both solvent and water washing facilities, warm water from the cooling plant may

be used for water washing treatments, allowing water and energy savings. In many cases, however, this water is not re-used and it is discharged together with the other effluents.

Both closed and open airflow circuits can be used for the removal of solvent from fabric.

In open circuit machines, when the washing cycle is over, large amounts of air are taken from the external environment, warmed up with a steam heat exchanger and introduced into the machine, thus obtaining the evaporation of the organic solvent. This process goes on until the solvent is almost completely eliminated from clean fabrics. Solvent-rich-air is then sent to a centralised activated charcoal filtering system. Filters require regular regeneration to ensure optimal cleaning performance. Most modern filters allow discharge into the atmosphere below $3 - 4 \text{ mg/m}^3$.

In closed circuit machines the volume of air used to carry out the drying process, instead of being filtered and released into the atmosphere, is internally treated. Such treatment consists in recovering the solvent by condensation using a chiller. When the solvent has been removed from air and recovered, solvent-poor-air is heated by a heat exchanger and then sent again inside the machine. Recovered solvent is sent to a centralised plant, where it is distilled and purified. Closed circuit machines do not require an active carbon filter.

Apart from the above-mentioned air emissions in open-circuit machines, possible emissions during washing operations may result from machine losses (which can be eliminated or reduced by hermetic sealing of the machinery) and from solvent attached to the dried fabric and ultimately released in the atmosphere. Most modern machines have a built-in control system which makes it impossible to open the machine hatch if the solvent concentration in the machine is greater than values established by national regulations.

Other potential sources of emissions are represented by the solvent contained in the residual sludges and active carbon filters.

Figure 2.39, Figure 2.40 and Figure 2.41 show the solvent and the air circuits in open loop and closed loop solvent washing machines (the solvent circuit is always closed)

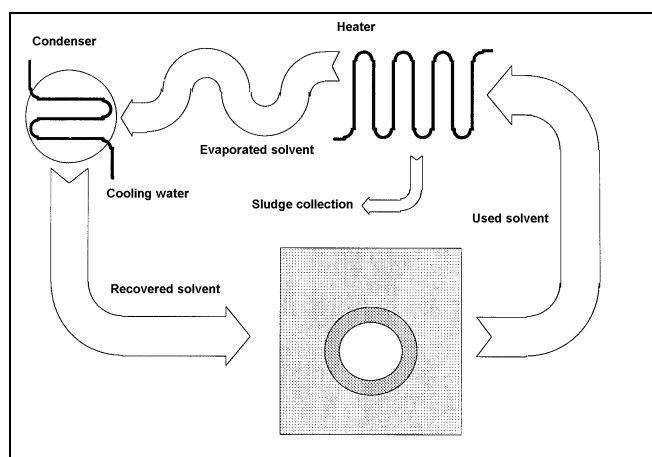


Figure 2.39: Solvent washing: representation of the solvent circuit
[66, CRIT, 1999]

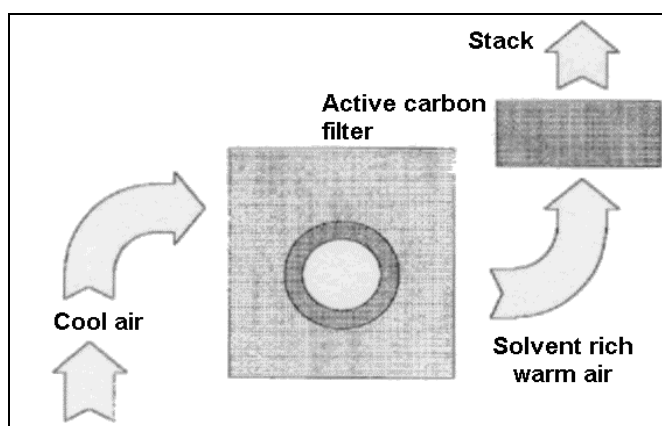


Figure 2.40: Solvent washing: representation of the air circuit in an open-loop washing machine [66, CRIT, 1999] revised by [318, Sperotto Rimar, 2002]

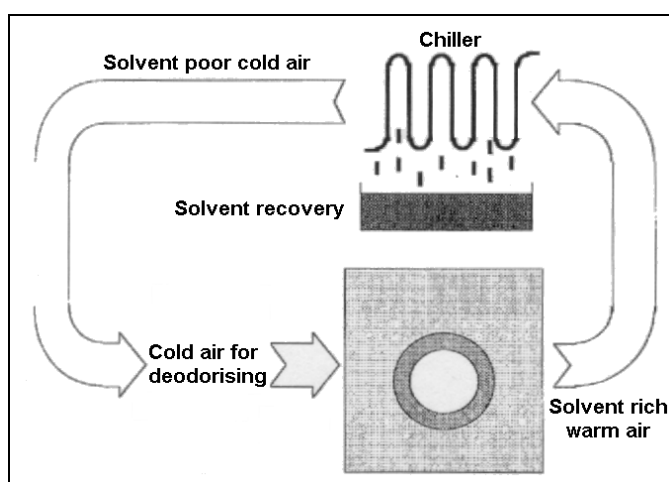


Figure 2.41: Solvent washing: representation of the air circuit in a closed-loop washing machine [66, CRIT, 1999] revised by [318, Sperotto Rimar, 2002]

2.13 Drying

Drying is necessary to eliminate or reduce the water content of the fibres, yarns and fabrics following wet processes. Drying, in particular by water evaporation, is a high-energy-consuming step (although overall consumption may be reduced if re-use/ recycling options are adopted).

Drying techniques may be classified as mechanical or thermal. Mechanical processes are used in general to remove the water which is mechanically bound to the fibre. This is aimed at improving the efficiency of the following step. Thermal processes consist in heating the water and converting it into steam. Heat can be transferred by means of:

- convection
- infrared radiation
- direct contact
- radio-frequency.

In general, drying is never carried out in a single machine, normally drying involves at least two different techniques.

2.13.1 Loose fibre drying

The water content of the fibre is initially reduced by either centrifugal extraction or by mangling before evaporative drying.

2.13.1.1 Centrifugal extraction

Textile centrifugal extractors (hydroextractors) are essentially a more robust version of the familiar domestic spin dryer, and normally operate on a batch principal, although machines capable of continuous operation may be used in very large installations.

When using conventional batch hydroextractors, fibre is unloaded from the dyeing machine into specially designed fabric bags which allow direct crane loading of the centrifuge. An extraction cycle of 3 - 5 minutes reduces residual moisture content to approximately 1.0 l/kg dry fibre (in the case of wool).

2.13.1.2 Mangling

Pneumatically loaded mangles may be used to reduce the water content of dyed loose fibre. Such equipment is often associated with a fibre opening hopper which is designed to break up the dyepack and present the fibre to a continuous dryer as an even mat. Mangling is invariably less efficient than centrifugal extraction.

2.13.1.3 Evaporative drying

All hot air evaporative dryers are of essentially similar design consisting of a number of chambers through which hot air is fan circulated. Consecutive chambers operate at different temperatures, fibre passing from the hottest into progressively cooler chambers. Fibre may be transported on a brattice or conveyer belt or may be carried through the machine on the surface of a series of "suction drums". High efficiency dryers with perforated steel conveyer belts have been developed which even out the air pressure drop across the fibre matt. This design results in more even drying and lower thermal energy requirements.

While the majority of dryers are steam heated, a number of manufactures supply radio frequency dryers. Fibre is conveyed on a perforated polypropylene belt through the radio frequency field and air flow is fan assisted. With these machines the fibre is not subjected to such high temperatures and the moisture content of the dried material can be controlled within fine limits.

Radio frequency dryers are reported to be significantly more energy efficient than steam heated chamber dryers. However, the higher efficiency is not always gained if a more global analysis is made, comparing the primary energy needed for production of electric power with methane gas consumed for thermal energy production. Radio frequency dryers are mainly used where the cost of electricity is low.

2.13.2 Hanks drying

2.13.2.1 Centrifugal extraction

Drained hanks from the dyeing machine can contain (in the case of wool) up to 0.75 kg water per kg of dry fibre (or higher depending on the hydrophilicity of the fibre). Moisture content is normally reduced by centrifugal extraction prior to evaporative drying using equipment identical to that described for loose fibre, above. Yarn is normally unloaded from the dyeing machine into fabric bags held in round carts to facilitate direct crane loading of the centrifuge. Hydroextraction reduces the moisture content to approximately 0.4 litres/kg dry weight.

2.13.2.2 Evaporative drying

Evaporative dryers consist of a number of heated chambers with fan assisted air circulation, through which the hanks pass suspended on hangers or poles or supported on a conveyer.

The hank sizes employed in carpet yarn processing require a slow passage through the dryer to ensure an even final moisture content, and a residence time of up to 4 hours is not uncommon. Air temperature is maintained below 120 °C to prevent yellowing (wool yellows above the boiling temperature).

All designs are capable of continuous operation. Thermal input is normally provided by a steam heated exchanger and many designs incorporate air-to-air heat exchangers on the dryer exhaust to recover heat.

Less commonly, hanks may be dried by employing a dehumidifying chamber. Moisture is recovered by condensation, using conventional dehumidification equipment. In comparison to evaporative dryers, yarn residence time tends to be longer, but energy consumption is lower.

2.13.3 Yarn packages drying

The moisture content of dyed packages is initially reduced by centrifugal extraction. Specially designed centrifuges, compatible with the design of the dyeing vessel and yarn carriers are employed.

Traditionally packages were oven dried, very long residence times being required to ensure adequate drying of the yarn on the inside of the package. Two methods are currently used, rapid (forced) air drying and radio frequency drying, the latter sometimes being combined with initial vacuum extraction. Forced air dryers generally operate by circulating hot air from the inside of the package to the outside at a temperature of 100 °C, followed by conditioning, in which remaining residual moisture is redistributed in a stream of air passing from the outside to the inside of the package. Radio frequency dryers operate on the conveyer principle and are perhaps more flexible than the types mentioned above. Lower temperatures can be used and energy efficiency is said to be high (comments made for evaporative drying of loose fibre apply in this case, too).

2.13.4 Fabric drying

The drying process for fabric usually involves two steps: the first one is aimed at removing water which is mechanically bound to fibres, while the second one is necessary to dry completely the fabric.

2.13.4.1 Hydro-extraction by squeezing

The fabric is squeezed by means of a padding machine through two or three rollers covered with rubber. This process cannot be applied to delicate fabric.

2.13.4.2 Hydro-extraction by suction

The fabric is transported flat over a "suction drum" which is linked to a pump. The external air is sucked through the fabric and thereby removes the excess water. The resulting residual humidity is still about 90 %.

2.13.4.3 Centrifugal hydro-extractor

The design of this machine is similar to the one described earlier for loose fibre and yarn hydro-extraction. With heavy fabric, an horizontal axis machine may be used.

This is the most efficient method for mechanical water removal, but it cannot be applied to delicate fabrics prone to form permanent creases.

2.13.4.4 Stenter

This machine is used for full drying of the fabric. The fabric is conveyed through the machine in open width. A hot current of air is blown across the fabric thereby producing evaporation of the water.

The fabric is sustained and moved by two parallel endless chains. The fabric is hooked undulating and not taut to allow its shrinking during drying.

Most common stenter designs are horizontal and multi-layer, but many new designs exist. In the horizontal stenter machine, the fabric enters wet from one side and exits dried from the other. In the multi-layer type it enters and exists from the same side. While in the first one the fabric moves horizontally without direction changes, in the second it is deviated many times, which makes this equipment unsuitable for delicate fabrics. On the other hand horizontal stenter frames occupy more space and are less efficient (in terms of energy consumption)

2.13.4.5 Hot-flue dryer

This machine is composed of a large metallic box in which many rolls deviate the fabric (in full width) so that it runs a long distance (about 250 m) inside the machine. The internal air is heated by means of heat exchangers and ventilated.

2.13.4.6 Contact dryer (heated cylinder)

In this type of machinery the fabric is dried by direct contact with a hot surface. The fabric is longitudinally stretched on the surface of a set of metallic cylinders. The cylinders are heated internally by means of steam or direct flame.

2.13.4.7 Conveyor fabric dryer

The fabric is transported within two blankets through a set of drying modules. Inside each module the fabric is dried by means of a hot air flow.

This equipment is normally used for combined finishing operations on knitted and woven fabrics when, along with drying, a shrinking effect is also required in order to give the fabric a soft hand and good dimensional stability.

2.13.4.8 Airo dryer

This machine can be used for washing, softening and drying operations on woven and knitted fabrics in rope form.

During the drying phase the fabric in rope form is re-circulated in the machine by means of a highly turbulent air flow. Water is thus partly mechanically extracted and partly evaporated.

Thanks to the particular design of this machine it is possible to carry out in the same machine wet treatments such as washing. In this case the bottom of the machine is filled up with water and the required chemicals and the fabric is continuously soaked and squeezed.

The capacity of this machine is determined by the number of channels (from 2 to 4).

2.14 Textiles industry categories

Up to this point, this chapter has described the fundamental unit processes in the textiles industry that are within the scope of this document. The information given has been structured by fibre type, which has made it possible to explain those issues that are determined by the physico-chemical behaviour of the fibre. From a practical point of view, however, a subdivision of the textile industry activities into sub-sectors based on the type of the fibre offers little practical aid.

In practice, there are established patterns of activity, with finishing mills tending to concentrate on particular kinds of make-up or end-product (e.g. yarn, woven fabric, carpet, etc.), because this is defined by the specialist machinery used. This degree of specialisation does not apply to the same extent to the fibre. Although in the past the predominance of natural fibres made possible the identification of separate sectors based on the fibre (mainly cotton and wool), nowadays the proliferation of man-made fibres means that finishers almost always process a wide variety of fibres, even if one type is dominant within a particular mill (e.g. wool, cotton, etc.).

As an aid to the application of this BREF, therefore, the rest of this chapter gives practical information on the main categories of mills that are actually found in this sector (integrated mills should be seen as a combination of these main categories).

The typical mill categories listed below also prepare the ground for the presentation of the emission and consumption levels in Chapter 3.

- Wool scouring mills
- Mills finishing yarn and/or floc
 - mainly CV, PES, PAC and/or CO floc material
 - mainly WO floc/tops/yarn
 - mainly CO yarn
 - mainly PES yarn
 - mainly WO, PAC and/or CV yarn
- Mills finishing knitted fabric
 - mainly CO
 - mainly CO with a significant proportion of printing
 - mainly synthetic fibres
 - mainly WO
- Mills finishing woven fabric
 - mainly CO and/or CV
 - mainly CO and/or CV with a significant proportion of printing
 - mainly WO
 - mainly PA
- Carpet industry
 - wool and wool-blend carpet yarn/ loose fibre dyehouses
 - piece carpet dyeing and printing mills
 - integrated carpet manufacturing companies.

The carpet industry is kept in a separate group from the other finishing mills. This is slightly inconsistent with the categorisation system adopted (based on the processing operations), in which a category of mills finishing yarn consisting mainly of wool is already identified in the list under the heading "Mills finishing yarn". However, the peculiarity of carpet as an end-

product involves such specific requirements that companies tend to specialise in the processing of products that are suitable only for the carpet sector.

2.14.1 Wool Scouring Mills

Wool processed in Europe is mostly imported. Most of the wool produced in Europe is in fact coarse wool which is suitable for the manufacturing of carpets, but not for use in apparel. Merino wool (fine wool) is therefore imported mainly from Australia, New Zealand, South Africa, Argentina, Uruguay and Brazil.

The organisation of the scouring sector reflects the two main systems used to process wool: the woollen and the worsted system. Scourers tend to specialise in one or the other. Woollen system scourers normally only scour the wool (sometimes they may blend it before dispatching it to the customer). Worsted system scourers usually scour, card and comb the wool thus producing a sliver of parallel fibres which is called top. Because of this difference, worsted system scourers are usually referred to as combers.

Within Europe, significant quantities of wool are also obtained from skins of slaughtered animals by a process called fellmongering in which the skins are treated chemically or biochemically to loosen the wool roots so that the wool can readily be separated from skins.

The scouring process is usually the only wet process carried out in scouring mills and it has already been described in detail in Section 2.3.1.1.

Most of the scourers have an on-site waste water treatment plant to treat their effluent. The majority discharge the treated effluent to sewer, but there are several scourers who discharge directly to surface waters. Those in the latter category have to treat their effluent to higher standards. Of the scourers who discharge to sewer, some treat only the heavily contaminated effluent from the scouring section and discharge the rinse water flowdown without treatment; others mix the two effluent streams before treatment.

Broadly speaking, there are four main types of effluent treatment process used by scourers:

- coagulation/flocculation;
- evaporation (sometimes combined with incineration with full closure of the water cycle);
- membrane filtration;
- anaerobic/aerobic biological treatment
- spreading to land or lagooning (after grease separation, in extensive wool producing areas).

Some scourers use combinations of the above processes. Neither the heavily contaminated effluent from the scouring section nor the mixed scouring and rinsing effluents can be treated directly by aerobic digestion, because their COD values are too high. It is normal to subject these effluent streams to anaerobic biological treatment or coagulation/flocculation before aerobic biological treatment (coagulation/ flocculation before aerobic treatment may result in huge amounts of sludge).

All of the effluent treatment processes employed by scourers produce a sludge or a concentrate which has to be disposed of safely. Sludge disposal routes used include landfill, composting, incineration, pyrolysis/gasification and brick manufacture.

2.14.2 Mills finishing yarn and/or floc

A common feature of floc and yarn finishing is that all process steps are normally carried out in the same equipment. The basic process sequence is:

- pretreatment (scouring/bleaching)
- dyeing
- finishing (mainly softening by addition of softening agents in the last rinsing bath, but also flame retardant or mothproofing treatments for carpet wool fibre).

Pretreatment can be carried out as a separate step, especially in the case of natural fibres, or together with dyeing by adding additional specific auxiliaries in the dye bath. The second option is common when the amount of impurities on the fibre is not significant and they are easy to remove, or when auxiliaries (e.g. preparation agents, spinning lubricants) are specially chosen not to interfere with the dyeing process.

Bleaching is normally not applied for synthetic fibres. With natural fibres, bleaching is commonly omitted for dark shades, whereas for light shades it is often combined with scouring. After washing, the material is dyed in the same machine and then submitted to final washing and rinsing.

For dyeing, it is common practice, in the case of floc and tops material, to achieve the desired final shade by thorough mixing of individual dyeings. With yarn, on the other hand, the required shade has to be achieved with only one dyeing since, unlike floc and tops, the shade cannot be corrected by compensation. For this reason, a higher standard of accuracy is required in the development of the dye recipe in the laboratory.

As explained in other parts of this document, the dyes and auxiliaries applied vary with the fibres processed.

Mercerising treatment may be desired for cotton. If so, the material is processed in hank form. Mercerisation is carried out in a separate machine and is normally the first treatment applied.

Anti-felt treatment is another optional operation; it is applied only on wool and mainly on tops.

2.14.3 Mills finishing knitted fabric

Mills finishing knitted fabric consisting mainly of CO

The typical process sequence for finishing knitted fabric consisting mainly of cotton is shown in Figure 2.42 (only the wet processes are reported). The dotted lines indicate processes that are not obligatory or are not common practice. Acidic demineralisation, for example, is applied only in a few mills. Mercerisation is also indicated with a dotted line because this additional treatment is only required for certain articles.

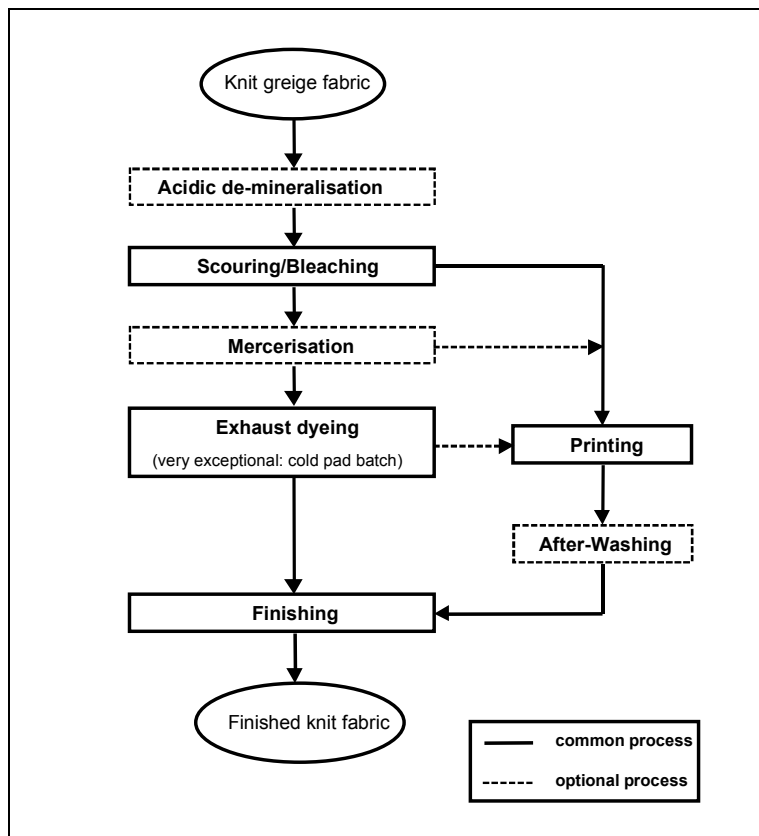


Figure 2.42: Typical process sequence for the finishing of knitted fabric mainly consisting of cotton [179, UBA, 2001]

Scouring is generally a batch operation, but large installations often do it in continuous mode. Hydrogen peroxide is the most commonly applied bleaching agent in cotton mills today.

Cotton knitted fabric can be dyed with different classes of dyestuffs such as reactive, direct, sulphur and vat dyestuffs. Reactive dyestuffs are the most commonly used. Direct dyestuffs may be used for lighter shades and sulphur dyestuffs for dark shades. Vat dyestuffs may be used for very high light fastness requirements.

In printing, two further subclasses can be identified:

- mills finishing cotton knitted fabric without a printing section and
- and mills finishing cotton knitted fabric with a printing section.

Pigment printing is widely applied for knitted fabric and does not need the after-washing step required when printing with reactive, disperse and vat dyes (also quite common techniques in this sector).

Mills finishing knitted fabric consisting mainly of synthetic fibres

The typical process sequence for finishing knitted fabric mainly consisting of man-made fibres is shown in Figure 2.43 (only the wet processes are indicated). Optional operations are indicated with dotted lines.

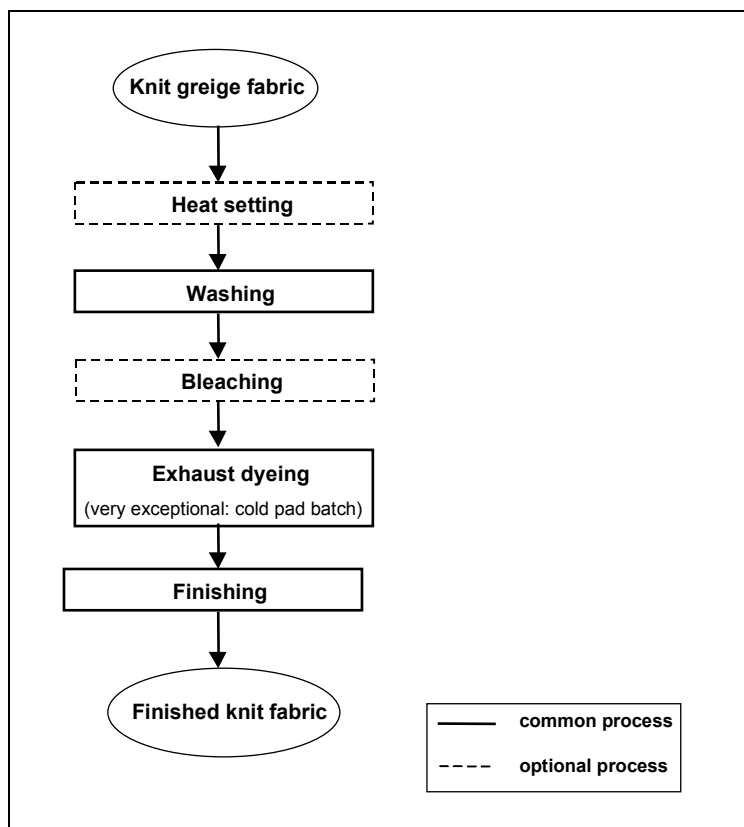


Figure 2.43: Typical process sequence for the finishing of knitted fabric consisting mainly of man-made fibres
 [179, UBA, 2001]

Before dyeing, the fabric is normally washed out in order to remove preparation agents and impurities. Heat-setting is not always needed, but when carried out this operation can take place either before washing (on the raw fabric) or after the washing step.

Depending on the required degree of white, bleaching may be needed.

Mills finishing knitted fabric consisting mainly of WO

The process sequence that is reported in Figure 2.45 is also applicable to this category of finishing mills.

2.14.4 Mills finishing woven fabric

Mills finishing woven fabric consisting mainly of CO and/or CV

The typical process sequence for the finishing of woven fabric consisting mainly of cotton is shown in Figure 2.44. Optional operations are indicated with dotted lines.

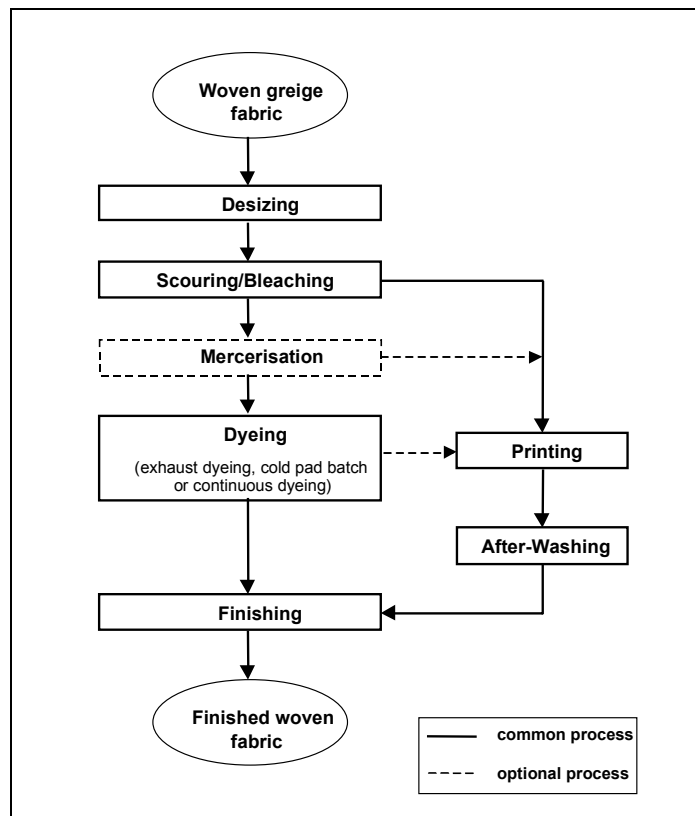


Figure 2.44: Typical process sequence for the finishing of woven fabric mainly consisting of cotton [179, UBA, 2001]

Woven fabric consisting mainly of cotton and cotton blends is finished on semi-continuous/continuous lines or in discontinuous mode mainly depending on the size of the lot.

Pretreatment operations such as desizing, scouring and bleaching are very often combined in one single step in continuous lines. Pretreatment of viscose usually requires alkali treatment and washing only, provided that the sizing agents are water-soluble, which is normally the case.

In addition to the processes mentioned in Figure 2.44, further treatments may be exceptionally applied, such as pretreatment with liquid ammonia (carried out at a very few sites in Europe only).

For printing, two further subclasses can be identified:

- mills finishing cotton woven fabric without a printing section
- and mills finishing cotton woven fabric with a printing section.

Mills finishing woven fabric consisting mainly of WO

The typical process sequence for the finishing of woven fabric consisting mainly of wool (woollen and worsted wool) is shown in Figure 2.45.

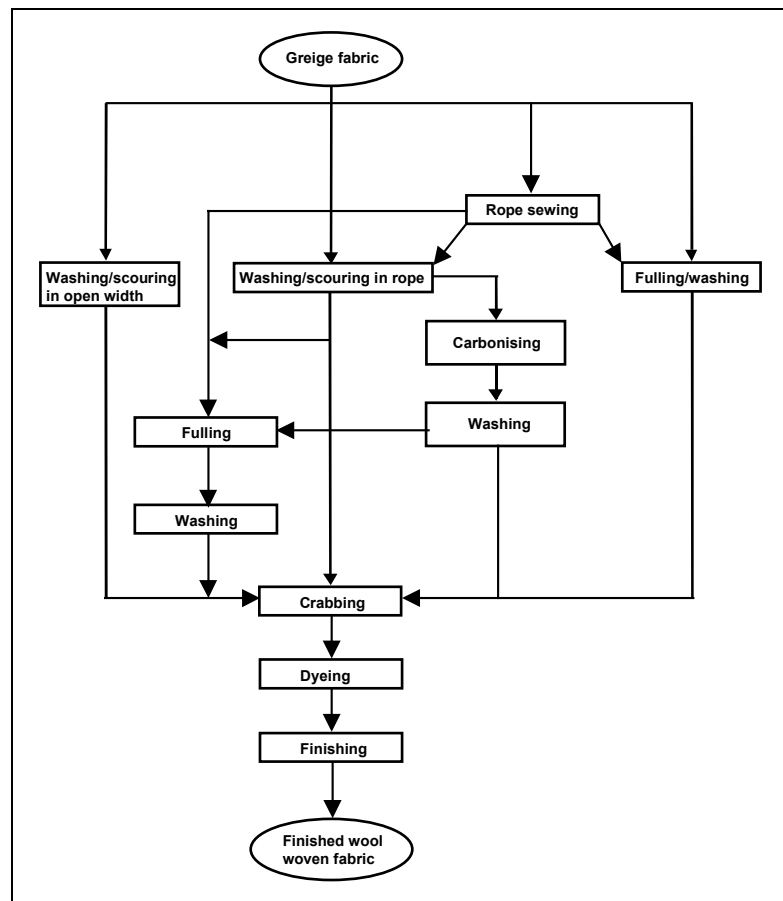


Figure 2.45: Typical process sequence for the finishing of woven fabric mainly consisting of wool [31, Italy, 2000]

Both water washing and solvent washing (dry cleaning) are common in the wool sector. Washing in an aqueous medium is carried out either in rope (in batch) or in open-width (mostly in continuous, but also in batch). Heavy fabrics (woollen wool) are preferably treated in rope form, whereas washing in open width is preferred for fine worsted fabric.

Carbonising and fulling are optional treatments in the basic process sequence. Carbonising is applied only on woollen wool fabric, which is also the most common application of fulling treatments.

Crabbing can be carried out before or after dyeing, depending on the desired effect. Crabbing on raw fabric is done in order to set the dimensions of the fabric, so that they will not change during use or during the subsequent processes.

Mills finishing woven fabric mainly consisting of synthetic fibres

The process sequence for the finishing of woven fabric consisting mainly of man-made fibres is similar to the one illustrated in Figure 2.43 for knitted fabric. However, here the washing/desizing step is more important because all sizing agents need to be removed. Synthetic sizing agents are normally used, which are easily removed with water, often in continuous washing machines.

In fabric with a certain percentage of elastane, silicones are also present. The complete removal of these substances can be very difficult. In some cases, tetrachloroethylene is applied; totally closed systems are mainly used for this purpose today, which severely limit losses of solvent.

Dyeing is carried out in continuous or in batch dyeing machines. The use of disperse dyes is dominant.

2.14.5 The Carpet industry

2.14.5.1 Wool and wool-blend carpet yarn dye-house

The production of spun dyed yarn can be regarded as a specific sector within the carpet manufacturing industry. Mills can be identified as dyehouses processing mainly wool and wool-blend fibres. Different treatments are carried out in order to convert white loose fibre into dyed carpet yarn. Wet processes essentially consist of dyeing and other ancillary operations carried out either in loose fibre or yarn form. Dry processes consist, in turn, in blending, carding, spinning, etc. These processes will not be considered here, since they have already been described in previous sections. Depending on when colouration takes place raw fibre flows through some or all of these processes. As can be seen from Figure 2.46, three basic process sequences are possible.

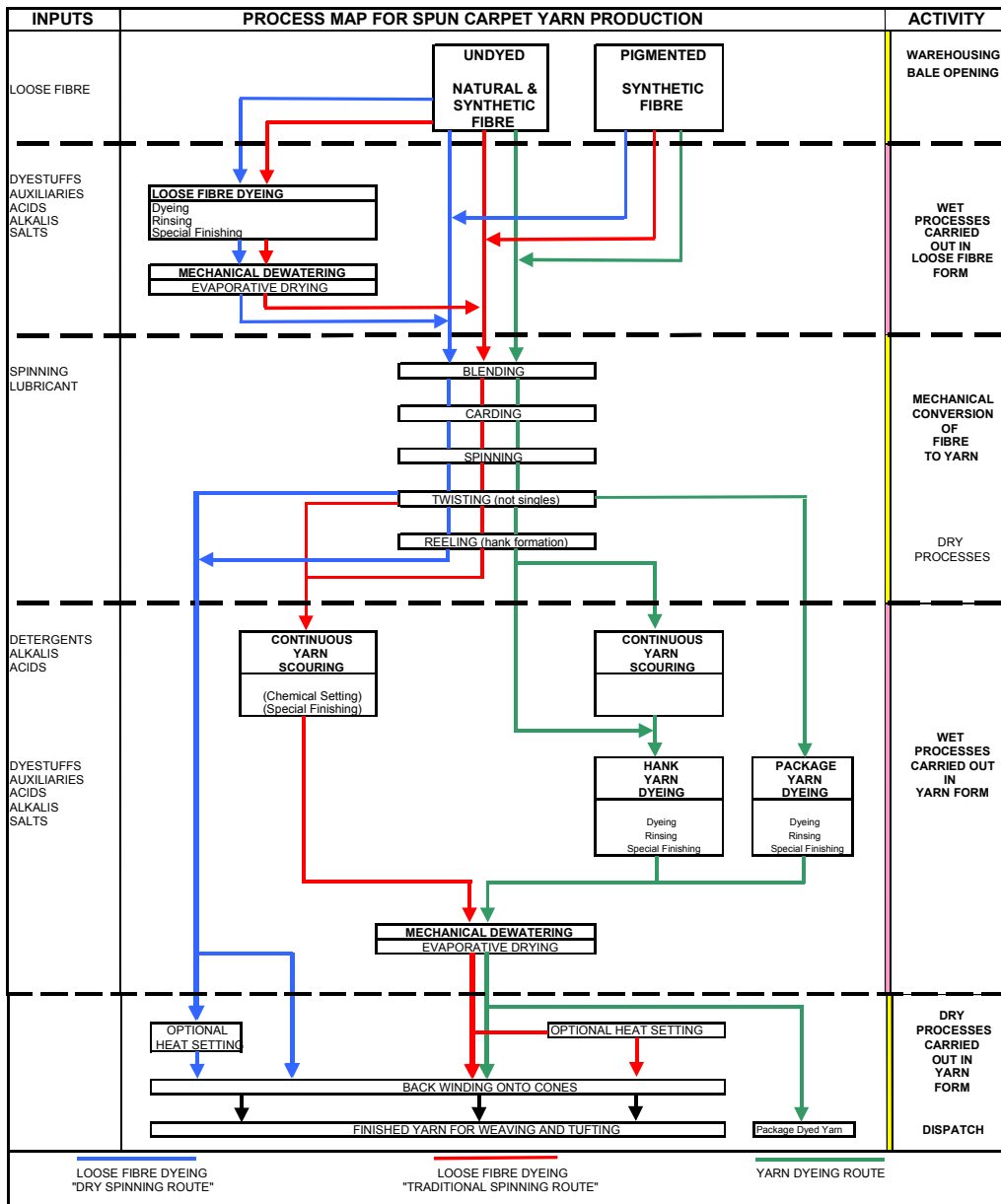


Figure 2.46: General process flow diagram for wool and wool-blend carpet yarn production [32, ENco, 2001]

The **dry spinning route**, so called because there is no wet processing after yarn formation, begins with colouration at the loose fibre stage. This is followed by yarn formation and finally twist setting. This process sequence is of relatively recent origin and requires the consistent use of wool with a low lanolin content and specialised spinning lubricants which can be left on the yarn without causing subsequent soiling of the carpet. The process is particularly useful in the production of yarn for large volume plain shade carpets and for effect yarns, obtained by blending together fibre dyed to different shades. While this production sequence is the most economical in terms of resource consumption, the selection of clean raw materials and the ongoing maintenance of the mill in a clean condition are essential.

The **traditional loose stock dyeing route** was originally used to produce large batches of yarn to the same shade for plain carpets. Loose fibre is first dyed and then converted to yarn using what is still sometimes referred to as the “oil spinning” process; this terminology arose from the practice of using spinning lubricants based on emulsions of mineral oil. Even small traces of residual mineral oil would lead to a marked propensity for the carpet to soil in service, and so yarns prepared by this route were thoroughly cleaned by scouring (washing) in hank form (see below). While the use of mineral oil-based lubricants has been largely replaced with water-soluble synthetic products, the practice of scouring the yarn is still judged to be essential by many processors in order to avoid potential claims arising from soiling. Unlike the dry spinning process, this route allows greater flexibility in the purchase of raw materials, so that wool with a higher lanolin content can be used.

In the **Yarn Dyeing Route**, clean fibre is first converted into yarn before dyeing. This process is particularly suitable for the production of the small coloured lots required for patterned carpet weaving or the bespoke trade, where white yarn can be held in stock and dyed as required to fill orders. The process is, however, by no means restricted to small batches, and dyeing machines with capacities of up to four tonnes are used to produce plain shades for both tufting and weaving.

In the case of integrated yarn manufacturers, it is common to find two or more of these process streams operating side by side and sharing common wet processing equipment. Since the dyeing and finishing techniques used apply equally to all three sequences, they are discussed in the following sections without further considering the different routes mentioned. Variants are described where they occur, and the relevance of any dry process segments is discussed where they have a significant impact on environmental performance or emissions.

2.14.5.1.1 Carpet loose fibre dye-house

Fibre is conventionally dyed in loose form (loose stock) when a large quantity of yarn is required to be of precisely the same shade, for example in a large solid shade (plain coloured) carpet where subtle variations in colour would be visible in service. Single colour batches may be made up of a number of individual dyeings, the dyer adjusting the dye addition to each dyeing in order to achieve the desired final shade of the yarn. Thorough mixing of the individual dyeings in a batch is achieved in a specific mechanical blending operation and during carding. Loose fibre dyeing, therefore, need not be as level as, for example, yarn dyeing, where there is no possibility of levelling the colour by further mechanical processing.

Dyed loose fibre is also used to achieve multicoloured effects in some yarns. In this process fibre dyed to different shades is blended together to produce a large range of designs, such as the “heather” styles in fashion at the present time. Such blends may contain dyed and undyed natural fibre and undyed and pigmented synthetic fibre.

Where the final yarn will contain a blend of wool and synthetic fibres (typically 80 % wool and 20 % polyamide) the required weights of the two components are normally dyed separately to optimise application conditions and dyestuff selection for each fibre type.

Loose-fibre dyeing processes

Scoured wool and new synthetic fibre are presented to the dye-house in a “clean” state and usually require no further treatment to remove contaminants before dyeing. If purchased from outside sources, fibrous raw materials normally arrive on site in the press-packed bales used universally by the textile industry to transport raw fibre.

Within an integrated manufacturing site, for example, one with its own wool scouring facilities, loose fibre may be transferred between the scouring department and blending department or loose fibre dyehouse by pneumatic conveyer or as individual low-density bales from intermediate warehousing.

Special opening machinery is not usually necessary when dealing with previously scoured wool and with new synthetic fibre. Bales are, therefore, often simply weighed and then brought into the dyehouse, opened at the side of the dyeing machine and the required quantity of (dry) fibre loaded manually into the dyeing vessel. Alternatively, fibre may be wet prior to packing in order to facilitate more even machine loading.

Various types of machines are used for dyeing wool and synthetic fibres in loose form. These include conical pan, pear shaped and radial flow machines (see Section 10). Loose fibre is typically packed into these machines manually.

Dyestuffs are dissolved in hot water before being added to the circulating bath. Typical dyestuffs and chemicals for wool and wool-blends are employed (see Sections 2.7.4 and 2.7.6).

In the majority of cases all chemical and dyestuff additions are made manually to the open dyeing machine. Less frequently, or if “pressure” dyeing machinery is being utilised (for synthetic fibres, because wool is normally dyed at atmospheric pressure), pre-dissolved chemicals and dye are introduced to the circulating dye bath from special addition tanks.

The dye bath is typically run for 10 - 15 minutes to ensure even penetration of the liquor through the fibre pack before commencing the heating cycle, raising the temperature of the dye liquor to 98 °C at a rate of 1 – 2 °C per minute. On reaching top temperature, dyeing may continue for up to 60 minutes, during which time the dye bath pH may be checked and adjusted by adding further acid to achieve maximum dye uptake. Progress of the dyeing is normally judged by eye and fibre samples are then removed for comparison with a standard.

A dyeing which is judged to be on shade will be terminated and the machine drained. A dyeing which is not of the required colour may have further additions of one or more dyestuffs, the dye bath being returned to the boil after each addition. Because of the blending operation which follows loose fibre dyeing, it is uncommon for there to be more than one shade addition unless the machine load is the only fibre in a batch.

Dyeing is followed by rinsing with cold water, to remove any surface-bound dyestuff and to cool the dyepack before manual unloading. The machine may be filled with cold water and then run for 10 - 15 minutes before draining. The use of “flood rinsing” in which the dye bath is allowed to refill and then run continuously to drain during the rinsing operation is now much less common due to increases in water charges and effluent disposal costs.

Liquor from both the dyeing and rinsing process may be recycled for further use. In this case the machine must be fitted with an external holding tank. The dye bath may be recycled if a number of dyeings of the same shade are being performed to make up a bigger dye lot. In this case the dye bath is pumped to the reserve tank and dropped back to the dyeing vessel when required for the next dyeing. There are, however, severe limitations to the use of this process because dye uptake is temperature-dependent and starting the dyeing at too high a temperature can result in an unacceptable rate of strike and unlevel application. The selection of dyestuffs and dyeing

conditions which promote maximum uptake of dye are required for the successful operation of this process.

In such circumstances it is more usual to recycle the rinse liquor, as the temperature of this liquor is lower and more compatible with dyeing start temperatures. Depending on the design of the machine a reserve tank may not be required for the operation of this process, as the fibre carrier can often be removed with the dyeing vessel full. Both these alternatives conserve water, and to a lesser degree, thermal energy (see also Section 4.6.22).

Application of functional finishes

A number of functional finishes may be applied to the loose fibre, either during the dyeing process itself or by application from an additional bath following dyeing/rinsing. This is particularly relevant in the “dry spinning” route where there will be no further wet processing after yarn formation. Finishes applied at the loose fibre stage include insect-resist treatments, antistatic treatments, anti-soiling treatments and treatments to counteract yarn/carpet colour change due to light exposure in service (see Section 8.8).

For expediency these finishes are combined with dyeing whenever possible, aftertreatments only being used when the chemistry of the two finishes is incompatible or if they require widely differing conditions of temperature and pH. Co-application with the dyes is simply accomplished by adding the product to the dye bath, usually with the dyeing auxiliaries.

Aftertreatments may require a fresh bath of clean water, or alternatively the rinse bath may be clean enough for re-use.

Specific techniques have been devised to minimise the concentration of mothproofing agents present in the spent liquors from loose fibre dyeing. The formulated commercial product is added at the beginning of the dyeing cycle and dyeing carried out as normal. At the end of the dyeing cycle the pH of the dye bath is lowered with the addition of formic acid and boiling is continued for a further 20 - 30 minutes. These strongly acidic conditions promote uptake of any active ingredient not adsorbed by the wool fibre under normal dyeing conditions and residual concentration can be reduced by up to 98 %.

Rinsing the fibre at moderate temperatures is known to cause desorption of mothproofers bound on or close to the surface of the wool fibre. Active ingredient concentrations in the spent rinse bath may consequently be significantly higher than those present in the dye bath. Techniques to minimise the impact of rinse desorption have been developed, in which the rinse bath is recycled, forming the next dye bath, thus eliminating all residues from the rinse liquor and reducing overall water consumption by 50 % (see Section 4.8.4 for further details).

Fibre in a drained carrier will contain up to 2 litres/kg of residual water (dry fibre weight). This is initially reduced by either centrifugal extraction or by mangling before evaporative drying in a hot air dryer.

2.14.5.1.2 Carpet yarn dye-house

On integrated sites the spun undyed yarn may be held in a bulk store as either hanks, wound onto cones or wound onto the special centres compatible with package dyeing equipment. Batches of suitable size are drawn from this material to fill individual orders. Commission yarn processors generally receive hanks baled in conventional wool bales.

In hank-based processes the bales are normally brought into the dyehouse and opened at the side of the scouring or dyeing machine ready for manual loading

Yarn scouring

Scouring is generally carried out as a semi-continuous process in which batches of yarn are transported through a series of aqueous baths containing detergent and alkali or rinse water. As shown in Figure 2.46 scouring can be carried out both on dyed and undyed yarn. To prevent cross contamination with dyestuffs, integrated yarn manufacturers may operate two scouring machines, one being reserved for scouring white yarn prior to dyeing and the second for the scouring of coloured yarn.

Yarn may be scouring using either hank scouring or package to package (sometimes referred to as single end) processing machinery.

In *tape scouring machines* (Figure 2.47) hanks are transported through the machine trapped between an upper and lower set of nylon tapes which run in an endless belt through each bowl and mangle set, guided by intermediate rollers in the bottom of each bowl. Bowl working volume is typically between 1200 and 1800 litres. Throughput capacity typically ranges from 500 to 1500 kg/hour. Residence time in each bowl varies between 20 and 45 seconds. Heating is provided by either closed coils in the base of the machine or live steam injection.

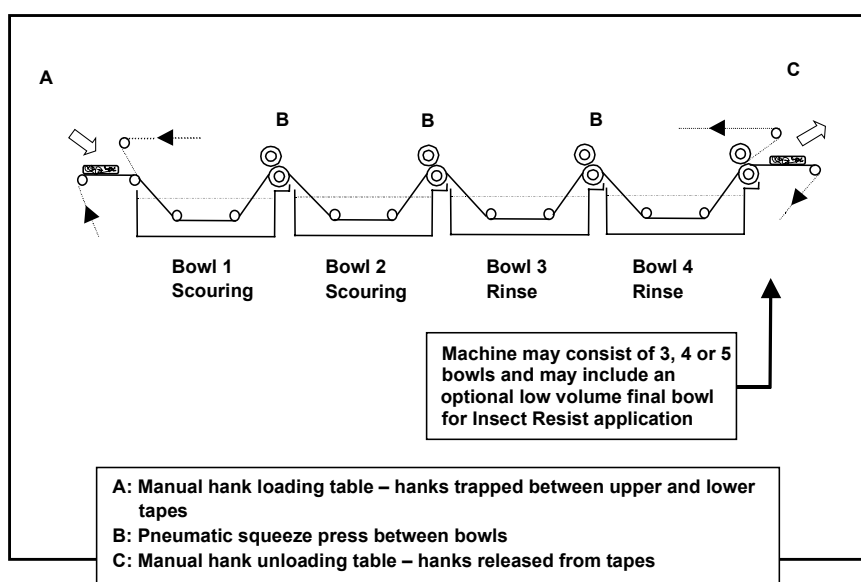


Figure 2.47: Schematic layout of a hank-scouring machine
 [32, ENco, 2001]

Each bowl is initially charged with the required chemicals and further additions are made during processing, either manually or with a metering device. In machines used only for scouring, the process liquor may flow from bowl four towards bowl one, thus providing a simple countercurrent extraction system. Specific water consumption varies widely, depending on the quantity of yarn processed through the machine before dropping the liquor for cleaning and the extent of any flowdown to drain from the scouring bowls. Values between 2 and 7 litres of water per kg yarn are common.

"Package to package" scouring machines (Figure 2.48) are less common and are of more recent design. With this machinery the whole process may be automated, including drying. Coiling devices take yarn from a number of individual cones and form this into an endless blanket of overlaid coils, laid down automatically onto a moving conveyer belt. The conveyer passes through each of the scouring and rinse bowls. The yarn is transferred to a second conveyer, which then passes through the dryer. The yarn blanket is then uncoiled and the yarn finally rewound onto cones.

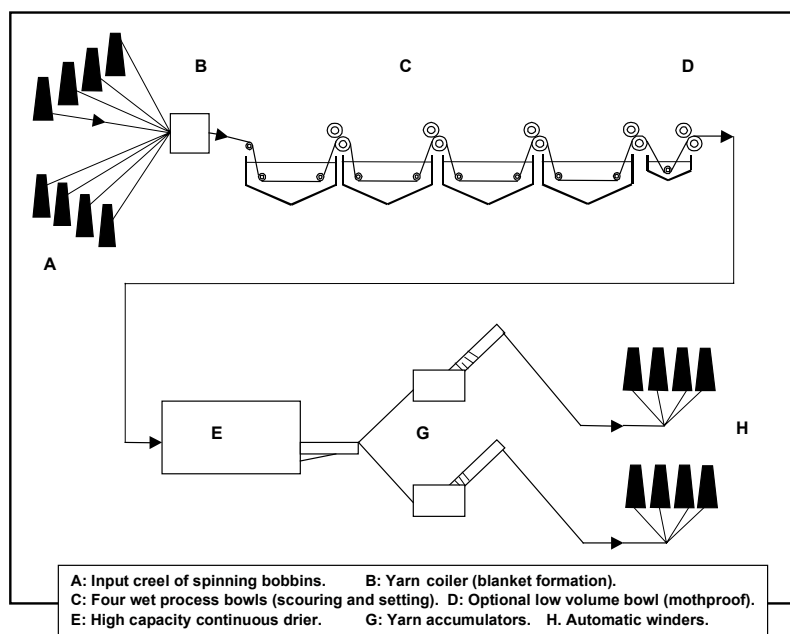


Figure 2.48: Schematic diagram of a "Package to Package" yarn scouring installation [32, ENco, 2001]

The scouring bowls are of larger volume (3500 litres) than tape scour machines and heating may be by direct gas firing. Most machines are equipped with dual yarn coilers, giving an overall capacity of up to 500 kg/hour.

Both hank and single end machines may be utilised only for scouring or the process may be modified to include simultaneous chemical setting of yarn twist and the application of insect-resist (IR) agents.

Scouring to remove lubricant

When the machines are operated only *to remove lubricant*, the first two bowls are charged with detergent and alkali and operate at 50 – 60 °C, while the remaining bowls serve to rinse the yarn with clean water at 20 – 30 °C. Chemical additions are made initially to set the bath concentration at a predetermined level, which is then maintained by further additions during processing.

Scouring and insect-resist treatment

Four-bowl machines are normally used if the scouring process is to incorporate a simultaneous insect-resist (IR) treatment. Bowls 1 & 2 are charged as above for scouring, bowl 3 contains clean water for rinsing, and bowl 4 is adapted for insect-resist application. Bowl 4 may be of the low volume type (100 - 200 litres), designed specifically for the treatment of yarn with insect-resist agent in order to minimise the volume of the process liquor and the resulting emissions.

In these installations, insect-resist agent is applied by a process of “continuous exhaustion” rather than physical impregnation and the active substance is stripped from the bath by the yarn, equilibrium bath concentration being maintained by continuous chemical metering at a rate proportional to yarn throughput.

Application is carried out at 50 – 60 °C under acidic conditions (approximately pH 4.5 by either formic or acetic acid) to promote rapid uptake of the active substance in the short yarn residence times available.

The insecticide content of the bowl is such that it cannot be discharged to drain and therefore storage tanks are used to retain the liquor between treatment cycles. Heavy contamination of the liquor with dyestuff removed from the yarn would lead to a change of shade in subsequent yarn lots and so a simple adsorptive filter system may be used to remove dyestuff before storage. This consists of a quantity of wool fibre packed into a filter housing and through which the liquor can be circulated. The liquor is preheated to a minimum of 70 °C to assist effective dyestuff removal. Operating with this liquor renovation system permits re-use of the liquor without the need to discharge to drain.

In the absence of these abatement systems the spent treatment liquor can be pumped from the scouring machine and added to a dark shade dyeing, where uptake at the high dyeing temperatures minimises emissions of active substance. Both loose fibre and yarn dyeing can be done in this way.

A third abatement option uses chemical hydrolysis of the active ingredient to destroy residual insecticide. Spent liquor is pumped from the machine and treated in a separate tank at 98 °C with sodium hydroxide (4g/l) for 60 minutes. The ester and cyano-ester linkages in permethrin and cyfluthrin undergo rapid hydrolysis under these conditions and more than 98 % abatement is achieved. The primary degradation products are at least one order of magnitude less toxic to aquatic invertebrates when compared to the parent molecule. Liquors treated in this way are normally discharged to drain, where the high alkali-content is neutralised by acids from dyeing processes.

More information about these techniques is reported in Section 4.8.4.

Chemical twist setting

Five-bowl machines are normally employed if chemical twist setting is to be carried out at the same time as scouring. In this mode Bowls 1 and 2 contain sodium metabisulphite (10 to 20 g/l) in addition to detergent and alkali and Bowl 4 may be charged with hydrogen peroxide (5 to 10g/l) to neutralise any residual bisulphite. In all other respects the process is similar to that described above.

Hanks leave the final mangle of the scouring line with a moisture content of approximately 0.8 litres per kg (dry weight). If the material is to receive no further wet processing, this residual moisture is further reduced by centrifugal extraction before evaporative drying in a hot air dryer.

Scouring in hank form may also be carried out using batch *solvent processing equipment*, although this practice is now less common. Perchloroethylene is the solvent of choice, and these machines operate on the totally enclosed principle, washing, rinsing and drying being accomplished sequentially within a horizontal drum. All machines are fitted with solvent recovery systems to distil used solvent and recover solvent vapour during drying.

Hank and package dyeing processes

Traditionally, carpet yarn dyeing is carried out in hank form, where liquor circulation in the dyeing machine produces a yarn with a characteristic physical property, often described as loft or fullness. Hank dyeing machines are mostly of the Hussong type.

In other sectors of the textile industry it is common to dye yarn in package form – wound onto a perforated centre, through which dye liquor can be circulated under pressure. This process has considerable cost advantage over hank dyeing in that it requires no reeling operation to form the hank and consequently no winding of the hank back onto cones in preparation for weaving or

tufting. With wool and wool-blend yarns the extension applied during package winding results in the yarn being set in a “lean” condition and the resultant yarn does not have the required physical characteristics for carpet manufacture. There are, however, a number of ways of overcoming these objections and package dyeing is slowly gaining credence in the carpet yarn dyeing industry. Three basic types of machines may be used for package dyeing wool yarns: horizontal or vertical spindle machines or tube type machines.

Although the machinery employed in hank and package-dyeing processes is different, the dyeing procedures and techniques are essentially the same and are described together.

Considerable care is required to obtain a level (even) dyeing on yarn as there are no opportunities to even up the colour by mechanical blending, as is the case with loose fibre dyeing. Faulty dyeings must be corrected by manipulation in the dye bath, by either removing or adding colour to achieve the final shade. This process can add significantly to the resources consumed in yarn dyeing.

In comparison to synthetic fibres, the rate of dyeing and the extent of dye uptake is less predictable when dyeing wool, as natural variations in the physical and chemical composition of the fibre have a marked effect on these important parameters.

The dyeing of carpet yarns predominantly composed of a blend of wool and polyamide fibre further compromises the dyer because the two fibres have markedly different dyeing properties and special dyeing auxiliaries must be used to achieve a commercially acceptable product. Problems associated with level dyeing are further compounded by the fact that very few shades can be achieved with one single dyestuff; most shades require the simultaneous application of a number of colours in various proportions and which may have different rates of uptake.

The usual approach is to carry out trial laboratory dyeing on a sample of the particular fibre blend and then to apply 5 – 10 % less dye in the full scale dyeing, the final shade being achieved by adding additional dye in small portions to achieve the final shade. Depending on the dyestuffs, it may be necessary to cool the dye bath for each of these additions in order to promote even migration of the added dye.

Dyeings which are “overshade” can be corrected by stripping dyestuff from the fibre using an excess of levelling agent or reducing conditions, and then adding further colour to achieve the correct shade. This is a practice of last resort in most dyehouses.

This shade matching procedure is an essential part of the dyeing processes as most dyeing is carried out to an agreed standard, either for internal use in the case of an integrated site or by agreement with the customer. Shade matching is predominantly carried out by eye, the dyer comparing the dyed material with a reference pattern under standard illumination.

In other sectors of the textile industry it is common to use colour matching spectrophotometers to determine the reflectance spectra of the dyed material for comparison with a numerical standard. In some instances these measurements may also be used to generate the dyeing recipe from the standard. These techniques are less successful with carpet yarn because a sample of yarn prepared to represent the cut pile of a carpet, viewed end on, must be used for the result to be meaningful. Despite these difficulties a number of manufacturers do use this technology, claiming significant improvements in batch-to-batch matching and subsequent reductions in material wastage.

Hank dyeing machines may be loaded with either dry or wet yarn. In the latter case the yarn may be carrying moisture from the scouring operation or may have been deliberately wetted out to facilitate even packing. This technique is often applied when loading large hanks of yarn with a high twist factor. Package dyeing machines are loaded dry.

Dyestuffs and chemicals typical of wool and polyamide fibres are employed (see Sections 2.7.4 and 2.7.6.1). Preparation for dyeing normally consists of filling the machine with water at 15 - 30 °C and adding acids, salts and dyeing auxiliaries as required by the recipe. With hank dyeing machines it is conventional to raise the lid and yarn from the dye bath before adding pre-dissolved dyestuffs. In closed package dyeing machines dyestuffs are added from linked transfer tanks.

The dye liquor is circulated for 10 - 15 minutes at 15 – 30 °C before commencing the heating programme, raising the temperature of the dye bath, according to the dyeing programme in order to maximise exhaustion.

At this stage the dyer will obtain a sample of the dyed yarn for comparison with a standard, in the case of hank dyeing by raising the load from the dye bath, or with package dyeing equipment, through a sampling port in the machine case. A dyeing which is judged to be on shade at this stage is terminated and the dye bath drained. If further additions of dyestuff are required the dye bath may be cooled, in the case of hank dyeing machines by partial draining and refilling with cold water or in package dyeing machines by circulating cooling water through an internal heat exchange core.

Following addition of dyestuff, the dye bath will be returned to the boil and boiled for 30 - 60 minutes before a further yarn sample is taken for shade matching. This operation may be repeated several times before the dyer is satisfied that the bulk material matches the standard. The spent dye bath is then drained and the yarn rinsed in clean water at 15 – 30 °C for 10 - 20 minutes before finally being allowed to drain, ready for unloading.

In some instances the spent rinse bath may contain little or no residual colour. As the temperature of this liquor is compatible with dyeing start temperatures, it may be retained in the dyeing machine and used for a subsequent dyeing. This practice reduces water usage by up to 50 %.

Application of functional finishes

A number of functional finishes may be applied, either with the dyestuffs or from additional baths of clean water following dyeing. These include insect-resist treatments, flame-retardant treatments and antistatic treatments.

Insect-Resist treatments

Traditionally formulated insecticides, based on synthetic pyrethroids or Sulcofuron, were added to the dyeing with the dyestuffs. To minimise residues and control fugitive emissions this basic procedure has been modified. The formulated product is now added to the dyeing at a later stage; to avoid the spillages that occur during yarn lowering and dyeing, auxiliaries are selected which do not interfere with exhaustion. Emissions from dyeings carried out under acidic conditions are normally within permitted limits, but experience has shown that these standards cannot be met when dyeing under more neutral conditions. In this case, the insect-resist agent is applied from a blank aftertreatment bath in the presence of formic acid at a temperature of 70 - 80 °C (see also Section 4.8.4).

Antistatic treatments

Antistatic finish applied to the pile yarn is mainly based on a cationic surfactant system, which is readily applied to the fibre under mildly alkali conditions. Cationic compounds are not compatible with anionic dyestuffs and these materials cannot, therefore, be incorporated in the dye bath, but must instead be applied as aftertreatments. The process consists of preparing a fresh bath of clean water, adjusting the pH and adding the required quantity of the proprietary product. The liquor is raised to 60 °C and run at this temperature for 20 - 30 minutes, followed by rinsing in clean water.

Flame-retardant treatments

Potassium salts of fluoro complexes of zirconium (potassium hexafluorozirconate) are typically used for wool and wool-blend fibres. Typical application conditions for carpet wool yarn are as follows:

- rinsing is required to remove interfering sulphate and phosphate ions, if present
- bath set up at 20–30 °C, pH 3 with hydrochloric acid (10 % o.w.f.) or formic acid (15 % o.w.f.) and citric acid (4 % o.w.f.)
- addition of potassium hexafluorozirconate (3 to 8 % o.w.f. depending on the final specification to be achieved and the substrate) dissolved in 10 times its weight of hot water
- temperature raised at 1–2 °C per minute to 60 °C and held at this temperature for 30 minutes
- rinsing in cold water for 10 - 20 minutes.

Other treatments

In addition to application of the above functional finishes, which are all invariably carried out in conjunction with colouration, yarn dyeing equipment may be used for other specific yarn preparation or treatment procedures, principally bleaching and twist setting. These are described separately below.

Bleaching

The industry favours the neutral white colour obtained by an oxidation bleach, followed by a reductive bleach. Typical processing conditions would be:

1. at 40 °C, run yarn in liquor containing 3 % o.w.f. proprietary stabiliser, 1.5 % o.w.f. sodium tri-polyphosphate, 20 % o.w.f. hydrogen peroxide (35 %). Raise liquor to 70 °C, circulate 40 minutes. Drain
2. run in a fresh bath containing 0.2 % o.w.f. formic acid (85 %) and 0.75 % o.w.f. sodium hydrosulphite. Raise to 50 °C, circulate 20 minutes, drain and rinse in cold water.

Yarn (dye bath) twist setting

This process is not always carried out as a separate treatment. In fact, during the hank dyeing of wool yarns the twist inserted during spinning is stabilised by chemical changes within the fibre at the temperatures reached by the boiling dye bath.

Yarn may, however, be twist set in hank form using conventional hank dyeing equipment. Typical processing conditions would be:

1. raise dye bath to 80 °C, add 5 % on the weight of yarn sodium metabisulphite, immerse yarn, circulate liquor for 15 minutes, drain machine
2. rinse cold with liquor containing 0.8 % o.w.f. hydrogen peroxide (35 %) for 15 minutes.

2.14.5.2 Integrated Carpet Manufacturing Mills

Fully integrated carpet manufacturers carry out all the mechanical processes, wet processes (pretreatment, dyeing, printing and finishing operations) required to convert natural and synthetic fibres into finished carpet. Such companies may also produce their own synthetic fibres from raw polymer feedstock. Regarding the natural fibres processed they can in some cases select and purchase natural fibres and operate the whole chain of processes from wool scouring to dyeing, yarn spinning and carpet weaving/tufting. However, usually not all of these operations are carried out at the same site.

The conversion of the fibre into finished carpet can follow different routes depending on the style of the carpet to be produced.

Tufted carpet

Yarn can be manufactured from:

- staple fibres, from both synthetic (PA, PP, PES, PAC) and natural (wool and cotton) fibres
- continuous filaments, exclusively from synthetic fibres (mainly PA, PP and PES).

The carrier materials (primary backing) usually consist of:

- PP woven fabrics or webs
- PES woven fabrics or webs
- jute fabrics.

Finishing of tufted carpets involves:

- dyeing and/or printing
- coating
- mechanical finishing
- chemical finishing.

Dyeing and chemical finishing can be applied on loose fibre, yarn or piece, while the other operations are carried out on the final carpet.

Needle felt carpet

Almost all fibres may be used for the production of needle felts (PP, PA, PES, PAC, wool, cotton jute/ sisal, coconut fibre and viscose). However, mostly man-made fibres are used.

Needle felts finishing involves:

- dyeing (rarely done)
- coating
- mechanical finishing (rare)
- chemical finishing.

Woven carpet

Both natural and synthetic fibres are used in woven carpet production.

Carpets are woven using dyed yarns (so piece dyeing is not applied in woven carpet production). The final carpet is then submitted to mechanical and chemical finishing treatments.

3 EMISSION AND CONSUMPTION LEVELS

3.1 Introduction

The main environmental issues relevant for the textile industry have been dealt with in detail, process by process, in Chapter 2.

The textiles industry has always been regarded as a water-intensive sector. The main environmental concern is therefore about the amount of water discharged and the chemical load it carries. Other important issues are energy consumption, air emissions and solid wastes and odours, which can be a significant nuisance in certain treatments.

Air emissions are usually collected at their point of origin. Because they have been controlled for quite a long time in different countries, there are good historical data on air emissions from specific processes.

This is not the case with emissions to water. The various streams coming from the different processes are mixed together to produce a final effluent whose characteristics are the result of a complex combination of factors:

- the types of fibres involved
- the types of make-ups processed
- the techniques applied
- the types of chemicals and auxiliaries used in the process.

Furthermore, since the production may vary widely not only during a year (because of seasonal changes and fashion) but even over a single day (according to the production programme), the resulting emissions are even more difficult to standardise and compare.

The ideal approach would be a systematic analysis of the specific processes, but data availability is very poor for many reasons, including the fact that legal requirements have tended to focus on the final effluent rather than on the specific processes.

Mindful of these limitations on the characterisation of waste water emissions, it has proven appropriate to identify narrow categories of finishing industries and then to compare the overall mass streams between mills belonging to the same category. This approach allows a preliminary rough assessment in which, by comparing the consumption and emission factors of mills within the same category, it is possible to verify given data and identify key issues and macroscopic differences between the similar activities.

Input/output considerations will therefore be addressed step by step, starting from overviews of the overall mass streams and ending in a more detailed analysis of single processes and/or issues that are of some concern.

This is the approach that will be followed in this chapter for all categories of industries identified in Chapter 2 (Section 2.14). One exception is represented by odours and solid wastes issues which will be dealt with in Section 3.5 and Section 3.6 at the end of this chapter. It should be noted that the data sets given within the tables reported in this chapter represent examples only.

3.2 Wool scouring mills

3.2.1 Cleaning and washing with water

This section refers to a well defined category of companies whose general features are briefly described in Section 2.14.1, while the scouring process itself is described in Section 2.3.1.1. The information reported in this section reflects an industry survey of raw wool scouring and effluent treatment practices in the European Union, undertaken by ENco in 1997/98 on behalf of INTERLAINE.

The number of responses received from each of the Member States where there is wool scouring activity was as follows:

Belgium	0
France	2
Germany	1
Italy	1
Portugal	2
Spain	1
UK	5
<i>Total</i>	<i>12</i>

In addition, a completed questionnaire was received from an Australian subsidiary of a European company and a set of data was submitted in a second stage by some Italian mills ([193, CRAB, 2001]).

Production volumes varied greatly, from 3000 to 65000 tonnes of greasy fibre per year. Working patterns also varied, ranging from companies working 24h per day on 7 days per week, to companies working 15 - 16h per day on 5 days per week.

As already highlighted in Section 2.3.1.1, the arrangements for circulating the scour and rinse liquors may vary widely. There are also significant differences in processing conditions due to the nature of the wool processed (fine or coarse) and the contaminants present. All these factors, combined with the type of waste water treatment adopted, influence the quality of the effluent from the scouring mill. Table 3.1, Table 3.2 and Table 3.3 summarise the data collected at different wool scouring sites. Some companies have been grouped together in an attempt to find a relationship between the liquor handling system adopted and the resulting consumption and emission levels. The original identification letters for the different companies have been kept. Fine, extra-fine and coarse wool processors appear in separate groups to enable easier comparison.

FINE WOOL	Mill F	Mill E	Mill G	Mill J	Mill N
Loop	No	Yes		Yes	
Recycle	No	No		Yes (from ww treatment plant)	
Water consumption (l/kg of g.w.)					
Gross:	6.67	n.d.	6.30	n.d.	5.00
of which recycled:					
- from grease recovery loop:	0	n.d.	3.33	n.d.	1.31
- from the rinse effluent:	0	0	0	0	0
- from the ww treatment:	0	0	0	2.37	2.38
Net:	6.67	10.00	2.97	0.36	1.31
Detergent (g/kg of g.w.)	7.78	15.83	5.96	4.50	6.15
Builder (g/kg of g.w.)	4.20	0.00	n.d.	5.55	3.84
Grease recovered (g/kg of g.w.)	34.5	71 ^(a)	27	19.10	34.6
% of the total	25 - 30		20	20	25 - 30
COD before ww treatment (g/kg g.w.)					
- from rinse water flow		13.40	n.d.	n.d.	7.35
- from scour flow		n.d.	n.d.	n.d.	143
Source [187, INTERLAINE, 1999]					
Notes:					
g.w. = greasy wool; Loop = use of dirt removal and/or grease recovery loop with recycle of the water to scour; Recycle = use of recycled water from the waste water treatment plant and/or from the rinse bowl by means of UF system; Gross = total flow in scour, i.e. sum of fresh and recycled water feeds;					
Net = net consumption					
^(a) Centrifugal grease + acid cracked grease					

Table 3.1: Wool scouring process mass streams overview (fine wool)

COARSE WOOL	Mill C	Mill H	Mill L
Loop	No	Yes	Yes
Recycle	No	No	Yes (from rinse bowl by UF)
Water consumption (l/kg of g.w.)			
Gross:	13.20	10.28	n.d.
of which recycled:			
- from grease recovery loop:	0	5.71 ^(a)	n.d.
- from the rinse effluent:	0	0	n.d.
- from the ww treatment:	0	0	n.d.
Net:	13.20	4.57	1.80
Detergent (g/kg of g.w.)	9.09	8.00	7.00
Builder (g/kg of g.w.)	7.09	1.00	7.00
Grease recovered (g/kg of g.w.)	0	13	7.5
% of the total	0	25	15
COD before ww treatment (g/kg g.w.)			
- from rinse water flow	n.d.	4.46	1.6
- from scour flow	n.d.	218.5	105.2 ^(b)
Source [187, INTERLAINE, 1999]			
Notes:			
g.w. = greasy wool			
Loop = use of dirt removal and/or grease recovery loop with recycle of the water to scour			
Recycle = use of recycled water from the waste water treatment plant and/or from the rinse bowl by means of UF system			
Gross = total flow in scour, i.e. sum of fresh and recycled water feeds;			
Net = net consumption			
^(a) the mill has two separate recovery loops (one for dirt removal and one for grease recovery)			
^(b) concentrate from the UF system + waste flow from grease recovery loop			

Table 3.2: Wool scouring process mass streams overview (coarse wool)

EXTRA FINE WOOL ^(a) (15 - 22 µm)	Site 1	Site 2	Site 3	Site 4
Loop	Yes	Yes	Yes	Yes
Recycle	No	No	No	No
Water consumption (l/kg of g.w.)				
Gross:	n.d.	n.d.	n.d.	n.d.
of which recycled:				
- from grease recovery loop:	n.d.	n.d.	n.d.	n.d.
- from the rinse effluent:	0	0	0	0
- from the ww treatment:	0	0	0	0
Net:	13.3	14	7.1	8.1
Detergent (g/kg of g.w.)	6.8	4.62	7.7	13.8
Builder (g/kg of g.w.)	12.3	15.2	12	20.3
Grease recovered (g/kg of g.w.)	30.9	42	31.7	32.5
% of the total	n.d.	n.d.	n.d.	n.d.
COD before ww treatment (g/kg g.w.)				
- from rinse water flow	n.d.	n.d.	n.d.	n.d.
- from scour flow	n.d.	n.d.	n.d.	n.d.
Sludge from the ww plant (g/kg g.w.)	510	432	353	325
Source: [193, CRAB, 2001]				
Notes:				
g.w. = greasy wool				
Loop = use of dirt removal and/or grease recovery loop with recycle of the water to scour				
Recycle = use of recycled water from the waste water treatment plant and/or from the rinse bowl by means of UF system				
Gross = total flow in scour, i.e. sum of fresh and recycled water feeds;				
Net = net consumption				
^(a) figures are related to greasy wool consumption, as are all other production-specific values in this report. In the original reference, the production-specific values are related to clean wool (about 60 - 70 % of greasy wool)				

Table 3.3: Wool scouring process mass streams overview (extra fine wool)

Water Usage

The wool scouring industry has a reputation for high water consumption. [18, VITO, 1998] reports 10 – 15 l/kg greasy wool as the range of water consumption for traditional installations, although lower values were observed in the surveyed companies.

Net specific consumption can be reduced by installing a grease and dirt recovery loop, through which water is recycled to the scouring bowls. It is also possible to apply similar recycling technology to waste rinse water. Mill L had such an arrangement, using ultrafiltration to treat the rinse water.

In addition to the above process-integrated recycling arrangements, it is also possible for mills with evaporative effluent treatment plants to re-use the evaporator condensate for feeding scour and/or rinse bowls. Five of the mills surveyed treat effluent by evaporation, but only three of these recycle the condensate. One of those that does not recycle the condensate cites problems with build-up of ammonia and odours as the reason for not recycling.

In fine wool scouring, gross water flow in the scour varies greatly, from 5 l/kg in the case of Mill N to more than 10 l/kg for Mill E. The latter apparently operates in similar conditions to Mill G, but it has an old and complex system for collecting, settling and filtering effluent, which probably explains its lower performance. Mill G recycles scour liquors at three times the rate of Mill N.

Net water consumption varies even more widely than the gross liquor circulation (from 10 l/kg in the case of Mill E to 0.36 l/kg for Mill J). In the latter this very low net specific water consumption is achieved through total recycling of condensate from the effluent treatment plant (anaerobic lagoon/evaporation), plus an unstated amount of process-integrated recycling via a grease/dirt removal loop.

Of the coarse wool scourers, two have dirt removal/grease recovery loops recycling to the first scour bowl; one of these two also has a rinse water recycling loop (Mill L). All three scourers bleach in the last bowl of the scour train, using hydrogen peroxide and isolating the bleaching bowls from the countercurrent.

It is possible to calculate gross circulation in the scour at two of the mills. In both cases, it is significantly higher than encountered in all but one of the fine wool scourers. This may be because the coarse wools contain more dirt than fine wools [187, INTERLAINE, 1999].

Net water consumption varies considerably in the three mills. Mill C has the highest net water consumption of any of the surveyed mills that process fine and coarse wool. This mill recycles no liquor at all. Mill H has a moderately low net water consumption, which is achieved by using the highest capacity dirt removal/grease recovery loop encountered in this survey. Mill L recycles rinse water and also presumably has other recycling arrangements to achieve its low net consumption.

Another factor playing a potential role in net water consumption is the production volume. Figure 3.1 shows, by plotting net consumption against production volume, a tendency for net specific water consumption to fall as production volume increases. There are clearly mills whose net water consumption is below the norm, which is represented by the drawn curve.

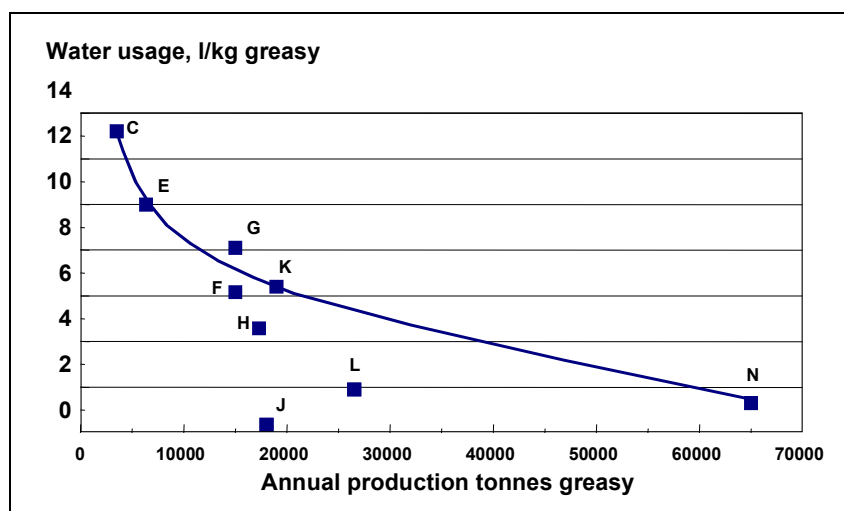


Figure 3.1: Net specific water consumption plotted against production volume [187, INTERLAINE, 1999]

There may be several reasons for this relationship between water consumption and production volume. Besides economies of scale in larger companies, possibly the most important reason is the mill's perception of the economics of reducing water consumption. Some of the medium-sized mills may feel unable to make the required investment or may not have the staff resources to devote to the task [187, INTERLAINE, 1999].

No detailed information has been submitted about the characteristics of the grease recovery loops applied in the mills mentioned in Table 3.3. Therefore it is not possible to draw conclusions about the water consumption levels reported in the table.

Grease recovery

One scourer (Mill C) has no grease recovery plant, while the remaining mills recover between 8 and 71 kg grease per tonne of greasy wool processed. The scourers at the bottom end of this range (Mill H, 13 kg/tonne and Mill L, 8 kg/tonne) are wholly or predominantly scourers of coarse wools, which contain lower percentages of grease in a more oxidised (less hydrophobic) form, which is more difficult to separate centrifugally. At the top end of the range is Mill E, which recovers 71 kg of grease per tonne of wool processed. This mill is a fine wool scourer with a centrifugal grease recovery plant and an acid cracking plant. The acid cracking plant produces a lower quality grease which must now be regarded as a waste rather than a by-product, since it cannot usually be sold and has to be landfilled. The remaining mills, wholly or predominantly fine wool scourers, recover between 22 and 42 kg of grease per tonne of raw wool (average, 30 kg/tonne).

Chemical Usage

The most important chemicals used by scourers are detergents and builders. As for the data reported in Table 3.1 and Table 3.2, seven of the scourers use alcohol ethoxylate detergents and five use alkylphenol ethoxylates (the data are reported for only two mills). Two UK scourers also report the use of “solvent assisted detergent” for the removal of marking fluids from fleeces. Eight scourers use sodium carbonate as builder, two use sodium hydroxide and two use no builder.

No information has been submitted about the types of detergents used by extra fine scouring mills referred to in Table 3.3.

Scourers of coarse (carpet) wools are often asked by customers to bleach the fibre by adding hydrogen peroxide and acid to the last rinse bowl. Five of the scourers do this routinely or occasionally.

The seven users of alcohol ethoxylates consume an average of 9.1g detergent per kg greasy wool (range 3.5 – 16g/kg), whilst the five users of alkylphenol ethoxylates use an average of 8.0g detergent per kg greasy wool (range 5 – 16g/kg). There is therefore no evidence of economies of scale, nor of the often-claimed greater efficiency of alkylphenol ethoxylates over alcohol ethoxylates.

It is also frequently claimed that fine wools require more detergent for scouring than coarse wools. The survey shows that the fine wool scourers use an average of 7.5g detergent per kg greasy wool (range 5 – 10g/kg) while coarse wool scourers use an average of 8.5g detergent per kg greasy wool (range 3.5 – 16g/kg), so this claim also seems to be without foundation.

Figure 3.2 shows that there is a relationship between detergent feed rate and the rate at which effluent is discharged to the mills’ effluent treatment plants. Detergent which is discharged in the effluent from the scour is lost, whilst recycling detergent via the grease recovery/dirt removal loop conserves much of it within the scour. Note that the values used in compiling this figure are calculated from annual usage divided by total wool processed and may differ from detergent feed rates to scour bowls used in the tables reported earlier (Table 3.1 and Table 3.2).

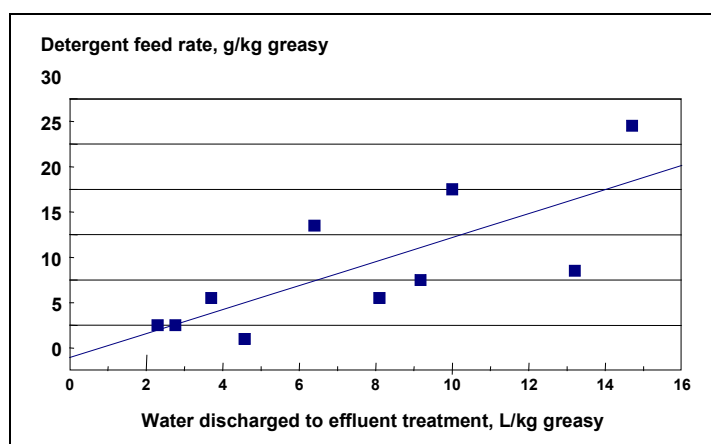


Figure 3.2: Relationship between the detergent feed rate and the rate of discharge of effluent to treatment

[187, INTERLAINE, 1999]

For builders, on the other hand, there is no obvious pattern related to wool type, detergent consumption or type or size of operation.

Several of the scourers also reported using varying quantities of acids and alkalis for cleaning purposes. These included hydrochloric, nitric, phosphoric and sulphuric acids, a mixture of organic and inorganic acids, and caustic soda. The use of sodium chloride for regeneration of the water treatment plant was also mentioned. Significant quantities of chemicals are used by some scourers in effluent treatment processes, but few data are available [187, INTERLAINE, 1999].

Energy Consumption

The mills in this survey were not asked to give energy consumption figures. Data presented here come from a survey carried out in the UK in 1998³.

Figure 3.3 shows the specific energy consumption (MJ/kg greasy wool) and the specific net water consumption (l/kg greasy wool) of the 11 mills which supplied data (the reported data refer only to the scouring process and do not include energy consumption for the waste water treatment plant).

The relationship between energy and water consumption is immediately obvious and is emphasised in Figure 3.4, where energy consumption is plotted against water consumption. As far as possible, the consumption figures used relate only to the scouring and related processes, such as effluent treatment.

Energy and water consumption both vary widely. Energy consumption ranges from 4.28 to 19.98 MJ/kg (average 9.29 MJ/kg) and water consumption varies from 1.69 to 18.0 l/kg (average 8.16 l/kg). R^2 for the correlation is 0.906.

³ M Madden, ENco, personal communication, 1999.

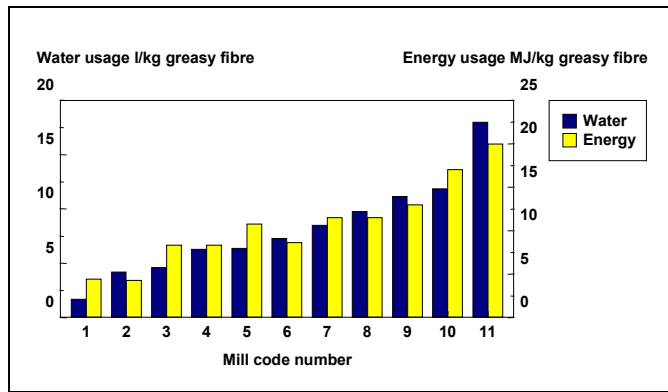


Figure 3.3: Energy and water consumption in 11 UK scouring mills [187, INTERLAINE, 1999]

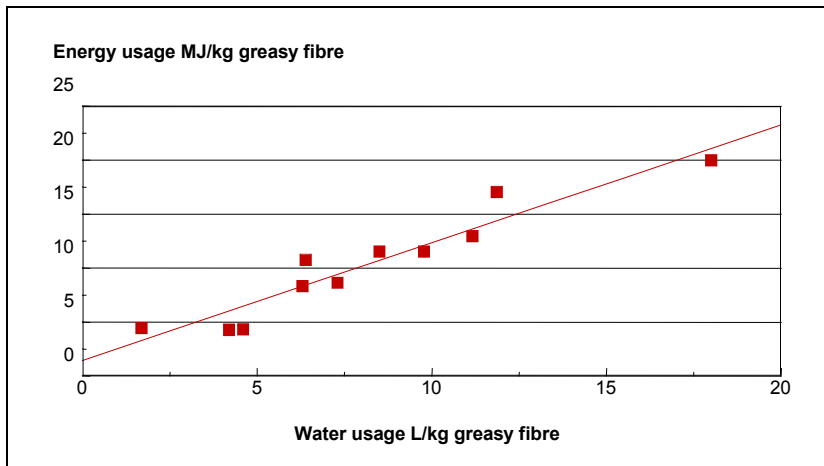


Figure 3.4: Energy consumption plotted against water consumption for 11 UK scouring mills [187, INTERLAINE, 1999]

The variation in water consumption in the UK study bore no relationship with throughput (as it did in the Europe-wide study). See Figure 3.5.

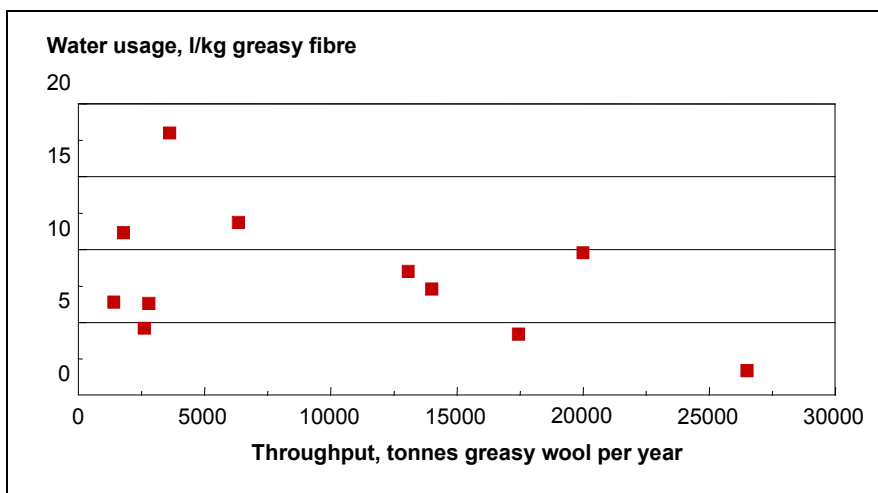


Figure 3.5: Water consumption against throughput for 11 UK scouring mills [187, INTERLAINE, 1999]

There are probably two reasons for the relationship between energy and water consumption. The more obvious is that much of the thermal energy consumed in wool scouring is used for heating water. Rather less obviously, it is likely that the mills which have expended time and effort (and perhaps capital) on reducing water consumption will also have given attention to reducing energy consumption. This assumption is supported by the fact that heating 1 litre of water to scouring bowl temperature consumes 0.21 MJ, whilst the slope of the regression line in Figure 3.4 above is 1.09 MJ/l [187, INTERLAINE, 1999].

Chemical Oxygen Demand

Specific COD loads before waste water treatment are indicated in the INTERLAINE document for only a few mills (see Table 3.1, Table 3.2 and Table 3.3). A global COD range of 150 - 500 g/kg of raw wool has, however, been estimated in the final summary (see Figure 3.6).

COD in the effluent immediately after the process is also influenced, apart from the quantity of contaminants present on the raw material, by the efficiency of the grease and dirt recovery system. Wool grease, dirt and suint are in fact the main contributors to the COD load, while detergent can be regarded as the smallest contributor. In this respect the specific COD loads could be roughly estimated, using the data available, by considering:

- the amount of COD contained in the raw wool (556 kg COD/tonne fine raw wool and 315 kg COD/tonne coarse raw wool, see also Section 2.3.1.2)
- the amount of grease removed/recovered from the effluent (assuming that the grease is the main contributor to the COD).

The available data concerning the COD levels after waste water treatment from the surveyed mills are summarised in Table 3.4. The mills have been subdivided into direct dischargers (companies that discharge directly to surface water) and indirect dischargers (companies that discharge to sewer after an on-site pretreatment. One mill recycles the effluent completely by evaporative treatment and therefore does not have any waste water discharge at all.

Some of the figures in Table 3.4 are estimated or calculated from other data supplied. To distinguish values supplied directly by the mills from estimated or calculated data, the former are printed in bold type.

In calculating the COD load entering the environment as a result of the activities of those wool scourers who discharge pretreated effluent to sewer, it has been assumed that the rate of mass removal of COD in the sewage treatment works is 80 %. This is believed to be an appropriate removal rate, although there is no hard evidence to support the assumption.

The processes used by the mills which responded to the questionnaire include all process types (coagulation/flocculation, evaporation, membrane filtration and aerobic/anaerobic biological treatment).

Unfortunately, not all effluent treatment sub-types are represented. For example, none of the responding mills uses dissolved air flotation (DAF) as a means of separation after addition of coagulants/flocculants to the effluent stream (all use either decanter centrifuges or hydrocyclones).

Only one mill uses membrane filtration (in this case ultrafiltration (UF) on rinse effluent only) – other types of membrane filtration are not represented. There is no mill which uses anaerobic digestion only to treat scouring effluent although the existence of such a mill in Italy is known.

There are also mills in Italy using conventional aerobic biological treatment (plants similar to those used for the treatment of municipal sewage) and combinations of anaerobic and aerobic biological treatment [187, INTERLAINE, 1999].

Four of the mills discharge effluent directly to surface waters. Two of these (Mills C and N) treat to high standards before discharge. Surprisingly, the other two discharge untreated effluent.

One of these mills is known to have installed a flocculation/coagulation effluent treatment plant since responding to the questionnaire.

Mill J recycles effluent completely after evaporative treatment. Mill N recycles scour effluent after treatment by evaporation and bio-filtration, but discharges rinse effluent to surface waters following treatment by prolonged aeration.

All the other mills (six in number) discharge to sewer and, in all cases, the discharged effluent receives aerobic biological treatment in a municipal sewage treatment works. The majority of these mills (four) use physico-chemical coagulation/flocculation processes to pretreat their effluent on-site, though only Mill K treats rinse effluent as well as scour effluent.

	On-site treatment		COD after on-site treatment		Sludge (g/kg)	COD after off-site treatment (g/kg)	Mill
	Scour liquors	Rinse liquors	(mg O ₂ /l)	(g/kg)			
No discharge	Scour liquors (after grease recovery) and rinse liquors are recycled after anaerobic lagoon and evaporative treatment		0	0	55	0	J
Direct discharge	None		19950 ^{c)}	299 ^{c)}		299 ^{c)}	B
	None		19950 ^{c)}	299 ^{c)}		299 ^{c)}	D
	Evaporator (the company does not have a grease recovery plant)		260	3.4	315 ^{b)}	3.4	C
	Evaporator + bioreactor (the water is recycled to rinse bowl)	Extended aeration (4 - 5 days)	120	0.2	75 ^{d)}	0.2	N
Indirect discharge	Al/polymeric flocculation Hydrocyclone	None	9000 ^{e)}	73 ^{e)}	233 ^{b)}	14.6 ^{f)}	G
	Acid/polymeric flocculation Decanter centrifuge	None	15000	60	145 ^{a)}	12.0 ^{f)}	H
	Fe/lime/polymeric flocculation Decanter centrifuge		3900	33	135 ^{a)}	6.6 ^{f)}	K
	Acid cracking Filter press	None	4000	42	154 ^{a)}	8.4 ^{f)}	E
	Aeration (4 - 5 days)		2800	25	113 ^{a)}	5.0 ^{f)}	F
	Evaporator	Recycling by UF (the concentrate is passed to the evaporator)	500	1.3	185 ^{a)}	0.3 ^{f)}	L

Source [187, INTERLAINE, 1999]

Notes:

Figures in bold are values that have been supplied directly by the mills; the other values have been calculated or estimated

a) dry weight

b) may be dry or wet

c) calculated as follows: COD content of coarse wool: 315 kg/tonne of which 95 % occurs in untreated waste water; water usage is assumed to be 15 l/kg greasy wool

d) estimated dry weight. This is the sludge from the grease recovery loop and aerobic biological treatment (the concentrate from the evaporator is incinerated and produces ash, but not sludge)

e) calculated as follows: COD content of fine wool 556 kg/tonne of which 95 % occurs in untreated waste water; water usage is assumed to be 15 l/kg greasy wool

f) calculated assuming that municipal aerobic treatment plant removes 80 % of COD

Table 3.4: Overview of effluent treatment processes and associated output of COD and sludge

Discharges from the mills vary widely, from zero to 73 kg COD/tonne of greasy wool processed, reflecting differences in the on-site treatments applied. However, all mills discharging more than 3.4 kg COD/tonne discharge to sewer and pay the sewerage operator for further treatment. This reduces the range of COD entering the environment to 0 – 15 kg/tonne. The best performance for a mill which does not completely recycle treated effluent (from evaporative treatment) is 0.2 kg COD/tonne for Mill N, but the estimated COD emissions to the environment from Mill L, which discharges via sewer, are similar at 0.3 kg/tonne.

Sludge

With regard to sludges arising from effluent treatment, many scourers did not state whether the weights given were wet or dry weight. These instances are noted in Table 3.4. Sludge production (dry basis) ranged from about 100 to 300 kg/tonne greasy wool except for two cases. Mill J treats effluent by anaerobic lagooning followed by evaporation and yet states that sludge production is only 55 kg/tonne. This figure possibly refers to the sludge or concentrate arising from evaporation and does not include the sludge from the anaerobic lagoon. In any case, it is unlikely to represent total sludge production at Mill J. Mill N treats scour effluent by evaporation and incineration. This produces 20 kg/tonne of ash, but no sludge. Sludges arise at this mill from gravity settling, plus decanter centrifuging, in the grease recovery/dirt removal loop and from aerobic biological treatment of rinse effluent. The figures given, equivalent to 75 kg/tonne, are believed correct [187, INTERLAINE, 1999].

The sludge is sent to landfill without pretreatment, or it finds other uses such as brickmaking or soil conditioner in agricultural land after composting. In one case it is incinerated.

Ectoparasiticides

Residues of veterinary medicines in wool scour effluent have the potential to cause harm in the environment. The most commonly found ectoparasiticides and the environmental issues related to their release in the effluent have already been described in Sections 2.1.1.9 and 2.3.1.2.

The questionnaire sent to scourers involved in the survey asked them to give quantitative information on the source countries of the wools they scour. Thanks to this information in combination with the ENco Wool and Hair Pesticide database (see Section 2.1.1.9) it was possible to estimate the average biocide content of the incoming raw material. The results of this calculation are reported in Table 3.5, which shows concentrations of individual ectoparasiticides in the range of 2 – 15 mg/kg of raw wool.

Mill	Total organochlorines ^(a) g/tonne greasy wool	Total organophosphates ^(b) g/tonne greasy wool	Total synthetic pyrethroids ^(c) g/tonne greasy wool
B	2.73	1.13	0.29
C	5.05	4.14	0.31
D	2.31	1.09	0.05
E	0.12	4.61	1.41
F	0.10	3.93	1.18
G	0.60	4.86	6.25
H	0.22	18.7	4.55
J	3.03	4.02	4.30
K	0.32	16.3	4.36
L	0.53	19.0	3.79
M	0.57	4.65	5.73
N	0.30	4.98	2.76

Source [187, INTERLAINE, 1999]

Notes

^(a) Sum of *alpha*-, *beta*-, *gamma* and *delta*-hexachlorocyclohexane, hexachlorobenzene, heptachlor, heptachlor-epoxide, aldrin, dieldrin, endrin, endosulphan, DDD and DDT.

^(b) Sum of chlorfenvinphos, dichlofenthion, diazinon and propetamphos.

^(c) Sum of cyhalothrin, cypermethrin, deltamethrin and fenvalerate.

Table 3.5: Average organochlorine, organophosphate and synthetic pyrethroid biocide content of the wools processed by 12 scourers

The emission loads of pesticides discharged in the effluent from the surveyed companies are not available. However, they could be estimated based on the water-grease partition factors of these compounds.

Biocides are in fact removed by the dirt removal/grease recovery loops, which are integrated with the scour, as well as by the end-of-pipe effluent treatment plant. For example, a mill which removes 25 % of the total grease on the incoming wool in its grease recovery loop, perhaps a further 5 % in its dirt removal loop, and 80 % of the remaining 70 % (i.e. 56 % of the total) in its effluent treatment plant, has an overall grease recovery rate of 86 %. Removal of lipophilic biocides would be expected to follow a similar pattern to that of grease removal. Rinse water recycling loops, if used, may also remove some biocides.

Many studies of the fate of ectoparasiticides in the wool scouring process have been carried out and these issues have already been dealt with in Section 2.3.1.2. Possible assumptions are listed as follows [103, G. Savage, 1998]:

- 96 % of the pesticides are removed from wool (4 % is retained on the fibre after scouring)
- of this 96 %, a percentage (which is usually 30 %, but in some examples it has been shown to be lower) is retained on-site in recovered grease
- the remaining fraction (which does not associate with wool, grease and dirt) is discharged in the effluent and submitted to waste water treatment.

Exceptions to this behaviour are represented by:

- water soluble pesticides (e.g. cyromazine and dicyclanil); in this case it is assumed that 4 % of the initial amount remains on the fibre, but no further pesticide is removed by wool grease recovery or on-site treatment; therefore 96 % of the initial amount is found in the waste water
- triflumuron: recent studies ([103, G. Savage, 1998]) have shown that triflumuron associates partly with grease and partly with dirt and that consequently a higher proportion of this pesticide residue is likely to be retained on-site. In particular, it can be assumed that 90 % of residues is retained on-site (including the amount retained on wool fibre and in recovered wool grease).

Concerning the effect of the waste water treatment, Table 3.6 summarises the monitoring results for woollscour effluent treatment plants, carried out by ENco in 1997/98⁴. The results in the table compare the effluent before and after treatment and were obtained by analysis of 24 h composite samples, taken on 10 separate days. The table also shows the reduced efficiency of evaporative systems in the removal of OPs due to their steam volatility (see also Section 2.3.1.2).

Mill	Plant type	Removal rate (%) in effluent treatment plant						
		Grease	COD	SS	OC	OP	SP	Total biocides
1	CF/Fe	86	84	89	83	88	94	88
2	CF/acid	89	73	89	69	78	40	77
3	HAC	82	70	75	72	75	75	75
4	BF/Fe	93	75	83	96	56	71	59
5	CF	73	70	75	76	91	94	91
6	CF/Fe	80	80	77	81	76	74	76
7	HB/Fe	96	83	94	90	92	89	92
8	Evap	100	99	100	97	72	100	78

Source [187, INTERLAINE, 1999]
Notes:
COD = chemical oxygen demand SS = suspended solids OC = organochlorines
OP = organophosphates SP = synthetic pyrethroids CF = continuous flocculation
HAC = hot acid cracking BF = batchwise flocculation HBF = hot batchwise flocculation
Evap = evaporation

Table 3.6: Performance of effluent treatment plants in removing wool grease, COD, suspended solids and ectoparasiticides from woollscour effluent

Additional data come from a separate ENco study⁵, where the mass loads of the three most commonly used sheep treatment chemicals – diazinon (OP), propetamphos (OP) and cypermethrin (SP) – discharged to sewer from seven scouring mills, were calculated and compared with the loads present on the incoming greasy wool. The latter values were obtained by using the average residue concentrations taken from the ENco database for the mix of wool sources scoured at each mill. The results are shown in Table 3.7.

Mill	Diazinon			Propetamphos			Cypermethrin		
	In wool g/tonne	In effluent g/tonne	Removal %	In wool g/tonne	In effluent g/tonne	Removal %	In wool g/tonne	In effluent g/tonne	Removal %
T	8.63	1.63	81	9.99	0.57	94	5.58	0.05	99
U	8.16	0.66	92	8.63	0.37	96	5.30	0.04	99
V	5.30	0.59	89	2.72	0.17	94	3.45	0.15	96
W	6.14	1.14	82	7.80	0.61	92	4.12	0.21	95
X	4.59	0.10	98	0.19	0.02	91	3.60	0.52	86
Y	8.16	1.48	82	10.60	0.78	93	5.41	0.20	96
Z	10.76	0.17	99	12.10	0.36	97	7.06	0.02	100

Source [187, INTERLAINE, 1999]

Table 3.7: Sheep treatment chemical residues in incoming greasy wool and in scouring effluent discharged to sewer at six mills

⁴ ENco, unpublished results, 1997 and 1998.

⁵ ENco, unpublished results, 1998.

By comparing the results in Table 3.6 and Table 3.7, it can be seen that the overall removal rates of sheep treatment chemicals from scouring effluent are significantly higher than the removal rates in the effluent treatment plants. As indicated earlier, the balance is presumably removed in the dirt removal/grease recovery loops.

The above discusses the removal of sheep treatment chemicals in physical and physico-chemical effluent treatment plants. It is possible that prolonged biological treatments will destroy at least some of the chemicals. One of the scourers in the European survey described here treats rinse effluent by prolonged (4 – 5 day) aeration and this is known to remove all SPs and all OPs except dichlofenthion^{6,7}. OCs are only partly removed. Biological treatments of short duration are not expected to break down the chemicals but may remove them by absorption into the lipid components of the biomass.

Figure 3.6 attempts to define for 1 tonne of raw wool the consumption and emission ranges for the scouring process and the waste water treatment. The ranges are defined based on the results of the survey integrated with some results obtained from previous surveys of scouring mills carried out by ENco in 1996 and 1998. It has to be noted that some of the given ranges are not generally applicable. For example, the range of values for flocculants used in on-site treatment is valid only for those companies with a coagulation/ flocculation effluent treatment plant.

⁶ Dichlofenthion is an OP which was formerly registered for sheep treatment in New Zealand. It is particularly resistant to biodegradation and its registration has been withdrawn.

⁷ G Timmer, Bremer Wollkämmerei, private communication, 1998.

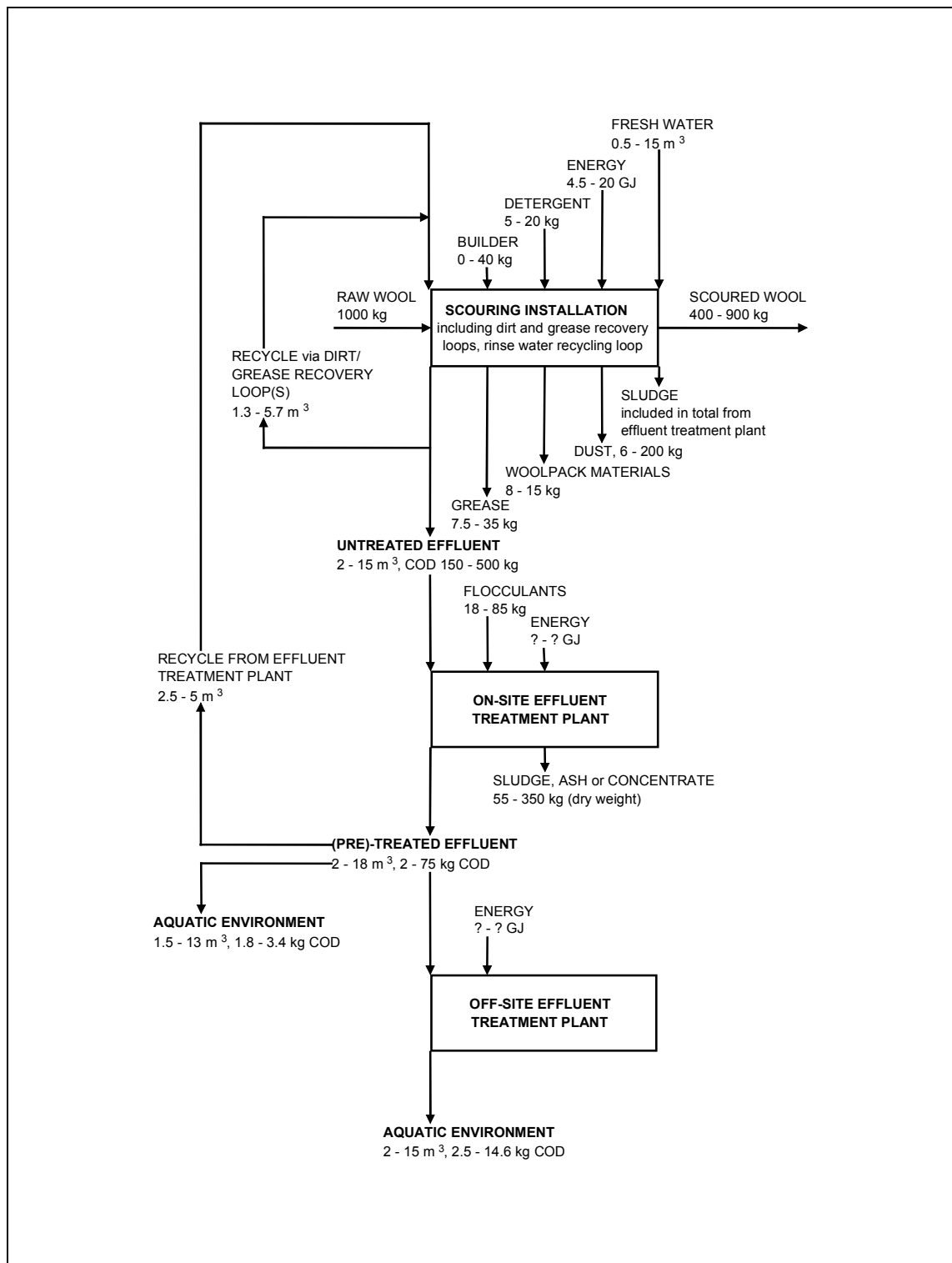


Figure 3.6: Diagram showing the ranges of inputs to and outputs from the scouring processes and effluent treatment plants (on- and off-site) at the mills surveyed [187, INTERLAINE, 1999]

3.2.2 Cleaning and washing with solvent

The inputs and outputs of the process are reported in Table 3.8. Inputs and outputs are based upon a Wooltech plant production of 500 kg of clean wool fibre per hour. Typically 852.6 kg/h of greasy wool feed comprises 500 kg/h wool fibre, 128 kg/h grease, 102 kg/h dirt, 42.6 kg/h suint and 80 kg/h moisture. Wide variations in contaminants (pesticides, dirt and grease) are possible. These figures, whilst typical, are therefore nominal only.

		Flow rate referred to the production of		Specific input/output referred to the production of		
		500 kg/h of clean wool	Unit	1 kg of greasy wool	1 kg of clean wool	Unit
INPUT						
Water	Total	124	kg/h	0.145	0.219	kg
	wool moist	20	kg/h	0.023	0.035	kg
	air moist	4	kg/h	0.005	0.007	kg
	steam eject	100	kg/h	0.117	0.177	kg
Solvent	TCE	10	kg/h	11.7	17.7	g
Energy	electricity	207	kWh	0.243	0.368	kWh
	natural gas	674	MJ/h	0.79	1.19	MJ
OUTPUT						
Clean dry wool	Total	563.1	kg/h	660	1000	g
	wool fibre	500	kg/h	586	888	g
	wool moist	60	kg/h	70	106	g
	grease	0	kg/h	0	0	g
	dirt	0.8	kg/h	0.9	1.4	g
	suint	2.3	kg/h	2.7	4.1	g
	pesticide (total)	Nil	kg/h	Nil	Nil	g
	TCE	0	kg/h	0	0	g
Dirt	Total	109.3	kg/h	128	194	g
	dirt	98	kg/h	114.9	174	g
	grease	7	kg/h	8.21	12.4	g
	suint	4.3	kg/h	5.04	7.64	g
	pesticide (total)	0.000138	kg/h	0.00016	0.00024	g
	TCE	0	kg/h	0	0	g
Grease	Total	160.2	kg/h	188	285	g
	grease	121	kg/h	141.9	215	g
	dirt	3.2	kg/h	3.75	5.68	g
	suint	36	kg/h	42.2	64	g
	pesticide (total)	0.00256	kg/h	0.003	0.00454	g
	TCE	0	kg/h	0	0	g
Water emissions	Total	124	kg/h	0.145	0.22	kg
	water	124	kg/h	0.145	0.22	kg
	TCE	0	kg/h	0	0	g
Air emissions	Total	643.01	kg/h	0.765	1.157	kg
	air	643	kg/h	0.754	1.14	kg
	TCE	0.01	kg/h	0.011	0.017	g
Uncaptured (1)	TCE	5	kg/h	5.86	8.88	g

Source: [201, Wooltech, 2001]

⁽¹⁾ A nominal allocation of 5 kg/h has been allowed

Table 3.8: Estimated process input and output in the Wooltech cleaning system

The following comments (see also Figure 2.5) apply to the reported data [201, Wooltech, 2001]:

- clean wool: it should be noted that this wool is pesticide free as any pesticides in the wool partition strongly to the solvent and are removed with the grease (analytical data have been submitted to support this statement). This has an additional advantage at the textile finishing mill as it makes it easier for the finisher to comply with the emission limit values for pesticides
- solvent make-up: a nominal consumption of 10 kg/h is shown, however much lower consumptions are generally achieved; the consumption is dominated by maintenance issues
- grease: this leaves as hot, liquid stream. Although it contains some dirt and suint, processes have been shown to separate this if higher quality grease is required (either acid cracking or no-acid cracking may be used). Also, final grease can be used for combustion to fuel the process
- fleece and moisture: water emissions come from moisture introduced with the wool, water introduced to the process (steam used in vacuum ejectors) and moisture recovered from air drawn into the equipment. This water is treated in two steps (see also Section 2.3.1.3). In the first step, most of the solvent is recovered by heating the water and air stripping it in the *Solvent Air Stripping Unit*. This recovers 99.98 % of the solvent present. The solvent recovered is recycled through the plant. Second, the minute traces of residual solvent (ppm level) in the water are then destroyed with a free radical process based on Fenton's reaction in the *Residual Solvent Destruction Unit*. Recovered solvent from, for example, maintenance activities is treated in the same manner.
- dirt: rinsing the solids and re-centrifuging prior to drying can eliminate the grease content. Solids are suitable for landfill or use as soil. Seeds in the dirt have been found to be rendered sterile by their contact with the solvent
- exhaust air: air is extracted from the plant to keep the processing equipment under a slight negative pressure. This air is treated through an adsorption system to recover solvent vapours. Destruction of the remaining solvent will involve a scrubbing treatment followed by oxidative destruction as for the process water.

3.3 Textile finishing industry

In the following sections, emissions and consumption levels are illustrated for a group of different sites belonging to the categories identified in Chapter 2 (see Section 2.14).

Information comes from various sources ([179, UBA, 2001], [198, TOWEFO, 2001], [200, Sweden, 2001], [199, Italy, 2001], [193, CRAB, 2001], [31, Italy, 2000]) and is the result of surveys carried out in a number of textile finishing industries in Europe in a five year timeframe (1995 to 2001).

With respect to the consumption of chemicals, where not otherwise specified, calculations have been carried out on the so-called "telquel"-basis. This means that the quantities of ready-for-use products have been considered, including water in the case of liquid formulations. This must be kept in mind when comparing the consumption levels of different companies. For instance, companies using mainly liquid dyestuff formulations (often the case for big mills) show specific dyestuff consumption higher than companies using powder or granulates.

3.3.1 Mills finishing yarn and/or floc

3.3.1.1 Mills finishing floc: mainly CV, PES, PAC and/or CO

For this category the only information available relates to emissions to water. The values are compiled in Table 3.9. Because of the low liquor ratios and small number of process baths, the specific waste water flow is low. The values in Table 3.9 are confirmed by "FhG-ISI, 1997" reporting specific flows for three further companies between 14 and 18 l/kg.

		TFI 1	TFI 2
Specific. Q _{ww} (l/kg)		34	10
COD	Conc. (mg O ₂ /l)	1945	1300
	E-Fac (g/kg)	67	13
BOD ₅	Conc. (mg O ₂ /l)	850	370
	E-Fac (g/kg)	29	4
AOX	Conc. (mg Cl/l)		
	E-Fac (g/kg)		
HC	Conc. (mg/l)	12.4	
	E-Fac (g/kg)	0.4	
PH			
L(mS/cm)		14.9	
T(°C)		40	
NH ₄	Conc. (mg/l)		
	E-Fac (g/kg)		
org.N	Conc. (mg/l)		
	E-Fac (g/kg)		
Tot.N	Conc. (mg/l)		
	E-Fac (g/kg)		
Cu	Conc. (mg/l)	1.2	0.05
	E-Fac (mg/kg)	41	0.5
Cr	Conc. (mg/l)	0.13	0.2
	E-Fac (mg/kg)	5	2
Ni	Conc. (mg/l)		<0.02
	E-Fac (mg/kg)		
Zn	Conc. (mg/l)	0.71	0.3
	E-Fac (mg/kg)	25	3
Source: [179, UBA, 2001]			
Notes:			
Blank cells mean that relevant information is not available			

Table 3.9: Concentration values and textile substrate specific emission factors for waste water from two mills mainly finishing floc material consisting of CV, PES, PAC or CO

3.3.1.2 Mills finishing tops/floc and yarn: mainly WO

Table 3.10 shows emissions and consumption levels in the apparel sector for three typical wool commission dyehouses and one spinning and dyeing mill (TFI 4). Companies belonging to this category tend to differentiate their production and to process more than one make-up, which means that comparisons are not straightforward. All four mills assessed in the table treat mainly tops, but TFI 1, TFI 3 and TFI 4 dye also a variable percentage of yarn (both in package and hank form), whereas TFI 2 treats only tops and loose fibre.

Figures for specific water consumption partly reflect the predominant processed make-up. TFI 4 shows very high water consumption levels. Various factors may reasonably explain this value. First of all, compared to the other sites, this mill treats almost half of the material in hank form (which requires higher liquor ratios). Secondly (like TFI 3) it also has a high production of shrink-resist treatment, which entails an additional step in the production sequence. The fact that this company is an integrated mill producing its own high-quality yarn and a premium product (at a premium price) may also explain why they appear to take a more relaxed view of the cost-savings to be had from reducing water consumption.

As already stated, both TFI 3 and TFI 4 have high production on shrink-resist treatment. The higher specific COD shows this difference with respect to the other two mills. More representative, however, would be the level of AOX in the discharged waste water. High levels of AOX are typical of effluents from wool shrink-treatment, but data for this parameter were not made available.

TFI 2 has a very high production on chrome dyeing, which is confirmed by the higher emission factor for chromium (124 g/kg).

	TFI 1	TFI 2	TFI 3	TFI 4
Production	Tops 64 % Hank 16 % Package 20 %	Tops 80 % Floc 20 %	Tops 92 % Hank 4 % Package 4 %	Tops 52 % Hank 41 % Package 7 %
Process input				
Specific water consumption (l/kg)	39.9	43.6	35.6	180
Electrical energy (kWh/kg)	0.6	0.7	0.5	1.1
Thermal energy (MJ/kg)	12.3	11.4	28	26.5
Dyes (g/kg)	15	36.2	12.2	26.6
Auxiliaries (g/kg)	9.4	23.9	111.2	142
Basic chemicals (g/kg)	48.5	86.9	285.6	147
Emissions to water ⁽¹⁾				
COD E-Fac (g/kg)	29	22	46	65
BOD ₅ E-Fac (g/kg)				
Cu E-Fac (mg/kg)	<2	<2	<2	<2
Cr E-Fac (mg/kg)	70	124	64	36
Ni E-Fac (mg/kg)	<2	<2	<2	<2
Zn E-Fac (mg/kg)	12	52	36	54
Waste				
Solid wastes (g/kg)	11	21	15	
Sludge (g/kg) ⁽²⁾	8	9	24	172
Lubricant oils (g/kg)	0.04	0.09		
Source [193, CRAB, 2001]				
Notes:				
Blank cells mean that relevant information is not available				
(1) Data are measured in homogenisation tank before on-site treatment				
(2) after on-site waste water treatment				

Table 3.10: Overview of consumption and emission levels from four mills finishing WO tops/yarn

3.3.1.3 Mills finishing yarn: mainly CO

Table 3.11 contains the concentration values and emission factors of four mills that finish yarn consisting mainly of cotton. Specific water flows are between 100 and 215 l/kg. These values

are confirmed by “FhG-ISI, 1997” reporting lower and higher values (68, 73, 78, 83, 120, 128, 149, 181, 271 l/kg). In this respect, the high value of 271 l/kg (from a small mill processing less than 0.5 t/d) has to be closely questioned. The high specific water flow reported for TFI 4 corresponds to a company that dyes a high percentage of material in hank form. The site is also reported to not fully recover cooling water (when leakage occurs from the process water, the cooling water has to be sent to the waste water treatment plant). This probably explains the high figure reported in the table.

		TFI 1 (1)	TFI 2 (1)	TFI 3 (1)	TFI 4 (2)
specific Q _{ww} (l/kg)		105	108	120	215
COD	Conc. (mg O ₂ /l)	690	632	805	365
	E-Fac (g/kg)	73	69	97	78
BOD ₅	Conc. (mg O ₂ /l)	260	160	200	98 ⁽³⁾
	E-Fac (g/kg)	27	17	24	21
AOX	Conc. (mg Cl/l)			0.36	
	E-Fac (g/kg)			0.04	
HC	Conc. (mg/l)	<0.5	1.2		
	E-Fac (g/kg)	<0.05	0.1		
PH				9.8	
L(mS/cm)		7	6.2		
T(°C)		27.3	33.5		
NH ₄	Conc. (mg/l)			0.6	
	E-Fac (g/kg)			0.07	
org.N	Conc. (mg/l)			11.1	
	E-Fac (g/kg)			1.3	
Tot.N	Conc. (mg/l)				10.1
	E-Fac (g/kg)				2.2
Tot.P	Conc. (mg/l)				2.1
	E-Fac (g/kg)				0.45
Cu	Conc. (mg/l)	0.19	0.12	0.13	0.1
	E-Fac (mg/kg)	20	13	16	21.5
Cr	Conc. (mg/l)		<0.05		0.02
	E-Fac (mg/kg)		<6		4.3
Ni	Conc. (mg/l)	0.32	<0.1		
	E-Fac (mg/kg)	34	<11		
Zn	Conc. (mg/l)				0.2
	E-Fac (mg/kg)				43
Source: (1) [179, UBA, 2001]; (2) [200, Sweden, 2001]					
Notes:					
Blank cells mean that relevant information is not available					
⁽³⁾ reported data refer to BOD ₇					

Table 3.11: Concentration values and textile substrate specific emission factors for waste water from four mills mainly finishing yarns consisting of CO

It is interesting to note the differences in COD emission factors associated with the patterns of dyestuffs usage. Mills like TF1 and TF2, dyeing mainly with reactive dyes, show a significantly lower COD (about 70 g/kg) compared to TF3 which uses predominantly vat dyes (nearly 100 g/kg). The higher COD emission factor from dyeing with vat colourants is partly explained by the use of additional textile auxiliaries, such as dispersing agents in the vat dyeing process. Also, since some reactive dyestuff-chromophores absorb 2 - 3 times more light per molecule than the corresponding vat dyestuffs, COD for vat dyeing may be higher because a higher amount of dyestuff is required to achieve the same depth of shade compared to reactive dyestuffs.

The applied chemicals are grouped as dyestuffs, textile auxiliaries and basic chemicals. Typical values (albeit based on limited data) are:

- dyestuffs: ~25 (g/kg textile substrate)
- textile auxiliaries: ~70 (g/kg textile substrate)
- basic chemicals: ~400 (g/kg textile substrate)

Note that for companies dyeing mainly with reactive colourants the consumption of basic chemicals can be higher because of the high neutral salt input.

The total specific energy consumption is about 11 kWh/kg, where the consumption of electricity is about 2 kWh/kg.

3.3.1.4 Mills finishing yarn: mainly PES

Table 3.12 contains the concentration values and emission factors for waste water for eight mills mainly finishing polyester yarn.

	TFI 1 (1)	TFI 2 (1)	TFI 3 (1)	TFI 4 (1)	TFI 5 (2)	TFI 6 (3)	TFI 7 (5)	TFI 8 (6)
Specific Qww (l/kg)	125	65	66	148	75	64	102	171
COD Conc. (mg O ₂ /l)	870	1917	1520	655		1320	1140	2280
E-Fac (g/kg)	109	125	100	97	83	85	116	390
BOD ₅ Conc. (mg O ₂ /l)	139		380	169		562	588	910
E-Fac (g/kg)	17		25	25		36	60	156
AOX Conc. (mg Cl/l)	0.7	1.26	0.45	0.65				
E-Fac (g/kg)	0.09	0.08	0.03	0.10				
HC Conc. (mg/l)		19						
E-Fac (g/kg)		1.24			15			
pH	8.2		7.7	8.6		7.7	7.7	7.5
L (mS/cm)	1.9		5	3				
T (°C)	24	26	44	35				
NH ₄ Conc. (mg/l)	31.2		8.2	7.6		43	16	
E-Fac (g/kg)	3.9		0.54	1.12		2.77	1.63	
org. N Conc. (mg/l)	13		17.3	9.5				
E-Fac (g/kg)	1.63		1.14	1.41				
Total N Conc. (mg/l)						101	44	
E-Fac (g/kg)						6.5	4.5	
Tot phosphorous (mg/l)								
E-Fac (g/kg)								
Cu Conc. (mg/l)				0.05				
E-Fac (mg/kg)				7.4	2			
Cr Conc. (mg/l)								
E-Fac (mg/kg)					7			
Ni Conc. (mg/l)								
E-Fac (mg/kg)					2			
Zn Conc. (mg/l)								
E-Fac (mg/kg)					22			

Source: (1) [179, UBA, 2001] (from TFI 1 to TFI 4 corresponding to sites 1 to 4 respectively); (2) [193, CRAB, 2001] (corresponding to Site 4); (3) [198, TOWEFO, 2001] (corresponding to Site I 19); (4) [198, TOWEFO, 2001] (corresponding to Site I 08); (5) [199, Italy, 2001] (corresponding to Site 1)

Notes:
Blank cells mean that relevant information is not available

Table 3.12: Concentration values and textile substrate specific emission factors for waste water from eight mills mainly finishing yarns consisting of PES

Apart from TFI 8, the reported specific water flows vary between ca. 65 and 148 l/kg. They are confirmed by "FhG-ISI, 1997" reporting for three similar mills 63, 86 and 122 l/kg. The figures are in the same range as mills finishing cotton yarn.

The upper value in the range (148 l/kg) is for a mill also processing yarn in hank form (this is normally associated with higher consumption of water due to higher liquor ratios). The higher water consumption is also justified by the fact that this company also treats some cotton yarn which is mercerised and dyed with azoic (development) dyestuffs, both operations requiring relatively high amounts of water.

The finishers of PES yarn generally have higher COD emission factors (97 - 125 g/kg) than the corresponding finishers processing cotton. This is mainly attributable to two different factors:

- the use of disperse dyes
- the removal of preparation agents present on the incoming fibre.

Concerning the first factor, the use of disperse dyes involves relevant emissions of dispersing agents (see Sections 2.7.6.2 and 8.6.3). These auxiliaries (usually naphthalene sulphonates-formaldehyde condensates and lignine sulphonates), besides contributing to the increase of the COD load of the final effluent, are water-soluble and hardly biodegradable.

Regarding the preparation agents, it has already been mentioned in Section 2.6.4 that they are applied during fibre and yarn manufacturing, but they need to be removed before dyeing. The formulations applied may still have a significant content of refined mineral. The amount of mineral oils, which is defined with the parameter "hydrocarbons" (HC), was measured in only two companies. On inspection of the HC emission factor reported for TFI 2 (1.2g/kg, corresponding to a COD of 3g/kg), the contribution of mineral oils to the overall COD load does not seem to be significant. However, the reported value is to be closely questioned. If a typical load-on of 20g/kg for preparation agents is considered, with an average COD content of 3000 mg/g of product, assuming 90 % removal from the fibre, a COD of about 50g/kg or more coming from the preparation agents would be expected in the waste water (see also Section 8.2).

The applied chemicals are grouped as dyestuffs, textile auxiliaries and basic chemicals. Typical ranges (albeit based on limited data) are:

- dyestuffs: 18 - 36 (g/kg textile substrate)
- textile auxiliaries: 80 - 130 (g/kg textile substrate)
- basic chemicals: 95 - 125 (g/kg textile substrate)

When high amounts of softening agents are applied, the consumption of textile auxiliaries can be up to 175 g/kg.

The total specific energy consumption is in the range of 11 - 18 kWh/kg. The higher value applies to companies which also have spinning, twisting and coning sections. The consumption of electricity is about 1 - 2 kWh/kg.

3.3.1.5 Mills finishing yarn: mainly WO, PAC and/or CV

Table 3.13 contains data for emissions to water for seven mills finishing yarn consisting mainly of wool and PAC blends along with some viscose in blend with wool and acrylic fibre.

	TFI 1 (1)	TFI 2 (1)	TFI 3 (1)	TFI 4 (1)	TFI 5 (1)	TFI 6 (2)	TFI 7 (2)
Specific Q _{ww} (l/kg)	120	212	167	66	74	43	95
COD Conc. (mg O ₂ /l)	590	480	584	782	1023		
E-Fac (g/kg)	70.8	102	97.5	51.6	75.7	35	47
BOD ₅ Conc. (mg O ₂ /l)	190	170	265	355	220		
E-Fac (g/kg)	22.8	36	44.2	23.4	16.3		
AOX Conc. (mg Cl/l)		0.4	0.76		0.17		
E-Fac (g/kg)		0.08	0.13		0.01		
HC Conc. (mg/l)							
E-Fac (g/kg)							
pH		7.7	6.9	7.3	6.8		
L (mS/cm)			4.4				
T (°C)			41				
NH ₄ Conc. (mg/l)		4.6					
E-Fac (g/kg)		0.98					
org. N conc. (mg/l)		11.2	16.6		22.8		
E-Fac (g/kg)		2.37	2.77		1.69		
Total N Conc. (mg/l)							
E-Fac (g/kg)							
Cu Conc. (mg/l)		0.02	<0.01				
E-Fac (mg/kg)		4.2	1.7			<2	<2
Cr Conc. (mg/l)		0.03	<0.1	0.38	1.2		
E-Fac (mg/kg)		6.4	16.7	25.1	88.8	34	28
Ni Conc. (mg/l)			<0.1		0.01		
E-Fac (mg/kg)			16.7		0.7	<2	<2
Zn Conc. (mg/l)			0.63		0.47		
E-Fac (mg/kg)			105.2		34.8	39	10
Source: (1) [179, UBA, 2001] (from TFI 1 to TFI 5 corresponding to site 1 to 5 respectively)							
(2) [193, CRAB, 2001] (from TFI 6 to TFI 7 corresponding to site 1 and site 3 respectively)							
Notes:							
Blank cells mean that relevant information is not available							

Table 3.13: Concentration values and textile substrate specific emission factors for waste water from seven mills mainly finishing yarns consisting of WO/PAC/CV

Specific water flow may vary widely (ranges between 43 and 212 l/kg have been observed). Various factors influence the water consumption and therefore the waste water flow of a mill. The age of the equipment is one factor, but the make-up of the yarn is also to be taken into account (hanks involve considerably higher consumption of water than cones). For example, TFI 6, which process 100 % yarn in package has a lower specific waste water flow compared to TFI 7, where 10 % of the production is dyed in hank form.

COD emission factors are similar to mills finishing cotton yarn. All parameters are quite similar to the other categories except for chromium, which is encountered in the effluent in significantly higher amounts. This is due to the use of metal-complex and chrome dyes, the latter involving the use of potassium or sodium dichromate. Chromium emissions may vary widely depending on the amount of wool processed and the dyeing method applied. In the case of companies with a high percentage of wool among the other fibres, emissions factors up to 100 mg/kg (89 mg/kg in TFI 5) are observed.

The applied chemicals are grouped as dyestuffs, textile auxiliaries and basic chemicals. Typical ranges (albeit based on limited data) are:

- dyestuffs: 13 – 18 (g/kg textile substrate)
- textile auxiliaries: 36 – 90 (g/kg textile substrate)
- basic chemicals: 85 - 325 (g/kg textile substrate)

The total specific energy consumption is in the range of 4 - 17 kWh/kg. The higher value is for finishing mills that also have spinning, twisting and coning sections. Of the overall energy consumption the actual consumption of electricity is about 0.9 - 6.5 kWh/kg, the higher value relating to mills with the above-mentioned additional processes.

3.3.1.6 Analysis of some relevant specific processes for mills finishing yarn and/ or floc

The main environmental concerns for yarn finishing mills arise from emissions to water, while air emissions are not significant.

It is interesting to show the wide variability of the characteristics (particularly in concentration) of the different baths involved in a typical dyeing process. This is put in evidence by showing the behaviour of five different parameters, namely COD, pH, conductivity, temperature and colour (determination of adsorption coefficients at wavelengths 435, 500 and 620 nm) in three different typical dyeing processes:

- exhaust dyeing of CV yarn on cones (L.R. 1:8 - 1:12) with reactive dyestuffs (Table 3.14)
- exhaust dyeing of PES yarn on cones (L.R. 1:8 - 1:12) with disperse dyestuffs (Table 3.15)
- exhaust dyeing of CO yarn on cones (L.R. 1:8 - 1:12) with vat dyestuffs (Table 3.16).

No of bath	Name of bath	COD (mg O ₂ /l)	pH	Conductivity (mS/cm)	Temperature (°C)	SAC 435 nm (1/m)	SAC 500 nm (1/m)	SAC 620 nm (1/m)
1	Exhausted dye bath	3170	10.2	35.1	48	27	13	2
2	Rinsing bath	550	10.1	11.7	42	14	10	3
3	Neutralisation bath	1220	4.4	3.8	44	4	4	1
4	Soaping bath	4410	6.2	2.4	57	16	11	4
5	Rinsing bath	1040	7.1	0.9	59	7	5	3
6	Rinsing bath	320	7.3	0.5	60	10	8	5
7	Rinsing bath	190	7.4	0.3	49	7	6	4
8	Conditioning bath (softening)	790	4.4	0.6	35	0	0	0

Source: [179, UBA, 2001]

Table 3.14: Sequence of discharged baths from exhaust dyeing of CV yarn with reactive dyestuffs along with values for COD, pH, conductivity, temperature and colour (spectral absorption coefficients, SAC)

No of bath	Name of bath	COD (mg O ₂ /l)	pH	Conductivity (mS/cm)	Temperature (°C)	SAC 435 nm (1/m)	SAC 500 nm (1/m)	SAC 620 nm (1/m)
1	Pretreatment bath	610	7.4	20	134	3.9	2.7	1.4
2	Exhausted dye bath	10320	5.0	3.4	130	290	375	125
3	Rinsing bath	1310	7.2	0.6	85	51	78	8.6
4	Reductive after-treatment	3610	9.5	6.1	89	18	11	6.3
5	Rinsing bath	615	9.2	1.4	84	6.3	4.2	2.7
6	Rinsing bath	140	8.6	0.5	66	0.9	0.7	0.3
7	Conditioning bath (softening)	2100	7.2	0.5	55	23.6	17.9	11.8

Source: [179, UBA, 2001]

Table 3.15: Sequence of discharged baths from exhaust dyeing of PES yarn with disperse dyestuffs along with values for COD, pH, conductivity, temperature and colour (spectral absorption coefficients, SAC)

No of bath	Name of bath	COD (mg O ₂ /l)	pH	Conduc- tivity (mS/cm)	Tempe- rature (°C)	SAC 435 nm (1/m)	SAC 500 nm (1/m)	SAC 620 nm (1/m)
1	Exhausted dye bath	14340	12.9	46	70	254	191	190
2	Overflow rinsing	6120	12.6	24	46	95	59	59
3	Rinsing	1900	12.2	12.7	34	9	8	7
4	Oxidation bath	4780	11.7	5.6	51	4	3	2
5	Rinsing bath	580	10.6	2	32	1	1	1
6	Soaping bath I	1510	10	2.3	55	4	4	5
7	Rinsing bath	230	9.3	1.5	36	2	2	2
8	Soaping bath II	860	10.1	3.4	74	4	3	2
9	Rinsing bath	47	8.9	1.2	37	1	1	1
10	Rinsing bath	27	8.5	1	31	0.5	0.5	0.4
11	Conditioning bath (softening)	1740	4.7	1.2	45	17	11	6

Source: [179, UBA, 2001]

Table 3.16: Sequence of discharged baths from exhaust dyeing of CO yarn with vat dyestuffs along with values for COD, pH, conductivity, temperature and colour (spectral absorption coefficients, SAC)

The examples reflect the typical sequences applied in exhaust dyeing of yarn with reactive, disperse and vat dyes. However, they should not be taken as fixed sequences, in the sense that they do not apply as such to any finishers of yarn. A finisher may need to apply, for example, additional rinsing baths, the yarn could be mercerised, the application of softening agents in the last bath could be avoided etc.

However, the examples show some key issues:

- first, it is significant (although maybe also obvious) to show how much the concentration values of the mixed final effluent (Table 3.9 - Table 3.13) can differ from the corresponding values reported in the tables above for the single baths. Thanks to a dilution effect, the global COD concentration levels are much lower for mixed effluents than the values for spent dyeing baths
- the spent dyeing baths are those that show the highest concentration levels in all three examples. However, the COD of the exhausted dye bath is significantly lower for reactive dyeing than for dyeing processes using disperse and vat dyes. As mentioned earlier in this chapter, the main reason is the application of dispersing agents which are needed to apply the water-insoluble disperse and vat dyestuffs
- operations like soaping and reductive aftertreatment, which are carried out in order to remove the unfixed dyestuff, are also associated with high values of COD as well as colour. In particular, for softening treatment, the high COD concentration is indicative of the poor exhaustion level typical of softening agents
- rinsing baths can have a very low concentration, 10 - 100 times lower than the exhausted dyeing bath. This shows the importance of optimising the rinsing process, for example by recycling low-concentration rinsing water.

Table 3.17 and Table 3.18 illustrate water and energy consumption figures observed in loose fibre and yarn (package) dyeing processes.

LOOSE FIBRE DYEING	Electricity	Thermal energy	Water for dyeing	Water for rinsing
Unit	kWh/kg	MJ/kg	l/kg	l/kg
WO (acid, chrome or metal-complex dyes)	0.1 - 0.4	4 - 14	8 – 15 ⁽¹⁾	8 - 16
PAC (cationic dyes)	0.1 - 0.4	4 - 14	4 – 12 ⁽¹⁾	4 - 16
PES (disperse dyes)	0.1 - 0.4	4 - 14	6 – 15 ⁽¹⁾	12 – 20 ⁽¹⁾
CO (direct, reactive dyes)	0.1 - 0.4	4 - 14	8 – 15 ⁽¹⁾	8 - 32
PA (direct, acid dyes)	0.1 - 0.4	4 - 14	6 – 15 ⁽¹⁾	6 - 12
Source: [77, EURATEX, 2000] except for (1), [280, Germany, 2002]				

Table 3.17: Water & energy consumption levels in loose fibre dyeing processes

YARN DYEING (on package)	Electricity	Thermal energy	Water for dyeing	Water for rinsing
Unit	kWh/kg	MJ/kg	l/kg	l/kg
WO/ PA (dye not specified)	0.8 - 1.1	13 - 16	15 – 30 ⁽¹⁾	30 – 50 ⁽¹⁾
PAC (dye not specified)	0.8 - 1.1	13 - 16	15 – 30 ⁽¹⁾	30 – 50 ⁽¹⁾
CO (direct dyes)	0.8 - 1.1	13 - 16	15 – 30 ⁽¹⁾	45 – 60 ⁽¹⁾
CO (reactive dyes)	0.8 - 1.1	13 - 16	15 – 30 ⁽¹⁾	60 ⁽²⁾
CO (sulphur dyes)	0.8 - 1.1	13 - 16	100 ⁽³⁾ – 150 ⁽¹⁾	
Source: [77, EURATEX, 2000] except for (1), [280, Germany, 2002]				
Notes:				
⁽²⁾ Water consumption for washing + rinsing				
⁽³⁾ Total water consumption				

Table 3.18: Water & energy consumption levels in yarn dyeing processes

3.3.2 Mills finishing knitted fabric

3.3.2.1 Mills finishing knitted fabric: mainly CO

Table 3.19 shows the data on waste water emissions from seventeen mills finishing knit fabric consisting mainly of cotton. These mills do not have a printing section.

The range of specific waste water flow is relatively small (60 – 136 l/kg), but there are two extreme exceptions at the lower and upper end of the range (see TFI 9 and TFI 17). TFI 9, with only 21 l/kg, performs scouring and bleaching only; in addition these operations are carried in continuous mode, which explains the very low specific waste water flow as well as the highest COD concentration in the final effluent. The reasons for the very high specific waste water flow of TFI 17 (216 l/kg) are reported to be the high quality requirements (more rinsing steps) and the high repairing rate.

The COD emission factors are within a surprisingly small range (70 – 85 g/kg), only TFI 9 carrying scouring and bleaching only has a lower value (48 g/kg). For TFI 10, 11 and 16, higher values are reported (107, 108 and 97 g/kg). The fact that these mills also process some

woven fabric may reasonably explain these higher figures. In addition TFI 10 finishes some polyester knit fabric, which also leads to higher COD emission factors. The processing of PES fibres is also the reason for the higher emission of hydrocarbons in the waste water (concentration > 20 mg/l). They come from the removal of preparation agents mainly containing mineral oils. Concentrations between 10 and 20 mg/l may also be observed in the case of mills finishing cotton only (e.g. from antifoaming agents based on mineral oils), but common values are below 10 mg/l. Heavy metals emissions are insignificant for all the seventeen mills analysed.

The applied chemicals are grouped as dyestuffs, textile auxiliaries and basic chemicals. Typical values (albeit based on limited data) are:

- dyestuffs: 18 (g/kg textile substrate)
- textile auxiliaries: 100 (g/kg textile substrate)
- basic chemicals: 570 (g/kg textile substrate)

The very high specific consumption of basic chemicals is due to the application of neutral salts (NaCl or Na₂SO₄) for reactive exhaust dyeing, which is about 400 g/kg.

The total specific energy consumption is in the range of 6 - 17 kWh/kg. The higher value relates to a site that also has spinning and coning sections. The consumption of electricity is 1 - 3 kWh/kg (data from 9 TFI).

	TFI 1	TFI 2	TFI 3	TFI 4	TFI 5	TFI 6	TFI 7	TFI 8	TFI 9	TFI 10	TFI 11	TFI 12	TFI 13	TFI 14	TFI 15	TFI 16	TFI 17
Specific Qww (l/kg)	67	60	101	67	78	79	120	77	21	71	133	75	88	136	87	96	216
COD Conc. (mg O ₂ /l)	1210	1340	748		931	954	673	1010	2281	1502	814	804	911	439	658	1004	390
E-Fac (g/kg)	81	80	76		73	75	81	78	48	107	108	60	80	60	57	96	84
BOD ₅ Conc. (mg O ₂ /l)	409	622	174	444	289	408	175	453	788	671	218		390	127	259	166	112
E-Fac (g/kg)	27.4	37.3	17.6	29.7	22.5	32.2	21	34.9	16.5	47.6	29.0		34.3	17.3	22.5	15.9	24.2
AOX Conc. (mg Cl/l)																0.3	0.21
E-Fac (g/kg)																0.03	0.05
HC Conc. (mg/l)	9.3	18.9	8.3	5	23.7	21.9	6.8	19.2	11.2	32	6.1	0.9	14.3	6.2	18.5		6.1
E-Fac (g/kg)	0.6	1.1	0.8	0.3	1.8	1.7	0.8	1.5	0.2	2.3	0.8	0.1	1.3				
pH																	
L (mS/cm)	3.5	4.4	6.5	4.6	10.1	4.7	8.1	2.9	2.7	3.8	2.26	6.3	6.1	5.1	11.1		
T (°C)	34	30	38	36	33.8	33	35	28.6	39	29.3	21	20	24	31	30		
NH ₄ Conc. (mg/l)																9	1
E-Fac (g/kg)																0.9	0.2
org. N Conc. (mg/l)															25	14.3	22
E-Fac (g/kg)															2.2	1.4	4.8
Cu Conc. (mg/l)	0.1	0.11	0.23	0.05	0.12	0.1	0.19	0.1		0.22	0.25		0.1	0.11	0.1		0.3
E-Fac (mg/kg)	7	7	23	3	9	8	23	8		16	33		9	15	9		65
Cr Conc. (mg/l)	0.1	0.1	0.05	0.05	0.1	0.1	0.05	0.1		0.2	0.05	0.1	0.1	0.1			
E-Fac (mg/kg)	7	6	5	3	8	8	6	8		14	7	8	9	14			
Ni Conc. (mg/l)																	
E-Fac (mg/kg)																	
Zn Conc. (mg/l)	0.2	0.33	0.37	0.1	0.2	0.14	0.1	0.2	0.37	0.26		0.1	0.12	0.12	0.2		0.3
E-Fac (mg/kg)	13	20	37	7	16	11	12	15	8	18		8	11	16	17		65

Source: [179, UBA, 2001]
Notes:
Blank cells mean that relevant information is not available

Table 3.19: Concentration values and textile substrate specific emission factors for waste water from seventeen mills mainly finishing knitted fabric consisting of cotton

3.3.2.2 Mills finishing knitted fabric: mainly CO with a significant printing section

Data for mills finishing cotton knitted fabric with a significant printing section are presented in Table 3.20. Most of the companies belonging to this category perform pigment printing.

In pigment printing, waste water is only emitted during cleaning-up operations (for drums, screens, etc.). This explains the very low specific waste water flow (usually far below 10 l/kg) typical of these mills. One exception is represented by TFI 6 which also uses reactive printing (for which afterwashing is required).

None of the companies analysed in the table, except for TFI 3, carries out pretreatment, but instead print on already pretreated knitted fabric. This is confirmed by the higher figures for waste water flow and organic load in the final effluent.

Information on chemical input and energy consumption was not made available.

	TFI 1	TFI 2	TFI 3	TFI 4	TFI 5	TFI 6	TFI 7	TFI 8	TFI 9	TFI 10	TFI 11	TFI 12
Specific Qww (l/kg)	6	15	42	1.1	0.4	35	0.4	2	0.9	2	2	3
COD Conc. (mg O ₂ /l)	233	391	170	296	376	17	1027	639	713	666	351	1196
E-Fac (g/kg)	1.4	6	7	0.3	0.2	0.6	0.4	1.3	0.6	1.3	0.7	3.3
BOD ₅ Conc. (mg O ₂ /l)			105									
E-Fac (g/kg)			4.4									
AOX Conc. (mg Cl/l)												
E-Fac (g/kg)												
HC Conc. (mg/l)	0.9	0.3	1.2	0.7	1	0.2	10.3	14.4		1.7	0.9	11.2
E-Fac (g/kg)	0.01	0.005	0.05	0.001	0.0004	0.01	0.004	0.03		0.003	0.002	0.03
pH												
L (mS/cm)	1.3	1	2.6	0.7	3	2.6	1.3	1.4	0.9	3.3	1.3	1.1
T (°C)	11.9	18.9	16.2	17.2	10.6	17.2	14.5	15.9	13.2	19	17.6	17
NH ₄ Conc. (mg/l)												
E-Fac (g/kg)												
org. N Conc. (mg/l)												
E-Fac (g/kg)												
Total N Conc. (mg/l)												
E-Fac (g/kg)												
Cu Conc. (mg/l)	<0.05	<0.1	<0.1	<0.1	<0.05	<0.1	0.1	0.6	0.07	<0.1	<0.1	<0.1
E-Fac (mg/kg)	0.30	1.50	4.20	0.11	0.02	3.50	0.04	1.20	0.06	0.20	0.20	0.30
Cr Conc. (mg/l)	<0.05	<0.1	<0.1	<0.1	<0.05	<0.1	<0.1		<0.1	<0.1	<0.1	<0.1
E-Fac (mg/kg)	0.3	1.5	4.2	0.1	0.02	3.5	0.04		0.1	0.2	0.2	0.3
Ni Conc. (mg/l)												
E-Fac (mg/kg)												
Zn Conc. (mg/l)	0.19	<0.1	0.3	<0.1	<0.1	<0.1	<0.1		<0.1	<0.1	0.3	0.2
E-Fac (mg/kg)	1	1.5	13	0.11	0.04	4	0.04		0.09	0.20	0.6	0.6
Source: [179, UBA, 2001]												
Notes:												
Blank cells mean that relevant information is not available												

Table 3.20: Concentration values and textile substrate specific emission factors for waste water from twelve mills finishing knitted fabric consisting mainly of CO with a significant printing section

3.3.2.3 Mills finishing knitted fabric: mainly synthetic fibres

According to data reported in Table 3.21 for thirteen mills in this category, there is considerable variability in the specific waste water flow (35 - 229 l/kg). Lower values are observed in installations using more advanced equipment (automated machines with low liquor ratio) and when a small number of finishing baths is required. Conversely the higher values are typical of companies having older machines where small batches are processed at non-optimal liquor ratios.

Due to the load of preparation agents, the emission of hydrocarbons is significantly higher compared to mills finishing mainly cotton fibres (see Table 3.19).

As with mills finishing mainly cotton, heavy metals emissions are not significant for this category.

COD emission factors vary between 65 and 150 g/kg. The lower COD figures are typical of mills finishing mainly polyamide. In particular, the composition of the emitted COD load for a mill finishing knit fabric consisting mainly of polyamide and polyamide/elastane blends is illustrated as an example in Figure 3.7. Data have been calculated using information reported in the safety data sheets and known/assumed retention factors (amount of chemical that remains on the fibre instead of being released to the waste water). Figures have been cross-checked with the measured COD concentrations and loads in the effluent.

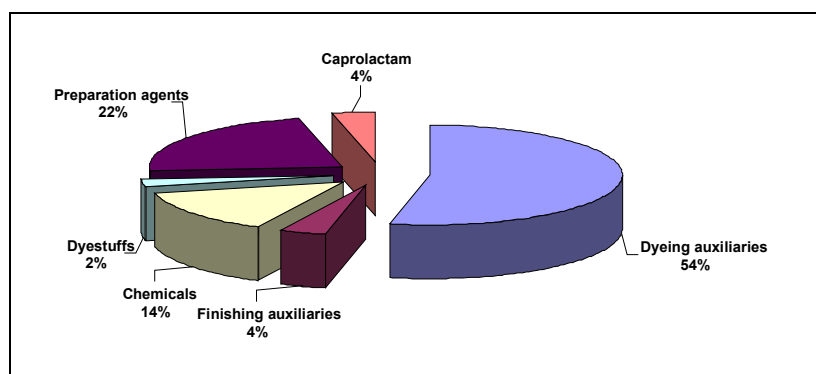


Figure 3.7: Example of composition of the COD load for a mill finishing knitted fabric consisting mainly of polyamide
[179, UBA, 2001]

As Figure 3.7 shows, dyeing auxiliaries and in particular levelling and washing agents, account for the highest share of the overall COD load. It is also interesting to notice the significant contribution of the preparation agents. In the given example, preparation agents are responsible for more than 20 % of total emitted COD load. This is in spite of thermofixation being carried out mainly on the greige fabric (preparation agents, based on mineral oil, evaporate to a significant extent during thermofixation and are therefore not found in the waste water). With polyamide 6, caprolactam is also present in waste water; in the presented example it represents 4 % of the total COD load.

The applied chemicals are grouped as dyestuffs, textile auxiliaries and basic chemicals. Typical ranges (albeit based on limited data) are:

- dyestuffs: 15 - 50 (g/kg textile substrate)
- textile auxiliaries: 45 - 150 (g/kg textile substrate)
- basic chemicals: 50 - 280 (g/kg textile substrate)

The ranges are rather wide, reflecting the variety of processes and process sequences. The total specific energy consumption is in the range of 3.5 - 17 kWh/kg. The consumption of electricity is 1.5 - 6 kWh/kg. The higher values correspond to mills also having spinning and knitting sections (data from three mills).

	TFI 1 (1)	TFI 2 (1)	TFI 3 (1)	TFI 4 (1)	TFI 5 (1)	TFI 6 (1)	TFI 7 (1)	TFI 8 (1)	TFI 9 (1)	TFI 10 (1)	TFI 11 (1)	TFI 12 (2)	TFI 13 (2)
Specific Qww (l/kg)	117	173	81	77	127	89	35	229	83	43	61	144	255
COD Conc. (mg O ₂ /l)	1003	379	1045	3590	911	890	2170	384	581	3480	1870	883	262
E-Fac (g/kg)	117	66	85	276	116	79	76	88	48	150	114	127	67
BOD ₅ Conc. (mg O ₂ /l)	271	184	384	855	242	246	252	95	132	590		326 ⁽³⁾	88 ⁽³⁾
E-Fac (g/kg)	31.7	31.8	31.1	65.8	30.7	21.9	8.8	21.8	11.0	25.4		47	22
AOX Conc. (mg Cl/l)				4.3	0.3	0.34				0.65	0.3		
E-Fac (g/kg)				0.3	0.04	0.03				0.03	0.02		
HC Conc. (mg/l)	60	4.9	57.1		26.9								
E-Fac (g/kg)	7	0.8	4.6		3.4								
pH						7.3		9.2		6	7.4		
L (mS/cm)	3.2	4.1	1	2.2		1.7		1.5	3.6	2.6	0.9		
T (°C)	29.3	29	39.8					36.8					
NH ₄ Conc. (mg/l)				2		6		18					
E-Fac (g/kg)				0.2		0.5		4.1					
org. N Conc. (mg/l)				15	16.5	18.2		12		15			
E-Fac (g/kg)				1.2	2.1	1.6		2.7		0.6			
Total N Conc. (mg/l)													4.7
E-Fac (g/kg)													1.2
Tot phosphorous (mg/l)												1.9	2.3
E-Fac (g/kg)												0.27	0.59
Cu Conc. (mg/l)	<0.05	0.06	0.09	0.09	<0.09			<0.1		<0.01	0.04	0.1	0.03
E-Fac (mg/kg)	6	10	7	7	11			23		0.43	2	14.4	8
Cr Conc. (mg/l)		<0.1	0.15	<0.05	0.14							0.03	0.03
E-Fac (mg/kg)		17	12	4	18							4.3	8
Ni Conc. (mg/l)								<0.1		<0.01	<0.02		
E-Fac (mg/kg)								23		0.4	1.2		
Zn Conc. (mg/l)	0.16	0.05	0.07							0.03	0.08	0.07	0.03
E-Fac (mg/kg)	19	9	6							1	5	10	8

Source: (1) [179, UBA, 2001] (from TFI 1 to TFI 11 corresponding to site 1 to 11 respectively) (2) [200, Sweden, 2001] (from TFI 12 to TFI 13 corresponding to sites B and G respectively)
Notes: Blank cells mean that relevant information is not available; ⁽³⁾ reported data refer to BOD₇

Table 3.21: Concentration values and textile substrate specific emission factors for waste water from mills finishing knitted fabric consisting mainly of synthetic fibres

3.3.2.4 Mills finishing knitted fabric: mainly wool

Data on waste water emissions and energy consumption have been made available for one mill only. The same applied to energy consumption. The precise process sequence is not known.

Table 3.22 contains the values for waste water emissions. Specific flow and other parameters do not indicate significant differences compared to mills finishing cotton or synthetic fibres.

Information on applied chemicals was not made available.

The specific energy consumption in the analysed company is very high (67 kWh/kg) whereas the specific consumption of electricity is 9.5 kWh/kg. This is because energy consumption for spinning, twisting, coning and knitting is included.

	TFI 1
Specific Qww (l/kg)	63
COD Conc. (mg O ₂ /l)	1470
E-Fac (g/kg)	93
BOD ₅ Conc. (mg O ₂ /l)	367
E-Fac (g/kg)	23.1
AOX Conc. (mg Cl/l)	0.3
E-Fac (g/kg)	0.02
HC Conc. (mg/l)	
E-Fac (g/kg)	
pH	6.8
L (mS/cm)	0.6
T (°C)	31.5
NH ₄ Conc. (mg/l)	9.5
E-Fac (g/kg)	
org. N Conc. (mg/l)	23.3
E-Fac (g/kg)	1.5
Cu Conc. (mg/l)	0.03
E-Fac (mg/kg)	2
Cr Conc. (mg/l)	0.09
E-Fac (mg/kg)	6
Ni Conc. (mg/l)	
E-Fac (mg/kg)	
Zn Conc. (mg/l)	0.5
E-Fac (mg/kg)	32
Source: [179, UBA, 2001]	
Notes:	
Blank cells mean that relevant information is not available	

Table 3.22: Concentration values and textile substrate specific emission factors for waste water from one mill finishing knitted fabric mainly consisting of wool

3.3.2.5 Analysis of some relevant specific processes for mills finishing knitted fabric

Process-specific information has been submitted on:

- heat-setting (Section 3.3.3.5.2)
- pretreatment of cotton knit fabric (continuous and discontinuous processes) (Section 3.3.2.5.1)
- pretreatment of knitted fabric consisting of synthetic fibres (very limited information available) (Section 3.3.2.5.2)
- exhaust dyeing of knitted fabric consisting of cotton and synthetic fibres (Section 3.3.2.5.3)

- printing (Section 3.3.3.5.5)
- finishing (Section 3.3.3.5.6)
- coating (Section 3.3.3.5.7).

3.3.2.5.1 Pretreatment of cotton knitted fabric

Pretreatment for cotton knitted fabric includes bleaching and washing. The intensity of bleaching mainly depends on the kind of cotton quality and the degree of whiteness to be achieved. For subsequent exhaust dyeing with dark shades a less intensive bleach process is sufficient (pre-bleach), whereas for pale shades and non-dyed products the degree of whiteness must be higher and consequently a more intensive bleaching treatment is required.

Continuous pretreatment of cotton knitted fabric

Continuous pretreatment is typical of larger installations. A process is described below for continuous bleaching/washing with hydrogen peroxide. It consists of the following steps:

- padding of the bleaching liquor with a pick-up of 130 %
- bleaching reaction in a steamer (30 min) with saturated steam at a temperature of 95 - 98 °C
- countercurrent rinsing
- padding of liquor containing complexing and washing agents followed by steaming (3 - 5 min with saturated steam)
- rinsing and drying (in the case of non-dyed finished products, softening agents are applied before drying)

A typical recipe is given below:

Recipe	(g/kg textile)	COD of the product (g O ₂ /kg product)	specific COD-input (g O ₂ /kg textile)	estim. spec. COD-output ⁽¹⁾ (g O ₂ /kg textile)
Padding liquor for bleaching				
NaOH(100 %)	8.2			
Wetting agent	6.0	1210	7.3	7.3
Complexing agents	4.4	270	1.2	1.2
Organic stabilisers	22.0	185	4.1	4.1
MgSO ₄	2.2			
H ₂ O ₂ (50 %)	66.0			
Optical brightener	5.0	760	3.8	1.14
Washing agent	1.5	2060	3.1	3.1
Second padding liquor				
Polyphosphate	1.1			
Washing agent	1.1	1780	2.0	2.0
			sum: 21.4	sum:18.84
Padding liquor in case of softening				
Softening agents	14.5	684	9.9	0.99
Acetic acid (60 %)	1.1	645	0.7	0.7
Source: [179, UBA, 2001]				
Notes:				
⁽¹⁾ COD output is estimated assuming that the wetting agents, complexing agents and organic stabilisers are released quantitatively to the waste water, whereas the optical brighteners and the softening agents remain on the fibre at a rate as high as 70 % and 90 %, respectively				

Table 3.23: Typical recipe for the continuous bleaching/washing of cotton knitted fabric

The specific COD-input can vary between 20 and 30 g/kg textile. This example is confirmed by the standard recipe reported in Chapter 11.

The specific water consumption and waste water flow from the whole process is about 30 l/kg (± 7 l/kg).

Typical values in the rinsing water from the first step are:

- COD: 4000 - 8500 mg/l
- Conductivity: 2.5 - 4.5 mS/cm
- pH: around 10.

Typical values in the rinsing water from the second step are:

- COD: 1000 - 3000 mg/l
- Conductivity: 0.5 - 1.2 mS/cm
- pH: around 8 - 10

As reported in Table 3.23, the COD-output-factor attributable to applied chemicals is estimated in about 20 g/kg textile (the wetting agents are the auxiliaries that contribute the most to the final COD in the waste water).

Measurements in total waste water showed COD output factors between 80 and 100 g/kg textile. The reason for this can be found in the additives (e.g. knitting oils) and the adjacent material present on the raw cotton knitted fabric, here 60 to 80 g/kg textile is attributable to these compounds. However, it should be noted that hydrogen peroxide has not been accounted for in the calculation (the COD_{Cr} method measures 0.45 g COD/g H₂O₂).

Data are available for a second process which consists of the following steps:

- padding of the demineralisation liquor with a pick-up of 130 % (inorganic and organic acids) with subsequent reaction at 40 °C and rinsing
- padding with the bleaching liquor (H₂O₂ as bleaching agent)
- bleaching reaction in a steamer with saturated steam at a temperature of about 97°C
- countercurrent rinsing
- addition of softening agents (if required).

The specific consumption of chemicals and the associated COD values are reported in Table 3.24. It is obvious that this process needs significant lower amount of water.

Specific input/output	Unit	Typical range
Consumption of inorganic chemicals	(g/kg textile)	37 - 41
Consumption of organic chemicals, as COD	(g O ₂ /kg textile)	29 - 35
Consumption of water	(l/kg textile)	14 - 19
Consumption of steam	(kg/kg textile)	1.1 - 1.6
Consumption of electricity	(kWh/kg textile)	62 - 79
COD-output in waste water caused by the applied chemicals ⁽¹⁾	(g O ₂ /kg textile)	16 - 20
Source: [179, UBA, 2001]		
Notes:		
⁽¹⁾ COD output is estimated assuming that the wetting agents, complexing agents and organic stabilisers are released quantitatively to the waste water, whereas the optical brighteners and the softening agents remain on the fibre at a rate as high as 70 % and 90 %, respectively		

Table 3.24: Consumption of chemicals and associated COD values for a continuous pretreatment process (bleaching/washing) of cotton knit fabric

Discontinuous pretreatment of cotton knitted fabric

For discontinuous bleaching/washing of cotton knitted fabric, Section 11 provides the standard recipes for bleaching with hydrogen peroxide (H_2O_2). Data for COD, pH and conductivity for exhausted bleaching bath and rinsing water for pre- and full-bleaching with H_2O_2 are reported in Table 3.25 (batch process). Thereby emission factors cannot be calculated because figures for waste water flow corresponding to the single batches were not made available. Only the overall specific waste water flow is known (30 - 50 l/kg, including rinsing).

Parameter	Pre-bleaching			Full-bleaching		
	Exhausted bleaching bath	Hot rinsing (15 min)	Cold rinsing (25 min)	Exhausted bleaching bath	Hot rinsing (15 min)	Cold rinsing (25 min)
pH	11.4 - 11.7	11.1 - 11.3	11.1 - 11.2	12.1 - 12.5	12.1 - 12.3	11.3 - 11.5
COD (mg O_2 /l)	5200 - 6500	4200 - 5400	800 - 1700	7800 - 8500	5700 - 6500	800 - 1200
Conductivity (mS/cm)	6.4 - 9.5	5 - 8	1.5 - 3.5	16 - 16.8	12 - 12.6	2.1 - 1.5
Source: [179, UBA, 2001]						

Table 3.25: Data for COD, pH and L for exhausted bleaching bath and rinsing water from pre- and full-bleaching with H_2O_2 of cotton knitted fabric; the specific waste water flow for the whole process including rinsing is 30 - 50 l/kg

For cotton knitted fabric a combination of sodium hypochlorite and hydrogen peroxide used to be widely applied. Since hypochlorite has been largely replaced by hydrogen peroxide this process is now less common. Information from 1992 shows values for the combined application of hypochlorite and peroxide and indicates the big difference of AOX in the waste water (Table 3.26). Thereby the AOX value in the exhausted H_2O_2 -bleaching bath (up to 6 mg Cl/l) derives from the fact that no rinsing is performed after hypochlorite bleaching and therefore the knitted fabric carries over the by-products from the previous bath to the peroxide bleaching bath.

Parameter	NaOCl-bleaching	H_2O_2 -bleaching	Rinsing
	Exhausted bleaching bath	Exhausted bleaching bath	
pH	9.3 - 10.2	10.5 - 11	8.2 - 8.3
COD (mg O_2 /l)	1500 - 1800	1500 - 1600	70 - 80
AOX (mg Cl/l)	90 - 100	3.5 - 6	0.2 - 0.3
Conductivity (mS/cm)	10.2 - 10.5	7.2 - 8	0.8 - 0.85
Source: [179, UBA, 2001] with reference to "ITV, 1992"			

Table 3.26: Data for COD, AOX, pH and conductivity for exhausted bleaching bath and rinsing water from combined bleaching of cotton knit fabric with NaOCl/ H_2O_2 (L.R. = 1:15) – "ITV, 1992"; the overall specific waste water flow (for the whole process including rinsing is 30 - 50 l/kg)

3.3.2.5.2 Pretreatment of knitted fabric consisting of synthetic fibres

The availability of specific data on the input/output of processes for the pretreatment of knit fabric consisting of synthetic fibres is limited. The components which are removed from the fibres along with quantities can be seen in Section 8.2. Using the information for specific water consumption and waste water flow, the concentration of COD and hydrocarbons can be reliably estimated. Bigger companies have continuous pretreatment processes (usually washing processes) with low specific water consumption resulting in high COD and hydrocarbon concentrations. In particular, for hydrocarbons, concentrations in the range of g/l-order are typical.

3.3.2.5.3 Exhaust dyeing of knitted fabric

Usually knitted fabric is dyed in batch (exhaust dyeing). In a few cases fabric is dyed in semi-continuous mode (generally by cold pad batch).

Exhaust dyeing of cotton knitted fabric

Table 3.27 presents typical input factors, distinguishing between light, medium and dark shades, (which influences primarily the specific input of dyestuffs and salt). The wide range reported in the table for liquor ratio is not because different types of machines have been considered (all data refer to machines with a liquor ratio of 1:8). It rather reflects a common situation that occurs when the machines are not fully loaded due to the need to treat small batches and they are operated at a non-optimal liquor ratio. A common feature of modern machines is that small batches can be dyed with approximately the same liquor ratio as for maximum load (see Section 4.6.19).

	Unit	light shade	medium shade	dark shade
Liquor ratio	1:8 - 1:25			
Dyestuff input	(g/kg textile)	0.5 - 4	5 - 30	30 - 80
Org. auxiliary input	(g/kg textile)	0 - 30	0 - 30	0 - 35
Salt input	(g/kg textile)	90 - 400	600 - 700	800 - 2000
Inorganic auxiliary	(g/kg textile)	50 - 250	30 - 150	30 - 150
Source: [179, UBA, 2001]				

Table 3.27: Typical input factors for exhaust dyeing of cotton knitted fabric with reactive dyestuffs

As concerns the characteristics of the discharged water, the following tables illustrate examples of some typical dyeing processes. Table 3.28 reports the data for each of the discharged baths from reactive dyeing of a light shade.

For light shades, less rinsing is normally required and soaping is not needed. COD values are very low, especially for rinsing water. Conversely, data presented in Table 3.29 for a dark shade dyeing sequence show significantly higher figures for COD, conductivity and colour. The values for exhaust dyeing with reactive dyestuffs at medium shade will be between these extreme cases.

No of bath	Name of bath	COD (mg O ₂ /l)	pH	Conductivity (mS/cm)	SAC 436 nm (1/m)	SAC 525 nm (1/m)	SAC 620 nm (1/m)
1	Exhausted dye bath	920	11	72	43	18	6
2	Rinsing bath	180	10.6	10	9	4	2
4	Rinsing bath	33	10	2.8	4	2	1
5	Rinsing bath	23	9	1	2	1	1
6	Rinsing bath	5	8.3	0.8	1	0.5	0.2

Source: [179, UBA, 2001]

Table 3.28: Sequence of discharged baths from exhaust dyeing (light shade) of cotton knitted fabric with reactive dyestuffs along with values for COD, pH, conductivity and colour (spectral absorption coefficients, SAC) L.R. = 1:25; specific water consumption for the whole process: 142 l/kg (including water consumed when loading the material and direct cooling after dyeing)

No of bath	Name of bath	COD (mg O ₂ /l)	pH	Conductivity (mS/cm)	SAC 435 nm (1/m)	SAC 500 nm (1/m)	SAC 620 nm (1/m)
1	Exhausted dye bath	3400	12.1	140	328	315	320
2	Rinsing bath	2980	11.8	55	325	298	308
3	Neutralisation bath	2530	4.5	25	309	220	246
4	Rinsing bath	1060	4.7	8.3	316	185	196
5	Rinsing bath	560	5.3	2.1	316	164	154
6	Soaping bath	450	6.7	0.8	321	177	132
7	Rinsing bath	150	7.0	0.5	205	94	61
8	Rinsing bath	76	7.6	0.4	63	27	17
9	Rinsing bath	50	7.6	0.4	29	13	7

Source: [179, UBA, 2001]

Table 3.29: Sequence of emitted baths from exhaust dyeing (dark shade) of cotton knit fabric with reactive dyestuffs along with values for COD, pH, conductivity and colour (spectral absorption coefficients, SAC) L.R. = 1:8.2; specific water consumption for the whole process: 71 l/kg

Two additional examples are presented below, one for dyeing with direct dyes (light shade) and one for dyeing with sulphur dyes (dark shade).

No of bath	Name of bath	COD (mg O ₂ /l)	AOX (mg Cl/l)	pH	Conductivity (mS/cm)	SAC 436m (1/m)	SAC 525m (1/m)	SAC 620 nm (1/m)
1	Exhausted dye bath	3000	1.5	10	9.1	50	28	19
2	Rinsing bath	160	0.18	8.2	1.2	8	3	2.8
3	Rinsing bath	50	0.07	7.4	0.6	0.3	0.02	0.02
4	Conditioning bath (softening)	900	0.2	4.8	0.8	13	9	7

Source: [179, UBA, 2001]

Table 3.30: Sequence of discharged baths from exhaust dyeing of cotton knitted fabric with direct dyestuffs (light shade) along with values for COD, AOX, pH, conductivity and colour (spectral absorption coefficients, SAC)

No of bath	Name of bath	COD (mg O ₂ /l)	AOX (mg Cl/l)	pH	Conductivity (mS/cm)	SAC 436nm (1/m)	SAC 525m (1/m)	SAC 620 nm (1/m)
1	Exhausted dye bath	4800	3.3	11.5	63	1100	1080	1130
2	Hot rinsing bath	600	0.4	10	3.2	8	8	9
3	Rinsing bath	36	0.03	8.2	0.62	0.5	0.3	0.3
4	Rinsing bath	25	0.04	8	0.34	0.3	0.1	0.2
5	Hot rinsing bath	580	0.3	8.3	1.3	3.5	3.2	3.3
6	Rinsing bath	30	0.04	7.4	0.52	0.1		0.1
7	Rinsing bath	25	0.04	7.4	0.5	0.1	0.02	0.03
8	Hot rinsing bath	390	0.25	8.2	1.5	2.8	2.6	3
9	Rinsing bath	24	0.03	7.6	0.52	0.1		0.08
10	Rinsing bath	12	0.04	7.7	0.5	0.2		0.08
11	Conditioning bath (softening)	2200	1.6	7.7	1.1	15	8	5

Source: [179, UBA, 2001]

Table 3.31: Sequence of discharged baths from exhaust dyeing of cotton knitted fabric with sulphur dyestuffs (dark shade) along with values for COD, AOX, pH, conductivity and colour (spectral absorption coefficients, SAC)

The tables above clearly indicate that high-, medium- and low-loaded baths are discharged from exhaust dyeing. This shows the importance of separating the different streams in order to allow recycling of the low-loaded baths and more effective treatment of the concentrates (see Sections 4.6.22 and 4.10.7 for more detailed information).

Exhaust dyeing of knitted fabric consisting of synthetic fibres

Table 3.32 shows a typical recipe for exhaust dyeing of PES knitted fabric including the application of a UV stabiliser for high light fastness. There are no analytical data available for this or for exhaust dyeing of other synthetic fibres.

	Input factor (g COD/kg textile)	Output factor to waste water (g COD/kg textile)
Liquor ratio	1: 10	
Exhaust dyeing		
Dyestuff input	1 - 100	0.5 - 50
Dispersing agent	6	5
Organic acid	n.d.	n.d.
Mixture of carriers ⁽¹⁾	23	11
UV absorber	19	4
Defoaming agent	17	16
Aftertreatment		
NaOH (50 %)		
Reducing agent	7	5
Sequestering agent	3	3
		Sum 45 - 95

Source: [179, UBA, 2001]

Notes:
⁽¹⁾ especially phthalic acid esters

Table 3.32: Typical input and calculated output factors for exhaust dyeing of PES knitted fabric with disperse dyestuffs

The conclusion from the reported data is that disperse dyeing causes COD emission factors significantly higher than, for example, reactive dyeing because of the dispersing agents (present in the dye formulation itself in percentages as high as 40 – 60 % of the weight of the product) and carriers.

3.3.3 Mills finishing woven fabric

3.3.3.1 Mills finishing woven fabric: mainly CO and CV

Table 3.33 presents the data for waste water emissions from seventeen mills finishing woven fabric consisting mainly of cotton. Most of these industries carry out pretreatment in continuous or semi-continuous mode. The same is true for dyeing, although some companies perform exhaust dyeing in combination with continuous dyeing or alone (which is the case for example in TFI 16).

Specific waste water flows vary widely, from 45 - 50 l/kg up to more than 200 or even, in two cases, more than 600 l/kg. These values are confirmed by “FhG-ISI, 1997”, reporting similar figures for 25 other mills, also reporting values as high as 240 and 265 l/kg and another very high value (415 l/kg).

Mills with specific waste water flows of about 50 l/kg (e.g. TFI 6 and TFI 9) are known to have more modern and more efficient washing machines than companies showing levels as high as 200 l/kg or more. Two sites in this survey (TFI 12 and TFI 16) show extremely high specific waste water flows (618 l/kg and 646 l/kg). In the case of TFI 12 the reason is to be found in the use of very old machines with poor washing efficiency. In the case of TFI 16 the high water consumption can probably be explained by the fact that on this site dyeing is carried out only in batch, a mode in which water consumption is normally higher than with continuous and semi-continuous dyeing techniques.

COD emission factors for finishers of woven fabric are considerably higher than for yarn or knitted fabric finishers (two to three times higher). This is mainly due to the removal of sizing agents which are present on woven fabrics up to 15 wt-%. The load of sizing agents on the fabric and therefore the COD emission factor vary strongly according to the type of fabric and quality of sizing agents applied. For example, TFI 5 treats light, open fabrics with a low load of sizing agents. In addition, this company only carries out pretreatment without dyeing the material (and the same is valid also for TFI 15), which explains the low emission factor. On the contrary, TFI 2 finishes woven fabric with a high load of sizing agents and therefore has a higher specific COD load (300 g/kg). Also mills finishing cotton frotté or fabrics consisting mainly of viscose have low factors.

It is interesting to see the variability of the COD/BOD₅ ratio, which can be considered an indicator of the biodegradability of the sizing agents applied. Synthetic sizing agents, such as carboxymethylcellulose (CMC), polyacrylates (PA) and polyvinyl alcohol (PVA) are all poorly biodegradable and CMC and PA, in particular, are non-biodegradable or only to a very low extent. Having said this, it can be inferred that companies such as TFI 1 and TFI 2 which have a COD/BOD₅ ratio of about 3:1 have a relatively high percentage of biodegradable sizing agents. Meanwhile TFI 3 and TFI 4 have about 5:1, which is indicative of the predominance of hardly- or non-biodegradable sizing agents.

Little further comment is needed on the high ammonia concentration of TFI 4, which is due to the printing section of this mill (this mill has not been categorised with mills having a significant printing section because the percentage of printed textile substrate is lower than 30 %). Furthermore a high AOX concentration and emission factor is observed for TFI 2, but no reasonable explanation is found for this.

Figure 3.8 shows as an example the composition of the COD load released to waste water by a mill finishing woven fabric consisting mainly of cotton. Data have been calculated using

information reported in the safety data sheets and known/assumed retention factors (amount of chemical that remains on the fibre instead of being released to the waste water). Figures have been cross-checked with the measured COD concentrations and loads in the effluent.

It is obvious that sizing agents and cotton impurities are the biggest contributors to the total COD load. In the example, the company uses sulphur and vat dyes predominantly. Because of the dispersing agents present in the applied formulations, the contribution of the dyes to the total COD is higher than when reactive dyes are mainly used.

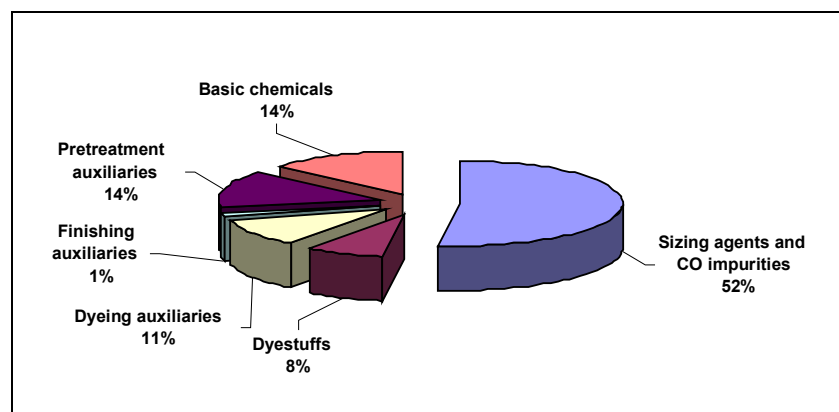


Figure 3.8: Composition of the COD load of a mill finishing woven fabric consisting mainly of cotton; semi-continuous and continuous dyeing is carried out with sulphur, vat and reactive dyestuffs

[179, UBA, 2001]

The applied chemicals are grouped as dyestuffs, textile auxiliaries and basic chemicals. Typical values (albeit based on limited data) are:

- dyestuffs: 10 - 20 (g/kg textile substrate)
- textile auxiliaries: 180 - 200 (g/kg textile substrate)
- basic chemicals: 200 - 250 (g/kg textile substrate)

The total specific energy consumption is in the range of 8 - 20 kWh/kg. The higher value is for mills also having spinning, twisting and coning sections. The consumption of electricity is about 0.5 - 1.5 kWh/kg (data from eight mills).

Information about the contribution of the different steps of the process to the overall energy consumption is limited. Two examples are available where energy consumption levels have been analysed in detail. These relate to the finishing of viscose fabric (Figure 3.9) and the finishing of woven fabric consisting of viscose/polyester blend (Figure 3.10).

The first example clearly indicates that high temperature processes such as thermal treatment in stenters and drying operations contribute most to the overall energy consumption. Electric energy is needed at all stages and there is no process that consumes significantly more than the others.

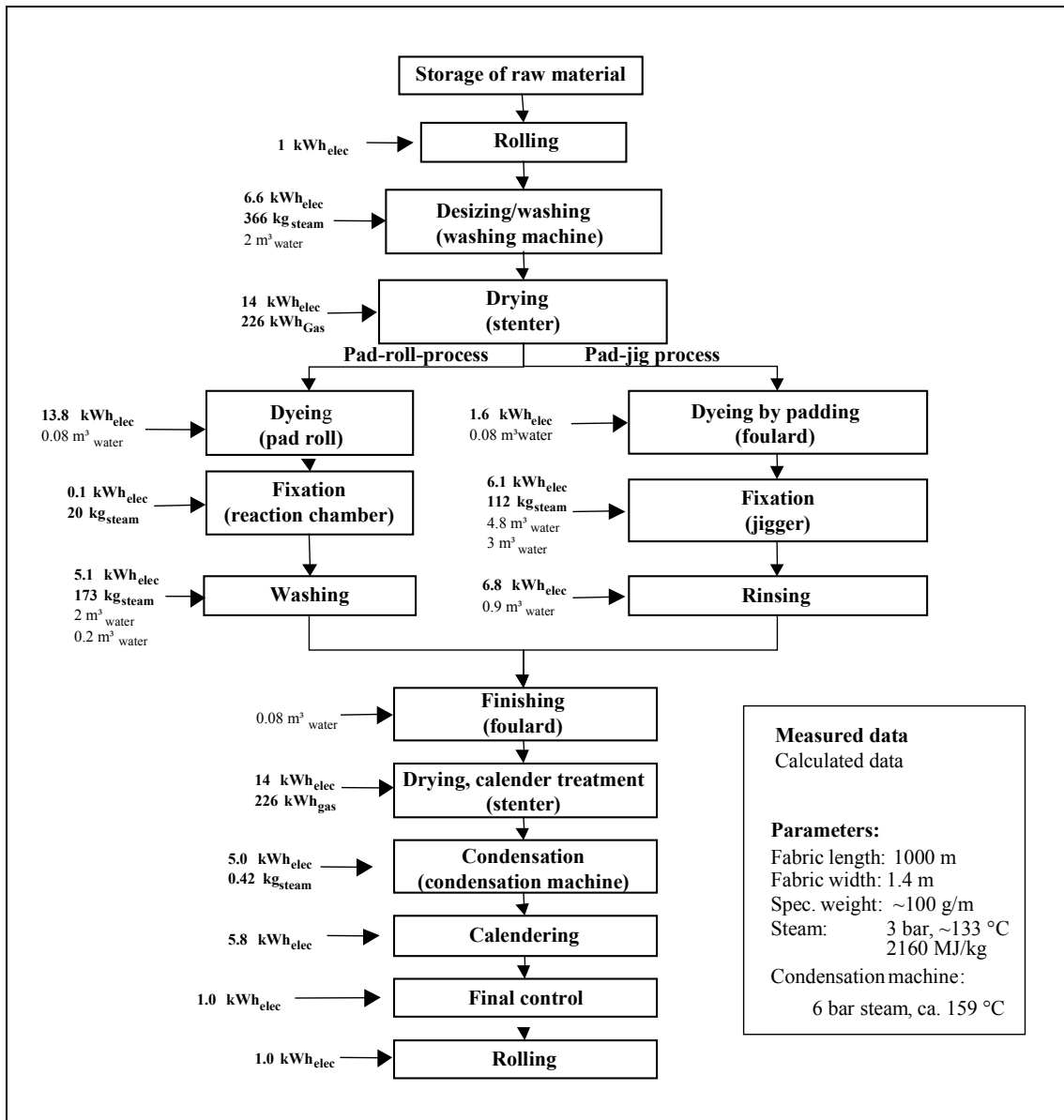


Figure 3.9: Analysis of thermal and electric energy consumption for the finishing of viscose fabric [179, UBA, 2001] with reference to “Eutech/ITA/LTT, 2000”

The second example shows that when HT dyeing is carried out, which is the case for polyester fibres, this process requires significant amounts of thermal energy and accounts for a considerable share of the total energy consumption.

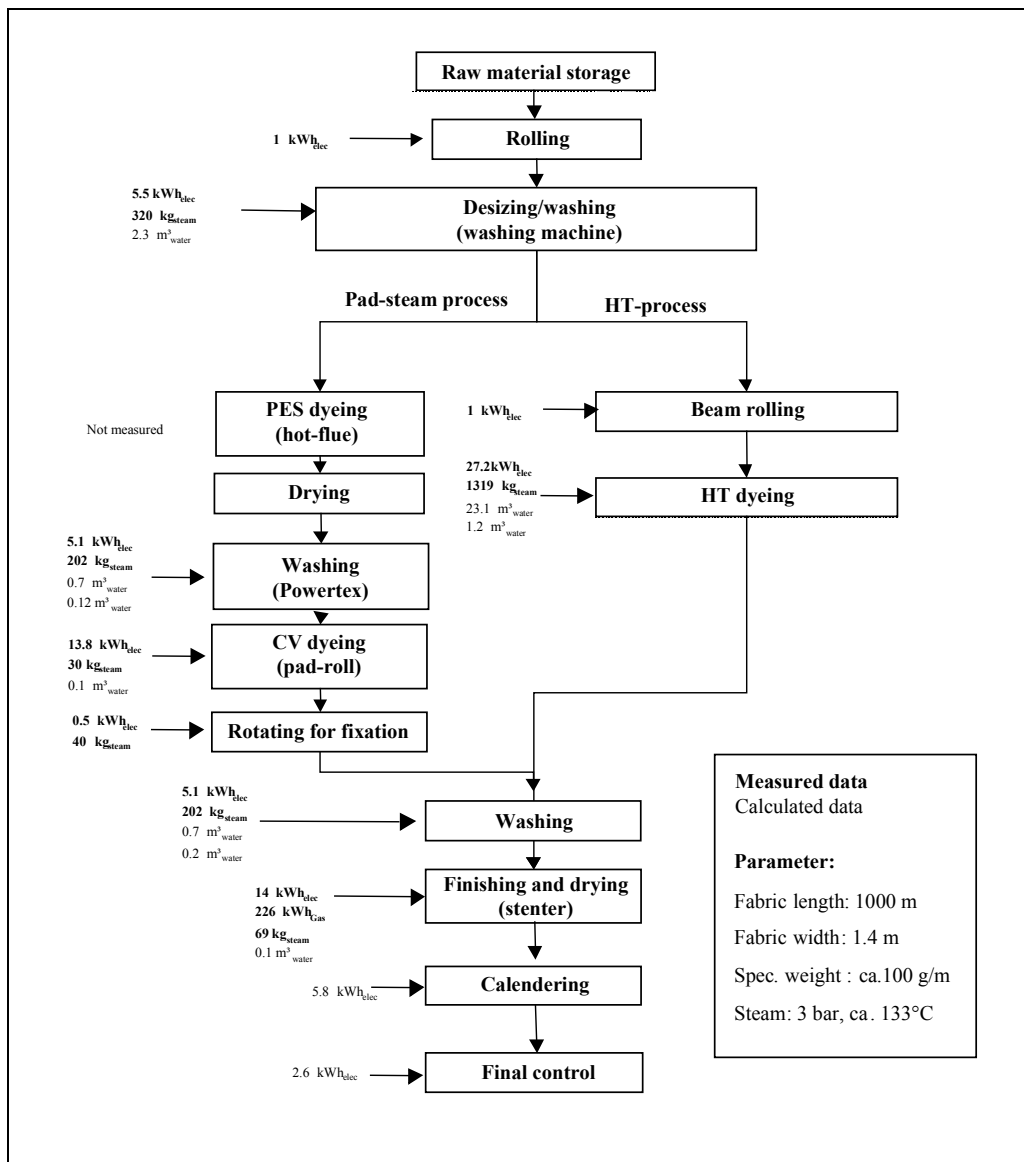


Figure 3.10: Analysis of thermal and electric energy consumption for the finishing of viscose/PES fabric
[179, UBA, 2001] with reference to “Eutech/ITA/LTT, 2000”

The basic conclusions drawn from these two examples may be transferable to the textile sector. These types of assessments unfortunately represent very rare examples in the textile industry. It is obvious, that only such detailed analysis will allow the identification of the processes most significant for minimising energy consumption.

	TFI 1 (1)	TFI 2 (1)	TFI 3 (1)	TFI 4 (1)	TFI 5 (1)	TFI 6 (1)	TFI 7 (1)	TFI 8 (1)	TFI 9 (1)	TFI 10 (1)	TFI 11 (1)	TFI 12 (1)	TFI 13 (2)	TFI 14 (2)	TFI 15 (2)	TFI 16 (2)	TFI 17 (3)
Specific Qww (l/kg)	182	83	211	99	52	56	132	93	45	150	93	618	71	99	21	645	107
COD Conc. (mg O ₂ /l)	822	3640	597	1210	824	2280	996	949	4600	672	1616	334	2000	1046	2782	467	1926
E-Fac (g/kg)	150	303	126	120	43	128	132	89	208	101	150	206	143	104	60	302	206
BOD ₅ Conc. (mg O ₂ /l)	249	1350	128	256	356	610	384		1760	307	367	66	900	197	1026	141	262 ⁽⁴⁾
E-Fac (g/kg)	45	113	27	25	19	34	51		79	46	34	41	64	20	22	91	28
AOX Conc. (mg Cl/l)	0.3	2.5	0.38	0.9		0.17			1.1	0.3	0.3	0.27					
E-Fac (g/kg)	0.05	0.21		0.09		0.01			0.05	0.04	0.028	0.17					
HC Conc. (mg/l)		7.5					3	3									
E-Fac (g/kg)		0.6					0.4	0.3									
pH	8.4		8.6	10.1		9.6				10.1		8.6	12	8.5	9	7.2	
L (mS/cm)	1.4	3.3	1.9			2.4	0.2	4.5		2.2		1.2					
T (°C)	25.8	44.5					20.4	34.1	33.7	41.9		30.9	40		35		
NH ₄ Conc. (mg/l)	4.6	3.1	7.9	48.3		14.3										2	
E-Fac (g/kg)	0.8	0.3	1.7	4.8		0.8										1.29	
org. N Conc. (mg/l)	16.7		15.6	158		56				25		16.5					
E-Fac (g/kg)	3		3.3	16		3.1				3.7		10.2					
Total N Conc. (mg/l)													40	12.32	75	11	19.7
E-Fac (g/kg)													2.86	1.22	1.61	7.11	2.11
Tot phosphorous (mg/l)													5	2.2	6		2.4
E-Fac (g/kg)													0.36	0.22	0.13		0.26
Cu Conc. (mg/l)	0.23	0.6	0.09	0.36		0.08	0.07	0.08	0.25	<0.01	0.13	0.12	0.10	0.12	0.05		0.22
E-Fac (mg/kg)	42	50	19	36		5	9	7.5	11	<1.5	12	74	7.1	11.9	1.0		23.5
Cr Conc. (mg/l)	0.09	0.05	0.02				0.1	0.07	0.006	<0.01	0.05	0.022	0.10	0.04	0.02		
E-Fac (mg/kg)	16	4	4				13	7	0.3	<1.5	5	14	7.1	4.0	0.5		
Ni Conc. (mg/l)									0.03		0.03		0.10	n.d	n.d		
E-Fac (mg/kg)									1		3		7.1				
Zn Conc. (mg/l)	0.24	0.18					0.16	0.3	0.18	<0.01		1.05	0.20	0.36	0.24		0.06
E-Fac (mg/kg)	44	15					21	28	8	<1.5		649	14.3	35.8	5.1		6.4
Sb Conc. (mg/l)																	0.11
E-Fac (mg/kg)																	22.7

Source: (1) [179, UBA, 2001] (from TFI 1 to TFI 12 corresponding to sites 1 to 12 respectively); (2) [198, TOWEFO, 2001] (from TFI 13 to TFI 16 corresponding to site B01, B02, BO6, I 12 respectively); (3) [200, Sweden, 2001] (TFI 17 corresponding to site C)

Notes: Blank cells mean that relevant information is not available; ⁽⁴⁾ reported data refer to BOD₇

Table 3.33: Concentration values and textile substrate specific emission factors for waste water from mills mainly finishing woven fabric consisting mainly of CO

3.3.3.2 Mills finishing woven fabric: mainly CO and CV, with a significant printing section

Table 3.34 presents the values of twelve cotton finishing mills each with a significant printing section (more than 30 % of the textile substrates are printed). In the twelve companies surveyed, printing with dyes is dominant in ten (TFI 1 to TFI 10, particularly reactive printing and etch printing). In the other two (TFI 11 and TFI 12) pigment printing is the larger part of the business. This influences water consumption levels, because higher amounts of water are needed in dye printing compared to pigment printing, and explains the relatively high specific waste water flow in comparison to all other categories of mills.

The specific waste water flow of the ten predominately dye-printers varies from 155 to 283 l/kg, except for TFI 4 which is not directly comparable (because it does not carry out pretreatment, but performs only printing and finishing on already pretreated fabric). The high figures for specific waste water flow are confirmed by "FhG-ISI, 1997" which reports for seven more mills values of 282, 288, 327, 450, 261, 189 and 302 l/kg.

COD emission factors are also high because, in addition to sizing agents, the high organic load from the printing section (cleaning of printing equipment and after-washing operations) has to be considered.

High ammonia concentrations and emission factors are also typical of dye-printing. This is due to the presence of urea and ammonia, especially in printing pastes (up to 150 g urea/kg printing paste). Urea hydrolyses to ammonia in waste water. Furthermore, concentrations and emission factors for copper are significantly higher compared to other kinds of mills because of the low fixation rates of copper-phthalocyanine-complex reactive dyestuffs. The higher AOX values are mainly attributable to vat and phthalocyanine dyes containing halogens (green shades).

The applied chemicals are grouped as dyestuffs, textile auxiliaries and basic chemicals. Typical values (albeit based on limited data) are:

- dyestuffs: 80 - 100 (g/kg textile substrate)
- textile auxiliaries: 180 - 200 (g/kg textile substrate)
- basic chemicals: 800 - 850 (g/kg textile substrate)

There are two main causes of the high specific consumption of dyestuffs. First, colouration is performed twice: for dyeing of the fabric and for printing. Second, many liquid dyestuff formulations are in use and, as already stated in the introduction, the water content is included for calculating the consumption factors.

The high specific consumption of basic chemicals is due to the high chemical demand of operations such as pretreatment and printing.

Energy consumption data have been made available for one company only. The total consumption for this site is 18.8 kWh/kg (2.3 kWh/kg for electricity, 16.5 kWh/kg as thermal energy).

	TFI 1 (1)	TFI 2 (1)	TFI 3 (1)	TFI 4 (1)	TFI 5 (1)	TFI 6 (1)	TFI 7 (2)	TFI 8 (2)	TFI 9 (2)	TFI 10 (2)	TFI 11 (3)	TFI 12 (3)
Specific Qww (l/kg)	264	155	229	139	255	283	207	284	295	283	175	143
COD Conc. (mg O ₂ /l)	1167	1265	859	819	570	760	640	961	513	607	1701	766
E-Fac (g/kg)	308	196	197	114	145	215	132	273	151	172	298	110
BOD ₅ Conc (mg O ₂ /l)	272	605	267	215	169	215	240	286	169	187	652 ⁽⁴⁾	191 ⁽⁴⁾
E-Fac (g/kg)	72	94	61	30	43	61	50	81	50	53	114	27
AOX Conc. (mg Cl/l)		0.4	1.3	2.4		1.7						
E-Fac (g/kg)		0.06	0.30	0.33		0.48						
HC Conc. (mg/l)	18.1											
E-Fac (g/kg)	4.78											
pH		9	9.1		9.3	9.6	7.8	7.9	8	8		
L (mS/cm)	1.4	2.8	2.8	2.5		1.3						
T (°C)	26	19	33.7									
NH ₄ Conc. (mg/l)			98	146	13.5	170	72	102	40	9		
E-Fac (g/kg)			22.44	20.29	3.44	48.11	14.91	29.02	11.81	2.55		
org. N conc. (mg/l)			24		156		19.5					
E-Fac (g/kg)			5.49		39.78		4.04					
Total N Conc. (mg/l)							92	108	46	28	39.5	29.9
E-Fac (g/kg)							19.05	30.72	13.58	7.93	6.91	4.28
Tot phosphorous (mg/l)											6.4	3.4
E-Fac (g/kg)											1.12	0.49
Cu Conc. (mg/l)	0.61	0.06	0.4			0.1					0.32	0.24
E-Fac (mg/kg)	161	9	92			28					56.0	34.3
Cr Conc. (mg/l)	0.1	0.02	0.08								0.02	0.01
E-Fac (mg/kg)	26	3	18								3.5	1.4
Ni Conc. (mg/l)		0.03				0.01						
E-Fac (mg/kg)		5				3						
Zn Conc. (mg/l)	0.22	0.15				0.15					0.24	0.06
E-Fac (mg/kg)	58	23				42					42.0	8.6
Sb Conc. (mg/l)												0.03
E-Fac (mg/kg)												3.3

Source: (1) [179, UBA, 2001] (from TFI 1 to TFI 6 corresponding to sites 1 to 6 respectively); (2) [198, TOWEFO, 2001] (from TFI 7 to TFI 10 corresponding to sites I 10, I 14, I 15, I 16 respectively) (3) [200, Sweden, 2001] (from TFI 11 to TFI 12 corresponding to sites D and E, respectively)

Notes: Blank cells mean that relevant information is not available; ⁽⁴⁾ reported data refer to BOD₇

Table 3.34: Concentration values and textile substrate specific emission factors for waste water from mills mainly finishing woven fabric consisting mainly of CO, with a significant printing section

3.3.3.3 Mills finishing woven fabric: mainly WO

The values for waste water emissions from six mills finishing fabric consisting mainly of wool are reported in Table 3.35. The specific waste water flow are usually higher than for mills finishing cellulosic fibres. The values quoted are confirmed by five values reported by “FhG-ISI, 1997” (133, 156, 253, 142 and 243 l/kg). Compared to the other kinds of mills, the emission factors for chromium can be noticeable (e.g. 54 and 71 mg/kg for TFI 1 and TFI 2) due to the application of after-chrome and metal-complex dyestuffs. Note also the high copper emission factor for TF5 (603 mg/kg). This comes from the fact that at the time when the data were collected, the company used to have copper pipelines in the heat recovery system. The mill has now replaced them with new pipelines in stainless steel.

	TFI 1 (1)	TFI 2 (1)	TFI 3 (2)	TFI 4 (2)	TFI 5 (3)	TF 6 (4)
Specific Q _{ww} (l/kg)	141	296	314	170	114	70
COD Conc. (mg O ₂ /l)	659	814			280	728
E-Fac (g/kg)	93	241	144	66	32	51
BOD ₅ Conc. (mg O ₂ /l)	227	308			60 ⁽⁵⁾	140
E-Fac (g/kg)	32	91			6.8	9.8
AOX Conc. (mg Cl/l)		0.31				
E-Fac (g/kg)		0.09				
HC Conc. (mg/l)	8.5					
E-Fac (g/kg)						
pH		7.1				
L (mS/cm)	1	1.9				
T (°C)	27	30				
NH ₄ Conc. (mg/l)						34
E-Fac (g/kg)						2.4
Org. N Conc. (mg/l)		22.7				
E-Fac (g/kg)		6.7				
Total N Conc. (mg/l)					55.2	
E-Fac (g/kg)					6.3	
Tot phosphorous (mg/l)					1.9	
E-Fac (g/kg)					0.22	
Cu Conc. (mg/l)	0.08	0.05			5.29	
E-Fac (mg/kg)	11	15	<8	<7	0.6	
Cr Conc. (mg/l)	0.38	0.24			0.04	0.25
E-Fac (mg/kg)	54	71	<8	16	5	17.5
Ni Conc. (mg/l)		0.05			0	
E-Fac (mg/kg)		15	<8	<7	0	
Zn Conc. (mg/l)	1.3	0.61			1.58	
E-Fac (mg/kg)	183	181	32	50	180	

Source: (1) [179, UBA, 2001] (TFI 1 to TFI 2 corresponding to sites 1 to 2 respectively) (2) [193, CRAB, 2001] (TFI 3 to TFI 4 corresponding to sites 1 and 2 respectively) (3) [200, Sweden, 2001] (TFI 5 corresponding to site I) (4) [31, Italy, 2000] (TFI 6 corresponding to site 1)

Notes:
Blank cells mean that relevant information is not available
⁽⁵⁾ reported data refer to BOD₇

Table 3.35: Concentration values and textile substrate specific emission factors for waste water from six mills finishing woven fabric consisting mainly of wool

The applied chemicals are grouped as dyestuffs, textile auxiliaries and basic chemicals. Typical ranges, albeit based on limited information (data from two mills) are:

- dyestuffs: 10 - 30 (g/kg textile substrate)
- textile auxiliaries: 140 - 160 (g/kg textile substrate)
- basic chemicals: 85 - 95 (g/kg textile substrate)

Also energy consumption data have been made available for two companies only. The total consumption ranges from 11 to 21 kWh/kg (0.5 - 0.8 kWh/kg for electricity, 10 - 20 kWh/kg for natural gas).

3.3.3.4 Mills finishing woven fabric: mainly synthetic fibres

Data on finishing of woven fabric consisting of synthetic fibres are presented in Table 3.36 for six mills. Figures vary according to the type of blend and the percentage of natural fibres (mainly cotton, flax and silk) often present in the blend.

Specific waste water flows are all above 100 l/kg, except for TFI 1 with only 7 l/kg. This mill, however, represents a particular situation not comparable with the other sites presented in this section. TFI 1 treats 100 % PA fibres and only carries out pretreatment in continuous modern washing machines for the removal of preparation and sizing agents.

As for the other companies, higher values for specific waste water flows can be explained partly by the equipment used and partly by considering that some companies process significant amounts of cellulosic fibres together with synthetic fibres (e.g. TFI 3 and TFI 5).

COD emission factors vary between 110 and 200 g/kg (one higher value, 286, only in TFI 2). In TFI 1 a lower value is reported (14 g/kg), but this is because no dyeing is carried out.

Figure 3.11 shows as an example the composition of the COD load of waste water from a mill finishing woven fabric consisting mainly of polyamide. It is evident that preparation agents account for a considerable share of the total COD load. Their removal requires relatively high amounts of washing and sequestering agents, which is confirmed by the high contribution of the pretreatment auxiliaries to the COD load. As for the relatively high COD load attributed to dyes, this is not due to the dyestuffs themselves, but to the levelling agents and dispersants present in dye formulations (especially in the case of disperse dyes, most often used for synthetic fibres).

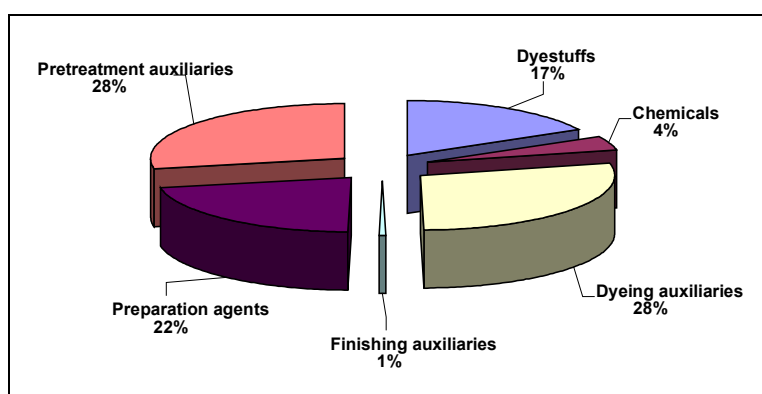


Figure 3.11: Composition of the COD load of a mill finishing woven fabric consisting of polyamide mainly

	TFI 1 (1)	TFI 2 (2)	TFI 3 (2)	TFI 4 (2)	TFI 5 (2)	TFI 6 (3)
Specific Qww (l/kg)	7	114	165	248	178	100
COD Conc. (mg O ₂ /l)	1950	2500	965	665	726	1254
E-Fac (g/kg)	14	286	160	165	129	125
BOD ₅ Conc. (mg O ₂ /l)	317		227	245	165	373
E-Fac (g/kg)	2		38	61	29	37
AOX Conc. (mg Cl/l)	0.13					
E-Fac (g/kg)	0.001					
pH	11		7	7.4	7.6	
L (mS/cm)	0.6					
T (°C)	32					
NH ₄ Conc. (mg/l)			1	9	12	
E-Fac (g/kg)			0.17	2.23		
org. N conc. (mg/l)						
E-Fac (g/kg)						
Total N Conc. (mg/l)			14	23	23	9
E-Fac (g/kg)			2.3	5.7		0.9
Total phosphorous (mg/l)						4.9
E-Fac (g/kg)						0.5
Cu Conc. (mg/l)						0.14
E-Fac (mg/kg)						14
Cr Conc. (mg/l)						0.06
E-Fac (mg/kg)						6
Ni Conc. (mg/l)						
E-Fac (mg/kg)						
Zn Conc. (mg/l)						0.06
E-Fac (mg/kg)						6
Source: (1) [179, UBA, 2001] (TFI 1 corresponding to site 1); (2) [198, TOWEFO, 2001] (from TFI 2 to TFI 5 corresponding to sites I 03, I 06, I 13, I 17 respectively); (3) [200, Sweden, 2001] (TFI 6 corresponding to site F)						
Notes: Blank cells mean that relevant information is not available.						

Table 3.36: Concentration values and textile substrate specific emission factors for waste water from six mills finishing woven fabric consisting mainly of synthetic fibres

3.3.3.5 Analysis of some relevant specific processes for mills finishing woven fabric

Process-specific information has been submitted on:

- singeing
- heat-setting
- continuous pretreatment of woven fabric
- continuous and semi-continuous dyeing
- printing
- finishing
- coating.

3.3.3.5.1 Singeing

The quality and quantity of air emissions in singeing depend strongly on:

- kind of substrate to be treated
- position of burners (angle and distance to the textile; one-sided or double-sided singeing)
- kind of emission abatement installed.

Main air emissions are:

- dust from the fibres burned-off
- organic-C from volatile substances on the substrate and/or crack-products and methane from incomplete combustion of burner gases
- formaldehyde from burner gases.

Emission levels from measurements carried out in five finishing mills are summarised in Table 3.37 [179, UBA, 2001].

Textile company	Sampling point	Installed emission abatement	Substrate	Concentration Organic-C (mg C/Nm ³)	Concentration Organic-C ex methane (mg C/Nm ³)	Concentration formaldehyde (mg HCHO/Nm ³)	Dust (mg/Nm ³)	Air flow (Nm ³ /h)	Off-gas temp. (°C)	Process velocity
A	Pre-brushing + burner compartment	Pre-brushing + burner: aqueous scrubber; after-brushing: circulating air, fabric filter	CO	99	22	-	1.8 - 3.7	5900	28	60 - 100 m/min
B	Pre-brushing + burner compartment	Pre-brushing + burner: aqueous scrubber after-brushing: aqueous scrubber	PES/CO	82	< 1	-	0.3 - 0.4	3800	34	120 m/min
B	After-brushing compartment	Pre-brushing + burner: aqueous scrubber after-brushing: aqueous scrubber	PES/CO	-	-	-	0.1	5670	24	120 m/min
C	Pre-brushing + burner compartment	Pre-brushing + burner: aqueous scrubber; after-brushing: circulating air, fabric filter	CO	74	-	-	6.2	8200	32	100 - 120 m/min
D (process 1)	Burner compartment	After-brushing: aqueous scrubber	CO	-	-	0.9	< 0.1	4410	83	2160 kg textile/h
D (process 2)	Burner compartment	After-brushing: aqueous scrubber	PES/CO	-	-	1.9	< 0.1		83	1620 kg textile/h
D (process 2)	After-brushing compartment	After-brushing: aqueous scrubber	PES/CO	-	-	-	< 0.1		27	1620 kg textile/h
E	Burner compartment	After-brushing: aqueous scrubber	PES/EL	42.4	26.3	3.2	-	3190	118	1746 kg textile/h
E	After-brushing compartment	After-brushing: aqueous scrubber	PES/EL	-	-	-	6.6	2760	27	1746 kg textile/h

Source: [179, UBA, 2001]

Table 3.37: Data on emissions to air from singeing facilities in five textile finishing mills

The following general considerations apply to the reported data [179, UBA, 2001]:

- if an aqueous scrubber is used for emission abatement in the after-brushing compartment, dust emissions $< 0.1 \text{ mg/m}^3$ can be achieved, but concentrations up to 6 mg/Nm^3 can also be detected
- Organic-C concentration caused by the process itself (methane emissions not included) varies within a wide range (from 1 to 26 mg C/Nm^3). Formaldehyde emission from the burner is in a range of 1 to $3 \text{ mg substance/Nm}^3$.
- off-gas temperature depends on sampling point (burner or after-brushing) and whether an aqueous scrubber is installed or not.

Singeing can be a very odour intensive process. An odour value of 60000 OU/kg textile could be measured for an installation singeing cotton without emission abatement systems [179, UBA, 2001] Advanced air treatment for destruction of odorous substances and abatement of dust may be necessary (see also Section 4.10.9). Odour emissions are dealt with in more detail in Section 3.5.

3.3.3.5.2 Heat-setting

Table 3.38 shows the possible sources of air emissions arising from:

- thermal treatment of raw fabrics
- thermal treatment of fabrics which are prewashed in an efficient way.

Fibre	Impurities/by-products on the fabric	Pollutants in air emissions
Man-made fibres in general	Preparation agents	Mineral oils, fatty acid esters and their by-products and/or thermal decomposition compounds
Natural fibres in general	Preparation agents	See above
PU (elastane)	Fibre solvent Preparation agents	Dimethylacetamide Silicones
Aromatic polyamides	Fibre solvent	Dimethylacetamide
PAC	Fibre solvent	Dimethylformamide, Dimethylacetamide
PA 6	Monomer	Epsilon-Caprolactam
Source: [179, UBA, 2001]		

Table 3.38: Possible sources of air emissions during heat-setting of grey fabrics or inefficiently washed fabrics

Typical air emission levels from heat-setting (concentrations, emission factors and mass flows) are reported in Table 3.39 for a sample of finishing mills. Note that when emission abatement systems are installed, the values shown in the table will correspond to the resulting clean gas. In the case of directly heated stenters, the portion of Organic-C emission attributable to the fuel (methane, propane, butane) is mentioned separately and is not included in the data concerning the Organic-C emission values (concentrations, emission factors and mass flows).

The following general considerations apply to the reported data:

- heat setting of raw textiles causes significant off-gas load. If heat-setting of PA 6 is carried out, considerable amounts of caprolactam are emitted (see process 1.1 and 13.3).
- in the case of textiles which contain low-emission preparation agents, much lower emission levels are observed (see process 15.1 and 15.2)
- Organic-C emissions caused by unburned fuel are in a range of 0.1 g/kg textile up to > 5 g/kg textile in the case of poorly maintained burners
- formaldehyde emissions may originate not only from the auxiliaries applied, but also from the direct-heated stenters themselves, due to partial burn-out of the gas (methane, propane, butane). Concentration levels from stenters range from 0.1 to 60 mg/Nm³.

Textile company	Stenter technology Emission abatement	Process	Substrate	Process temperature (°C)	Emission factor (g C/kg textile)	Concentration (mg C/Nm ³)	Mass-flow (g C/h)	Machine based emission (g C/kg textile)	Remarks
1.1	Direct heated	Heat-setting (raw fabric)	PA 6	185	12	82	359	5.4	4.3 g/kg caprolactam
3.3	Direct heated Heat recovery, electrofiltration	Heat-setting (raw fabric)	PES/PAC	180	0.7	92	1260	0.1	
3.4	Direct heated Heat recovery, electrofiltration	Heat-setting (pre-washed fabric)	PES/PAC	180	0.9	77	1055	0.2	
4.3	Direct heated	Heat-setting (not raw fabric)	PES/WO/EL	165	0.2	14	130	1.6	0.08 g/kg formaldehyde
4.4	Direct heated	Heat-setting (carrier dyed fabric)	PES/WO/EL	165	6.5	460	4269	1.4	0.08 g/kg formaldehyde
10.2	Direct heated Aqueous scrubber	Heat-setting (not raw fabric)	PA 6.6/EL	190	1.5	38	427	0.1	
10.3	Direct heated Aqueous scrubber	Heat-setting (pre-washed fabric)	PA 6/EL	190	2.2	84	945	0.2	
10.4	Direct heated Aqueous scrubber	Heat-setting (not raw fabric)	PA/EL	190	2.6	71	1052	1.4	
11.1	Direct heated Aqueous scrubber, electrofiltration	Heat-setting (not raw fabric)	PES	150	1.2	24	507	0.5	
11.2	Direct heated Aqueous scrubber, electrofiltration	Heat-setting (pre-washed fabric)	PES	150	0.8	19	394	0.4	
13.1	Direct heated Condensation, electrofiltration	Heat-setting (not raw fabric)	PES	205	3.2	36	820	1.2	
13.2	Direct heated Condensation, electrofiltration	Heat-setting (not raw fabric)	PES/PAC	180	2.2	59	1350	0.5	

Textile company	Stenter technology Emission abatement	Process	Substrate	Process temperature (°C)	Emission factor (g C/kg textile)	Concentration (mg C/Nm ³)	Mass-flow (g C/h)	Machine based emission (g C/kg textile)	Remarks
13.3	Direct heated Condensation, electrofiltration	Heat-setting (not raw fabric)	PA 6	185	1.9	18	410	0.5	0.7 g/kg caprolactam
14.1	Direct heated	Heat-setting (not raw fabric)	CO/PES	200	1.1	95	697	0.1	
15.1	Direct heated Aqueous scrubber	Heat-setting (not raw fabric)	PES	190	0.8	65	689	0.2	Raw gas data considered
15.2	Direct heated Aqueous scrubber	Heat-setting (not raw fabric)	PES/CO	90	0.6	39	421	0.2	Raw gas data considered

Source: [179, UBA, 2001]

Table 3.39: Heat-setting: process specific emission data (measured values)

The substance-based emission factor for some of the most commonly applied preparation agents are reported in Table 2 (see Section 11.4). As better explained in Section 3.3.3.5.6, the substance-based emission factor is defined as the amount of organic and inorganic substances in grams that can be released at defined process conditions (curing time, curing temperature and type of substrate) from one kilogram of auxiliary.

3.3.3.5.3 Continuous pretreatment of woven fabric

Pretreatment of cellulosic woven fabric

For cotton, the most common processes are desizing, scouring and bleaching. Today, these processes are often combined.

The next figure illustrates a typical pretreatment process (desizing, scouring and bleaching), in the case of water-soluble sizing agents which can be easily removed with water only. The specific input for water, steam and chemicals in a modern continuous pretreatment line are presented in Table 3.40.

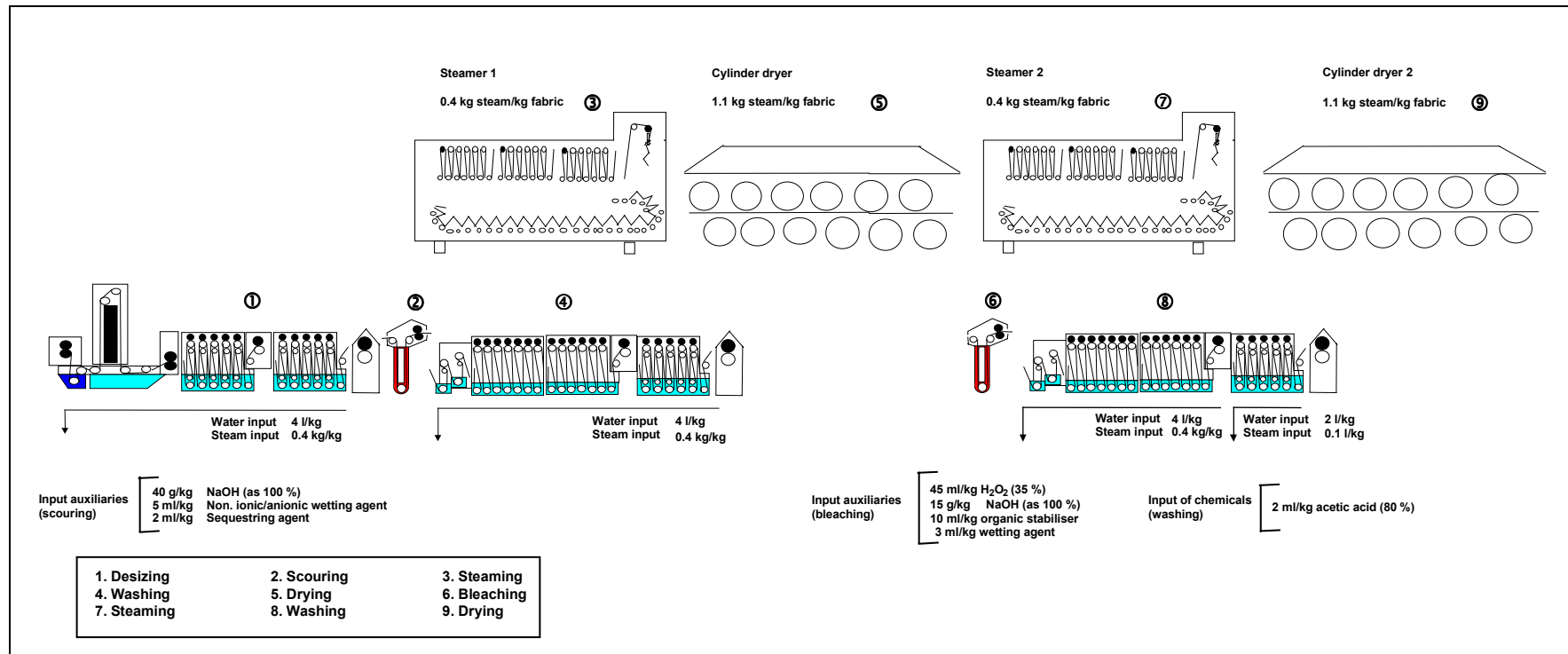


Figure 3.12: Typical continuous process for pretreatment of cellulosic fibres, including desizing (first two compartments), scouring (padding of scouring liquor, steam treatment, washing, drying), bleaching (padding of the bleaching liquor, steaming, washing and drying) [179, UBA, 2001]

Operation	Input auxiliaries/ kg fabric		Hot water (l/kg fabric)	Steam (kg/kg fabric)	
				without heat exchanger	with heat exchanger
Desizing			3 - 4	0.6 - 0.8	0.3 - 0.4
Scouring	NaOH (as 100 %)	40 g/kg			
	Wetting agents	5 ml/kg			
	Sequester. agents	2 ml/kg			
Steaming					0.4
Washing			4 - 5	0.8 - 1	0.4 - 0.5
Drying					1.1
Bleaching	H ₂ O ₂ (35 %)	45 ml/kg			
	NaOH (100 %)	15 g/kg			
	Org. stabiliser	10 ml/kg			
	Wetting agent	3 ml/kg			
Washing	Acetic acid (80 %)	2 ml/kg	4 - 5 ⁽¹⁾	0.8 - 1 ⁽¹⁾	0.4 - 0.5 ⁽¹⁾
Steaming					0.4
Drying					1.1

Source: [179, UBA, 2001]
Notes: ⁽¹⁾ for washing after cold bleaching the reference values are: water 4 - 6; steam (without heat exchanger) 0.8 - 1.2; steam (with heat exchanger) 0.4 - 0.6

Table 3.40: Specific input for water, steam and chemicals in a modern continuous pretreatment line, including desizing, scouring (padding of scouring liquor, steam treatment, washing, drying), bleaching (padding of the bleaching liquor, steaming, washing and drying)

The figures reported in Table 3.40 refer to the amounts of water, steam and chemicals used in each step of the pretreatment process. However, these figures do not take into account possible re-use and recycling options and do not necessarily correspond to the actual consumption levels in the process. It is reported ([281, Belgium, 2002]) that in modern pretreatment lines levels of 6 litres for total water consumption (water and steam/kg of fabric) or 9 l/kg (including heat exchangers and filters cleaning) were observed. As for the organic load discharged, a large fraction comes from the desizing bath. The COD concentration and load can be calculated knowing the amount of sizing agents applied on the fabric and the specific COD value of the size reported in Section 8.3. Considering the specific input for water reported for desizing in Table 3.40 (4 l/kg), and assuming a 6 wt-% load of sizing agent on the fabric, with a specific COD of 1600 g/kg (e.g. polyvinyl alcohol), the resulting COD concentration will be about 24000 mg/l and the corresponding COD emission factor will be 96 g O₂/kg fabric.

With starch and modified starch sizing agents, enzymatic or oxidative desizing is normally applied, followed by washing. In Annex IV, typical recipes are given for enzymatic desizing, for cold oxidative desizing and for the removal of water-soluble sizing agents.

Pretreatment of synthetic woven fabric

Synthetic woven fabric is pretreated both discontinuously and continuously. The main purpose is to remove preparation agents. Typical recipes are submitted in Annex IV.

In continuous pretreatment, very high concentrations of hydrocarbons may result. For example, with a load of hydrocarbons of 1.5 wt-% and a specific water consumption of 5 l/kg, a highly concentrated stream will result (3000 mg/l). Additional organic load comes from pretreatment auxiliaries.

Pretreatment of woollen woven fabric

The availability of detailed information on the pretreatment of woollen fabric is limited. Thus, reference is made to the standard recipes for pretreatment in Annex IV.

3.3.3.5.4 Continuous and semi-continuous dyeing

Emission and consumption levels for exhaust dyeing of woven fabric are not considered in this section because the sequence of baths and the operative conditions are very similar to exhaust dyeing of knitted fabric.

In semi-continuous and continuous dyeing, the application of dyestuffs by padding is the most common technique. Therefore the following points should be taken into account.

Very often, the whole quantity of padding liquor is prepared in advance. In order to avoid shortfalls during the process, a surplus of liquor is normally prepared. Discharging the residual liquor contained in the padder and in the preparation tank into the waste water is still practised in many companies. Compared to the overall waste water flow, the quantity of these concentrated dyestuff liquors is very low. However, they contribute to a high extent to the overall dyestuff load in the waste water (see also Section 4.6.7).

The quantity of liquor in the padder mainly depends on width and weight of the fabric and design of the padder. The range is about 10 - 15 l for modern designs and 100 l for old designs and heavy woven fabric (>200 g/m²).

The residual amount in the preparation tank depends on applied dosage and control technology and can range from a few litres under optimised conditions up to 150 - 200 l. The latter is not too exceptional.

The quantity of residual padding liquors can be easily estimated on the basis of the number of batches per day. For example, a mill processing 40000 m/d and an average of 800 m per batch will have 50 batches per day. This number multiplied by the average volume of residual padding liquor per batch gives the daily quantity of residual padding liquor to dispose of.

Given a realistic pick-up of 100 % and a typical range of dyeings from 0.2 – 10 %, the dyestuff concentration in the padding liquor varies between 2 and 100 g/l. The specific COD of dyestuffs is in the order of 1 - 2 g/g. Considering only the dyestuff itself, without taking into account the auxiliaries already contained in dye formulations, the COD attributable to the dyestuffs in the padding liquor may vary between 2 and 200 g/l.

Typical recipes for continuous and semi-continuous dyeing are reported in Annex IV.

3.3.3.5.5 Printing

Printing paste residues and water emissions from rotary screen printing

It is well known that losses of printing pastes are particularly significant for rotary screen printing and analogue printing in general (perhaps less for flat screen printing) compared to digital printing - see also Section 2.8.3. In addition, especially for copper or nickel phthalocyanine dyestuffs, fixation rates can be very low for cellulosic fibres, PES and their blends (less than 50 %).

Typical figures for printing paste losses are:

2.5 – 4	kg for conventional squeegees (depending on diameter and length of the squeegee)
2.5	kg from pipes and the pumps
1 - 2	kg from the screens
6.5 – 8.5	kg Total

Thus, for conventional printing paste supply systems, volumes (= losses) of 6.5 – 8.5 kg per colour applied can be expected

Depending on the quantity and pattern of textile substrate to be printed, the losses of printing paste can be even higher than the amount of printing paste applied on the textile substrate. For example, for printing 250 m of fabric (with 200 g/m specific weight) and at a coverage of 80 % (ratio between the total textile area and the printed area), 40 kg printing paste are required. In the case of 7 colours and 6.5 kg of printing paste residues per colour, the loss is 45.5 kg, which is higher than the quantity of paste printed on the textile substrate (without taking into account the residues in the printing paste buckets, etc.).

Printing pastes are concentrated mixtures of different chemicals. Pigment printing pastes are the most concentrated ones, whereas reactive printing pastes have the lowest content of organic compounds. The composition of typical formulations of reactive, vat, disperse and pigment printing pastes are submitted in Section 11.

At the end of each batch the printing equipment (squeegee, pipes, pumps, screens, etc.) is cleaned. Typical values for water consumption are as follows:

- 350 l per pump and pipes for one printing paste supply system
- 35 l per squeegee (modern washing equipment)
- 90 l per screen (modern washing equipment).

In addition, water is consumed for cleaning the printing blanket, with typical consumption levels of around 1200 l/h. Normally, the washing facility is coupled with the movement of the blanket, which is only about 25 % of the time (on/off system).

The dryer blanket also needs to be cleaned after the printing process. A typical consumption level is about 400 l/h; here, too, the washing facility is coupled with the movement of the blanket.

Urea consumption levels in reactive printing pastes

Urea from reactive printing pastes is the main source of NH_3 and NH_4^+ in the waste water from printing houses.

Data reflecting current industrial practice in three typical mills in Italy are reported for silk and viscose [312, ANT, 2002]. For silk the consumption levels range from 40 to 100 - 110 g/kg printing paste. For viscose the reported figures show even higher dosages (up to 150 g urea/kg of printing). Information about techniques for avoiding or at least reducing the use of urea is reported in Section 4.7.1.

Air emissions from drying and fixation treatments carried out after printing

It is well known that printing pastes contain substances with high air emission potential. The relevant pollutants and the possible emission sources are listed in Section 2.8.3.

Table 3.41 shows emission data from measurements carried out in three finishing mills. The reported figures refer to screen printing of flat fabrics (they do not apply to the printing of bulky fabrics such as carpets).

Site	Printing process	Processing step	Substrate	Process temperature (°C); Curing time (min)	Emission factor (g C/kg textile)
A	Vat discharge-printing on direct dyed grounds	Drying	CV		0.3
		Steaming	CV	102; 13	1.0
	Vat two-step printing	Drying			0.6
		Fixation		135; 1	1.3
	Disperse printing	Drying	PES		1.3
		Fixation	PES	175; 5	0.01
	Pigment printing	Drying	CO	150	0.2
Condensation		CO	160; 5	0.1	
B	Pigment printing, simulation pilot stenter	Drying and fixation	CO	Drying: 150; 1 Fixation: 160; 4	0.4 -4 depending on the recipe
C	Pigment printing, simulation pilot stenter	Drying and fixation	PES	Drying: 150; 1 Fixation: 160; 4	0.4 -5.6 depending on the recipe
Source: [179, UBA, 2001]					

Table 3.41: Air emission data from drying and fixation after printing (measurements carried out at two finishing mills)

3.3.3.5.6 Finishing

Water emissions from finishing treatments

Water pollution from finishing operations may arise from afterwashing operations (which are not always required) and from inadequate disposal of concentrated residues from padding devices, preparation tanks and pipes. The amount of residual liquors is in the range of about 0.5 to 35 % of the total amount of finishing liquor prepared. The lower value is for integrated mills finishing only one type of substrate, whereas the higher value is typical of textile mills processing small lots and different types of substrates.

Many different chemicals and recipes are available in order to finish textile substrates. Notable examples with cellulosic fibres, are the finishing treatments applied with reactive flame retardants (organophosphorus compounds) and those with reactive non-iron auxiliaries. For the latter, a typical recipe is presented in Table 3.42.

	(g/l)	Remarks
Dimethyloldihydroxy ethylene urea	130 - 200	cross-linking agent
Sulphuric acid (48 %)	15 - 30	
Washing agents	2	fatty acid ethoxylates
Source: [179, UBA, 2001]		
Notes:		
a) The reaction is carried out at acidic conditions (pH 2 - 3), reaction time is 20 - 40 h at 25 - 30°C		
b) COD of the padding liquor is about 130 - 200 g/l		

Table 3.42: Standard recipe for the finishing of cotton woven fabric with reactive non-iron compounds

The chemicals applied for both flame retardant and non-iron finishing are non-biodegradable and also adsorption to activated sludge is very low. This indicates that biological treatment is not appropriate for treating these waste streams.

Another example is given for finishing agents that are widely applied to cotton woven fabric to improve crease and shrink resistance. One typical recipe is presented in Table 3.43.

Component	Quantity (l/1000m)	x 0.91 ⁽¹⁾	spec. COD (g O ₂ /kg)	COD (mg/1000 m)
Levelling and dispersing agent	5	4.55	645	2934.75
Methyloldihydroxyethylene urea	40	36.40	790	28756.00
MgCl ₂	10	9.10		
Natrium F-borate	0.15	0.14		
Optical brightener	2	1.82	360	655.20
Additive for cross-linking agents	20	18.20	628	11429.60
Smoothness agent	40	36.40	340	12376.00
Softening agent 1	30	27.30	530	14469.00
Softening agent 2	30	27.30	440	12012.00
Total chemicals	177.15			
Total liquor applied (incl. water)	195		Total	82632.55

Source: [179, UBA, 2001]
Notes:
Specific fabric weight: 250 g/m²
Fabric width: 1.6 m
⁽¹⁾ because of dilution

Table 3.43: Typical finishing recipe for crease and shrink resistance

In this case, there is no afterwashing, but environmental concerns arise from the potential discharge of the residual finishing liquor in the padder and preparation tank. The reactive component (methyloldihydroxyethylene urea), the optical brightener and the softening agents are non biodegradable and contribute to residual COD in the treated effluent of biological waste water treatment plants.

Potential air emissions from finishing auxiliaries (calculated data)

In most cases the emission potential of a finishing recipe can be calculated on the basis of emission factors given for the individual substances present in the formulation. According to this concept, which is explained in more detail in Section 4.3.2, it is possible to define the following parameters (the original nomenclature is kept in the following description):

- a substance-based emission factor, and
- a textile substrate-based emission factor.

There are two types of *substance-based emission factors*: 1) *f_c*, which gives the total emission produced by the organic substances present in the formulation, expressed as total organic carbon; 2) *f_s*, which gives the emission attributable to specific toxic or carcinogenic organic substances or inorganic compounds, such as ammonia and hydrogen chloride, present in the formulation.

In Germany, where this concept was developed, auxiliary suppliers provide information on the substance-based emission factors. This is a prerequisite for the calculation of the textile-based emission factors.

The *textile substrate-based emission factor* (W_{Fc} or W_{Fs}) is defined as the amount of organic and inorganic substances in grams that can be released under defined process conditions (curing time, curing temperature and type of substrate) from one kilogram of textile treated with a given auxiliary formulation.

The textile substrate-based emission factor can be calculated on the basis of the substance-based emission factors of the individual components of the formulation/recipe (*f_c* or *f_s*), their concentration in the bath (*FK*) and the liquor pick-up (*FA*, which normally ranges between

60 % and 120 % depending on the type of substrate). An example of the calculation of the textile-based emission factors is reported in Table 3.44.

	FK (g/kg)	FA (g/kg)	fs (g/g)	fc (g/g)	FK*FA*fs (g/kg)	WFs (g/kg)	FK*FA*fc (g/kg)	WFc (g/kg)
RECIPE 1 Cotton; 170°C								
Fatty acid ester	20	0.65		0.015			0.2	
Polysiloxane	20	0.65		0.005			0.07	
Cross-linking agent	100	0.65	0.0041FO	0.0009	0.27FO		0.06	
Stearyl urea derivative (catalyst)	20	0.65	0.0165FO	0.0162	0.21FO		0.21	
Total 1						0.48FO		0.54
RECIPE 2 Cotton; 150°C								
Softening agent	50	1	-	0.005	-		0.25	
Formaldehyde-free cross-linking agent	12	1	-	0.01	-		0.12	
Catalyst	12	1	-	0.008	-		0.1	
Total 2						-		0.47
Source: [179, UBA, 2001]								
Notes:								
FK: concentration in the recipe (g auxiliary/kg liquor)								
FA: liquor pick-up (kg liquor/kg textile substrate)								
fs: substance-based emission factor (g emission/g auxiliary) (in the case of toxic or carcinogenic organic substances or in the case of inorganic substances such as ammonia, hydrogen chloride, etc.)								
fc: substance-based emission factor, expressed as total organic carbon (g Org-C/g auxiliary)								
WFs: $\Sigma(\text{FK} \cdot \text{FA} \cdot \text{Fs})$ - textile-based emission factor, within the same class of substances								
WFc: $\Sigma(\text{FK} \cdot \text{FA} \cdot \text{Fc})$ - textile-based emission factor, expressed as total organic carbon								
FO: formaldehyde								

Table 3.44: Two examples for the calculation of air emission factors

Based on these examples, the potential of a number of commercial auxiliaries to release Organic-C or specific substances such as formaldehyde during thermal processes carried out after finishing has been calculated and reported in the tables in Section 11.4. The analysed auxiliaries are taken from the “Textile Auxiliaries Buyers’ Guide” [65, TEGEWA, 2000]. The various formulations have been divided into different classes according to their functionality.

Considerable differences are also observed among auxiliaries belonging to the same class because of: chemical composition, active ingredients, by-products and impurities. However, the following general comments can be made:

- formaldehyde is released mainly from auxiliaries based on *cross-linking compounds* (esp. cross-linking agents and reactive flame retardants). Formaldehyde emission potential of melamine derivatives is in most cases higher than auxiliaries based on dimethyloldihydroxyethen urea derivatives (see Table 3 and Table 4)
- *antifoaming agents* that contain highly volatile hydrocarbons as the main active compound have a very high emission potential compared to silicon-based types (see Table 5)
- for *wetting agents* based on tributylphosphate, which is characterised by a high vapour pressure, substance-specific emission factors up to about 340 g Organic-C/kg are observed. Because various additives/by-products not specified in the Material Safety Data Sheets are used and the amount of active ingredients can vary greatly, the emission factors of the other wetting agents (see Table 6) also vary greatly

- *softening agents* based on fatty acid derivatives are characterized by emission factors between 1 and 5 g Organic-C/kg. Polysiloxane-based types show higher values. The highest mentioned value in Table 7 is caused by a fatty acid type with an additive of a highly-volatile wax
- *carriers* are usually highly volatile substances; emission factors above 300 g Organic-C/kg are observed (see Table 8)
- *levelling agents* used in dyeing can – like carriers - be carried over by the textile substrate and cause considerable air emissions
- differences in the emission potential of *flame retardants* are mainly caused by the different types of active substances and amounts of by-products/additives (alcohols, especially methanol for reactive types, glycols, glycol ethers) (see Table 9)
- with *repellents*, too, a wide range of emission factors is observed. This is mainly caused by a different kind and quantity of solvents used for fluorocarbon resins (e.g. buthyl/ethyl acetate, methylethyl/isobutylketone, ethandiol, propanediol) and different amounts of active ingredients if paraffin-based types are considered
- for *conditioning agents* it is clear that products based on paraffins (which have a relatively high volatility) have a higher emission potential than fatty acid derivatives (see Table 11)
- *optical brighteners* and *antielectrostatic agents* have variable emission potentials due to different active ingredients and differences in the formulations of the auxiliaries (see Table 12)
- *filling* and *stiffening agents* based on natural or synthetic polymers have low emission potentials
- emission levels for *aftertreatment agents* are low
- *biocides* can contain aromatic hydrocarbons; this leads to increased emission factors (see Table 16)
- emission potentials of silicic acid-based *non-slip agents* are very low.

Captured air emissions from thermal processes carried out after finishing treatments

The previous section dealt with calculated emissions. As for measured emissions at the stack, typical emission levels are reported in Table 3.45 for a sample of finishing mills (each with one or more different processes). When emission abatement systems are installed, the values shown in the table will correspond to the resulting clean gas. In the case of direct heated stenters, the portion of Organic-C emission attributable to the fuel (methane, propane, butane) is mentioned separately and is not included in the data for the Organic-C emission values (concentrations, emission factors and mass flows).

The following general comments apply to the reported data:

- thermal treatment of textiles on stenters can be influenced by upstream finishing processes (and by the efficiency of the previous washing treatment, if applied), as can be seen for dyeing carriers in process 4.4 in Table 3.39 and for perchlorethylene in process 12.1 and 12.2 in Table 3.45 (this aspect is analysed in more detail later in this section)
- an emission factor of 0.8 g Organic-C per kg textile can be achieved in nearly all processes in textile finishing (however, it has to be kept in mind that for sites with installed emission abatement systems, the reported emission figures correspond to the clean gas).
- Organic-C emissions caused by uncombusted fuel are in a range of 0.1 g/kg textile up to > 5 g/kg textile in the case of poorly maintained burners
- formaldehyde emissions may originate not only from the auxiliaries applied, but also from the directly heated stenters themselves due to partial burning-out of the gas (methane, propane, butane). Concentration levels from stenters range from 0.1 to 60 mg/Nm³.

Site	Stenter technology Emission abatement	Recipe	Substrate	Process temperature (°C)	Emission factor (g/kg textile)	Concentration (mg/Nm ³)	Mass-flow (g/h)	Machine based emission (g/kg textile)	Remarks
1.2	Direct heated	Finishing (stiffening cross-linking agents), de-aeration, non-slip)	PA 6	150	3.5	21	101	7.7	1.5 g/kg formaldehyde
1.3	Direct heated	Antistatic, softening	PA 6.6	150	0.7	33	148	0.1	
2.1	Indirect heated	Easy-care, softening, acetic acid	CO/EL	170	0.9	52	506	-	0.02 g/kg formaldehyde
3.1	Direct heated Heat recovery	Flame retardant	CO	145	0.3	19	155	0.2	0.01 g/kg formaldehyde
3.2	Direct heated Heat recovery	Optical brightener, antistatic	PES	190	0.6	24	277	0.5	
4.1	Indirect heated	Softening	PES/WO	130	0.6	187	529	-	0.05 g/kg formaldehyde
4.2	Indirect heated	Non-slip	PES/WO	130	0.3	15	188	-	0.01 g/kg formaldehyde
5.1	Direct heated	Stiffening, softening	PES	170	0.4	9	123	0.2	0.03 g/kg formaldehyde
5.2	Direct heated	Softening	PES	170	0.5	10	149	0.2	0.04 g/kg formaldehyde
6.1	Direct heated Heat recovery	Coating (polyvinylacetate)	CV/PP	110	0.7	68	689	1.4	0.06 g/kg formaldehyde
6.2	Indirect heated Heat recovery	Coating (polyvinylacetate), softening, thickener, acetic acid	CV/CO	120	0.08	8	36	-	
7.1	Direct heated Aqueous scrubber	Coating /acrylate, cross-linking agent, foaming agent	CV	150	0.35	16	142	0.1	0.14 g/kg formaldehyde
8.1	Direct heated Aqueous scrubber	Wetting agent, stain release	CV/CO/ PES/WO	165	0.5	22	255	0.4	
8.2	Direct heated Aqueous scrubber	Softening, foaming agent	PES/CV/ CO	150	0.3	17	200	0.3	
8.3	Direct heated Aqueous scrubber	PU-coating	PES/CO	130	0.2	10	121	0.1	
9.1	Indirect heated -	Easy-care, softening, wetting agent, acetic acid	CO/EL	150	0.2	43	56	-	0.03 g/kg formaldehyde
9.2	Indirect heated	Easy-care, softening, wetting agent, acetic acid, stiffening, hydrophobic	CO/CV/ EL	150	0.3	53	69	-	0.05 g/kg formaldehyde

Site	Stenter technology Emission abatement	Recipe	Substrate	Process temperature (°C)	Emission factor (g/kg textile)	Concentration (mg/Nm ³)	Mass-flow (g/h)	Machine based emission (g/kg textile)	Remarks
10.1	Direct heated Aqueous scrubber	Drying after dyeing	PA/EL	135	0.4	12	138	0.1	
12.1	Direct heated	Wool protecting (polyurethane, polyacrylate) wetting agent	PES/WO/ EL	190	1.3	60	542	0.3	0.7 g/kg perchloroethylene
12.2	Direct heated	Hydrophobic, wetting agent, acetic acid	PES/WO/ EL	190	0.9	41	370	0.4	0.8 g/kg perchloroethylene
14.2	Direct heated	Hydrophobic	PAC/PES	180	0.5	18	238	1.3	
14.3	Direct heated	Softening	CO/PES	160	0.5	34	439	0.7	
14.4	Direct heated	Anti-slip	PAC	160	0.7	19	245	1.8	
14.5	Direct heated	Easy-care	CO/PS	170	1.5	50	764	0.6	0.06 g/kg formaldehyde
Source: [179, UBA, 2001]									

Table 3.45: Thermal treatments after finishing treatments: process-specific emission data (measured data)

Carry-over of pollutants from upstream processes to drying and fixation

Textile auxiliaries and chemicals (and their by-products/ impurities) with a certain affinity with the fibres can be fixed temporarily on the textile, especially if washing/rinsing is inadequate. In down-stream thermal treatments these substances can be released from the textiles and end up in the exhaust air. Typical substance classes to be regarded from this point of view are:

- carriers
- levelling agents
- aftertreatment agents
- wetting agents
- hydrocarbons from printing pastes (this aspect has already been analysed in Section 3.3.3.5.5)
- acetic acid
- perchlorethylene (if dry-cleaning is carried out)

Data on emission potential of carrier-dyed fabrics and dry-cleaned fabrics are given below.

Emission potential of carrier- dyed fabrics

Carriers are mainly used for dyeing of PES and PES blends (see also Sections 2.1.1.1 and 4.6.2). Part of the carrier (in some cases up to 50 % or more) is absorbed on the fabric and released during heat treatment. The degree of carrier exhaustion/absorption mainly depends on:

- liquor ratio
- quantity used
- dyeing process
- textile substrate
- processing conditions during rinsing.

Emission potential of carrier-dyed fabrics is summarised in Table 3.46. Data are based on fabric that has been dyed with carriers (on industrial scale), but not dried. Drying of the fabric and air-emission measurement was carried out on a laboratory stenter.

Carrier active components	Emission factor (g C/kg textile)
Benzyl benzoate; Phthalic acid ester	8.97
Biphenyl; Dimethyl phthalate	8.3
Alkylphthalimide	5.88
Source: [179, UBA, 2001] with reference to "Envirotox, 2000"	

Table 3.46: Air emission factors from drying carrier-dyed textiles

Table 3.47 shows a representative selection of air-emission values from four textile mills during drying/fixation of carrier-dyed wool fabrics. It is clear from reported data that, especially if carriers based on aromatic solvents are used, the active compounds of carrier formulations can lead to a considerable off-gas load during thermal treatment. The efficiency of the emission abatement systems (calculated by comparing the Organic-C concentration in raw and in clean gas) can be insufficient (only 10 - 40 %,) for these classes of compounds.

For non treated off-gases, concentrations ranging between 30 and 4600 mg C/m³ were observed with emission flows of 0.2 - 28 kg C/h and emission factors (WFC) of 0.8 - 24 gC/kg textile. The most critical substance found in the exhaust gas was biphenyl with concentration levels of 60 - 110 mg/m³ at emission flows of 350 - 600 g/h (WFs: 0.9 - 1.5 g/kg textile).

Textile company	Emission abatement efficiency (%)	Carrier chemistry	Emission factor (g Org.-C/kg textile)	Concentration (mg/Nm ³)	Mass-flow (kg Org.-C/h)
Site 1 Fabric A	15	Aromatic solvents	24	2000 - 4500	28
Fabric B	25	Aromatic solvents	7.6	200 - 1000	8
Site 2 Fabric A	Not installed	Phthalimide, dimethyl phthalate Biphenyl, Dimethylene phthalate	0.77	66	0.4
Fabric B	Not installed		1.2	84	1.1
Site 3 Fabric A	30 - 40	Benzoate, phthalate	0.8 - 0.9	22 - 25	0.2
Fabric B	10 - 25	Benzoate, phthalate	2.0 - 2.2	50 - 60	0.6
Site 4 Fabric A	Not installed	Benzoic acid esters, aromatic compounds	6.5	400	4.3
Source: [179, UBA, 2001] with reference to "Envirotext, 2000"					

Table 3.47: Air emission levels during drying/fixation of carrier-dyed fabrics

Emission potential of dry-cleaned fabrics

Dry-cleaning is used in the textile industry for the following purposes:

- cleaning of grey textiles and especially elastane blends (conventional washing processes are insufficient to remove silicone preparations widely used for elastane fibres)
- aftertreatment for wool/elastane or wool/PES fabrics to achieve improved colourfastness especially for dark shades
- quality corrections (removal of spots).

Besides the intentional use of perchlorethylene, a considerable amount of dry-cleaned fabric is finished in Germany because imported goods are often dry-cleaned. The retention of perchloroethylene (main solvent used in dry-cleaning) on textiles is high. As a result perchloroethylene can be released during thermal processes (especially drying).

Due to a potential risk of PCDD/PCDF formation by drying/fixation of perchloroethylene-cleaned fabrics, treating perchloroethylene-cleaned fabrics on directly heated stenters is banned in some countries (e.g. Germany).

The emission potential of non-dried fabrics treated with perchloroethylene from five textile finishing plants has been investigated on a laboratory stenter (process temperature 150 °C). Table 3.48 summarises the resulting measured emissions.

Ranges of air-emission values for perchloroethylene-cleaned fabrics during drying/fixation are:

- 0.1 – 0.8 g perchloroethylene/kg textile (dry-cleaning on-site at finishing plant)
- 0.3 – 1.7 g perchloroethylene/kg textile (external dry-cleaning).

Textile company	Fabric	Emission factor (g C/kg textile)	Concentration (mg C/Nm ³)	Mass flow (g C/h)	Emission factor (g PER/kg textile)
Site 1	A*	0.11	28.1	3.77	0.27
	B*	0.23	32.6	4.28	1.17
Site 2	A*	0.19	16.1	1.88	0.95
	B*	0.26	21.7	2.71	0.66
	C*	0.14	11.7	1.68	0.63
	D*	0.13	6.1	0.82	0.47
	E*	0.85	70.8	9.27	1.65
	F**	0.29	21.1	2.59	0.67
	G**	0.11	8.0	0.99	0.51
Site 3	A**	0.27	19.3	2.37	0.09
	B**	0.18	12.9	1.58	0.19
	C**	0.30	20.1	2.47	0.13
Site 4	A**	1.23	94.9	11.95	0.79
	B**	0.86	65.9	8.11	0.65
	C**	0.80	53.1	6.53	0.54
Site 5	A**	0.09	6.6	0.80	0.46
	B**	0.12	4.0	0.50	0.67
	C**	0.15	6.4	0.81	0.82
Source: [179, UBA, 2001] with reference to "EnviroTex, 1998b"					
Notes: * External dry-cleaning ** On-site dry-cleaning at the finishing plant					

Table 3.48: Emission values from perchloroethylene-cleaned fabrics

3.3.3.5.7 Coating and laminating

The main environmental concerns from coating operations are volatile organic compounds from solvents, softeners, etc. as well as ammonia and formaldehyde from stabilisers and cross-linking agents. These aspects are discussed in more detail in Section 2.10. Process-specific emission values for coating processes (including one example for carpet back-coating) derived from measurements carried out in five installations are presented in Table 3.49. However, it has to be noted that since in-house recipes are normally used, the emission levels can vary greatly. Therefore the examples in Table 3.49 are intended to give only a first insight on the topic.

Additional data can be found in Table 3.45 (see processes 6.1, 6.2, 7.1, 8.3).

Note that in the case of direct heated stenters, the portion of Organic- C emission attributable to the fuel (methane, propane, butane) is mentioned separately (see column "machine based emission") and is not included in the data for the Organic-C emission values ("concentration", "emission factor", "mass flow").

Site	Drying apparatus technology Emission abatement	Recipe	Substrate	Process temperature (°C)	Emission factor (g Org.-C/kg textile)	Concentration (mg Org.-C/Nm ³)	Mass-flow (g Org.-C/h)	Machine based emission (g Org.-C/kg textile)	Remarks
1.1	Direct heated Aqueous scrubber	Coating agent (acrylate dispersion) Fixation agent (melamine) Foaming agent Thickener (acrylate based)	CV (non-woven)	150	0.4	20	173	0.1	Formaldehyde: 0.14 g/kg
2.1	Indirect heated	Laminating: PVC adhesive (PVC-powder, softener, stabilisator, primer, emulsifier)	PVC-foil on knitted goods	105	-	82	144	23 g Org.-C/h	Phthalates: 6 mg/Nm ³ ; Vinylacetate 12 mg/Nm ³
3.1	Direct heated	Carpet back-coating (pre-coating and foam coating) based on styrene/butadiene latices and natural latices	PA 6 tufting	120	0.8	75	450	1.5	Formaldehyde: 0.06 g/kg; Ammonia: 0.3 g/kg
4.1	Direct heated	Flame laminating	PU-foam on PA substrate	-	-	74	232	798 g C/h	HCN: 3.6 mg/Nm ³ TDI ⁽¹⁾ 0.5 mg/Nm ³
5.1	Direct heated	Acrylate dispersion with additives (thickener, ammonia, catalyst)	CO	150	0.4	-	138	1.9	Ammonia: 0.02 g/kg

Source: [179, UBA, 2001]

Notes:

⁽¹⁾ According to another source ([319, Sweden, 2002]), flame laminating mills usually treat their air stream with both fabric filters and wet scrubbers. An example is given whereby the emission levels of TDI from one mill using a wet scrubber to treat its emissions are 1.09 mg TDI/ Nm³ before the scrubber and 0.06 mg TDI/ Nm³ after the scrubber.

Table 3.49: Air emission data from coating (measurements carried out in five finishing mills)

3.4 Carpet industry

3.4.1 Wool and wool-blend carpet yarn dyehouses

The processes dealt with in this section are described in detail in 2.14.5.1. Literature data on consumption and emission levels for the wool carpet yarn sector is very poor. Information presented below comes from the report that ENco has submitted to the EIPPC Bureau [32, ENco, 2001]. Quantitative data have been gathered from a group of UK companies representative of this sector. The survey covered a range of enterprises, varying in size from a yarn dyehouse processing approximately 1000 tonnes/year of fibre to an integrated loose fibre and yarn dyeing/finishing plant, processing over 7000 tonnes of fibre per year.

Three categories of companies were involved:

- loose fibre dyehouses which dye and dry only loose fibre
- yarn dyehouses which scour, dye and dry only yarn. In one or two cases the scouring of previously dyed yarn is also included
- integrated loose fibre and yarn dyehouses.

In this document, data on consumption and emission levels are presented for the first two categories of mills in Table 3.50 and Table 3.53. Integrated dyehouses can be seen as mixtures of these processes. Figure 3.14 attempts to give ranges of inputs to and output from the wool carpet yarn activities (outputs after municipal waste water treatment are not included). The reported figures should be used with caution, as the diversity of the sector makes these generalisations subject to considerable error.

Consumption and emission figures are based on information for a twelve month period within a 1999 - 2000 time frame.

Emission data are given only in respect of water pollution, from which the main environmental issues associated with the activities carried out in this sector arise.

Emissions factors have been calculated from waste water volume, measured waste water concentration at the outfall to public sewer (after flow balancing only) and textile product throughput over a corresponding time frame. There are typically wide variations in the composition of waste water due to the predominantly batch nature of the dyeing process used and natural variation in the fibre. Data available from longer term measurements have been preferred, as individual measurements made on a few batches of material are unlikely to reflect long-term trends.

The emissions have been quantified in terms of the following environmentally significant parameters:

- Chemical Oxygen Demand (COD)
- suspended solids (SS)
- metals (copper, chromium, cobalt, nickel)
- organochlorine pesticides (HCH, dieldrin, DDT)
- organophosphorus pesticides (diazinon, propetamphos, chlorfenvinphos)
- synthetic pyrethroid insecticides (permethrin and cyfluthrin from mothproofing agents) and cypermethrin (from sheep-dip ectoparasiticides).

3.4.1.1 Loose fibre dyehouses

LOOSE FIBRE DYEHOUSE		Units/tonne (textile product)	Site A	Site B	Site C
PROCESS INPUTS					
Water		m ³	34.9	28.7	53.5
Energy, total		GJ	11.18	15.52	15.64
Dyeing & finishing chemicals	Basic chemicals	kg	36.39	28.81	72.11
	Dyes total, of which <i>chrome+metal complex</i>	kg	7.65 <i>2.90</i>	3.60 <i>2.10</i>	4.39 ^(c) <i>2.81</i>
	Dyeing aux. of which <i>Levelling agents</i>	kg	10.27 <i>5.67</i>	15.84 <i>5.85</i>	4.30 <i>2.53</i>
	Finishing aux. total, of which <i>mothproofing agent</i>	kg	0.40 <i>0.18</i>	5.89 <i>0.78</i>	0.08 <i>0</i>
PROCESS OUTPUTS					
Emissions to water:					
COD		kg	20	28	20
SS		kg	0.05	0.30	1.03
Metal total, of which:		g	67.33	54.85	2.97
- Chromium		g	66.08	52.78	1.67
- Copper		g	0.47	1.19	0.15
- Cobalt		g	0.78	0.88	1.15
SPs total, of which:		g	0.462	0.172	0.015
- Permethrin (from mothproofers)		g	0.458	0.165	0.010
- Cyfluthrin (from mothproofers)		g	n.d.	n.d.	n.d.
- Cypermethrin (from raw fibre)		g	0.004	0.007	0.005
OCs total (from raw fibre) ^(a)		g	0.003	0.007	0
OPs total (from raw fibre) ^(b)		g	0.811	0.664	0.722
Waste water		m ³	27.7	24.46	45.44
Source [32, ENco, 2001]					
Notes:					
n.d. = not detectable in the effluent					
^(a) Sum of: HCH total; Dieldrin; DDT total					
^(b) Sum of Diazinon, Propetamphos, Chlorfenvinphos					
^(c) Site C does not use chrome dyes (only metal-complex dyes)					

Table 3.50: Overview of emission and consumption levels for three typical loose fibre dyehouses

Water & energy consumption

As a general consideration, it has to be noted that the water consumption figures reported in the table above are inevitably higher than the theoretical values obtained considering the liquor ratio of the machines (which is typically 1:10 for loose fibre dyeing) and the subsequent water additions for rinsing or other aftertreatments. These values include water used to raise the steam for heating the liquor, spillage on loading and reloading, cooling additions made for shade matching, etc.

The three loose fibre dyehouses referenced in Table 3.50 indicate a wide range of specific water consumption figures, attributable to different working practices and water recycling measures. Plant A operates a standard dyeing regime consisting of the dyeing cycle followed by rinsing in a separate bath, with all waste liquors discharged directly to drain. Site C operates similar machinery, but rinses and cools dyeings using the overflow methods in which clean water is allowed to overflow from the dyeing machine to drain. Site B recycles a proportion of both the dye liquor and rinse liquor and has the lowest overall water consumption factor.

Reported data on energy consumption account for the operations of raising the temperature of the dye liquor from ambient to boiling point and evaporating water from the textile during drying.

Heating 1 kg of water to 100 °C requires: 0.00042 GJ
 Evaporating 1kg of water requires: 0.00260 GJ

Therefore, the theoretical requirements for loose fibre dyeing and drying would be:

- for dyeing (heating 10kg of water per kg of textile): 4.2GJ/tonne
- for drying (water content when the fibre enters the dryer: 0.5kg/kg textile): 1.3GJ/tonne.

The total theoretical energy requirement is, therefore, 5.5 GJ/tonne of textile. In practice the energy requirements of individual plants are significantly higher than the above figures would suggest, due to losses in steam generation and transmission and the use of process water at modest temperatures in rinsing and the application of finishes.

Data presented in Table 3.50 fall within a narrow range despite their widely differing water consumption figures. This is understandable on the basis that all three enterprises consume energy in essentially the same way (to raise the temperature of the dye bath and to dry the wet fibre) and that the additional water usage arises from cooler rinsing operations.

Chemical Oxygen Demand

The organic substances discharged in the waste water and the corresponding COD emission factors reflect the pattern of usage of dyestuff and dyeing auxiliaries. In loose fibre dyehouses the use of metal-complex dyes is predominant. Dyeing may require the use of both levelling agents and polyamide reserving agents.

COD emission factors for the three selected mills range from 20 to 30 kg/tonne of processed fibres. A portion of this COD load, however, is attributable to contaminants already present on the incoming raw material. Scoured wool may contain variable amounts of residual wool grease and detergent, depending on the efficiency of the wool scouring process. Synthetic fibres on the other hand contain residual spin finish whose content in oxygen-demanding material varies depending on the lubricant employed.

The figures in the table below come from laboratory analyses performed by submitting samples of raw material to aqueous extraction procedures to simulate the removal of the contaminants in the first wet process.

Material	First wet process	COD equivalent of removable contaminants (kg /tonne)
Scoured wool fibre	Loose fibre dyeing	5 – 15
Nylon fibre (as received)	Loose fibre dyeing	30 – 50
Source: [32, ENco, 2001]		

Table 3.51: Concentrations of compounds present on raw loose fibres, which contribute to the waste water COD load

Synthetic pyrethroids from mothproofers

The indicated emission factors of mothproofing active agent permethrin show a wide range of values, which reflects very different procedures on each site.

Site A operates a conventional mothproofing process in which each of the dyeings that will ultimately make up a bulk blend is treated at a level consistent with the desired overall application rate (typically 100 mg permethrin/kg fibre). Waste water from each dyeing is discharged.

Site B operates with an overtreatment and dye liquor re-circulation system designed to minimise mothproofing emissions. In this process only some of the fibre (perhaps as little as 10 % of the total blend weight) will be mothproofed, this portion receiving a correspondingly high application rate. Spent dye baths from this process contain correspondingly high levels of permethrin, but they are retained in a holding tank and re-used for the next sequence of dyeings or are used to dye fibre which requires no treatment. Overall the waste water residues from this sequence of operations are significantly lower than from the conventional process. The remainder of the blend receives no treatment and spent process liquor from these dyeings contains no residual mothproofing agent. Finally the overtreated and untreated fibre is intimately mixed during mechanical processing and yarn formation, resulting in an insect-resistant yarn with the correct average treatment level.

Site C does not carry out mothproofing. The low levels of permethrin detectable in the effluent arise from the dyeing of fibre which is inadvertently contaminated with low levels of permethrin. The source of this contamination is difficult to identify but may arise, for example, through the reprocessing of previously treated waste fibre, contamination during the raw wool scouring process when this process is used to mothproof scoured wool, etc.

Data presented in Figure 3.14 also illustrate typical permethrin emissions from a site operating with the conventional means of mothproofing, in which mothproofing is carried out in loose fibre dyeing. The resultant yarn is subsequently scoured to remove lubricant, contaminating the scour liquors with mothproofing agent. This process is no longer commonplace in the UK, where the majority of manufacturers using this production route are obliged to apply mothproofing agent from a special low-volume application bowl at the end of the scouring line, in order to meet local waste water emission limits.

Metals

Reference Sites A and B use the highest proportions of afterchrome dyes, which is reflected by mill effluent loads in the range of 53 – 66 g/tonne of dyed fibre. Note that loads are derived from effluent parameters and total dyed fibre and therefore do not represent loads from individual dyeings carried out with these materials, which are obviously higher (approximately 90 g/tonne fibre for chrome dyes and 10 g/tonne fibre for complex dyes).

Organochlorine pesticides and organophosphorus & synthetic pyrethroid ectoparasiticides

Meaningful quantitative data on the concentrations of the organochlorine pesticides present in mill effluent are difficult to obtain, not least because the levels present are often below the lower limit of detection of the analytical procedure, but also because the occurrence of these compounds on wool is intermittent and they therefore occur in effluents in an unpredictable pattern.

The reported data have been calculated from raw fibre consumption and data relating to the partition of the different pesticides between waste water and the fibre for different wet processing sequences. Fibre consumption is identified by country of origin and the initial pesticide content calculated using data from the ENco wool & hair pesticide database. As an example, annual average pesticide content of scoured wool processed at six reference sites is reported in Table 3.52.

Average OC pesticides ^(a) (g/t fibre)	Average OP Pesticides ^(b) (g/t fibre)	Average SP pesticides ^(c) (g/t fibre)
0.07	2.71	0.79
0.05	3.00	0.81
0.13	2.30	0.50
0.24	2.50	0.69
0.01	1.63	0.35
0.05	3.32	0.17
Source [32, ENco, 2001] Notes: ^(a) Sum of HCH isomers, HCB, heptachlor, heptachlor epoxide, aldrin, dieldrin, endrin, DDD, DDT ^(b) Sum of propetamphos, diazinon, dichlofenthion, chlorfenvinphos ^(c) Sum of cypermethrin, cyhalothrin, deltamethrin		

Table 3.52: Annual average pesticide content of scoured wool processed at six reference sites

The annual pesticide mass released in the effluent is then calculated by applying a waste water-fibre partition coefficient for each of the wet processes used. These coefficients were determined from trials with fibre selected to have a high initial pesticide loading, thus ensuring analytical detection at each processing stage. The same approach is also applied for OP and SP pesticides. Partition values for the most relevant OC, OP and SP pesticides are reported in Figure 3.13.

Recent studies indicate that individual OPs, (propetamphos, diazinon and chlorfenvinphos) and the SP cypermethrin behave differently when subjected to the wet treatments common in carpet fibre processing [32, ENco, 2001].

In high-temperature dyeing processes these compounds partition between the dye liquor and the fibre in ratios which approximate to their relative water solubility, thus cypermethrin (solubility 0.009mg/l) is generally present at lower concentrations than propetamphos (solubility 110mg/l). Diazinon behaves somewhat differently and is degraded at the pH values used in wool dyeing, being present neither on the fibre nor in the effluent on completion of dyeing. This observation has been made only recently (ENco, 2000, unpublished results) but explains why many dyehouse effluents appear to contain appreciably less diazinon than propetamphos when the average content of scoured wool is the reverse.

Dyeing also causes hydrophobic pesticides to migrate from the surface into the micro-structure of the wool fibre. Scouring ecreu (undyed) yarn thus releases more of these compounds into the effluent than does the scouring of yarn spun from previously dyed fibre.

Where they can be measured, emissions of OC pesticides fall in the range 0.001 - 0.025 g/t of processed wool, reflecting the background environmental contamination responsible for their presence on the fibre. The OP and SP ectoparasiticides are present at higher levels as a result of their registered use as sheep medicines.

3.4.1.2 Yarn dyehouses

YARN DYEHOUSE		Units/tonne (textile product)	Site H	Site J	Site K	Site L
PROCESS INPUTS						
Water		m ³	22		52.7	17.9
Energy, total		GJ	23.27			11.9
Yarn scouring chemicals	Basic chemicals	kg	16.2		8	
	Detergents	kg	4.6	0.45	6	
	Mothproofing active	kg	0	0	1	
Dyeing & finishing chemicals	Basic chemicals	kg	144	103	56.6	38
	Dyes total, of which <i>chrome+metal-complex</i>	kg	5.6 <i>0.3</i>	12.3 <i>3.7</i>	7.1 <i>0.25</i>	11.4 <i>7</i>
	Dyeing aux. of which <i>PA reserving agents</i>	kg	33.6 <i>16.4</i>	58.2 <i>37.4</i>	25.0 <i>18.7</i>	47.9 <i>34.3</i>
	Finishing aux. total, of which <i>mothproofing agent</i>	kg	1.0 <i>0.5</i>	0.4 <i>0.1</i>	1.6 <i>0.6</i>	2.2 <i>0</i>
PROCESS OUTPUTS						
Emissions to water:						
COD		kg	16.3	25.2	n.d.	59
SS		kg	0.26	2.04	n.d.	1.85
Metal total, of which:		g	0.8	3.54	n.d.	22
- Chromium		g	0.1	2.19	n.d.	21.2
- Copper		g	0.41	0.26	n.d.	0.10
- Cobalt		g	0.07	0.82	n.d.	0.09
- Nickel		g	0.28	0.27	n.d.	0.36
SPs total, of which:		g	0.212	0.039	n.d.	0.277
- Permethrin (from mothproofing)		g	0.24	0.035	n.d.	0.023
- Cyfluthrin (from mothproofing)		g	0	0.002	n.d.	0.24
- Cypermethrin (from raw fibre)		g	0.012	0.002	n.d.	0.014
OCs total (from raw fibre) ^(a)		g	0.029	0.005	n.d.	0
OPs total (from raw fibre) ^(b)		g	0.142	0.426	n.d.	0.41
Waste water		m ³	16.6	23	n.d.	17.9
Source [32, ENco, 2001]						
Notes:						
^(a) Sum of: HCH total; Dieldrin; DDT total						
^(b) Sum of Diazinon, Propetamphos, Chlorfenvinphos						

Table 3.53: Overview of emission and consumption levels for four typical carpet yarn dyehouses

Water & energy consumption

Among the four sites analysed, data on water and energy consumption are available only for Sites H, K and L. Nevertheless they are useful to represent a range of yarn dyeing processes, resulting in quite different water requirements. Both sites H and K pre-scour yarn in hank form and hank dye in Hussong type machines (L.R. 1:15). On Site H, the bulk of production is not rinsed following dyeing, while on Site K the reverse is true. In the former case water consumption amounts to 22m³/tonne of product while on the latter site 53m³/tonne is required. Site L dyes yarn on packages (L.R. 1:12), without pre-scouring; in this case the water and energy requirements are significantly lower than for hank dyeing.

The considerations outlined for loose fibre dyeing, regarding the meaning of the total water and energy consumption values reported in this report with respect to the corresponding theoretical requirements, are also valid for yarn dyeing.

The theoretical energy requirements for yarn dyeing can therefore be defined as follows:

- yarn package dyeing (heating 10 kg of water per kg of textile): 4.2 GJ/tonne
- hank dyeing (heating 15 kg of water per kg of textile): 6.3 GJ
- yarn drying (water content when entering the dryer: 0.5 kg/kg textile): 1.3 GJ/tonne.

The total theoretical energy requirement is, therefore, 5.5 and 7.6 GJ/tonne of textile for package and hank dyeing respectively.

The energy requirements of individual plants are two to three times higher than the above figures for the same reasons as those mentioned earlier for loose fibre dyeing. The wide range of values also reflects the types of processes employed on each site. Sites H and K operate hank dyeing equipment and pre-scour the yarn before dyeing. Conversely, Site L operates with package dyeing equipment at a liquor ratio closer to that employed in loose fibre dyeing. In addition, Site L does not pre-scour the yarn, but simply carries out dyeing in the presence of the lubricant, which is specially selected not to interfere with dyeing (this is a not very common process).

Data from the survey record only total energy consumption in wet processing and it was not possible to estimate reliably the proportions attributable to dyeing and drying. However, values are available from other studies (Table 3.54) for hank scouring, dyeing and drying processes and package dyeing of textiles. These sources typically indicate an overall energy requirement of between 17 and 28 GJ/tonne of textile for the hank dyeing route and 5 to 18 GJ/tonne for package dyeing. The values recorded in the industry survey fall within this range, so can be taken as representative of current industry practice. In the majority of cases, approximately 75 % of the energy use arises from scouring and dyeing and 25 % from the drying operations.

	Process	Energy requirement (GJ/tonne textile product)	Percentage of total energy requirement %
Hank dyeing route	Continuous hank scouring	3.0 - 5.0	18
	Hank dyeing	10.0 - 16.0	57
	Hank drying	4.5 - 6.5	25
	<i>Total</i>	<i>17.5 - 27.5</i>	<i>100</i>
Package dyeing	Package dyeing	5 - 18	

Source: UK, Department of the Environment, Energy Efficiency Best Practice Programme Good practice guide No. 168

Table 3.54: Literature values for practical energy requirements in yarn dyeing

Chemical Oxygen Demand

The reported figures record the COD load of the final effluent. It is possible, however, to estimate that the proportion of COD arising from the scouring process accounts for up to 80 % of the total. The total load from scouring is not distributed evenly between scour bowls and, in most installations, bowls 1 and 2 contain up to 95 % of the residues.

In the yarn dyeing sector, acid dyes predominate due to the requirement for level dyeing and may account for up to 90 % of total usage on any given site. Individual manufacturers may dye yarn from specific market segments that require a higher degree of fastness and the use of metal-complex and reactive dyes. The use of chrome dyes is normally restricted to the production of black and navy shades and the proportion of these dyes is typically no more than

5 % of total usage. Among the dyeing auxiliaries consumed, a significant percentage is represented by polyamide reserving agents.

In assessing the COD load in yarn dyeing effluents, it has to be pointed out that, besides the chemicals and auxiliaries used by the finisher, fibrous raw materials carry an additional amount of organic contaminants into the process stream. Synthetic yarn, in particular, contains both the synthetic fibre spin finish and spinning lubricants applied to aid mechanical processing in the mill. These substances are largely removed during the first wet process to which the fibre is subjected, thus contributing to a proportion of the chemical oxygen demand present in waste water.

Table 3.55 indicates the approximate loading of COD-contributing compounds present on raw materials entering the production chain. The figures were generated by subjecting samples of the raw material to a simple aqueous extraction procedure to simulate the first wet process. Oxygen-demanding chemicals present on spun yarn prior to scouring are related to the quality of the raw materials, as described above, and to the quantity and nature of the spinning lubricant applied by the spinner. Residual COD carried forward from yarn scouring into dyeing reflects the efficiency of the scouring process. Inevitably the COD attributable to this source varies widely.

Material	First wet process	COD equivalent of removable contaminants (kg /tonne)
80/20 wool nylon yarn "in oil"	Yarn scouring	40 – 80
80/20 wool nylon yarn Scoured for dyeing	Yarn dyeing	10 – 20
Source: [32, ENco, 2001]		

Table 3.55: Concentration of compounds present on raw fibre, which contribute to the waste water load

Synthetic pyrethroids from mothproofers

Emission levels associated with yarn dyeing are generally a function of dye bath pH and auxiliary usage. Dyeing under the strongly acidic conditions associated with the use of level dyeing acid dyes produces the lowest feasible residues, while dyeing under the more neutral conditions necessary when using metal-complex dyes will produce significantly higher residues. Emission factors can vary from 0.7 g/tonne of yarn, under acid levelling conditions, to 9.2 g/tonne when dyeing at pH>4.5 with metal-complex dyes. Moreover, some dyeing auxiliaries, particularly levelling agents, can exert a significant retarding action with respect to mothproofers uptake.

Of the companies involved in the survey, Site H shows a higher permethrin emission factor (0.24 g/tonne) than Site J (0.035 g/tonne). The difference cannot be attributed to the classes of dyestuffs used, however, because the two companies operate in similar conditions, both using predominantly acid dyes. The difference is attributable to the fact that Site H mothproofs all production with permethrin-based agent, while Site J uses a mixture of agent types and does not mothproof all production in dyeing.

Site L does not use permethrin-based mothproofers and residues in its effluent must, therefore, arise from the processing of previously contaminated fibre.

Metals

Residual metals in the waste water invariably mirror dyestuff usage patterns. In particular, the levels of chromium reflect the usage of chrome dyes. In yarn dyeing the use of acid and metal-complex dyes is predominant. The emission levels of chromium are therefore not as high as for loose fibre dyeing. The highest emission factor corresponds to Site L, where metal-complex and chrome dyes (in lower percentage) account for 60 % of the total amount of dyestuffs consumed.

Organochlorine pesticides and organophosphorus & synthetic pyrethroid ectoparasiticides

The considerations outlined for loose fibres are also valid for yarn dyehouses. The partition factors for yarn dyeing processes are reported in Figure 3.13

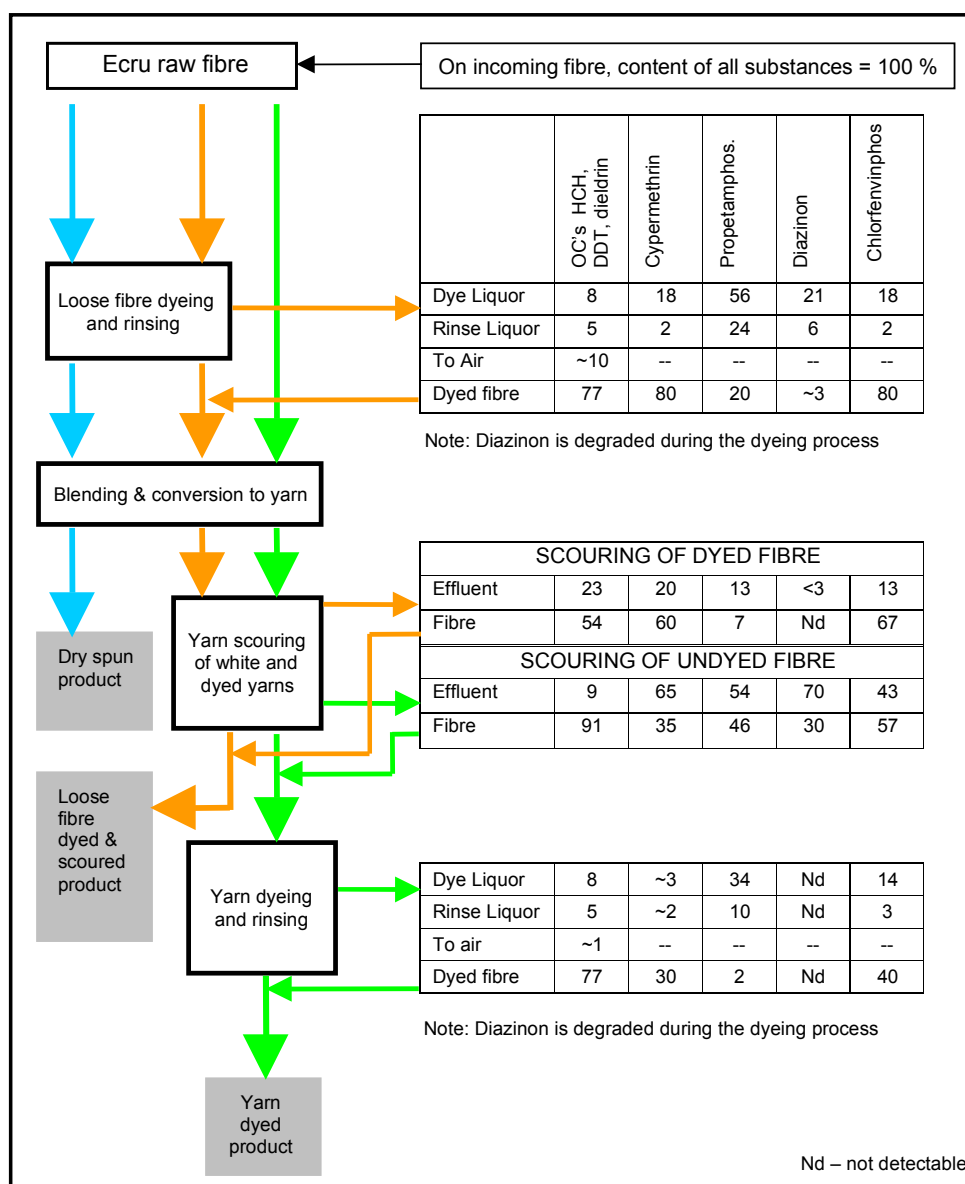


Figure 3.13: Waste water: fibre partition coefficients for OC, OP and SP pesticides in wet processing

Source: [32, ENco, 2001]

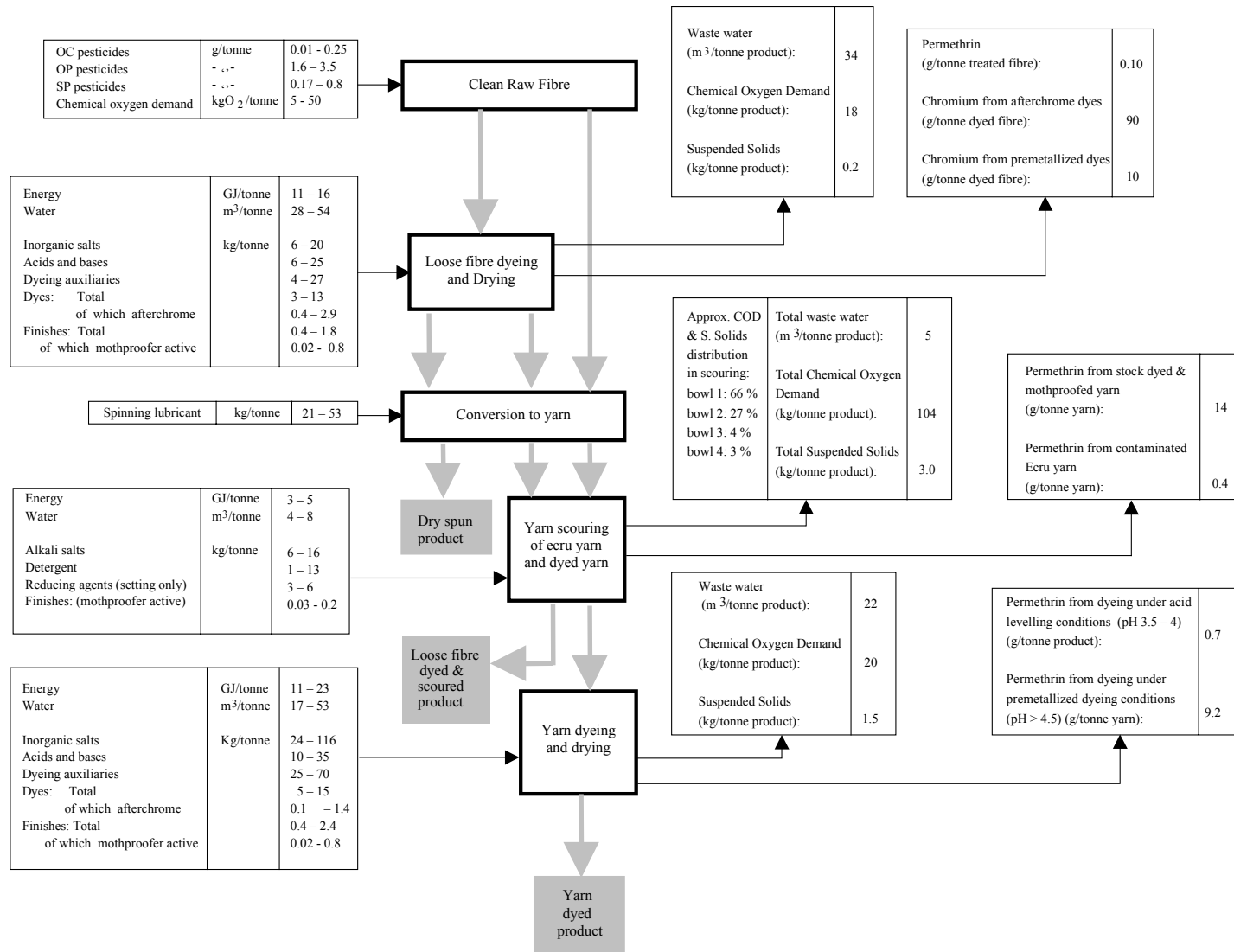


Figure 3.14: Diagram showing the ranges of inputs to and indicative output from wool and wool-blend carpet fibre wet processing [32, ENco, 2001]

3.4.2 Integrated carpet manufacturing companies

Table 3.56 reports data for waste water emissions from two carpet finishing mills. Here, specific consumption is not related to kg but to m². There is limited information available for the finishing of carpets in piece form. Therefore the examples in the table are intended to give only a preliminary insight [179, UBA, 2001].

	TFI 1	TFI 2
specific Q _{ww} (l/m ²)	14.7	35.6
COD Conc. (mg O ₂ /l)	1980	1670
E-Fac (g/m ²)	29	59
BOD ₅ Conc. (mg O ₂ /l)		490
E-Fac (g/m ²)		17
AOX Conc. (mg Cl/l)		0.28
E-Fac (g/m ²)		0.01
HC Conc. (mg/l)		
E-Fac (g/m ²)		
pH	7	6.8
L(mS/cm)	0.73	
T(°C)	29	37
NH ₄ Conc. (mg/l)		
E-Fac (g/m ²)		
org.N Conc. (mg/l)		
E-Fac (g/m ²)		
Cu Conc. (mg/l)	0.3	
E-Fac (mg/m ²)	4.4	
Cr Conc. (mg/l)	0.11	
E-Fac (mg/m ²)	16.2	
Ni Conc. (mg/l)		
E-Fac (mg/m ²)		
Zn Conc. (mg/l)	0.23	
E-Fac (mg/m ²)	3.4	
Source: [179, UBA, 2001]		
Notes: Blank cells mean that relevant information is not available		

Table 3.56: Concentration values and textile substrate-specific emission factors for waste water from two carpet finishing mills

Both sites are integrated plants where dyeing, printing and back-coating are carried out. TFI 1 dyes only in discontinuous, whereas TFI 2 is one of the few plants dyeing with the Carpet-O-Roll method. Both sites use the rotary printing technology.

As for waste water flow, the exhaust dyeing section accounts for the highest share (about 80 %), followed by the printing section (18.5 %). The waste water from the application of latex (this process is carried out only in TFI 1) results from cleaning of the application equipment and accounts for about 1.5 % of the discharged volume. This effluent is usually treated by flocculation/precipitation, resulting in considerable amounts of sludge to be disposed of.

The applied chemicals are grouped as dyestuffs, textile auxiliaries and basic chemicals. The values from the two mills are as follows:

- dyestuffs: 2.1 - 3.4 (g/m² carpet)
- auxiliaries: 21.6 (g/m² carpet)
- basic chemicals: 4.4 (g/m² carpet)

For one mill the sum of textile auxiliaries and basic chemicals is 55.2 g/m².

The specific consumption of electricity of the two mills is 0.9 and 1.3 kWh/m². The consumption of oil or natural gas is not available.

3.4.2.1 Analysis of some relevant specific processes for carpet manufacturing mills

There is no detailed information available that can provide a realistic picture of emission and consumption levels for specific processes in this category of mills. The only process-specific data presented in this section regard air emissions from carpet backing lines. Data are based on measurements carried out in a sample of carpet manufacturing mills over the period 1996 - 2001.

Table 3.57 gives an overview of the composition of the off-gases from two typical carpet backing lines (textile backing and foam backing).

As Table 3.58 shows the main pollutants found in the exhaust air are VOC, measured as total organic carbon.

Hazardous substances such as 1,3 butadiene and 4-vinyl-1-cyclohexene can be emitted from latices. However, nowadays their concentration is low, especially the 1,3 butadiene content which is normally below 1 mg/kg.

Ammonia, which is mainly used as stabiliser for the latex, is also often found in the emissions. Latices with only very small amounts of ammonia or even ammonia-free latices are available on the market today.

Textile backing (2001)		Foam backing (1996)	
Off gas components	($\mu\text{g}/\text{m}^3$)	Off gas components	($\mu\text{g}/\text{m}^3$)
Benzene	13.9	Diphenylamine	15.2
Ethylbenzene	140.9	Isothiocyanatomethane	118.66
Propylbenzene	167.8	2,2,6,6-tetramethyl-4-methylenheptane (Dodecene A)	10
Cumene	165.5	2,2,4,6,6-pentamethyl-3-heptene (Dodecene B)	518.14
Total other alkylbenzenes	374.9	4-phenylcyclohexene	4986.01
Styrene	658.9	Cumene	486.5
4-Phenylcyclohexene	258.5	Cyclohexanol	62.79
Total other alkenylbenzenes	73.2	Ethylbenzene	255.01
Acetophenone	19.0	Propylbenzene	193.81
Benzaldehyde	n.a.	Propenylbenzene	541.87
Diphenylcyclohexadienone	521.3	Styrene	739.63
4-vinylcyclohexene	91.6	Total xylols	198.26
Total not identified aromatics	n.a.	Total alkyl cyclohexane	150.3
Total alkylcyclohexanone	180.1	Total ethyltoluene + trimethylbenzene	1779.86
Ethylhexanale	56.4	Toluene	144.06
Total alkyl cyclohexanols	239.3	vinylcyclohexene	378.74
Trimethyl cyclohexan methanol	n.a.	Decane	193.81
2-ethylhexanol	2413.6	Decanol	174.03
Total not identified alcohols	48.6	Dimethylheptene	10
Isopropylmyristate	99	Hexylene glycol	19.17
Total alkyl cyclohexanes	2271.3	Total other alkenes	1740.31
Undecane	51.9	Total other alkylated benzenes	2729.12
Dodecane	39	Total not identified glycols	31.06
Tridecane	137.1	Total tetramethyl benzenes	193.81
Tetradecane	68.9	Tridecane	197.76
Total other aliphatic hydrocarbons	49	Undecane	229.4
Total not identified alkenes	n.a.	Total methoxy trimethylsilane + butandiol	30.4
Total not identified compounds	903	Total other aliphatic hydrocarbons	205.8
Total listed compounds	9042.7	Total listed compounds	12333.51
Total all compounds (as toluene equivalent)	11115.3	Total all compounds ⁽¹⁾	16313.50
Source: [280, Germany, 2002]			
Note:			
⁽¹⁾ Total aromatics measured: 12626.66			

Table 3.57: Overview of the composition of the off gases of two typical carpet backing lines (textile backing and foam backing). Analysis was performed by GC/MS

Textile company	Process	Production data			Ammonia			Total Organic Carbon				VCH - Vinylcyclohexene					
		1 st latex (g/m ²)	2 nd latex (g/m ²)	Production rate (m ² /h)	Mass flow (kg/h)	Concentration (mg/m ³)		Mass flow (kg/h)	Concentration (mg/m ³)			Mass flow (g/h)	Concentration (mg/m ³)				
A	Textile backing	700	700	1285	0.25	20		0.16	13			No data available					
	Foam backing	800	1000	1084	0.50	39		0.43	34								
	Textile backing normal latex	725	1000	1220	0.07	5		0.27	19								
					0.05	3		0.27	20								
	Textile backing with normal latex pre-coating and ammonia-free latex binder	775	830	1260	0.06	4		0.19	13								
					0.05	3		0.19	13								
					0.04	3		0.17	12								
	Foam backing non gel	875	1010	960	0.71	5		0.33	24								
					0.05	3		0.33	24								
0.02					2		0.32	23									
B	Foam backing AA gel	1 st latex (g/m ²)	2 nd latex (g/m ²)	Production rate (m ² /h)	Mass flow (kg/h)	Dryer	Ultra-red field		Mass flow (kg/h)	Dryer	Ultra-red field		Mass flow (g/h)	Dryer	Ultra-red field		
		No data available			1080	0.60	17	35		No data available				No data available			
C	Needle felt	1 st latex (g/m ²)	2 nd latex (g/m ²)	Production rate (m ² /h)	Mass flow (kg/h)	Pre-dryer	Cylinder dryer	Cooling unit	Mass flow (kg/h)	Pre-dryer	Cylinder dryer	Cooling unit	Mass flow (total) (g/h)	Pre-dryer	Cylinder dryer	Cooling unit	
		No data available			732	0.04	4	2	2	0.69	77	31	12	0.0	0.00	0.00	0.00
					930	0.02	2	2	1								
D	Only pre-coating	1 st latex (g/m ²)	2 nd latex (g/m ²)	Production rate (m ² /h)	Mass flow (kg/h)	Pre-dryer I	Pre-dryer II		Mass flow (kg/h)	Pre-dryer I	Predryer II		Mass flow (predryer I) (g/h)	Pre-dryer I	Pre-dryer II		
		800			1260	0.67	28	37		3.75	72	262 ⁽¹⁾		0.4	0.05	No data available	
						0.64	27	36		3.71	65	262 ⁽¹⁾					
						0.66	27	37		3.63	68	254 ⁽¹⁾					

Textile company	Process	Production data			Ammonia				Total Organic Carbon				VCH - Vinylcyclohexene			
		1 st latex (g/m ²)	2 nd latex (g/m ²)	Production rate (m ² /h)	Mass flow (kg/h)	Pre-dryer	Ultra red field	Cooling unit	Mass flow (kg/h)	Pre-dryer	Ultra red field	Cooling unit	Mass flow (kg/h)	Pre-dryer	Ultra red field	Cooling unit
E	Needle felt	1 st latex (g/m ²)	2 nd latex (g/m ²)	Production rate (m ² /h)	Mass flow (kg/h)	Pre-dryer	Ultra red field	Cooling unit	Mass flow (kg/h)	Pre-dryer	Ultra red field	Cooling unit	Mass flow (kg/h)	Pre-dryer	Ultra red field	Cooling unit
		No data available			205	0.30	42	35	26	0.27	50	18	25	0.0	0.00	No data available
F	Backing line	1 st latex (g/m ²)	2 nd latex (g/m ²)	Production rate (m ² /h)	Mass flow (kg/h)	Backing line			Mass flow (kg/h)	Backing line			Mass flow (kg/h)	Backing line		
		300	230	2840	0.39	14			0.75	26			0.0	0.00		
					0.35	12			0.95	33			1.6	0.06		
					0.17	6			1.08	38			1.9	0.07		
G	Backing line	1 st latex (g/m ²)	2 nd latex (g/m ²)	Production rate (m ² /h)	Mass flow (kg/h)	Pre-dryer			Mass flow (kg/h)	Pre-dryer			Mass flow (kg/h)	Pre-dryer		
		800		1260	0.89	73			0.73	60			0.0	0.00		
					0.73	60			1.07	88			0.0	0.00		
					0.94	77			0.53	44			0.0	0.00		
		1500		1430	2.42	112			0.45	21			0.0	0.00		
					1.05	48			0.48	22			0.0	0.00		
H	Latex coating (indirect heated main stenter, direct heated pre-stenter)	1 st latex (g/m ²)	2 nd latex (g/m ²)	Production rate (m ² /h)	Mass flow (kg/h)	Concentration (mg/m ³)			Mass flow (kg/h)	Concentration (mg/m ³)			Mass flow (kg/h)	Concentration (mg/m ³)		
		No data available			0.53	0.5 (g/kg textile substrate)			0.6	0.6 (g C/kg textile substrate)			1.1	0.001(g/kg textile substrate)		
					No data available			0.3	0.3 (g C/ kg textile substrate)			No data available				
I	PP Hot melt coating	1 st latex (g/m ²)	2 nd latex (g/m ²)	Production rate (m ² /h)	Mass flow (kg/h)	Concentration (mg/m ³)			Mass flow (kg/h)	Concentration (mg/m ³)			Mass flow (kg/h)	Concentration (mg/m ³)		
		No data available			No data available			0.06	0.09 (g C/kg textile substrate)			No data available				
J	Latex coating (direct heated backing line)	1 st latex (g/m ²)	2 nd latex (g/m ²)	Production rate (m ² /h)	Mass flow (kg/h)	Concentration (mg/m ³)			Mass flow (kg/h)	Concentration (mg/m ³)			Mass flow (kg/h)	Concentration (mg/m ³)		
		No data available			0.031 – 0.132	0.05 – 0.23 (g/kg textile substrate)			1.3	0.7 (g C/kg textile substrate)			No data available			
					0.04 – 0.25	0.07 – 0.49 (g/kg textile substrate)			0.5	0.9 (g C/kg textile substrate)						

Textile company	Process	Production data			Ammonia		Total Organic Carbon		VCH - Vinylcyclohexene	
		1 st latex (g/m ²)	2 nd latex (g/m ²)	Production rate (m ² /h)	Mass flow (kg/h)	Concentration (mg/m ³)	Mass flow (kg/h)	Concentration (mg/m ³)	Mass flow (kg/h)	Concentration (mg/m ³)
K	Latex-coating (indirect heated pre-stenter)	No data available			0.023	9	0.021	8	No data available	
					0.076	11	0.153	22		
L	Latex-coating (indirect heated)	1 st latex (g/m ²)	2 nd latex (g/m ²)	Production rate (m ² /h)	Mass flow (kg/h)	Concentration (mg/m ³)	Mass flow (kg/h)	Concentration (mg/m ³)	Mass flow (kg/h)	Concentration (mg/m ³)
		No data available			0.157	30	0.142	27	No data available	

Source: [280, Germany, 2002]
⁽¹⁾ TOC mainly from unburned natural gas

Table 3.58: Example of process-specific emission data (measured data) from carpet baking lines

3.5 General issues concerning odour nuisances in the textile industry

Some processes in the textile industry are often accompanied by odour emissions.

Odour-intensive substances and typical ranges for odour concentrations are summarised in Table 3.59 and Table 3.60.

Substance	Possible source
Epsilon-caprolactame	Heat-setting of polyamide 6 and polyamide 6 blends; Paste and powder coating with PA 6 and PA 6-copolymers
Paraffins, fatty alcohols, fatty acids, fatty acid esters (less odour-intensive substances, but high concentrations)	Heat-setting of grey textiles and inefficiently pre-washed textiles
Hydrocarbons	Printing, wetting agents, machine cleaning, coating
Aromatic compounds	Carriers
Acetic acid, formic acid	Various processes
Hydrogen sulphide, mercaptans	Sulphur dyeing
Sulphur derivatives	Reducing agents, hot acid cracking in wool scouring mills
Ammonia	Printing (ex urea), coating, non-woven processing
Acrylates	Printing (ex thickening agents), coating, non-woven processing
Formaldehyde	Easy-care finishing, finishing of non-wovens, permanent flame retardants
Terpene (d limonene)	Solvents, machine cleaners
Styrene	SBR polymerisation, styrene addition to SBR compounds
4-Vinylcyclohexene (4-VCH)	SBR- polymerisation (4-VCH is a dimer of butadiene that is formed during SBR-polymerisation)
Butadiene	Monomere in SBR-polymerisation
4-phenylcyclohexene (4-PCH)	SBR- polymerisation (4-PCH is formed by reaction between styrene and butadiene)
Aldehydes	Singeing
Acroleine	Decomposition of glycerol
Phosphoric acid esters (esp. tributylphosphate)	Wetting agents, de-aeration agents
Phthalates	Levelling and dispersing agents
Amines (low molecular)	Various processes
Alcohols (octanol, butanol)	Wetting agents, antifoaming agents
Source: [179, UBA, 2001]	

Table 3.59: Odour-intensive substances in the textile industry

Substrate/Process	Range of odour concentration (OU/m ³)	Average odour concentration (OU/m ³)
<u>PA 6</u> Heat-setting grey fabric	2000 - 4500	2500
<u>PA 6</u> Finishing of thermofixed and pre-washed fabrics	500 - 2000	1100
<u>PES</u> Heat-setting grey fabric	1500 - 2500	2000
<u>PES</u> Finishing of thermofixed and pre-washed fabrics	500 - 1500	800
<u>CO</u> Finishing	300 - 1000	500
<u>Fibre blends</u> Heat setting	1000 - 2500	1500
<u>Fibre blends</u> Finishing of thermofixed and pre-washed fabrics	500 - 2000	1200
Sulphur dyeing		Up to 10000
Singeing		Up to 2500
<u>Non-wovens</u> (monomer-containing binders)		Up to 10000
<u>Printing (mansards)</u> - pigment - vat dyes (2 steps) - disperse dyes - vat dyes (discharge)		282 586 53 286
<u>Printing (steamer)</u> - pigment - disperse dyes - vat dyes (2 steps)		670 608 633
<u>Drying carrier-dyed textiles</u> ⁽¹⁾ - carrier: benzyl benzoate, phthalic acid ester - carrier: biphenyl, dimethyl phthalate - carrier: alkylphthalimide		800 - 2800 4800 478
Drying of textiles without carriers		4790
Source: [179, UBA, 2001]		
⁽¹⁾ Data are based on fabric that has been dyed but not dried; drying and air emission measurements were carried out on a laboratory scale		

Table 3.60: Typical examples of odour concentrations in some textile processes (OU: odour unit)

3.6 General issues concerning solid & liquid wastes generated in the textile industry

In textile finishing industries, many different solid and liquid wastes are generated and have to be disposed of. Some of them can be recycled or re-used, whereas others are incinerated or landfilled. There are also some wastes which (in a few cases) are treated in anaerobic digesters.

Many of these wastes are not specific to the textile finishing industry. A distinction is therefore made here between solid wastes that are specific to this sector and those that are not (see Table 3.61).

Wastes not-specific to the textile industry	Wastes specific to the textile industry
<u>Waste not in need of control</u> <ul style="list-style-type: none"> - Waste glass - Paper, paper board - Wood - Iron scrap (pipes, old machines) - Electric cables - Plastic drums (clean) - Metal drums (clean) - Non-contaminated plastic wrap 	<u>Waste not in need of control</u> <ul style="list-style-type: none"> - Waste yarn - Waste fabric (spoilt works, trials, selvedge cuttings) - Wastes from shearing and raising - Textile dust
<u>Waste in need of control</u> <ul style="list-style-type: none"> - Waste oil - Oil-contaminated cloths - Non-halogenated organic solvents - Soot from oil incinerators - Glue and adhesive agents - Contaminated packaging material - Electronic scrap 	<u>Waste in need of control</u> <ul style="list-style-type: none"> - Dyes and pigments - Residual padding dyeing liquors - Residual printing pastes - Residual padding finishing liquors - Oil-containing condensates from off-gas treatment (stenters) - Sludge from process waste water treatment
<u>Waste in need of high control</u> <ul style="list-style-type: none"> - Waste from oil/water separators - Halogenated organic solvents - PCB-containing condensers 	
Source: [179, UBA, 2001]	

Table 3.61: Solid and liquid wastes from textile industry

Usually, most of the textile waste is recycled.

Today, there are only a few mills that segregate high-loaded waste water streams, such as residual padding dyeing liquors and residual padding finishing liquors. Companies tend to apply these measures only when exceeding limits for COD, nitrogen or colour.

Conversely, it is more common to dispose separately of residual printing pastes. These pastes are disposed of in incineration plants or, in the case of reactive and vat printing pastes, in anaerobic digesters.

There are mills treating their waste water by flocculation/precipitation. The volume of sludge produced after dewatering (usually in chamber filter presses), including the water content (which is usually 60 – 65 %), is normally within the range 1 - 5 kg/m³ treated waste water. With a specific waste water flow of 100 - 150 l/kg, the amount of sludge to dispose of is 100 - 750 g/kg finished textiles [179, UBA, 2001].

4 TECHNIQUES TO CONSIDER IN THE DETERMINATION OF BAT

4.1 General good management practices

4.1.1 Management and good housekeeping

Description

The notes on management and housekeeping given here, although far from being exhaustive, attempt to point out some general principles and pollution prevention approaches that are almost universally applicable in textile mills.

Education/ training of employees

Staff training is an important element of environmental management. All staff should understand clearly the precautions needed to avoid resource wastage and pollution. Training should be resource- (chemicals, fibres, energy, water), process- and machinery-specific.

Senior management should have a clearly expressed commitment to environmental improvement, preferably in the form of an environmental policy and an implementation strategy, made available to all staff.

Equipment maintenance and operations audit

Machinery, pumps and pipework (including abatement systems) should be well maintained and free from leaks. Regular maintenance schedules should be established, with all procedures documented. In particular, attention should be paid to the following areas:

- machinery checking: the most significant components of the machinery like pumps, valves, level switches and pressure and flow regulators should be included in a maintenance checklist
- leak control: audits should be carefully conducted for broken and leaking pipes, drums, pumps and valves, not only in the water system but also from the oil heat transfer and chemicals dispensing systems in particular
- filter maintenance: regular cleaning and checking
- calibration of measuring equipment, such as chemicals measuring and dispensing devices, thermometers etc.
- thermal treatment units (e.g. stenters): all units should be regularly (at least once a year) cleaned and maintained. This should include cleaning deposits from the exhaust gas conducting system and from the intake system of the burner air inlet.

Chemicals storage, handling, dosing and dispensing

Each chemical should be stored according to the instruction given by the manufacturer in the Material Safety Data Sheet.

All areas where chemicals are stored or spillages are likely to occur should be bunded and it should be impossible for spillage to enter surface waters or sewers. Toxic and dangerous chemicals should be stored separately. More detail on these issues will be found in the horizontal BREF on Storage (which was in preparation at the time of writing).

First aid facilities should be available and evacuation and emergency procedures in place and rehearsed regularly. Records of accidents and incidents (near-misses) must be kept.

Transfer of chemicals from storage to machine is often prone to leakage or spillage. Pumps and pipework used for transfer must be regularly inspected (see “Equipment maintenance” above)

and provisions should be made to ensure the safety of manual transfer (including appropriate training of workers, use of buckets with leak-proof lids, etc.)

Accurate weighing, dispensing and mixing are fundamental to avoiding/minimising spillage in manual operation. However, an automated chemical dosing and dispensing system offers some important advantages over the manual method (better laboratory-to-dyehouse correlation; minimises the chance of worker injury when handling hazardous chemicals; faster delivery times, etc.)

Improved knowledge of chemicals and raw materials used

The process inputs and outputs should be known and regularly monitored. This includes inputs of textile raw material, chemicals, heat, power and water, and outputs of product, waste water, air emissions, sludges, solid wastes and by-products (see Section 4.1.2).

Prescreening of incoming raw materials (fibres, chemicals, dyestuffs, auxiliaries, etc.) is of the utmost importance for pollution prevention. The supplier should take the responsibility for providing adequate information that enables the mill to make responsible environmental evaluation, even on proprietary products.

The detailed information provided to the finisher about textile raw material tends to be limited to the technical characteristics of the textile substrate. Information from the supplier should include also the kind and amount of preparation agents and sizing agents, amount of residual monomers, metals, biocides (e.g. ectoparasiticides for wool) present on the fibre. These substances/impurities are carried over into the process and account for a significant percentage of the pollution load from textile mills. Improved knowledge of the raw material will allow the manufacturer to prevent or at least control the resulting emissions.

Minimisation/optimisation of chemicals used

In general the overall strategy for the minimisation/optimisation of the chemicals used should consider the following steps:

1. where it is possible to achieve the desired process result without the use of chemicals, then avoid their use altogether
2. where this is not possible, adopt a risk-based approach to selecting chemicals and their utilisation mode in order to ensure the lowest overall risk.

That said, possible measures of general applicability are:

- regularly revising the recipes in order to identify unnecessary chemicals (dyes, auxiliaries) so that they can be avoided
- giving preference in the selection of auxiliaries and chemicals to products with a high degree of biodegradability/ bieliminability, low human and ecological toxicity, low volatility and low smell intensity (see Sections 4.3.1 and 4.3.2)
- optimising the process by improving the control of process parameters such as temperature, chemical feed, dwell times, moisture (for dryers), etc.
- using high-quality water (where needed) in wet processes in order to avoid/reduce the use of chemicals to prevent side effects caused by the presence of impurities
- avoiding/ minimising any kind of surplus of applied chemicals and auxiliaries (e.g. by automated dosing and dispensing of chemicals)
- optimising scheduling in production (e.g. in dyeing: dyeing dark shades after pale shades reduces water and chemicals consumption for machine cleaning)
- giving preference to low add-on devices for chemicals
- re-using mother-baths whenever possible
- recovering vapour during delivery of volatile substances
- filling of tanks with volatile compounds using the following precautions:

- use of vapour balancing lines that transfer the displaced vapour from the container being filled to the one being emptied
- bottom loading to avoid splashing (for larger tanks).

Use of water and energy:

In order to develop waste minimisation options in a process, a detailed understanding of the plant wastes and operations is required. In particular, optimal use of water and energy should start from monitoring of water, heat and power consumption of sub-units of the process and characterisation of the facility waste streams. This general, but fundamental, approach is explained in Section 4.1.2.

Using this improved knowledge of the process, a number of low-technology measures can be identified. A *first group* of measures applicable to wet processes (in which water and energy consumption are often related because energy is used to a great extent to heat up the process baths):

- installation of flow control devices and automatic stop valves which link the main drive mechanism of the range to the water flow (e.g. on continuous washers – Section 4.9.2)
- installation of automatic controllers to facilitate accurate control of fill volume and liquor temperature (e.g. batch dyeing machines)
- substitution of overflow-flood rinsing method (in batch processes) in favour of drain and fill or other methods (e.g. smart rinsing) based on optimised process control (see Section 4.9.1)
- optimisation of scheduling in production (e.g. in dyeing: dyeing dark shades after pale shades reduces water and chemicals consumption for machine cleaning; in finishing: proper scheduling minimises machine stops and heating-up/cooling down steps)
- adjustment of processes in pretreatment to quality requirements in downstream processes (e.g. bleaching is often not necessary if dark shades are produced)
- combination of different wet treatments in one single step (e.g. combined scouring and desizing, combined scouring/desizing and bleaching – an example is given in Section 4.5.3)
- water re-use (e.g. re-use of final rinsing baths, dye bath re-use, use water for pre-washing carpets in after-washing, countercurrent flows in continuous washing– see Section 4.6.22)
- re-use of cooling water as process water (and also for heat recovery).

Note that whenever water is re-used/ recycled it is important to discriminate between water *usage* and water *consumption* of the process. When water is re-used in the process the overall water consumption naturally reduces.

A *second group* of options specifically focused on energy savings is:

- heat-insulation of pipes, valves, tanks, machines (see Section 4.1.5)
- optimising boiler houses (re-use of condensed water, preheating of air supply, heat recovery in combustion gases)
- segregation of hot and cold waste water streams prior to heat recovery and recovery of heat from the hot stream.
- installing heat recovery systems on waste off-gases – an example is given in Section 4.8.1
- installing frequency-controlled electric motors
- controlling moisture content in the circulating air and on the textile in stenters (see Section 4.8.1)
- proper adjustment of drying/curing temperature and drying/curing time.

Management of waste streams

The following general measures can be identified:

- separate capture of high-loaded waste streams from low-concentrated effluent to allow more efficient treatment
- separate collection of unavoidable solid waste
- reduction of packaging

- use of returnable containers
- recycling of textile wastes (textile residues, spoilt work, raising, etc.).

Main achieved environmental benefits

The main environmental advantages achievable by systematic performance of optimised housekeeping and management measures are savings in the consumption of chemicals, auxiliaries, fresh water and energy and the minimisation of solid waste and pollution loads in waste water and off-gas.

Workplace conditions can also be improved.

Operational data

Vary with the type of measure considered. Cross-references to fuller information about some techniques are given above.

Cross-media effects

None believed likely.

Applicability

Most of the described methods are cheap and do not require investment in new equipment, although the immediate applicability of some of the techniques in existing mills may be limited by considerations of space, logistics etc. and the need for major structural modifications. Particularly, space availability may be an issue in some existing plants if implementing measures such as the optimisation of boiler houses and the installation of heat recovery systems for off-gases [311, Portugal, 2002].

Some measures, such as the installation of automated dosing systems and process control devices, may be expensive, depending on how sophisticated they are.

The success of management and good housekeeping measures is largely dependent on the commitment and organisational skills of management. Tools such as EN ISO 9000 ff, EN ISO 14001 and EMAS will support this approach. Information and communication are required at company level and within the whole supply chain.

Economics

The described measures enable improved operational reliability and reproducibility, which is economically beneficial. The main economic benefits are savings in the consumption of energy, fresh water, chemicals, and in the cost of waste water, off-gas cleaning and discharge of solid waste.

Driving force for implementation

Cost savings, improvement of operational reliability, improved environmental performance and compliance with legislation are the main reasons for implementing good general management / good housekeeping.

Reference plants

Various textile finishing mills in Europe have implemented good general management practices to improve their environmental performance and are working in accordance with good housekeeping principles.

Reference literature

[192, Danish EPA, 2001], [179, UBA, 2001], [51, OSPAR, 1994], [77, EURATEX, 2000], [11, US EPA, 1995], [32, ENco, 2001], [187, INTERLAINE, 1999].

4.1.2 Input/output streams evaluation/inventory

Description

All environmental problems are directly linked with input/output streams. In the interests of identifying options and priorities for improving environmental and economic performance, it is therefore vital to know as much as possible about their quality and quantity.

Input/output stream inventories can be drawn up on different levels. The most general level is an annual site-specific overview.

Figure 4.1 indicates the relevant input/output streams. Starting from the annual values, specific input and output factors for the textile substrate can be calculated (e.g. litre of water consumption/kg processed textiles or g of COD in waste water/kg processed textiles etc.). Although these factors have their limitations, they allow preliminary comparisons with other sites or similar processes and they provide a baseline against which to start tracking on-going consumption and emission levels. Available data for different categories of waste water are presented in Chapter 3.

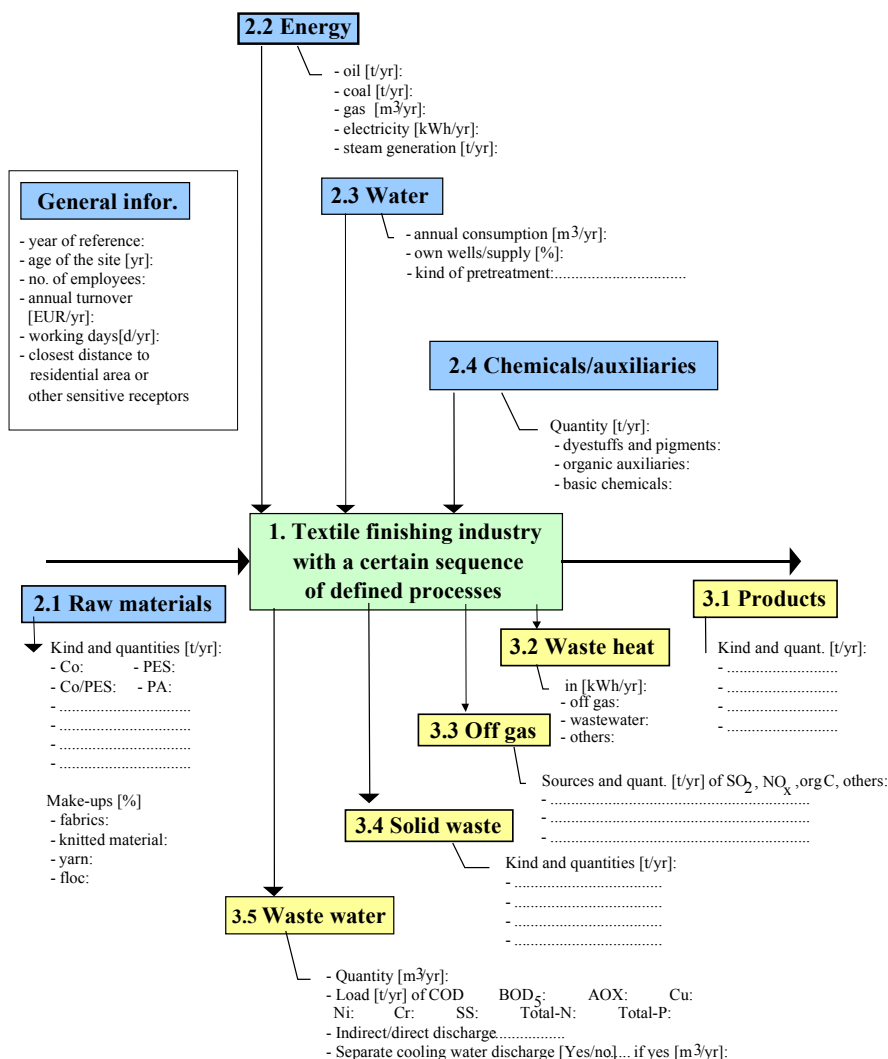


Figure 4.1: Scheme for annual input/output overview at site level [179, UBA, 2001]

The systematic listing and evaluation of applied chemicals (dyestuffs and pigments, textile auxiliaries and basic chemicals) is very important for identifying critical compounds. It is therefore recommended that eight forms be used, one for each of the following classes (see example in Table 4.1):

- auxiliaries and finishing agents for fibres and yarns
- pretreatment agents
- textile auxiliaries for dyeing and printing
- finishing assistants
- technical auxiliaries for multipurpose use in the textile industry
- textile auxiliaries not mentioned in the Textile Auxiliaries Buyer's Guide "Melliand/TEGEWA, 2000"
- basic chemicals (all inorganic compounds, all aliphatic organic acids, all organic reducing and oxidising agents, urea)
- dyestuffs and pigments.

The first six categories are identical with Textile Auxiliaries Buyer's Guide.

The following table shows an example form for dyeing and printing.

Form 3		TFI:								Year:	
3. Textile auxiliaries for dyeing and printing											
3.1 Dyestuff solubilizing and hydrophobic agents 3.2 Dispersing agents and protective colloids 3.3 Dyeing wetting agents, deaeration agents 3.4 Levelling agents 3.5 Carriers 3.6 Crease-prevention agents 3.7 Dyestuff protecting agents, boil-down protecting agents 3.8 Padding auxiliaries 3.9 Fixing accelerators for continuous dyeing and printing 3.10 Aftertreatment agents for fastness improvement 3.11 Bonding agents for pigment dyeing and printing 3.12 Printing thickeners 3.13 Emulsifiers for gasoline printing 3.14 Agents to remove printing thickeners 3.15 Printing and edge adhesives 3.16 Oxidizing agents 3.17 Reducing agents 3.18 Discharging agents and discharging assistants 3.19 Resist agents 3.20 Mordants 3.21 Brightening and stripping agents 3.22 Fibre-protective agents 3.23 pH-regulators, acid and alkali dispensers											
N°	Commercial name	Chemical characterization	Process, application	Danger symbol	Annual consumption (kg/yr)	Biological degradation / elimination (%) and testing method	Spec. COD-value (mg O ₂ /g)	Spec. BOD ₅ -value (mg O ₂ /g)	Heavy metal content (mg/g)	Org. halogen content (mg/g)	COD-load (kg/O ₂ /yr)
3.16	Revatol S Gran.	Nitrobenzene sulphonic acid, Na-salt	dyeing	Xi	5400	>90; OECD 302 B	0.990				5346
3.04	Alvicon OG-BM fl.	Formulation of surfactants and high-boiling alcohols	dyeing	----	3800	>80; after adaptation	0.760				2888
3.17	Cyclanon ARC Ptv.	Sulphinic acid derivative and dispersing agent	dyeing	Xi	3650	20 - 70; OECD confirmatory test	0.335				1223
3.02	Lamepon UV fl.	Polysaccharide	dyeing	----	2500	>70; OECD 302 B	0.350				875
3.04	Drimagen E2R fl.	Aromatic polyether sulphionate	dyeing	Xi	1300	46; OECD 302B	0.616				801
3.23	Sandacid PBD fl.	Aliphatic carbonic acid derivative	dyeing	---	1250	80; OECD 302 B	0.309				386
3.04	Peregad P fl.	Polyamidoamine	dyeing	----	850	>70; OECD confirmatory test	0.430				366
3.23	Egasol 910 Plv	Mixture of organic and inorganic salts	dyeing	Xi	620	---	---				
3.10	Indosol E-50 fl.	Aliphatic polyamine	dyeing	---	480	89; OECD 302 B	0.420				202

Table 4.1: Form for the listing of textile auxiliaries for dyeing and printing [179, UBA, 2001]

The listing allows a first rough assessment of the applied chemicals and a calculation of COD input to the process. The information on biological degradation/elimination is the basis for the selection of products with higher biodegradability/bioeliminability. The full picture, however, can only be had by assessing each of the ingredients of the commercial formulations used. In addition, the information on biological degradation/elimination often has to be critically questioned with respect to the properties of chemicals and the testing methods.

The next level is the process or machine level. Chapter 3 contains examples of analysis of consumption and emission levels for some specific processes. In many cases this level of information directly leads to identification of options for improvement and optimisation.

Figure 3.9 shows an example of input/output assessment at process-specific level (the example deals with energy and water consumption, but the same approach can be applied for other parameters).

Main achieved environmental benefits

The described evaluation and inventory of input/output mass streams is an essential management tool for the identification of optimisation potential, both environmental and economic. It is the prerequisite for a continuous improvement process.

Operational data

The application of such a management tool requires highly qualified staff and management commitment at the highest level. The work of such experts generally pays for itself, but this is not yet widely understood.

Cross-media effects

There are no cross-media effects to be mentioned. On the contrary, the input/output streams assessment/inventory allows cross-media effects to be taken into consideration during the assessment of potential optimisation options. This means the achievement of a high level of protection of the environment as a whole.

Applicability

The technique is applicable to both existing and new installations. Provided that the management of a company is convinced of the benefits of such a tool, there are no limitations in applicability, regardless of the size of the mill.

Economics

There is no specific information available on economic aspects but, generally speaking, because of the big potential for improvements in the textile sector, the application of the described management tool pays for itself within a short time [179, UBA, 2001].

Driving force for implementation

Saving on raw materials and production costs is good business. The application of this type of approach makes it easier to implement environmental management systems under EMAS/ISO 14001.

Reference plants

There are various textile finishing industries in Western Europe which have implemented input/output streams evaluation and documentation as inventories on site level. Only a few are also systematically applying this instrument on process level.

References literature

[179, UBA, 2001]

4.1.3 Automated preparation and dispensing of chemicals

Description

Great improvements have been made in recent years in the automation of traditionally manual process steps, such as the preparation and dosing/dispensing of chemicals (as either aqueous solutions, powder or pastes) and even laboratory operations.

Automated colour kitchens and automated chemicals dosing and dispensing systems are now commonly applied in many companies in the textile industry. Microprocessor-controlled dosing systems meter chemicals automatically according to a variety of profiles, such as constant rate or variable rate.

In the case of highly concentrated padding liquors for pretreatment, dyeing and finishing (continuous and semi-continuous processes), it is of environmental relevance to prevent or to minimise excess liquors. Today, there are automated systems available for just-in-time-preparations of liquors. With on-line measurement of the liquor pick-up and of the quantity of processed fabric, the exact amount of liquor can be prepared and added. Liquor surpluses and waste water pollution are therefore minimised.

Moreover, in modern dosing and dispensing systems, the water used for washing the preparation vessel and supply pipes is taken into account when the quantity of liquor to be prepared is calculated. This approach reduces waste water, but still involves premixing of chemicals. Other automated dosing systems are available where the chemicals are not premixed before being introduced into the applicator or dyeing machine. In this case, individual streams are used for each of the products. As a result, there is no need to clean the containers, pumps and pipes before the next step, saving even more chemicals, water and time. This is an important feature in continuous processing lines.

Figure 4.2 shows an example of an automated systems for dispensing chemicals for the preparation of pretreatment and finishing liquors (without premixing of the chemicals). Similar devices can be used in semi-continuous (cold pad batch - see the relevant described technique in Section 4.6.7) and continuous dyeing.

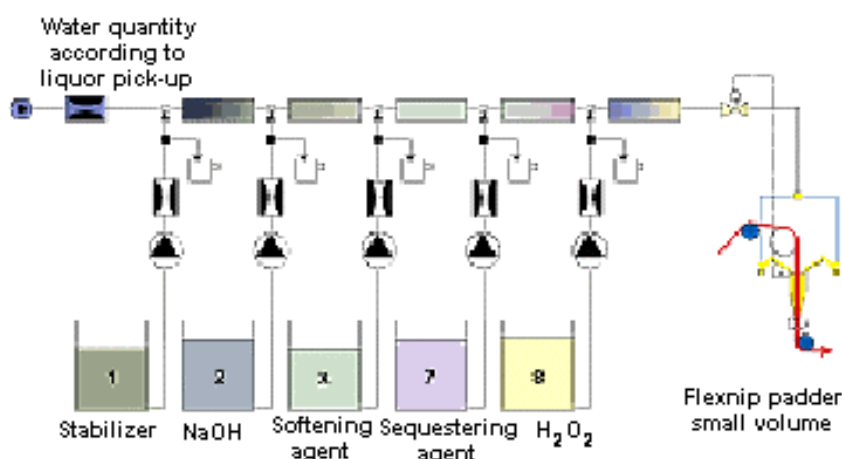


Figure 4.2: Example of automated systems for dispensing chemicals

In addition to the improvements mentioned above, the most recent developments in dosing systems for carpets and bulky fabrics, although expensive, are still worth mentioning. The most advanced equipment allows on-line real-time preparation, dosing and application of each of the individual components. The most innovative machines and application systems work on the colour-on-demand principle. There is no longer any need to make measurements; the liquors are injected or applied digitally and quantitatively. As a result, there are no liquor residues at the end of the process.

Important improvements have also been made in laboratory operations. All laboratory operations needed in batch dyeing can now be carried out with fully automated systems with practically no need for manual intervention. These sophisticated systems have been successfully applied in some large dyehouses.

Main achieved environmental benefits

Automation leads to a number of environmental benefits.

First of all, tighter control of the process allows for improved right-first-time performance, which means minimising corrective measures such as reworks, redyes, stripping and shade adjustment.

Secondly, automated systems with just-in-time preparation of liquors and separate dispensing of the different chemicals (i.e. no premixing) allow a significant reduction of waste water pollution and wasted chemicals thanks to the minimisation/ avoidance of liquor residues that would otherwise need to be disposed of at the end of the process. This is particularly important in continuous and semi-continuous processing.

Another important issue to consider is a safer and healthier working environment. Eliminating human contact means no workers handling and breathing toxic and hazardous substances.

Operational data

Highly automated systems generally require qualified personnel, but usually one person can easily operate the system.

Automated systems for powders are highly sophisticated, especially when very small amounts have to be metered. High precision in dosing is fundamental, especially for powder dyes. Modern automated dosing systems can dose amounts of powders as small as 0.8 g [289, Comm., 2002].

Data from a textile dyehouse (size 5500 t/year) show the following improvements before and after the installation of an automated dosing and dispensing system for chemicals [289, Comm., 2002].

	Before	After
Seconds	1.6 %	0.9 % (43 % reduction)
Reworks	4.5 %	3.7 % (17 % reduction)
Chemicals reduced costs		11.2 %
Labour reduced cost (in the dyehouse)		10 %
Increased dye machine efficiency		5 %

Another example comes from a well-known Italian manufacturer who, due to the installation of an automated dosing and dispensing system for dyes and auxiliaries, no longer needed a sampling operation on the batches and so was able to replace it with an extra daily batch on each machine [289, Comm., 2002].

Automated laboratories can reduce reworking to 2 – 3 % of total production.

Cross-media effects

There are no cross-media effects to be mentioned.

Applicability

Typical automated dosing and dispensing techniques described in this section are applicable to both new and existing installations. However, exception is made for highly sophisticated techniques such as dosing systems based on the colour-on-demand principle and automated laboratories, which are still very expensive and as a consequence more suitable for large installations.

According to information provided by equipment suppliers, the size and the age of the plant do not seem to represent a limitation in the applicability of automated dosing and dispensing systems in general. Examples are available of plants with production capacity ranging from 70 t/day to 5 t/day [289, Comm., 2002].

Space availability may represent an issue in existing companies, especially for the automation of dyes. Whereas liquid chemicals are easy to automatate due to the limited number of chemicals used in the process, some companies may regard the high number of dyes as a limitation due to lack of space and higher investment costs required.

It is not uncommon to find dyehouses with 150/200 different dyes for various reasons. However, in most cases it should be possible to use a maximum of 15 colours for each fibre, which means 90 dyes for 6 different types of fibre [289, Comm., 2002].

Usually the colourants that are used more frequently (highest consumption) are selected for automation. A typical situation is the one in which a company uses 60 colourants with a daily consumption of 5 - 6 kg and 20 colourants in amounts as low as 10 g/day. In such a situation, it is likely that the company will decide to automatise the 60 dyes with higher consumption and leave the others for manual dosing and dispensing. Very often this choice encourages the company in giving preference to dyes that are automatized, gradually reducing the consumption of the other dyes [289, Comm., 2002].

In automated systems with separate dispensing of the different chemicals, the resulting environmental benefits are particularly important where chemicals and auxiliaries are used in large amounts in the mill and in long continuous lines (where the dead volume in the distribution system is comparable with the volume in the paddler). When the different chemicals are not mixed before the process they can be easily re-used for the next run. Separate dispensing of each dye, although technically possible, is very expensive and advantageous only for trichromatic systems where a few dyes are used (maximum nine different dyes) and the volumes recovered are high enough to justify the investment.

Economics

Investment costs for the automated dosing of liquid chemicals, depending on the number of machines to be served, liquors to be prepared and chemicals to be used, range from EUR 230000 to EUR 310000. For powder dyes, the investment is between 250000 and 700000 euros, whereas for powder auxiliaries the prices range from a minimum of 110000 up to a maximum of 310000 euros. The reported figures do not include costs for pipes and conjunctions [289, Comm., 2002].

Cost savings can be derived from a reduction of consumption of chemicals and water, increase of reproducibility and decrease in staff costs. Savings of up to 30 % have been reported by [179, UBA, 2001].

Liquid chemicals are the most commonly automatised (first option in existing companies) due to health & safety reasons, but also due to the relatively low investment needed (limited number of chemicals used in the process) [289, Comm., 2002].

Driving force for implementation

The main driving forces for implementation are increased reproducibility and productivity along with health and safety requirements defined by legislation.

Reference plants

Plants with automated dosing and dispensing systems represent more than 60 % of the existing dye and printing houses in Europe. Automated systems for liquid chemicals are the most common (70 % of the plants), whereas automated dosing and dispensing for powder dyes and auxiliaries are present in 20 % of the European installations [289, Comm., 2002].

Some examples of installations using automated systems for just-in-time preparation of liquors are in Germany:

- Brennet AG, D-79704 Bad Säckingen
- Schmitz Werke GmbH + Co., D-48282 Emsdetten
- Görlitz Fleece GmbH, D-02829 Ebersbach
- Thorey Gera Textilveredelung GmbH, D-07551 Gera.

There are many examples of installations equipped with fully automated in Europe and worldwide.

Reference literature

[179, UBA, 2001], [171, GuT, 2001], [76, Colorservice, 2001], [289, Comm., 2002].

4.1.4 Optimising water consumption in textile operations

Description

Textile processing is known to be a water-intensive sector. Many techniques in this chapter, including some of the housekeeping measures already mentioned in other parts of this document, deal with reducing water consumption. Some aspects are common to many treatments. This section is intended to be a summary of the factors that may be of more importance for optimal water usage.

Controlling water consumption

A prerequisite of any programme to prevent unnecessary waste of water is to firstly collect information on the installation and the volumes consumed in the various processes. This kind of audit/assessment should actually be part of a wider programme involving the collection of information on types, quantities, composition and sources of all waste streams (see Section 4.1.2).

As with water consumption, data at site level is already a good benchmark in determining whether water consumption is excessive and is a good baseline against which to measure improvements. A process-specific analysis, however, is fundamental for setting priorities and identifying potential pollution prevention options. Water use should be monitored and recorded at machine/process level and water meters should be regularly maintained and calibrated.

Reducing water consumption

- by improved working practices

Inappropriate working practices and the absence of automated control systems can lead to significant wastage of water, e.g.:

- during filling and rinsing, for example, where machines are equipped only with manual water control valves there is potential for overfilling
- displacement spillage during immersion of the fibre in the machine may account for up to 20 % of total operating volume over the course of a dyeing cycle (this may also lead to losses of dyes and hazardous chemicals if these are introduced before the displacement takes place).

Well-documented production procedures and training are important. Dyeing machines should at least be fitted with modern process control equipment, capable of accurately controlling both the fill volume and the liquor temperature.

- by reducing liquor ratio

In *continuous* dyeing, the dye is applied in the form of a concentrated liquor. The volume of water consumed per kg of processed fabric in the dyeing process is therefore fairly low even when using conventional application systems (e.g. padders). This volume can be even lower in more recently developed application systems (e.g. fluidyer, foam, flexnip application systems, etc. – see Section 10.4.2).

As already explained in Section 2.7.8.2, in *batch* operations the amount of water used per kg of processed substrate is higher, although there has been considerable improvement in this field, too. All major machine manufacturers now have units for dyeing at low liquor ratio. An investment in such units pays because it cuts operating costs (energy, water, chemicals, dyes, etc.) and raises productivity by reducing processing times (see also Sections 2.7.8.2 and 4.6.19).

- by improving washing efficiency

In both batch and continuous processing, water consumption for washing is significantly higher than for the treatment itself (e.g. dyeing, etc.) (see also Section 2.7.8.2). Modern *continuous* washing machines have greatly improved their washing efficiency. In *batch* processes, it is not straightforward to achieve a high washing efficiency with little water and in a short time and therefore low liquor ratio does not always correlate with reduced water use as one might expect. Indeed it is not uncommon to find machines able to dye with a liquor ratio of 1:5 and then rinse with a liquor ratio of 1:10. Moreover conventional machines can only handle unloading by increasing the liquor ratio.

These problems were recently tackled by machine manufacturers and dyestuff suppliers. Recent technological developments have decreased specific water consumptions in batch processing to levels more typical of continuous operations. A constant liquor ratio across variable load sizes is now a standard feature of modern equipment for batch processes. Efficient washing techniques have also been especially developed for batch operations (see Section 4.9.1). Furthermore, various functions typical of continuous processing have been transferred to batch machines, such as (see Section 4.6.19):

- in-process separation of the bath from the substrate
- internal separation of process-liquor from the washing liquor
- mechanical liquor extraction to reduce carry-over and improve washing efficiency
- internal countercurrent flow in the batch washing process.

- by combining processes

Combining and scheduling processes reduces the number of chemical dumps. This is often feasible for pretreatment operations (e.g. scouring/desizing, scouring/desizing/bleaching – see for example Section 4.5.3). Combining pretreatment into the colouration stage is also possible in some cases.

Re-using water

Batch processes do not easily allow for water recycling. When trying to re-use waste water in batch operations, storage facilities for re-usable waste water must be provided. Other problems associated with re-use of waste water from batch bleaching and scouring are the non-continuous character of the waste stream and the higher liquor ratios.

Continuous countercurrent flow of textiles and water is now also possible in batch processing. Machines are now available with built-in facilities for waste stream segregation and capture. For example, the wash water from a previous load can be recovered and fully used in the bleach bath for the current load, which can then be used to scour the next load. In this way, each bath is used three times.

Some examples of water recycling and re-use are reported in this chapter (see Sections 4.6.22 and 4.7.7).

The internal separation of process-liquor from the washing liquor applied to some modern batch dyeing machines (see above) is essential to allow easier bath segregation and re-use, in cases where the characteristics of the liquor make it feasible.

Main achieved environmental benefits

Significant savings in water and energy consumption are possible (energy is used to a great extent to heat up the process baths).

Operational data

The following specific water consumption levels are considered achievable based on the data reported in Chapter 3 and expert judgement (assessment of the process, available machinery and applied techniques) [179, UBA, 2001]:

- | | |
|---|---------------|
| • finishing of yarn: | 70 - 120 l/kg |
| • finishing of knitted fabric: | 70 - 120 l/kg |
| • pigment printing of knitted fabric: | 0.5 - 3 l/kg |
| • finishing of woven fabric consisting mainly of cellulosic fibres: | 50 - 100 l/kg |
| • finishing of woven fabric consisting mainly of cellulosic fibres (including vat and/or reactive printing) | <200 l/kg |
| • finishing of woven fabric consisting mainly of wool: | <200 l/kg |
| • finishing of woven fabric consisting mainly of wool (for processes that require high liquor ratio): | <250 l/kg |

Cross-media effects

None believed likely.

Applicability

The principles described here are applicable at a general level.

Economics

In existing mills, investment in new equipment and/or structural modifications (e.g. for the segregation of streams) is likely to be necessary.

Reference plants

See cross-referenced techniques in other sections of this document.

Reference literature

[179, UBA, 2001], [204, L. Bettens, 2000], [208, ENco, 2001], [11, US EPA, 1995].

4.1.5 Insulation of High Temperature (HT) machines

Description

Insulation of pipes, valves, tanks and machines is a general principle of good housekeeping practice that should be applied at the general level in all processes.

In this section an example is given of the energy savings achievable by heat insulation of HT dyeing machines.

Main achieved environmental benefits

More rational use of energy.

It is reported that insulation can save up to 9 % of the total energy requirement on wet processing machines [146, Energy Efficiency Office UK, 1997]. An integrated approach to energy conservation is, however, preferable to *ad hoc* measures.

Operational data

The nature of the process means that insulation material may be exposed to water, chemicals and physical shock. Any insulation layer should therefore be covered or coated with a hard-wearing, chemical/water resistant outer layer.

Cross-media effects

None believed likely.

Applicability

General applicability.

Economics

A calculation of the payback for heat-insulation of HT dyeing units is given in the table below [179, UBA, 2001].

Reference data for calculation are as follows:

- thermal transmission coefficient for stainless steel 15.1 W/m²K
- thermal transmission coefficient for insulating material 0.766 W/m²K
- dyeing temperature 110 °C

• room temperature	30 °C
• HT-dyeing unit (average temperature 110 °C)	10 h/d
• processing time	230 d/yr
• gas costs	0.25 euros/m ³
• loss by energy transformation and transport	15 %
• dyeing unit 1 – front	17.5 m ²
• dyeing unit 2 – front	23.5 m ²
• dyeing unit 3 – front	31.6 m ² .

	Dyeing unit 1	Dyeing unit 2	Dyeing unit 3
Material costs - insulation (euros)	3838	5263	6500
Labour costs - installation (euros)	2000	2000	2000
Annual losses due to thermal radiation (MWh/yr)	45.4	60.9	81.9
Annual gas savings (euros/yr)	1434	1926	2590
Payback period (yr)	4.9	4.6	3.8
Source: [179, UBA, 2001]			

Table 4.2: Payback periods for heat insulation of dyeing units

Driving force for implementation

Savings in energy costs.

Reference plants

Many plants.

Reference literature

[179, UBA, 2001], [146, Energy Efficiency Office UK, 1997]

4.2 Quality management of incoming fibre

4.2.1 Man-made fibre preparation agents with improved environmental performance

Description

Man-made fibres cannot be produced and processed without auxiliaries. As a consequence of pretreatment operations (e.g. washing and heat-setting) these auxiliaries find their way into the waste water and exhaust air of finishing mills.

Among the auxiliaries used, coning oils and other preparation agents applied to the fibre after it has been manufactured have been identified as the major causes of the pollution in the downstream processes. This is due to the quality of the formulations employed and to the high loads applied (see also Section 2.6.4.2).

Conventional preparation agents are mainly based on mineral oils, with their well known disadvantages of high add-on, low temperature stability (they smoke during high-temperature treatments), poor biodegradability, presence of polyaromatic hydrocarbons and generation of difficult-to-sediment sludge in biological waste water treatment plants (see also Section 8.2).

Alternatives to the mineral oil-containing preparation systems are preparation agents based on [179, UBA, 2001]:

- polyether/polyester or polyether/polycarbonates
- special polyolesters
- special steric hindered fatty acid esters.

Main achieved environmental benefits

Alternative preparation systems are less volatile and have higher thermal stability. Moreover, they can be applied in lower amounts on the fibre. As a result, reduced odour nuisance in the workplace and reduced emission levels of organic volatile compounds in the exhaust air are achieved.

The table below compares the performance of the alternative products with the conventional systems in heat-setting conditions for grey materials.

Substance	Emission factor (g C/kg textile)	Concentration (mg C/m ³)
<i>Conventional products</i>		
Mineral oils	10 - 16	500 - 800
Classic fatty acid esters	2 - 5	100 - 250
<i>Optimised products</i>		
Steric hindered fatty acid esters	1 - 2	50 - 100
Polyolesters	0.4 - 4	20 - 200
Polyether/polyester or polyether/polycarbonates	0.2 - 1	10 - 50
Source: [179, UBA, 2001], [77, EURATEX, 2000]		
Notes: Preparation agent add-on: 2 %; air/textile ratio: 20 m ³ /kg; heat setting temperature: 190 °C; curing time: 1.5 min		

Table 4.3: Emission factors and corresponding organic-C concentration in the off-gas

The optimised products indicated in the table above are easier to wash out (lower consumption of water, energy and chemicals) and are in general characterised by a higher level of biodegradability compared to mineral oil-based preparation agents. Polyester-/polyetherpolycarbonates compounds, in particular, show extremely good biodegradability in comparison with mineral oils. Sterically hindered fatty acid esters, on the other hand, only represent an improvement with respect to classic fatty acid esters for air emissions from thermal treatment (thermofixation). They are in fact less volatile, but they are more difficult to biodegrade due to the increased branching of the chain.

Operational data

Yarn producer

Some machine components have to be made up of high-grade steel due to potential corrosion problems. With polyether/polyethercarbonate-based products compatibility problems with conventional hydrophobic preparation systems means that thorough equipment cleaning is needed following use.

Fabric producer

Because of compatibility problems the equipment has to be cleaned carefully (especially in the case of polyester-/polyethercarbonate-based auxiliaries).

Finishing mill

Processes in pretreatment have to be adjusted to the new preparation systems. In some cases (e.g. with polyester-/polyethercarbonate-based auxiliaries) washing steps in pretreatment can be simplified or even omitted.

Cross-media effects

Since new products are less volatile, off-gas emissions are reduced, but a higher amount remains on the fabric after heat-setting and eventually ends up in the waste water.

However, because of the lower quantities applied and the better biodegradability of the new products, the replacement will always bring benefits [179, UBA, 2001].

Applicability

Low-emission preparation agents are applicable on PES, PA 6.6, PA 6, CV and their blends with PES or CV. However, the applicability depends on the type of fibre and the particular end-use of the final product. As a result, specific trials should be carried out [179, UBA, 2001].

Commission finishers often receive no information from the supplier concerning the quality of preparation agents used. Conventional preparation agents are cheaper and spinning mills look mainly at the economic aspects and at the performance of a given substance in the spinning process. The environmental problems produced in the downstream processes (at the finishing mill) are not seen as a priority by spinning mills.

Economics

The following economic aspects affecting all members of the textile processing chain have to be taken into consideration [179, UBA, 2001].

Yarn producer

Low-emission auxiliaries are high-price products. This can be compensated by a lower add-on.

Finishing mill

Saving of exhaust-air cleaning equipment, simplified waste water treatment and prevention of oil-contaminated wastes will reduce investment, maintenance, and disposal costs.

Additional cost savings can be achieved with those preparation agents that allow total or partial omission of the washing step. Increased operational reliability is also to be expected.

Driving force for implementation

Minimising off-gas loads caused by preparation agents (compliance with national regulations) and water saving in washing are the main reasons for the use of low-emission preparation agents.

Reference plants

Some fibre/yarn and fabric producers in Europe are using low-emission preparation agents. Examples of fibre/ yarn producers are listed below [179, UBA, 2001].

Inquitex S. A.
Via Augusta 158, 5^a planta
E-08006 Barcelona

Nurel S. A.
P. delle Gracia 53
E-08007 Barcelona

Nylstar GmbH
Postfach 2209
D-24531 Neumünster

Nylstar CD Italy
Via Friuli 55
I-20031 Cesano Maderno (MI)

Textilwerke Deggendorf GmbH
Postfach 1909
D-94459 Deggendorf

Trevira GmbH & Co KG
D-60528 Frankfurt am Main

Unifi Textured Yarns Europe LTD.
Co. Donegal
Letterkenny, Ireland

Reference literature

[77, EURATEX, 2000], [179, UBA, 2001].

4.2.2 Mineral oils substitution in wool spinning lubricants

Description

Spinning lubricants are usually removed during pretreatment to ensure uniform penetration of the dye and finishing agents and to avoid reaction and precipitation with them. Since in the case of wool the processes that take place first in the finishing mill are wet treatments (washing/scouring), the presence of lubricants affects primarily water rather than air emissions.

In carded wool and wool blend yarns, where a higher load of lubricants is applied (compared to worsted wool) spinning oils (together with detergents used in the scouring process) may contribute up to 80 % of the oxygen-demanding load in dyehouse waste water [32, ENco, 2001].

Mineral oil-based lubricants were once used universally in the wool sector. These substances may not be fully degraded in biological sewage treatment works.

Moreover, the formulations of conventional spinning lubricants may contain variable amounts of even more hazardous substances such as polyaromatic hydrocarbons and APEO or other “hard surfactants” as emulsifiers (see also Section 8.2).

Mineral oils have now largely been replaced with formulations based on glycols and this trend continues. Biodegradable substitutes are readily available [32, ENco, 2001]. APEO compounds can now also be substituted by less problematic surfactants.

Main achieved environmental benefits

Elimination of mineral oil from scouring and dyeing waste water and the effluents received by sewage treatment works.

Using APEO-free spinning lubricant formulations helps to reduce the amount of potentially toxic endocrine disrupters in the receiving water.

Operational data

In the carpet sector, the use of mineral oil-based lubricants is reported to have been in decline for some years, indicating that carpet yarn of commercial quality can be produced without the use of this material [32, ENco, 2001]. It is believed that the same is valid for the textiles sector.

Cross-media effects

Compared to mineral oil-based lubricants, increased foaming in the waste water treatment may be observed.

There is some evidence that mineral oil-based lubricants are more amenable to on-site treatment than are the more water-soluble glycol-based products. Where there is on-site pretreatment, the choice of lubricant may be critical and mineral oil-based products may be the more viable option. Further research may be required [32, ENco, 2001].

Applicability

Spinning lubricants are applied during fibre blending. Undertakings which include the manufacturing processes leading up to wet processing, such as sales yarn spinning, and vertically-integrated companies have the means to control the use of these materials “in house”.

Commission dyers receive yarn on which the lubricant is already present. In these cases it would be necessary to work with clients to eliminate these materials from the supply chain [32, ENco, 2001].

Economics

The consequences of substituting one spinning lubricant for another are difficult to predict as the yarn yield (the quantity of yarn obtained from a given mass of raw fibre) is notoriously difficult to measure accurately and very small changes in yield markedly affect the economics of yarn production. The lubricant type and level of application can have a significant impact on yield [32, ENco, 2001].

Driving force for implementation

Environmental legislation.

Reference plants

Many plants in Europe.

Reference literature

[32, ENco, 2001]

4.2.3 Mineral oils substitution in knitted fabric manufacturing

Description

The production of knitted fabric requires an efficient lubrication of the needles and mechanical elements of the knitting machine. The quantity of lubricants used depends on the technology of the machine and its speed.

The yarn driven by the needles during the manufacturing of the fabric carries part of the lubricant. As a result, the final knitted fabric can contain about 4 – 8 % w/w of lubricant oils that then needs to be removed during pretreatment.

Conventional knitting oils (mineral oil-based formulations) can only be removed through emulsification using detergents, emulsifiers and antiredeposition agents. The process is carried out under alkaline conditions and at temperatures between 80 and 100 °C. Water consumption is approximately 10 l/kg of fabric, and the time required for the process is about 30 - 60 min.

The proposed technique suggests using hydrosoluble oils instead of conventional lubricants.

With knitted fabrics made of *cotton or cotton blends with synthetic fibres* these hydrosoluble oils can be easily washed out with water at 40 °C. This makes it possible to scour and bleach the fabric in one single step, thus saving time, water and energy.

Knitted fabrics made of *synthetic fibres* (e.g. polyester or polyamide) are often thermofixed before being washed. If conventional oils are present on the fabric, an intense emission of fumes is generated and the remaining oil becomes more difficult to remove from the fabric in the subsequent washings.

Also in this case it is often possible to use water-soluble oils instead of conventional lubricants and to carry out the washing step before thermofixation. Washing takes place in a continuous high-efficiency washing unit (e.g. TVE-Escalé type). After this step the fabric is sent to the stenter and then dyed, washed and finished. In this way emissions of fumes from the stenter are minimised.

Main achieved environmental benefits

Unlike conventional mineral oil-based lubricants, hydrosoluble oils can be easily washed out from the fabric. This helps reduce water, energy and chemicals consumption along with processing time. Moreover, these oils are reported to be biodegradable according to OECD test 301C [295, Spain, 2002], which makes the resulting effluent suitable for treatment in a biological waste water treatment plant.

With synthetic knitted fabric, one of the advantages of carrying out the washing step before thermofixation is that air emissions from the stenter can be significantly reduced without the need for air emission abatement equipment.

Operational data

The alternative hydrosoluble knitting oils described in this section produce emulsions which remain stable for three days [295, Spain, 2002].

Cross-media effects

Provided that the water-soluble knitting oils used in substitution of the conventional ones are biodegradable and that the fabric is processed in high-efficiency washing machines, a net environmental benefit is achieved.

Applicability

The technique is applicable to new and existing plants. However, corrosion problems have been observed in some existing plants.

As for the types of fibres, the referenced hydrosoluble oils are suitable for knitted fabrics made of cellulose fibres and blends, as well as fabrics made of synthetic fibres, mainly polyester and polyamide, and their blends with natural and synthetic fibres, including elastane.

Nevertheless, since the technique implies that the company has direct control on the type of lubricants used during the knitting process, implementation can be problematic for non-integrated mills and in particular, for commission finishers. In these cases it would be necessary to work with clients to eliminate these materials from the supply chain.

Some synthetic knitted fabrics need to be thermofixed before washing. In this case another option is the “dry route”: the fabric is submitted to thermofixation before washing and the resulting fumes are treated in an electrostatic precipitator with subsequent recovery of the oil. The advantage is that the recovered oil can be disposed of separately, thereby reducing the contamination of the water effluent. Energy recovery is another feature of this technique. More details are given in Section 4.10.9.

Economics

The overall cost balance of this technique is comparable with the conventional one. The referenced water-soluble knitting oils are more expensive than the mineral oil-base ones, but this extra cost is compensated by the higher productivity and by the higher treatability of the effluent resulting from pretreatment.

Driving force for implementation

The strict limits set by environmental legislation for emissions to air and water favour the implementation of this technique.

Reference plants

Many plants.

Reference literature

[295, Spain, 2002].

4.2.4 Selection of sizing agents with improved environmental performance

Description

Sizing agents are applied to warp yarn in order to prevent thread breakage during weaving. For subsequent processing, the sizing agents need to be removed almost completely from the fabric. This is done in the desizing step, often with a large amount of water and the addition of auxiliaries. The resulting effluent is responsible not only for high COD/BOD load (about 30 to 70 % of the overall COD load), but also for the presence of difficult to degrade substances that may pass through the final treatment. In some cases sizing agents may be recovered from the desizing liquor. More often, however, the effluent is treated in the waste water treatment plant.

Along with low add-on techniques such as prewetting (see Section 4.2.5), targeted selection of sizing agents may also contribute significantly to the reduction of the environmental impact of this operation.

Environmentally-optimised sizing agents should be:

- highly efficient with low add-on
- completely and easily removed from the fabric
- readily biodegradable or bioeliminable (>80 % after 7 days according to OECD-test 302 B).

It is now accepted that readily biodegradable/ bioeliminable sizing agent formulations are available, covering all needs. Modified starches, certain galactomannans, polyvinyl alcohol and certain polyacrylates satisfy this requirement.

Furthermore, latest generation-polyacrylates are able to fulfil all the requirements listed above. Firstly, use of these high efficiency synthetic sizes instead of conventional modified starches allows a reduction in size add-on without any decline in weaving efficiency (in some cases, increased weaving efficiency is observed). Secondly, new generation-polyacrylates are easy to wash out and can be removed with little water and without additional auxiliaries.

The new polyacrylates can be applied as almost universal sizing agents for all kinds of fibres. Exceptions include filament polyester and some specific finishing treatments where the use of polyacrylates may give rise to quality problems. For example, technical problems in the finishing stage were experienced when using polyacrylates on cotton fibre that had to be submitted to pre-shrink finishing [281, Belgium, 2002].

For cotton, polyacrylates are applied in combination with other sizes, usually PVA, in order to increase the viscosity of the system

Main achieved environmental benefits

The application of biodegradable/bioeliminable sizing agents leads to significant reduction of the COD-load that may pass un-degraded through the waste water treatment plant and be discharged to natural waters.

Additional advantages are achievable when using the highly efficient, easy-to-wash sizing agents. Lower add-on means reduced COD load in the discharged effluent, while the fact that they are easily washed out means that significant savings can be obtained in chemicals, water and energy consumption. With advanced efficient washing machines only low quantities of water are needed to remove the size, without additional auxiliaries (e.g. emulsifiers) or long cycle times (lower energy consumption).

Polyacrylates, polyvinyl alcohol and modified starch are not only biodegradable/bioeliminable, but are also suitable for size recovery techniques. New polyacrylates have the additional advantage of being applicable as almost universal sizing agents. This means that they are potentially easy to re-use as sizes in weaving firms.

Operational data

The bioelimination curves of seven combinations of sizing agents based on modified starches, new generation-polyacrylates, polyvinyl alcohol and certain galactomannans, are shown in Figure 4.3 (see also “Reference Plants”).

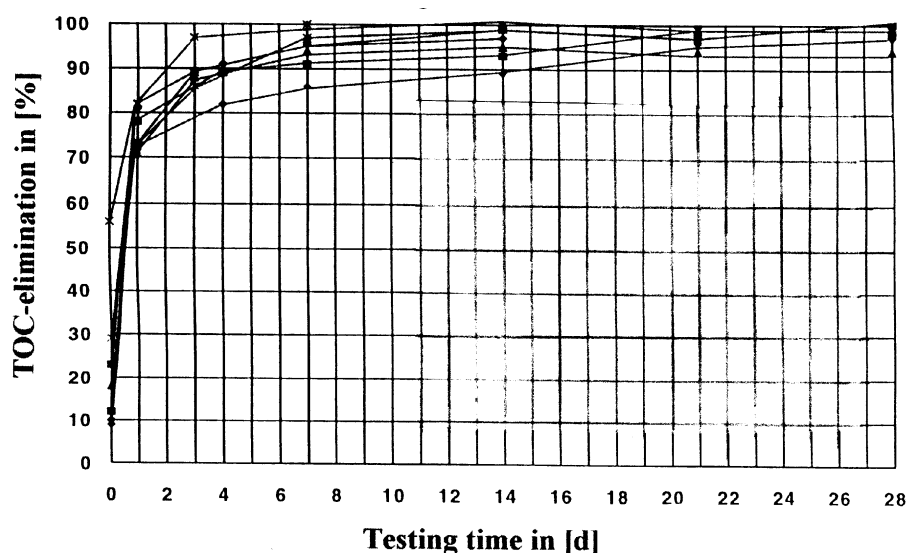


Figure 4.3: Bioelimination curves in the modified Zahn-Wellens Test (EN 29888) of seven combinations of different sizing agents which are bioeliminated to more than 80 % after 14 days [179, UBA, 2001]

Modified starches are water-removable (less easy than modified polyacrylates), without need for enzymatic or oxidative desizing. They are bioeliminable, but they give rise to bulky, viscose and filamentous sludge that is difficult to settle.

Polyvinyl alcohol is easy to wash out at mid-range pH and it is recoverable. In alkaline conditions, it swells and becomes highly viscose and difficult to remove. Polyvinyl alcohol is biodegradable only under specific system conditions such as adaptation of the activated sludge, temperatures not below 15 °C and particularly low food to micro-organism ratios (F/M-ratios) (see Section 4.10.1). In alkaline conditions, PVA gives problems with settlement.

As mentioned above, the new polyacrylates are highly efficient with lower add-on (see table below), they are removable with only water (no need for either enzymatic or oxidative desizing) and they also have high stability to alkalis (it is possible to bleach the fabric directly, without a preliminary scour). Unlike classic polyacrylates, the new ones are more than 90 % eliminated under the conditions of the Zahn-Wellens test, even in high concentrations, by adsorption on the activated sludge. Furthermore, they become insoluble by forming complexes with iron. In this way they can be precipitated almost totally with only a small amount of precipitant.

	Common recipe (modified starch, wax)	Alternative recipe (modified polyacrylate, PVA, wax)⁽¹⁾
Size add-on	13 %	10 %
Specific COD (g O ₂ /100 kg warp yarn)	17800	11550
Total COD (t/yr) ⁽²⁾	712	462
Reduction of COD-load	-	35 %
Source: [179, UBA, 2001] with reference to "Steidel, 1998"		
Notes:		
(1) typical operating conditions for sizing staple fibre yarn in air jet loom at 650 rpm are as follows: PVA: 7 kg; modified acrylate (liquid 25 %): 7 kg; wax: 0.4 kg; volume sizing liquor: 100 l; nip pressure: 20kN; sizing speed: 100m/min		
(2) calculated on an annual production of 4000 t warp yarn		

Table 4.4: COD reduction after replacement of conventional sizing agent by alternative recipe based on polyacrylates

Cross-media effects

The application of sizing agents with higher bioeliminability/biodegradability leads to an increased amount of sludge to be disposed of [179, UBA, 2001]. This sludge can be bulky, filamentous and difficult to settle.

Applicability

Although the application of optimised sizing recipes is technically feasible for all sizing departments, the world-wide organisation of the textile chain, makes it difficult for non-integrated mills and in particular, for commission finishers to influence the up-stream weaving mills [179, UBA, 2001].

Economics

In most cases, biodegradable/bioeliminable combinations of sizing agents are no more expensive than others that do not meet the high elimination rate requirement (>80 % after 7 days according to OECD-test 302 B) [179, UBA, 2001].

Details are given in the table below, regarding, in particular, the application of alternative synthetic, high-efficiency sizes based on polyacrylates.

	Common recipe (modified starch, wax)	Alternative recipe (modified polyacrylate, PVA, wax) ⁽¹⁾
Costs for sizing agents (euros/yr)	260850	325850
Warp thread breakage (thread break/10 ⁵ picks)	5.8	3.0
Savings due to minimised thread breakage (euros/yr)	-	225000
Total savings (euros/yr) ⁽¹⁾	-	160000
Source: [179, UBA, 2001] with reference to "Steidel, 1998"		
Notes:		
⁽¹⁾ cost savings are calculated for a typical weaving mill working 8000 h/yr (100 weaving machines, 310 rpm)		

Table 4.5: Comparison between conventional and high-efficiency sizing agents

Driving force for implementation

In general the need to minimise discharged COD loads and increasing concern for environmental protection (see also EU Eco-label) are considered as the main driving forces in the selection of biodegradable/bioeliminable sizing agents [179, UBA, 2001].

The selection of biodegradable/bioeliminable sizing agents is also encouraged by initiatives at European level such as EU Eco-label, OSPAR, etc.

In addition, the substitution of conventional size recipes with highly efficient ones is economically motivated in the weaving mills, especially in combination with prewetting techniques (see Section 4.2.5), which can reduce size consumption by 1/3 or even more.

Reference plants

Environmentally-optimised sizing agents are largely applied world-wide in weaving mills.

UBA reports about a voluntary initiative in Switzerland of 20 weaving mills. Seven different bioeliminable formulations of sizing agents have been developed (see also Figure 4.3) and currently applied, which can cover all different kinds of substrates and weaving techniques. They are based on [179, UBA, 2001]:

- starches and starch derivatives
- certain polyacrylates,
- polyvinyl alcohol
- certain galactomannans.

Reference literature

[51, OSPAR, 1994] P003, P004, P005, P008, P047, [179, UBA, 2001], [18, VITO, 1998], [169, European Commission, 2001], [77, EURATEX, 2000].

4.2.5 Minimising sizing agent add-on by pre-wetting the warp yarns

Description

It is well known that in cotton finishing mills the desizing process accounts for 50 to 70 % of the total COD in the waste water. Minimising the amount of size applied on the warp yarn during fabric processing is one of the most effective pollution prevention techniques for reducing the organic load caused by sizing agents.

On-line monitoring/control of size add-on and prewetting technology are now available options.

The prewetting technology consists in running the warp yarn through hot water before the sizing process. The warp yarn is dipped into the hot water (an additional spraying of hot water may be possible), then a squeeze roller removes the surplus water before the sizing stage. Systems with two dipping and squeezing steps are also in use.

Prewetting allows a more homogeneous sizing effect, increased adhesion of the size and reduced hairiness of the yarn. From experimental analysis it seems that a lower “core-sizing” effect is produced. As a result, a reduced amount of size can be applied to the fibre without affecting weaving efficiency. In some cases, an increase in weaving efficiency can even be observed.

Main achieved environmental benefits

A reduced size load on the yarn means that a lower amount of sizing agent is discharged in the water during pretreatment, with immediate positive effects on the organic load of the final effluent.

Operational data

Depending on the setting of the warp beam and the type of yarn processed (e.g. density of the yarn, type of fibres in the blend), a reduction of the size add-on of about 20 - 50 % is possible.

Cross-media effects

None believed likely.

Applicability

Prewetting has now been tested in practice with all types of cotton yarns and blends of cotton/PES and viscose. Best results are achieved with medium to coarse yarns. Application is

possible for batches of more than 5000 m (better >10000 m), both for ring-spun and OE-yarns. On the contrary, the technique is not applicable to small batches (<5000 m) as the add-on cannot be controlled adequately. This is often the case for dyed yarns.

Technical problems may be observed in relation with the efficient measurement and control of high humidity percentages and with the calibration of the wetting device [281, Belgium, 2002].

Existing sizing machines with two sizing boxes can be reconstructed/upgraded by using the first sizing box for prewetting and the second one for sizing.

A high percentage of cotton fabric finished in Europe is actually imported from non EU-countries (e.g. India) where these control techniques are not yet widely used. As a result, from a practical point of view, this pollution-prevention measure is more easily and immediately applicable in integrated than in commission companies.

Economics

Sizing equipment with prewetting boxes is approximately EUR 25000 – 75000 more expensive than sizing equipment without a prewetting section. Operating costs are only marginally higher, because the additional expenditure for the prewetting water is compensated by the reduction in sizing liquor consumption.

A direct comparison between sizing with and without prewetting (operational data of an Italian weaving mill) shows cost savings of about 27 %, an increase in sizing machine speed of about 22 %, and an increase in weaving efficiency of about 0.2 % [179, UBA, 2001].

Driving force for implementation

Sizing agent savings, increase of weaving efficiency, as well as a reduction of waste water load (environmental cost savings) are driving forces for the implementation of the prewetting technology.

Reference plants

Worldwide about 100 prewetting boxes have been sold by Benninger Zell GmbH, Zell, Germany. About 60 prewetting boxes of Deutsche Babcock Moenus Textilmaschinen AG, Mönchengladbach are running in 40 plants. Another supplier for prewetting systems is Karl Mayer Textilmaschinenfabrik GmbH, Obertshausen, Germany [179, UBA, 2001].

Reference literature

[179, UBA, 2001]

4.2.6 Use of techniques that allow reduced load of sizing agents on the fibre (compact spinning)

Description

Normally, in ring spinning, after the draft system a spinning triangle is generated. At the moment, when they pass the spinning triangle, the fibres are not strengthened by twisting. Yarn breakage and yarn hairiness occur. In compact spinning the fibre strands are compressed after the draft system by means of pneumatic devices (application of low pressure) [179, UBA, 2001] with reference to “Artzt, 1995”. A higher yarn quality results (increased fibre strength and elongation, reduced hairiness, increased abrasion resistance).

Main achieved environmental benefits

Compared to conventional ring spun yarns, compact yarns have better running properties and less thread breakage during weaving even when the size add-on is reduced by up to 50 %. This leads to a considerable reduction in waste water load in desizing. Due to the reduced hairiness, application of paraffins to yarns is no longer necessary [179, UBA, 2001].

Operational data

No information was made available.

Cross-media effects

None believed likely.

Applicability

Applicability is proved for pure cotton yarns. It has to be taken into account that the appearance and technological properties of compact spinning yarns (and fabrics made of them) are different from those of conventional manufactured yarns. The lower hairiness of the yarns is an undesired effect in the case of yarns produced for knitted goods.

Adaptation of existing spinning machines is partially possible [179, UBA, 2001].

Economics

Additional costs in yarn manufacturing are partially or totally offset by cost savings in the weaving mill, due to higher weaving efficiency and reduced size add-on. Reduced costs in finishing are expected (e.g. lower waste water treatment cost due to the lower amount of sizing agents).

Driving force for implementation

A better yarn quality and the possibility to create new effects/designs are the main reasons for installing compact spinning machines.

Reference plants

At present about 250000 spindles are installed, mostly in Italy ("ITV, 2001").

Compact spinning machines are manufactured by

- Rieter Textile Systems, CH-Winterthur
- Zinser Textilmaschinen, D-Ebersbach
- Spindelfabrik Süssen, D-Süssen

Reference literature

[77, EURATEX, 2000], [179, UBA, 2001]

4.2.7 Minimising residues of organochlorine ectoparasiticides in the raw material by substitution

Description

Organochlorine ectoparasiticides may still be used, legally or illegally, for the treatment of sheep in some countries. The OCs are toxic in the environment, persistent and bioaccumulative. They are likely to have long-range effects and as such are the most hazardous ectoparasiticides found on wool. Several OCs are also suspected of having endocrine disrupting effects.

OCs are not used for sheep treatment in the mainstream wool producing and exporting countries. Wool from these countries may, however, contain OC pesticides at the trace levels consistent with contamination from background sources. Secondary sources of wool supply, from which OCs have not been eliminated, include Argentina, the Czech Republic, France, Spain, Turkey and the former Soviet States. At the present time the geographic source of the fibre is therefore the most reliable guide to its likely OC pesticide content.

A number of organisations maintain information on the pesticide content of greasy and scoured wool. Manufacturers can use this information to avoid processing suspect wool unless an analytical certificate showing its OC content to be less than 1 mg/kg is provided by the owner of the wool. In this way, the market for contaminated wool will be undermined and those wool producers still using OCs for sheep treatment will desist. In the absence of information, samples should be assayed to confirm their pesticide content, but this option entails higher costs for the manufacturer.

In wool dyehouses, the wool scouring process removes a significant proportion of the OCs present on greasy wool as these compounds partition with the wool grease into solid and liquid wastes arising from the scouring process (see Sections 2.3.1.2 and 3.2.1). Scoured wool thus contains less than 10 % of the original greasy wool pesticide burden.

Wool which is scoured to a low residual grease content would be expected to contain the lowest levels of OCs. There are, however, practical limits to the efficiency with which wool can be scoured and in some cases it is desirable to retain some lanolin on the fibre to aid further mechanical processing. Scoured wool with a residual grease content of between 0.4 and 1.0 % is generally regarded as optimal. Fibre with a residual grease content significantly higher than 1 % is unlikely to have passed through an efficiently operated scour and manufacturers should avoid using such materials, even as a small proportion of a blend, unless the pesticide content can be confirmed by analysis.

Main achieved environmental benefits

Emissions of OCs in waste water from wool scouring, dyeing and finishing operations, and from sewage works receiving textile effluents will be reduced. The environmental concentrations of OCs in surface waters receiving treated effluent will also fall. The concentrations in sewage sludge are also likely to fall.

The effectiveness of control measures can be judged by the following UK example. The River Calder in West Yorkshire receives treated textile effluents from the Dewsbury Sewage treatment works. This works receives waste water from ten dyehouses processing wool carpet fibre, two wool scouring companies and a fellmonger. The river is monitored regularly for compliance with EU Environmental Quality Standards.

Table 4.6 indicates river water concentrations (ng/l) downstream of the sewage works as reported by the regulator (Environment Agency) in the two years to June 2000. These data indicate that measures employed by the textile industry (and others) in this catchment area are sufficient to reduce emissions of OCs to below the limit of detection, and within EU Environmental Quality Standards.

	Gamma HCH ⁽¹⁾	Aldrin	Dieldrin	Endrin	DDT ⁽²⁾
EU Environmental Quality Standard (nanograms/litre)	100	10	10	5	25
Limit of quantification (nanograms/litre)	1.0	2.0	3.0	2.0	5.0
Total number of samples analysed in the 2 years to June 2000	27	24	27	27	23
Number of samples > limit of quantification	19	0	2	0	23
Maximum recorded value (nanograms/litre)	61	--	6.0	--	--
Minimum recorded value (nanograms/litre)	3.0	--	4.0	--	--
Mean recorded value ⁽³⁾ (nanograms/litre)	16.4	--	5.0	--	--
Number of samples < Limit of quantification	8	24	25	27	23
Number of samples Greater than EQS	0	0	0	0	0
Source: [32, ENco, 2001] Notes: (1) Alpha and Beta HCH also recorded for all samples at <1ng/l. (2) Sum of op and pp DDT (3) These values ignore those results less than the limit of quantification (LOQ). If all the results were taken into the calculation using half the LOQ as an estimate for those values <LOQ, the mean values would be 11.7 for Gamma HCH and 1.7 for Dieldrin.					

Table 4.6: Organochlorine pesticide concentrations in the River Calder below Dewsbury Sewage Treatment Works (UK). Data for 2 years to June 2000

Operational data

The occurrence of OCs in mill waste water depends on the mix of fibre being processed at any given time and is therefore likely to be highly irregular. In the majority of cases concentrations will be below the limit of reliable analytical detection. Analysis of mill effluents is, therefore, unlikely to provide a realistic estimate of releases. Monitoring of raw materials for the presence of OCs would provide a more realistic means of controlling inputs and hence outputs from the process stream.

At the present time individual batch testing of small fibre lots is not viable. However, information is available from a number of sources on the average OC content of wools from different geographic locations. Manufacturers should monitor the underlying trends in these data to avoid processing potentially contaminated wool.

Cross-media effects

Effects on all media are expected to be positive.

Applicability

This technique can be applied by all manufacturers who purchase their own raw materials and by commission scouring and finishing mills with the co-operation of their clients.

However, if mills are to be required to turn away business, they must be assured of a level playing field, i.e. that the measure will be adopted and enforced throughout the European Union.

UK mills currently minimise their release of the organochlorine compounds known to be present on wool from some sources by selective purchase or, if the source is suspect, by certification. This strategy has proved successful, particularly in the case of companies who purchase their own raw materials. Although further down the supply chain, commission companies are able to regulate their incoming material quality by requesting data from suppliers.

Economics

Substituting one supply source for another on the basis of pesticide content may have major cost implications for the industry. Maintaining a profitable business partially depends on striking a balance between these two factors and purchasing wool with the correct technical specification (fibre diameter, fibre length, colour, etc.) at the most economic price.

For merchants and topmakers the cost of sampling and analysing a wool batch of, say, 10 tonnes would be approximately 200 euros or 0.02 euros/kg. There would possibly be expensive logistical problems for wool batches which tested above the limit. The solution for the importer would be to insert appropriate conditions into his contract and to have the wool sampled and analysed before export from the country of origin. Quality assured sampling, analysis and certification would be essential.

This cost would eventually reduce to zero, as the technique has its effect in discouraging the use of OCs for sheep treatment in wool-producing countries and it becomes possible to assume that fewer and fewer sources are producing wools potentially contaminated with OCs.

Driving force for implementation

The driving forces are prevention of aquatic pollution and long-range effects, an increase in the probability that sludge can safely be disposed of to agriculture, and a reduction of OCs in wool grease.

Reference plants

The selective processing and purchase of wool to control OC emissions is already practised by UK wool scouring companies and wool dyers.

CSIRO in Australia is promoting testing and certification schemes in order to allow European processors to purchase Australian wool with confidence.

Reference literature

[32, ENco, 2001], [187, INTERLAINE, 1999], [97, CSIRO, 2000], [202, Ian M. Russel, 2000].

4.2.8 Minimising residues of organophosphate and synthetic pyrethroid ectoparasiticides in the raw material by substitution

Description

Other compounds, typified by the OPs and SPs used legally in animal husbandry, are more difficult to manage by substitution than OCs. The occurrence of OP and SP pesticides in mill waste water will depend on the mix of fibre being processed at any given time and as such is likely to be highly irregular. Waste water concentrations may be below the limit of reliable analytical detection. Monitoring of raw materials for the presence of OPs and SPs would provide a more realistic means of controlling inputs and hence outputs from the process stream.

Wool from some minor sources is known to be essentially free of OP and SP residues, either because these materials are not available in those countries or because the climate or local practice dictates that they are not used. The quantities of fibre available from these sources are small and opportunities to increase production to meet global market demand is limited. Widespread substitution using wool from these sources is not considered viable.

In mainstream wool producing countries the competent bodies responsible for wool production and marketing have recognised the importance of minimising OP and SP residues by good flock management, controlled application procedures and the use of recommended withholding periods between sheep treatment and wool harvesting. At the time of writing, co-operation programmes with leading grower countries have resulted in a progressive reduction of the mean OP and SP residues on wool. The industry continues to develop these strategies, which may in time lead to the widespread availability of low pesticide wool lots, perhaps supported by certification.

Manufacturers should encourage the development of low pesticide residue wool by continued dialogue with the major producer countries.

Main achieved environmental benefits

Emissions of OPs and SPs in waste water from dyeing and finishing operations and from sewage works receiving textile effluents will be reduced. The environmental concentrations of these compounds in surface waters receiving treated effluent will also fall, likewise the concentrations in sewage sludge.

Operational data

At the present time there is no widespread selection of wool on the basis of OP and SP pesticide content. It could be said, therefore, that there is no direct operational experience at the time of writing [32, ENco, 2001]. However, the sector acting through trade associations and wool promotion bodies has influenced the wool production industries of major producing countries to the extent that the majority now have in place pesticide reduction programmes, which are progressively reducing average clip concentrations.

A low-residue certification scheme is, for example, currently promoted by CSIRO Textile and Fibre Technology in Australia.

The resources required to achieve a reduction in average clip concentration are considerable, but the effectiveness of this strategy can be illustrated by reference to data on the average OP and SP content of the Australia and New Zealand wool clip in recent years (see figures below).

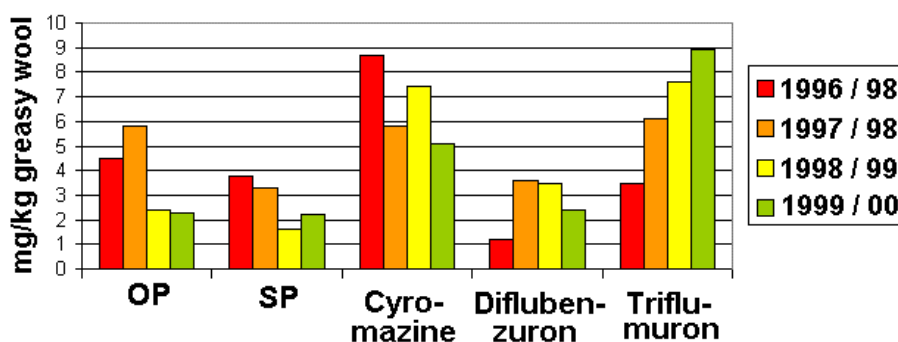


Figure 4.4: Residues on Australian fleece wool 1996 to 1999 [202, Ian M. Russel, 2000]

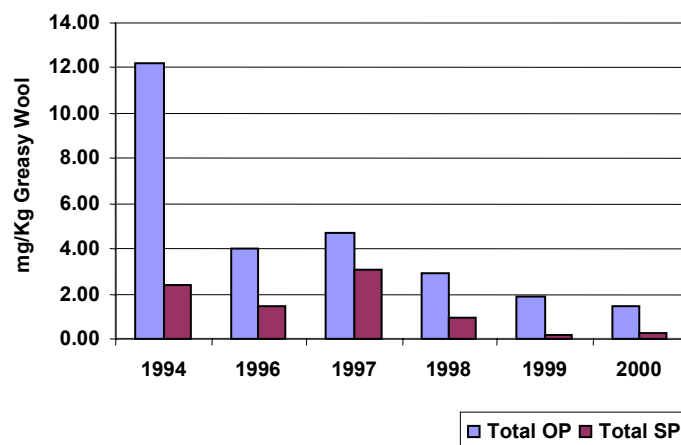


Figure 4.5: Average pesticide residues in New Zealand greasy wool 1994 to 2000
[32, ENco, 2001]

Cross-media effects

Effects on all media are expected to be positive.

Applicability

These measures can be adopted by all manufacturers who purchase their own raw materials and by commission processors with the co-operation of their clients.

Economics

Wool price has a very significant influence on the overall economics of yarn production. Yarn manufacturers (both sales yarn spinners and integrated mills) select wool on both technical merit and price. Maintaining a profitable business partially depends on striking a balance between these two factors and purchasing wool with the correct technical specification (fibre diameter, fibre length, colour, etc.) at the most economic price. Substituting one supply source for another on the basis of pesticide content may have major cost implications for the industry [32, ENco, 2001].

Reference literature

[32, ENco, 2001], [97, CSIRO, 2000], [202, Ian M. Russel, 2000].

4.3 Selection/ substitution of chemicals used

4.3.1 Selection of textile dyes and auxiliaries according to their waste water relevance

Description

During the past 15 years, various schemes have been developed for ecotoxicological assessment and classification. These include the Dutch General Assessment Methodology in the Netherlands (RIZA-Concept), the SCORE-System in Denmark, the BEWAG-Concept in Switzerland and the TEGEWA scheme developed in Germany by industry in collaboration with authorities.

Three of these schemes — the TEGEWA scheme, the SCORE-System and the Dutch General Assessment Methodology — have been proposed by the German, Danish and Dutch TWG members, respectively, as techniques to be considered in the determination of BAT. All three methods are presented in Section 13 (extracts of submitted documents).

Main achieved environmental benefits

All three sources regard the proposed schemes as useful tools that allow the user to select textile dyes and auxiliaries for ecotoxicological aspects. Indirect benefits for water quality are therefore expected, although difficult to quantify/evaluate.

According to TEGEWA, the introduction of the method in Germany in 1998 has produced a reduction in the consumption of Class III products (products with “High relevance to waste water, according to TEGEWA classification scheme). This is shown in the table below.

	Number				Quantity (t/yr)				Quantity (%)			
	1997	1998	1999	2000	1997	1998	1999	2000	1997	1998	1999	2000
Class I	2821	3020	3242	3164	98446	105983	102578	104406	63	67	75	77
Class II	1499	1485	1358	1258	29972	29422	23321	22103	19	18	17	16
Class III	460	417	358	297	27574	23830	10231	9206	18	15	8	7
Total	4780	4922	4958	4719	155992	159235	136130	135715	100	100	100	100

Table 4.7: Textile auxiliaries sold in Germany from 1997 to 2000: number, quantity and percentage of textile auxiliaries in classes I, II, III, according to TEGEWA [179, UBA, 2001]

Cross-media effects

None believed likely according to both sources. However, some considerations are worth mentioning:

- EU/ OSPAR have set criteria for the selection and prioritisation of chemicals. The conclusions of the EU/OSPAR criteria may be not fully in agreement with the conclusions derived from the proposed classification schemes
- a hazard assessment considers only product-specific properties and not the actual risk or total effluent load. It is crucial to differentiate between hazard and risk. Risk is a function of hazard and exposure. If either of these factors is zero then the risk is also zero. Conversely, a less hazardous product can pose a higher risk than a more hazardous product, if the exposure is high (e.g. quantity, frequency of use, degree of exhaustion, etc.). Hazard and exposure are the integral parts of risk assessment (which is taken into account by EU policy). Correct evaluation of the control of risks arising from the use of chemicals can only be achieved by performing a risk assessment [102, ETAD, 2001]
- it is important that the steps of the process and the information that supports the allocation of a product to a given class of hazard remain transparent in order to allow a critical evaluation of the results by the users (both industry and authorities).

Applicability

From the user/textile finisher point of view, the implementation of the TEGEWA method does not require particular resources to be spent because the chemical producers classify of the products.

Conversely, the implementation of the Danish SCORE-System implies that the authorities and the companies allocate the necessary man-hours to set up the system. Once the company has joined the system, approximately 25 - 50 man-hours a year are needed for maintenance of the system [192, Danish EPA, 2001].

The broad applicability of this kind of tool at the European level depends on the degree of acceptance of the method by the parties involved (i.e. industry and national authorities).

Economics

According to the sources, no major economic problems have been encountered in Germany or in Denmark, where the two proposed classification tools are already applied.

Driving force for implementation

Demand from authorities [192, Danish EPA, 2001].

Reference plants

The TEGEWA scheme has been applied in Germany since 1998, while the implementation of the SCORE-System is part of the environmental permits for the clothing and textile industry in Ringkjøbing in Denmark.

Reference literature

[192, Danish EPA, 2001], [37, TEGEWA, 2000], [179, UBA, 2001] with reference to:

“Lepper, 1996”

Lepper, P.; Schönberger, H.

Konzipierung eines Verfahrens zur Erfassung und Klassifizierung von Textilhilfsmitteln
Abschlussbericht FKZ 10901210 zu einem Forschungsvorhaben im Auftrag des
Umweltbundesamtes (1996) - nicht veröffentlicht

“TEGEWA, 1998”

Noll, L.; Reetz, H.

Gewässerökologisch orientierte Klassifizierung von Textilhilfsmitteln
Melliand Textilberichte 81 (2000) 633-635

“TVI-Verband, 1997”

Verband der deutschen Textilveredlungsindustrie, TVI-Verband, D-Eschborn

Official and published self-commitment concerning the classification of textile auxiliaries
according to their waste water relevance, dated 27.11.1997 (1997)

4.3.2 Emission factor concept (emissions to air)

Description

The emission factor concept embraces the emissions of volatile organic carbon and dangerous substances that are potentially found in the exhaust air from heat-setting, thermosol process, impregnation and fixation of finishing agents. The concept was developed in Germany by public authorities (national and federal states level) in co-operation with the German Association of textile finishing industry (TVI-Verband) and TEGEWA “LAI, 1997”.

The fundamental principle of this concept is that in most cases the emissions produced by the single components in the auxiliary formulations are additive. As a result the emission potential of each recipe can be calculated on the basis of emission factors given for the single substances present in the formulation (for certain substances, however, the correlation between emission and process parameters is more complex).

It is necessary to distinguish between:

- a substance-based emission factor and
- a textile substrate-based emission factor.

As described earlier in Section 3.3.3.5.6, the *substance-based emission factor* (fc or fs) is defined as the amount of substances (organic or inorganic) in grams that can be released at defined process conditions (curing time, curing temperature and type of substrate) from one kilogram of auxiliary. There are two types of substance-based emission factors: 1) fc, which gives the total emission produced by the organic substances present in the formulation, expressed as total organic carbon; 2) fs, which gives the emission attributable to specific toxic or carcinogenic organic substances or to inorganic compounds, such as ammonia and hydrogen chloride, etc. present in the formulation.

In Germany, where the technique is widely applied, the substance-based emission factors are provided to the finisher by the auxiliary supplier, in addition to the information reported in the Material Safety Data Sheets. The factors are based on measurements, calculations or conclusions made by analogy (according to TEGEWA guidance for calculation of substance-based emission factors) [287, Germany, 2002].

The *textile substrate-based emission factor* (Wfc or Wfs) is defined as the amount of organic and inorganic substances in grams that can be released as defined process parameters (curing time, curing temperature and type of substrate) from one kilogram of textile treated with a given auxiliary formulation. The textile substrate-based emission factor can be calculated on the basis of the emission factors of the individual components of the formulation/recipe (fc or fs), their concentration in the liquor (FK) and the liquor pick-up. One example of calculation of the textile-based emission factor is reported in Table 3.44.

The calculated textile substrate-based emission factors Wfc/s can then be compared with the limit values for textile substrate-based emission factors set by environmental authorities (referred to a standard air-to-textile substrate ratio of 20 m³ air/kg textile substrate).

Main achieved environmental benefits

The concept can be regarded as a system to control and prevent air emissions from textile finishing. The auxiliary-based substance emission factor makes it possible to predict the emissions of a given recipe based on the emission factors of the single components. In this way the operator knows the emissions of his process before carrying it out. He can therefore concentrate at the product and process design stage on minimising the emissions at the source, for example by reducing the amount of auxiliaries or selecting auxiliaries with lower emission potentials.

Operational data

Typical auxiliary-based emission factors are summarised in Annex IV.

The control of the air emissions of the recipes/formulations for finishing by pre-calculation of the textile substrate-based emission factors should be done regularly (at least once a year) and specially before using a new recipe or changing compounds of an existing recipe.

The following reflects the air emission values related to an air/ textile substrate ratio of 20 m³/kg, applied in Germany and achievable thanks to the application of the Emission Factor Concept:

- harmful substances such as toxic substances, suspected carcinogens: ≤ 0.4 g/kg textile substrate as total emission, with an emission mass flow from the entire plant of 0.10 kg/h or higher
- carcinogenic substances a maximum of 0.02 g/kg textile substrate as total emission, with an emission mass flow from the entire plant of 2.5 g/h or higher
- other organic substances: ≤ 0.8 g C/kg textile substrate, as total emission, with an emission mass flow from the entire plant of 0.8 kg Org.-C/h or higher.

All substances belonging to class I (3.1.7 TA-Luft) exceeding 500 ppm in the auxiliary formulation have to be declared. In addition, information on substances classified under item 2.3 TA-Luft (carcinogenic substances) exceeding 10 ppm is obligatory (“TA-Luft, 1986”).

Substances or preparations which are classified as carcinogens, mutagens or toxic to reproduction under Directive 67/548 EEC as last amended by Directive 1999/33/EG and last adapted by Directive 2000/33/EG, are assigned or need to carry the risk phrases R45, R46, R49, R60, R61 shall be replaced as far as possible by less harmful substances or preparations within the shortest possible time.

Cross-media effects

None believed likely.

However, it has to be kept in mind as a general consideration, that the use of a factor makes access to the accumulated information difficult, unless it is fully disclosed [281, Belgium, 2002].

Applicability

The emission factor concept is of general applicability in textile mills and is especially suitable for facilities performing chemical finishing treatments and thermosol processes.

This technique is widely applied in Germany, where it is accepted by the environmental authorities. For other countries the application of the emission factor concept depends entirely on the national competent bodies.

Economics

There are no costs for the textile finisher apart from the cost of calculating the emission factors for the finishing recipes used in the process, which is negligible. A correct selection of low-emission auxiliaries can significantly reduce costs for air emission abatement.

Driving force for implementation

Pre-calculation of emissions enables the finisher to take actions in order to meet the emission limit values set by environmental authorities.

In Germany, where the emission factor concept is accepted by the environmental authority, an important driving force for implementing this technique has been the possibility that it gives of avoiding or reducing expensive emission measurements (pre-calculation).

Reference plants

Many in Germany.

Reference literature

[179, UBA, 2001].

4.3.3 Substitution for alkylphenol ethoxylates (and other hazardous surfactants)

Description

Many surfactants give rise to environmental concerns due to their poor biodegradability, their toxicity (including that of their metabolites) and their potential to act as endocrine disruptors.

Concerns currently focus on alkylphenol ethoxylates (APEO) and in particular on nonylphenol ethoxylates (NPE), which are often contained in the formulations of detergents and many other auxiliaries (e.g. dispersing agents, emulsifiers, spinning lubricants).

Alkylphenol ethoxylates are themselves believed to be endocrine disruptors and to cause feminisation of male fish. More importantly, however, they produce metabolites which are believed to be many times more potent as endocrine disruptors than the parent compounds. The most potent of these are octyl- and nonylphenol. Nonylphenol is listed as a priority hazardous substance under OSPAR and the EC Water Framework Directive, which means that any discharge needs to be phased out.

Alkylphenol ethoxylates may be present in auxiliaries formulations as the main active substances or in small percentages as additives. In both cases substitutes are available. The main alternatives are alcohol ethoxylates (AE), but other readily biodegradable surfactants have also been developed.

As to other problematic surfactants, substitutes are often available that are readily biodegradable or bioeliminable in the waste water treatment plant and that do not form toxic metabolites.

Substances are considered readily biodegradable if in a 28-day period, with ready biodegradation studies (OECD 301 A-F), the following levels of degradation are achieved:

- for tests based on dissolved organic carbon (e.g. OECD tests 301 A, 301 E): ≥ 70 % DOC reduction or
- for tests based on oxygen depletion or carbon dioxide generation (e.g. OECD test 301 B): ≥ 60 % (of theoretical maxima).

Substances are considered bioeliminable if the following levels of degradation are achieved:

- OECD test 302 B, DOC reduction ≥ 70 % in 28 days or
- OECD test 302 B, DOC reduction ≥ 80 % in 7 days, if an adapted “inoculum” is used in the treatment plant where the substance is treated.

The finisher should be able to select the less hazardous products based on the information reported by the manufacturer on Material Safety Data Sheets.

Main achieved environmental benefits

The use of APEO-free auxiliaries produces a reduction of the amount of potentially toxic endocrine disruptors in the receiving water. Moreover, the substitution of non-bioeliminable surfactants will result in improved treatability of the effluent.

Operational data

Sites using exclusively APEO-free auxiliaries report no operational or processing difficulties [32, ENco, 2001].

For the substitution of APEO in detergents, the new washing formulations are reported to be applied in concentrations similar to the conventional ones [180, Spain, 2001].

According to other sources (e.g. [187, INTERLAINE, 1999]), AE are slightly less effective detergents than APEO, which means that higher concentrations and feed rates may be required for equivalent effects. Investigations carried out in the wool scouring sector showed that mills using alkyl phenol ethoxylates used an average of 7.6 g detergent per kg greasy wool (range 4.5 - 15.8 g/kg), while the users of alcohol ethoxylates consumed an average of 10.9 g detergent per kg greasy wool (range 3.5 – 20 g/kg).

Cross-media effects

There are no adverse environmental effects to be mentioned.

The possibility of foaming in rivers exists in cases where sufficient amounts of surfactant pass through sewage treatment works unchanged or as partial metabolites with residual surfactant properties. The formation of foam is, however, typical of many other surfactants, including APEO.

Applicability

This measure is generally applicable in all new and existing wet processing installations. However, as long as “hard” surfactants are used in fibre and yarn preparation agents, a large fraction of potentially hazardous surfactants in wet-processing effluents cannot be controlled by the dyehouse.

For APEO, it should be noted that these surfactants also have many dry applications (e.g. as dry spinning lubricants, in the production of viscose for technical uses). In these cases substitution is possible, but it is expensive and it is not a priority. Indeed, here the presence of APEO can be regarded as a less critical problem since the surfactant does not enter the wet processing line.

Economics

AE are 20 – 25 % more expensive than APEO. The fact that they appear to be less effective can further increase the operating costs over those of APEO. However, mills making the change from APEO to AE are more likely to take care to optimise their use [187, INTERLAINE, 1999].

An example is given for a UK scouring mill which made the substitution in 1996. Annual costs for detergent use were estimated to have increased from EUR 84700 to EUR 103600: an increase equivalent to about EUR 1.09 per tonne of wool processed. In the past few years the cost of APEO has been reduced significantly from EUR 1000/tonne (1997/98) to EUR 700/tonne (1999). As a result the increase in costs involved with the use of AE could be even higher [187, INTERLAINE, 1999].

Generally speaking, costs of environmentally optimised formulations are comparable, but in some cases can be significantly higher than conventional products. However, usually the finisher tends to accept the extra costs associated with the use of more environmentally friendly products, especially when the overall environmental balance is considered [179, UBA, 2001].

Driving force for implementation

The enforcement of regulations at national and European level, together with the PARCOM recommendations and the eco-labelling schemes, are the main driving forces.

Reference plants

Many plants throughout the world.

Reference literature

[187, INTERLAINE, 1999], [32, ENco, 2001], [179, UBA, 2001], [180, Spain, 2001], [51, OSPAR, 1994] with particular reference to P010, P011, P012, [61, L. Bettens, 1999].

4.3.4 Selection of biodegradable/bioeliminable complexing agents in pretreatment and dyeing processes

Description

Description

Complexing agents are applied to mask hardening alkaline-earth cations and transition-metal ions in aqueous solutions in order to eliminate their damaging effect, especially in pretreatment processes (e.g. catalytic destruction of hydrogen peroxide), but also during dyeing operations.

Typical sequestering agents are polyphosphates (e.g. tripolyphosphate), phosphonates (e.g. 1-hydroxyethane 1,1-diphosphonic acid) and amino carboxylic acids (e.g. EDTA, DTPA, and NTA) (see figure below).

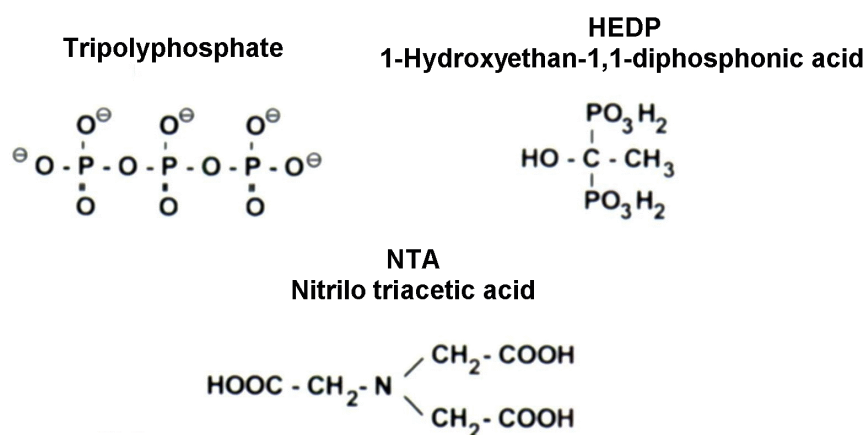


Figure 4.6: Chemical structure of some N- or P- containing complexing agents [179, UBA, 2001]

The main concerns associated with the use of these substances arise from, their N- and P-content, their often-low biodegradability/bioeliminability and their ability to form stable complexes with metals, which may lead to remobilisation of heavy metals (see also Section 8.5).

Softening of fresh water, to remove the iron and the hardening alkaline-earth cations from the process water, and the techniques described in Section 4.5.6 are available options for minimising/ avoiding the use of complexing agents in various applications (e.g. in hydrogen peroxide bleaching, rinsing after reactive dyeing of cotton).

When complexing agents are used, polycarboxylates or substituted polycarboxylic acids (e.g. polyacrylates and polyacrylate-maleic acid copolymerisates), hydroxy carboxylic acids (e.g. gluconates, citrates) and some sugar-acrylic acid copolymers are convenient alternatives to the conventional sequestering agents. None of these products contains N or P in their molecular structure. In addition, the hydroxy carboxylic acids and sugar-acrylic acid copolymers are readily biodegradable.

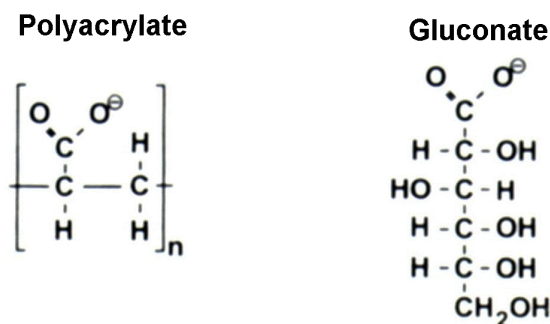


Figure 4.7: Chemical structure of some N- and P-free complexing agents
[179, UBA, 2001]

The best complexing agent (in a technical, economical and ecological sense) is one that also achieves a good balance of ecological properties and effectiveness and has no detrimental effect in dyeing (demetalisation of dyes).

Effectiveness is measured as the capacity to complex alkaline-earth cations, the dispersing capacity and the capacity of stabilising hydrogen peroxide.

On the ecological side, the following factors are to be considered:

- biodegradability
- bioeliminability
- remobilisation of heavy metals
- nitrogen content (eutrophication potential)
- phosphorus content (eutrophication potential).

A qualitative assessment of the ecological properties of most common classes of complexing agents is given in Table 4.8, while Table 4.9 gives an analysis of the aspects related to their effectiveness.

Ecological property	EDTA, DTPA	NTA	Poly-phosphate	Phosphonates	Poly-carboxylates	Hydroxy carboxylic acid	Sugar copolymers
Biodegradability	No	Yes	Inorganic	No ⁽¹⁾	No	Yes	Yes
Bioeliminability	No	-	-	Yes ⁽²⁾	Yes	-	-
N-content	Yes	Yes	No	No	No	No	No
P-content	No	No	Yes	Yes	No	No	No
Remobilisation of heavy metals	Yes	No	No	No	No	No	No

Source: [179, UBA, 2001]
Notes:
(1) [179, UBA, 2001] with reference to "Nowack, 1997"
(2) under UV photocatalytic degradation is observed

Table 4.8: Qualitative assessment of commercially available complexing agents

Main achieved environmental benefits

The substitution of conventional complexing agents with the product mentioned above has the following positive effects:

- reduced eutrophication in the receiving water
- improved biodegradability of the final effluent
- reduced risk of remobilisation of the heavy metals from sediments.

Operational data

Complexing agents are applied in many different fields in textile chemistry. Recipes and application techniques are therefore process-specific. However, the use of the optimised products mentioned above does not imply major differences with respect to conventional complexing agents.

Bioelimination/biodegradation rates for some commercial products that do not contain P and N in their molecular structure are:

- sugar-acrylic acid copolymer: readily biodegradable, (OECD 301 F, mineralisation: 100 %; COD: 194 mg/g; BOD₅ 40 mg/g) (“CHT, 2000”)
- sugar acrylic acid copolymer: readily biodegradable (OECD 301C; COD: 149 mg/g) (“Stockhausen, 2000”)
- hydroxy carboxylic acid: bioeliminable (OECD 302 B, elimination: 92 %; COD: 144 mg/g; BOD₅ 51 mg/g) (“CHT, 2000”)
- carboxylates: bioeliminable (OECD 302B, elimination>90 %; COD: 280 mg/g; BOD₅ 125 mg/g) (“Petry, 1998”)
- modified polysaccharide: readily biodegradable (OECD 301E, biodegradability: 80 %; COD: 342 mg/g; BOD₅ 134 mg/g) (“Clariant, 2000”).

NTA is biodegradable when treated in waste water treatment plants under nitrifying conditions (OECD 302B, elimination 98 % COD: 370 mg/g; BOD 30: 270 mg/g – “BASF, 2000”). Recent studies have shown that NTA plays a minor role, if any, in the remobilisation of heavy metals in aquatic sediments [280, Germany, 2002]. Phosphonates are not biodegradable, but they are bioeliminable and they do not contribute to the remobilisation of heavy metals (see also Section 8.5).

Cross-media effects

Taking as a reference the application of conventional complexing agents, there are no cross-media effects of concern. With polyacrylate-based complexing agents, the residual monomer content in the polymer should be taken into account (note that acrylates are also widely used in large volume in other sectors as detergent builders, thus overloading the waste water treatment plants more significantly than textile effluents do).

Applicability

The complexing agents described in this section can be used in continuous and discontinuous processes. The effectiveness of the various products has, however, to be considered when replacing conventional complexing agents by more environmentally-friendly ones (see table below).

Property	EDTA, DTPA	NTA	Poly-phosphate	Phosphonate	Poly-carboxylates	Hydroxy carboxylic acid	Sugar copolymers
Softening	+	+	+	++	+	0	+
Dispersing	-	-	0	+	+	-	+
Stabilisation of peroxide	+	-	-	++	0	-	+(special products)
Demineralisation	++	+	0	++	0	0	0

Source: [179, UBA, 2001]
Note: effectiveness increases in the following order -, 0, +; ++

Table 4.9: Effectiveness of complexing agents

Economics

Costs for N- or P-free compounds, especially for sugar-acrylic copolymers, are comparable to other N- and P-free products, although higher quantities may be necessary in some cases, [179, UBA, 2001].

Driving force for implementation

The enforcement of regulations at national and European level, together with the PARCOM recommendations and the eco-labelling schemes, are the main driving forces.

Reference plants

N- and P-free complexing agents are applied in many plants world-wide. Consumption of polycarboxylates is significantly higher than for sugar-acrylic copolymers and hydrocarboxylic acids [179, UBA, 2001].

Reference literature

[61, L. Bettens, 1999], [169, European Commission, 2001], [179, UBA, 2001] with reference to:

“CHT, 1999”
Chemische Fabrik Tübingen, D-Tübingen
Material Safety Data Sheet (1999)

“CHT, 2000”
Chemische Fabrik Tübingen, D-Tübingen
Product information (1999)

“Clariant, 2001”
Clariant, D-Lörrach
Material Safety Data Sheet (2001)

“Stockhausen, 2000”
Stockhausen, D-Krefeld
Material Safety Data Sheet (2000)

“Petry, 1998”
Dr. Petry, D-Reutlingen
Material Safety Data Sheet (1998)

4.3.5 Selection of antifoaming agents with improved environmental performance

Description

Excessive foaming causes uneven dyeing of yarn or fabric. There is a trend towards higher consumption of defoamers because of the growing preference for high speed and high temperature processing, reduction in water usage and continuous equipment/processes. Anti-foaming agents are commonly applied in pretreatment, dyeing (especially when dyeing in jet machines) and finishing operations, but also in printing pastes. Low foaming characteristics are particularly important in jet dyeing, where agitation is severe.

Products that are insoluble in water and have a low surface tension are suitable for providing antifoaming effect. They displace foam-producing surfactants from the air/water boundary

layer. Nevertheless, antifoaming agents contribute to the organic load of the final effluent. Their consumption should therefore be reduced in the first place. Possible measures in this respect are:

- using bath-less air-jets, where the liquor is not agitated by fabric rotation
- re-using treated baths (see Section 4.6.22).

However, these techniques are not always applicable and cannot completely avoid the use of defoamers. Therefore the selection of auxiliaries with improved ecological performance is important. Antifoaming agents are often based on mineral oils (hydrocarbons). The presence of PAHs contaminants must also be taken into account when poorly refined oils are present in the formulation.

Environmentally improved products are free of mineral oils and are characterised by high bioelimination rates.

Typical active ingredients of alternative products are silicones, phosphoric acid esters (esp. tributylphosphates), high molecular alcohols, fluorine derivatives, and mixtures of these components.

Main achieved environmental benefits

Thanks to the use of mineral oil-free defoamers the hydrocarbon load in the effluent, which is often limited in national/regional regulations, is minimized. Furthermore, these alternative defoaming agents have lower specific COD and higher bioelimination rate than hydrocarbons. For example, a product based on triglycerides of fatty acid and fatty alcohol ethoxylates (COD: 1245 mg/l; BOD₅: 840 mg/l) has a degree of bioeliminability higher than 90 % (determined in the modified Zahn-Wellens-Test, according to OECD 302 B Test method or EN 29888, respectively) [179, UBA, 2001].

For air emissions, due to the substitution of mineral oil-based compounds, it is possible to reduce VOC emissions during high-temperature processes (caused by the carry-over of antifoaming agents on the fabric after wet operations).

Operational data

The mineral oil-free defoamers can be used in a way similar to conventional products. Because silicone products are highly effective, the required amount can be considerably reduced.

Cross-media effects

Account must be taken that:

- silicones are eliminated only by abiotic processes in waste water. Furthermore, above certain concentrations, silicone oils may hinder the transfer/diffusion of oxygen into the activated sludge
- tributylphosphates are odour-intensive and strongly irritant
- high molecular-weight alcohols are odour-intensive and cannot be used in hot liquors.

Applicability

There are no particular limitations to be mentioned concerning the application of the mineral oil-free formulations. However, the effectiveness of the various alternative products has to be borne in mind [179, UBA, 2001].

If antifoaming agents based on silicones are used there is risk of silicone spots on the textile and silicone precipitates in the machinery [179, UBA, 2001].

Restrictions in the use of silicones in some sectors have to be considered. For example, in the automotive industry restrictions have been put in place, which forbid the use of silicones in automobiles and textiles for this industry.

Economics

Cost of mineral oil-free products is comparable to conventional ones [179, UBA, 2001].

Driving force for implementation

Minimisation of hydrocarbons in the effluent is the main reason for substituting mineral oil-containing antifoaming agents.

Reference plants

Many plants in Europe. There are various suppliers for antifoaming agents free of mineral oils.

Reference literature

[179, UBA, 2001] with reference to:

“Dobbelstein, 1995”

Optimierung von Textilhilfsmitteln aus ökologischer Sicht. Möglichkeiten und Grenzen
Nordic Dyeing and Finishing Conference 20.05.1995, F-Hämeenlinna

“Petry, 1999”

Dr. Petry GmbH, D-Reutlingen
Material Safety Data Sheet

4.4 Wool scouring

4.4.1 Use of integrated dirt removal/grease recovery loops

Description

As already described in Section 2.3.1.1 (see Figure 2.4), a wool scouring plant operating in countercurrent mode normally produces three liquid waste streams:

- a dirt-rich flow, from the bottoms of the scouring bowls
- a less concentrated dirty flow, from the bottoms of the rinse bowls
- a grease-rich flow, from the top of the first scour bowl, or from the side tank of the first scour bowl, which receives the liquor removed from the wool as it exits the bowl through the squeeze press.

All of these flows can be partially decontaminated and recycled to the scour, by means of grease recovery and dirt removal loops.

There is no consensus on the best way to operate the loop(s). Some mills prefer to treat the dirt-rich flow and the grease-rich flow separately, whilst others combine the two streams and carry out sequential treatment, first for dirt removal, then for grease recovery.

For grease recovery, plate-type centrifuges are employed. They are usually protected from the abrasive effects of dirt by hydrocyclones in cases where separate rather than sequential grease recovery and dirt removal is practised. The centrifuge produces a top phase, known as “cream”, which is grease containing a small amount of water. This “cream” is usually passed to a secondary centrifuge, which produces an upper, a lower and a middle phase. The upper phase

consists of anhydrous grease, which can be sold as a by-product. The bottom phase is high in dirt and may be passed to the input side of the dirt recovery loop, or to the effluent treatment plant. The middle phase is impoverished in both grease and dirt and may be completely or partially recycled to the scour, by addition to the first scouring bowl. A portion of the middle phase may flow to effluent treatment.

Dirt removal may employ gravity settling tanks, hydrocyclones or decanter centrifuges – or combinations of these methods.

In mills with more than one scouring line, the lines normally share dirt removal/grease recovery facilities.

For fine and extra-fine wool, when carried out using machinery that has a separate continuous sludge flow output, the wool grease recovery loop also allows the elimination of the very fine dirt fraction without the need for a separate loop for dirt removal.

Main achieved environmental benefits

The implementation of dirt removal/grease recovery loops allows:

- a reduction in water consumption ranging from a minimum of 25 % to a maximum of more than 50 %, taking as reference point the consumption of water of a conventional plant operating in countercurrent (between 5 and 10 l/kg of greasy wool)
- a reduction in energy consumption equivalent to the amount of thermal energy carried by the recycled liquor (the liquor temperature is generally about 60 °C)
- the production of a valuable by-product: wool grease
- a reduction in detergent and builder consumption proportional to the water savings achieved
- the conversion of suspended dirt into spadeable sludge
- a reduction of the load (oxygen-demanding substances and suspended solids) sent to the effluent treatment plant, which means a reduction in the consumption of energy and chemicals for the treatment of the waste water. This reduction is proportional to the dirt removal and grease recovery rate achieved.

Operational data

Medium-to-large scouring mills (say 15000 – 25000 tonnes greasy wool per year) employing dirt removal/grease recovery loops should be able to achieve net specific water consumption figures of 2 - 4 l/kg of greasy wool for most types of wool. Both coarse and fine wool scourers in the survey are already achieving these figures. However, there is insufficient data to define whether these performances are also applicable to extra-fine wool scourers.

The amount of grease recovered as sellable by-product in the surveyed companies ranges between 10 and 35g/kg of greasy wool. The best performance for a fine wool scourer is almost 35 g/kg greasy wool and for a coarse wool scourer about 13 g/kg. These recovery rates represent about 25 % of the grease estimated to be present in the wool scoured.

There is probably a maximum amount of grease that can be recovered centrifugally, which is governed by the ratio between hydrophobic and less-hydrophobic grease (top grease and oxidised grease) present on the scoured wool [187, INTERLAINE, 1999].

Cross-media effects

The dirt and part of the grease which is not recovered as by-product may be transferred as pollutant, from water to land.

Applicability

This measure is applicable in all new and most existing wool scouring plants.

For plants scouring hair, or wools giving low yields of poor quality grease, the measure might not be an economically attractive proposition.

The COD concentration of the effluent resulting from the dirt removal and grease recovery loop may be too high for on-site aerobic treatment plants. The installation of a coagulation/flocculation or anaerobic biological treatment before the aerobic biological plant would overcome this problem.

Economics

A calculation of net economic benefit per tonne greasy wool can be done, based on the assumptions reported in Table 4.10. The unit costs refer to the UK situation at the time of the research, therefore they can only be indicative for considerations at European situation.

Benefits per tonne of greasy wool processed	Unit cost
Water saved: 4 m ³	EUR 0.68 /m ³ mains water
Energy saved: 836.8 MJ ^(a)	EUR 0.00245 /MJ
Detergent saved: 1 kg	EUR 1.40 /kg
Builder saved: 1 kg	EUR 0.27 /kg (Na ₂ CO ₃)
Avoided treatment of waste water: 4 m ³	EUR 0.53 /m ³ water discharged ^(b)
Avoided disposal of sludge: about 150 kg (wet weight)	EUR 0.041 /kg of sludge (wet weight)
Grease produced for sale: - 32.5 kg (fine wool scourers) - 13 kg (coarse wool scourers)	EUR 2 /kg of wool grease ^(c) (but very variable)
Source [187, INTERLAINE, 1999] except (c), I.M. Russell personal communication	
Notes:	
^(a) The energy saved to heat water to operating temperature of 60 °C can be estimated at 209.2 MJ per m ³ of saved water (using direct gas at 90 % efficiency).	
^(b) UK cost (1999) considering only the volume charge. In a real case energy, chemicals, manpower, etc. should be taken into account	

Table 4.10: Estimate of the economic benefits achievable with the installation of integrated dirt removal/ grease recovery loops

It is estimated that the installation of dirt removal/grease recovery loops at a mill processing 15000 to 25000 tonnes/year of greasy wool would cost between 400000 and 800000 euros, depending on the nature, the quality and the capacity of the particular system chosen. The payback time on the installation, ignoring the benefits of reduced effluent disposal costs, would be between 2.04 and 4.08 years [187, INTERLAINE, 1999].

Driving force for implementation

The driving forces are economic benefit for medium and large mills, especially those processing fine (high grease content) wools. Economic benefit derives from savings in water, energy, sewage treatment and chemical costs and the proceeds from sales of wool grease. Disincentives are the high capital cost, high maintenance costs and complexity.

Reference plants

Many plants throughout Europe (see also survey referred to in Chapter 3).

4.4.2 Use of integrated dirt removal/grease recovery loops combined with evaporation of the effluent and incineration of the sludge

Description

The technique involves the closed-loop treatment of wool scouring effluents by evaporation/incineration with recovery of water and energy. Thereby the whole system of effluent and waste management is closely integrated with a dirt removal/grease recovery loop applied to the scouring process (described in Section 4.4.1).

As far as can be determined, there is only one mill in the world presently using this technique. That is Mill N, mentioned in the survey presented in Chapter 3 [187, INTERLAINE, 1999] (see schematic diagram of the effluent and waste management system in the figure below). The features of the system, as it is applied in the referenced mill, are therefore used as the basis for the description of this technique.

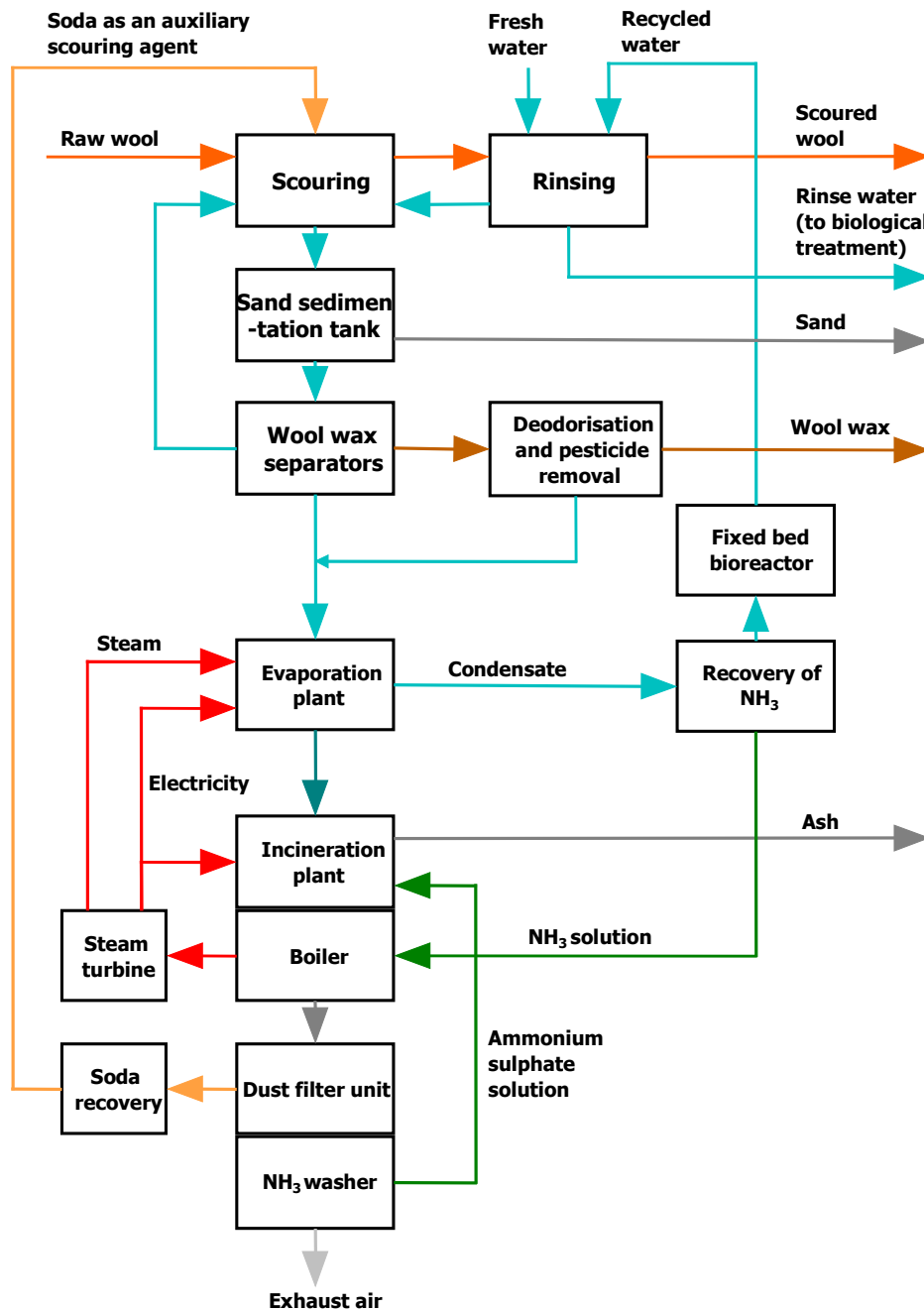


Figure 4.8: Schematic diagram of the effluent and waste management system at Mill N [187, INTERLAINE, 1999]

Mill N has eight scour lines. Flowdown from the rinse bowls is treated biologically, using aeration in a series of 5000 m³ circular tanks. Biological sludge is removed in a settling tank and partly returned to the first aeration tank. Excess sludge is treated in a sludge thickener, then dewatered in a decanter centrifuge and finally disposed of to agricultural land.

Heavy scour effluent is sent to a settling tank. The dirt- or sand-rich sludge from the bottom of the tank is dewatered in decanter centrifuges and then partly used in brick-making and partly landfilled. The grease-rich phase from the top of the tank is taken to the wool wax separators (grease centrifuges). Here the grease is separated. The middle phase from the centrifuges is returned to the scours and the bottom (dirty) phase sent to the evaporation plant.

A seven-stage steam-heated falling film evaporator is installed. The steam used for heating is produced in a boiler which uses waste heat from the incinerator. The boiler also powers a steam

turbine, producing electricity. The integrated evaporator/incinerator/boiler system is self-sufficient in energy, all the energy used being derived from the sludge.

The condensate from the evaporator is treated in a steam stripper to remove ammonia, then passed through a fixed bed aerobic bioreactor, which removes residual odorous compounds and 90 % of steam-volatile ectoparasiticides, before the water is recycled to the rinse section of the scour. The ammonia is used in a catalytic reactor to reduce the NO_x content of the incinerator flue gases.

The evaporator concentrate entering the incinerator has a calorific value of 9.5 MJ/kg and its combustion is self-supporting (no fuel added from external sources). The operating temperature of the incinerator is 1200°C in order to destroy the polychloro-dioxins and -benzofurans. The exhaust gases are used to heat the boiler, as already stated, and fly ash is removed from the boiler flue gases in a bag filter system. The ash is extracted with water to recover sodium and potassium carbonate in solution, which is used as a builder in the scour. The extracted ash and the solidified liquid ash from the incinerator are landfilled.

Main achieved environmental benefits

In addition to the environmental benefits achievable with the application of a dirt removal/grease recovery loop of the type described in the previous section, the proposed technique allows further reductions of:

- the organic load discharged to the environment (see Table 4.11)
- water consumption, thanks to the additional amount of water recovered from the evaporator. Assuming a consumption of 4 - 6 l/kg greasy wool as best performance achievable by a company using high capacity dirt removal/grease recovery loops, a further 70 – 75 % reduction in water consumption may be obtained (Mill N declared a net water consumption of 1.31 l/kg greasy wool)
- the amount of sludge to be disposed of. The evaporation/incineration process produces 20 g of ash per kg of greasy wool, but no sludge. Sludges (75 g/kg greasy wool, dry weight) arise from the dirt removal/grease recovery loop and from the biological treatment of rinse effluent. In other companies where the sludge is not incinerated the amount produced is in the region of 185 g/kg of greasy wool (dry weight), as for example in Mill L (see Chapter 3, Section 3.2.1).

The environmental performance of the plant at Mill N has been described in detail⁸. The plant was installed in stages over a period of 13 years from 1982 – 1995. In 1982, the settling tank and wool wax recovery plant were installed. By 1987, the aerobic biological effluent treatment plant had come on line, and at that time was used to treat heavy scouring effluent. In 1988, the evaporation/-incineration plant was built and since then used for heavy scouring effluent and only rinse water treated in the aerobic biological plant. Later refinements included the fixed bed bioreactor, for removing odours and volatile ectoparasiticides from the recycled evaporator condensate, and then the ammonia stripper used to prevent recycling of ammonia in the condensate thereby reducing ammonia and nitrate levels in the treated effluent from the aerobic biological plant. At a similar time, the mill started to use ammonia to reduce NO_x in the exhaust gases from the boiler, and bag filtration of the gases (replacing a water scrubber) to remove fly ash, so reducing air emissions and emissions of sodium and potassium salts to water.

The performance of these various stages of plant improvements and additions in reducing emissions to water, air and land are given in the next tables. Figures are related to greasy wool consumption.

⁸ R Hoffmann, G Timmer and K Becker, *The Environmentally Friendly Production of Wool Tops – Waste Water Treatment at BWK*, Proc. 9th Int. Wool Text. Res. Conf., Biella, 1995; R Hoffmann, G Timmer and K Becker, *Wool and the Environment – Effluent Treatment and Recycling, Recirculation of Useful Substances in Wool Scouring and Combing Plants*, Bremer Woll-Kämmerei AG, 1995.

	Unit (1)	1982 Settling, grease recovery	1987 Aerobic biological plant	1992 Evaporator, incinerator	1995 Refinements
COD	g/kg	74	21	1.1	1.1
BOD	g/kg	32	1.4	0.03	0.03
NH ₄ , NO ₃ , NO ₂	g/kg	15	8.4	1.3	0.3
Phosphates	g/kg	0.13	0.13	0.13	0.02
AOX	mg/kg	88	18	3.2	3.2
Ectoparasiticides total	mg/kg	2.0	1.2	0.01	0.01

Source: [187, INTERLAINE, 1999]
Notes:
(1) figures are related to greasy wool consumption

Table 4.11: Emissions to water at Mill N, 1982-1995: production specific values

Parameter	Unit	Actual level 1994
Carbon monoxide	mg/Nm ³	ca. 10
Total dust	mg/Nm ³	5
Total carbon	mg/Nm ³	<10
Inorganic chlorine compounds as HCl	mg/Nm ³	6
Inorganic chlorine compounds as HF	mg/Nm ³	0.9
SO _x	mg/Nm ³	<10
NO _x	mg/Nm ³	180
Cd+Ti	mg/Nm ³	0.0001
Hg	mg/Nm ³	0.001
Sb+As+Pb+Cr+Co+Cu+Mn+Ni+V+Sn	mg/Nm ³	0.013
PCDDs	ng/Nm ³	0.02
Pesticides	µg/Nm ³	<0.1
Ammonia	mg/Nm ³	<30
Odour	OE/Nm ³	<2

Source: [187, INTERLAINE, 1999]

Table 4.12: Incinerator flue gas emissions at Mill N: concentrations

Solid waste	Unit (1)	1982 Settling, grease recovery	1987 Aerobic biological plant	1992 Evaporator, incinerator	1995 Refinements
To landfill	g/kg	615	585	207	108
To agricultural land	g/kg	0	31	100	200

Source: [187, INTERLAINE, 1999]
Notes:
(1) figures are related to greasy wool consumption

Table 4.13: Solid wastes at Mill N, 1982-1995: production-specific values

Operational data

A plant such as this requires extensive monitoring. All the parameters listed in the above-mentioned tables should be monitored regularly [187, INTERLAINE, 1999].

Cross-media effects

Significant cross-media effects should only occur if the plant is operated incorrectly. Although the plant is self-sufficient in energy, it uses a large amount of self-generated thermal and electrical energy and produces CO₂. However, conversion of the carbon content of the evaporator concentrate to CO₂ is preferable to its conversion to methane in landfill [187, INTERLAINE, 1999].

Applicability

The availability of this “complete solution” to the problems of wool scour effluent and waste management is restricted, for existing installations, by a number of considerations [187, INTERLAINE, 1999]:

- the economics – the very high capital cost and high running cost – probably make the system unaffordable for any but the largest scourer (Mill N’s throughput – 65000 t/yr – is almost double that of any other European scourer).
- the technology is very complex and the required expertise is beyond the scope of many scourers. It would be necessary to find and employ an engineer with the requisite skills and experience.
- the space occupied by the plant is large and many scourers would not have room for the plant on their present site.

Mill N has offered to make its expertise available to other scourers who are contemplating installing similar plant. This may increase availability because other mills would not need to go through the learning curve, which began in 1982 at Mill N and is still ongoing, though all the developments described above were in place before the end of 1995 [187, INTERLAINE, 1999].

Economics

In addition to savings achievable with the dirt removal/ grease recovery loop (see Section 4.4.1), recycling of condensate from the evaporator saves the cost of water and the cost of effluent disposal.

Mill N reported in 1995 that its capital expenditure on environmental improvements, since 1982, had been DM64 million (33 million euros) and that the annual running cost of the plant is DM10 million (5 million euros). Despite the mill’s large size and economies of scale its effluent and waste management costs, per tonne of wool processed, are higher than all but the smallest scourers in the survey [187, INTERLAINE, 1999].

Driving force for implementation

It is believed that the driving force at Mill N has been stringent local and national regulations regarding emissions to air and water [187, INTERLAINE, 1999].

Reference plants

Mill N.

As already stated above, as far as can be determined, this is the only mill in the world presently using this technique.

Reference literature

[187, INTERLAINE, 1999]

4.4.3 Minimising energy consumption in wool scouring installations

Description

Wool scouring is an energy-intensive process. In addition to the generally applicable good housekeeping techniques already mentioned, the biggest energy savings in a wool scouring process come from reducing effluent flowdown (and consequent heat losses) to drain or to on-site effluent treatment plant, by the installation of a dirt/grease recovery loop. Technique include fitting a heat exchanger to recover heat from the dirt/grease loop flowdown.

Further savings arise from each of the following measures [187, INTERLAINE, 1999]:

- fitting of covers on scour bowls to prevent heat loss by convection or evaporation. Retrofitting, however, is sometimes difficult on existing installations
- optimising the performance of the final squeeze press in order to improve mechanical removal of water from the wool before it enters the evaporative dryer. The presses used for squeezing wool usually have steel bottom rollers and a porous top roller. Traditionally, the top roller was a steel roller wound with crossbred (coarse) wool top (a sliver of parallel fibres). More recently, this has been replaced with a blended top of wool and nylon (polyamide), a nylon top, or a square section rope, usually of wool and nylon blend. The last option combines durability with good performance. Porous composition rollers are offered commercially, but no information is available on their performance in this application
- running the last bowl at relatively high temperature in order to improve squeezing efficiency. Many scours are set to run with bowl temperatures decreasing from first or second to last bowl. Last bowl temperatures in the survey ranged from ambient (say 20°C) to 65°C, with an average of 48 °C. Since heat losses from the last bowl will increase as its temperature increases and heat consumption in the dryer will correspondingly decrease as the squeezing efficiency improves, it follows that there is an optimum temperature for the last bowl. It has been shown that this temperature is 60 – 65 °C for wool throughput rates above about 500 kg/h
- retrofitting heat recovery units to dryers. However, this is expensive and the heat saving available is only about 0.2 MJ/kg. Scourers' practical experience with heat recovery units on wool dryers is also negative; the units quickly become blocked with fibre and may even cause increases in energy consumption
- direct gas firing of scour bowls and driers in order to avoid the losses which occur in the generation and distribution of steam for use in direct or indirect steam heating. Retrofitting is not always possible in existing plant and the cost is relatively high. Energy saving is 0.3 MJ/kg.

Main achieved environmental benefits

Reduction in energy consumption will have the effect of reducing emissions of CO₂, SO_x and NO_x, either from the scouring plant itself or off-site.

Energy savings from a dirt/grease recovery loop can be estimated as about 2 MJ/kg of greasy wool if a scour with loop and heat exchangers is used. It is assumed that a conventional scourer discharging 10 litres of water per kg greasy wool needs 2.09 MJ to heat 10 litres of fresh water from 10 °C to 60 °C (209 kJ/l). A scouring installation with loop and heat exchangers discharges only 2 l/kg (see Section 4.4.1) and recovers 80 % of the heat contained in the effluent (the energy input needed becomes 0.084 MJ/kg greasy wool).

It is also interesting to show the energy savings achievable in the dryer by operating the last bowl at optimum temperature (65°C) as discussed earlier.

Last bowl temperature °C	20	30	40	50
Savings, MJ/kg wool (1)	0.42	0.25	0.12	0.04
Source: [187, INTERLAINE, 1999] with reference to L A Halliday, WRONZ Report No R112, 1983				
Notes:				
(1) Calculations were made considering an indirect steam dryer				

Table 4.14: Energy savings from operating the last bowl at optimum temperature (65°C)

Energy savings for the other measures described have already been reported under the heading “Description”.

In conclusion, medium-to-large wool scouring plants can be operated with energy consumptions of 4–4.5 MJ/kg greasy wool processed, comprising approximately 3.5 MJ/kg thermal energy and less than 1 MJ/kg electrical energy. Smaller plants may have higher limits for specific energy consumptions, but no information is available to confirm this [187, INTERLAINE, 1999].

Operational data

Many mills do not have separate metering for monitoring the energy consumption of individual machines or processes – or even whole departments. In these circumstances, it is difficult for mill personnel to identify potential energy savings or to become quickly aware of problems, such as loss of efficiency of a dryer. Installation of energy monitoring equipment would probably have an early payback, but little evidence is available to support this claim. In the absence of individual metering, whole-plant monitoring should be done on a frequent basis and any departures from the norm investigated [187, INTERLAINE, 1999].

Cross-media effects

Energy conservation has positive effects on emissions to air and land. No negative effects are to be expected.

Applicability

The measures described here are of mixed applicability. Many are readily applicable in existing plant but some are not, or would involve such changes that the plant would, in effect, become a new plant. For many of the measures, applicability is discussed in the descriptions above [187, INTERLAINE, 1999].

Economics

The most important means for wool scourers to reduce energy consumption is by reducing water consumption and effluent volume. The economics of doing this by installation of countercurrent scouring and integrated dirt removal/grease recovery loops have already been discussed (Section 4.4.1). Information on the costs of other measures is not available at the time of writing [187, INTERLAINE, 1999].

Driving force for implementing these techniques

Economic considerations are the major driving force from the industry’s point of view. From a governmental viewpoint, the main driving force is reduction of emissions to air, in order to achieve commitments made in international agreements [187, INTERLAINE, 1999].

Reference plants

All the measures discussed here are in operation in mills throughout the world, although there may be no one mill which operates all. An exception is the use of co-generation (combined heat and power). No wool scouring mill is known to be operating such a system, though systems operate in other industries. It is likely that a scouring mill would generate an excess of power (electrical energy) and in most member states the excess could be sold and fed into the grid. For the wool scouring sector, co-generation must be regarded as an emerging technique [187, INTERLAINE, 1999].

Reference literature

[187, INTERLAINE, 1999]

4.4.4 Wool scouring with organic solvent

Description

The Wooltech wool cleaning system involves the use of a non-aqueous solvent (trichloroethylene) and does not use any water in the washing process. The process has already been described in Section 2.3.1.3.

Main achieved environmental benefits

The described technique avoids the use of water in the actual wool cleaning process. The only source of water emission is moisture introduced with the wool, steam used in vacuum ejectors and moisture recovered from air drawn into the equipment. This water is treated in two steps, comprising a solvent air stripping unit and a residual solvent destruction unit. Here the residual traces of solvent are destroyed, using a free-radical process based on the Fenton reaction (iron and hydrogen peroxide).

Since pesticides partition strongly to the solvent and leave with the grease, the clean wool is reported to be pesticide free. This has positive implications for the downstream processes where wool is finished.

Another positive effect of this technique is reduced energy consumption, due to the low latent heat of evaporation of an organic solvent compared to water.

Operational data

A nominal consumption of 10 kg/h of solvent is reported for the production of 500 kg/h of clean wool fibre. Part of this solvent ends up in the water stream and is destroyed. The remaining portion is partly emitted in the exhaust air (0.01 kg/h) and partly accounted for as uncaptured losses (5 kg/h).

It is reported ([201, Wooltech, 2001]) that uncaptured losses can generally be very low, but this is directly related to how the plant operators undertake maintenance and how the plant is managed. The Wooltech process has prepared a Code of Conduct for operators with strict maintenance, quality control and management practices to address all the environmental, health and safety issues [201, Wooltech, 2001].

Cross-media effects

The referenced technique uses trichloroethylene as solvent. Trichloroethylene is a non biodegradable and persistent substance. Unaccounted losses of this solvent arising from spills, residues on the fibre, etc., if not adequately treated on site to destroy the solvent, may lead to

diffuse emissions resulting in serious problems of soil and groundwater pollution. This has been taken into account in the latest design of the described technique.

Applicability

The technique is reported to be applicable to any kind of wool. Typically plants with 250 kg/h or 500 kg/h of clean wool (852 kg/h of greasy wool) capacity are used, but smaller plants can be considered [201, Wooltech, 2001]

Economics

According to information submitted by the supplier ([317, Comm., 2002]), the capital investment required for a solvent scouring line (and ancillary plant) with a capacity of 500 kg/h clean wool is in the order of A\$ 5000000 (corresponding to about 2.8 million euros).

An estimate of the operating costs can be derived from the consumption levels reported in Table 3.8.

Driving forces for implementation

Scarcity of water is probably the main driving force for the implementation of this technique.

Reference plants

The Wooltech system is applied in one plant in Trieste-Italy.

Reference literature

[201, Wooltech, 2001]

4.5 Pretreatment

4.5.1 Recovery of sizing agents by ultrafiltration

Description

Sizing agents are applied to warp yarn in order to protect it during the weaving process and have to be removed during textile pretreatment, thus giving rise to 40 – 70 % of the total COD load of woven fabric finishing mills.

Water-soluble synthetic sizing agents such as polyvinyl alcohol, polyacrylates and carboxymethyl cellulose can be recovered from washing liquor by ultrafiltration. Recently, it has been confirmed that modified starches such as carboxymethyl starch can also be recycled.

The principle of recovery by ultrafiltration is shown in Figure 4.9. After sizing and weaving, sizing agents are removed during textile pretreatment by hot washing with water in a continuous washing machine (in order to minimise water consumption, the washing process may need to be optimised). Sizing agents concentration in the washing liquor is about 20 - 30 g/l. In the ultrafiltration plant, they are concentrated to 150 - 350 g/l. The concentrate is recovered and can be re-used for sizing, whereas the permeate can be recycled as water in the washing machine. Note that the concentrate is kept at high temperature (80 - 85°C) and does not need to be reheated [179, UBA, 2001].

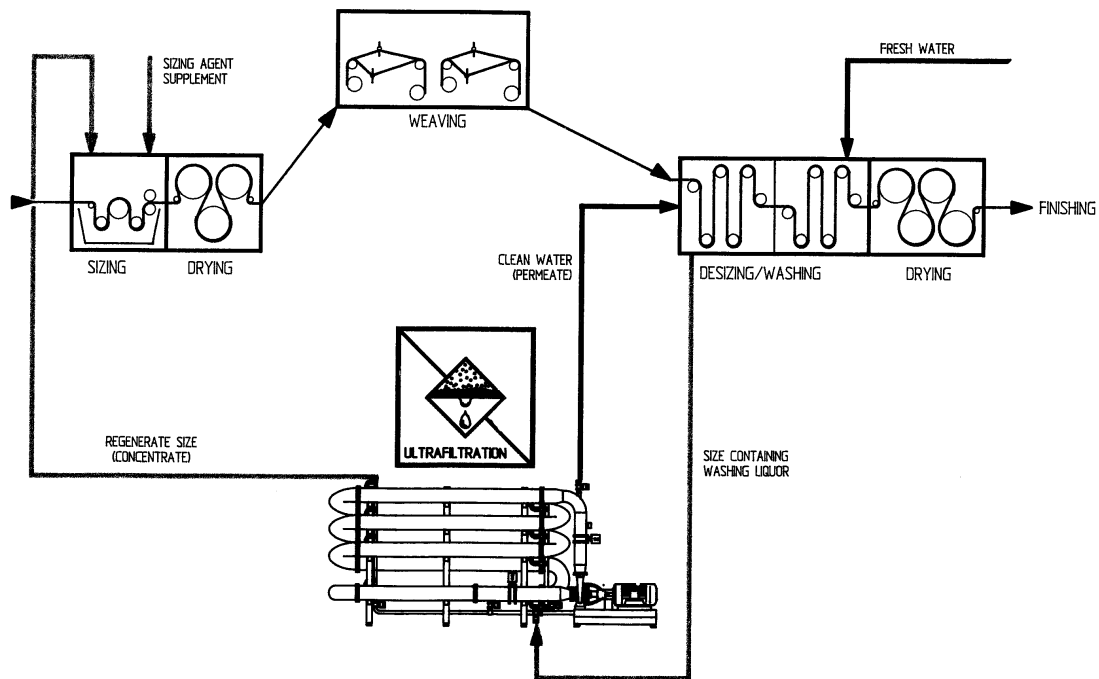
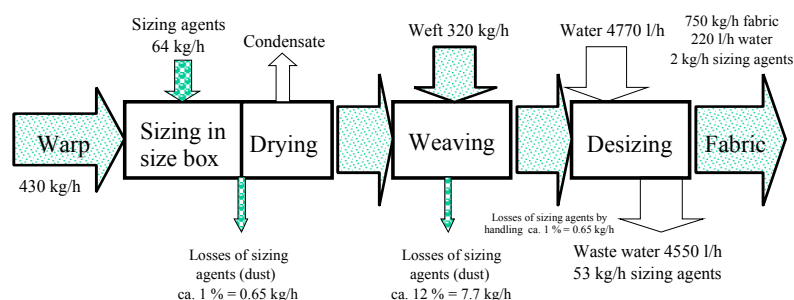


Figure 4.9: Recovery of sizing agents by ultrafiltration
[179, UBA, 2001]

Figure 4.10 shows the mass balance of sizing agents and water for the process with and without recovery in a representative case study. It can be noticed that, even with recovery, some losses of sizing agent still occur at various steps of the process, especially during weaving. Furthermore, a certain amount of sizing agent still remains on the desized fabric and a fraction ends up in the permeate. In conclusion, the percentage of sizing agents which can be recovered is 80 – 85 %.

Material balance for sizing agents without recovery



Material balance for sizing agents with recovery

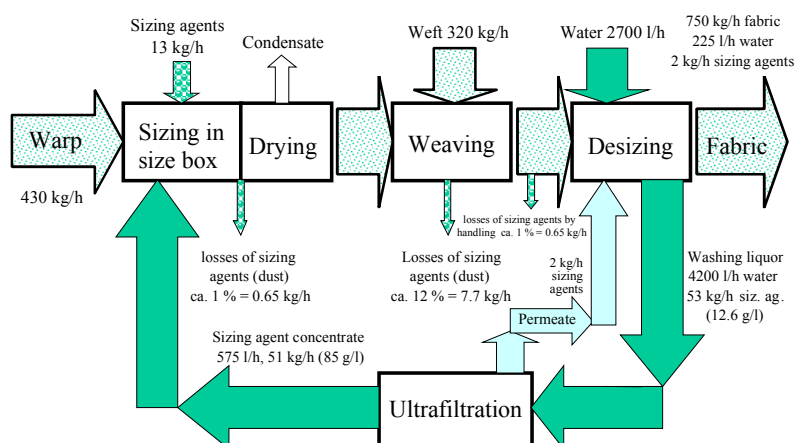


Figure 4.10: Representative example of mass balance for sizing agents and water with and without recovery
[179, UBA, 2001]

Main achieved environmental benefits

COD load of waste water from finishers of woven fabric is reduced by 40 – 70 %. Sizing agents are recovered by 80 – 85 %. In addition, sizing agents in waste water do not need to be treated. Thus energy consumption for treatment is reduced significantly as well as quantity of sludge to be disposed of [179, UBA, 2001].

Ultrafiltration is very efficient in reducing high organic load from textile mills. However, it has to be remembered that the polymers used for recoverable sizing agents are also widely applied in products such as household detergents, which are found in great quantities in other effluents. [61, L. Bettens, 1999].

Operational data

In order to minimise scaling and fouling, fibres have to be removed before ultrafiltration. The same applied to fine particles, such as singeing dust. A pre-filtration step is carried out for this purpose.

When desizing coloured woven fabric (dyed warp yarn), the desizing liquor becomes slightly coloured. Dyestuff particles are more difficult to remove and the liquor needs to be submitted to microfiltration (which is more complex, but still feasible) [179, UBA, 2001].

The operation/management of ultrafiltration units for recovery of sizing agents requires qualified staff and accurate maintenance.

Cross-media effects

Ultrafiltration needs energy, but the amount consumed is much less than the energy required to produce new sizing agents (if they are not recovered) and to treat them in a waste water treatment plant [179, UBA, 2001].

Applicability

As explained earlier, this technique is suitable only for specific types of sizing agents. These are water-soluble synthetic sizing agents such as PVA, polyacrylates and carboxymethyl cellulose. Recently, it has been confirmed that some modified starches such as carboxymethyl starch can also be recycled.

Re-use in the weaving plant is not always without problems. Stock and the recovered size need to be kept under sterile conditions when stored and mixed with virgin size. In the past, failure of protection against bacterial growth (biological degradation of concentrates and contamination of the ultrafiltration equipment) resulted in the shutdown of a recycling plant in Belgium [61, L. Bettens, 1999]. Nowadays, recovered sizing agents are kept at temperatures above 75 °C. It is reported that under these conditions there are no problems of microbial attack and therefore no addition of biocides is needed to maintain sterile conditions [280, Germany, 2002].

Limitations in the applicability of this technique may arise from cases where the auxiliaries applied to the yarn are not only sizing agents, but also waxes, antistatic agents, etc. These compounds remain in the concentrate after UF. The concentrate can be re-used for sizing, but limitations can be found when re-using the same concentrate for different kind of yarns (with different applications and end-uses) which may need specific additives [281, Belgium, 2002]. To date, the weavers' acceptance of recovered sizes is still limited. Weavers are concerned about the quality of the recovered size. Furthermore, certain effects such as minting can only be carried out with non-desized fabric. For these reasons, re-use of the concentrate is typically applied in integrated companies with a uniform production.

A further issue to consider is the transport distances. Long-distance shipments cancel out any ecological advantages because the liquor needs to be transported in adequate conditions in insulated tankers [179, UBA, 2001]. Although, there are mills where recovery is carried out in spite of a considerable distance between the weaving and finishing departments (up to 300 km in one company in the USA), sizing agents are usually recovered in integrated mills having a weaving and a finishing section at the same site.

When weaving and finishing (desizing) take place in completely different places, a more practicable option would probably be to remove and recover the sizing agents directly in the weaving mill, which would therefore produce desized fabric. However, while the quantity of processed fabric must be higher than 1000 t/yr to make the process cost-effective in an integrated mill, the minimum amount in a weaving mill producing desized fabric is much higher (about 5000 - 8000 t fabric/yr) because, in addition to the ultrafiltration plant, a washing machine and a dryer have to be installed [179, UBA, 2001]. Additionally the textile finishers' acceptance of already de-sized fabric is still limited and certain effects such as minting can only be carried out with non-desized fabric.

Economics

A cost/benefit assessment should take into account not only the costs of ultrafiltration, but also the recipe and overall process and treatment costs, especially when considering that changing over from starch and starch derivatives to synthetic sizing agents also has implications for weaving efficiency. Synthetic sizing agents are more expensive than starch-based sizing agents, but they are applied in lower amounts and the weaving efficiency may be higher.

The following table presents a typical example of the annual savings achievable when introducing recovery of sizing agents [179, UBA, 2001].

Input for sizing	Without recovery (annual basis)		With recovery (annual basis)	
		EUR		EUR
Produced woven fabric	8750 t		8750 t	
Quantity of warp yarn	5338 t		5338 t	
Load of sizing agents ⁽¹⁾	13.8 %		10 %	
Recovered sizing agent	-		427 t	76095
Starch derivative	470 t	261435		
PVA	264 t	722500	75 t	205100
Polyacrylates (100 %)			32 t	158400
Wax	59 t	133040	26.7 t	30485
Fresh water	5075 m ³	5840	755 m ³	830
Steam	890 t	10780	350 t	4235
Electricity	155680 kWh	8560	32000 kWh	1760
Manpower	4450 h	58700	1680 h	22180
Total cost		1200855		499085
[179, UBA, 2001]				

Table 4.15: Typical example of annual savings achievable when introducing recovery of sizing agents
[179, UBA, 2001]

In the example given in the table, there will be additional savings because of the higher weaving efficiency and the reduced cost of pretreatment (time saving and significantly reduced consumption of chemicals for degradation and removal of sizes compared to starch-based products) and waste water treatment. The payback time of an ultrafiltration plant may then be less than one year [179, UBA, 2001], which suggests that in most cases companies primarily invest in this technique not because of the environment, but because of the economical benefit.

The investment costs for the ultrafiltration plant referenced above illustrated above are the following [179, UBA, 2001]:

	EUR
- ultrafiltration plant:	1000000
- equalisation tank:	105000
- installation:	77000
- start up:	27500
- miscellaneous:	27500
- total investment cost:	1237000

Driving force for implementation

Waste water problems and cost reductions have been the most important driving forces to implement recovery of sizing agents [179, UBA, 2001].

Reference plants

The first plant for recovery of polyvinyl alcohol went into operation in 1975 in the USA. Meanwhile there are two plants that have been in operation in Germany for many years and various plants are now in operation in Brazil, Taiwan and USA. There are not many suppliers of ultrafiltration plants [179, UBA, 2001].

Reference literature

[61, L. Bettens, 1999], [179, UBA, 2001] with reference to:

“Klaus Stöhr, ATA Journal, Oct/Nov, 2001, 50-52”

“Heinz Leitner, Melliand Textilberichte 10 (1994) E, 205-209”

“Technical information BASF, T/T 372e, July 2000”

“Size UCF-4, Techn. Info BASF (2000)”

4.5.2 Application of the oxidative route for efficient, universal size removal

Description

Many woven fabrics contain a variety of different sizing agents, depending on the origin and quality of the substrate. Most textile finishers deal with many different types of fabrics, and therefore sizing agents, so they are interested in fast, consistent and reliable removal of non-fibrous material (be it the impurities and fibre-adjacent material or any preparation agent) independent of the origin of the fabric.

Enzyme desizing removes starches but has little effect in removing other sizes. Under specific conditions (above pH 13), H_2O_2 generates free radicals which efficiently and uniformly degrade all sizes and remove them from the fabric. This process provides a clean, absorbent and uniform base for subsequent dyeing and printing, no matter which size or fabric type is involved [189, D. Levy, 1998].

Recent studies ([203, VITO, 2001]) show that above pH 13 the oxide radical anion O^* is the predominant form. This species is highly reactive, but it will attack non-fibrous material (sizing agents, etc.) rather than cellulose, for various reasons. First because it is negatively charged like the cellulose polymer in strongly alkaline medium (coulombic repulsion effect) and secondly because, unlike the OH^* it does not react by opening the aromatic rings.

It is recommended to first remove the catalyst that is not evenly distributed over the fabric (e.g. iron particles, copper, etc.). One possible process sequence would therefore be: removal of metals (modern pretreatment lines are equipped with metal detectors), oxidative desizing (peroxide and alkali), scouring (alkali), demineralisation (acid reductive or, better still, alkaline reductive/extractive), bleaching (peroxide and alkali), rinsing and drying.

Main achieved environmental benefits

The proposed technique allows significant environmental benefits: water & energy consumption along with improved treatability of the effluent.

The oxidative route is a very attractive option where peroxide bleaching is carried out. Taking advantage of hydrogen peroxide also being used as an active substance for bleaching, it is advantageous to combine alkaline bleaching with scouring and regulate the countercurrent flow of alkali and peroxide through the different pretreatment steps, so as to save water, energy and chemicals.

Because of the action of free radicals generated by activation of hydrogen peroxide, the size polymers are already highly degraded. The process produces shorter and less branched molecules, glucose, more carboxylated molecules such as oxalate, acetate and formate, which are easier to wash out with a reduced amount of water in efficient washing machines.

The pre-oxidation of size polymer is also advantageous at waste water treatment level (improved treatability). With enzymatic desizing, starches are not completely degraded (the long molecules are not completely broken down after desizing). This means higher organic load to be degraded in the biological plant and it is often the cause of problems such as the production of bulky difficult-to-settle sludge.

Operational data

It is well known that in an oxidative alkaline medium (with hydrogen peroxide) there is potential risk of fibre damage during bleaching if OH* formation is not controlled. Size and the cellulose have similar molecular structure and therefore the attack of the cellulose polymer from non-selective OH* is possible. To achieve good results and avoid damage to the fibre when removing starch-like size, it is essential to add hydrogen peroxide at pH >13. These operating conditions minimise OH* radicals, which are responsible for cellulose damage.

An example of desizing-bleaching padding recipe for PVA/starch blends is:

- detergent (0.3 %)
- sequestrant (0.1 %)
- sodium hydroxide (0.7 - 2.0 %)
- hydrogen peroxide (0.2 - 0.4 %)
- salt (0.04 %)
- emulsifiers as needed.

Cross-media effects

None believed likely.

Applicability

The technique is particularly suitable for commission finishers (independently of their size), who need to be highly flexible because their goods do not all come from the same source (and consequently they do not have goods treated with the same type of sizing agents). In the interests of high productivity, these companies need to operate with a universally applicable technique to enable a right-first-time approach.

There is no need for sophisticated control devices as these are already be available for control of oxidative bleaching. Equipment is no different from modern preparation lines.

Economics

The steps and liquors are combined so that the resource consumption is optimised at overall minimal cost.

Driving force for implementation

With the increased usage of hydrogen peroxide as a replacement for hypochlorite in bleaching, the cost of hydrogen peroxide will continue to drop relative to other oxidants. Selective use of hydrogen peroxide (minimising non-selective reaction pathways) will be important for reducing overall costs, including raw material, energy and environmental clean-up.

Reference literature

[203, VITO, 2001] with reference to:

“Ref. 1995, Catalytic oxidations with oxygen: An Industrial Perspective, Jerry Ebner and Dennis Riley

“Ref. 1998, Peroxide desizing: a new approach in efficient, universal size removal, David Levy”

“Ref. 1995, Environmentally friendly bleaching of natural fibres by advanced techniques, Ludwich Bettens (SYNBLEACH EV5V – CT 94- 0553) - Presentation given at the European

Workshop on Technologies for Environmental Protection, 31 January to 3 February 1995, Bilbao, Spain – Report 7”

4.5.3 One-step desizing, scouring and bleaching of cotton fabric

Description

For cotton woven fabric and its blends with synthetic fibres, a three-stage pretreatment process has been the standard procedure for many years, comprising:

- desizing
- scouring
- bleaching.

New auxiliaries' formulations and automatic dosing and steamers allow the so-called “Flash Steam” procedure which telescopes desizing, alkaline cracking (scouring) and pad-steam peroxide bleaching into a single step [180, Spain, 2001].

Main achieved environmental benefits

Combining three operations in one allows significant reductions in water and energy consumption.

Operational data

Within the space of 2 - 4 minutes (with tight strand guidance throughout) loom-state goods are brought to a white suitable for dyeing. This is a big advantage, especially when processing fabrics that are prone to creasing [180, Spain, 2001].

The chemistry is simple and completely automated with full potential for optimum use.

One of the possible recipes consists of:

- 15 - 30 ml/kg phosphorus-free mixture of bleaching agents, dispersant, wetting agent and detergent
- 30 - 50 g/kg NaOH 100 %
- 45 - 90 ml/kg H₂O₂ 35 %

The sequence of the “Flash Steam peroxide bleach” is:

1. application of the bleaching solution
2. steam 2 - 4 min (saturated steam)
3. hot wash off.

Cross-media effects

None believed likely.

Applicability

Companies with new machinery suitable for this process can apply this technique [180, Spain, 2001]. No more detailed information was made available.

Economics

No information was made available.

Driving force for implementation

Increase in productivity.

Reference plants

Several plants in Europe.

Reference literature

[180, Spain, 2001] with reference to “International dyer, October (2000), p.10”

4.5.4 Enzymatic scouring**Description**

Enzymatic desizing using amylases is an established process that has been in use for many years. More recently, pectinases have shown promise in replacing the traditional alkaline scouring treatment. Some auxiliaries suppliers have introduced an enzymatic process to remove hydrophobic and other non-cellulosic components from cotton. The new process operates at mild pH conditions over a broad temperature range and can be applied using equipment such as jet machines.

It is claimed that, due to a better bleachability of enzyme-scoured textiles, bleaching can be carried out with reduced amounts of bleaching chemicals and auxiliaries. Enzymes actually make the substrate more hydrophilic (which could explain better bleachability), but they are not able to destroy wax and seeds, which are therefore removed in the subsequent bleaching process.

Main achieved environmental benefits

Sodium hydroxide used in conventional scouring treatment is no longer necessary. Furthermore, the following advantages are reported over the traditional procedure (see next table).

	Enzymatic scouring	Enzymatic scouring + bleaching with reduced concentration of hydrogen peroxide and alkali
Reduction in rinsing water consumption	20 %	50 %
Reduction in BOD-load	20 %	40 %
Reduction in COD-load	20 %	40 %
Source: [179, UBA, 2001]		

Table 4.16: Environmental benefits achieved with an enzymatic scouring process

Operational data

A typical process for a pad-batch process combining scouring and desizing in one single step is as follows [179, UBA, 2001]:

- impregnation at 60 °C (pH 8 - 9.5) with:
 - 2 - 3 ml/l wetting agent
 - 2 - 5 ml/l emulsifier
 - 5 - 10 ml/l enzymatic compound
 - 4 - 6 ml/l amylase
 - 2 - 3 g/l salt
- storing for 3 - 12 h, depending on the amount and type of starch
- extraction and rinsing.

Cross-media effects

The environmental benefits remain unclear as enzymes contribute to the organic load and their action is based on hydrolysis rather than oxidation. The organic load not removed with enzymatic scouring may appear in the later wet processing steps. A more global balance would probably reveal no significant improvement.

Applicability

The enzymatic scouring process can be applied to cellulosic fibres and their blends (for both woven and knitted goods) in continuous and discontinuous processes.

When enzymatic desizing is applied, it can be combined with enzymatic scouring.

The process can be applied using jet, overflow, winch, pad-batch, pad-steam and pad-roll equipment.

Economics

Price performance is claimed to be economical when considering the total process costs.

Driving force for implementation

Quality aspects (good reproducibility, reduced fibre damage, good dimensional stability, soft handle, increased colour yield, etc.), technical aspects (e.g. no corrosion of metal parts) as well as ecological and economical aspects are reported as reasons for the implementation of the enzymatic scouring technique [179, UBA, 2001].

Reference plants

Many plants in Europe [179, UBA, 2001].

Reference literature

[179, UBA, 2001] with reference to:
"kahle, 2000"

Kahle, V.

Bioscouring ein neues, modernes Bio Tech-Konzept
Product information, Bayer AG, D-Leverkusen (2000)

4.5.5 Substitution for sodium hypochlorite and chlorine-containing compounds in bleaching operations

Description

The application of hypochlorite gives rise to subsidiary reactions leading to the formation of a number of chlorinated hydrocarbons such as the carcinogenic trichloromethane (which is also the most frequently formed as it is the end of the reaction chain). Most of these by-products can be detected as adsorbable organic halogens by means of the sum parameter AOX. Similar contributions to the formation of hazardous AOX come from chlorine or chlorine-releasing compounds and strong chlorinated acids (e.g. trichloroacetic acid). Halogenated solvents are a different category of problematic AOX (see also Section 2.6.1.2).

Sodium hypochlorite was for a long time one of the most widely used bleaching agents in the textile finishing industry. Although it has been largely replaced in Germany and many other European countries, it is still in use not only as a bleaching agent, but also for cleaning dyeing machines or as a stripping agent for recovery of faulty dyed goods.

In certain conditions, sodium chlorite may also give rise to the formation of AOX, although to a lesser extent than hypochlorite. However, recent investigations have shown that the cause is not sodium chlorite itself, but the chlorine or hypochlorite present as impurities (from non-stoichiometric production) or used as activating agent. Recent technologies (using hydrogen peroxide as the reducing agent of sodium chlorate) are now available to produce ClO_2 without generation of AOX [18, VITO, 1998], [59, L. Bettens, 2000].

Hydrogen peroxide is now the preferred bleaching agent for cotton and cotton blends as a substitute for sodium hypochlorite.

When a single-stage process using only hydrogen peroxide cannot achieve the high degree of whiteness required, a two-stage process with hydrogen peroxide (first step) and sodium hypochlorite (second step) can be applied, in order to reduce AOX emissions. In this way the impurities on the fibre – which act as precursors in the haloform reaction – are removed, thus producing a reduction in AOX in the effluent. Nevertheless, a two-stage bleaching process using only hydrogen peroxide is today possible, thus completely eliminating the use of hypochlorite (cold bleaching at room temperature followed by a hot bleaching step).

There is also increasing support for peroxide bleach under strong alkaline conditions, which achieves a high degree of whiteness after careful removal of catalysts by a reduction/extraction technique. The additional advantage claimed is the possible combination of scouring and bleaching. The reduction/extraction followed by a strong oxidative combined bleaching/scouring step (high alkali and high active oxygen concentration) is applicable for bleaching highly contaminated textiles in all make-ups and on all types of machines (discontinuous and continuous). This method takes the oxidative route and uses the active oxygen.

Main achieved environmental benefits

The presence of hazardous AOX such as trichloromethane and chloroacetic acid in the effluent is avoided.

Operational data

Particular attention needs to be paid to the combination or sequence of pretreatment operations and to the mixing of streams containing hypochlorite or chlorine. For example, the application of the two-step bleaching method where hypochlorite as well as peroxide is used, is potentially hazardous if the hypochlorite bleaching is performed when large quantities of organohalogen precursors are still present on the substrate. The risk would thus be reduced if hypochlorite

bleach came as a last step after an alkaline peroxide bleach that removes the precursors from the fibre. However, no data were made available that show the importance of reversing the sequence of the two steps from hypochlorite → peroxide into peroxide → hypochlorite. It is actually more important to avoid mixing hypochlorite bleach waste water with certain other streams and mixed effluents, in particular from desizing and washing, even when the right sequence of pretreatment and bleaching is adopted. The formation of organohalogenes is highly possible in combined process streams.

For chlorite bleach, handling and storage of sodium chlorite needs particular attention because of toxicity and corrosion risks. Machinery and equipment need to be inspected frequently because of the high stress to which they are subjected (see also Section 2.6.1.2).

Cross-media effects

Complexing agents (e.g. EDTA, DTPA, phosphonates) are normally applied as hydrogen peroxide stabilisers. The main concerns associated with the use of these substances arise from their ability to form stable complexes with metals (remobilisation of heavy metals), their N- and P- content and their often low biodegradability/bioeliminability. The addition of strong sequestering agents, however, can be avoided by fine control of the pH conditions during the bleaching process (see Section 4.5.6) and with the assistance of silicates, magnesium, acrylates or biologically degradable carboxylates, slowing down the uncontrolled decomposition of hydrogen peroxide (see Section 4.3.4).

Optical brighteners are often applied when peroxide bleaching is not sufficient to achieve the required level of whiteness. The resulting COD load and smoke during fixation in the stenter have to be taken into account. Moreover, optical whiteners are potentially irritating and thus not always acceptable for white goods coming into close contact with the skin (e.g. underwear, bedsheets).

Applicability

Substitution for hypochlorite as bleaching agent is applicable to both new and existing installations.

Hydrogen peroxide is a valid substitute for bleaching yarn and woven fabric made of most cellulosic and wool fibres and most of their blends. Today a full hydrogen peroxide bleaching process is also applicable to cotton & cotton-blend knitted fabric and a high degree of whiteness (>75 BERBER Whiteness Index) can be obtained (with a strong alkaline scour/bleach after removal of the catalyst).

Exceptions are flax and other bast fibres that cannot be bleached using peroxide alone. Unlike chlorine dioxide, the anionic bleaching agent is not strong enough to remove all coloured material and does not preferentially access the hydrophobic region of the fibre. A two-step hydrogen peroxide-chlorine dioxide bleaching is an option for flax.

It is claimed that a sequence where precursors of halogenation are removed with a peroxide bleach followed by a hypochlorite bleach (or a peroxide pre-bleach followed by a combined hydrogen peroxide/hypochlorite bleach) is still necessary for high whiteness and for fabrics that are fragile and would suffer from depolymerisation.

Sodium chlorite is an excellent bleaching agent for flax, linen and some synthetic fibres.

Economics

In general, bleaching with hydrogen peroxide is no more expensive than with hypochlorite because of market saturation.

The two-stage bleaching process with hydrogen peroxide proposed for knitted fabric is reported to be from two to six times more expensive than the conventional process using hydrogen peroxide and hypochlorite [179, UBA, 2001].

If using chlorine dioxide as bleaching agent, investment may be needed (in existing installations) for equipment resistant to the highly corrosive conditions in which this bleaching agent is used.

As far as the production of elemental chlorine-free chlorine dioxide is concerned, this process is fully investigated and described in another BREF (pulp & paper industry).

Driving force for implementation

Market demands for chlorine-free bleached textiles and the requirements set by legislation (regarding waste water discharge) are the main driving forces for the implementation of this technique.

Reference plants

Many plants in Europe and worldwide largely use substitutes for sodium hypochlorite as bleaching agent.

Reference literature

[179, UBA, 2001], [51, OSPAR, 1994] (P059, P063), [203, VITO, 2001].

4.5.6 Minimising consumption of complexing agents in hydrogen peroxide bleaching

Description

When bleaching with hydrogen peroxide, oxygen species of differing reactivity may be present in water (O_2^{*} , H_2O_2/HOO^- , H_2O/OH^- , HOO^*/O_2^{*-} , OH^*/O^{*-} , O_3/O_3^{*-}). The kinetics of formation and disappearance depend on concentration of oxygen, energy for activation, reduction potential, pH, catalyst and other reagents. These processes are very complex and can only be explained with dynamic simulation models. It is widely accepted that the OH^* radical is responsible for attacking the cellulose fibre and leading to its damage (depolymerisation) and that the formation of the OH^* radical is mainly due to the reaction of H_2O_2/HOO^- with transition metals such as iron, manganese and copper. The prevention of “catalytic” damage of the fibre as a consequence of the uncontrolled formation of OH^* radical is usually achieved by using complex formers that inactivate the catalyst (stabilisers). See also Section 8.5.

Complexing agents (see Figure 4.6) that are typically applied in finishing mills are based on polyphosphates (e.g. tripolyphosphate), phosphonates (e.g. 1-hydroxyethane 1,1-diphosphonic acid) and amino carboxylic acids (e.g. EDTA, DTPA and NTA). The main concerns associated with the use of these substances arise from their N- and P- content, their often-low biodegradability/bioeliminability and their ability to form stable complexes with metals, which may lead to the remobilisation of heavy metals (see also Section 8.5).

The use of high quantities of sequestering agents can be avoided by removing the responsible catalysts from the water used in the process and from the textile substrate and by scavenging away the OH^* .

Softening of fresh water is largely applied by textile mills to remove the iron and the hardening alkaline-earth cations from the process water (magnesium hydrate has a stabilising effect and techniques that remove transition metals and calcium are therefore preferred).

Iron carried with the raw fibre can be present as fibre impurity, rust or coarse iron particles on the surface of the fabric. The latter can be detected and removed by a dry process using magnetic detectors/ magnets (modern continuous lines are equipped with magnetic detectors). This treatment is convenient when the process starts with an oxidative scouring/desizing step, because otherwise a huge amount of chemicals would be required to dissolve these coarse iron particles in a wet process. On the other hand, the previous removal of coarse iron particles is not necessary when an alkaline scouring treatment is carried out as a first step before bleaching.

Magnetic sensors cannot detect non ferromagnetic particles and magnets cannot remove the iron that is inside the fibre (fibre impurities and rust in heavily contaminated goods). This iron fraction has to be solubilised and removed from the substrate by acid demineralisation or reductive/extractive treatment before bleaching. In the case of *acid demineralisation*, Fe(III) oxide, iron metal and many other forms of iron (some organic complexes) are solubilised in strongly acid conditions (by hydrochloric acid at pH 3). This means that the metal parts of the equipment must withstand these conditions. The advantage of the *reductive treatment* is that there is no need to use strong corrosive acids. Moreover, with the new non-hazardous reductive agents (see Section 4.6.5), it is possible to avoid a drastic change of pH.

As mentioned above, OH^* radicals can be scavenged away in order to minimise fibre damage without the need for complexing agents.

In-depth research into the reactivity of hydrogen peroxide (SYNBLEACH EV5V-CT94-0553 EC funded research project) has shown that the control of the process is fundamental to prevent uncontrolled decomposition of hydrogen peroxide and to allow optimum use of hydrogen peroxide.

Figure 4.11 shows that under optimal conditions (pH approximately 11.2, homogeneously distributed catalyst and controlled peroxide concentration) the hydroxyl radical OH^* is scavenged away by hydrogen peroxide, forming the true bleaching agent, the dioxide radical ion (maximum formation of dioxide radical anion O_2^{*-} in accordance with the peak). Under these conditions hydrogen peroxide itself acts as a scavenger and the reaction product is the active bleaching agent itself (which allows optimal use of hydrogen peroxide). The addition of formic acid (formate ion) as scavenging agent is also useful to further control the formation of the OH^* radical, generating more O_2^{*-} and even repairing damage to the fibre.

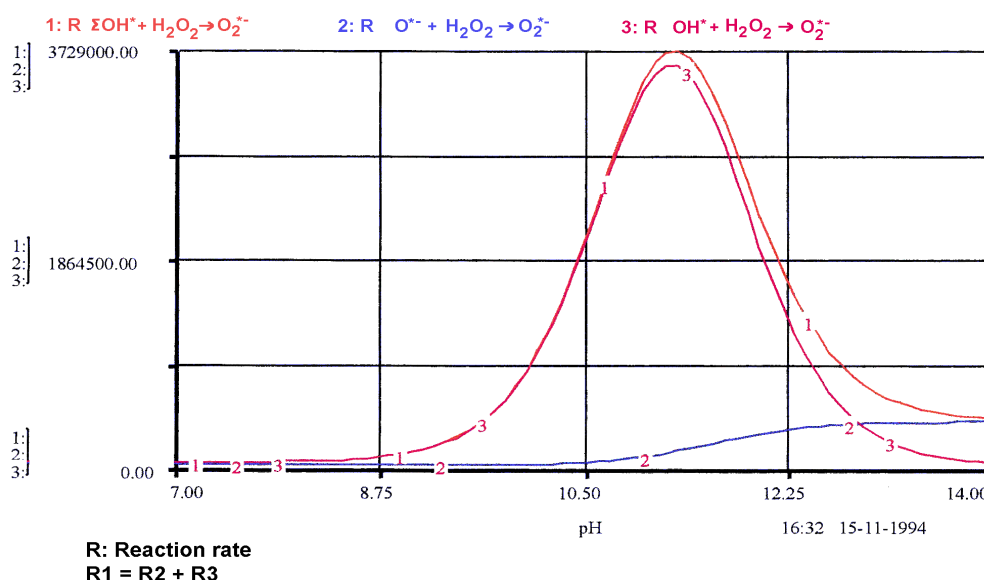


Figure 4.11: Production of the peroxide radical ion by scavenging hydroxyl radicals (OH^*) using hydrogen peroxide [203, VITO, 2001]

Main achieved environmental benefits

With the proposed technique it is possible to bleach cellulose in full and even to high whiteness, without damage to the fibre with:

- no use of hazardous sequestering agents
- minimal consumption of peroxide (<50 % compared with uncontrolled conditions)
- (pre-)oxidation of the removed substances.

Operational data

As mentioned above, as an alternative to acid demineralisation, pre-cleaning of heavily soiled fabric (rust) is possible in more alkaline conditions using non-hazardous reducing agents, without any need for a drastic change in pH. The reduction/extraction is effective for all types of substrates and qualities of fabrics (highly contaminated, uneven distribution of iron-rust). This step is easy to integrate with discontinuous and continuous processes following the oxidative route under mildly or strongly alkaline bleach conditions [203, VITO, 2001].

Cross-media effects

None to be expected.

Applicability

The measures described in this section may be generally applicable to existing and new plants. However, fully automated equipment is necessary for the application of hydrogen peroxide under controlled process conditions. Dosing of the bleaching agent, controlled by a dynamic simulation model, is still limited [203, VITO, 2001].

Economics

Reduction of peroxide consumption by more than 50 % is possible. There is no increase, but rather a decrease in organic load, along with better treatability of the effluent. The chemistry needed is not expensive and is reliable, provided that there is a good knowledge of the complex control parameters [203, VITO, 2001].

Reference plants

The technique described in this section is provided directly by some auxiliaries suppliers. With the help of dynamic simulation models they are able to prepare a recipe that is suitable for the specific substrate, equipment used, etc. under defined process conditions.

Reference literature

[203, VITO, 2001] with reference to:

“Ref. 1995, Environmentally friendly bleaching of natural fibres by advanced techniques, Ludwich Bettens (SYNBLEACH EV5V – CT 94- 0553) - Presentation given at the European Workshop on Technologies for Environmental Protection, 31 January to 3 February 1995, Bilbao, Spain – Report 7”.

4.5.7 Recovery of alkali from mercerising

Description

During the mercerisation process, cotton yarn or fabric (mainly woven fabric but also knit fabric) is treated in a solution of concentrated caustic soda (270 - 300 g NaOH/l, or also 170 - 350 g NaOH/kg textile substrate) for about 40 - 50 seconds. The textile substrate is then rinsed in order to remove caustic soda. This rinsing water is called weak lye (40 - 50 g NaOH/l) and can be concentrated by evaporation for recycling. The principle is shown in the figure below.

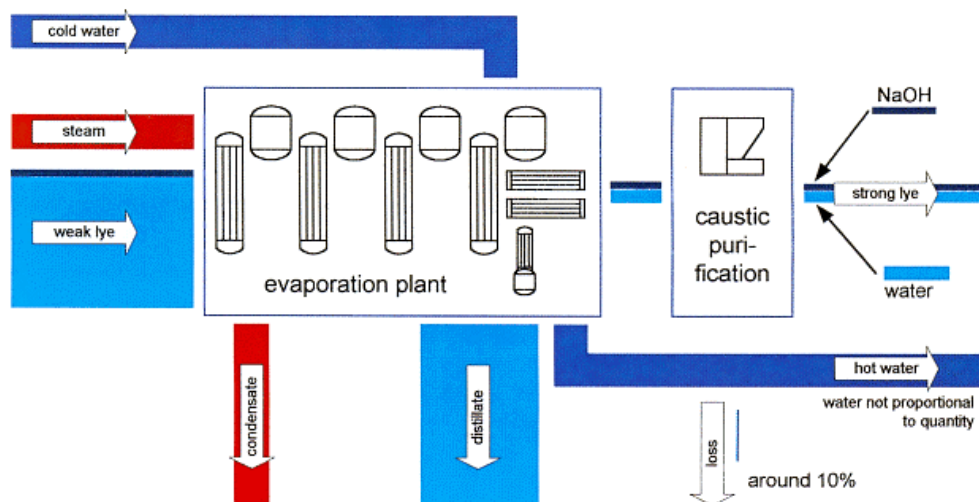


Figure 4.12: Representation of the caustic soda recovery process by evaporation followed by lye purification

[179, UBA, 2001]

After removal of lint, fluff and other particles (using self-cleaning rotary filters or pressure micro-filtration), the weak lye is first concentrated, for instance in a three-stage evaporation process. In many cases, purification of the lye is required after evaporation. The purification technique depends on the degree of lye contamination and can be simple sedimentation or oxidation/flotation with injection of hydrogen peroxide.

Main achieved environmental benefits

The alkaline load of waste water is reduced drastically and acid required for waste water neutralisation is minimised.

Operational data

The concentration of weak lye is usually 5 - 8 °Bè (30 - 55 g NaOH/l) and is increased to 25 - 40 °Bè (225 - 485 g NaOH/l), depending on the mercerising process applied. When mercerisation is carried out on the greige dry textile substrate (raw mercerisation) it is possible to achieve a concentration of caustic soda not higher than 25 - 28 °Bè, whereas a concentration of 40 °Bè can be obtained in non-raw mercerisation. In raw mercerisation, the concentration of impurities is significantly higher, as is viscosity, which makes it difficult to reach higher concentrations (circulation in evaporators is disturbed) [179, UBA, 2001].

The higher the number of stages for evaporation, the more often the heat is re-used, the lower the steam consumption and, therefore, the running cost. Investment, however, obviously increases with the number of stages [179, UBA, 2001].

Cross-media effects

Evaporation requires approximately 0.3 kg steam /kg water evaporated in a 4-stage evaporation plant. This corresponds to 1.0 kg steam/kg of recovered NaOH at 28 °Bé or 1.85 kg steam / kg of recovered NaOH at 40 °Bé.

Applicability

The technique is applicable to both existing and new installations.

Due to the action of active oxygen generated by the decomposition of hydrogen peroxide it is possible to recover and decontaminate coloured alkali for re-use (hydrogen peroxide is already used in the water stream when applying the oxidative route – see Section 4.5.2).

Economics

Investment costs mainly depend on plant size and purification technique and typically vary from 200000 to 800000 euros. Payback time depends on plant size and operating time per day. Usually, if mercerisation is practised full-time, the payback period is less than one year. In companies where non-recovered caustic soda lye has to be neutralised with acid, payback time is less than six months. Thus, from the economic point of view, caustic soda recovery may be very attractive [179, UBA, 2001].

Driving force for implementation

High alkali content of waste water and economic aspects of caustic soda losses are the main driving forces [179, UBA, 2001].

Reference plants

The first caustic soda recovery plant went into operation more than one hundred years ago. Today, there are more than 300 plants in operation worldwide, especially for recovery of caustic soda from woven fabric mercerisation and yarn mercerisation and some from knit fabric mercerisation (the latter process is not applied very often).

Main suppliers in Europe are:

- KASAG Export AG, CH-9259 Kaltenbach, Switzerland
- Körting Hannover AG, D-30453 Hannover, Germany

Reference literature

[179, UBA, 2001], [5, OSPAR, 1994] P040.

4.5.8 Optimisation of cotton warp yarn pretreatment

Description

In the production of white, non-dyed cotton sheets (e.g. sheets to be used under bed sheets and table-cloths) cotton warp yarn is bleached before weaving (for the production of this type of article the fabric does not need to be desized after the weaving process).

The conventional process consists of five steps, including wetting/scouring, alkaline peroxide bleaching and three subsequent rinsing steps. The last rinsing water is re-used for making the first bath.

This process can be further improved by combining wetting, scouring and bleaching in one step and performing rinsing in two steps, re-using the second rinsing bath for making the bleaching/scouring bath (as above).

In addition, the energy consumption of the process has been reduced by heat recovery. The heat from the scouring/bleaching bath (110°C) is recovered (by means of a heat exchanger) and used for heating the fresh water for the first rinsing. The bath is therefore cooled to about 80°C, while the fresh water reaches a temperature of 60 – 70 °C.

This cooled scouring/bleaching bath is collected in a tank together with the warm rinsing water from the first rinsing step. This waste water still has a valuable energy content. Therefore, before being drained, this stream is used to heat the water from the second rinsing step (which is then used for making the bleaching/scouring bath as explained above).

Main achieved environmental benefits

Water consumption and waste water discharge before and after optimisation can be seen from the following table: 50 % reduction of water consumption is achieved.

	Process	Water consumption in the conventional process (litres) ⁽¹⁾	Water consumption in the optimised process (litres) ⁽¹⁾
Step 1	Wetting/scouring	6400	6400
Step 2	Bleaching	5000	
Step 3	Cold rinsing	5000	5000
Step 4	Warm rinsing	5000	
Step 5	Rinsing and pH adjustment with acetic acid	5000	5000
Total		26400	16400
Recycling of last rinsing bath		-5000	-5000
Total water consumption		21400	11400
Specific water consumption (800 kg yarn/batch)		26.8 l/kg	14.3 l/kg
Residual water content in the yarn		1400	1400
Waste water flow		20000	10000
Specific waste water flow		25 l/kg	12.5 l/kg
Source: [179, UBA, 2001]			
Note: ⁽¹⁾ Data are referred to a 800 kg batch			

Table 4.17: Optimisation of warp yarn scouring/bleaching: absolute and specific water consumption and waste water discharge before and after process optimisation

The consumption of chemicals and energy has also been reduced drastically. The following savings are achieved [179, UBA, 2001]:

- process time: about 50 %
- water consumption/waste water discharge: about 50 %
- NaOH: about 80 %
- H₂O₂: no reduction
- complexing agents/stabilisers: about 65 %
- surfactants: about 70 %
- optical brightener: no reduction
- COD load of waste water: about 20 %
- energy: 1.2 kg steam/kg warp yarn

Operational data

The operating conditions of the optimised process are illustrated in Table 4.18, which also contains the calculation of COD-input and -output.

Process input and operating conditions	Quantity	Spec. COD	COD-load per kg of yarn
<u>Wetting/scouring/bleaching</u>			
• Conditions: pH ca. 12, 110°C, 10 min			
• Recipe			
- NaOH 38°Bé (33 %)	3.5 g/l	-	
- H ₂ O ₂ 35 %	3.0 g/l	-	
- Sequestrant and stabiliser	1.0 g/l	85 mgO ₂ /g	0.6 gO ₂ /kg
- Surfactant	1.9 g/l	1610 mgO ₂ /g	24.2 gO ₂ /kg
- Optical brighteners	0.15 wt-%	2600 mgO ₂ /g	<u>3.9 gO₂/kg</u>
			Tot. from auxil. 28.7 gO ₂ /kg
			Extracted from cotton 70.0 gO ₂ /kg
<u>First rinsing</u>			
• Conditions: 70°C, 15 min		3000 mgO ₂ /l	18.7 gO ₂ /kg
<u>Second rinsing</u>			
• Conditions: 70°C, 15 min		1000 mgO ₂ /l	6.2 gO ₂ /kg
			Total 124 gO ₂ /kg

Source: [179, UBA, 2001]

Table 4.18: Optimisation of warp yarn scouring/bleaching: recipe and operating conditions for the optimised process

Cross-media effects

None believed likely.

Applicability

The optimisation of the process is possible for both existing and new installations. For the recovery of heat, space for additional tanks is required, which may be a limiting factor in some cases. The quality of the cotton yarn has to be considered (as regards content of iron, seeds etc.) in order to make sure that the process can be applied.

Economics

The considerable savings of time, water, chemicals and energy make the process highly economic. The optimised process does not require new equipment for pretreatment, but tanks, heat exchangers, pipes and control devices for energy recovery from waste water are required.

Driving force for implementation

Environmental motivation has been the main driving force for the development of the process, but the economic benefit also justifies the investment of effort.

Reference plants

Two textile finishing plants in Germany are using the described optimised process successfully.

Reference literature

[179, UBA, 2001] with reference to:

“van Delden, 2001”

van Deleden, S.

Prozessoptimierung durch Wasserkreislaufführung und Abwasservermeidung am Beispiel einer Kettbaubleiche

Proceedings of BEW-Seminar "Vermeidung, Verminderung und Behandlung von Abwässern der Textilindustrie" on 06.03.2001 (2001)

4.6 Dyeing

4.6.1 Exhaust dyeing of polyester and polyester blends with carrier-free dyeing techniques or with use of environmentally optimised carriers

Description

Due to the high glass transition point of polyethyleneterephthalate, which is in the range of 80 - 100 °C, the diffusion rate of disperse dyestuff molecules into the standard PES fibres (PET based) at normal dyeing temperatures is very low. As a result, dyeing conditions typically used for other types of substrates are not applicable. Exhaust dyeing of single polyester and polyester blends can be carried out either in autoclaves at high temperature (HT-dyeing at 130 °C, which is usually applied for pure PES and wool-free PES blends) or at normal dyeing temperatures (95 °C – 100 °C, which is applied for PES/wool blends) with the help of so-called carriers (see also Sections 2.1.1.1, 2.7.6.2, 2.7.7 and 8.6.7).

Carriers are absorbed to a great extent onto the PES fibre. They improve fibre swelling and encourage colourant migration. In dyeing and rinsing a significant amount of carriers is emitted to waste water. The fraction that remains on the fibre may be emitted to air during subsequent drying, heatsetting and ironing.

Active substances used in carrier formulations include:

- chlorinated aromatic compounds (mono-chlorobenzene, trichlorobenzenes etc.)
- o-phenylphenol
- biphenyl and other aromatic hydrocarbons (trimethyl benzene, 1-methyl naphthalene etc.)
- phthalates (diethylhexylphthalate, dibutylphthalate, dimethylphthalate)

Human and aquatic toxicity, high volatility and high odour intensity are the main concerns associated with the use of the above-mentioned substances (see also Section 2.7.8.1). Not only do water and air become contaminated by the emissions, but it is increasingly suspected that consumer health problems can be caused by remobilisation of halogenated carriers (e.g. 1,2,4-trichlorobenzene) in the treated textiles [18, VITO, 1998].

The application of HT-dyeing processes avoids the use of carriers. This technique is currently widely applied when dyeing pure polyester and wool-free PES blends.

However, due to the sensitivity of the wool substrate to high temperatures, it is still necessary to use carriers when dyeing polyester blends and, in particular, polyester/wool blends. In these cases, hazardous carriers can be replaced by chlorine-free substances with improved toxicological and environmental characteristics. New carriers are based on:

- benzylbenzoate
- and N-alkylphthalimide.

Main achieved environmental benefits

In the case of HT-dyeing processes, waste water and off-gas are carrier-free. The quantity of environmentally problematic substances is reduced.

PES/wool blends may be dyed with benzylbenzoate and N-alkylphthalimide based carriers; benzylbenzoate is a readily biodegradable substance (the degree of mineralisation for the benzylbenzoate is 79 % [179, UBA, 2001]), while N-alkylphthalimide is bioeliminable (the $(\text{BOD}_{30}/\text{COD}) \times 100$ is 50 – 100 %) with a fish toxicity between 10 and 100 mg/l. Moreover, because of their low volatility, odour nuisance (especially in the workplace) is negligible.

Both substances show great affinity for the aqueous medium, which makes them easy to prepare (without need for emulsifying and dispersing agents) and easy to remove at the end of the dyeing process (with lower water consumption).

Operational data

In the case of benzylbenzoate carriers, applied concentrations range between 2.0 and 5.0 g/l (dyeing at boiling temperature; average liquor ratio) [179, UBA, 2001].

N-alkylphthalimide carriers are applied in the range of 2 % (liquor ratio 1:10) to 1 % (liquor ratio 1:20) for dyeing of light shades. For dark shades the amount of carrier varies between 6 % (L.R. 1:10) and 3 % (L.R. 1:20) [179, UBA, 2001].

Cross-media effects

When dyeing in HT-conditions a higher quantity of oligomers tends to migrate to the surface of the fibre.

Dyeing at high temperature also requires higher energy consumption. The balance between the different effects involved (the effects of the hazardous carriers on the environment and the effects of higher energy consumption) is, however, still largely in favour of the application of this technique [179, UBA, 2001].

Benzylbenzoate and N-alkylphthalimide based carriers are less effective than conventional carriers. They have a reduced penetrating and swelling effect. As a result, a longer residence time and higher amounts (about three times as much) are needed to reach the same effect.

Applicability

Carrier-free dyeing at high temperature can be applied to all PES qualities, provided that HT-dyeing equipment is used. Application to PES blends depends on the sensitivity to high temperature of the fibres in the blend, being particularly critical for PES/WO blends.

Dyeing with optimised carriers is applicable to all PES blends.

Economics

Optimised carriers described in this section cost approximately the same as common carriers [179, UBA, 2001].

Driving force for implementation

Limit values enforced by environmental legislation on workplace safety have been one of the main driving forces in the process of elimination/substitution of halogenated and other hazardous carriers.

In 1994, OSPAR recommended cessation of use of organohalogen carriers ([51, OSPAR, 1994]). Moreover, a number of eco-label schemes for textile products include, among their requirements, prescriptions regarding dye carriers. The European Ecolabel, for example, requires that halogenated carriers should not be used. GuT-label requirements (for carpets) state that dye carriers must not be used in manufacture or be detectable in the product.

Reference plants

Carrier-free HT-dyeing processes and the above-mentioned optimised carriers are applied across Europe and the world.

Reference literature

[179, UBA, 2001], [18, VITO, 1998], [61, L. Bettens, 1999], [52, European Commission, 1999], [59, L. Bettens, 2000].

4.6.2 Use of non-carrier dyeable PES fibres

Description

The polymer industry has long shown an interest in the entire series of aromatic polyester polymers made from the homologous series of n-methylene glycols. Among these polymers, PET based polyester fibres are the most important ones in the textile industry. They show excellent mechanical properties and resistance to heat, but their high degree of crystallinity makes them non-dyeable below 100 °C unless dye carriers are applied.

The environmental concerns raised by the use of these hazardous substances and the proposed techniques to counteract this problem are described in the previous section. An additional option to consider is the use of non-carrier dyeable PES-fibres, such as polytrimethylene terephthalate (PTT) polyester fibres (see also Section 2.1.1.1).

Polytrimethylene terephthalate remained an obscure polymer for a long time not because it lacked good physical and chemical properties and potential applications, but because the high cost of synthesis of the starting monomer (1,3-propanediol) has prevented the resulting fibre from being brought to market. PTT polymers are of renewed interest today thanks to Shell's recent breakthrough in a lower-cost synthesis process.

Fibres made from polytrimethylene terephthalate can be dyed or printed using standard disperse dyestuffs without the need for any special processing steps or carriers to accelerate the dyeing process.

Main achieved environmental benefits

The following environmental benefits are achieved in the dyeing process compared to standard polyester fibres (PET type):

- emissions of carriers in the workplace and in the environment are completely avoided
- a lower amount of energy is consumed compared with PET dyed under high-pressure-high – temperature (HT) conditions (PTT is dyed atmospherically at 100 °C with excellent dye exhaustion and colourfastness).

Operational data

Disperse dyes are the recommended dye class for PTT, especially for dark shades. Basic dyes may also be used, but only for light shades.

Dyeing equilibrium for a medium shade is obtained in 30 to 60 minutes, depending on the dyes selected. To achieve a good dye utilisation without compromising productivity, 30 to 45 minutes holding time at 100 °C is recommended [178, VITO, 2001].

The recommended dyeing conditions are pH 7 and 100 °C (PTT at 100 °C was dyed with the same or slightly deeper shade than PET at 130 °C) [178, VITO, 2001].

Cross-media effects

None believed likely.

Applicability

PTT fibres are not only easy to process, but also easy to manufacture. They can be extruded on all commonly used machinery with minor modifications.

Thanks to their performance, they may have extensive applications in carpeting, textiles and apparel, engineering thermoplastics, non-wovens, films and mono-filaments. According to manufacturers, fibres made from CORTERRA® Polymers demonstrated performance equal to and, in many cases, better than other materials such as polypropylene, nylon and PET. However, due to the difference in structure, their physical and mechanical properties obviously differ from standard PES fibres (PET type). As a result, they do not cover exactly the same product market and they cannot be regarded to as “substitutes” for PET fibres.

Economics

The new synthesis route pursued by Shell for the manufacturing of the poly(trimethylene terephthalate) has made PTT fibres competitive on the market with standard PES fibres.

Low dyeing temperature and the broad dyeing pH allowance help to decrease the cost of dyeing. Moreover, the environmental costs associated with the presence of carriers are avoided.

Driving force for implementation

Limit values and restrictions on dye carriers that are currently required by environmental legislation and the leading voluntary Eco-label schemes are the main driving forces for implementation.

In the carpet industry, the possibility of dyeing PES carpets in piece at atmospheric conditions without the use of carriers is particularly convenient (due to the high cost of pressurised machinery for dyeing in piece under HT conditions).

Reference plants

Shell Chemical Company announced the commercial introduction of PTT in 1996 under the trade name of CORTERRA® Polymers.

Reference literature

[178, VITO, 2001]

4.6.3 Dispersing agents with higher bioeliminability in dye formulations

Description

Dispersing agents (see Section 8.6.3) are present in disperse, vat and sulphur dye formulations (and they are further added in the subsequent steps) to ensure uniform dispersion throughout the dyeing and printing processes. Disperse dyes in powder or granulated form contain 40 – 60 % (in some cases up to 70 %) of dispersing agents, whereas liquid formulations contain 10 – 30 % (see also Table 2.15, Section 2.7.8). Usually, in the case of dark shades, no additional dosage of dispersing agents is required, whereas this may be necessary for pale shades. The quantities in vat and sulphur dyestuffs may be similar but precise information is not available.

The dispersing agents do not have affinity for the fibres and they are therefore found in the final effluent. Due to the significant amounts applied and to their often-low biodegradability/bioeliminability they contribute to most of the recalcitrant organic load originating from dyeing and printing processes.

In particular, the lignosulphonates and the condensation products of naphthalene sulphonic acid with formaldehyde, which are widely applied as dispersing agents, show COD levels as high as 1200 mg/g (lignosulphonates) and 650 mg/g (naphthalenesulphonic acid condensation products). Elimination in biological waste water treatment is insufficient for both products. Thus, they contribute to residual (recalcitrant) COD in treated waste water [179, UBA, 2001].

Improved dispersing agents are now available that can substitute conventional dispersing agents in the dye formulations up to a maximum of 70 %. Two options are possible [179, UBA, 2001]: *Option A* (to date only applicable to liquid formulations of disperse dyestuffs): it consists in the partial substitution of conventional dispersing agents with optimised products based on fatty acid esters. A mixture of dispersing agents is used, where fatty acid esters represent the main components. The dispersing effect of the product is improved compared to conventional dispersing agents, which means that the amount of dispersing agent in the formulation can be significantly reduced. The tinctorial strength of the dye is also improved (from 100 % to 200 %) due to the correspondingly higher concentration of the dyestuff in the formulation (“Grütze, 2000”).

Option B (applicable to common dispersing agents in powder and granulate formulations): it consists in applying dispersing agents based on mixtures of the sodium salts of aromatic sulphonic acids (“Kilburg, 1997”). It is reported that these products are modified compounds of the common condensation products of naphthalene sulphonic acid with formaldehyde. This chemical modification leads to higher bioelimination rates because of increased adsorption rate to the biomass. However, they remain non-biodegradable compounds.

Main achieved environmental benefits

Option A) According to the Modified Zahn-Wellens-Test (OECD 302 B), bioelimination rates are between 90 and 93 %. A comparison between conventional disperse dyes and optimised formulations (average values considering the whole dye range) is given in Figure 4.13. Differences in tinctorial strength are taken into account.

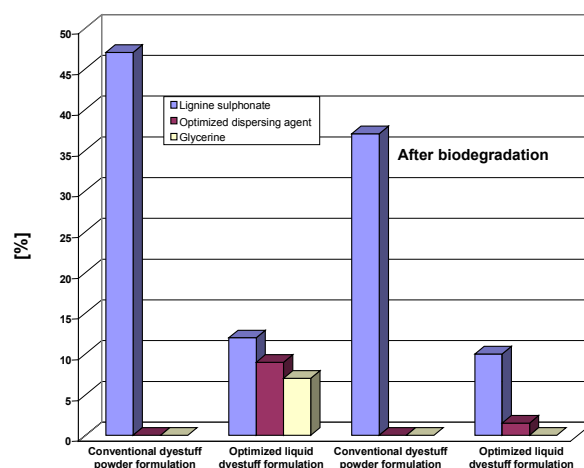


Figure 4.13: Comparison between the composition of conventional and new liquid formulations of liquid disperse dyes, before and after biological treatment (the (%) in the y axis indicates the percentage of dispersing agents related to the overall formulation) [179, UBA, 2001]

Option B) Figure 4.14 compares the bioelimination rates of conventional condensation products of naphthalene sulphonic acid with formaldehyde and the modified optimised ones. The degree of bioelimination of the modified dispersing agent is about 70 % (test method according to OECD 302 B) compared to 20 – 30 % for the conventional one.

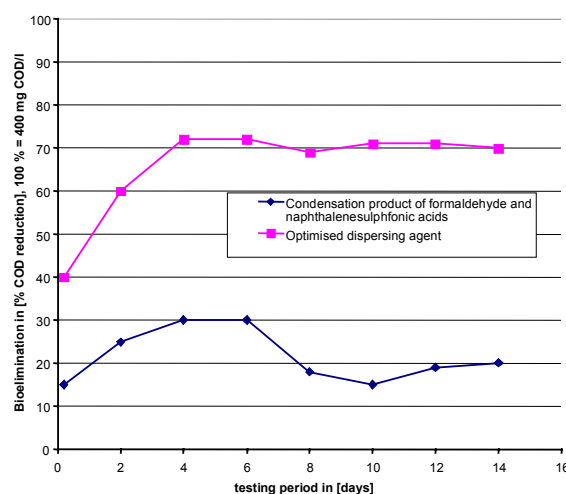


Figure 4.14: Comparison of the bioelimination rates of conventional and modified dispersing agents, both based on condensation products of naphthalenesulphonic acid with formaldehyde [179, UBA, 2001]

Operational data

The application of environmentally optimised dispersing agents proposed does not imply changes in the process compared to the application of conventional products.

Cross-media effects

None believed likely.

Applicability

Option A) These dispersing agents can only be used for liquid formulations of disperse dyes; there is no restriction regarding application, but the dyestuff palette is currently limited.

Option B) These dispersing agents can be used both for disperse and vat dyes (solid and liquid formulations).

Economics

Dye formulations containing dispersing agents with improved bioeliminability are in general more expensive than conventional ones [179, UBA, 2001].

Driving force for implementation

The improvement of the environmental performance is the main driving force encouraging finishing mills to select dyes containing dispersing agents with a better degree of bioelimination.

Reference plants

Many plants in Europe.

Reference literature

[179, UBA, 2001] with reference to “BASF Aktiengesellschaft, Technical Information TI/T 7063 d, 1998”.

4.6.4 One-step continuous vat dyeing in pastel to pale shades

Description

The conventional pad steam process with vat dyes (see Section 2.7.3) includes the following steps:

- padding of dyestuff pigments
- intermediate drying
- padding of chemicals/auxiliaries (reducing agents)
- steaming
- oxidising
- washing (several washing and rinsing steps).

In some cases the process can be carried out without steaming and subsequent washing, according to the following simplified sequence (similar to the dyeing process with pigments):

- padding of dyestuffs and chemicals/auxiliaries in one step
- drying
- fixation.

Special selected vat dyes with a low tendency to migration need to be used. Moreover, auxiliaries based on polyglycols and acrylic polymers are necessary, which improve pad liquor stability and provide a high fastness level.

Main achieved environmental benefits

A number of steps, in particular the washing operations, are avoided. As a result, only the residual padding liquors have to be disposed of at the end of the process and water consumption is minimised to approximately 0.5 l/kg of textile [179, UBA, 2001].

Savings in chemicals and energy are also obtained.

Operational data

A typical recipe for the padding liquor includes [179, UBA, 2001]:

- binder: 30 - 40 g/l
- sodium sulphate: 5 - 10 g/l
- antimigrant: 10 - 20 g/l
- dyestuff: up to 2.5 g/kg

Among typical process parameters, the pick-up should be as low as possible (50 – 65 %) and the liquor temperature should be kept below 35 °C. Intermediate drying is carried out at 100 - 140 °C, while thermofixation conditions are typically 30 s at 170 °C for cellulose and 30 s at 190 °C for polyester/cellulose blends [179, UBA, 2001].

Cross-media effects

None believed likely.

Applicability

The technique is suitable for cellulose and cellulose/polyester blends. The applicability, however, is restricted to pastel to pale shades (up to approximately 5 g/l of dyestuff at 50 % liquor pick-up).

Economics

Significant benefits are achieved compared to the conventional pad-steam method, thanks to savings in energy, time, water and chemicals.

Driving force for implementation

Economic benefit is the main motivation for the implementation of this technique.

Reference plants

Many plants in Germany and world-wide [179, UBA, 2001].

Reference literature

[179, UBA, 2001] with reference to “BASF Aktiengesellschaft, Technical Information TI/T 7063 d, 1998 and 7043 d, 1998”.

4.6.5 Aftertreatment in PES dyeing

Description

A major problem in the dyeing of PES fibres and PES blends using disperse dyestuffs is wash fastness. In order to meet washing fastness requirements, an after-treatment step is carried out,

which removes the non-fixed disperse dyes from the fibre. Reductive after-clearing is normally preferred over simple washing with surfactants because disperse dyestuff molecules absorbed on the surface are broken down into smaller, often colourless and more readily water-soluble fragments (see 2.7.6.2). The precondition is that no dyestuffs susceptible to reduction have been used for dyeing.

In the conventional process, after dyeing the polyester at 130 °C, the dye bath (acidic) needs to be cooled down to 70 °C before draining, in order to bring the fibre below its glass transition temperature. The reductive aftertreatment is carried out in a new bath using hydrosulphite and a dispersing agent in alkaline conditions (the temperature is raised again to 80 °C during the process). Afterwards the bath is drained and one or two more rinsing steps are needed in order to remove the remaining alkali and reducing agent. The pH of the textile before entering the steamer needs to be between 4 and 7 in order to avoid yellowing. Rinsing is therefore carried out in acidic conditions.

Beside the environmental concerns involved with the use of hydrosulphite as reducing agent (see 2.7.8.1), this process entails three bath changes (including temperature raising/cooling cycles) and two changes in the pH of the treatment baths: from acidic pH of the dyeing liquor to the high alkalinity of the aftertreatment bath and back again to acidic levels in the rinsing baths. The double change produces higher consumption of water, energy and chemicals, greater demands on time and increased levels of salt in the effluent.

Two different approaches are proposed:

- *Approach A*) consists of using a reducing agent based on a special short-chain sulphinic acid derivative that can be added directly in the exhausted acidic dye bath. This reducing agent is liquid and can therefore be metered automatically. Moreover, it has very low toxicity and is readily biodegradable [179, UBA, 2001], [181, VITO, 2001].
- *Approach B*) consists of using disperse dyes that can be cleared in alkaline medium by hydrolytic solubilisation instead of reduction. These are azo disperse dyes containing phthalimide groups [182, VITO, 2001].

Main achieved environmental benefits

Approach A)

First of all, because this reducing agent can be applied in the acidic pH range, significant water and energy savings can be achieved. Compared to the conventional process, up to 40 % of water can be saved.

Moreover, these aliphatic short-chain sulphinic acid derivatives are readily biodegradable (the product is non volatile and water-soluble, with more than 70 % DOC reduction within 28 days, under the OECD test 302B). The sulphur content of the product is approximately 14 %, compared to 34 % of sodium dithionite and the amount of by-products (sulphites and sulphates) can be reduced by half relative to the conventional process (see table below).

It is also worth noticing that unlike sodium dithionite, the product is non-corrosive, non-irritant, non-flammable and does not have an unpleasant odour. As a result, workplace safety compared to dithionite is improved and odour nuisances minimised.

Recipe	Sulphur concentration in mixed effluent ⁽¹⁾ (mg/l)	Specific sulphur load ⁽²⁾ (mg/kg PES)	Max sulphite concentration in mixed effluent ⁽¹⁾ (mg/l)	Max specific sulphite load ⁽²⁾ (mg/kg PES)
Sodium dithionite (3 g/l) 2 rinsing baths	260	4100	640	10300
Sulphinic acid (3 g/l) 2 rinsing baths	100	1700	130	2000
Sulphinic acid (3 g/l) 1 rinsing bath	200	1700	260	2000

Source: [179, UBA, 2001] with reference to “WO 98/03725; BASF Aktiengesellschaft, Priority, July 23rd 1996”

Notes:
(1) Mixed effluent: sum of the exhausted dye bath, the clearing bath and the number of rinsing baths
(2) Data are calculated assuming a liquor ratio of 1:4

Table 4.19: Sulphur and sulphite concentration and load in the mixed effluent from typical processes using sodium dithionite or sulphinic acid based reducing agents

Approach B)

With alkali-dischargeable dyes the use of hydrosulphite or other reducing agents can be avoided, which means a lower oxygen demand in the final effluent.

There is the possibility of dyeing PES/cotton blends using a one-bath two-step dyeing method, as alkali-clearable dyes can be applied in the same bath with cotton reactive dyes. This brings about additional environmental benefits in terms of water and energy consumption.

Operational data

Approach A)

In most cases concentrated hydrosulphite can be replaced by the same quantity of the referenced product. In a typical process 1.0 – 1.5 ml/l of reducing agent (for medium shades) and 1.5 – 2.5 ml/l (for dark shades) are added to the exhausted dye bath. The process is carried out for 10 – 20 min at 70 – 80 °C. Hot and cold rinsing follow [179, UBA, 2001].

In order to derive the maximum environmental and economic benefit from the proposed technique, it is of primary importance that only the strict amount of reducing agent needed to reduce the dyestuff is consumed. Consumption of the reducing agent by the oxygen in the machine should therefore be avoided as much as possible. One effective technique to ensure this is to use nitrogen to remove oxygen from the liquor and the air in the machine [182, VITO, 2001].

For some types of polyesters that show a higher percentage of oligomer migrating to the surface during the dyeing process, it is advantageous to carry out the aftertreatment in a fresh bath.

Approach B)

The example below gives a comparison between two equivalent recipes, one with alkali-clearable dyes and the other with standard disperse dyes:

(Recipe with alkali-clearable dyes)

- Dye 40 g/kg
- pH stabiliser 25 g/kg
- Equalisation agent 10 g/kg

(Recipe with standard dye)

- Dye 55 g/kg
- Acetic acid 25 g/kg
- Equalisation agent 10 g/kg
- Levelling agent 5 g/kg
- Dispersing agent 12 g/kg
- Detergent 12 g/kg

With alkali-clearable disperse dyes there is no need for levelling agents, dispersing agents or detergent. Moreover the amount of dye used is reduced. The resulting environmental benefits are evident.

Cross-media effects

Approach A) When the product is used in the dye bath, the unfixed dispersed dye particles are destroyed by reduction so that the effluent is largely free of colour. On the other hand, the by-products of the reductive reaction may be more hazardous than the original dyestuff (e.g. aromatic amines originating from reduction of azo dyes). The effluent therefore needs to be treated before being discharged (for polyester oligomers and aromatic amines).

Approach B) None believed likely.

Applicability

Approach A) The technique can be used in all types of dyeing machines, not only for polyester fibres, but also for PAC, CA and their blends. The only limitation on applicability is with blends with elastane fibres.

Approach B) Alkali-clearable dyes are currently applied for both for PES and PES/cotton blends, with greater environmental and economic advantages being achieved with PES/cotton blends.

Economics

Approach A) Significant savings can be achieved as a result of higher productivity, reduced consumption of energy, water and chemicals and the lower burden in waste water.

Approach B) The use of alkali-clearable dyes implies higher recipe costs compared to conventional disperse dyestuffs (about twice as much: the total cost of a recipe with alkali-clearable dye is about EUR 0.5/kg, whereas with standard disperse dyes this is in the order of EUR 0.2/kg). However, Approach B is expected to bring savings in time (higher productivity) and reduce water, energy and chemicals costs, (particularly when these dyes are applied for PES/cotton blends).

Driving force for implementation

Cost savings (higher productivity) and improvement of the environmental performance (especially with regard to sulphite content in the waste water) are the main reason for application of both these techniques.

Reference plants

Approach A) The proposed technique is applied in at least five finishing mills in Germany and world-wide as well [179, UBA, 2001].

Approach B) Many plants in Europe.

Reference literature

[179, UBA, 2001] with reference to “BASF Aktiengesellschaft, Technical information TI/T 7043 d, 1998”, [180, Spain, 2001], [182, VITO, 2001], [181, VITO, 2001], [59, L. Bettens, 2000].

4.6.6 Dyeing with sulphur dyes

Description

Sulphur dyestuffs are of great importance world-wide in dyeing cotton in medium to dark shades (especially black) with a high fastness to light and washing. Sulphur dyes are insoluble in water and they need to be converted to the water-soluble “leuco-form” at some stage during the dyeing process (see also Section 9.9).

Conventional sulphur dyes are available in powder form. Before dyeing, they have to be reduced with sodium sulphide in alkaline conditions. Other typical sulphur dyes are the “pre-reduced”/“ready-for-use” dyes. They are supplied in liquid form and already contain the reducing agent in their formulation (the sulphide content may be higher than 5 % [179, UBA, 2001]).

Excess of sulphide (from the dyestuff and reducing agent) is responsible for aquatic toxicity and odour nuisances (workplace atmosphere) (see also Section 2.7.8.1 – “Sulphur-containing reducing agents”).

The ecological profile of sulphur dyeing has decisively improved thanks to the introduction of new sulphur dyes and alternative reducing agents.

The classic powder and liquid sulphur dyes can be successfully replaced by [179, UBA, 2001]:

- pre-reduced dyestuffs (liquid formulations with sulphide content <1 %) (with reference to “DyStar, 2001”)
- non-pre-reduced sulphide-free dyestuffs (water-soluble in the oxidised form) (with reference to “DyStar, 2001”)
- non-pre-reduced sulphide-free stabilised dispersed dyestuffs (in powder or liquid form) (with reference to “DyStar, 2001”)
- non-pre-reduced sulphide-free dyestuffs (stable suspension) (with reference to “Clariant, 2001”).

Unlike the old sulphur dyes with low reduction potential, all these types of dyestuffs can be used without any sodium sulphide (in the pre-reduced liquid formulations a low amount of sodium sulphide is still present in the formulation). The following binary systems are in use (“DyStar, 2001”):

- combination of dithionite and glucose
- combination of hydroxyacetone and glucose (seldom)
- combination of formamidine sulphinic acid and glucose (seldom).

Glucose is added to sodium dithionite to prevent over-reduction. Looking at the first list of bullet points, the addition of glucose can be omitted when using stabilised sulphide-free dyestuff formulations (3rd bullet point). With the non-pre-reduced sulphur dyestuffs mentioned at the last bullet point, the reduction step can be carried out with glucose alone (“Clariant 2001”).

In the past, an additional concern associated with sulphur dyeing was raised by the use of sodium dichromate as oxidising agent (applied to reconvert the dye to the original oxidised

insoluble form, after adsorption into the fibre). Sodium dichromate has now been fully replaced by hydrogen peroxide, bromate, iodate and chlorite.

Hydrogen peroxide is the preferred oxidising agent. Bromate, iodate and chlorite are detected as AOX. Nevertheless, they are not organohalogen compounds and they are not likely to give rise to hazardous organohalogen products (only certain chlorite products that contain Cl₂ or use chlorine as activator are likely to give rise to hazardous AOX).

Main achieved environmental benefits

Main environmental benefit resulting from the application of sulphide-low or sulphide-free sulphur dyes in combination with sulphide-free reducing agents is that sulphide content in waste water is minimised.

In order to derive the maximum environmental and economic benefit from the proposed technique, it is of primary importance that only the strict amount of reducing agent needed to reduce the dyestuff should be consumed. Consumption of the reducing agent by the oxygen in the machine should therefore be avoided as much as possible. One effective technique to ensure this is to use nitrogen to remove oxygen from the liquor and the air in the machine [182, VITO, 2001].

Operational data

A typical recipe for cotton dyeing on a jet machine (liquor ratio 1:6 to 1:8; dyeing for 45 min at 95 °C) is given below [179, UBA, 2001] (with reference to “DyStar, 2001”):

- non-pre-reduced sulphur dye: 10 %
- wetting agent: 1 g/l
- caustic soda solution (38 Bé): 15 - 20 ml/l
- soda ash: 8 - 10 g/l
- salt: 20 g/l
- glucose: 10 - 12 g/l
- sodium dithionite: 8 - 10 g/l or hydroxyacetone: 4 - 5 g/l or formamidine sulphinic acid: 4 - 5 g/l.

Cross-media effects

When using sodium dithionite as reducing agent, the sulphite content in waste water has to be taken into account (see Section 2.7.8.1).

Applicability

The dyestuffs and reducing agents described in this section can be used in existing and new dyeing machines (exhaust dyeing as well as continuous techniques). Possible differences of shade compared to common sulphur dyeing should be taken into consideration [179, UBA, 2001].

Economics

Stabilised non-pre-reduced sulphide-free dyestuffs are more expensive than sulphur dyes. Detailed information is not available [179, UBA, 2001].

Driving force for implementation

Worker health & safety, odour nuisance and waste water problems related to the presence of sulphides.

Reference plants

Many plants in Europe and world-wide.

Reference literature

[179, UBA, 2001], [51, OSPAR, 1994] P071, [183, VITO, 2001].

4.6.7 Minimisation of dye liquor losses in pad dyeing techniques

Description

Main emission sources in pad dyeing processes arise from the discharge of the residual dyeing liquor in the pad, pumps and pipes at the end of each lot when a new colour is started (see Section 3.3.3.5.4 for further details about emission & consumption levels).

Reduction of these losses can be achieved by carrying out the impregnation step in a nip or by minimising the capacity of the dip trough (e.g. flex-shaft, U-shaft).

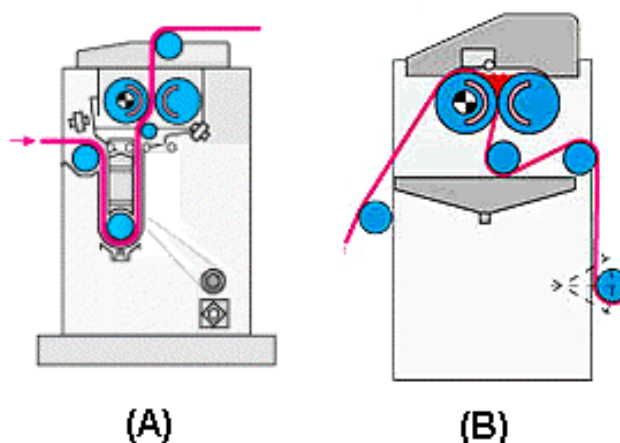


Figure 4.15: Representation of a U-shaft (A) and nip (B) dye liquor application systems

Further reduction of losses can be achieved by means of:

- systems for controlled dosage of the input raw materials. The dyestuff solution and auxiliaries are dosed, based on the specific recipe and are dispensed as separate streams, being mixed only immediately before being fed to the pad
- dosage of the padding liquor based on measurement of the pick-up. The amount of dyeing liquor consumed is measured by reference to the quantity of processed fabric by measuring the length of the fabric times its specific weight. The resulting values are automatically processed and used for the preparation of the next comparable batch in order to minimise residues of unused dyeing liquor. This system, however, cannot avoid the presence of residual dye liquor in the feeding tank. The rapid batch dyeing technique represents a further improvement in this respect. In this case, rather than prepared in one single step (for the whole batch) before starting the dyeing batch, the dyestuff solution is prepared just in time, in several steps, based on on-line measurement of the pick-up.

Main achieved environmental benefits

Conventional pad-bath troughs have a capacity ranging from 30 litres to up to 100 litres. Changing over to U-shaft troughs (12 litres capacity) will enable a reduction of the residues of unused liquor from 60 % to nearly 90 % per batch, compared to the conventional system. Correspondingly, in the case of nip dyeing (5 litres), up to 95 % reduction will be achieved.

Separate dispensing of chemicals and colourants avoids unnecessary wastage of raw materials that cannot be considered for further re-use, if already pre-mixed. The preparation of the dye liquor batch based on on-line measurement of the pick-up allows a reduction of the residual dye liquor in the feeding tanks from up to 150 litres down to 5 – 15 litres.

Furthermore, modern dyeing ranges are operated with minimised flow of rinsing water, which allows additional 25 % water savings.

Operational data

Routine maintenance is essential in order to ensure the precision and proper performance of the equipment. In particular, the precision of the dosage system (e.g. pumps) and pick-up measurement should be checked at regular intervals. In measuring the pick-up, the specific weight of the fabric has to be determined on the fabric before dyeing and not on the raw material before pretreatment.

Cross-media effects

None believed likely.

Applicability

The described techniques are recommended both for new and existing continuous and semi-continuous dyeing ranges. However, it is often more convenient to wait and install completely new machinery, where all the recommendations have already been taken into account, rather than upgrading parts of the existing machine [59, L. Bettens, 2000].

Dyeing in the nip is not suitable for light fabrics (below 220 g/m) or fabric with good wettability. With brushed or sheared textiles, the pick-up time may be too short and reproducibility is adversely affected [179, UBA, 2001].

Special attention has to be paid to knit and elastic fabrics.

Economics

Investment cost for an automated dosage system and a volume-minimised trough (e.g. U-shaft) is about 85000 euros (taking as a reference a width of 1800 mm). On the other hand, annual savings of 85000 euros are already achieved in the case of finishing mills performing 15 batches per day (assuming savings of 50 litres per batch at a cost of the dye liquor of 0.5 euros/l). This means a short payback time. [179, UBA, 2001]

Furthermore, the additional benefits achievable thanks to the reduced volume of waste water to be treated have to be taken into account.

Driving force for implementation

The restrictions set by environmental legislation (e.g. colour in the effluent) have certainly encouraged mills to apply measures aimed at reducing the emission of concentrated effluent. However, they are not to be regarded as the only driving force. The avoided wastage of expensive raw materials (colourants and auxiliaries) together with the increased reproducibility (right-first-time) and productivity achieved thanks to improved process control play an important role in the implementation of this technique.

Reference plants

In Europe and countries outside Europe, there are about 40 plants successfully operating the described technique. These plants are equipped with the on-line system for individual dosage of

dyestuffs/auxiliaries combined with pick-up measurement devices for preparation of the next comparable batch. The rapid batch dosing system for liquid dyes is successfully operating in at least one finishing mill in Europe.

The rapid batch dosing system is supplied by [179, UBA, 2001]:

- E. Kusters Maschinenfabrik GmbH & Co. KG, division textile, D-47805 Krefeld
- Kleinewefers Textilmaschinen GmbH, D-47803 Krefeld
- Seybert & Rahier GmbH & Co. Betriebs-KG, 34376 Immenhausen

Reference literature

[51, OSPAR, 1994] (P082), [179, UBA, 2001], [59, L. Bettens, 2000].

4.6.8 Enzymatic after-soaping in reactive dyeing

Description

Dyeing and printing with reactive dyes entails a number of soaping and rinsing steps to remove from the substrate the amount of unreacted and hydrolysed dye. The removal of all unfixed dyestuff from the fibre is essential for obtaining optimum wet fastness, while contributing significantly to energy, water and chemicals consumption of the overall dyeing process.

The suggested technique consists in adopting an enzymatic treatment to remove the non-fixed dyestuff not only from the fibre, but also from the exhausted dye bath. Enzymatic decolourisation of reactive dyestuffs has been proved with Levafix, Remazol, Cibacron, Procion and Synozol types [179, UBA, 2001].

The application of the enzymatic compounds usually takes place in the fourth or fifth rinsing step (see table below).

Typical sequence in the case of conventional after-soaping	Sequence in the case of enzymatic after-soaping
5 min overflow rinsing	5 min overflow rinsing
10 min 40°C	10 min 40°C; neutralisation
10 min 40°C; neutralisation	10 min 60°C
10 min 95°C	10 min 95°C
10 min 95°C	15 min 50°C; enzymatic treatment
10 min 50°C	10 min 30°C
10 min 30°C	-
Source: [179, UBA, 2001] with reference to "Bayer, 2000"	

Table 4.20: Comparison of the sequence steps between a conventional and an enzymatic after-soaping treatment (exhaust dyeing)

Main achieved environmental benefits

As Table 4.20 shows, one of the hot rinsing steps can be avoided when using enzymatic after-treatment. Savings in water, energy and detergent consumption are the main advantages achievable with this technique [179, UBA, 2001].

Operational data

The enzymatic treatment is carried out as follows (batch process) [179, UBA, 2001]:

- filling with fresh water (50°C)
- addition of a buffer for adjusting the pH
- control of pH (addition of acetic acid, if necessary)

- addition of the enzymatic compound (0.25 g/l)
- running: 10 min
- draining

Cross-media effects

None believed likely.

Applicability

The technique is already applicable to exhaust dyeing with reactive dyestuffs. Application to continuous dyeing and printing is currently under development.

Most of the reactive dyestuffs can be enzymatically decolourised. However, a precautionary test on laboratory scale is recommended.

Economics

Savings in water and energy consumption and reduced process time are among the economic benefits achievable.

No information has been made available about the cost of the enzymatic compounds.

Driving force for implementation

Cost-saving potential and improved quality (higher fastness) of the final product [179, UBA, 2001].

Reference plants

Enzymatic after-treatment is applied in Germany in several finishing mills and world-wide [179, UBA, 2001].

Reference literature

[179, UBA, 2001].

4.6.9 Silicate-free fixation method for cold pad batch dyeing

Description

Sodium silicate is often used in cold pad-batch dyeing, mainly to increase the pad liquor stability and to avoid selvaige carbonisation. On the other hand, sodium silicate gives rise to a number of problems such as the formation of silicate deposits on the textile surface and on the equipment, increased salt in the effluent, etc.

Silicate-free highly concentrated aqueous alkali solutions have been developed and are now available on the market. They are ready-made products (carefully adjusted mixture of alkali in aqueous solution), which can be easily applied with modern dosing systems. They are particularly suitable for the cold-pad-batch process.

Main achieved environmental benefits

The following advantages are achievable:

- no residues of alkali in the preparation tank because, unlike with sodium silicate, the alkali can be added as ready-made solution and does not need to be prepared
- no formation of difficult-to-wash-off deposits on the substrate and on the equipment
- no need for additional auxiliaries in the padding liquor to avoid the formation of deposits
- lower electrolyte content in the effluent
- possibility of using membrane techniques in waste water treatment (no crystallisation in filters, pipes and valves and no membrane blocking, which is the case with sodium silicate).

Operational data

Membrane pumps such as the sera-pumps with 4:1 ratio (alkali solution to dyestuffs solution) are suitable for the application of the product [179, UBA, 2001].

Figure 4.16 shows a typical dosing curve. Using a curve instead of the conventional alkali addition steps brings additional advantages in terms of increased reproducibility [179, UBA, 2001].

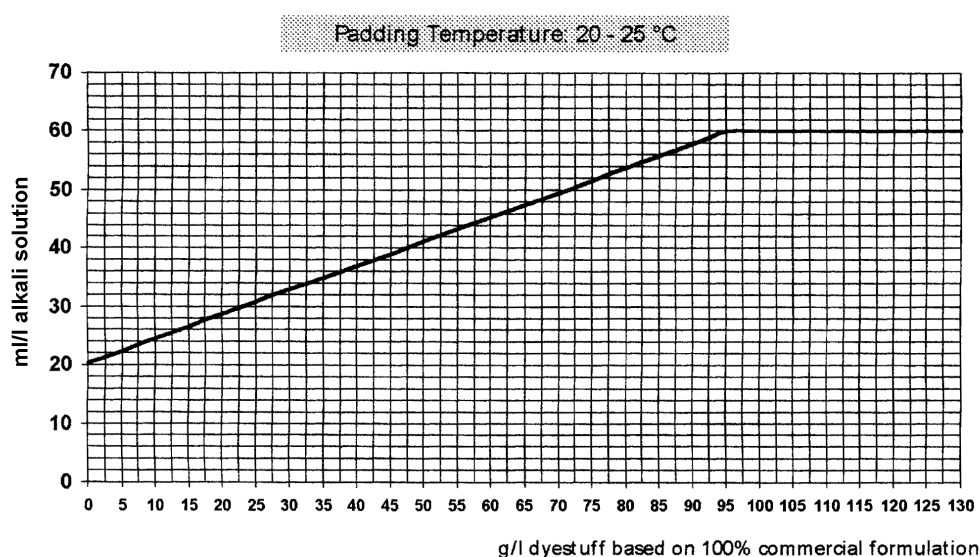


Figure 4.16: Dosing curve for ready-made alkali solution [179, UBA, 2001]

Cross-media effects

None believed likely.

Applicability

The technique is applicable to both existing and new installations. However, for existing installations additional measures for process optimisation and control may be needed in order to guarantee constant conditions [179, UBA, 2001].

Economics

The ready-made alkali solutions are more expensive than the conventional fixation methods.

The ready-made alkali solutions are designed for modern minimum-volume troughs, where pad liquor exchange time is very short and where extremely long pad liquor stability is not needed. Nevertheless, the absence of sodium silicate affects the stability of the pad liquor. More efficient

process control (e.g. temperature control of the dyeing liquor) is therefore required and the corresponding investment costs have to be taken into account.

The following economic benefits have to be considered [179, UBA, 2001]:

- investment in advanced dosing systems is lower because only two dosing units are needed (1 for the dyestuff solution and 1 for the ready-made alkali solution), while with the conventional fixation methods based on silicate, three dosing units are required (1 for the dyestuffs solution, 1 for the silicate and 1 for the alkali). Investment cost for 1 dosing unit is around 12000 euros
- no need to change the rubbers of the padder at short time intervals because of silicate deposit formation. The cost for removing the rubber of a padder is estimated at around 7000 - 10000 euros
- the lower electrolyte content of the liquor reduces the substantivity of the hydrolysed dyestuffs, which is therefore easier to wash off. This results in lower energy and water consumption in the washing-off step of the process
- higher productivity of the padders and washing ranges
- better reproducibility thanks to monitored process conditions.

In conclusion, reduction of total process costs is achieved, compared to the conventional fixation methods.

Driving force for implementation

Among the main driving forces it is worth highlighting [179, UBA, 2001]:

- better reproducibility
- reduction of total process costs
- easy handling of the product (possibility of having the alkali in liquid form and dosable in the required concentration without crystallisation problems)
- no deposits and better washing-off behaviour
- possibility of using membrane techniques for waste water treatment.

Reference plants

In Europe there are many finishing mills applying ready-made alkali solutions. Some example plants are Miroglio in Italy, T.I.L., F-Lyon in France, Riedel & Tietz Textil GmbH, D-09212 Limbach-Oberfrohna in Germany and Fussenegger, A-Dornbirn in Austria.

Reference literature

[179, UBA, 2001]

4.6.10 Exhaust dyeing of cellulosic fibres with high-fixation polyfunctional reactive dyestuffs

Description

One of the main objectives of research & development studies is the development of reactive dyes with the greatest possible degree of fixation (see also Sections 9.8 and 2.7.8.1 – “Dyes”). Bifunctional (polyfunctional) reactive dyes, containing two similar or dissimilar reactive systems, offer very high levels of fixation in exhaust dyeing. Because of their two reactive groups, bifunctional reactive dyes have increased probability of chemical reaction with cellulose fibres compared to monofunctional dyes with one reactive group. If one of the reactive groups hydrolyses during the dyeing process, the other one can still chemically react with the hydroxyl groups of cellulose. Moreover, combining two reactive systems in the same dye delivers the advantages of the two individual groups (e.g. high degree of fixation with high fastness levels

and wash-off). However, polyfunctional dyes are not necessarily better. Only the right combination of reactive groups makes them superior to conventional monoreactive dyes.

Examples of these high-fixation dye ranges are [179, UBA, 2001]:

- Cibacron FN (exhaust warm) (Ciba)
- Cibacron H (exhaust hot) (Ciba)
- Drimarene HF (Clariant)
- Levafix CA (Dystar)
- Procion H-EXL/ XL+ (Dystar)
- Sumifix HF (Sumitomo).

Figure 4.17 illustrates two examples. The first has two monofluoro triazine reactive groups bridging the chromophore; the second (reactive black 5) has two vinyl sulphone reactive groups. There are also reactive dyestuffs with two different reactive groups.

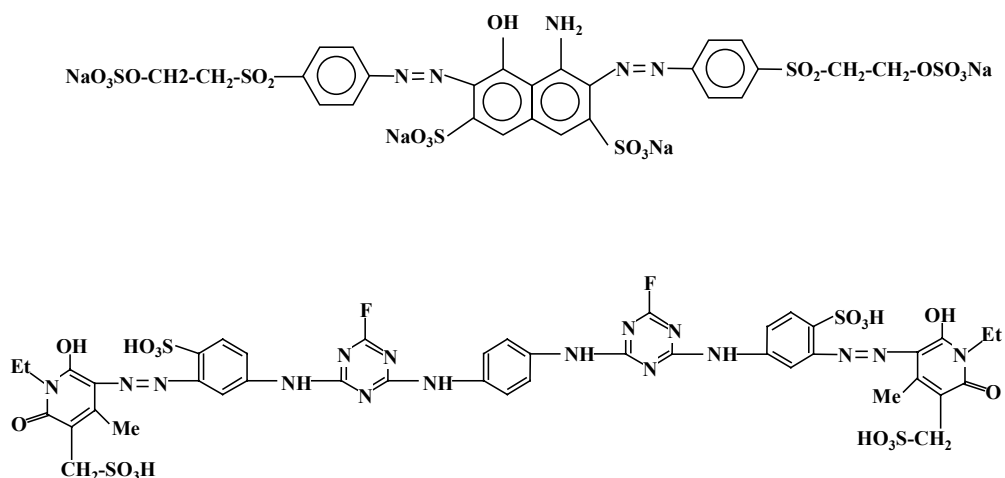


Figure 4.17: Two examples of polyfunctional dyestuffs
[179, UBA, 2001]

Main achieved environmental benefits

The fixation of a reactive dye with cellulose can be expressed either as a percentage of the total dye applied (fixation rate, sometimes also called “absolute fixation”) or as a percentage of the dye exhausted (exhaustion rate, sometimes also called fixation efficiency). In the case of monofunctional dyes, the fixation rate is approximately 60 % (with an exhaustion rate of about 70 %) so that 40 % of the dye applied is lost in the effluent. In the case of bifunctional reactive dyes, 80 % fixation rate and over 90 % exhaustion rate is achieved. The immediate consequence is a significant reduction of unused dyestuff ending in the waste water stream (reduced colour and organic load).

This is particularly advantageous when advanced oxidation techniques are applied to treat the dye in the effluent (see Section 4.10.7). It has to be noted, however, that a lower amount of dye in the effluent does not necessarily produce a reduction in visual colour. The tinctorial strength of new reactive dyes has significantly improved. This means that deeper and more intense shades are possible with less dye than necessary with other dyes or dye classes. Less dye is therefore left in the effluent, but visual colour may be still high [190, VITO, 2001].

With new dyes (and processes) there is also potential for water, energy and chemicals savings. For example, the recently introduced Levafix CA dyes (Dystar) reach more than 90 % fixation with moderate salt quantities.

Post-rinsing to obtain the required level of wet-fastness can be performed quickly and with relatively little energy and water. This is partly a consequence of the high fixation yield of the new bifunctional dyes (only a small amount of unfixed dye needs to be washed off). More important, however, is the fact that some new reactive dyes have molecules especially designed to show reduced affinity when they are in the hydrolysed form, which means that they have excellent wash-off properties.

A recent innovation from Dystar (Procion XL+ dyes) allows much shorter processing time on certain substrates by combining the pretreatment and dyeing steps using polyfunctional dyes that fix at 90 °C. Savings of up to 40 % in water and energy consumption and more than 30 % of salt are claimed.

Operational data

To facilitate selection and application, dye manufacturers introduced small dye ranges each comprising highly compatible dyes with virtually identical behaviour in the dye bath. Each of these compact ranges is geared to specific application segments. Also dyeing compatibility matrixes are provided. This is important in order to obtain high reproducibility, low dependency on dyeing conditions (e.g. liquor ratio, dyeing temperature, salt concentration) and therefore “right-first-time” dyeing.

Cross-media effects

None believed likely.

Applicability

High fixation reactive dyes can be applied in all types of dyeing machines, but offer particular advantage on the most modern low liquor ratio dyeing machines fitted with multi-task controllers where additional advantages in terms of reduced energy and water consumption can be exploited [179, UBA, 2001]. In particular, new reactive dyes with very good solubility can be applied at ultra-low liquor ratios [190, VITO, 2001].

Economics

Compared to conventional reactive dyes, polyfunctional reactive dyestuffs are more expensive per kilogram, but the higher fixation efficiency, the savings on salt usage and the reduced water and energy consumption lead to a significant reduction of total cost.

Driving force for implementation

The introduction of legislation restricting colour in the discharged effluent has been the main driving force for the development of high fixation dyes. Another important drive is the reduction of total processing costs achievable thanks to high dye fixation [179, UBA, 2001].

Reference plants

Many plants in Europe.

Reference literature

[179, UBA, 2001], [190, VITO, 2001], [180, Spain, 2001].

4.6.11 Exhaust dyeing with low-salt reactive dyes

Description

Traditionally, exhaust dyeing of cellulosic fibres with reactive dyestuffs required high amounts of salt to improve exhaustion (usually 50 - 60 g/l, but also up to 100 g/l for dark shades - see also Sections 2.7.3 and 2.7.8.1 – “Salt”). Several dye manufacturers have developed innovative dye ranges and application processes that only need about two-thirds of this quantity. Examples are:

- Cibacron LS (Ciba)
- Levafix OS (Dystar)
- Procion XL+ (Dystar)
- Sumifix HF (Sumitomo).

Most of these dyes are polyfunctional dyes and offer very high level of fixation, thus bringing the added benefit of a reduced amount of unfixed dye in the effluent.

Because of the reduced amount of salt needed for their exhaustion, low-salt dyes are more soluble and can be kept in solution at a higher concentration than necessary for low liquor ratio dyeing machines. This offers further possibilities for reducing the overall salt requirement, as illustrated in the following table.

	Winch (L.R. 1:20)	Jet (L.R. 1:10)	Low L.R. Jet (L.R. 1:5)
Traditional reactive dyes (salt 60 g/l)	1200 kg	600 kg	300 kg
Low salt reactive dyes (salt 40 g/l)	800 kg	400 kg	200 kg
Source: [179, UBA, 2001]			

Table 4.21: Quantities of salt required for dyeing 1000 kg of fabric to a medium depth of shade

Main achieved environmental benefits

Salt consumption for exhaust dyeing of cellulose fibres is reduced by about one-third of the quantity needed for conventional reactive dyestuffs, with positive effects on effluent salinity and smooth running of waste water treatment units [179, UBA, 2001].

Low-salt reactive dyes are high affinity dyes, which makes them less easy to wash off than low- or medium-affinity types. However, dyes with low affinity in the hydrolysed (unfixed) form are increasingly available, making post-rinsing operations much easier.

Operational data

The lower the salt concentration, the more sensitive the system becomes to any change in parameters that influence exhaustion. To give the dyer the high flexibility needed, dye manufacturers have developed trichromatic combination dyes with high mutual compatibility (by matching the affinity and reactivity of each dye and minimising interactions among components). Products with very similar application properties are now available, which makes them little affected by (or virtually insensitive to) changes in dyeing conditions. Right-first-time production is claimed (for example, with Cibacron LS) even when batch sizes and liquor ratio vary widely, as for example when dyeing blends such as polyester/cotton [190, VITO, 2001].

Individual manufacturers provide comprehensive technical information for their low salt dye ranges, including detailed salt recommendations according to depth of shade, type of substrate, equipment in use, etc.

The most impressive feature of advanced reactive dyes is the mutual compatibility of the dyes included in each dye range (matching the affinity and reactivity of each dye and minimising interactions among components). Thanks to sophisticated molecular engineering techniques it has been possible to design reactive dyes which have the optimum profile required to maximise the right-first-time production. They exhaust at very similar rates. Curves plotted for each dye colour by temperature and time can be laid over one another with practically no variation. This is important in order to obtain high reproducibility, low dependency on dyeing conditions (e.g. liquor ratio, dyeing temperature, salt concentration) and therefore “right-first-time” dyeing.

Cross-media effects

None believed likely.

Applicability

Low-salt reactive dyestuffs are applicable to both existing and new dyeing equipment, but offer particular advantage in the most modern low liquor ratio dyeing machines where additional advantages of reduced energy and water consumption can be exploited [179, UBA, 2001].

Economics

Low-salt reactive dyes are significantly more expensive than conventional reactive dyes (mainly because of the sophisticated molecular engineering techniques applied in their manufacture). However, depending on the special circumstances of each dyehouse, the application of low-salt dyes can be of economic benefit.

Driving force for implementation

Low-salt reactive dyes were introduced first in areas having arid climate conditions and negative water balance (e.g. North Carolina in the US and Tirupur, Tamil Nadu in India). They have also been successful in regions where dyehouses discharge directly to fresh water and there is a need to minimise salination effects.

Moreover, it should not be forgotten that corrosion caused by the presence of salt is the main cause of failure in water recycling.

Reference plants

Many plants in Europe.

Reference literature

[179, UBA, 2001], [190, VITO, 2001], [180, Spain, 2001], [61, L. Bettens, 1999].

4.6.12 Omitting the use of detergents in afterwashing of cotton dyed with reactive dyes

Description

Both international literature and practical experience in textile mills show that detergents do not improve removal of hydrolysed reactive dyestuffs from the fabric.

On the contrary, high temperatures do have an affect on rinsing effectiveness. Tests carried out with rinsing at 90 – 95 °C have shown that rinsing is more effective and faster at high temperatures. About 30 % more unfixed hydrolysed reactive dyestuff is rinsed out after 10 minutes of rinsing at 95 °C than at 75 °C.

Many dyehouses already carry out hot rinsing and omit the use of detergents in rinsing after reactive dyeing. The product quality is not negatively affected. On the contrary, most often the fastness of the goods are better after the hot rinsing than after the traditional rinsing with detergents, complexing agents and neutralisation in the first rinse.

Energy should be recovered when using large volumes of hot process water. Energy reclamation can be done either by heat exchange between the hot outgoing process water and the cold incoming clean water or by reclamation of the hot water and re-use of both energy and water.

Main achieved environmental benefits

The main benefit is the reduction in consumption of detergents and pollution load discharged to the waste water. Obviously, the potential for reduction will vary according to the existing dyeing procedure at the company.

The experience of two dyehouses (one mainly dyeing knitted fabrics and the other dyeing garments) shows that the average potential load reduction can be in the order of 1 kg detergent, 1 kg complexing agent and 1 kg acetic acid per 100 kg of textile.

Additional advantages are the savings achievable in the amount of chemicals consumed to destroy reactive dyes by free radical treatment processes. In the Fenton reaction for example since the OH* radicals react very fast not only with the dyestuffs but also with many detergents, a large amount of expensive H₂O₂ can be saved by omitting the use of detergents.

Operational data

The high degree of fixation and the excellent wash-off properties typical of some new low-salt, polyfunctional reactive dyes (see Sections 4.6.10 and 4.6.11) are important factors that help obtain sufficient wash fastness with hot rinsing without the need for detergents.

It has been reported that difficulties might arise with accidental stops of the machinery. In such conditions the high temperature of the rinsing water could cause irreversible cleavage of the bond between the reactive groups of the dye and the hydroxyl groups of cotton or viscose [297, Germany, 2002].

Cross-media effects

Substituting cold rinsing with hot rinsing leads to higher energy consumption, unless thermal energy from the rinsing effluent is recovered.

Applicability

A Danish textile mill has during the last 5 years totally omitted the use of detergents in the rinsing process after reactive dyeing. The company treats knitted and woven goods made of cotton or cotton/PES and dyes them in all colours and shades. The application of this technique may involve a change in the type of dyes employed. The referenced company works with bifunctional reactive dyes as Cibachron C or Bezaktiv S. Soft water is used.

Another textile mill dyeing garments of knitted and woven fabric has not used detergents during the last 5 – 6 years, apart from a few exceptions (i.e. red, dark red or bordeaux colours).

Economics

The only change in operating procedures is to omit the addition of detergents. Savings will depend on the number of reactive dyeings carried out at the company.

Driving force for implementation

High costs for chemicals and waste water treatment.

Reference plants

Many plants in Europe. In particular, a few examples of plants applying this technique in Denmark are: Kemotextil A/S, Sunesens Textilforædling ApS, Martensen A/S.

Reference literature

[78, Danish EPA, 1999], [7, UBA, 1994],

“Environmentally friendly method in reactive dyeing of cotton”. Water Science and Technology Vol. 33, No.6, pp.17-27, 1996”

“Reclamation and re-use of process water from reactive dyeing of cotton”. Desalination 106 (1996) 195-20”

4.6.13 Alternative process for continuous (and semicontinuous) dyeing of cellulosic fabric with reactive dyes

Description

The technique referenced is a continuous dyeing process for cellulose fibres that uses selected reactive dyestuffs. Unlike the conventional pad/continuous dyeing systems, it requires no additional substances such as urea, sodium silicate and salt, or long dwell time to fix the dyes. The recipe includes: x g/l dye 1, y g/l dye 2, z g/l dye 3, 1 - 2 g/l wetting agent and alkali. The other auxiliaries normally used in a conventional process are replaced here by operating with controlled steam content during drying.

The dye liquor is applied to the textile using a padder (cotton is squeezed to about 70 % pick-up and viscose to about 80 %) and, after a short passage through air, the fabric is fed directly to the dryer (hot-flue), where it remains for 2 minutes.

In the conventional process, urea is used as solvent for the dye in dry heat. Urea melts at 115 °C and binds water above 100 °C, thus allowing penetration of the dyestuff in the fabric during fixation in the steamer. With the referenced process, this is not needed because the conditions in the dryer are set (120 °C and 25 vol.- % steam content) so that the fabric remains at a specific temperature of 68 °C as long as it is damp.

Since highly reactive dyes are used, only a low fabric temperature (68°C), a weak alkali and a short time (2 minutes) are needed for fixation.

Main achieved environmental benefits

Significant reduction in chemicals consumption is possible as shown in Figure 4.18.

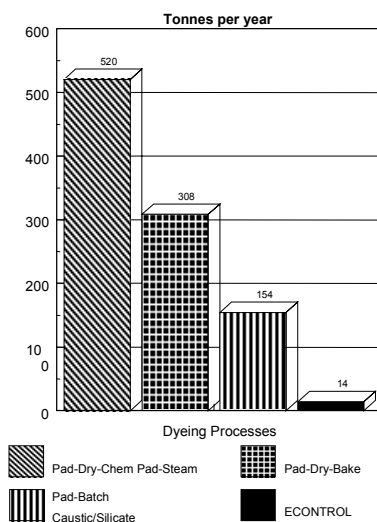


Figure 4.18: Basic chemicals consumption per 10 million metres with pad-dry-pad-steam, pad-batch, pad-dry-thermofix and the reference technique [180, Spain, 2001]

No urea, salt (chloride/sulphate), or sodium silicate is consumed and the alkalinity is often lower (less NaOH, due to substitution with Na_2CO_3 depending on the selected dyes).

One company operating a three-shift system for dyeing continuously by the pad-dry-thermofix process or the pad-dry-pad-steam process, at a rate of 40 m/min, would consume approximately 423 t/yr of urea or 540 t/yr of NaCl. On the other hand, a company operating the referenced technique on a three-shift basis would consume only 22 t/yr of sodium bicarbonate, which ends up in the effluent. In conclusion, the waste water from washing contains only 4 – 5 % of the chemical load produced by other dyeing processes carried out in accordance with the latest technology [190, VITO, 2001].

The elimination of urea, in particular, results in a lower amount of nitrogen-containing compounds in the waste water and avoids the presence of urea break-down products in the exhaust air, typically found in pad-thermofix processes.

The absence of salt is advantageous not only because it results in a lower salt load in the final effluent, but also because without salt the unfixed dye is easier to wash off (less water and energy consumption in post-rinsing operations). In addition, dyes that have low substantivity in the hydrolysed form are now employed, which show very good washing-off properties.

In addition, energy consumption is minimised through control of the exhaust air.

Operational data

The temperature and humidity profile during the fixation process is illustrated in the figure below.

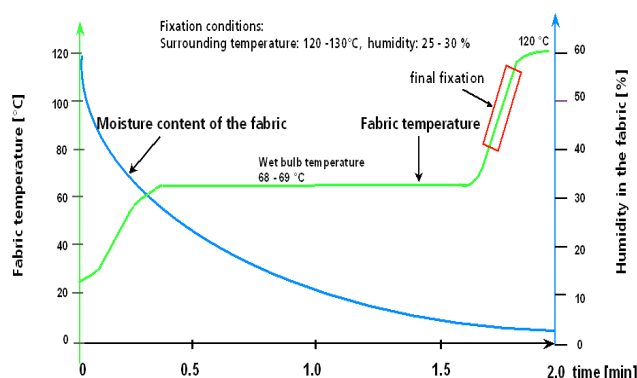


Figure 4.19: Fabric temperature and humidity during the dyeing process using the referenced technique [180, Spain, 2001]

A dampening unit is used during start-up of the machine in order to ensure that ambient conditions in the chamber of the dryer are set at 25 vol.-%.

Sometimes, the amount of water given off from very lightweight fabrics is not enough to keep the chamber at 25 vol.-%. In this case, the steam injector is used to spray-in the required amount of steam.

It has to be stressed that maximum performance is obtained only with the right choice of fabric pretreatment and well-engineered selected dye formulations.

Cross-media effects

None believed likely.

Applicability

The process itself is simple and ideal for both small and large batches. It is an economically viable option for dyehouses that are reinvesting.

In addition to high versatility and applicability to a wide variety of fabrics, a number of benefits are achieved in terms of fabric quality compared with other dyeing techniques. These include for example [180, Spain, 2001]:

- soft handle due to mild fixing conditions
- migration minimised by rapid fixation and humidity control (especially important on pile fabrics, where rub fastness is improved due to less dye migration to the tips)
- improved penetration of difficult fabrics (compared to pad-thermofix) due to presence of humidity at high fabric temperature
- improved coverage of dead cotton compared to pad-batch or exhaust dyeing
- dyeing PES/viscose and PES/cotton blends in a single bath with excellent results.

Economics

No IR pre-dyer is needed, unless heavy fabric is being dyed. Nevertheless, the initial investment cost for new hot-flue is around 0.75 million euros, excluding the cost of an automatic dye kitchen [190, VITO, 2001]. This investment cost, however, is compensated by huge savings in chemicals/auxiliaries, energy, flexibility, higher productivity and environmental improvement (less emissions to air or waste water pollution to treat).

The lower chemicals/auxiliaries costs arise from the avoidance of sodium silicate, sodium chloride and urea in the dyeing recipe. In many cases, the dye consumption is also reduced compared with the other processes such as pad-batch. This is illustrated in the example reported in the table below.

	Pad-batch/sodium silicate method	Referenced technique	Difference %
Levafix Yellow CA	15.0 g/l	13.7 g/l	-8.7
Levafix Red CA	12.0 g/l	11.6 g/l	-3.3
Levafix Navy CA	10.4 g/l	10.1 g/l	-2.9
Total dye	37.4 g/l	35.4 g/l	-5.3
Urea	100 g/l	-	-100
Wetting agent	2 g/l	2 g/l	0
Sodium silicate 38°Bè	50 ml/l	-	-100
Caustic soda 50 % ⁽¹⁾	14 ml/l	6 ml/l	-57
Sodium carbonate ⁽¹⁾	-	10 g/l	+100
Total chemicals	166 g/l	18 g/l	-89
Dwell time	12 hours	2 minutes	
Source: [180, Spain, 2001]			
Notes:			
⁽¹⁾ Differences in operation (depending on the selected dyes) may allow full substitution of caustic soda and sodium carbonate with sodium bicarbonate (lower alkalinity)			

Table 4.22: Comparison between a conventional pad-batch process and the referenced technique applied to mercerised 100 % cotton twill, 300 g/m, 75 % pick-up

The increased productivity obtained by the elimination of long batching times, produces significant savings over the traditional pad-batch process. Despite the much lower machinery cost for pad-batch equipment, this alternative process has shown to be more cost effective in terms of total processing costs. Moreover, the demand for rapid response by the industry can be met more easily. Not having to wait until the next day to view shades means a much improved service and a faster delivery to the customer.

Driving force for implementation

Minimised consumption, sustainable clean technology, market share.

Reference plants

The referenced technique is available commercially under the name of Econtrol®, which is a registered trademark of DyStar.

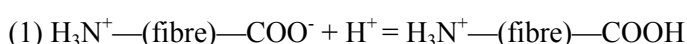
Plants in Spain, Belgium (UCO-Sportswear), Italy, Portugal, China, Turkey, India, Pakistan and Korea are operating with the Econtrol® process.

4.6.14 pH-controlled dyeing techniques

Description

Fibres such as wool, polyamide and silk contain weak acid and weak base groups (e.g. carboxylic and amino functions). Just like the parent amino acids from which all proteins are derived, these fibres show zwitterionic characteristics at pH values close to the isoelectric point (i.e. the pH at which the fibre contains equal numbers of protonated basic and ionised acidic groups).

At a pH below the iso-electric point, the carboxylate anions are progressively neutralised by the adsorption of protons and the fibre acquires a net positive charge (see equation 1):



Conversely, as the pH rises above the isoelectric point, the fibre becomes negatively charged as a result of the dissociation of the carboxylic acid groups (equation 2) and deprotonation of the amino groups by adsorption of hydroxide ions or other anions as shown below in equation 3:



Based on these reactions, fibres with zwitterionic characteristics can be dyed by imposing a pH profile at iso-temperature, instead of a temperature profile at iso-pH.

The dyeing process is started in alkaline conditions, above the isoelectric point. At this pH, the carboxylic groups become dissociated and the anionic charged groups repulse anionic dyes. This makes it possible to control the adsorption of the dye on the fibre by gradually decreasing the pH.

At a low enough pH when the number of cationic charges on the fibre increases, the dye becomes attracted to the fibre via coulombic interactions, which provides additional bonding forces that cannot be broken by thermal agitation.

At iso-pH, part of the carboxylic groups are neutralised and at higher temperatures, the dye can move rapidly and with minimal energy through the fibre.

The main difference between temperature- and pH-controlled dyeing is that in the temperature-controlled dyeing the process is controlled by the dye bath exhaustion and thermal migration of the dye, whereas with a pH-controlled profile the dyeing process is controlled by the adsorption of the dye onto the ionic fibre.

The pH profile can be controlled during the dyeing process either by dosing a strong acid or base or by creating a buffer system during the dyeing process (mixture of a weak acid and their conjugates base or vice versa). Two methods are normally used to generate a buffer system. One method is to dose a weak acid (e.g. acetic acid) starting from an alkaline bath containing a strong base (or a strong acid starting from a weak base); another method consists in using acid- or base-donors for pH-sliding (ammonium sulphate and hydrolysable organic esters are examples of acid donors).

Main achieved environmental benefits

One of the advantages of iso-thermal dyeing is that the use of special organic levelling agents or retarders (typically added to the dye bath to allow even dyeing) can be avoided.

Time and energy use with pH-controlled dyeing is lower than with the temperature-controlled process. Energy is saved because the dye bath (and the machine) do not need to be heated from room temperature up to the migration temperature (above the optimum dyeing temperature). Time is saved because the heating and cooling phases are shorter and no extra time is required for the migration process.

Moreover, this technique offers new opportunities for recycling and recovery of spent dye baths. With a pH-controlled system, the hot spent bath can be recycled as such for the next batch, instead of being cooled down before re-use. This is not possible in a temperature-controlled dyeing system because in that case the dyeing cycle cannot be started at the so called “treatment temperature”, but must be started at a lower temperature (e.g. 50°C) in order to prevent uneven dyeing.

Operational data

As stated earlier, pH steering during batch dyeing can be performed by fitting the machine with dosing systems for acids and alkalis. This is the best and most effective method because it minimises the amount of chemicals consumed to shift the pH. However, precise control of the pH profile with this method is difficult as the pH must be measured continuously and the bath must be fully homogenised. This technique is therefore limited to machines where the goods and liquor are well mixed, such as jets and modern carpet winches. Moreover, if a mineral acid (e.g. sulphuric acid) and an alkali are used, the salt content of the dye bath may increase above acceptable levels when recycling water.

Instead of using pH-measuring instrumentation another technique is the generation of a pH-buffer during the dyeing process. In this case, there is no need to measure the pH in a fully contained system. In fact, pH-chemistry and dynamic mass-balancing can predict pH and more importantly, can create a consistent repeatable pH profile [171, GuT, 2001]. For these reasons this technique, although more expensive (higher consumption of chemicals) and more polluting (higher organic load in the effluent), tends to be preferred by companies in the sector.

The use of decarbonated water is the best way to ensure optimal pH control, especially when weak acid donors are used (when process water is not decarbonated the acid will be consumed in the formation of CO₂ rather than for shifting the pH of the bath).

Cross-media effects

The application of the proposed technique doesn't give rise to significant cross-media effects. However, the thermal splitting of ammonium sulphate releases ammonia to the atmosphere.

Applicability

The pH-controlled process is applicable to fibres with zwitterionic behaviour such as wool, polyamide, silk, etc. The technique is commonly applied in uni-dyeing processes, whereas it presents some limitations when blends of fibres are dyed to obtain differential shades (differential dyeing). Here, if the two (or more) fibre-types do not have compatible pH-exhaustion/adsorption profiles, dyeing at iso-pH may be preferable.

The pH-controlled dyeing process is less common for fibres with only basic or only acidic functional groups. Nevertheless it is also advantageous for dyeing acrylic fibres with basic dyes and in principle it can be used for all types of fibres with "neutral pH-dyeable" reactive dyes.

The referenced technique is generally considered the most valuable technique in batchwise and continuous carpet dyeing and may set an example for other textile products [59, L. Bettens, 2000].

Economics

The bath does not need to be warmed up and cooled down according to a preset temperature profile. The resulting saving in processing time is therefore one major economic advantage of this technique.

Additional benefits in terms of time and energy savings can be achieved when the hot spent dye bath is recycled because the dye liquor can then be re-used for the next dyeing cycle without the need to cool it down and warm it up again.

Investment costs, although fairly acceptable, are associated with fitting the dyeing machine with dosing and pH-control units.

No investment cost is required when the pH control takes place via buffer systems or acid/alkali donors.

Driving forces for implementation

Time and energy savings are the main driving forces for the implementation of this technique. Moreover, the technique overcomes the limited potential for dye bath recycling often found with temperature-controlled dyeing processes.

Reference plants

The technique has been applied by many dyehouses (especially in the carpet sector) since the early seventies.

Reference literature

[171, GuT, 2001], [59, L. Bettens, 2000]

4.6.15 Low-chrome and ultra-low-chrome afterchroming methods for wool

Description

Chrome dyeing of wool is still an extremely important process to obtain deep full shades at an economical price and with excellent fastness properties.

In 1995, the world market for wool dyestuffs was about 24000 t, with a higher percentage in Asia, especially China and Japan, than in Europe. Chrome dyes represent about 30 % of the global market. They are used for dark shades specifically, 50 – 60 % for black shades, 25 - 30 % for navy and the remaining 10 – 25 % for specific colours, such as brown, bordeaux or green [179, UBA, 2001].

The afterchrome method (see also Sections 2.7.4 and 9.6) is now the most widely adopted technique for the application of chrome dyes, and chromium (as sodium or potassium dichromate) is the metal used almost universally as mordant. In the application of chrome dyes, inefficient chroming methods can lead to the discharge of chromium in spent dye liquors (see also Section 2.7.8.1 “oxidising agents”). In order to minimise the amount of residual chromium in the final effluent much attention has recently been given to the low-chrome (stoichiometric) and ultra-low (substoichiometric) chrome dyeing techniques, where only the minimum amount of dichromate required to form the dye complex in the fibre is dosed.

During the last 10 - 15 years, so-called *low-chrome* dyeing technology has been increasingly used. The method consists in stoichiometric dosage of chrome (up to a maximum of 1.5 % o.w.f.) together with careful pH control (3.5 - 3.8) and optional addition of a reducing agent, which assists in the conversion of CrVI to CrIII and promotes its exhaustion onto the fibre [191, VITO, 2001].

Every major chrome dye manufacturer has published data relating to chrome additions and dyeing techniques which are widely adopted (e.g. Bayer, Ciba-Geigy, Sandoz).

By the use of low-chrome techniques it is possible to reduce residual CrIII in the spent chroming bath from about 200 mg/l (typical of conventional process) to about 5 mg/l in practical mill conditions. Residual CrVI is almost eliminated. In the laboratory, lower residual CrIII concentrations (about 1 mg/l) can be achieved but, although such results are reported in the literature, they are not regularly achievable in practice [191, VITO, 2001].

Ultra-low chroming techniques are applied to achieve even lower residual chromium levels or in particular cases (e.g. wool that has to be dyed in deep shades) when low-chroming techniques cannot guarantee residual chromium levels below 5 mg/l in the spent chroming bath. Chrome is dosed substoichiometrically, based on the dye uptake of the fibre.

With ultra-low chroming techniques additional measures are applied, compared to the low-chrome process, in order to ensure maximum exhaustion of the dye bath. If the dye bath exhaustion is incomplete before chroming, the residual dye in the liquor will be chromed and remain in the liquor, adding to the discharged chromium. By ensuring maximum dye exhaustion, contamination from this source can be reduced and this will also give maximum fastness performance. Dye bath exhaustion can be improved by ensuring that the dye bath pH is sufficiently low or, as Bayer have shown, by allowing the dye bath to cool to 90 - 80 °C at the end of the dyeing stage. Optimum results will be obtained by draining the dye liquor and setting a fresh bath for chroming [191, VITO, 2001].

Main achieved environmental benefits

Methods using exactly calculated quantities of dichromate and special process conditions result in minimisation of chromium in the waste water.

An emission factor of 50 mg chromium per kg of wool treated is achieved, which corresponds to a chromium concentration of 5 mg/l in the spent chroming bath when a 1:10 liquor ratio is used [191, VITO, 2001].

Operational data

In order to ensure accurate dosing and minimum handling of hazardous chemicals by the operator, the application of the low-chroming/(ultra-low chroming) techniques requires the use of automated dosing and dispensing system for dichromate, dyes and pH-control. The required amount of dichromate is fed directly to the dyeing machine through pipework (no manual transfer, no human contact, no losses). The system is fitted with control devices for the volumetric control of the delivered quantities, which switch the entire system into emergency mode if normal operating parameters are breached [161, Comm., 2001].

In addition, special safety precautions are recommended for the storage of dichromate. The containers for the solution of sodium dichromate must be stored within isolated bunded areas in order to contain potential spillage and avoid interaction with other chemicals (in case of spillage).

For maximum chroming efficiency, it is essential to eliminate from the chroming bath any chemicals that will inhibit the chromium/dye interaction. Two main classes of chemicals can have this effect. The first class includes all chemicals that can form soluble complexes with chromium, thereby holding the metal in solution in the bath and adding to the effluent load. Examples of such products are sequestering agents and polycarboxylic acids, such as citric acid. The second class of compounds are those that inhibit the exhaustion of the dichromate anion; the most common example is the sulphate anion. The use of sodium sulphate and sulphuric acid should therefore be avoided, except in the manner indicated in the specific Bayer method [191, VITO, 2001].

Note that, even without added reducing agent, reducing species released from the wool into the dye bath will convert CrVI almost quantitatively to CrIII. An exception is represented, for example, by wool that has been submitted to oxidising shrink-resist treatments, because in this case wool molecules will already be oxidised and the reduction potential will be lower.

Cross-media effects

Taking the conventional method as a reference, there are no cross-media effects to be mentioned.

It has to be taken into account that even when: 1) special application methods are employed, which involve reduction of Cr(VI) to Cr(III); 2) the chrome is encouraged to complex with the

carboxyl groups within the fibre; 3) a further effluent dilution from rinsing is incorporated, it is still a huge challenge to reduce the chromium level in the total chrome dyeing effluent (spent dye bath + rinsing water) from over 300 mg/l to just 1 mg/l. It is for this reason that the future of afterchrome dyestuffs has been questioned [188, VITO, 2001].

If a fresh bath is set for chroming, as required with the ultra-low chroming technique, the additional water consumption has to be taken into account [280, Germany, 2002].

Applicability

Low-chroming methods are cheap and easy to apply and are already widely used.

The optimised levels of dichromate additions give complete and level chroming of the dye, under specified chroming conditions. This minimises oxidation and cross-linking of the fibre, and therefore also reduces fibre damage.

However, it has to be taken into account that too low amounts of dichromate may adversely affect the required reproducibilities of shades [280, Germany, 2002].

Economics

It is commonly accepted that in the long term, the introduction of automated dosing/dispensing systems brings about savings in chemicals thanks to improved dosing accuracy, but no quantitative data were made available to this respect [161, Comm., 2001].

The addition of reducing agents increases costs because of the longer dyeing cycles and the resulting reduced productivity [161, Comm., 2001]. The same is valid for the setting of a fresh bath for the chroming step, as required by the ultra-low chroming techniques [280, Germany, 2002].

Driving force for implementation

Pressure and safety requirements set by the legislation are probably the main driving forces for the application of this technique. It should be noted, however, that many initiatives discourage the use of chrome mordant dyes (OSPAR, GuT, EU-Ecolabel, etc.). Chromium-free dyeing is therefore becoming more and more attractive for companies that are not obliged to use chromium dyes.

Reference plants

Many plants in Europe.

Reference literature

[51, OSPAR, 1994] P091, [161, Comm., 2001], [188, VITO, 2001], [179, UBA, 2001], [191, VITO, 2001].

4.6.16 Chromium-free dyeing of wool

Description

Concerns associated with the use of sodium (or potassium) dichromate as mordant in wool dyeing with chrome dyes are already discussed in Section 2.7.8.1 (“oxidising agents”). Low-chrome dyeing techniques (see Section 4.6.15) allow a considerable improvement in the efficiency of this process, but they cannot avoid the presence of free chromium in the water effluent and in the sludge.

Furthermore, many initiatives discourage the use of chrome mordant dyes (e.g. OSPAR, GuT, EU-Ecolabel).

Until recently the use of chrome dyes was considered unavoidable for certain types of wool articles, in particular for dark shades, due to the excellent wet fastness of these dyes. Quite recently, new reactive dyestuffs have been put on the market that can provide levels of fastness comparable with those achievable with chrome dyes, even for dark shades.

These new colourants are bifunctional reactive dyestuffs generally containing bromo-acrylamide or vinylsulphone reactive groups. The structure of a typical bifunctional reactive dyestuff of the bromo-acrylamide type is shown in Figure 4.20. The dye range is based on a trichromatic system, where Yellow CE (or Golden Yellow CE), Red CE and Blue CE can be used as the basis for the coloured shade area, and Navy CE and Black CE as the basis for highly fast navies and blacks.

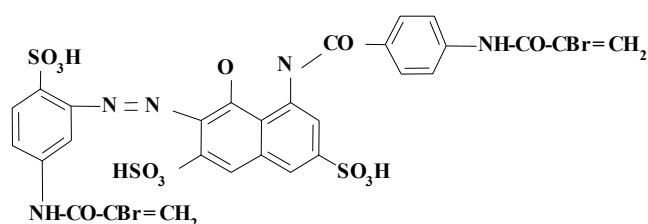


Figure 4.20: Structure of a typical bifunctional reactive dyestuff for wool of the bromo-acrylamide type

Six different reactive colours available on the market and the related auxiliaries are shown in the next two tables, together with available details on composition and ecological features.

Trade name	Chemical characterisation (all dyestuff products are powder formulations)	Danger symbol	Biodegradation/bioelimination (%), testing method	spec. COD (mg O ₂ /g)	spec. BOD ₅ (mg O ₂ /g)	Heavy metals (mg/g)	Organo-halogens (mg/g)	Nitrogen (mg/g)
Lanasol Yellow CE	mixture of azo dyestuffs	Xn	40 - 50, OECD 303A	790	55		65	39
Lanasol Golden Yellow CE	azo dyestuff	Xi	<10, OECD 302B	909	0		<1	ca. 10
Lanasol Red CE	mixture of azo dyestuffs	Xi	<10, OECD 302B	700	0		<1	56
Lanasol Blue CE	mixture of azo & anthraquinone dyestuffs (contains reactive black 5)	Xn	40 - 50, OECD 303A	928	329		<1	36
Lanasol Navy CE	mixture of azo dyestuffs (contains reactive black 5)	Xn	20 - 30, OECD 302B	1032	57		<1	64
Lanasol Black CE	mixture of azo dyestuffs (contains reactive black 5)	Xn	20 - 30, OECD 303A	ca. 800	0			96

Source: [179, UBA, 2001]

Table 4.23: Composition and ecological information of six commercial reactive dyestuffs for wool

Trade name	Chemical characterisation	Danger symbol	Biodegrad./ bioelimination (%), testing method	spec. COD (mg O ₂ /g)	spec. BOD ₅ (mg O ₂ /g)	Heavy metals (mg/g)	Organo-halogens (mg/g)	Nitrogen (mg/g)
Cibaflow CIR	anionic de-aerating agent containing alkylpolyalkylene-glycoethers and esters	Xi	80 - 90, OECD 302B	410	135			
Albegal B	amphoteric hydroxyethylated fatty acid amine derivative	Xi	60 - 70, OECD 302B	1025	0			33

Source: [179, UBA, 2001]

Table 4.24: Composition and ecological information of two auxiliaries to be applied with “Lanasol Dyes”

It has to be noted that the formulated product also contains a variable amount of auxiliaries (e.g. anti-dusting agents) that are completely discharged with the exhausted liquor.

Thanks to the high fixation rate now achieved, the released dye only accounts for a minor amount of the total COD from dyeing, whereas the real contribution comes from the other constituents of the dye formulation and from the auxiliaries used in the process (e.g. levelling agents).

The general features of these new reactive dyes, in comparison with chrome dyes, are reported in the following table.

	Chrome dyestuffs	Reactive dyestuffs
Fixation mechanism	small acid dye molecule, which is complexed with chromium	covalent chemical bond
Dye fixation rate	<ul style="list-style-type: none"> ▪ traditional chrome dyes: 83 % ⁽¹⁾ ▪ optimised chrome dyes: <99 % ⁽¹⁾ 	optimised reactive dyes: <95 % ⁽¹⁾
Formulation	only one chromophore to yield black colour	dye combination necessary to yield black colour
Levelling properties	good levelling properties	levelling properties depend on dyeing auxiliaries and combination reagents (levelling is difficult without assistance of auxiliaries)
Fastness properties	high standards of fastness	Fastness performance comparable with chrome dyes
Reproducibility	shade matching difficult	very good
Dyeing process	two-step dyeing process (dyeing and chroming)	one-step dyeing process (but for dark shades an after-treatment is required)

Source: [179, UBA, 2001], [191, VITO, 2001]
Notes:
(1) non fixed dye: metal complex dyes: 3 – 7 % (“Entec” and “Ciba”); 1:2 metal complex dyes: 2 – 5 % (“Ciba”); chrome dyes: 1 – 2 % (“Entec”); reactive dyes: 7 – 20 % (“Entec”), 5 – 15 % (“Ciba”)

Table 4.25: Comparative analysis of the features of chrome dyes and reactive dyes for wool dyeing

Main achieved environmental benefits

By changing over to reactive dyestuffs, the handling of hexavalent chromium, which requires special safety precautions, due to its chronic toxicity and carcinogenic effects, can be avoided.

As concerns waste water, the presence of chromium, not only in the chelated form, but more importantly as free metal, is avoided. In this respect, it has to be taken into account that dyehouses that accept dyeing without chrome dyes may still use the metal complex dyes. Nevertheless, in metal-complex dyes the metal is present in the chelated form, which brings about less risk than the same amount of chromium released from afterchroming (see Section 2.7.8.1 – “Heavy metals emissions”).

Operational data

Dyeing cycles are reported to be longer when dyeing with reactive dyes, due to rinsing and clearing (approximately one hour more than a standard cycle of 2h30 with chrome dyes) [163, Comm., 2001]. However, this technique is improving very rapidly and industrial experience shows that in most cases it is possible to dye at 105 °C and carry out the afterclearing process in the dye bath, without lowering the wet fastness (see the dyeing curve in Figure 4.21) [280, Germany, 2002]. As a result, water and energy consumption can be reduced.

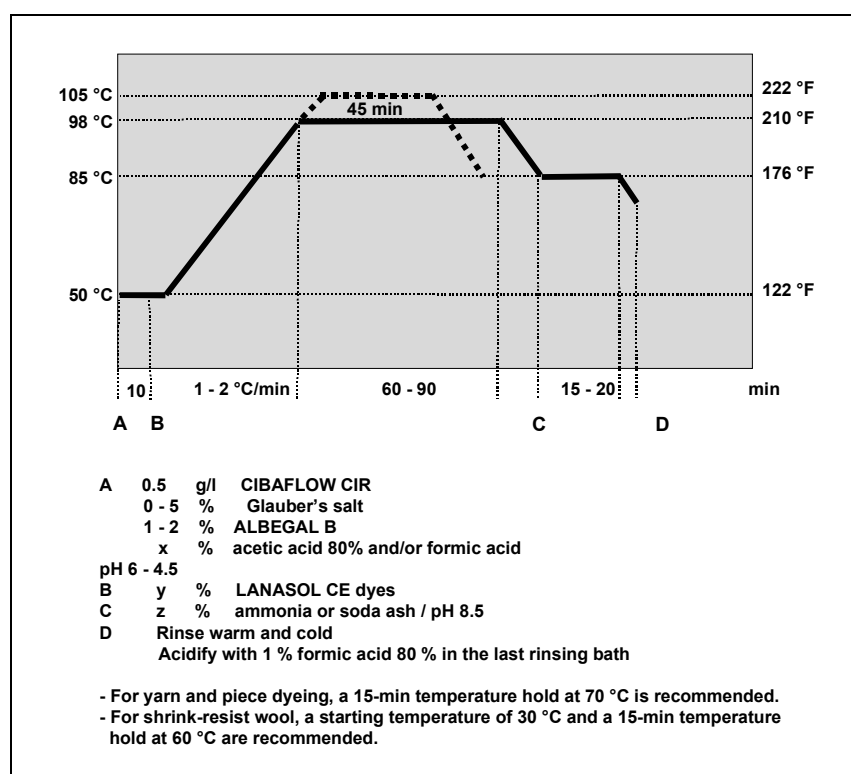


Figure 4.21: Dyeing curve for the application of reactive dyestuffs for wool exhaust dyeing

Cross-media effects

Attention should be paid to colour, AOX and organic load from non-biodegradable levelling agents.

Reactive dyestuffs produce more highly coloured effluents than chrome dyes. This is attributable to the higher colour strength typical of these colourants. In quantitative terms, however, for the same level of colour the amount of dyestuff discharged may be comparable or even less than traditional dyes [61, L. Bettens, 1999]. EU research shows that effective and economic viable routes (Enhanced Thermal Fenton ETF & Enhanced Photo Fenton reaction EPF) are available for destruction of the residual dyestuff [191, VITO, 2001].

For an objective assessment of the organic load produced by the dyeing process, the composition of the dye and the COD-values of the other constituents of the dye formulation, along with the auxiliaries used in the process, should be considered. The dyestuff itself, thanks

to its relatively high fixation rate, makes only a minor contribution to the organic load in the final effluent. On the other hand, the organic load produced by the levelling agents added to the dye liquor is significant in the overall balance. These are fatty amine ethoxylates, which are hardly biodegradable and only 60 – 70 % bioeliminable. Since these compounds have affinity for the wool, it is estimated that 50 % of the amount applied will remain on the fibre, while the remaining 50 % will end up in the waste water or in the sludge (that is, transferred to other media). Nevertheless, at a minimum application level of 1 % o.w.f. (10 g/kg fibre), 1.5 g/kg of CD from the levelling agent would still be released into the waste water (10g/kg x 0.5 x 0.3 x 1025 mg COD/g), unless free-radical destruction methods are applied.

Dyeing with pH-controlled profile (starting in acid conditions when reduced reaction occurs and shifting to alkaline pH as soon as the boiling temperature is reached) would allow optimum dye exhaustion with lower environmental impact (no need for levelling agent). A pH-buffer can be used as alkali spender, instead of neutralising the acid bath with alkali (which would give uneven results). However, these compounds also need to be assessed for their hazardousness and the possible formation of harmful products.

The fact that reactive dyestuffs may contain organically bound halogens is regarded as an environmental issue, especially in countries where AOX is a parameter regulated by the environmental legislation. However, in the case of reactive dyes, the AOX found in the waste water are not the result of a haloform reaction and therefore they represent a much lower level of risk for the environment. Furthermore AOX originated from reactive dyes are not persistent in the environment because of hydrolysis (see also Section 2.7.8.1, “AOX”).

Note also that most navy and black dyestuffs (shade range in which chrome dyes are most used) do not contain any AOX at all [280, Germany, 2002].

Finally water and energy consumption: when dyeing with reactive dyes two rinsing steps at about 80 °C are normally carried out after dyeing, in order to remove the unfixed dye. This leads to higher consumption of water (approximately 30 % more [163, Comm., 2001]) and energy.

However, as already mentioned earlier, recent industrial experience shows that in most cases the afterclearing process can be carried out directly in the exhausted dye bath, thus saving water and energy (specific water consumption figures of about 25 l/kg are reported) [280, Germany, 2002].

Applicability

Reactive dyestuffs described in this section are suitable for wool and polyamide in all make-ups and can be applied in all types of dyeing machines.

Fastness properties can be very good and even comparable/equivalent to those obtained with chrome dyes. However, the importance of reactive dyes in substitution of chrome dyes is increasing only slowly for a number of reasons:

- not all operators agree that wool articles treated with the two different classes of dyestuffs both meet the final quality standards, especially for fastness levels. Some finishers still consider that chrome dyes are the only dyes that can guarantee the level of fastness required for over dyeing
- it is not possible to match the same shade (metamerism) and thus a slightly different product is obtained by substitution
- it is difficult, especially for commission dyehouses, to change over to reactive dyestuffs because customers often expressly require the use of a specific class of dyestuffs
- operators find it difficult to adapt to new techniques because this requires radical changes to a well-established procedure
- dyeing with reactive dyes is claimed to be more expensive than with chrome dyes.

Economics

UBA states that costs are comparable with the chroming method when taking into account the overall process costs [179, UBA, 2001].

According to CRAB- Italy, on the other hand, dyeing with reactive dyes is more expensive than with chrome dyes [163, Comm., 2001]. The economic aspects involved with changing over from chrome to reactive dyes are summarised in the following table.

Item	Additional costs	Avoided costs	Remarks
Dyestuff and auxiliaries	CRAB-Italy states that 30 % increase in recipe costs (0.25 EURO/kg) is observed, due to the higher cost and the higher consumption levels of reactive dyes [163, Comm., 2001]		A full cost comparison is needed to support this statement
Water	Increase in water costs due to higher consumption in rinsing steps (30 % more than to chrome dyes) [163, Comm., 2001]		Water use for chroming is up to 25 - 35 l/kg (knitted fabric), but lower for loose fibre, tops, yarn. Metal complex dyeing of semi-worsted wool yarn is ca. 25 l/kg. Reactive dyeing probably needs more water when aftertreatment is carried out in a separate bath
Thermal energy	Increase in energy costs due to higher consumption in rinsing steps (estimated 3 - 5 MJ/kg more than with chrome dyes) [163, Comm., 2001]		Estimate has been made based on the following assumptions: <ul style="list-style-type: none"> - two rinsing steps, - 1:10 liquor ratio, - the water has to be heated from 20 to 80 °C (4.2 kJ/l °C)
Waste water treatment	Higher energy costs in the ozonisation treatment of the final mixed effluent due to increased colour level [163, Comm., 2001]		EU research showed that more effective and less expensive routes (ETF & EPF) are available for destruction of the residual dyestuff in the segregated waste water stream [191, VITO, 2001]
Waste disposal		Savings thanks to the absence of chrome in the sludge	
Source: [163, Comm., 2001] and remarks according to [191, VITO, 2001]			

Table 4.26: Assessment of the economic aspects involved when changing over from chrome to reactive dyes

Driving force for implementation

Economic reasons are not considered to be the driving force. Pressure and safety requirements set by legislation play a more important role in the ongoing process of substitution for chrome dyes.

As mentioned at the beginning, the use of chrome dyes is also discouraged by various initiatives at European level (e.g GuT label for carpets, Eco-label for textile products, etc.). GuT members, for example, have agreed to no longer use chrome dyes for carpet wool and the European Eco-label Criteria are taking the same direction for textiles.

GuT and EU labelling do not exclude metal complex dyes. OSPAR recognises the need for chrome dyes, but strict limits are recommended in order to minimise the amount of chrome discharged.

Reference plants

Reactive dyes have been on the market for about 15 years and are now successfully applied in many finishing mills in Europe and world-wide.

Reference literature

[179, UBA, 2001], [163, Comm., 2001], [61, L. Bettens, 1999], [59, L. Bettens, 2000], [51, OSPAR, 1994].

4.6.17 Emission reduction in dyeing wool with metal-complex dyestuffs

Description

Dyeing of loose wool fibre and combed tops is still often carried out using afterchrome or metal-complex dyestuffs. Afterchrome dyestuffs can be substituted by metal-free reactive dyestuffs in many cases. However, when substitution is not possible, another alternative is using metal-complex dyes under optimised conditions (especially pH control).

In the case of 1:2 metal complex dyestuffs, the dyeing process can be improved by:

- using a special auxiliary (mixture of different fatty alcohol ethoxylates with high affinity for the fibre and the dyestuff)
- replacing acetic acid by formic acid.

The optimised process is the well-known "*Lanaset TOP process*", launched by a dyestuffs and textile auxiliaries supplier in 1992.

The control of pH and the application of a mixture of different fatty alcohol ethoxylates shorten the dyeing time drastically compared to the conventional process. In addition exhaustion rate is almost 100 %, which makes dyeing in a standing bath easier [179, UBA, 2001].

In addition to environmental advantages, the process enables reproducible dyeings with very high fastness properties.

Main achieved environmental benefits

Because of the higher exhaustion and fixation rate, the amount of dye in the exhausted liquor is reduced, which directly correlates with lower chromium content of the effluent. Residual chromium levels down to 0.1 mg/l have been reached in the exhausted dye bath in a laboratory test for a marine shade (i.e. a dark shade). Such low values were confirmed as achievable. However, concerning daily practice in companies, higher values of 1 mg/l are considered more realistic. Emission factors of 10 - 20 mg/kg of treated wool can therefore be achieved, which correspond to 1 - 2 mg/l of chromium in the spent dye bath when a 1:10 liquor ratio is used [320, Comm., 2002].

Such low concentration levels open the way for dyeing in a standing bath without the negative effects/limitations arising from build-up of chromium.

The substitution of acetic acid (which has a specific COD of 1067 mg/g) by formic acid (which has a specific COD of only 235 mg/g and is a stronger acid than acetic acid) contributes to lowering the COD load in the effluent.

An additional benefit is achieved due to the reduction of the dyeing cycle time. When applying this technique, boiling time can be shortened to one-third that of the conventional process, which saves energy as well as time.

Operational data

Figure 4.22 shows the dyeing curve for the conventional process and the optimised process (Lanaset TOP process).

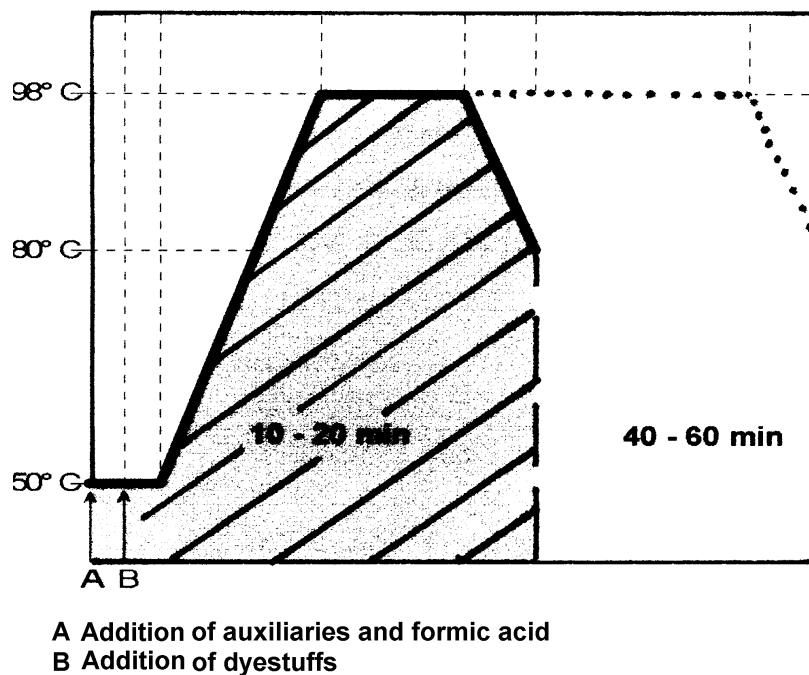


Figure 4.22: Dyeing of loose wool fibre and combed tops: comparison between the dyeing curve for the conventional process (whole curve) and the optimised process (Lanaset TOP process) (dotted part of the curve)
[179, UBA, 2001]

Cross-media effects

None believed likely.

Applicability

The technique is applicable in new and existing installations. It is mainly applied for dyeing loose wool fibre and combed tops, which still represent about half of the wool fibre processed annually.

Economics

Savings are achieved due to shorter process time and less rinsing water.

Driving force for implementation

The requirements set by environmental legislation to reduce the chromium content in waste water and the desire to increase productivity have been the main driving forces for the implementation of this technique.

Reference plants

The process has been successfully put into practice in many dyehouses worldwide.

Reference literature

[179, UBA, 2001]

4.6.18 Use of liposomes as auxiliaries in wool dyeing

Description

The use of liposomes as auxiliary products in wool dyeing with acid dyestuffs allows good dye bath exhaustion at 80 °C and in 40 min. The advantages are:

- lower superficial damage of the wool fibre (due to the lower operating temperature the hand-feel of the fabric is softer)
- energy saving
- no electrolyte use
- lower COD load in the waste water.

With wool/polyester mixtures, in order to allow the diffusion of disperse dye into the polyester fibre, it is necessary to operate at higher temperatures (100 °C), and to add a low concentration of carriers. Liposomes have the effect of increasing the diffusion of disperse dyestuffs into the wool fibre (see Section 2.7.7 - “Polyester-wool blends”). It is therefore important to carry out selection essays of the suitable disperse dyestuffs in order to avoid negative effects on the fastness properties of the dyed product.

Main achieved environmental benefits

The main environmental benefits associated with the use of liposomes include:

- energy saving
- lower COD load in the waste water
- lower conductivity of the waste water.

Operational data

Wool dyeing with acid dyes in the presence of liposomes is carried out at 80 °C for 40 min., in a bath containing [308, Spain, 2002]:

- liposome 0.1 - 0.2 % o.f.w.
- formic acid
- acid dyestuff.

Cross-media effects

None believed likely.

Applicability

Liposomes-based auxiliaries have general applicability in wool dyeing mills [308, Spain, 2002].

Economics

Energy savings and better quality of the fabric compensate for the cost of the liposomes [308, Spain, 2002].

Driving force for implementation

The improved product quality is the main driving force for the implementation of this technique.

Reference plants

Two plants in the Barcelona region are reported to have implemented this technique [308, Spain, 2002].

Reference literature

[308, Spain, 2002], [180, Spain, 2001].

4.6.19 Equipment optimisation in batch dyeing

Description

Textile equipment manufacturers are becoming more and more aware of the need to conserve water, chemicals and energy. These are key objectives that new machine technologies help to achieve. Moreover, optimisation of equipment benefits not only environmental aspects, but also process economics.

Liquor ratio is one of the parameters that influence the environmental performance of the batch dyeing processes and, recently, a distinct trend has developed among equipment manufacturers toward reducing bath ratios. Terms like “low” and “ultra-low” liquor ratio are commonly used by equipment manufacturers to define the characteristics of batch dyeing machines (see Section 2.7.8.2 for the definition of these terms). Moreover, an outstanding feature of modern machines is that they can be operated at approximately constant liquor ratio whilst being loaded at a level as low as 60 % of their nominal capacity (or even 30 % of their nominal capacity with yarn dyeing machines). Even small size lots can therefore be dyed at optimal/ nominal liquor ratio. This is particularly important especially for commission companies, which need high production flexibility.

Low bath-ratio dyeing machines conserve chemicals as well as water and energy and also achieve higher fixation efficiency. However, as already explained in other parts of this document (see Section 4.1.4), the total water consumption is determined not only by the liquor ratio of the dyeing step, but also by the rinse and wash processes.

The correlation between bath ratio and total water use is not always exact and factors other than liquor ratio should be taken into account when assessing the environmental performance of a batch dyeing machine.

One important factor is the maximum **cut-off between different batches** and, in particular, the maximum separation between the exhausted dye bath and the rinsing water.

In some modern batch dyeing machines, instead of rinsing by overflow or by draining the bath and refilling the vessel with rinsing water, the textile material is rinsed in a continuous mode in a separate stream, thus avoiding cooling or dilution of the exhausted bath. In this way, the hot exhausted dye liquor and the rinsing waters are kept as separate streams, which allows them to be re-used or at least be treated separately and thermal energy recovered.

Moreover, various techniques can be applied in order to increase **rinsing efficiency**. When applicable, mechanical liquor extraction is a possible method for reducing the non-bound water retained by the fabric, which is otherwise carried over by the substrate to the next step. Expression, suction and blowing air through the fabric are also all available techniques. Vacuum technology is the most efficient, but it is not applicable to all types of fabric and it consumes more energy than expression.

Another factor affecting specific water and energy consumption in dyeing processes is the **duration of the cycle**. Short cycle times mean not only higher productivity, but also a reduction in electrical and thermal energy consumptions. Various techniques can be applied to reduce downtimes in the working cycles. These typically include pumped drain and fill options, charge tanks (which are used for the preparation of the liquor in parallel with other process operations), combined cooling and rinsing systems, etc. In the latter the cooling water is passed through the machine heat exchanger during the cooling step and is then fed directly into the jet as hot fresh rinse water. The quantity of rinsing water can be controlled, depending on the end temperature, the desired rate of cooling and, in some machines, also on the desired quality of rinsing.

Further reduction of the cycle times can be achieved by improving the **textile/liquor contact** to achieve homogenisation of the bath more rapidly (i.e. by shortening the transition time) after a change in operating conditions (e.g. alkali/dyestuff injection, temperature increase/decrease).

Additional common features of modern batch dyeing machines include:

- **automated systems for chemicals/dyes dispensing and dyeing cycle control**: this allows improvement of the efficiency and reproducibility of the process. In addition, overuse of chemicals, handling losses and equipment clean-up requirements are reduced
- **automatic controllers to facilitate liquor level and temperature measurement and control**: where machines are equipped only with manual water control valves there is a potential for overfilling and unnecessary wastage of water during filling and rinsing operations. Spillage may also result from excessive boiling during the final stages of dyeing. Modern machines are fitted with process control equipment capable of accurately controlling the level of the liquor and the steam supply
- **indirect heating and cooling systems**: indirect heating and cooling is now common practice in modern batch dyeing equipment to overcome dilution and spillage of water
- **hoods and doors**: vapour losses can be significantly reduced by full closure of the machines.

Main achieved environmental benefits

The technological optimisation of dyeing machines described above leads to improved environmental performance in terms of both consumption of resources (water, energy and chemicals) and water pollution. These aspects are summarised in the following table.

Aspect	Basis	Technological improvement	Environmental benefit
Dosing of dyes and chemicals	Manual	Automated, microprocessor-controlled	Reduced spillage, handling and residues of chemicals which are ultimately discharged to water
Control of liquor level and temperature	Manual	Automated, microprocessor-controlled	Reduced spillage and wastage of water
Heating	Direct steam, boiling	Indirect heating	Reduced dilution and spillage of water
Hoods, doors	Open	Fully closed	Reduced energy and vapour losses
Liquor ratio	Higher	Lower	Reduced use of: <ul style="list-style-type: none"> - water in the dyeing step - energy to heat the dye bath - chemicals in the dyeing step
Constant liquor ratio across variable load size	Machine needs to be filled with the same volume regardless of the size of the lot	The machine can maintain a constant liquor ratio whilst being loaded at a level as low as 60 % of its nominal capacity	Maintains the same benefits to those achievable with low liquor ratio (see above) but at reduced loading
Sequence of the batches and rinsing operations	Mixed batches	Separate streams (maximum cut-off between different batches)	Avoids contamination of the rinsing water Avoids contamination and cooling of the hot dye bath Possibility of re-use of the dye bath ⁽¹⁾ Improved treatment of the concentrated streams
Rinsing	By overflow or drain and fill techniques	High-efficiency rinsing techniques (e.g. by mechanical extraction)	Reduced water & energy consumption in rinsing operations Lower volume of waste water to be handled
Source: [171, GuT, 2001]			
Notes:			
⁽¹⁾ In particular, the full separation of exhausted hot bath from rinsing water is especially advantageous when dyeing under pH-controlled conditions. In this case, the hot exhausted bath can be directly re-used for making up the next batch because dyeing is started at high temperature.			

Table 4.27: Environmental benefit associated with optimisation of batch dyeing machines

Operational data

Variable according to the type of equipment considered (more information can be found for the examples presented in Sections 4.6.20 to 4.6.21.3).

Cross-media effects

None believed likely.

Applicability

Most of the principles described in this section are applicable to all types of batch dyeing equipment. Indeed, the extent to which the liquor ratio can be reduced depends on the type of substrate to be processed. Nevertheless, today equipment manufacturers can offer for each

substrate machines with increasingly reduced liquor ratios compared to conventional machines, whilst maintaining the same quality standard of the final product.

Examples of batch dyeing machines where the principles described are applied are reported in Sections 4.6.20 to 4.6.21.3.

Economics

Variable according to the type of equipment considered (more information can be found for the examples presented in the crossed-referenced sections mentioned above).

Driving force for implementation

High productivity and reproducibility still remain the main driving forces, followed by savings in water, chemicals and energy consumption.

Reference literature

[176, VITO, 2001], [171, GuT, 2001], [177, Comm., 2001], [179, UBA, 2001], [116, MCS, 2001], [120, Brazzoli, 2001], [127, Loris Bellini, 2001].

4.6.20 Equipment optimisation applied to winch beck dyeing machines

Description

Winch beck dyeing machines are described in detail in Section 10.3.1.1. In many sectors of the textile industry they have been superseded by other types of equipment (e.g. jet), but winch dyeing still remains an important technology when dyeing in piece voluminous textiles such as carpets, upholstery, terry-towels and tubular fabrics. In these types of textiles the softness is determined by the bulk given during dyeing and the winch machine has the advantage of imposing low tension on the fabric while maintaining great mechanical action.

A number of technological improvements have been introduced in this dyeing technique, principally in [171, GuT, 2001]:

- heating: the liquor in the early winches was usually heated by direct steam injection through a perforated pipe. This system provided both rapid heating and vigorous agitation in the beck, but the dilution effect has to be taken into account. Indirect heating/cooling is now more commonly used to overcome dilution and spilling water
- liquor/goods contact: in modern winches both the liquor and the fabric are circulated to improve liquor/goods exchange. The carpet is cycled through the dye liquor, which is in turn continually pumped through a drum filter to remove the lint. This circulation system ensures a more rapid homogenisation of the bath and an even distribution of the colour throughout the carpet
- liquor ratio: recent winch becks operate at liquor ratios that are significantly reduced compared to conventional machines. Moreover, an outstanding feature is that small batches can be dyed with approximately the same liquor ratio as for maximum load
- rinsing: modern winches are designed to remove the carpet without dropping the bath and without cooling or diluting it with rinsing water. Thanks to the “hot-drawing-out system”, the carpet is automatically taken out of the beck and passed over a vacuum extractor which removes the non-bound water. The recovered liquor is diverted back to the dye bath. The carpet is then sprayed and passed over a second suction section where the rinsing water is collected.

In addition to the above, modern winches are fitted with hoods to help maintain temperature and minimise losses. They are also equipped with automated dosing and process control systems for full control of temperature profile and chemicals injection during the dyeing process.

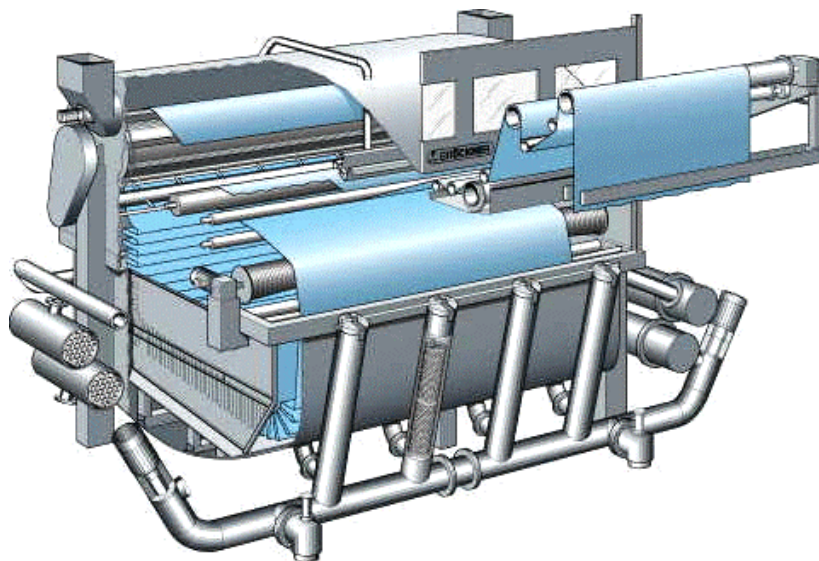


Figure 4.23: Supraflor Carpet Winch
[171, GuT, 2001]

Main achieved environmental benefits

The features described above bring about substantial savings in terms of water, chemicals and energy consumption. Reductions of 40 to 50 % in fresh water for the total dyeing process (up to 94 % savings in rinsing water) and 30 % in electricity consumption are claimed by the machines' manufacturers [171, GuT, 2001].

The advanced concept applied in this type of winch beck is that the rinsing step is no longer carried out in batch, but rather in continuous mode in a separate section of the equipment without contact between the substrate and the bath. In this way there is no mixing between the rinsing water stream and the hot exhausted bath, which makes it possible to re-use both streams and to recover the thermal energy.

Operational data

Liquor ratios used in carpet winches are typically 1:30 or higher. Recent open-width winch becks operate at liquor ratios of 1:15 - 1:20, depending on the substrate type, loading and fabric construction. A new type of winch beck for open-width dyeing of carpet operates at liquor ratios ranging from 1:9.5 to 1:19 and is used successfully in several installations.

In textile dyeing, liquor ratios for conventional winch becks are typically in the region of 1:15 - 1:25. Recent textile winch becks have a nominal liquor ratio as low as 1:5 - 1:8 (depending on the type of substrate) [171, GuT, 2001].

Cross-media effects

None believed likely.

Applicability

New generation winch becks can replace old machines in all applications where the use of winch becks is still necessary (e.g. bulky textile such as carpets, upholstery, terry-towels).

The fundamentals of the new equipment cannot be retrofitted onto existing dyeing machines, they need to be replaced. However, some types of older machines can be upgraded with the special “hot-drawing-out system”.

Economics

No data were made available.

Driving force for implementation

High productivity and reproducibility still remain the main driving forces, followed by savings in water, chemicals and energy consumption.

Reference plants

Many are in operation in textile finishing industries world-wide.

Examples are the Supraflor and the Novacarp Carpet Winch.

Reference literature

[171, GuT, 2001]

4.6.21 Equipment optimisation applied to jet dyeing machines

New concepts have been introduced in jet machines, which can significantly improve not only the productivity but also the environmental performance of the dyeing process for fabrics that are treated in rope form. Some examples of available techniques are presented in the following sections.

4.6.21.1 Airflow jet dyeing machines

Description

Jet dyeing is now a mature technology. There is, however, a fundamental innovation, which is the use of air, either in addition to or instead of water, as the motive force in driving the fabric rope (air-jet).

In the latest development, the fabric is moved by means of moisturised air, or a mixture of steam and air, in the total absence of liquid. The dyestuffs, chemicals and auxiliaries are injected into the gas stream. Liquor ratios of 1:2 may be reached for woven PES fabric, while 1:4.5 is the lowest limit achievable for woven cotton fabric with such air-jet machines.

The following figure shows that the bath level is always below the level of the processed textile. The fabric no longer stays in contact with the liquor (the bath is below the basket holding the fabric in circulation). This means that the bath conditions can be changed without changing the process phase of the substrate (for example, cooling the bath while the substrate is still at high temperature for prolonged fixation, adding chemicals, interchanging the bath with another one).

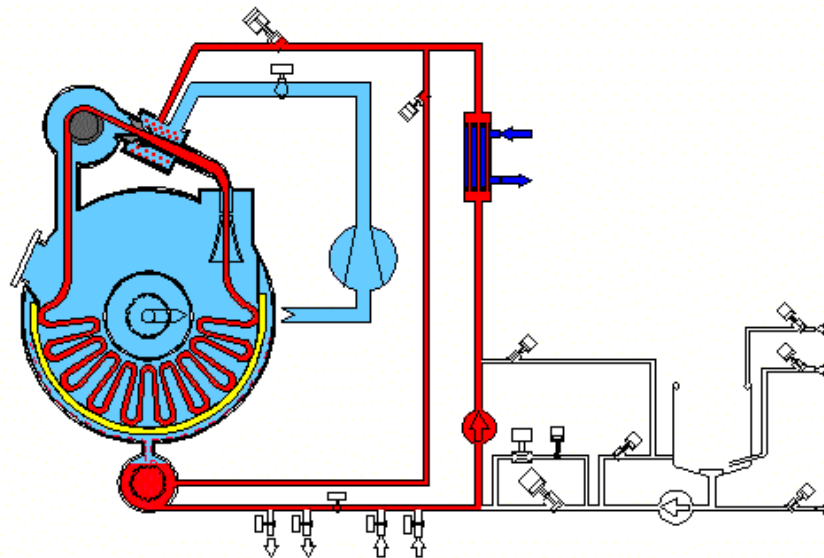


Figure 4.24: Illustration of an airflow dyeing machine with indication of air circulation and injection of the bath

[280, Germany, 2002]

The bath-less dyeing operation is one of the main features of this machine, the other one is the separated circuit for liquor circulation without contacting the textile. By contrast with conventional machines, during the whole rinsing process (see Figure 4.25), the bottom valve is open and the rinsing water, initially sprayed onto the fabric when it enters the jet, is immediately drained without additional contact with the fabric. Thus, rinsing is no longer a batch operation, but instead offers all the potential advantages of continuous processing (time saving, possibility of discharging the bath after high-temperature dyeing at 130 °C for optimum heat recovery, maximum cut-off between hot bath liquors and rinsing water, etc.).

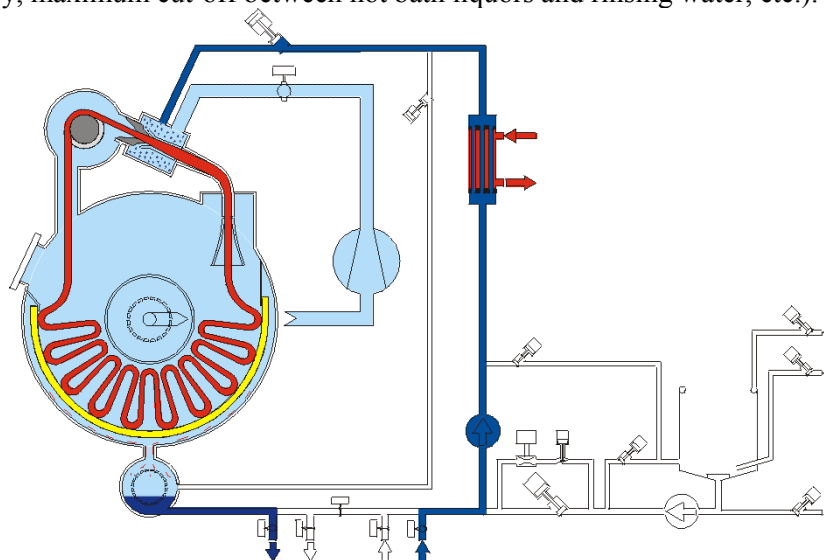


Figure 4.25: Illustration of the rinsing step in an airflow dyeing machine with indication of the open valve to achieve continuous rinsing

[280, Germany, 2002]

Main achieved environmental benefits

The extremely low liquor ratio and the continuous rinsing system results in a virtually non-stop process with:

- less energy needed thanks to quicker heating/cooling and optimum heat recovery from hot exhausted dye liquors
- reduced consumption of those chemicals (e.g. salt) for which dosage is based on the amount of dye bath (about 40 % [179, UBA, 2001])
- less water (up to 50 % water savings are achieved compared to conventional machines operating at L.R. of 1:8 – 1:12) [179, UBA, 2001].

In addition, the release of the exhausted dye bath at process temperature and without dilution by rinsing water opens the way for a very efficient and cost-effective degradation of the remaining dyes and other difficult-to-treat auxiliaries, using the advanced radical treatment process “ETP & ETF” (Enhanced Thermal Fenton reaction & Enhanced Photo Fenton reaction).

Operational data

Table 4.28 shows specific input data ranges for cotton dyeing with reactive dyestuffs in a conventional jet operating at L.R. of 1:8 – 1:12 and in the airflow machine described above. The data are derived from measurements taken at production sites.

It is worth adding that the model of airflow described in this section is also designed to maintain its low liquor ratio even with the machine well underloaded.

Input	Unit	Conventional jet operating at L.R. 1:8 - 1:12	Airflow jet operating at L.R. 1:2 - 1:3 (PES) - 1:4.5 (CO)
Water ⁽¹⁾	(l/kg)	100 - 150 ⁽³⁾	20 - 80 ⁽³⁾
Auxiliaries	(g/kg)	12 - 72	4 - 24
Salt	(g/kg)	80 - 960	20 - 320
Dyestuffs	(g/kg)	5 - 80	5 - 80
Steam	(kg/kg)	3.6 - 4.8	1.8 - 2.4
Electricity	(kWh/kg)	0.24 - 0.35	0.36 - 0.42
Time ⁽²⁾	min		

Source: [179, UBA, 2001]

Notes

⁽¹⁾ Including rinsing

⁽²⁾ Including loading/ unloading

⁽³⁾ The variation in water consumption is to be read as 20 l/kg in the case of PES and 80 l/kg in the case of cellulose. The airflow machine can use as little as 16 l/kg for peroxide bleaching against 32.5 l/kg for a conventional jet and 26.6 l/kg for reactive dyeing/wash-off against 43 l/kg for a conventional jet [176, VITO, 2001]

Table 4.28: Comparison of specific input data for cotton dyeing with reactive dyestuffs in a conventional jet (L.R. 1:8 – 1:12) and in the airflow machine described above

Cross-media effects

None believed likely.

Applicability

This machine can be used both for knit and woven fabric and for nearly all types of fibres. Fabrics containing elastane fibres, which are always difficult to dye, due to dimensional stability, can be dyed successfully using the airflow system. Limitations to the use of this machine are found with wool and wool blends with a percentage of wool higher than 50 % because of felting problems. This technique cannot be recommended for dyeing linen fabric because the linen lint causes scaling of the machine. The technique has been approved for silk, but it is rarely applied.

A process has been developed to minimise the oxidation of vat and sulphur dyes by the oxygen in the injected air.

Economics

The application of this technique means investment in new equipment. Existing machines cannot be retrofitted. Investment cost for this type of machine is around one third higher than conventional jets, but due to high savings the payback period is relatively short. [179, UBA, 2001].

Driving force for implementation

High productivity and repeatability still remain the main driving forces, followed by savings in water, chemicals and energy consumption.

Reference plants

Airflow dyeing machines are in operation in many textile finishing mills world-wide. Bath-less airflows such as the one described in this section, where the textile is moved by air only, are produced by THEN GmbH, D-74523 Schwäbisch Hall. ATYC SA Terrassa Barcelona produces an ULLR airflow (AIRTINT EVO H.T. machine) where the fabric is driven by air and water in separate jets. Other producers of machines using air and water for moving the fabric, with reduced and variable bath (e.g. Thies GmbH, 48653 Coesfeld; MCS, I-24059 Urgnano – Bergamo; Scholl AG, CH-5745 Safenwil).

Reference literature

[179, UBA, 2001], [176, VITO, 2001].

4.6.21.2 Soft-flow dyeing machines with no contact between the bath and the fabric

Description

This model of jet uses water to keep the fabric in circulation. The concept that distinguishes this equipment from conventional jets operating with a hydraulic system is that the fabric rope is kept in circulation during the entire processing cycle (from loading to unloading) without stopping either the liquor or the fabric circulation for normal drain and fill steps.

The principle behind this technique is that fresh water enters the vessel via a heat exchanger and arrives at a special interchange zone whilst at the same time the contaminated liquor is channelled to the drain without coming into contact with the fabric or the new bath in the machine.

Rinsing is carried out in continuous mode, as in the airflow machine described earlier. Rinsing efficiency is increased thanks to the application of a special countercurrent system.

Main achieved environmental benefits

The features of this machine lead to significant savings in processing time (17 – 40 %), water (about 50 %) and steam consumption (11 – 37 %), compared with other soft-flow machines of the same category. Performance data are reported under “Operational data”.

The efficient separation of the different streams offers further advantages such as optimum heat recovery and the possibility of re-use or dedicated treatment.

Operational data

Table 4.29 shows the results of a comparison that has been made by running the same dyeing procedure on a conventional machine, on a “new generation” machine (typified by having charge tanks, pumped drain & fill options and continuous rinsing systems) and on the referenced soft-flow machine described above.

Input	Unit	Conventional jet machine	"New generation" jet machine	Referenced soft-flow machine
Water ⁽¹⁾	(l/kg)	82	87	42
Auxiliaries	(g/kg)			
Dyestuffs	(g/kg)			
Steam	(kg/kg)	3.95	4.84	3.07
Electricity	(kWh/kg)			
Time ⁽²⁾	min	472	341	284
Source: [176, VITO, 2001]				
Notes				
⁽¹⁾ Including rinsing				
⁽²⁾ Including loading/ unloading				

Table 4.29: Comparison of the performance for cotton dyeing with reactive dyestuffs in a conventional machine, a "new generation machine" (typified by having charge tanks, pumped drain & fill options and continuous rinsing systems) and the referenced soft-flow machine

Cross-media effects

None believed likely.

Applicability

Typical applicability of soft-flow machines.

Economics

The application of this technique means investment in new equipment. Existing machines cannot be retrofitted. No data regarding investment costs for this type of equipment were made available.

Driving force for implementation

Increased productivity.

Reference plants

The machine described in this section is produced by Sclavos (VENUSTM with AquachronTM process).

Reference literature

[176, VITO, 2001]

4.6.21.3 Single-rope flow dyeing machines

Description

The configuration of this jet machine is reported in Figure 4.26. The way in which it handles the fabric and the dyeing cycle is very different from conventional rope dyeing machines. Firstly, there is only one fabric rope which passes through all flow groups and compartments, returning to the first compartment after the lap is complete.

The single rope approach ensures both optimum uniformity of the system and repeatability of the results.

High uniformity is achieved because the fabric passes continuously through all the different nozzles and different troughs in each lap. Whilst in multi-rope machines different conditions are generated in each compartment for various reasons (e.g. different speed of the ropes due to different nozzle flows, etc.), the single rope approach ensures homogenous operating conditions in the system as whole. This also means that the bath reaches equilibrium more rapidly when the operating conditions change (e.g. alkali/dyestuff injection, temperature increase/decrease). An immediate consequence is that chemical injection can be much faster and temperature gradients can be significantly increased without damage to the fibre.

This single-rope technique introduces a new concept in securing high repeatability: the use of the number of laps, rather than hold time for controlling the process. Except for time for fixation, which remains a time dependent parameter, addition of dyes and chemicals into the machine, temperature increase/decrease, etc. are done over a number of laps, instead of by a pre-set time. The counting of laps is very easy and ensures that from dye lot to dye lot the fabric always undergoes an equivalent process. Another advantage of the application of this lap-counting approach is that the cycle time is automatically adjusted to the speed of the rope and the load of the machine (the shorter the length of the rope, the lower the machine cycle time).

A lot of the latest time-saving devices are also incorporated, such as power filling and draining, a full volume heated tank, advanced rinsing programmes, etc.

The machine can maintain a constant liquor ratio (typically 1:6) whilst being loaded at a level as low as 60 % of its nominal capacity.

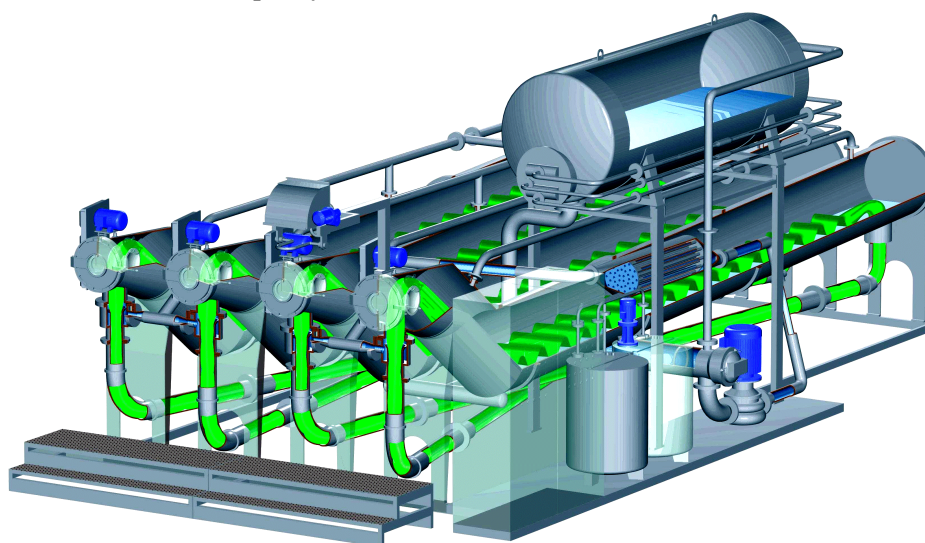


Figure 4.26: Representation of the single-rope dyeing machine

Main achieved environmental benefits

Very short cycles and other features described above result in significant water and energy savings (up to 35 %) compared to conventional multi-rope machines.

High repeatability and reliability of the final results bring about additional environmental benefits. "Right-first-time" production is one of the most effective pollution prevention measures because it avoids additional consumption and waste of chemicals and resources for corrective measures such as rework, re-dyes, stripping, shade adjustments, etc. A reduction of reworks from 5 % to 2 % has been observed in companies where this technique is applied [177, Comm., 2001].

Last but not least, the use of a single-rope machine reduces the amount of sewing and cutting at the end of each dyeing cycle. On average 1 – 1.5 metres of fabric are wasted for each join. A typical three-rope machine performing 3 dyeing cycles per day for 300 days/year would waste 2700 metres of fabric per year more than the same process carried out in a single-rope machine. For a medium-size finishing mill this is equivalent to about 3000 – 4500 kg/year of wasted fabric [177, Comm., 2001].

Operational data

The table below shows the results of the same dyeing process in a conventional machine (L.R. 1:10 – 1:12), a "new generation machine" (typified by L.R. of 1:8 and fitted with latest time-saving devices) and the single-rope machine described above (L.R. 1:6). The data are derived from measurements taken at production sites.

Input	Unit	Conventional jet machine	"New generation" jet machine	Single-rope jet machine
Water ⁽¹⁾	(l/kg)	100 - 130	50 - 90	30 - 70
Auxiliaries	(g/kg)	15 - 75	8 - 40	5 - 25
Dyestuffs	(g/kg)	10 - 80	10 - 80	10 - 80
Auxiliaries	(g/kg)	100 - 900	80 - 640	60 - 480
Steam	(kg/kg)	4 - 5	2 - 3	1.5 - 2.5
Electricity	(kWh/kg)	0.34 - 0.42	0.26 - 0.32	0.18 - 0.22
Time ⁽²⁾	min	510 - 570	330 - 390	210 - 220
Source: [177, Comm., 2001]				
Notes				
⁽¹⁾ Including rinsing				
⁽²⁾ Including loading/ unloading				

Table 4.30: Comparison of the performance for cotton dyeing with reactive dyestuffs in a conventional machine (L.R. 1:10 – 1:12), a "new generation machine" (L.R. 1:8 and equipped with latest time-saving devices) and the single-rope machine described above (L.R. 1:6)

Cross-media effects

None believed likely.

Applicability

The single-rope machine is used successfully for processing both knit and woven fabric of nearly all types of fibres. Unless the horizontal model of this machine is used, limitations are observed when dyeing wool, silk and blends of these two fibres.

Economics

Investment cost for this type of machine is 20 – 30 % higher compared to new conventional type machines, but thanks to savings and the higher productivity the payback period can be less than 10 months.

Driving force for implementation

High productivity, repeatability and versatility are the strong points of this machine. Minimisation of energy consumption is a welcome bonus.

Reference plants

Many are in operation in textile finishing industries world-wide.

The single-rope machine described in this section is produced by MCS Urganano (BG) Italy.

Reference literature

[177, Comm., 2001], [116, MCS, 2001], [176, VITO, 2001].

4.6.22 Water re-use/recycling in batch dyeing processes

Description

Opportunities to minimise water consumption in dyeing processes may be found in dye bath reconstitution and re-use or re-use of the rinse water for the next dyeing.

Dye bath re-use is the process by which exhausted hot dye baths are analysed for residual colourant and auxiliary concentration, replenished and re-used to dye further batches. Two procedures are possible. With the first method the dye bath is pumped to a holding tank (or to a second identical machine), while the product is rinsed in the same machine in which it was dyed. The dye bath is then returned to the machine for the subsequent batch of material. With the second option, the product is removed from the exhausted dye bath and placed in another machine for rinsing. In this case no holding tank is required, but the material needs additional handling. Dye bath analysis can be performed using spectrophotometer and/or may be determined by production experience based on exhaustion level, volatilisation and dye liquor drag-out [11, US EPA, 1995].

Since the spent dye bath is usually hot, it is of course convenient to save time and energy by dye bath re-use. However, to assure level dyeing it is normally necessary to start the dyeing process at 50 °C. Therefore, the hot spent bath is cooled down and then warmed up again. In some cases this can be avoided. New technologies have been developed which allow dyeing to start at process temperatures. Instead of piloting the temperature one can control the chemical potential of the dye (which is what happens, for example, by adding the sodium hydroxide to reactive dyes). These techniques are suitable for wool dyeing with acid dyes, acrylic dyeing (this would exclude the addition of levelling agents) and for cotton in the case of sulphur dyeing or reactive exhaustion dyeing processes [204, L. Bettens, 2000].

The second technique proposed here is similar, but this time the spent rinse bath is re-used to form the next dye bath.

Main environmental benefits

Reduction in water and chemicals consumption. Energy saving (re-use of the hot dye bath) is also possible, in some cases (see above) when dye adsorption is controlled by pH and the bath becomes nearly completely exhausted without cooling down at the end of dyeing.

Operational data

Operational data are reported by UBA for a plant dyeing PES and wool loose fibre. Wool is dyed with afterchrome or with metal-complex dyes, whereas PES fibre is dyed with disperse dyes. Both dyes are characterised by high exhaustion rates, which allows re-use of the spent dyeing bath for the next batches. All dyeing machines with capacity ranging from 50 to 100 kg (L.R. 1:8) have been fitted with holding tanks, temperature and pH control devices and automated dosage systems for formic acid. Most of the holding tanks are constantly used for the same type of dyes and shades (e.g. afterchrome bath for dark shades, etc.). As a result of the improvements, the company has achieved a decrease in specific water consumption from 60 to 25 l/kg [179, UBA, 2001].

Another operational experience is reported by ENco for a mill dyeing wool loose fibre. The company operates conical pan type machines and loads the fibre carriers with dry fibre. Mean specific water consumption figures for the conventional dyeing and rinse cycle are 9.5 l/kg and 7.8 l/kg, respectively (1.7 l/kg is retained by the fibre load between dyeing and rinsing). Overall water consumption for a conventional cycle would be 17.3 l/kg.

When re-using the rinse liquor for the next dyeing it is necessary to add on average 1.7 l/kg of fresh water to the dyeing to make up for the water lost when the wet fibre from the previous dyeing is removed. Experience indicates that on average only four cycles of the same shade can be sustained with re-use. Overall water consumption for this four-batch dyeing system is reduced by approximately 33 % when compared with the conventional cycle [32, ENco, 2001].

Cross-media effects

None believed likely.

Applicability

For re-using water in dyeing processes (both techniques) holding tanks are normally needed to store the spent baths. Some models of modern batch dyeing machines (e.g. jiggers, jets and winches) have built-in holding tanks, thus allowing for uninterrupted automatic separation of concentrates from rinsing water.

When using top-loading dyeing machines (typically used for loose fibre and in some cases for yarn) the rinse bath can be retained in the machine at the end of the process and re-used for dyeing the next lot of material without need for holding tanks.

The re-use of dye baths and rinse waters involves some fundamental differences from the use of fresh bath. The easiest systems to manage are dye classes which have high affinity (exhaustion) and which undergo minimum changes during the dyeing process. Examples are acid dyes for nylon and wool, basic dyes for acrylic, direct dyes for cotton and disperse dyes for synthetic fibres. The easiest situation is to re-use a dye bath to repeat the same shade with the same dyes and equipment and the same fibre. Some production planning to progress from pale to deep shades is required (which may somewhat limit the flexibility of batch dyeing operations).

The number of re-use cycles is limited by build-up of impurities from several sources. One source is represented by the impurities present on the textile material, which include natural impurities in cotton and wool, knitting oils, fibre preparation agents, etc. Impurities can also

accumulate from components of dye formulations, auxiliaries (e.g. levelling agents), electrolytes, salt build-up from addition of acids and bases for pH control, etc.

In conclusion, the limitations are less severe where machinery is available for internal separation of contaminated spent bath and rinsing water, where trichromatic dye systems are used, dye adsorption is controlled by pH (saving the hot dye bath) and where the bath becomes nearly completely exhausted without cooling down at the end of dyeing [204, L. Bettens, 2000].

Economics

Direct savings are related to both process water purchase price and effluent disposal costs. Prices vary from country to country. UBA reports, for the example plant described above, savings of 3.20 euros/m³ (0.6 euros/m³ for fresh water, including treatment, and 2.60 euros/m³ for disposal fee). ENco indicates UK costs in the region of 1.09 euros/m³ for town water and average effluent disposal cost of about 1.62 euros/m³ (calculated according to the standard Modgen strength formula) [32, ENco, 2001].

In the example plant reported by UBA, investment costs for the tanks, piping and control devices amounted to 0.8 million euros [179, UBA, 2001].

Reference plants

Many plants in Europe.

Reference literature

[204, L. Bettens, 2000], [179, UBA, 2001], [11, US EPA, 1995], [51, OSPAR, 1994] (P087, P088), [32, ENco, 2001].

4.7 Printing

4.7.1 Urea substitution and/or reduction in reactive printing

Description

Description

Urea content in reactive printing paste can be up to 150 g/kg paste. Urea is also used in printing pastes for vat dyes, but in much lower concentration (about 25 g/kg paste). Urea is applied to:

- increase the solubility of dyestuffs with low water solubility
- increase the formation of condensate, which is necessary for allowing migration of the dyestuff from the paste to the textile fibre
- form condensates with a higher boiling point (115°C) which means that requirements for constant operating conditions are lower (non-constant operating conditions can negatively affect reproducibility if urea is not used).

Urea can be substituted by controlled addition of moisture (10 wt-% for cotton fabric, 20 wt-% for viscose fabric and 15 wt-% for cotton blends). Moisture can be applied either as foam or by spraying a defined quantity of water mist.

Main achieved environmental benefits

In the textile finishing industry the printing section is the main source of urea and its decomposition products (NH₃/NH₄⁺). During waste water treatment, the nitrification of the excess ammonia involves high energy consumption. Discharge of urea, ammonia and nitrate

contributes to eutrophication and aquatic toxicity. Minimisation/elimination of urea at source significantly reduces these adverse effects.

In reactive printing the urea content in the printing paste can be reduced from 150 g/kg paste to zero by application of moisture. In case of phthalocyanine complex reactive dyes, however, reduction is possible only to 40 g/kg paste because of the bad migration properties typical of these large-molecule dyestuffs [179, UBA, 2001].

Operational data

By avoiding the use of urea in reactive printing pastes, the ammonia concentration in the mixed effluent of a finishing mill with a significant printing section, decreased from about 90 - 120 mg $\text{NH}_4^+\text{-N/l}$ to about 20 mg $\text{NH}_4^+\text{-N/l}$ [179, UBA, 2001].

Without using the referenced technique, the amount of urea consumed can be reduced to about 50 g/kg of printing paste for silk and 80 g/kg for viscose, and still maintain the quality standards.

Cross-media effects

The application of moisture needs energy, but this consumption is significantly lower than the energy required for the production of urea [179, UBA, 2001].

Applicability

The foam and the spraying systems are applicable to both new and existing plants performing reactive printing [179, UBA, 2001].

For silk and viscose articles, however, it is not possible to completely avoid the use of urea with the spraying system. The technique is not reliable enough to ensure a uniform dosage of the low moisture add-on required for these fibres and, especially for fine articles, cases have been reported where spraying systems did not meet the quality standards.

On the contrary, the foaming system has proven successful for several years for viscose in complete elimination of urea [179, UBA, 2001]. This technique should in principle be technically viable also for silk, although it has not yet been proven. Silk is known to be less problematic as a fibre than viscose, but it is typically processed in smaller runs.

Economics

The investment costs for spraying equipment including on-line moisture measurement are about 30000 euros, but the foam system is significantly more expensive. Approximately 200000 euros are required for a foaming machine, which relates to a production capacity of up to about 80000 linear metres per day. The foaming technique has been operated under economically viable conditions in plants of capacity of about 30000, 50000 and 140000 linear metres per day.

Driving force for implementation

Stringent limits applied by local authorities for $\text{NH}_4^+\text{-N}$ in waste water, due to eutrophication and aquatic toxicity in surface water, have promoted the introduction of this technique.

The application of this technique is also very attractive for mills discharging to a municipal waste water treatment plant. Because of the high energy consumption for biological nitrification, many municipalities now charge indirect dischargers for nitrogen emissions.

Reference plants

Many plants in Europe. Example plants where the technique is currently applied are: Ulmia, D-Ravensburg-Weissenau; KBC, D-Loerrach; Textilveredlung Wehr, D-Wehr [179, UBA, 2001]

Reference literature

[179, UBA, 2001].

4.7.2 Reactive two-step printing

Description

As already described in Section 4.7.1, in conventional one-step printing with reactive dyes, urea is used to increase solubility of the dyestuffs and to improve dyestuff migration from the printing paste to the textile fibre.

Minimisation or even substitution of urea is possible in the one-step method by controlled addition of moisture.

Another option is the two-step printing method, involving the following steps:

- padding of the printing paste
- intermediate drying
- padding with alkaline solution of fixating agents (especially water-glass)
- fixation by means of overheated steam
- washing steps (to remove thickeners and improve fastness properties).

The process is carried out without urea.

Main achieved environmental benefits

Significant reduction of ammonia content in waste water and reduced off-gas problems are the main ecological improvements. In addition the life-time of printing pastes is lengthened, which increases the opportunities to recycle the residual printing pastes [179, UBA, 2001].

Operational data

A typical recipe for the printing paste is given below [179, UBA, 2001].

Thickening stock solution:

alginate-based thickening agent:	700 g
oxidising agent:	50 g
complexing agent:	3 g
preserving agent:	0.5 - 1 g
water:	x g
Total:	1000 g

Printing paste:

thickener stock solution:	800 g
reactive dyestuff:	x g
water:	y g
Total:	1000 g

Fixation is carried out by means of overheated steam (90 s at 125 °C).

Cross-media effects

None believed likely.

Applicability

Two-step reactive printing can be carried out on cotton and viscose substrates. Application of the fixation liquor needs the combination of an impregnation device with a steamer. Overheated steam is necessary. Reactive dyes based on monochlorotriazine and vinylsulphone types can be used [179, UBA, 2001].

It should be noted that this technique is more complex and slower than the one-phase process.

Economics

No information was made available.

Driving force for implementation

Environmental and quality aspects are the reasons for implementing a two-step printing method.

Reference plants

Many plants in Europe and world-wide.

Reference literature

[179, UBA, 2001] with reference to:

“DyStar, 2000”

DyStar, D-Frankfurt/Main

Product information (2000)

4.7.3 Pigment printing pastes with optimised environmental performance

Description

The final stages in pigment printing consist in drying and fixing the printed fabric with hot air. In both stages, emissions of volatile organic compounds to air may be significant (see also Sections 2.8.3 and 8.7.2).

White spirit used for emulsion thickeners was a major source of volatile organic compounds in the past. Water-in-oil (full emulsion) thickeners seem no longer to be applied in Europe and half-emulsion printing pastes (oil in water) are only occasionally used. Hydrocarbons (predominantly aliphatic) are still found in exhaust air, however, mainly arising from mineral oil contained in synthetic thickeners. Their emission potential can be up to 10 g Org.-C/kg textile.

New generation thickeners contain minimal amounts of volatile organic solvents. They are based on polyacrylic acid or polyethylene glycol compounds instead of mineral oils. Products have also been developed that do not contain any volatile solvent. They are supplied in the form of non-dusting granules or powders.

Another potential source of air emissions in pigment printing is fixing agents. The cross-linking agents contained in these auxiliaries are largely based on methylol compounds (melamin compounds or urea-formaldehyde pre-condensates) that give rise to formaldehyde and alcohols (mainly methanol) in the exhaust air. New low-formaldehyde products are now available.

Furthermore, optimised printing pastes are APEO-free (pigment printing auxiliaries may be found in the waste water as a result of cleaning operations, etc.) and have a reduced ammonia content. Ammonia is used as additive in binders and is also a source of air pollution.

Main achieved environmental benefits

Table 4.31 shows for three typical thickeners the emission levels that may arise from drying and fixing.

Operation	Pigment print recipe I (g Org.-C/kg textile)	Pigment print recipe II (g Org.-C/kg textile)	Pigment print recipe III (g Org.-C/kg textile)
Drying	2.33	0.46	0.30
Fixing	0.04	0.73	0.06
Total	2.37	1.19	0.36
Source: [179, UBA, 2001]			

Table 4.31: Volatile organic carbon emissions in pigment printing

Recipe I is an already optimised thickener, but still containing hydrocarbons. In the optimised recipe II the mineral oil is replaced by polyethylene glycol, while recipe III uses a powder thickener. With recipe III formaldehyde emissions can be kept below 0.4 g CH₂O/kg textile (assuming 20 m³ air/kg textile). As a result, the carry-over of volatile substances from printing to finishing processes can also be reduced to <0.4 g Org.-C/kg.

Using optimised printing pastes, ammonia emission can also be reduced below 0.6 g NH₃/kg textile (assuming an air/textile ratio of 20 m³/kg).

Operational data

There has been no evidence of variations in operating conditions, product quality or process control [180, Spain, 2001].

Cross-media effects

None believed likely.

Applicability

The technique is applicable in new and existing installations [179, UBA, 2001], [180, Spain, 2001].

Thickeners based on powders may generate dust or block the stencils [179, UBA, 2001].

Economics

The higher costs of the printing pastes are offset by the reduced air treatment costs (lower emissions of organic volatile compounds) [180, Spain, 2001], [179, UBA, 2001].

Driving force for implementation

Environmental legislation (regarding, in particular, emission limits set for volatile organic carbon, formaldehyde and ammonia) is the main motivation for the use of optimised printing pastes [179, UBA, 2001].

Reference plants

Many plants in Europe and world-wide.

Reference literature

[180, Spain, 2001], [51, OSPAR, 1994] (P096, P106), [61, L. Bettens, 1999], [179, UBA, 2001]

4.7.4 Volume minimisation of printing paste supply systems in rotary screen printing machines**Description**

A typical printing paste supply system for textile rotary screen printing machines is illustrated in Figure 2.22. The volume depends on the diameter of the pipes and squeegee as well as on the pump design and the length of the pipes.

Printing paste supply systems, of which there may be up to 20 per printing machine, have to be cleaned at each change of colour or pattern and a considerable amount of printing paste finds its way into the waste water. For fashion patterns, a typical number of different colours per design is 7 to 10. Typical system volumes in conventional and optimised printing paste supply systems for textiles are shown in Table 4.32. Note that the figures given in this section are not applicable to carpet rotary screen printing (the screens in carpet rotary screen printing are much bigger – 5 - 6 m width – and the the volumes of printing paste to be delivered are much higher than in most textile printing applications).

Printing width (cm)	Conventional system ⁽¹⁾ (litres)	Optimised system ⁽¹⁾ (litres)
164	5.1	2.1
184	5.2	2.2
220	5.5	2.3
250	5.8	2.4
300	6.2	2.6
320	6.5	2.7
Source: [179, UBA, 2001]		
Notes: ⁽¹⁾ including pipes, pump and squeegee		

Table 4.32: Volume of conventional and optimised printing paste supply systems in rotary screen printing machines for textiles

In addition to this volume, residual printing paste in the rotary screens has to be taken into account, which may be about 1 - 2 kg. Thus, in conventional systems the loss per supply system is up to 8 kg.

If this quantity is compared with the amount of paste applied on the printed fabric (see table below), it becomes apparent that the volume of the supply system is highly significant and may even exceed the amount of paste printed on the fabric (for pattern/batch lengths of about 120 m). In Europe in recent years, average printing batch lengths have significantly decreased to only 400 - 800 m.

Pattern/batch length (m)	Weight (kg) ⁽¹⁾	Printing paste required according to the degree of coverage (kg)		
		25 %	60 %	90 %
120	21.6	5.4	13.0	19.5
500	90.0	22.5	54.0	81.0
1000	180.0	45.0	108.0	162.0
1500	270.0	67.5	162.0	243.0
Source: [7, UBA, 1994]				
Notes: ⁽¹⁾ assuming 180g/running metre				

Table 4.33: Amount of printing paste required for printing various lengths of fabric at different degrees of coverage

Minimising the system volume therefore has major effects in reducing printing paste emissions to waste water.

Diameters of pipes and squeegees have been reduced to 20 - 25 mm, leading to substantial reductions.

Along with minimum-volume supply systems, paste residues can be minimised by improving paste recovery from the supply system itself. New pumps can be operated in both directions. Thus, at the end of each run, the printing paste can be partly pumped back into the drum. The problem of air being drawn in via the holes in the squeegee can be solved by applying the technique described in Section 4.7.5.

Additional measures are:

- using squeegees with an even paste distribution over the whole width (minimisation of residual printing pastes in the screens)
- manual stopping of printing paste supply shortly before finishing a run in order to minimise the residual printing pastes in the rotary screens.

For small run lengths in particular, the following measures may also be considered:

- not using the supply system, but instead injecting small quantities of printing paste (1 - 3 kg) directly into the squeegee manually or by manual insertion of small troughs (with a cross-section of 3x3 cm or 5x5 cm)
- minimisation of pipes by supplying the printing pastes through funnels positioned directly above the pumps.

Main achieved environmental benefits

System volumes and consequent losses can be reduced significantly (according to industrial experience, a reduction of up to one third is possible), depending on the age of the equipment [179, UBA, 2001].

Operational data

Measures such as the manual injection or insertion of printing paste and the manual stopping of the printing paste supply system shortly before the end of the run need trained and motivated staff. Meanwhile some companies have put in practice the manual injection of printing paste, but others report that even for small lots (up to 120 m), the technique is difficult to apply. Reproducibility may be affected because the quantity of printing paste to be injected varies according to the pattern, which is difficult to manage for the staff. Moreover, a constant level of printing paste within the screen cannot be maintained, which may affect constancy of printing quality.

Cross-media effects

None believed likely.

Applicability

The described measures are applicable to both existing and new installations.

Economics

The installation of 12 sets of volume-minimised pipes and squeegees requires investment cost of about EUR 25000.

Driving force for implementation

The need to minimise production costs by minimising printing paste losses and problems with waste water disposal have been the main driving forces.

Reference plants

Many plants in Europe and world-wide have been retrofitted with minimised printing paste supply systems that operate successfully.

Reference literature

[179, UBA, 2001], [51, OSPAR, 1994] (P100).

4.7.5 Recovery of printing paste from supply system in rotary screen printing machines

Description

This technique allows the recovery of the printing paste remaining in the supply system in rotary screen printing machines at the end of each run. Before filling the system, a ball is inserted in the squeegee and then transported by the incoming paste to its end. After finishing a print run, the ball is pressed back by controlled air pressure, pumping the printing paste in the supply system back into the drum for re-use. Systems available for re-using residual printing paste are described in Section 4.7.6.

The technique is illustrated in the figure below, showing the ball during the phase in which the pump is transporting the paste back to the drum.

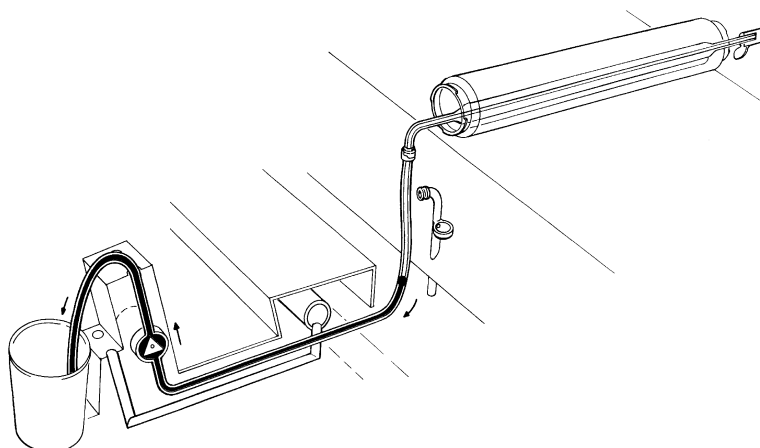


Figure 4.27: Recovery of printing paste from the paste supply system by back-pumping an inserted ball

[179, UBA, 2001] with reference to “Stork, 2001”

Main achieved environmental benefits

Printing paste losses are reduced drastically. In textiles, for instance, at a printing width of 162 cm, the loss is reduced from 4.3 kg (in the case of a non-optimised printing paste supply system) to 0.6 kg.

Rotary screen printing machines have up to 20 supply systems, although in practice, for fashion patterns, 7 - 10 different printing pastes are common. Therefore, the 3.7 kg of printing paste saved per supply system have to be multiplied by 7 - 10. Water pollution can thus be minimised considerably.

To achieve maximum benefit from this measure, modern printing machines with minimum-volume feed systems should be used (see Section 4.7.4).

Operational data

The described technique is successfully applied in textile finishing mills, especially in combination with recycling of the recovered printing paste.

Cross-media effects

None believed likely.

Applicability

The technique is applicable to new installations (new rotary screen printing machines). Certain existing machines can be retrofitted. There is only one supplier for this technique (Stork Brabant B.V., NL-5830 AA Boxmeer). All their machines newer than the so-called RD-III (that is RD-IV and all subsequent models) can be retrofitted with the described system.

As mentioned earlier the technique is applied in textile finishing mills (for flat fabrics). In principle this system can also work for carpets, but it is not applied for various reasons. Probably the main reason is related to the type of thickeners most commonly used in carpet printing pastes. These are based on guar-gum, which is quite inexpensive, but has a limited shelf-life and therefore cannot be stored for long time before re-use (it is biodegradable and the growth of bacteria and other organisms such as yeasts, rapidly destroy the viscosity).

Economics

Investment for retrofitting this recovery system to a rotary screen printing machine with 12 new squeegees and pipes (for a printing width of 185 cm) is about EUR 42000. The next table shows the savings achievable in the reference mill.

Number of changes of printing pastes per day	8
Number of working days per year	250
Average number of printing pastes per design	7
Saving of printing paste per supply system	3.7 kg
Price of printing paste	0.6 euros/kg
Saving per year	31080 euros/yr
Source: [179, UBA, 2001]	

Table 4.34: Calculation of savings achievable in a typical textile mill by installing the referenced printing paste recovery system (the number of changes as well as the number of printing pastes per design may be higher in industrial practice)

The example does not include the investment cost of new pumps, so a certain range of viscosity needs to be maintained. When a wide viscosity range is required, the pumps have to be replaced. The total investment cost is then reported to range between about 90000 and 112000 euros.

A payback time of about two years can therefore be considered realistic, but only when the whole amount of recovered printing paste is re-used. In practice this does not happen, especially with mills that use several different types of printing pastes. In such mills, due to logistical problems (limited storage and handling capacities), re-use rates of only 50 - 75 % are reported, which significantly extends the payback period [179, UBA, 2001].

Driving force for implementation

Severe waste water problems and the need to reduce printing paste losses for economic and environmental reasons have been the main driving forces.

Reference plants

World-wide, but especially in Europe, there are many rotary screen printing machines in operation, equipped with the described technique.

Reference literature

[179, UBA, 2001], [180, Spain, 2001].

4.7.6 Recycling of residual printing pastes

Description

Printing pastes are highly concentrated preparations that consist of dyestuff, thickener and various other auxiliaries according to the different types of pastes (e.g. pigment, reactive, vat and disperse printing pastes). Printing paste residues can reach levels as high as 40 – 60 % in non-optimised equipment. A large portion of these residues is still discharged to the effluent, thus causing considerable waste water problems (see Section 2.8.3).

For a long time, printing pastes were prepared manually, which meant that residues were re-used, but the extent and manner of that re-use were highly dependent on the staff responsible and on the production schedule. Today, computer-assisted systems offer more opportunities for recycling printing pastes. In most companies printing pastes are prepared with computerised

systems (each printing paste has its specific recipe which is saved electronically). At the end of a run each residual paste is weighed and sent to a defined location in a storage facility. The composition is saved electronically and computer programmes calculate the formulation of new printing pastes, taking account of the amount, composition and durability (which is not normally a problem) of the residues to be re-used.

Another option is to empty all drums with residual printing paste and sort it according to its chemical characteristics (that is, type of dyestuff and thickener). The drum is cleaned with a scraper to minimise the printing paste loss, then is washed and re-used for the preparation of new printing pastes.

Main achieved environmental benefits

The quantity of residual printing pastes to be disposed of is significantly reduced both as waste water and solid waste. The amount of residual printing paste is reduced by at least 50 % and in many cases by about 75 % [179, UBA, 2001], [192, Danish EPA, 2001].

Operational data

Textile finishing mills that have applied these techniques report that such systems need some time for implementation in daily routine, but after managing starting problems, they work satisfactorily. The recycling systems described here are most efficient in companies having only one or two kinds of printing pastes (e.g. pigment and reactive printing pastes). In companies using various different types of printing pastes, the management of a large number of different mixtures may be difficult (logistical problems, limited capacity of the storage area, etc.). In these cases, the recycling rate may be in the range of 50 – 75 % only [179, UBA, 2001].

Operating with modern printing machines with a built-in system for mechanical removal of printing paste from pipes and hoses of the feeding system will increase the amount of printing paste that can be collected and re-used (see Section 4.7.5).

Cross-media effects

None believed likely.

Applicability

Systems for recycling of printing pastes are applicable in the textile industry both in existing and new installations. However, for totally computerised systems, the printing section must have a minimum size of 3 rotary screen and/or flat screen printing machines [179, UBA, 2001].

Trained and motivated personnel are needed for manual operations, such as scraping buckets, aimed at increasing paste recovery rate. Printers claim that specialised personnel are not willing to scrape buckets, especially given the number of buckets a day that need to be scraped for a typical 12 position printer that has to be changed every 600 - 800 m on average.

This technique is not applicable in the carpet industry for the same reasons explained in Section 4.7.5.

Economics

Investment costs are about 0.5 - 1 million euros, depending on size and number of different printing pastes to be recycled. Payback periods are reported to vary between two and five years depending on individual circumstances [179, UBA, 2001].

Driving force for implementation

Economic considerations and problems regarding residual printing paste disposal have been the main driving forces [179, UBA, 2001].

Reference plants

Many plants in Europe and world-wide.

Important suppliers are:

- Stork Brabant B.V., NL-5830 AA Boxmeers
- GSE Klieverik Dispensing, NL-6971 GV Brummen
- I.A.S. Industrial Automation Systems S.R.L., I-22077 Oligate Comasco

Reference literature

[179, UBA, 2001], [192, Danish EPA, 2001].

4.7.7 Reduction of water consumption in cleaning operations

Description

The equipment used around the printing machine (e.g. screens, buckets and the print paste feed system) needs careful cleaning before it can be used for new colours. In connection with cleaning operations there are several ways of reducing water consumption:

- A. start/stop control of cleaning of the printing belt
- B. mechanical removal of printing paste
- C. re-use of the cleanest part of the rinsing water from the cleaning of the squeegees, screens and buckets
- D. re-use of the rinsing water from the cleaning of the printing belt.

A. Start/stop control of cleaning of the printing belt.

In many cases water dosage for the cleaning of the printing belt continues when the fabric and (therefore) the printing belt are stopped for whatever reason. Start/stop control of the water dosage can be automatically connected to the start/stop control of the printing belt.

B. Mechanical removal of printing paste.

Large amounts of water for cleaning of squeegees, screens and buckets are used within the print-house. Improved printing paste removal before flushing this equipment reduces the amount of water needed for flushing. Physical devices for removal of dye from buckets are available (e.g. scrapers). Modern printing machines have a built-in system for mechanical removal of residual printing paste from pipes and hoses.

C. Re-use of the cleanest part of the rinsing water from the cleaning of the squeegees, screens and buckets.

Typically, the first half of the effluent from the washing equipment is heavily loaded with printing paste and will have to be discharged as waste water. The water used for this first stage does not, however, need to be of a high quality, which means that recycled water can be used. In the second half of the washing process, clean water must be used, but the effluent can be collected for re-use, potentially as first-rinse water in the next cycle.

D. Re-use of the rinsing water from the cleaning of the printing belt.

The rinsing water from the cleaning of the printing belt is only slightly coloured and contains small amounts of fibres (depending on the fabric) and very small amounts of glue. The rinsing water can be mechanically filtered, collected in an overflow vessel and re-used for the same purpose if minor amounts of fresh water are added to the recycling system.

Main achieved environmental benefits

The environmental benefit is a reduction in water consumption. In a Danish pigment print-house the implementation of all the above options has reduced the annual consumption of water by approximately 25000 m³ (55 % reduction). For option A alone the savings are estimated at approximately 2 m³ for every hour the printing machine is stopped and the water dosage for cleaning of the printing belt is still running for whatever reason. For option C 50 % of the water can be re-used. For option D approximately 70 % of the water can be recycled [192, Danish EPA, 2001].

Operational data

No information was made available.

Cross-media effects

None believed likely.

Applicability

Options A – D can be implemented in all types of textile companies involving a printing section: new or existing, large or small. Space availability is a minor factor: the company only needs space for collection tanks (option C and D). However, older printing machines can probably not be retrofitted with a device for mechanical removal of the residual printing paste from pipes and hoses in the printing machine as suggested in option B [192, Danish EPA, 2001] (see Section 4.7.5).

Economics

In the Danish case mentioned above, the total capital costs (tanks, mechanical filters, pumps and pipes) for all options are estimated at approximately 100000 DKK (13500 euros). Options C and D together amount to approximately 95000 DKK (12825 euros). Option A costs approximately 5000 DKK (675 euros) and the cost of option B is negligible. Changes in operating costs (before and after implementation) for all options are negligible. The costs for fresh water and waste water discharge are 9 and 18 DKK per m³ respectively (1.2 and 2.43 euros/ m³). Hence the total annual savings are approximately 675000 DKK (90000 euros). For the case study considered here, the payback time for all options together is estimated at about two months [192, Danish EPA, 2001].

Driving force for implementation

The high cost of waste water discharge and, in some countries, of fresh water are the main driving forces for implementing the measures described.

Reference plants

Many plants in Europe. One example plant is mentioned by [192, Danish EPA, 2001]: Danish Colour Design Textile Print A/S

Reference literature

[192, Danish EPA, 2001]

4.7.8 Digital jet printing of carpet and bulky fabric

Description

The principles of jet printing and the latest development in this technique are described in Section 2.8.2.

Jet printing is today a full digital technique (right from the design stage to industrial production). The designer makes the sample on the computer and from this digital information the sample can be exactly reproduced on an industrial scale without need for corrective adaptations/measures.

Main achieved environmental benefits

In digital jet printing, selected trichromatic dyes are dosed on-line, based on computed requirements. The colour is applied on demand. This avoids dye losses or printing paste residues at the end of the process, which represents a revolutionary change from conventional printing methods (flat-screen and rotary screen).

Another big advantage of this technique is that the amount of thickeners can be reduced depending on the type of substrate because the dye is shot directly deep into the face of the fabric.

Further environmental advantages are [171, GuT, 2001]:

- reduced water consumption (only 20 % compared with conventional printing)
- less trial-and-error sampling (one of the most important sources of pollution, often forgotten in evaluations)
- the printing process can be carried out in the final stage of the manufacturing chain (reduction of material losses, particularly of coloured fabric).

Operational data

No information made available.

Cross-media effects

Compared to analogue printing techniques, no negative cross-media effect needs to be mentioned. However it is important to point out that the substrate must still undergo fixation and afterwashing. Therefore water emissions cannot be completely avoided.

Applicability

Digital jet printing can be applied to carpet and bulky fabrics. It is also applicable for patterning runners, mats and tiles, in which case the operation is done very conveniently at the end of the process on the ready-made product (which doesn't need to be washed afterwards).

The investment cost is still significant, which means that this technique is applied only in large companies.

There is still room for developments in [171, GuT, 2001]:

- increasing productivity
- wider application (uneven pile density and un-level pile-height, blends, unfixed structure)
- reducing investment cost
- expanding the dye-range to cover more, if not all, shades and depths.

Economics

The relatively high investment cost (no precise information given) of this sophisticated equipment makes this technique more appropriate for large-volume print houses. Nevertheless, digitally-controlled printing and processing offers several economic advantages. First of all this technique allows the flexibility necessary to satisfy customer and retailer demands with just-in-time delivery (quick reaction to customer's orders, alterations easily made). Equally, the stocking of finished goods becomes unnecessary as goods are produced to order. As designs are stored in an electronic format there is no need for a large screen storage facility [171, GuT, 2001].

Reference plants

Many plants already use digital jet printing machines.

As already stated in Section 2.8.2, the latest developments of this technique are already applied on commercially available machines, such as the Zimmer's Chromojet and the latest Milliken's Millitron machine.

Reference literature

[171, GuT, 2001].

4.7.9 Ink-jet digital printing for flat fabric

Description

A technique such as the jet printing technique (see Sections 2.8.2 and 4.7.8), where the colour is injected deep into the face of the fabric, is applicable for carpet and bulky fabrics but is not suitable for light fabrics such as those that are typically printed in the textile finishing sector. Ink-jet printing (see also Section 2.8.2) seems to be the most appropriate technique in this case because the colour has to be applied to the surface (similar to paper).

Although great improvements have been made in ink-jet printing, production speeds are still low, which prevents this technique from yet replacing traditional analogue printing techniques. Nevertheless it can already offer significant advantages in the production of short runs (typically less than 100 m), where the system losses in analogue printing are often comparable with or can even exceed the amount of paste printed on the fabric.

Urea (for dissolving highly concentrated dyes) and a thickening agent are needed. These auxiliaries cannot be injected through the needles, due to viscosity problems and the reduced size of the needles. Therefore the first operation in the printing process is to cover the substrate (woven or knitted fabric) with the urea and the thickening agent.

After printing, the fabric generally has to be first dried and then fixation takes place. The fabric is then washed and finished.

A suitable set of dyes with affinity for the fabric is required. Companies like Ciba, Dystar and Brookline have developed prints with acid, reactive and disperse dyes. Pigment formulations have also recently been made available.

Main achieved environmental benefits

Dye residues are minimised. The application of the “colour-on-demand” principle means that the printing paste preparation stage is no longer needed. Therefore there are no dye residues and no printing paste preparation tanks to be cleaned at the end of each run. The environmental advantage over conventional analogue printing techniques is particularly noticeable when processing small lots, when the printing paste losses are particularly high for analogue machines.

In pigment printing, the digital technique is even more advantageous because no afterwashing is needed. This means no residues or waste water from the process and also higher productivity. Pigment printing accounts for a large share of printed goods production and the omission of afterwashing makes this technique likely to become rapidly competitive with conventional printing methods.

Operational data

This technique is constantly being improved. However, the current speed of commercial ink-jet textile printing machines is in the range of 20 to 40 m² of fabric per hour.

It should be emphasised that digital printing machines can work 24 h/day and, unlike with analogue printing, no extra time needs to be spent in cleaning operations when changing from one product to another.

Injector maintenance is still crucial.

Cross-media effects

Ink-jet printing is considered a clean technology, but it cannot be considered as such when ink is wasted (continuous ink printing technologies) or when jets are flushed out with solvent to prevent blocking when the printer is not in use.

Applicability

Ink-jet printing is suitable for flat fabrics.

Ink-jet printing is often considered a technique only applicable to the production of samples. However, using digital printing for sampling and analogue printing (screen-printing) for industrial production implies that the sample obtained by digital printing matches the characteristics of the product obtained from analogue printing. This is currently very difficult for various reasons. Therefore the future aim of ink-jet printing in the textile sector is industrial scale production. The problem is that at the current performance speed, the process becomes economically attractive only at runs below 100 m (short runs). In conclusion, the ink-jet technique should be considered as BAT for the production of short runs rather than for the production of samples (with the aim of mass customisation where the sampling machine will be the production machine) [281, Belgium, 2002].

Economics

Information on investment cost was not made available. It is reported that the higher flexibility and promptness in satisfying customer and retailer demands compensate the machine [180, Spain, 2001].

Reference plants

Many plants.

Reference literature

[180, Spain, 2001], [204, L. Bettens, 2000].

4.8 Finishing

4.8.1 Minimisation of energy consumption of stenter frames

Description

Stenters are mainly used in textile finishing for heat-setting, drying, thermosol processes and finishing. It can be roughly estimated that, in fabric finishing, each textile substrate is treated on average 2.5 times in a stenter.

Energy savings in stenters can be achieved by applying the following techniques.

A) Optimising exhaust airflow through the oven

The main energy requirements for a stenter are for air heating and evaporation. It is therefore fundamental that the fabric moisture content should be minimised before the fabric enters the stenter and that exhaust airflow within the oven is reduced.

Water content on the incoming fabric can be minimised using mechanical dewatering equipment such as vacuum extraction systems, optimised squeezing rollers, etc. (the latter is less efficient, but less energy consuming). Up to 15 % energy savings in the stenter (depending on the type of substrate) can be obtained if moisture content of the fabric is reduced from 60 % to 50 % before it enters the stenter.

Exhaust airflow optimisation is another determinant factor. Many stenters are still poorly controlled, relying on manual exhaust adjustment and operator estimation of fabric dryness. For optimum performance, exhaust humidity should be maintained between 0.1 and 0.15 kg water/kg dry air. It is not unusual to find stenters with exhaust humidity of only 0.05 kg water/kg dry air, indicating that the exhaust volume is too high and excessive energy is being used to heat air [146, Energy Efficiency Office UK, 1997]. Energy consumption for air heating can reach up to 60 % of the total energy requirement, if airflow is not monitored [185, Comm., 2001].

Equipment is available (variable-speed fans) which will automatically adjust exhaust airflow according to moisture content of the exhaust air or according to moisture content or temperature of the fabric after the process. A reduction of fresh air consumption from 10 kg fresh air/kg textile to 5 kg fresh air/kg textile results in 57 % energy saving [179, UBA, 2001].

B) Heat recovery

Exhaust heat recovery can be achieved by using air-to-water heat exchangers. Up to 70 % of energy can be saved. Hot water can be used in dyeing. Electrostatic filtration for off-gas cleaning can optionally be installed. Retrofitting is possible.

If hot water is not required, an air-to-air heat exchanger can be used. Efficiencies are generally 50 to 60 % ([146, Energy Efficiency Office UK, 1997]). Approximately 30 % savings in energy

can be achieved [179, UBA, 2001]. An aqueous scrubber alone or with subsequent electrostatic filtration can optionally be installed for off-gas cleaning.

C) Insulation

Proper insulation of stenter encasement reduces heat losses to a considerable extent. Savings in energy consumption of 20 % can be achieved if the insulation thickness is increased from 120 to 150 mm (provided that the same insulation material is used).

D) Heating systems

Direct gas firing is reported to be both clean and cheap. When it was first introduced there was concern that oxides of nitrogen, formed by exposure of air to combustion chamber temperature, would cause fabric yellowing or partial bleaching of dyes. This concern has since been shown to be unjustified [146, Energy Efficiency Office UK, 1997].

However, other sources also show the advantages of new (recently developed) indirect gas firing systems. By means of a flue gas/air heat exchanger the heat generated by the burner flame is directly transferred to the circulating air in the stenter ("Monforts, Textilveredlung 11/12, 2001, p.38"). This system has higher efficiency than conventional indirect heating systems using mainly heating oil. Reactions of off-gas compounds with emissions from the textile materials and auxiliaries (especially generation of formaldehyde) are avoided.

E) Burner technology

With optimised firing systems and sufficient maintenance of burners in directly heated stenters, the methane emissions can be minimised. A typical range for an optimised burner is 10 - 15 g methane (calculated as organic carbon)/h, but it has to be taken into account that methane emissions from burners are strongly linked with actual burner capacity.

Stenters should receive general maintenance by specialised companies at regular intervals. There should also be routine checking of the burner air inlet for blocking by lint or oil, cleaning of pipework to remove precipitates and adjusting of burners by specialists.

F) Miscellaneous techniques

With optimised nozzles and air guidance systems, energy consumption can be reduced, especially if nozzle systems are installed that can be adjusted to the width of the fabric.

Main achieved environmental benefits

Savings in energy consumption and therefore minimisation of emissions associated with energy production are the main environmental advantages.

Data about achievable energy savings are already indicated for some of the presented techniques. Obviously, for existing plants, the potential for reductions will vary according to the existing technology and energy management policy in the company.

Operational data

Minimising energy consumption in the stenters, especially if heat recovery systems are installed, requires adequate maintenance (cleaning of the heat exchanger and stenter machinery, checking of control/monitoring devices, adjusting of burners etc.).

Proper scheduling in finishing minimises machine stops and heating-up/cooling-down steps and is therefore a prerequisite for energy saving.

Heat recovery systems are often combined with an aqueous scrubber or electrostatic filtration systems or a combination of these techniques.

Condensed substances (mainly preparation oils) from heat recovery systems have to be collected separately.

Cross-media effects

None believed likely.

Applicability

All described techniques are applicable to new installations. For existing equipment, the applicability is in some cases limited. For example, improving stenter insulation (see Option C) is not always practicable, although on some older machines, it may be cost-effective to insulate the roof panels. Existing stenters cannot be retrofitted with air-to-air heat exchangers.

Economics

Payback data for heat recovery systems (both air/water and air/air systems) are illustrated in Table 4.35 for drying and heat-setting processes. Information is based on the following reference data [179, UBA, 2001]:

- heat recovery system: counter-flow pipes
- drying temperature: 130°C
- heat setting: 190°C
- off-gas volume flow: 15000 m³/h
- off-gas moisture content (drying): 70 g/m³
- off-gas moisture content (heat-setting): 40 g/m³
- T of the fresh water (before heat recovery): 15°C
- efficiency: 70 %
- heating value of the gas: 9.3 kWh/m³
- cost of the gas: 0.25 euros/m³
- maintenance cost: 1000 euros/yr
- interest rate: 6 %

		1-shift/day		2-shift/day		3-shift/day	
Process		Savings (euros)	Pay-back period (yr)	Savings (euros)	Pay-back period (yr)	Savings (euros)	Pay-back period (yr)
Air/water	Drying	32050	5.7	64150	2.6	96150	1.7
Fresh water T: 15 °C	Heat-setting	34450	5.4	68900	2.4	103350	1.5
Air/water	Drying	18050	12.6	36100	5.9	54150	3.3
Fresh water T: 40 °C	Heat-setting	23350	8.6	46700	3.7	70050	2.4
Air/air	Drying	8000	> 20	16000	15.6	24000	8.5
Fresh air temp.20 °C	Heat-setting	11000	> 20	22000	9.6	33000	6.6

Source: [179, UBA, 2001]

Table 4.35: Return on investment for different processes (textiles drying and heat setting), heat recovery systems (air/water and air/air) and number of shifts per day

The above information does not consider the installation of other measures such as fabric moisture control and exhaust humidity control. If these systems are installed, according to some sources heat recovery may not be cost-effective [146, Energy Efficiency Office UK, 1997].

Driving force for implementation

Minimisation of energy consumption (and therefore costs) is the main reason to retrofit optimised stenter technology.

Reference plants

The described technologies are in use in many finishing mills in Europe and worldwide. The indirect heating system based on flue-gas/air exchanger is currently due to be installed in several finishing plants.

Reference literature

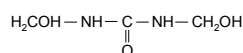
[146, Energy Efficiency Office UK, 1997], [179, UBA, 2001], [185, Comm., 2001].

4.8.2 Formaldehyde-free or formaldehyde-poor easy-care finishing agents

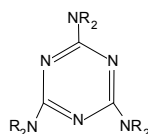
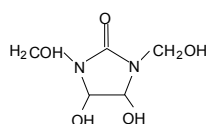
Description

Easy-care finishing is mainly carried out on cellulosic fibres and their blends in order to increase the crease recovery and/or dimensional stability of the fabrics (see Sections 2.9.2.1 and 8.8.1).

Easy-care finishing agents are mainly compounds synthesised from urea, melamine, cyclic urea derivatives and formaldehyde. Cross-linking agents (reactive groups) are composed of free or etherificated N-methylol groups.



Dimethylol urea and Dimethylol urea derivatives

Melamine derivatives (R = H, CH₂OH, CH₂OCH₃)

1,3-Dimethylol-4,5-dihydroxyethylene urea

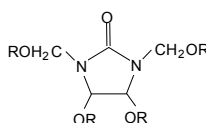
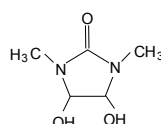
1,3-Dimethylol-4,5-dihydroxyethylene urea derivatives (R = H, CH₃)1,3-Dimethyl-4,5-dihydroxyethylene urea (DMeDHEU)
(1,3-Dimethyl-4,5-dihydroxyimidazolidinon-2; DMDH)

Figure 4.28: Chemical structure of cross-linking agents
[179, UBA, 2001]

Formaldehyde-based cross-linking agents may release free formaldehyde. Formaldehyde is thought to be carcinogenic and is a threat to the workforce (formaldehyde can also be released, for example, during cutting operations). The presence of free formaldehyde or partly hydrolysable formaldehyde on the finished fabric also represents a potential risk for the final consumer. The European Eco-label scheme sets a threshold of 30 ppm for products that come into direct contact with the skin.

Low-formaldehyde or even formaldehyde-free products are an alternative.

Type of cross-linking agent	Formaldehyde release potential
Dimethylol urea	High
Melamine formaldehyde condensation products	High
Dimethyloldihydroxyethylene urea (DMDHEU)	High
Dimethyloldihydroxyethylene urea (DMDHEU) derivatives (most commonly used)	Low
Modified dimethyloldihydroxyethylene urea	Formaldehyde-free
Source: [179, UBA, 2001]	

Table 4.36: Overview of formaldehyde release potential of most important cross-linking agents

Main achieved environmental benefits

With low-formaldehyde or formaldehyde-free products, a reduction of formaldehyde emissions in finishing is achieved. Formaldehyde residues on the textiles can be minimised (<75 mg/kg textile, or even lower than 30 ppm for consumer requirement). With optimised catalysts, curing temperature and therefore energy consumption can be reduced.

If directly-heated stenters are inefficiently maintained, they may also emit formaldehyde in the exhaust air.

Operational data

A typical recipe for low-formaldehyde finishing of cotton (woven fabric) is:

- 40 - 60 g/l cross-linking agent
- 12 - 20 g/l catalyst
- liquor pick-up: 70 %
- drying and condensation (150 °C, 3 min).

A typical recipe for a formaldehyde-free finishing of cotton is:

- 80 - 120 g/l cross-linking agent (integrated catalyst)
- liquor pick-up: 80 %
- acidifying with acetic acid
- drying and condensation (130 °C, 1 min).

Cross-linking compounds are often applied in combination with wetting agents, softeners, products which increase rip-resistance etc.

Cross-media effects

Like the conventional cross-linking agents, the formaldehyde-free alternative products mentioned above are hardly biodegradable. However, as a fundamental rule, the amount of concentrated liquor should be kept to a minimum by small pad-boxes, and residues should be disposed of separately without draining them to the waste water.

Non-optimised formaldehyde-free products can be odour-intensive.

Applicability

In the carpet sector it is always possible to avoid formaldehyde emissions by using formaldehyde-free easy-care finishing agents, whereas in the textile sector the use of formaldehyde-poor agents may be inevitable [281, Belgium, 2002].

The products can be applied similarly to conventional products. The kind and amount of catalyst have to be adjusted, as well as curing time and temperature.

Required quantity of formaldehyde-free products is approximately twice as high as conventional products.

Economics

Prices for formaldehyde-free products are significantly higher than for formaldehyde-low products.

Reference plants

Formaldehyde-free and low-formaldehyde easy-care finishing auxiliaries are supplied by various companies and applied worldwide.

Driving force for implementation

Regulations concerning formaldehyde in the off-gas and compliance with various codes of conduct concerning consumer health (e.g. European Eco-label, etc.) are the main motivation for the use of the formaldehyde-free or low-formaldehyde products.

Reference literature

[179, UBA, 2001], [51, OSPAR, 1994] (P016)

4.8.3 Avoiding batch softening

Description

In batch processing softening agents are often applied after the dyeing process directly in the dyeing machine (e.g. jet, overflow) using the exhaustion method.

Unfortunately, this limits the choice of softening agents to environmentally harmful cationic agents and gives rise to a 10 – 20 % loss of the whole volume of the warm softening bath [78, Danish EPA, 1999].

Alternative techniques are the application of softeners by pad mangles or by spraying and foaming application systems (see Sections 2.9.1 and 2.9.3).

The advantages of these techniques are that the use of cationic softening agents can be avoided and any chemical loss can be reduced to a few percent [78, Danish EPA, 1999].

The amount of residual liquors is also reduced compared with the waste water volume produced by a batch process. In this respect, the best performances are achieved with application techniques such as spraying and foaming, which allow minimum system-losses (residual liquor in the chassis, residual liquor in the pipes and leftovers in the batch storage containers). However, the concentration of active substance is much higher, which makes these liquors not suitable for treatment in a biological system.

Another advantage of applying the softeners in separate equipment after the batch dyeing process is that it is then possible to re-use the dyeing or rinse baths as there is no longer a problem with the presence of residual cationic softeners, which would otherwise limit the adsorption of the dye in the subsequent dyeing process.

Main achieved environmental benefits

Savings in water, energy and chemicals. Introduction of less environmentally harmful softening agents.

Operational data

No information was made available.

Cross-media effects

When softening is done in separate equipment after the dyeing process, the volume of the residual liquor is reduced (limited to system-losses), but the concentration of the active substance is higher. Provided that this concentrated stream is not mixed with the other effluents and sent to a biological waste water treatment, no cross-media effects need to be considered.

Applicability

The technique has general applicability in the textile and carpet sectors.

Economics

Economic benefits can be derived from savings in water, energy and chemicals consumption.

Reference plants

Many plants.

Reference literature

[78, Danish EPA, 1999].

4.8.4 Minimisation of emissions in the application of mothproofing agents

The next three figures (Figure 4.29, Figure 4.30, Figure 4.31) illustrate the baseline processes used by the sector to apply insect resist (IR) agents and identifies the point of application in wet processing and potential points of emission of residual active substance to water. The application method(s) adopted by any manufacturer will depend on the specific yarn production/process sequence used and it is not uncommon to find more than one application procedure in use on one site.

Techniques to minimise the emission of residual insect resist agent may take a number of forms:

- general practices applicable to the majority of processes, for example material handling and storage and selection of the correct application rate
- specific process modifications which include, for example, changes to the chemistry of the process or the substitution of interfering chemicals
- alternative processes such as the use of specialised machinery dedicated to insect resist application. Application at a different point in the carpet manufacturing sequence is also considered under this heading
- on site pretreatment of specific waste water streams – destruction of residual active substance by alkali hydrolysis.

The following discussion first describes general techniques and then specific modifications applicable to each of the three identifiable processing routes for yarn manufacture:

- yarn production by the “dry spinning” route
- yarn production by the “oil spinning” route
- yarn dyed production route.

4.8.4.1 General techniques to minimise the emission of insect resist agent active substance

General techniques to minimise the emission of insect resist agent active substance include: appropriate material handling and dyeing auxiliary selection.

Material handling

The handling of environmentally sensitive materials such as formulated mothproofing agent requires the use of special techniques to minimise spillage during dispensing and transport within the dyehouse. The majority of commercial formulations are supplied as self-emulsifying concentrates- referred to as concentrate, below.

For handling and transfer of concentrate to dyeing machines the following measures should be adopted:

- bulk containers should be transferred to a safe bunded store on receipt
- in the event of a fire, provision to inform the fire authority and sewage treatment undertaker of the presence and nature of the substance should be in place
- concentrate should only be dispensed from bulk containers within the colour store
- automated dispensing systems should be considered to minimise spillage and improve accuracy
- concentrate should not be pre-dissolved in the colour room, but:
- concentrate should be transferred from the colour store to the point of addition to the process in sealed shockproof containers
- concentrate should be added directly to the process liquor only when the dyeing is underway and the dye bath volume is stable (prevents displacement spillage).

For handling concentrate in relation to semi-continuous application the following measures should be adopted:

- concentrate should be stored in the original containers, within a bund and protected from accidental impact
- concentrate should be dispensed directly into the process liquor – stock solutions should not be used
- dispensing should not be a manual operation. Dosing pumps should be used.

Dyeing Auxiliary selection

Some dyeing auxiliaries are known to exert a retarding action on the uptake (exhaustion) of insect resist agents in all dyeing processes. The choice of, for example levelling agent and polyamide blocking agent can significantly affect the final dye bath and rinse residues. These effects are known to depend on both dye liquor pH and auxiliary concentration. Dyeing auxiliaries should therefore be screened for retarding action. Products with a significant retarding action should be substituted, if possible.

Main achieved environmental benefits

The correct timing of additions to the dye bath has been shown to play an important role in reducing overall emissions of IR agent by minimising the spillage of the concentrated treatment liquor at the start of the dyeing process.

A targeted selection of the dyeing auxiliaries allows a reduction of the concentration of mothproofing agent in spent dye bath liquors.

Operational data

Quantification of the impact of the materials handling regime described above on overall mill effluent residues is difficult to assess, but measurements on individual dyeing machines suggest that between 10 and 20 % of the total emissions can arise from liquor spillage.

Cross-media effects

Cross-media effects are believed to be unlikely as regards the adoption of the proposed material handling regime. The choice of auxiliaries should be made taking into account overall effects on the environment.

Applicability

The above techniques are applicable to all installations. However, it should be recognised that substitute auxiliaries with equivalent technical performance are not always available

Economics

Many of the above measures regarding material handling are of low or no cost. Accurate metering and dispensing systems for use in the colour store and as part of a continuous application system are estimated to cost in the range EUR 8000 –16000.

Reference literature

[32, ENco, 2001], [51, OSPAR, 1994], [50, OSPAR, 1997].

4.8.4.2 Specific process modifications to minimise the emission of insect resist agent active substance during yarn production by “dry-spinning route”

Figure 4.29 illustrates the baseline process used for the application of mothproofer to “dry spun” production during fibre wet processing. Insect resist agent is applied in loose fibre dyeing by addition to the dye bath at the commencement of the dyeing. In the baseline process the dye bath and the rinse liquor are discharged to drain and may carry residual agent not taken up by the fibre. Dewatering the dyed fibre using either a centrifuge or with squeeze rollers also generates an additional potential source of residues.

Candidate process modifications with potential to reduce mothproofer emissions in loose fibre dyeing include:

- acid aftertreatment & re-use of the rinse bath
- proportional overtreatment of loose fibre.

4.8.4.2.1 Acid aftertreatment & re-use of the rinse bath

Description

The procedure illustrated in Figure 4.29 combines:

1. acid aftertreatment: dyeing conditions can be modified to incorporate an acidification step at the end of the dyeing cycle. Lowering the dye liquor pH (< 4.0) increases the uptake of mothproofer active substance at the end of the cycle and reduces overall residues.
2. re-use of the rinse bath: reusing the liquor for the next dyeing can eliminate residues from the rinse bath. This approach is only feasible if the machine can be unloaded without emptying the dye vessel or if the machine is equipped with an external liquor storage tank to which the liquor can be transferred between unloading and loading.

Main achieved environmental benefits

Reduction of residues from the dyeing process. Emissions of IR agent active substance are reduced by approximately 90 % when compared with the baseline process.

The example given in the table below illustrates the effectiveness of acid after-treatment.

Waste water source	Approximate waste water volume (l/kg)	Residual permethrin (mg/kg fibre)		Achieved reduction in residues
		Baseline Process	Modified process after-treatment with formic acid	
Dye bath	10	1.5	0.17	
Rinse bath	9	0.38	0.02	
Hydroextractor liquor	0.5	0.6	0.04	
Process total		2.48	0.23	90.7 %
Source: [32, ENco, 2001] Notes: Indicative results from a single dyeing carried out with premetallised dyes Permethrin application rate: 60mg/kg				

Table 4.37: Indicative emissions from loose fibre dyeing

Cross-media effects

None believed likely.

Applicability

The above techniques are applicable to all installations.

It is reported that this mothproofing technique may affect the quality of the product after dyeing [281, Belgium, 2002].

Economics

The aftertreatment process requires additional time to complete, adding an average 30 minutes to a dyeing cycle. Productivity is reduced accordingly and the energy required to maintain the dye bath at elevated temperature increases overall consumption.

Reference plants

Acid aftertreatment is reported to be used extensively by UK industry. A number of installations apply this technique in combination with rinse liquor recycling.

Reference literature

[32, ENco, 2001]

4.8.4.2.2 Proportional overtreatment of loose fibre

Description

This technique utilises the fact that an intimate blend of treated and untreated fibres will be resistant to insect attack providing that the overall blend treatment level is maintained. In practice only a proportion of the fibre is treated, by adding mothproofers at an increased rate to one or more dyeings. The remaining fibre receives no treatment. Mixing of the two fibre types is achieved during mechanical blending.

The technique can be used for the preparation of both solid shades and yarns with mixed colour effects. The ratio of treated to untreated fibre can be varied, but normally between 5 and 20 % of the total blend weight would be treated.

Fewer dyeings are carried out in the presence of mothproofers, but the higher application rates required would under normal circumstances result in higher emissions from those dyeings, which may exceed the emissions arising from the normal production sequence. In practice it has been found that plant using this technique for more than a very small proportion of their production must install some form of dedicated dye liquor re-use system to manage waste water concentrations.

Moreover, both the spent dye liquor and the rinse liquor may need to be re-used, which implies the construction of dedicated machinery, a revised drainage system and the installation of liquor storage tanks. A revision of the dyeing methods and dyestuff / auxiliary selection may be required to minimise colour contamination.

Main achieved environmental benefits

Using a dedicated installation and treating only 5 % of the total fibre blend with insect resist agent is an efficient way of providing protection to a large volume of finished carpet. Estimates of the waste water emissions from such an installation show values of less than 0.2mg active substance/kg fibre, which at a 5 % blending ratio is equivalent to 0.01mg active substance /kg of spun yarn.

Cross-media effects

None believed likely when compared with the baseline process. However, as stated above, the application of this measure alone without dedicated dyeing machinery and waste water recycling systems does not provide sufficient reduction of the emissions of IR agent.

Applicability

The technique can only be adopted on a significant scale by using specially constructed equipment and is not, therefore, applicable to the majority of dyehouses.

Economics

On a self-build basis the cost of constructing a dedicated installation from available materials is said to be in excess of EUR 130000.

Reference plants

One installation is known to exist in the UK. No design or operational details are available.

Reference literature

[32, ENco, 2001]

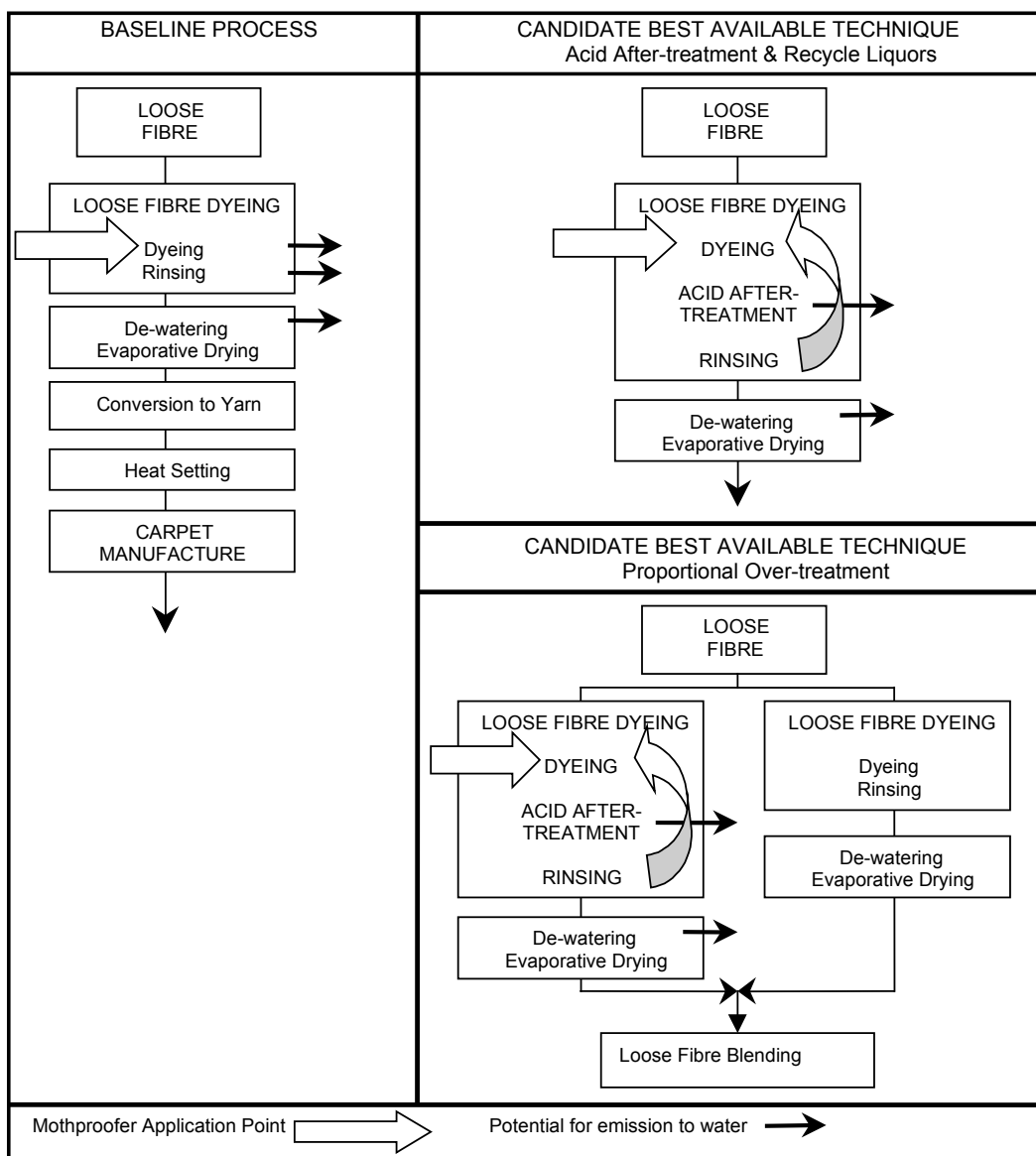


Figure 4.29: Process Map for Mothproofing Dry-Spun Production [32, ENco, 2001]

4.8.4.3 Specific process modifications to minimise the emission of insect resist agent active substance during the treatment of stock dyed-yarn scoured production

Figure 4.30 illustrates the baseline process used for the application of mothproofers to yarn produced by the loose fibre dyeing – yarn scouring route. In the baseline process insect resist agent is applied during loose fibre dyeing. The fibre is then converted to yarn and scoured to remove mill dirt and spinning lubricant.

Emissions of mothproofers arise from the dyeing and rinsing operations and from the yarn scouring operation, as mothproofers are removed from the spun yarn during this operation and concentrates in the scour liquor.

Figure 4.30 indicates that there are three possible alternative modifications to the baseline process that may be applied to reduce mothproofers emissions:

- **Process A:** application of agent from the final bowl of the yarn scour – uses conventional, existing equipment and eliminates emissions at the dyeing stage
- **Process B:** uses dedicated application machinery designed to operate at very low volumes – eliminates emissions from the dyeing process and fugitive emissions from the conventional scour bowl application
- **Process C:** application of the insect resist agent directly to the carpet pile using dedicated foam application machinery – equipment is self contained and can be operated without emissions to water.

4.8.4.3.1 Process A: Application of agent from the final bowl of the yarn scour – uses conventional, existing equipment and eliminates emissions at the dyeing stage

Description

Mothproofers are applied from the final bowl of a conventional yarn scour as a substitute for conventional dye bath application in loose fibre colouration.

Conventional sized scour bowls are used, typically 1200 –2000 litres operating volume. Mothproofers concentrate is metered to the bowl at a rate proportional to yarn throughput. The treatment liquor is acidified to promote adsorption of the active substance, metering of acid is in proportion to throughput. Bowl liquor is discharged when judged to be too contaminated for further use.

Main achieved environmental benefits

A reduction in active substance emissions when compared to the baseline process. Emissions reduction depends on the quantity of yarn that can be treated before the liquor becomes too contaminated to use. Typical emissions figures equivalent to 92mg active/kg yarn have been reported from an installation of this type (*Allanach and Madden, Proceedings of the 9th International Wool Textile Research Conference Vol. 1, 182 -190 (1995)*).

Operational data

This process was used extensively in the UK until the introduction of surface water Environmental Quality Standards in the early 1990's. Strict trade effluent consents, limiting the discharge of mothproofers followed, and operators adopted alternative processing routes, invariably either Process B or Process C described below. In light of this experience the above technique can no longer be considered to represent BAT for application in conjunction with yarn scouring.

Applicability

The technique can be used with any existing yarn scouring machine. A minimum of four scouring bowls is normally required to carry out the scouring, rinsing and mothproofing operation successfully.

Reference literature

[32, ENco, 2001]

4.8.4.3.2 Process B: Mothproof application using dedicated low volume application equipment, incorporating liquor clean-up and re-cycling

Description

Specialised application equipment has been developed to meet many of the shortcomings encountered in Process A above. Minimal operating volume both limits liquor contamination and permits re-cycling of the liquor with intermediate cleaning to remove contaminants. Electronic measurement and process control are used to eliminate fugitive emissions and control mothproof application levels and acidification conditions. Machines of this design are variously referred to as mini-bowl, low volume bowl or EnviroProof installations.

An installation of the type described above is capable of operation in a number of modes:

- liquor storage between yarn batches – discharge to drain when liquor is contaminated
- liquor storage between batches with adsorptive renovation of liquor to eliminate discharge.

Further developments of the low volume application system have taken place in which residual liquor from the hydroextractor is treated with alkali at high temperature. This procedure is applicable to all insect resist agent formulations based on synthetic pyrethroids, which undergo rapid hydrolysis at elevated temperatures. The degradation products from this reaction are several orders of magnitude less toxic to invertebrates than the parent molecule (*Hill, I. R. Pesticide Science. 1989, 27,429-465*) and can thus be safely discharged to drain with other waste water streams.

The above technique has also been adapted to treat the spent bowl liquor in cases where heavy contamination cannot be managed with the adsorptive filter system.

A further variant of the system deals with the hydroextractor liquor by segregation from other effluents, followed by addition to a dye bath. Dark shades are usually chosen to accommodate any slight shade change due to contaminants in the hydroliquor and only 10 - 20 % of the dye bath volume is made up using hydroliquor. Active ingredient present in the hydroliquor behaves in a similar manner to that present in the original formulation and is adsorbed by the fibre under the hot acidic dyeing conditions. Overall residues from this process are of a similar magnitude to those encountered when IR agent is applied from the dye bath.

Main achieved environmental benefits

Dedicated application machinery eliminates emissions from the dyeing process and fugitive emissions from the conventional scour bowl application.

Allanach and Madden (*Proceedings of the 9th International Wool Textile Research Conference Vol. 1, 182 -190 (1995)*) quantified the permethrin release from an installation processing respectively 22 and 92 tonnes of carpet yarn. Both operating modes mentioned above were assessed (1. discharge to drain when liquor is contaminated and 2. adsorptive renovation of liquor to eliminate discharge).

Permethrin released from the installation amounted to 0.97mg/kg in the case of simple multiple batch processing without clean up and 0.23mg/kg for the system running with full clean up and recycling of the process liquor. In both cases a significant proportion of the emissions arose when the treated yarn was hydroextracted prior to evaporative drying.

Cross-media effects

None believed likely

Applicability

Installations of this type may be retrofitted to any continuous yarn scouring machine. Versions of the technology have been adapted for both hank and continuous end to end yarn processing machines.

Economics

Both commercial and self-build versions of the low volume application system described above are known. A commercial installation (EnviroProof) retrofitted to an existing scour line normally includes all the control features associated with chemical dosing and liquor management, together with refurbishment of the final squeeze press of the existing scour. Installation costs are in the region of EUR 185000. The chemical dosing system fitted to these installations is capable of closely regulating application levels in proportion to yarn throughput. As a result, the nominal treatment level can normally be reduced without compromising the insect resistance of the treated yarn. The magnitude of these savings can vary from site to site, but a 50 % reduction is not uncommon, equivalent to a saving of approximately EUR 7.0/tonne of treated yarn.

Equipment for the control and in-plant treatment of hydroextractor residues and highly contaminated liquors using the alkali hydrolysis technique is often assembled on a self build basis to suit local site conditions and space. Depending on complexity, costs are estimated to be upwards of EUR 7000. Treatment costs, excluding energy, are in the region of EUR 1.4/m³

Reference plants

A significant number of plant in the UK use variations of the low volume application techniques described above and their associated spent liquor management systems for the insect resist treatment of yarn in both hank and single end form. Further installations operating similar systems are known to be in operation in Europe and New Zealand.

Reference literature

[32, ENco, 2001]

4.8.4.3.3 Process C: Insect resist application to the carpet pile using foam technology

Description

Figure 4.30 shows that this candidate technique does not form part of the yarn manufacturing process. In this case IR agent is applied directly to the pile of the carpet during the back-coating or latexing operation. Specialised equipment has been developed in which a high-density foam incorporating the IR agent is generated on site and applied to the carpet using a specially profiled application head. This is a continuous process and can be carried out simultaneously with backing/ latexing. The use of foam minimises moisture addition. The foam is generated within a contained area on demand and any rinse water is recycled and used to prepare the next batch of foam. There are no emissions to the mill waste water stream. For the treatment to be

fully effective the active ingredient must penetrate to the base of the carpet pile structure. The density of the pile structure, the foam density and foam blow ratio, controls penetration. Technical aspects of the technology are described by Allanach and Greenwood (*Proceedings of the 9th International wool Textile Research Conference Vol.3,325-332, 1995*)

Main achieved environmental benefits

When operated with a rinse liquor re-use system the process is effluent-free and eliminates the emission of mothproofing active substance to the aquatic environment.

Cross-media effects

None believed likely.

Applicability

The technique relies on application of the mothproofing finish directly to the pile of the carpet and is, therefore, applicable only on sites where the final carpet manufacturing processes are carried out. Commission dyers and sales yarn spinners are unable to make use of this technique. Practical experience indicates that penetration of the foam to the base of the pile may be difficult to achieve with some densely tufted and woven pile structures. The application of a foam to the surface of some pile structures is also known to cause unacceptable changes in the surface appearance of the finished carpet and these effects have to be determined on a case by case basis. In comparison to yarn application techniques a somewhat higher overall application rate is required to ensure that the base of the pile is adequately protected against insect damage. The foam adds moisture to the carpet which must be removed by evaporation, additional drying capacity may be required over and above that required to cure the latex or backcoat.

Economics

Dedicated equipment designed specifically to achieve the level application of foam at a low moisture add-on is required. At the time of writing only one commercially available system has been fully evaluated for insect resist treatment. The equipment can be retrofitted to an existing carpet finishing line if space allows, at a cost of approximately EUR 160000. Depending on the construction of the carpet, additional drying capacity may need to be installed, or alternatively the finishing line may need to be run at a slower speed. Due to the higher required application rate, chemical costs are approximately twice those incurred when a mothproofing finish is applied during yarn wet processing.

Reference plants

The technique is employed by a number of UK and European carpet manufacturers.

Reference literature

[32, ENco, 2001]

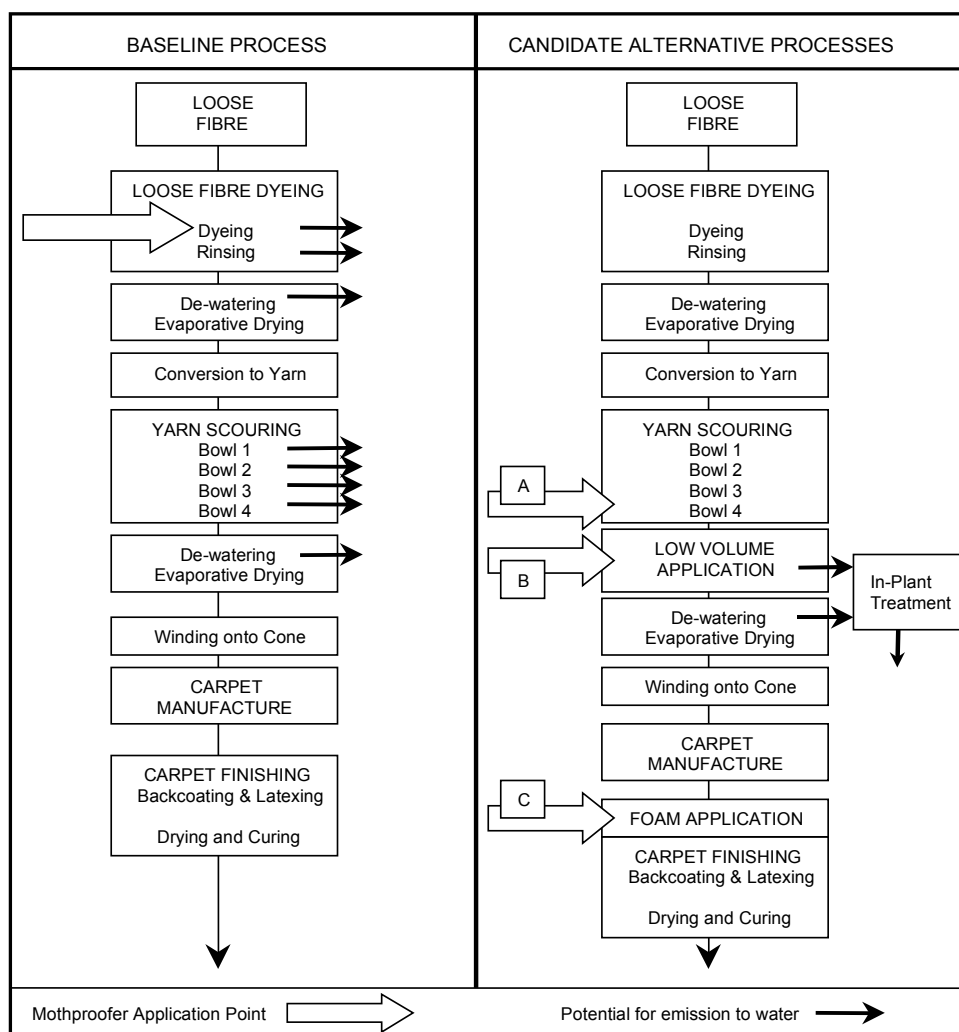


Figure 4.30: Process map for mothproofing stock dyed – yarn scoured production
[32, ENco, 2001]

4.8.4.4 Specific process modifications to minimise the emission of insect resist agent active substance during the treatment of yarn dyed production

Figure 4.31 illustrates the baseline process for the mothproofing of carpet yarn produced via the yarn dyeing route. In this process mothproofing is carried out simultaneously with colouration, the required quantity of agent being added to the dye vessel at the commencement of dyeing.

Active substance is adsorbed by the fibre as the temperature of the dye liquor increases. This adsorptive process reaches equilibrium at the boil, with more than 98 % of the active substance partitioning towards the fibre. The spent dye liquor contains residual active substance at a concentration that depends on dyeing conditions. Acidic dyeing conditions (<pH 4) yield the lowest residues. Dyeing carried out under more neutral conditions, for example, in the case of dyeing with pre-metallised dyestuffs generally result in higher residues in liquors.

The dyeing may be followed by a rinsing cycle, which may also contain residual active substance. In the conventional process both these spent liquors are discharged to the mill's waste water attenuation tank. The liquor expelled during hydrextraction of the dyed yarn may also contain active substance at trace levels.

Emissions from the baseline process depend on a large number of interrelated variables as each dyeing is virtually unique. For practical purposes the pH of the dye liquor can be considered to

have the single most important effect and emission values from a large number of dyeings generally fall in the following range (*Enco Environmental Network, unpublished*):

dyeing at a pH <4	0.1 – 0.4mg/kg yarn
dyeing at a pH >4	2.0 – 7.0mg/kg yarn

Inspection of Figure 4.31 indicates that there are four alternative process modifications (numbered 1 – 4) which are capable of minimising the emission of mothproofers when compared with the baseline process. Two of these alternatives, continuous low volume application (Process 2) and foam application (Process 4) have been described above in the section on minimising emissions from the stock dye – yarn scour yarn production route. The two candidate techniques which are suitable only for the yarn dye production route (Process 1 and Process 3) are described below.

4.8.4.4.1 Process 1. Aftertreatment under acidic conditions

Description

In this process mothproofing is carried out from a separate bath to colouration as an aftertreatment, following rinsing. The aftertreatment bath is acidified to provide optimum conditions for mothproofers uptake.

Main achieved environmental benefits

Treatment is carried out in the absence of any retarding chemicals and at a pH optimal for mothproofers adsorption. Residual active substance loads are typically between 0.1 and 0.4mg/kg.

Cross-media effects

None believed likely.

Applicability

In many dyehouses wool and wool blend dyeing is carried out using a variety of dyeing conditions, dependent on the particular dyestuffs selected to meet end-product requirements. This process is applicable to the mothproofing of yarn that would be dyed under conditions which are not optimised for mothproofers uptake. In practice the technique is used to mothproof yarn when the dyeing conditions specify a liquor pH greater than approximately 5.0.

Economics

The process requires the use of an additional after-treatment bath, equal in volume to the original dyeing. Depending on machine design and yarn load water consumption will lie between 15 and 25 m³/tonne. Additional energy is required to raise the aftertreatment bath to dyeing temperature, together with additional time to complete the lengthened process.

Reference plants

This technique is used in UK dyehouses to minimise emissions from a dyeing that would otherwise yield unacceptably high residues.

Reference literature

[32, ENco, 2001]

4.8.4.4.2 Process 2. Low volume semi-continuous application

Description

The basic technique and equipment are described in the section on mothproofing stock dyed – yarn scoured production. Identical equipment can be employed to treat yarn that is dyed in hank form rather than as loose stock. In this case a stand alone machine may be required consisting of only the low volume application bowl and squeeze press or alternatively the feed to an existing machine installed on the end of a conventional scouring line can be modified to accept hanks between the scour and the low volume application bowl.

In this application contamination of the treatment liquor with residual colour from the previously dyed yarn can be a significant problem and the yarn must be dyed with dyes of good wet fastness.

Main Achieved Environmental Benefit

See previous section (Process B).

Applicability

The technique is applicable where yarn dyeing is carried out with dyes of good wet fastness.

Economics

See previous section (Process B).

Reference plants

One dyehouse is known to mothproof yarn dyed production by this technique, but no detailed information is available.

Reference literature

[32, ENco, 2001]

4.8.4.4.3 Process 3. Application of mothproofer from a modified centrifugal hydroextractor

Description

The technique relies on the use of a modified batch hydroextractor. Centrifugal force is used to transport treatment liquor sprayed into the centrifuge from a centrally located spray head through the yarn load as it rotates. Liquor expelled from the centrifuge is either collected and recycled, or separated from other waste water streams and treated to remove residual active substance. The technique was fully described by Allanach (*Proceedings of the 8th International Wool Textile Research Conference, Vol.4, 568-576,1990*).

Main achieved environmental benefit

A reduction in mothproofer residues discharged to waste water.

Applicability

The technique requires modification of the centrifuge, the centrifuge drainage system and the provision of spent liquor treatment facilities. These may consist of either alkali hydrolysis or a

physical separation technique. The system as originally envisaged used a heated treatment liquor to encourage mothproofing uptake and re-cycling of the treatment liquor between batches. No such installations were ever operated on a commercial basis, but variants of the system have been used. Batch to batch re-use of the liquor can be difficult to implement because of the risk of colour change. The technique is, therefore, not universally applicable and for this reason has not been widely adopted by industry.

Economics

There are no commercially available packages. Modification of an existing centrifuge on a self-build basis and the provision of ancillary equipment is estimated at approximately EUR 30000.

Reference plants

One plant in the UK is known to operate a variant of the process described above, but no details are available.

Reference literature

[32, ENco, 2001]

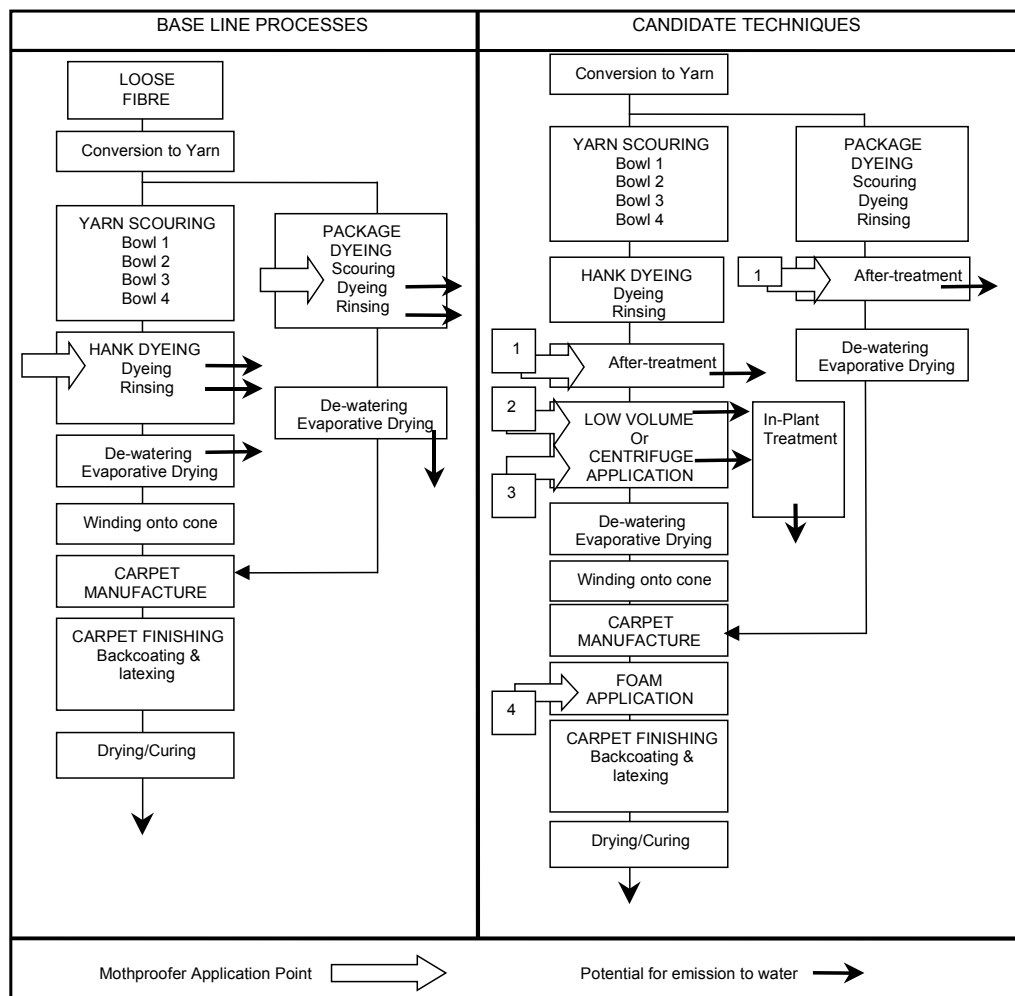


Figure 4.31: Process map for mothproofing yarn dyed production [32, ENco, 2001]

4.9 Washing

4.9.1 Water & energy conservation in batch washing and rinsing

Description

Washing and rinsing are two of the most common operations in the textile industry. Optimisation of washing efficiency can conserve significant amounts of water and energy.

In batch processes, typical washing and rinsing techniques include:

- drain and fill rinsing
- overflow or “flood” rinsing.

In *overflow* rinsing, clean water is fed into the machine and drained through an overflow weir, usually set near the normal running level. This technique is useful for removing the surface scum resulting from poor quality water, chemicals or from inefficient pretreatment, but it is inefficient in terms of water consumption, especially in machines with high liquor ratio.

Better options are:

A) The *drain and fill* method [205, M. Bradbury, 2000]

The drain and fill method is a more efficient technique in terms of water consumption. Here, rinsing is achieved by successive fill, run and drain steps. Among the various factors playing a role in this process, it is worth noting the influence of liquor ratio and draining time on rinsing efficiency, as calculated using the equation below.

$C_f = C_s \times R/L.R.$, where:

- C_f = concentration of solute in the subsequent rinse bath
- C_s = concentration of solute in the previous bath
- R = retention capacity (or carry-over) of the substrate (l/kg)
- L.R. = liquor ratio (l/kg).

From the equation it can be demonstrated that at lower liquor ratios more rinsing steps are required in order to achieve the same dilution effect, but actually using less water. The following example for cotton dyeing with reactive dyes clearly shows this. Considering an exhausted dye liquor containing 60 g/l electrolyte, with a retention capacity of the substrate of 3 l/kg (R) and a liquor ratio of 1:15 (L.R.), the concentration of electrolyte C_f in the subsequent rinse bath after one drain/fill operation will be 12 g/l and after two drain/fill operations will be 2.4 g/l. Conversely, if the liquor ratio is reduced to 1:7, C_f becomes 26 g/l and 11 g/l, respectively, for one and two subsequent rinses.

Moreover, the substrate in the machine retains much of the previous bath, which is expressed by the R parameter (retention capacity). This can be reduced by proper draining (increasing draining times) or, in some batch machines (e.g. yarn package dyeing, stock dyeing), by using compressed air or vacuum blowdown between washing steps.

The main disadvantages of the traditional drain & fill rinsing method are:

- the longer production cycle time, which means lower productivity
- the thermal shock to which the substrate is submitted during the first rinsing
- the deposition of scum on the substrate between rinses as the liquor drains. This means that the removed chemicals or impurities can re-deposit on the surface of the textile material, especially if the machine is re-filled with cold water.

All these limitations have been solved in modern machinery.

As for the cycle time, the machines are equipped with special time-saving devices (power draining and filling, combined cooling and rinsing, full volume heated tanks, etc.), which allows shorter time cycles compared to traditional “overflow” rinsing.

The thermal shock during the first rinsing step can be avoided using the “*combined cooling and rinsing*” system. This is again a common feature of modern machinery, which allows simultaneous cooling and rinsing of the processed textile. Clean water is introduced through the jet/overflow nozzle after it has been preheated by passing it through either the machine’s main heat exchanger or an external high-efficiency plate heat exchanger. The contaminated waste liquor is then drained.

Deposition of scum on the substrate remains a limitation of the drain & fill method. This is why batch dyeing machines are designed to allow rinsing in either the “drain & fill” or the “smart rinsing” mode. The latter, which is described below, is a “controlled overflow” method that can be used for the first rinsing step before switching to the drain & fill mode.

B) “*Smart rinsing*” systems [205, M. Bradbury, 2000]

The use of low liquor ratio machines is a specific requirement for effective use of smart rinsing systems. Rinsing is achieved by feeding clean water into the machine and draining it through an overflow weir set low down in the dyeing machine. In addition, the clean water flow in the machine is regulated at an equivalent rate to that of the liquor draining through the low-level overflow. Compared to traditional overflow rinsing, the dilution effect is increased thanks to the reduced volume of contaminated liquor circulating in the machine. The technique is particularly efficient when hot water is used for rinsing. This can be done in an efficient way by “combined cooling and rinsing”, which allows simultaneous cooling and rinsing of the processed textile as described above.

In this case the final concentration of the solute at the end of the rinsing sequence is given by the following equation:

$C_f = C_s \times \exp(-Rt/V_k)$, where:

C_f = final concentration of the solute
 C_s = starting concentration of the solute
 R = flow rate of incoming fresh liquor (l/min)
 t = rinsing time (min)
 V_k = volume of liquor bath (l).

The liquor ratio is one determinant factor: the higher the liquor volume, the longer is the rinsing time required (and therefore the higher the water consumption) to reach the same dilution effect at the same flow rate. The flow rate R also significantly influences rinsing efficiency. If the rate is reduced, longer rinsing times are needed to achieve the same end point, but this time the water consumption would be unaltered.

Further process optimisation may be achieved by applying systems such as on-line conductivity meters to signal the attainment of a pre-set concentration of salt (when using reactive dyes) or by colorimeters to facilitate rinsing to the optimum end point.

Main achieved environmental benefits

Drain and fill and smart rinsing are both more efficient in terms of water consumption than conventional overflow rinsing.

As far as the drain & fill method is concerned, by replacing each overflow rinse by 2 - 4 "drain and fill" cycles a reduction of 50 – 75 % water consumption can be achieved.

Reduced water consumption also means reduced energy consumption, since hot and warm rinsing steps are often required. In addition, energy savings are obtained with combined cooling and rinsing techniques.

One fundamental feature of both “smart rinsing” and drain & fill compared to the conventional overflow method is that it is possible to keep the exhausted concentrated dye liquor and the rinsing waters as separate streams. This means that they can be re-used or at least treated separately and thermal energy can thus be recovered.

Operational data

As in any productivity improvement, the first step should be a complete audit (and possible upgrading) of utilities to ensure that the benefits of the new equipment can be exploited to the full [205, M. Bradbury, 2000].

Cross-media effects

None believed likely.

Applicability

The adoption of the drain and fill rinsing technique is applicable at a general level to both new and existing equipment, but is more efficient on low liquor ratio machines equipped with the latest time-saving devices (power draining and filling, combined cooling and rinsing, full volume heated tanks, etc.).

The concept of smart rinsing has been developed specifically to solve the problems with fabric rinsing.

Both “smart rinsing” and “rapid drain & fill” systems are now available on virtually all new jet and overflow machines [288, MCS, 2002].

The same is valid for the “combined cooling and rinsing” system. Most of the new dyeing machines have systems (e.g. stock tanks with internal heat exchangers large enough to accommodate the nominal running capacity of the machine) in order to allow simultaneous cooling and rinsing of the fabric.

Economics

“Smart rinsing” and “rapid drain & fill” offer great potential advantages not only in terms of efficient use of water and energy, but also in allowing shorter production cycles, and thereby a reduction in total production costs.

The application of the conventional drain & fill technique, although easy to implement (i.e. no need for investment in new machinery) will not allow shorter production cycle times or an increase in productivity.

Driving force for implementation

Reduction of production cycle time (increase in productivity) without compromising right-first-time performance is the main driving force for the application of this technique.

Reference plants

Many plants world-wide.

Reference literature

[205, M. Bradbury, 2000], [176, VITO, 2001], [288, MCS, 2002].

4.9.2 Water & energy conservation in continuous washing and rinsing

Description

As mentioned in the previous section, most of the finishing processes involve washing and rinsing stages. In continuous operating mode in particular, washing after dyeing, printing, etc. consumes greater quantities of water than the dyeing and printing steps themselves.

Water (and energy) conservation can be achieved by increasing the washing efficiency, but a considerable improvement can often be obtained with the application of simple low-technology (good housekeeping) measures.

A) Water flow control

In practice, mills rarely measure and keep control of water use. Every mill should have water meters that can be installed on individual machines to document water use and evaluate improvements. Significant water reduction has been observed in industry experience after the installation of cheap flow control devices on washers [167, Comm., 2000]. A systematic procedure can be applied aimed at defining the optimum flow needed to achieve the desired level of product quality.

Automatic stop valves that link the main drive mechanism of the range to the water flow can save considerable quantities of energy and water by shutting off water flow as soon as a stoppage occurs. With manual control, the water flow may not be switched off until the machine has stopped for more than 30 minutes [146, Energy Efficiency Office UK, 1997].

B) Increasing washing efficiency

Many factors influence washing efficiency (e.g. temperature, residence time, liquor/substrate exchange, etc.). The techniques applied in modern washing machines depend largely on the type of fabric to be washed, e.g. light or very heavy fabrics, etc. Two basic principles/strategies are applied in modern washing machines: countercurrent washing and reduction of carry-over.

The *countercurrent principle* means that the least contaminated water from the final wash is re-used for the next-to-last wash and so on until the water reaches the first wash stage, after which it is discharged. This technique is relatively straightforward and inexpensive and can be applied for washing after continuous desizing, scouring, bleaching, dyeing or printing [11, US EPA, 1995].

A washer configuration with internal countercurrent (and recycling) capabilities is the vertical counter-flow washer, which sprays recirculated water onto the fabric and uses rollers to squeeze waste through the fabric into a sump, where it is filtered and recirculated. This construction allows for high-efficiency washing with low water use. Energy use decreases greatly because less water must be heated [11, US EPA, 1995].

Reduction of carry over is another fundamental factor. Water (containing contaminants) that is not removed is “carried over” into the next step, contributing to washing inefficiency. Proper extraction between steps is essential. In continuous washing operations, squeeze rollers or vacuum extractors (more efficient) are used to reduce drag-out and carry-over [11, US EPA, 1995].

Wash boxes with built-in vacuum extractors are available for purchase as well as after-printing washers that combine successive spray and vacuum slots without any bath for the fabric to pass through [11, US EPA, 1995].

C) Introduce heat recovery equipment

Installing heat recovery equipment on a continuous washer is usually a simple but effective measure, since water inflow and effluent outflow are matched, eliminating the need for holding tanks. The effluent from these machines can become contaminated with fibrous material, so it is important to install heat exchangers capable of handling such loads (e.g. self-cleaning elements) [146, Energy Efficiency Office UK, 1997]

Main achieved environmental benefits

All measures described contribute to overall reduction of water and energy consumed. In order to allow full exploitation of the benefits achievable with the new advanced washing machinery, the implementation of the low-technology measures is fundamental.

Operational data

The table below shows the achievable water consumption levels for washing cotton and viscose woven fabric and their blends with synthetic fibres. The values for the different processes are additive and were submitted by machine manufacturers and confirmed by some finishing mills.

It is worth pointing out that the achievable performances are influenced by the degree of implementation of complementary techniques. Low water consumption levels can only be achieved by synergistic combination of different possible measures, from the preparation of the fabric through the process chain (e.g. low add-on application techniques for sizing agents, selection of dyes with good washing off properties, etc.)

	Water consumption (l/kg)	
	TOTAL	of which HOT WATER
Pretreatment Processes		
Washing for desizing	3 - 4	3 - 4
Washing after scouring	4 - 5	4 - 5
Washing after bleaching	4 - 5	4 - 5
Washing after cold bleaching	4 - 6	4 - 6
Washing after mercerisation		
- Washing to remove NaOH	4 - 5 (hot)	4 - 5
- Neutralisation without drying	1 - 2 (cold)	n/a
- Neutralisation and drying	1 - 2 (warm)	<1
Washing after dyeing		
Reactive dyestuffs	10 - 15	4 - 8
Vat dyestuffs	8 - 12	3 - 7
Sulphur dyestuffs	18 - 20	8 - 10
Naphtol dyestuffs	12 - 16	4 - 8
Washing after printing		
Reactive dyestuffs	15 - 20	12 - 16
Vat dyestuffs	12 - 16	4 - 8
Naphtol dyestuffs	14 - 18	6 - 10
Disperse dyestuffs	12 - 16	4 - 8
Source: [179, UBA, 2001]		

Table 4.38: Achievable specific water consumption levels for continuous washing processes during finishing of open width woven fabric consisting of cotton or viscose and their blends with synthetic fibres

Cross-media effects

Highly intensive and efficient washing techniques with low water consumption require intensive mechanical washing conditions such as spraying and sucking, which may require somewhat higher electricity consumption. However, this is largely offset by energy savings achievable by implementing thermal energy recovery measures that are also part of the described measures [179, UBA, 2001].

Applicability

The achievement of performances typical of highly efficient washing machines requires investment in new equipment. However, the application of low-technology measures such as flow control devices, automatic valves, etc. can also produce some reduction in water and energy consumption.

Economics

Detailed information was not made available. In order to indicate the order of magnitude, a continuous IPPC-capacity preparation line for cotton fabric, allowing for minimal water consumption (9 l/kg in total, including odour removal and lint filtration) by combined application of various technical optimisation measures, costs 2.5 million euros [247, Comm., 2001].

Driving force for implementation

The main driving forces for the implementation of the described techniques are the increasing cost of water supplies and waste water treatment, and the desire for increased productivity (in the case of new highly efficient washing machinery).

Reference plants

Many plants.

Reference literature

[167, Comm., 2000], [179, UBA, 2001], [11, US EPA, 1995], [146, Energy Efficiency Office UK, 1997]

4.9.3 Use of fully closed-loop installations for fabric washing (scouring) with organic solvent

Description

Continuously operating solvent scouring installations for open-width fabrics have been known since the late 1960s. They have been used by the textile finishing industry in different production sectors for over thirty years mainly because of the advantages of organic solvents over water in solving technical and qualitative problems related to fabric cleaning.

The specific heat of PER (the solvent most commonly used) is about 1/5 of that of water and the latent heat of evaporation is over 10 times lower, resulting in about 90 % reduction of the total heat requirement for evaporation in favour of PER. This means much faster and cheaper evaporation with significant savings in time and energy during drying.

The lower surface tension of PER results in a quicker and deeper fibre impregnation, thereby making any cleaning or finishing treatment more complete and uniform.

Nevertheless, the application of PER requires extreme care and sophisticated techniques for reducing and minimising its harmfulness potential for the environment and humans.

The following gives an insight into the features of the new generation of technologically advanced solvent treatment installations compared to the traditional ones.

In general terms, the components of a typical installation of the 1970s, schematically represented in the diagram below (see Figure 4.32), are:

- S. scouring unit
- D. drying unit
- C. cooling section

Solvent recovery equipment:

- LR liquid recovery / sludge disposal (1 distillation, 2 condensation, 3 water separation, 4 solvent tank)
- GR gaseous recovery (5 open-loop active charcoal filters)

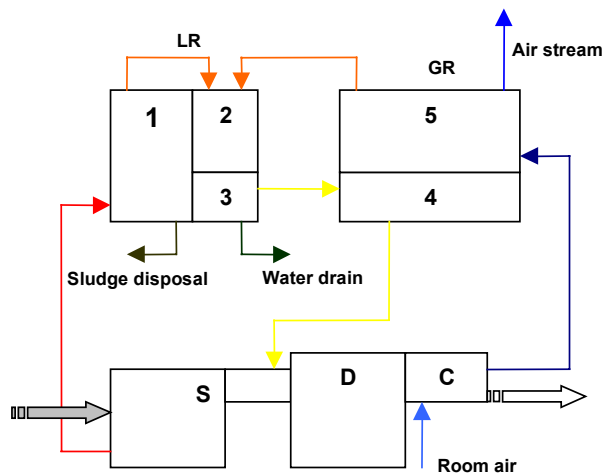


Figure 4.32: General layout of a conventional solvent scouring installation [197, Comm., 2001]

The components of a typical modern installation, schematically represented in the figure below, are:

- S. scouring unit
- D. drying unit
- C. cooling section

Solvent recovery equipment:

- LR liquid recovery / sludge disposal (1 main distillation, 2 sludge distillation, 3 condensation, 4 water separation, 5 solvent tank)
- GR gaseous recovery (6 closed-loop active charcoal filters)
- W. water treatment:
- WD decantation
- WS air stripping
- WA charcoal absorption

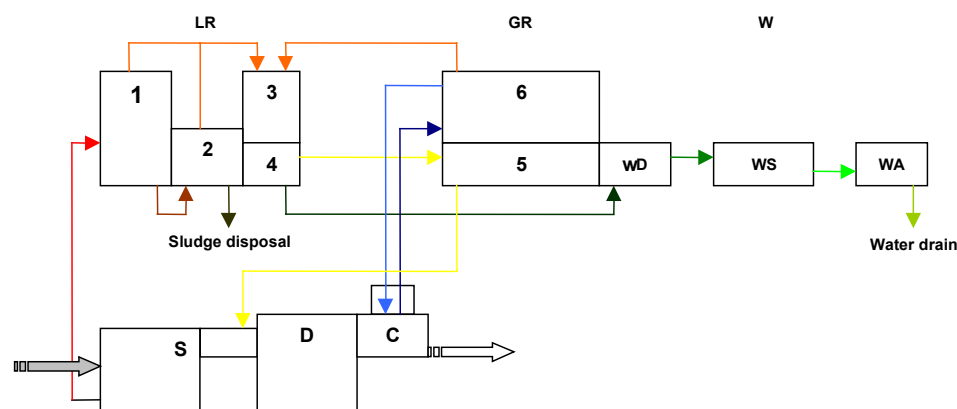


Figure 4.33: General layout of a modern solvent scouring installation
[197, Comm., 2001]

The following solutions to main emission and pollution sources have been developed in the new generation equipment.

Air emissions (Outside atmosphere)

Problem

Open-loop active charcoal filters used for the purification of the air stream release to the outside atmosphere between 500 and 1000 g/h PER, depending on the equipment size (at a solvent concentration in the region of 500 - 600 mg/m³).

Solution

The new installations are fitted with closed-loop active charcoal filters. The exhaust duct has been eliminated and the purified air is now recycled to the fabric deodorising / cooling section of the machine: this avoids any air-stream exhaustion to the outside environment.

Moreover, with the closed-loop filters it has been possible to re-design more efficient sealing systems at the machine inlet and outlet sides with consequent benefits for the workplace as well.

Water emissions

Problem

The so-called “separation water” produced by the solvent recovery system with an average flow of about 0.5 m³/h and a content of PER of between about 150 and 250 g/m³, gives rise to an emission of 75 - 125 g/h PER. This effluent used to be drained to the sewer (in the worst case), or to the central waste water treatment plant. Since the solvent is not biodegradable, once it reaches the aquifer it accumulates, and lasts indefinitely.

Solution

A built-in, dedicated piece of equipment is now available to pretreat, extract and recover most of the water-dissolved PER, through a two-stage process involving:

1. stripping by means of an air-stream
2. absorption through active charcoal cartridges, periodically changeable and rechargeable.

Again, the closed-loop active charcoal filters are involved in purifying the polluted air-stream from the 1st stage and recovering the extracted solvent.

The system is able to ensure a residual PER content into the draining water not higher than 1 mg/l (emission in the water \leq 0.5 g/h PER).

Nevertheless, since the water flow is fairly low ($\leq 0.5 \text{ m}^3/\text{h}$) advanced oxidation processes (e.g. the Fenton process) are suitable for treating such low water flows on site [281, Belgium, 2002].

Apart from the above-mentioned contact-water drain, a solvent installation, either old or new, does not generate any other water effluent.

Waste

Problem

The high water content and the over 5 % by weight residual PER concentration in the sludge makes this waste difficult to manage at mill level and undesirable to most collectors. Landfilling creates soil or aquifer contamination, and PER may still be released to atmosphere in landfill gas. It is possible that implementation of the Directive 99/31/EC on the landfill of waste may prevent this material being landfilled in the future.

Solution

The complete redesign of the main distilling group (of the “forced circulation” type) and, particularly, the redesign of the sludge distiller (of the “thin layer evaporator” type), has drastically reduced the solvent residue in the sludge well below 10000 mg/kg (1 %), producing a dry, thick waste. This reduces collection and disposal problems and cost.

Working environment

Problem

Solvent remains absorbed on fibres and this has been evaluated to be in the range of 0.1 - 1.0 %. Emission of this solvent to the surrounding environment is difficult to control. This also influences the air-stream quality from the drying / heat-setting machines exhaust ducts.

Solution

The sealing systems at the machine inlet and outlet sides have been redesigned to further improve the solvent vapours pick-up efficiency. This results in a much safer environment and better preservation of human health. A typical TLV-TWA value all around the installation is now no higher than 50 mg/m³.

As a whole, the total solvent consumption of the solvent treatment installation has been reduced from the 3 – 5 % (by weight of fabric produced) typical of traditional equipment to 0.8 - 1.5 %. Further improvement is likely in the near future.

Main environmental benefits

The environmental benefits of scouring with organic solvent lie essentially in the following points:

- reduction of both water and energy consumption, due to the dry-to-dry processing and to the heat requirement for solvent evaporation compared to water
- reduction in auxiliary usage (e.g. surfactants used as detergents, emulsifiers, etc). A high amount of auxiliaries is needed for difficult-to-remove preparation agents such as silicone oils present on elastane fibres and their complete removal with water washing is not possible. As a result the remaining preparation agents are released to the exhaust air from stenters in the subsequent thermal treatments
- reduction of the organic load sent to the waste water treatment plant (the impurities are disposed of in a concentrated form as sludge).

Cross-media effects

Organic halogenated solvents are non biodegradable and persistent substances. Unaccounted losses from spills, scouring-unit filters, fabric, etc. may give rise to diffuse emissions, resulting in groundwater and soil pollution. In the UK, municipal water abstraction has been stopped

from aquifers contaminated in this way and compensation claims can threaten companies' economic viability.

Moreover, textiles treated with perchloroethylene have a potential to release it in the later thermal treatments. In directly heated stenter frames, dioxins and furans may be formed. In Germany legislation forbids treating textile substrates which have been pre-cleaned with PER in directly heated stenters or comparable equipment. High emissions of PER, in the exhaust gas (0.1 – 0.8 g PER/kg of textile substrate and emission mass flows of up to 0.3 kg PER/h) have been observed in some installations, thereby creating difficulties in meeting the emissions limit values [280, Germany, 2002].

As far as the problem of the solvent retention by the fibres is concerned, studies and experimentation are in progress, which aim at reducing the solvent content basically by means of a final fabric treatment under heat and moisture conditions. It seems that the solvent abatement level in the fabric can reach over 90 %.

Applicability

Solvent treatments of textiles includes all those applications where the solvent (PER) is able to perform better than water, particularly in terms of solvency power of hydrophobic substances. The cleaning treatment of loom-state fabrics as a preparation for dyeing or printing is the most typical application of this technique, provided that some hydrophilic (water-soluble) substances, such as warp sizing agent, are not present as well.

The main application of solvent is for knitted fabrics, particularly in man-made fibres.

In the particular case of elastic knits (elastane blended fibres), the solvent pretreatment is particularly indicated because it is able to remove efficiently the silicone oils contained in the elastomeric fibres while conferring optimal shrinkage properties. Thanks to those features, solvent scouring is often extended to the cotton/elastane blends as well.

In woven fabrics processing, scouring of loom-state wool cloth, both grey and tops/yarn dyed, either worsted or woollen, is widely used provided that sizing agents are not present.

More recent production of wool elastic fabrics (elastane/wool and wool-polyester blends) requires an after-dyeing solvent treatment to increase the fabric colour fastness.

Particularly in case of woollen fabrics, solvent scouring can be combined with aqueous carbonising in a single processing line (see Section 2.6.2.1).

Economics

The following tables attempt to evaluate the economic aspects of the solvent system by comparing it with the aqueous system in a parallel operation with the same fabric quality and at the same production rate.

Two fabrics with the same fibre composition and different construction (one knitted and one woven) have been selected, both in the range of medium-light weight (240 g/m) thus allowing the two systems to produce about 0.8 tonnes/hour each at the same speed of 55 metres/minute.

Since all the machines in the two systems have a nominal production capacity up to 1 tonne/hour, the comparison has been made at 80 % efficiency.

Both systems comprise a washing installation and a heat-setting installation, but:

- the aqueous process uses heat-setting for drying as well
- the solvent process, including a built-in drying unit, uses heat-setting for this purpose only.

The consumption figures have been taken from the technical characteristics supplied by the relevant machinery manufacturers (Sperotto Rimar Spa for the solvent installation and Santex AG for the washing range and the stenter-frame).

Consumption/h		Aqueous system			Solvent system		
Utilities	Unit	Washer	Stenter	Total	Solvent washer	Stenter	Total
Labour	h	1	1	2	1	1	2
Electricity	KW/h	94	158	252	81	158	239
Thermal energy	MJ/h	2160	6669	8860	2282	4867	7149
Steam	kg/h	950	2940	3890	1000	2130	3130
Water supply	m ³ /h	8		8	23 ⁽¹⁾		23 ⁽¹⁾
Waste water	m ³ /h	8		8			
Detergent	kg/h	16		16			
PER	kg/h				8		8
Sludge	kg/h				16		16

Source: [197, Comm., 2001]
(1) cooling water, fully recoverable 40 – 45 °C

Table 4.39: Consumption data: aqueous system and solvent system

Running costs/h		Aqueous system			Solvent system		
Utilities	euros/unit	Washer	stenter	Total	solvent washer	stenter	total
Labour	16/h	16.00	16.00	32.00	16.00	16.00	32.00
Electricity	0.10/kWh	9.40	15.80	25.20	8.10	15.80	23.90
Steam	0.03/kg	28.50	88.20	116.70	30.00	63.90	93.90
Water supply	0.30/m ³	2.40		2.40	6.90		6.90
Waste water	0.78/m ³	6.24		6.24			
Detergent	1.55/kg	24.80		24.80			
PER	0.40/kg				3.20		3.20
Sludge	0.78/kg				12.48		12.48
Total	euros/h	87.34	120.00	207.34	76.68	95.70	172.38

Source: [197, Comm., 2001]

Table 4.40: Hourly cost figures: aqueous system and solvent system

The thermal energy consumption figures have been calculated from the heating capacity performance and expressed as steam consumption for an easier cost determination.

The detergent usage for the aqueous system and the PER consumption for the solvent system are classified as “chemicals” consumption.

The water purification for the aqueous system corresponds broadly with the sludge disposal for the solvent system.

As stated earlier, the water supply in the solvent system is used for cooling purpose only and can be fully recovered, unpolluted, to be re-used in the dyehouse or even recycled in the solvent installation after suitable cooling.

The unit costs are based on current prices in Italy, although they fluctuate over time and vary with textile type. Local prices can easily be substituted.

The disposal cost for the sludge is compensated by the savings achievable in:

- heating energy (steam)
- total water (supply + purification)
- chemicals (detergent v/s PER)

On the whole, the solvent system can ensure a total saving of about 17 %, that is 35 euros/working hour.

The high investment cost is sometimes a disincentive, but has a short payback period (usually no longer than 2 - 3 years), particularly for medium-large installations and big companies with an annual production of at least 3000 tonnes of fabric [197, Comm., 2001].

Reference plants

It is estimated that at least 200 plants, either old or new, are presently operating world-wide [197, Comm., 2001].

Driving force for implementation

Reducing air emissions of pollutants seems to be, at the moment, the priority for an investment decision. Second are market requirements, as new textile products are developed, creating the need for solvent systems development. Running cost reductions are also a factor.

Reference literature

[197, Comm., 2001] with reference to:

“Paolo Zanaroli, Sperotto Rimar S.p.A., Malo, Italy; Optimisation of wool cloth processing with solvent: scouring and carbonising in perchloroethylene - Proceedings of the Aachen Textile Conference, November 1997, pages 417 – 424”

4.10 Final effluent/emission abatement techniques

4.10.1 Treatment of textile waste water in activated sludge system with low food-to-micro organisms ratio (F/M)

Description

Aerobic biological treatment techniques are widely used to treat mixed textile waste water. In most cases, complete-mix activated sludge systems are used. The description and performance of this type of technique is treated in detail in another BREF ([196, EIPPCB, 2001]).

Textile waste water is a mixture of many different chemical compounds which can roughly be classified into easily biodegradable, hardly biodegradable (recalcitrant) and non-biodegradable compounds. In activated sludge systems, easily biodegradable compounds are mineralised, whereas hardly biodegradable compounds need special conditions, such as low food-to-mass-ratios (F/M) ($< 0.15 \text{ kg BOD}_5/\text{kg MLSS} \cdot \text{d}$, or even < 0.05 for mineralisation below optimum temperatures), adaptation (when the compounds are discharged very regularly) and temperature higher than $15 \text{ }^\circ\text{C}$ (which is normally the case for textile waste water).

F/M is the most relevant design parameter. If they remain under the mentioned F/M value, hardly biodegradable chemicals, such as nitrilotriacetate (NTA) (“GDCh, 1984”), m-nitrobenzene sulphonate and its corresponding amine (“Kölbener, 1995”), polyvinyl alcohol (PVA) (“Schönberger, 1997”) and phosphonates (“Nowack, 1998”) are degraded and mineralised.

Today, many activated sludge systems meet these system conditions (see following examples), which also enables almost complete nitrification. In these conditions, both readily and hardly biodegradable compounds can be degraded. On the contrary, effluents containing non-biodegradable compounds should be treated/pretreated at the source (see Section 4.10.7), but this is done only in a few mills. In most cases, in addition to activated sludge further treatment

steps are carried out, such as flocculation/ precipitation, coagulation/adsorption/precipitation, adsorption to activated carbon and ozonation.

Other techniques combine the biological degradation process with physical adsorption, coagulation and advanced oxidation processes. These techniques are described in Section 4.10.3.

Plant 1:

The treatment plant receives municipal waste water and effluent from four large textile finishing mills. The textile waste water is equalised and then mixed with primarily treated municipal waste water. The textile waste water accounts for about 45 % of the hydraulic load and about 60 % of the COD load. After primary treatment and equalisation, there is a biological treatment, including nitrification/denitrification and flocculation with $FeCl_3$ as final step ($FeCl_3$ has the disadvantage of introducing additional chloride ions in the system, which are a source of corrosion problems). The system can be seen from Figure 4.34 while Figure 4.35 shows the daily measured average COD concentration of the final effluent. The values vary within a significant range, reflecting fluctuations during the week, rainy days (because storm water enters the same sewer) and holiday time (very low values are recorded at the end of August which is the holiday time for companies).

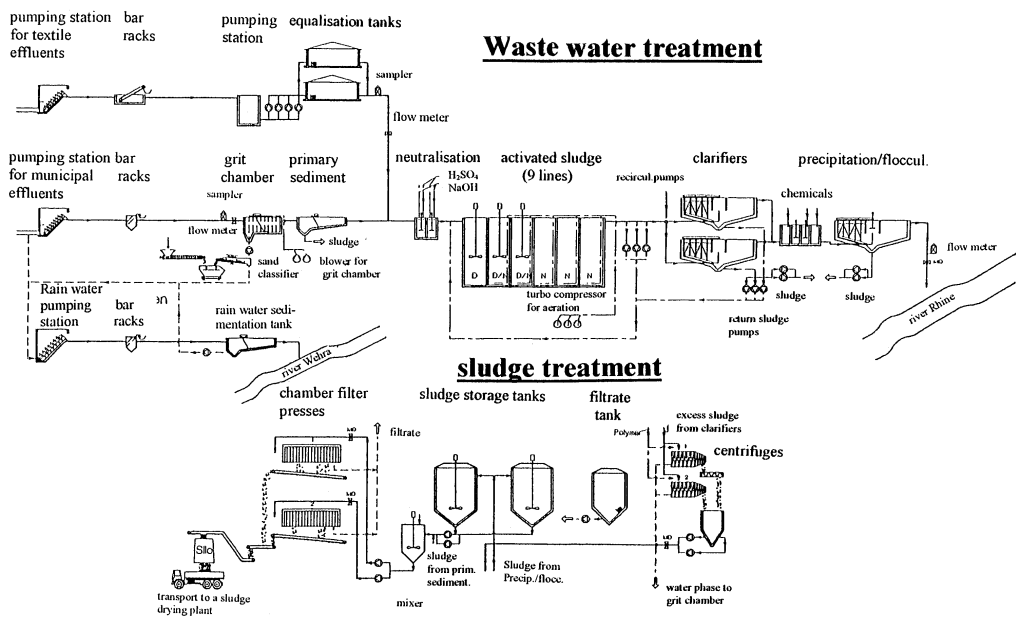


Figure 4.34: Plant 1 – combined treatment of textile effluent and municipal waste water [179, UBA, 2001]

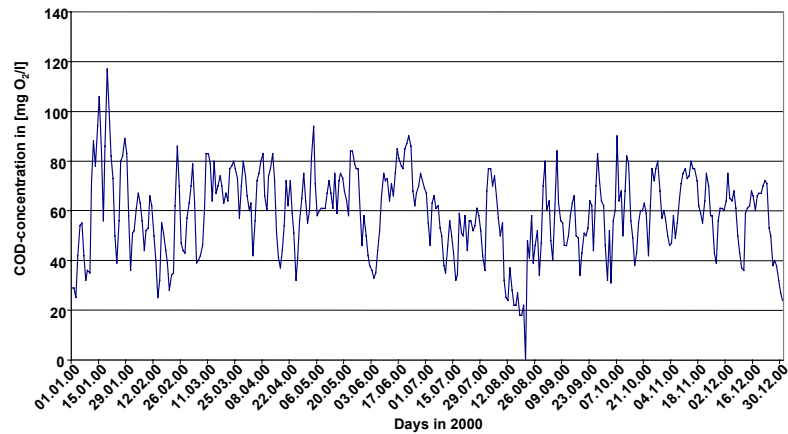


Figure 4.35: Daily average COD concentration measured on the final effluent from Plant 1 in the year 2000
[179, UBA, 2001]

Plant 2:

In this big plant, waste water from two cities and some villages is treated together with textile waste water from four large textile finishing industries which accounts for about 40 % of the hydraulic load and about 65 % of the COD load. Municipal waste water and textile waste water are already mixed in the public sewer. Figure 4.36 shows the layout of the plant. The tanks for primary treatment are also used for equalisation of the incoming waste water. After the activated sludge treatment, no additional treatment is applied for further reduction of organic compounds and colour. The daily variation of the COD-load at the outlet of the plant can be seen from Figure 4.37. There are high peaks which result from high flows of storm water. In such conditions, retention time is reduced and removal efficiency is therefore also reduced. As in example Plant 1, during holiday time in the industry (August), residual COD load is significantly lower.

Legend:

- 1: Influent pumping station
- 2: Bar screen
- 3: Aerated grease and grit chamber
- 4: Venturi flow measurement
- 5: Primary treatment and equalisation
- 6: Intermediate pumping station
- 7: Activated sludge tanks
- 8: Clarifiers
- 9: Return sludge pumping station
- 10: Primary sludge pumping station
- 11: Pumping station for discharging the treated effluent
- 12: Sludge thickener
- 13: Anaerobic digesters
- 14: Gas holding tank
- 15: Operation and administration building
- 16: Machinery building
- 17: Blower house
- 18: Gas motors building
- 19: Sludge container hall
- 20: Bunker for fatty wastes
- 21: Overflow in case of emergency

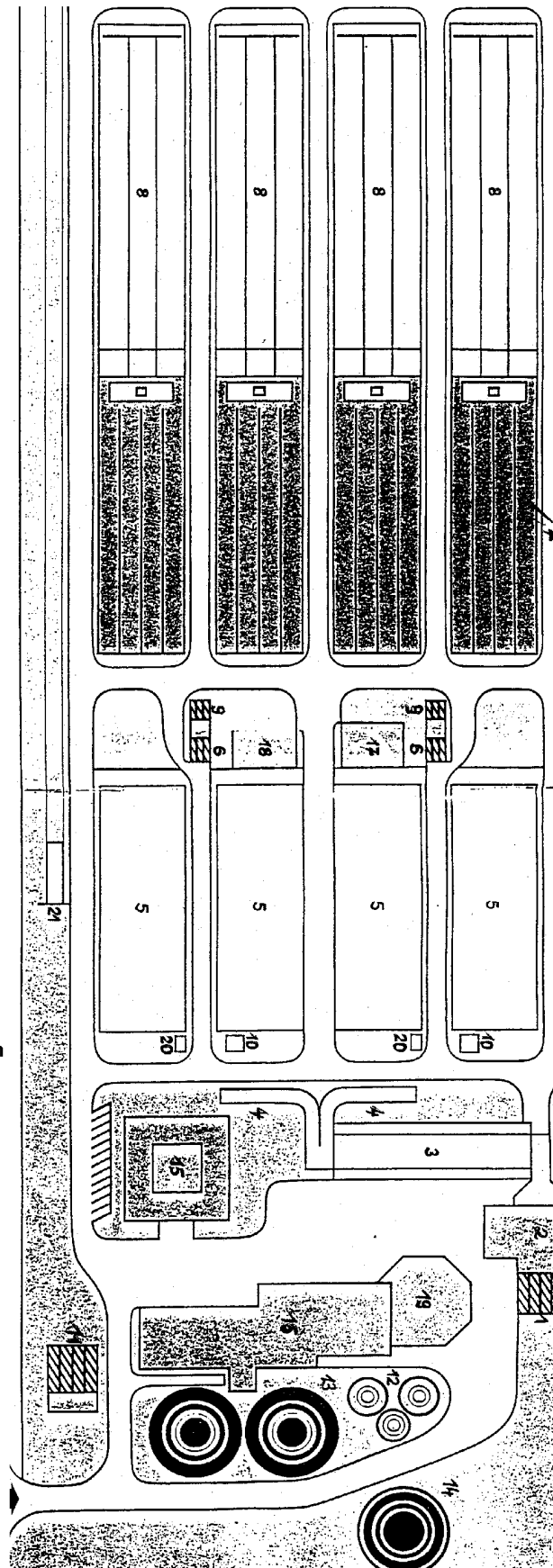


Figure 4.36: Plant 2 – combined treatment of textile effluent and municipal waste water [179, UBA, 2001]

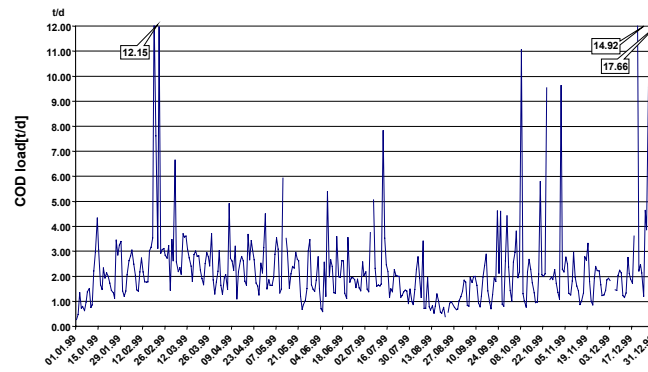


Figure 4.37: Daily average COD load measured on the final effluent from Plant 2 in 1999 [179, UBA, 2001]

Plant 3:

This example also features combined treatment of municipal and textile waste water. The layout of the plant is shown in the next figure. The neutralised and equalised waste water of a big textile company is discharged to the treatment plant by a separate sewer. The water is specially pretreated in a high-loaded activated sludge system with F/M 1.1 kg BOD₅/kg MLSS · d. Under these conditions PVA, which is present at high concentration in the textile waste water, is not degraded at all. More than 90 % PVA removal is achieved in the subsequent (second) activated sludge stage having F/M 0.05 kg BOD₅/kg MLSS · d.

Ozonation of textile waste water reduces colour significantly, but COD is reduced only very slightly (< 10 %) because of low ozone dosage (about 50 g/m³). However, it is postulated that biodegradability is increased. Activated carbon treatment is added only where the standards are breached, which has not happened in the past three years. Flocculation /filtration as a polishing step reduces COD to 10 – 20 % and removes some colour as well.

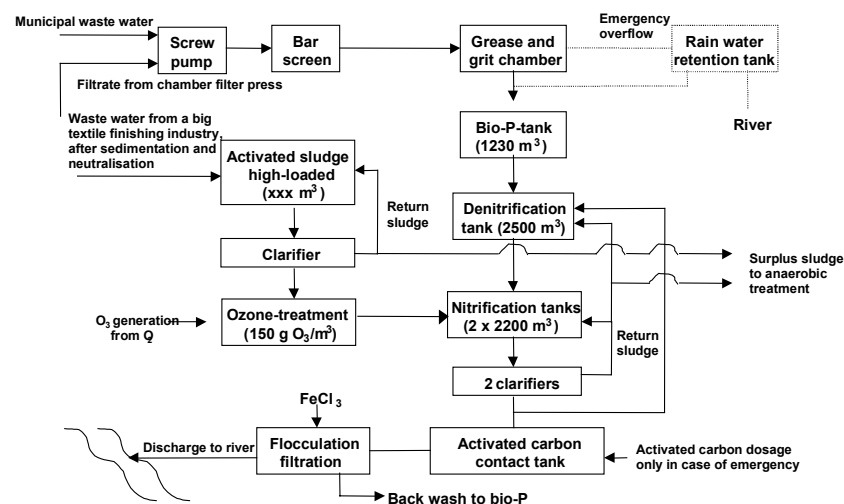


Figure 4.38: Plant 3 – combined treatment of textile effluent and municipal waste water [179, UBA, 2001]

Plant 4:

This large plant is for the treatment of waste water from about 150 textile units. Textile waste water accounts for about 55 % of the hydraulic load, municipal waste water for about 23 % and infiltration and storm water for the remainder. The layout of the plant is shown in the following figure.

After biological treatment including nitrification/denitrification, the mixed waste water is precipitated/flocculated for further COD reduction. The effluent is subsequently treated with ozone in order to remove colour and recalcitrant surfactants. The F/M ratio is higher than 0.15 kg BOD₅/kg MLSS · d, which means that complete nitrification cannot be achieved and hardly degradable compounds may not be removed to as high an extent as with a lower F/M ratio.

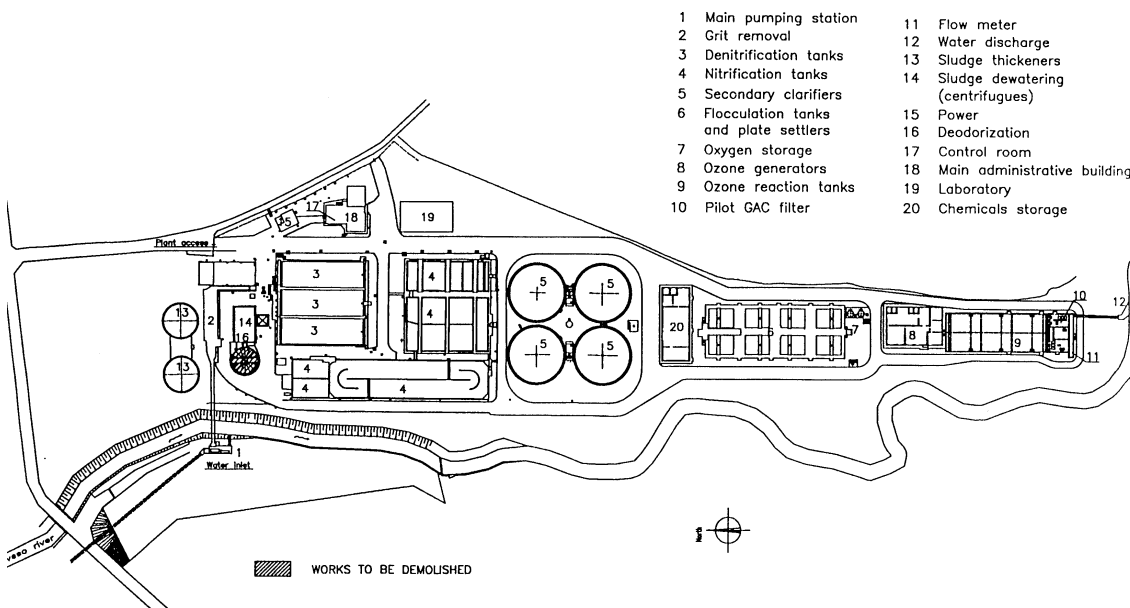


Figure 4.39: Plant 4 – combined treatment of textile effluent and municipal waste water [179, UBA, 2001]

Plant 5:

In plant 5, the waste water from one textile finishing industry is treated. The company mainly finishes cotton fabric, including pretreatment (desizing, scouring, bleaching), dyeing (cold pad batch and exhaust dyeing), printing (mainly with pigment printing pastes) and finishing. About 5 % of the treated waste water is recycled for washing and cleaning operations (floor washing, cleaning of printing equipment such as pumps, pipes, squeegees and screens). Retention time in the activated sludge system is very high. Decolourisation is achieved through reductive cleavage of azo groups of dyestuffs by an iron(II)-salt. Figure 4.40 shows the layout of the plant.

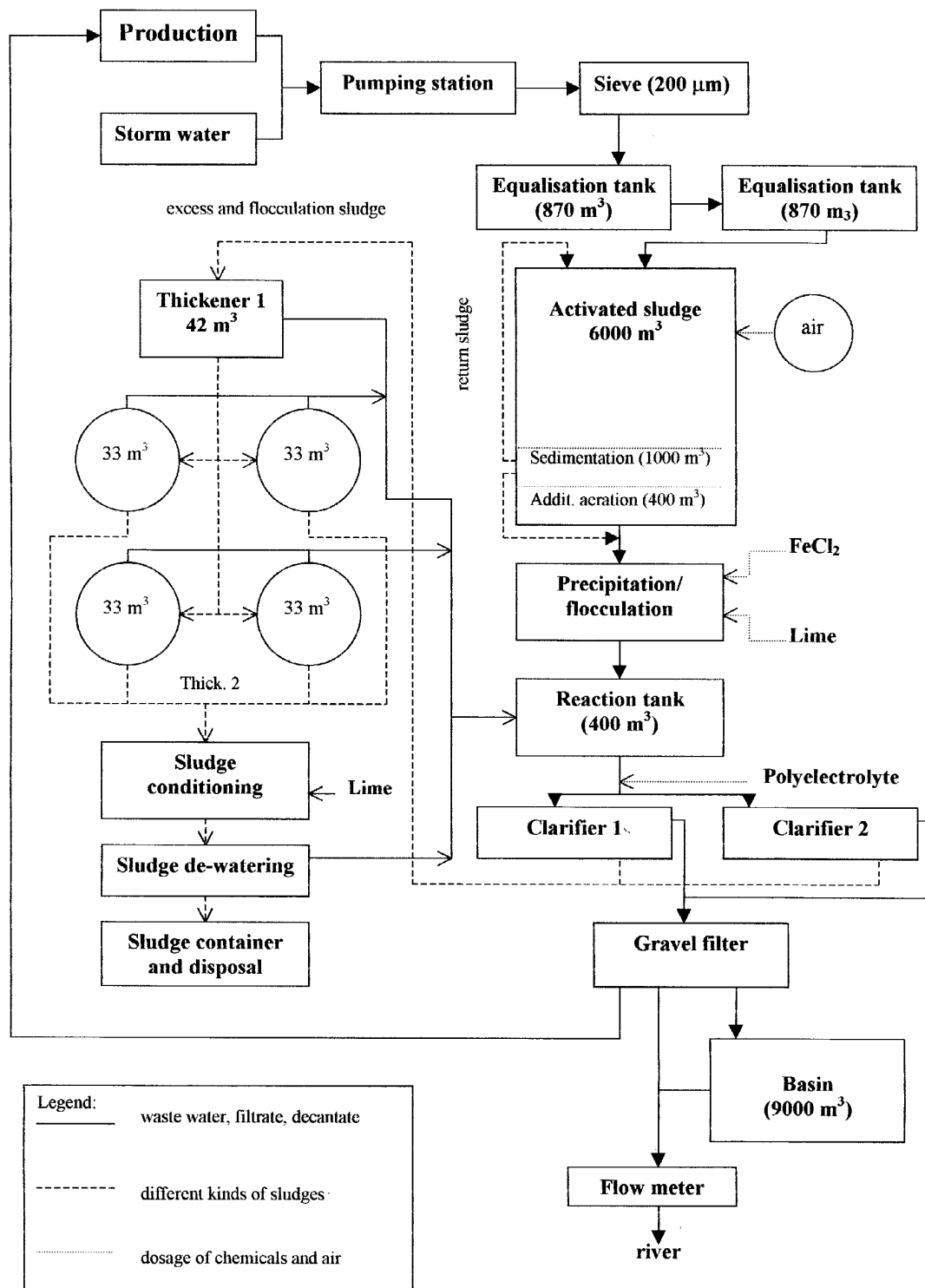


Figure 4.40: Plant 5 –treatment of waste water from one textile finishing mill with 5 % water recycling
[179, UBA, 2001]

Plant 6:

In the plant, shown in Figure 4.41, waste water from about 30 textile finishing units is treated together with municipal waste water. Textile waste water accounts for about 30 % of the hydraulic load and COD for about 40 %. The textile finishing industries discharge their waste water to the public sewer after neutralisation on site. Various companies have pretreatment

plants, especially pigment printing units, which treat the waste water from cleaning the printing equipment by flocculation/precipitation. The layout of the plant is typical with bar screen, aerated grit and grease chamber, primary clarifier, denitrification and nitrification stage. It is exceptional as regards the presence of an additional treatment with activated carbon powder in order to minimise COD and colour in the final effluent. The dosage of activated carbon powder is about 30 g/m^3 and dosage of alum sulphate and polyelectrolyte is about 3 g/m^3 for complete removal of residual suspended carbon particles. Backwash water containing activated carbon is fed to the activated sludge system (this has a significant stabilising effect). Residual COD is very low (below 20 mg/l ; the annual average is 11 mg/l). The final effluent is colourless.

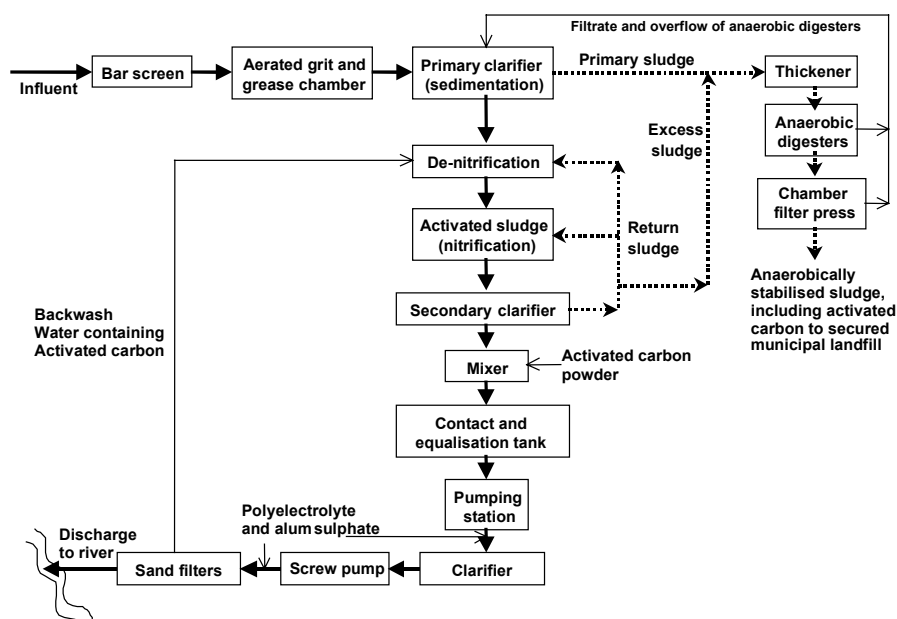


Figure 4.41: Plant 6 –treatment of waste water from one textile finishing mill [179, UBA, 2001]

Achieved emission levels

The table below shows the influent and effluent values and F/M-ratios of the six described treatment plants. In some cases of combined treatment, textile waste water and municipal waste water are discharged to the plant via different sewer lines. For these plants, the influent values are presented separately. Where textile and municipal waste water are already mixed in the sewer, the influent values are given under the heading "influent (textile ww)".

F/M-ratios below $0.15 \text{ kg BOD}_5/\text{kg MLSS}\cdot\text{d}$ enable almost complete nitrification (residual ammonia concentrations lower than 0.5 mg/l).

Plant 4 has a F/M ratio of 0.2, resulting in higher ammonia concentrations and lower BOD_5 removal efficiency.

Aspect/component	unit	Plant 1	Plant 2	Plant 3	Plant 4	Plant 5	Plant 6
		ann. average values for 2000	ann. average values for 1999	ann. average values for 2000	ann. average values for 1998	ann. average values for 2000	ann. average values for 2000
Total flow	(m ³ /d)	8377±1431	47770±24500	6690	25000	2070	38750±16790
Municipal ww flow	(m ³ /d)	4562±2018		4865			
Textile ww flow	(m ³ /d)	3685±1431		1825			
Food-to-microorganisms ratio (F/M)	kg BOD ₅ /kg MLSS x d	0.1	0.1	1.1 and 0.05	0.2	0.1	0.1
Influent (municipal ww)							
pH		8±0.4		8.1			
COD	(mg O ₂ /l)	443±200		336			278±86
BOD ₅	(mg O ₂ /l)	114±50		144			138±49
NH ₄ -N	(mg N/l)	30±14		31			12.5±4.8
N-org	(mg N/l)	18±7		15.9			n.a.
P total	(mg P/l)	6±2		6.2			3.7±1.2
Influent (textile ww)							
pH		9.2±0.8	8.4±0.4	8.7	n.a.	9 - 9.5	
COD	(mg O ₂ /l)	791±281	349±129	967	950	1200 - 1500	
BOD ₅	(mg O ₂ /l)	157±57	145±49	336	400	400 - 500	
NH ₄ -N	(mg N/l)	2.6±2.0	26±8	5.6	n.a.	11 - 25	
N-org	(mg N/l)	19.5±7.0	6±3	9.5	50	30 - 40	
P total	(mg P/l)	3.8±1.2	5±2	2.2	n.a.	10 - 25	
PVA	(mg/l)	28 - 138	n.a.	53	n.a.	n.a.	
Effluent							
pH		7.2±0.2	8.2±0.3	7.4	n.a.	7.8 - 8.6	6.8 - 7.5
COD	(mg O ₂ /l)	59±16	46±23	54	60 - 110	90 - 110	11±1.3
BOD ₅	(mg O ₂ /l)	3±2	4.4±3.8	3	10 - 40	<5	3±0.7
NH ₄ -N	(mg N/l)	0.1±0.2	0.2±0.9	0.12	5 - 15	0.3 - 1.6	0.4±0.3
NO ₃ -N	(mg N/l)	2.9±1.9	3.6±1.1	5.4	1 - 10	<2	6.8±1.0
N-org	(mg N/l)	1.7±0.5	n.a.	n.a.	8 - 15	5 - 10	n.a.
P total	(mg P/l)	0.2±0.2	0.9±0.7	0.6	n.a.	1 - 2.5	0.15±0.015
AOX	(mg Cl/l)	0.06 - 0.08	0.06 - 0.1	n.a.	n.a.	<0.04 - 0.15	n.a.
PVA	(mg/l)	0.6 - 7.8	n.a.	3	n.a.	n.a.	n.a.
SAC (435 nm)	(1/m)	8.3±3	n.a.	2.4	0.02	5 - 7	0.42±0.08
SAC (525 nm)	(1/m)	6.8±2.9	n.a.	0.9	n.a.	1.5 - 5	0.31±0.08
SAC (620 nm)	(1/m)	2.9±1.4	n.a.	0.9	n.a.	1 - 3.5	0.18±0.05
Removal efficiencies							
COD	(%)	90±4	84.4	89	91	92.5	96
BOD ₅	(%)	97±2	96.2	98	93.5	99	98
nitrogen	(%)	88±6	88	78	77	82	47
phosphorous	(%)	96±3	79	88	n.a.	90	96

Table 4.41: Characteristics of waste water parameters (input and output) for six treatment plants [179, UBA, 2001]

Applicability

Activated sludge systems with low F/M ratios are applicable to both new and existing plants for all kinds of textile waste water. They can also be applied to municipal waste water treatment plants with low and high percentages of textile waste water as well as to purely industrial plants in which the waste water of one or more finishing mills is treated.

The low F/M ratio conditions in an activated sludge treatment can be achieved not only by increasing the hydraulic retention time. Other methods are applicable, such as for example:

- removing the food from the activated sludge (like for example in the technique described in Section 4.10.3)
- reducing the load by pretreatment of selected concentrated streams (see Section 4.10.7)
- increasing the biomass in the activated sludge system (e.g. bio-membrane reactor, bio-flotation).

Cross-media effects

Treatment in activated sludge under low F/M conditions as such is not sufficient for removing the fraction of COD represented by non-biodegradable hazardous chemicals. Other or additional treatment are necessary to transfer or better transform these substances.

Economics

When low F/M ratio conditions are achieved by increasing the retention time, this means bigger aeration tanks, resulting in higher investment costs. Broadly speaking, the size of activated sludge systems is inversely proportional with F/M. Precise data on investment costs are not available. Additional cost for additional aeration is about 0.30 euros/m³.

Reference literature

[179, UBA, 2001]

4.10.2 Treatment of mixed waste water with about 60 % water recycling

Description

The example presented here ([179, UBA, 2001]) illustrates the on-site treatment of mixed textile waste water with partial recycling of the treated effluent.

The flow sheet is shown in Figure 4.42.

Before treatment, the hot streams (> 40°C) are submitted to heat recovery. The following steps are then carried out on the mixed effluent:

- equalisation (about 20 h equalisation) and neutralisation
- activated sludge treatment in a special system consisting of loop reactors (dry matter content in the reactors: about 35 g/l) and clarifiers (which are not shown in the figure). Here the biodegradable compounds are completely removed (< 5 mg/l). Biodegradation efficiency is improved and stabilised by lignite coke powder which acts as temporary adsorbent both for organic compounds and oxygen (buffer function); in addition, micro-organisms growing on lignite powder can be enriched in the system
- adsorption stage: lignite coke powder (with a specific surface of 300 m²/g) is added with a dosage of about 0.8 - 1 kg/m³ in order to remove dyestuffs and other hardly or non-biodegradable compounds (the content of dry matter in the reactors is about 40 g/l). After sedimentation, the lignite coke powder is recycled to the adsorbers as well as to the activated sludge loop reactors
- flocculation/precipitation and removal of the sludge by flotation: this step is necessary to ensure the complete removal of lignite powder (otherwise incomplete due to the small size of the particles). Alum sulphate and an anionic polyelectrolyte are added as flocculants (about 180 g/m³). In addition, to avoid breaching local limits on colour, especially red, an organic cationic flocculant (forming water-insoluble ion pairs with the sulpho-groups of the dyestuffs) is dispensed
- filtration in a fixed bed gravel filter to remove suspended solids and some organic compounds.

Then about one third of the flow is discharged to the river and the other two-thirds are first treated in an activated carbon filter in order to remove residual traces of organic compounds and are then desalinated in a reverse osmosis plant.

In the reverse osmosis plant (consisting of 10 modules containing 4 spiral modules each) the permeate is mixed with fresh water and is used for all finishing processes, whereas the salty concentrate is re-used for the preparation of the brine solution needed for reactive dyeing.

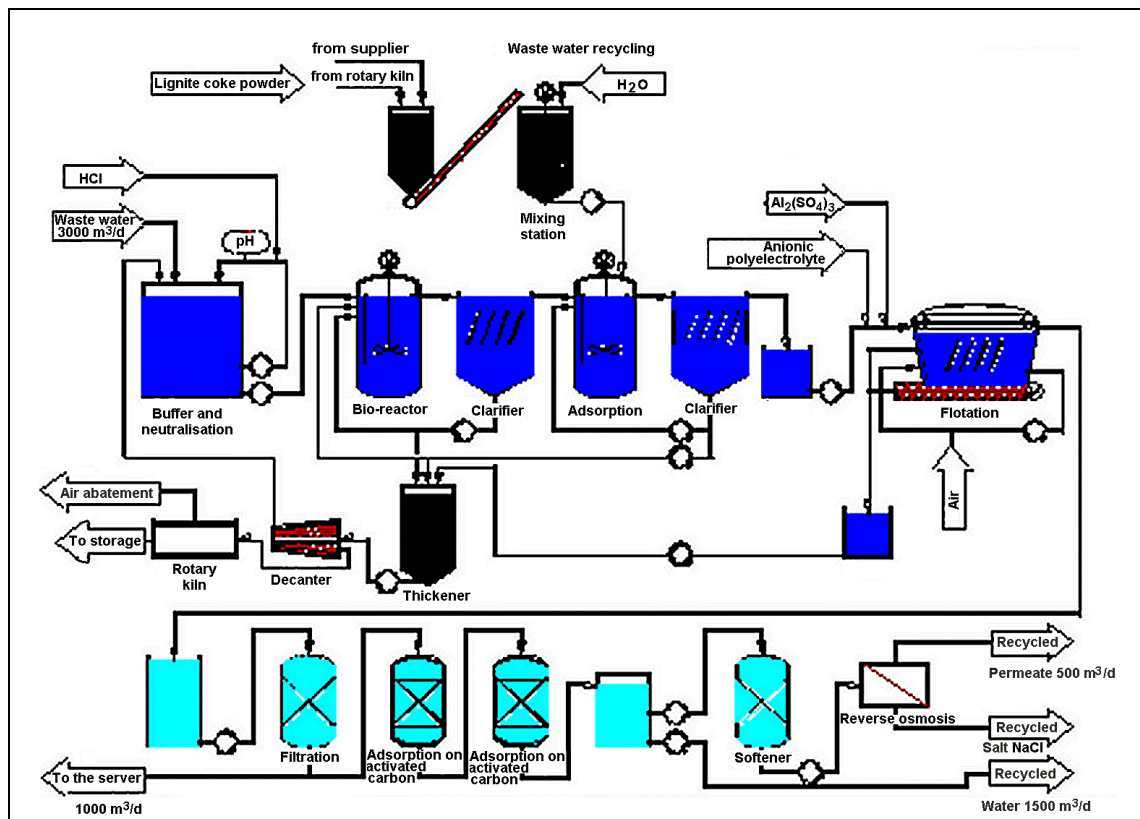


Figure 4.42: On-site treatment of mixed textile waste water with partial recycling of the treated effluent
[179, UBA, 2001]

The treated waste water is stored in a tank and conditioned with ozone (about 2 g/m^3) in order to prevent any biological activity. The effluent is colourless and the inorganic and organic load is very low.

Along with excess sludge from the activated sludge system, the sludge from flotation is dewatered in a thickener and decanter and is then thermally regenerated in a rotary kiln (Figure 4.43). The temperature of the off-gas from the kiln is about $450 \text{ }^\circ\text{C}$. The flue-gas is submitted to post-combustion (about $850 \text{ }^\circ\text{C}$) and then the heat from the final off-gas is recovered by heat exchange (final temperature of the emitted air is about $120 \text{ }^\circ\text{C}$).

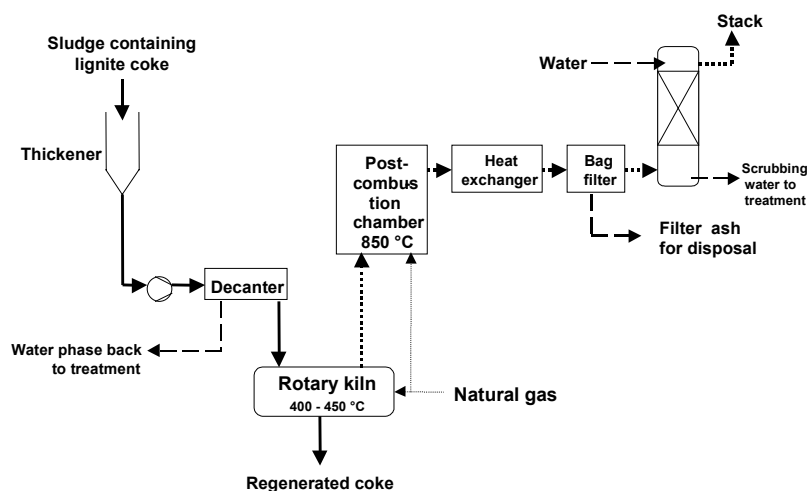


Figure 4.43: Thermal treatment of excess sludge from the activated sludge treatment and sludge from flotation
[179, UBA, 2001]

Main achieved environmental benefits

The described treatment enables significant reduction of waste water flow, achieving about 60 % recycling of the treated water. In addition, about 50 % of neutral salt is recovered and re-used for exhaust dyeing. The non-recycled water is discharged with very low residual content of organic compounds.

Applicability

The described technique is applicable to all types of textile waste water. It has been tested at pilot plant scale (1 m³/h) for waste water from textile mills finishing yarn, woven fabric and knitted fabric with or without a printing section [179, UBA, 2001].

Cross-media effects

The treatment requires considerable amounts of energy (mainly for the reverse osmosis plant).

Reference plants

A) Plant for the treatment and recycling of waste water at Schiesser, D-09243 Niederfrohna (in operation since 1995) for a design waste water flow of 2500 m³/d. This company treats cotton knitted fabric and dyes almost exclusively with reactive dyestuffs. The present waste water flow is about 1300 m³/d. There are two lines for activated sludge treatment and adsorption; at any one time, one line is in operation and the second is on stand-by in case of increasing flow.

B) A second plant has been in operation since 1999 at Palla Creativ Textiltechnik GmbH, D-09356 St. Egidien which is designed for a flow of 3000 m³/d and a 60 % recycling rate. This company mainly finishes woollen woven fabric.

Operational data

The performance of the Schiesser plant is illustrated in the following tables.

The very low values for COD, BOD₅, TOC, detergents, colour and heavy metals in the treated effluent (see table below) indicate that there are no limitations for recycling. However, as seen

earlier, additional treatment (ion exchange and reverse osmosis) is necessary to remove salt and hardness ions (mainly calcium extracted from cotton).

Parameter	unit	Influent	Effluent after filtration, before adsorption	Recycled stream after reverse osmosis
pH		7.3	7.2	7.0
Conductivity	(mS/cm)	5.9	6.2	0.8
Temperature	(°C)	26.2	22.9	
COD	(mg O ₂ /l)	515	20	10
BOD ₅	(mg O ₂ /l)	140	< 0.1	< 0.1
TOC	(mg C/l)	135	4.8	3
AOX	(mg Cl/l)	0.56	0.2	
Anionic detergents	(mg/l)		0.02	
Cationic detergents	(mg/l)		0.02	
Hardness	(°dH)	2.5	13.6	
Ammonia	(mg N/l)	0.3	< 0.01	
Nitrate	(mg N/l)	2.5	0.9	
Total Iron	(mg/l)		< 0.01	
Total aluminium	(mg/l)		< 0.01	
Chloride	(mg/l)	1750	1710	
Sulphate	(mg/l)	163	188	
o-Phosphate	(mg/l)	0.7	< 0.01	
SAC at 436 nm	(1/m)	13	0.04	0
SAC at 525 nm	(1/m)	16.2	0.04	0
SAC at 620 nm	(1/m)	24.5	0.04	0

Table 4.42: Typical characteristics of the different water streams (mean values) at the treatment plant Schiesser, D-Niederfrohna [179, UBA, 2001]

As regards the regeneration of lignite coke in the sludge, the following emission values are achieved.

Parameter	unit	Achieved value @ 11 vol-% O ₂
Total particulate matter (dust)	(mg/Nm ³)	9.2
Carbon monoxide	(mg/Nm ³)	9.3
Total organic carbon	(mg/Nm ³)	< 3.0
Gaseous inorganic chlorine compounds	(mg/Nm ³)	< 1.0
Sulphur dioxide	(mg/Nm ³)	< 1.4
Nitrogen oxides (as NO ₂)	(mg/Nm ³)	190
PCDD/PCDF	(ng I-TEQ/Nm ³)	0.004

Table 4.43: Measures emission values: off-gas from the thermal regeneration plant [179, UBA, 2001]

The composition of fresh and regenerated lignite coke is shown in the next table. The carbon content of regenerated coke is slightly higher, but ash content is about 30 % lower. Thus, recycling is possible without limitations. Also the size distribution of regenerated coke particles is very similar to that of the fresh material.

Parameter	Fresh lignite coke (weight-%)	Regenerated (at 450°C) lignite coke (weight-%)
C	88.5	90.5
H	0.4	0.3
N	0.4	0.28
Total Si	0.5	0.59
Ash	9.0	6.63

Table 4.44: Elemental analysis of fresh and regenerated lignite coke
[179, UBA, 2001]

Ash removed from off-gas after heat recovery has to be disposed of as hazardous waste. The specific quantity is 5 g/m³ treated effluent.

Although the equipment was made of stainless steel, there were corrosion problems at the Schiesser plant; but they have been solved by replacing the supply pipes with plastic and coating the reactors with polyurethane.

Since summer 1998 the reverse osmosis plant has been out of operation because of high operating cost and the fact that the company does not need a 60 % recycling rate because the actual flow is far below the designed one. Thus, a recycling rate of 25 % is sufficient at the moment.

Data on the plant at Palla Creativ Textiltechnik GmbH are not available.

Economics

Investment costs for such a plant are very high. For Schiesser it was 10.1 million euros, of which 2.0 million were for building construction, 7.4 million for technical equipment and 0.7 million for planning, scientific investigations etc. The plant has been highly subsidised by the federal and state government (about 80 %). The following table shows the cost per year and flow-specific cost, ignoring the subsidies, i.e taking full account of the capital cost.

Cost factor	Cost per year (EUR/yr)	Flow specific cost (EUR/m ³)
Capital cost (10 a-depreciation at an interest rate of 6.88 %)	876260	1.46
Personal cost	78000	0.13
Maintenance cost	63000	0.105
Operation cost		
- Lignite coke	60000	0.1
- Acetic acid	9000	0.015
- Polyelectrolyte	6000	0.01
- Alum sulphate	30000	0.05
- Cationic organic flocculant	15000	0.025
- Wetting agent	15000	0.025
- Cleaning agent for membranes (acidic)	3000	0.005
- Cleaning agent for membranes (alkaline)	3000	0.005
- Electricity (1.51 kWh/m ³)	63000	0.105
- Natural gas for coke regeneration	57000	0.095
- Disposal of ash from flue gas purification	1650	0.0019
Fee for waste water discharge	18000	0.03
total	1297910	2.16
Pay back from heat recovery	538200	0.9
Total cost	759710	1.27

Table 4.45: Capital and operating costs of the Schiesser plant; costs are calculated for the design flow of 2500 m³/d and 600000m³/yr, respectively
[179, UBA, 2001]

The total flow-specific cost has to be compared with the alternative cost of discharging the waste water to the municipal waste water treatment plant.

In addition, since the company is only allowed to use 1000 m³/d ground water, 1700 m³/d would have been purchased from public water supply to cover the design consumption (2700 m³/d). Thus, the company would have had to pay 2.90 euros/m³. Thus, 1.63 euros/m³ could be saved, which means nearly one million euros per year.

Data on the plant at Palla Creativ Textiltechnik GmbH are not available.

Driving force for implementation

Ground water supply is limited. This was an important reason to go for a waste water recycling technique. The very high investment costs could be accepted because of the generous subsidies granted.

Reference literature

[179, UBA, 2001]

4.10.3 Combined biological physical and chemical treatment of mixed waste water effluent

Description

Treatment in activated sludge systems under low F/M ratio conditions (Section 4.10.1) enables the degradation of both readily and hardly biodegradable substances. However, this technique is not sufficient for degrading or eliminating non-biodegradable compounds. Effluents containing non-biodegradable compounds should undergo additional treatments to remove or destroy these substances.

Such treatments should preferably be carried out before the final biological treatment (see Section 4.10.7), but in practice this is done only in a few mills.

In most cases additional sequential treatments are carried out after the activated sludge such as flocculation/precipitation, coagulation/adsorption/precipitation, ozonation. However, ozonation, when applied at the end of the treatment process, mainly has the effect of degrading the chemicals into intermediate degradation by-products, whereas the other treatments listed ultimately just transfer to sludge the substances that escape bioelimination.

Another approach for improving the performance of the activated sludge treatment is represented by the Powdered Activated Carbon treatment. This consists in combining the different technologies (biological, physical, chemical), thus allowing simultaneous biodegradation, adsorption and coagulation. The process was introduced in the early seventies and industrialised with the commercial name of PACT and PACT® systems.

In the PACT system, powdered activated carbon and bacteria are maintained in an aerobic/anoxic treatment process for symbiotic activity [292, US Filter-Zimpro, 2002].

In the PACT® system, the excess sludge (a mixture of spent powdered carbon and biomass) from the aerobic aerator is regenerated by means of a hydrothermal treatment (wet oxidation). This is a liquid phase reaction in water using dissolved oxygen (or air) to oxidise soluble and suspended oxidisable contaminants. When air is used as the source of oxygen the process is referred to as “Wet Air Oxidation”. The oxidation reaction is carried out at moderate temperatures of 150 – 315 °C and at pressures from 10 to 207 bar. The process destroys the large molecules in waste water, converting them predominantly to carbon dioxide, water and

short chain organic acids, which are highly biodegradable and more suitable for biological treatment. This regeneration process provides continual re-use of the activated carbon and ensures high levels of waste treatment.

A first application of the PACT® system in the European textiles industry appeared in 1975 (Desso in Belgium). The process was later improved by integrating it with simultaneous coagulation treatment (the system is called PACT+, a cryptic term to indicate a first improvement).

A second improvement (the so-called PACT++) could only be achieved by changing and extending the conventional activated sludge process with a nitrification/denitrification step followed by a filtration of the effluent to retain suspended solids.

Another technique is the PACT3+ system. This concept is a combination of different available techniques, with the aim of improving performance, flexibility and economy of scale of the PACT® system.

In the PACT3+ system, activated carbon is added to the aerobic aerator together with iron, which is used as a coagulant to precipitate phosphate and increase the binding of dyes into the sludge. The reactivation of the spent sludges containing powdered carbon and iron, is carried out at low temperature (below 130°C) if hydrogen peroxide is used (a process referred to as “catalytic active carbon wet peroxidation”). Concentrated or adsorbed substances are destroyed by advanced oxidation using hydrogen peroxide, creating the conditions for the Fenton reaction (H_2O_2 , Fe^{2+} at pH 3). The principle of this process is described in Section 4.10.7. Both the reactivated carbon and the iron are recycled back to the aerobic system.

In this enhanced process it is not necessary to add oxygen (pure oxygen or air) because this is already available in the biomass.

Main achieved environmental benefits

The described pretreatment techniques increase the performance of the activated sludge treatment.

The main advantages over sequential tertiary treatments applied after the biological system are:

- the production of excess sludge is reduced
- substances that are potentially hazardous (non-biodegradable, accumulatable, toxic) are preferentially removed and destroyed
- the activated sludge system is better protected against shock loading, and as the adsorbed material is degraded, the risk of displacement of dyes and other adsorbed substances is much lower than it appears to be with post-adsorption (e.g. granular activated carbon)
- the excess solids produced are dense and retain the remaining substances, which can therefore be sent to easier dewatering (anaerobic) and incineration
- mineralisation of the organic pollutants is improved
- energy use in aeration is lower.

Operational data

With PACT® and PACT3+ treatments a good filtration is very important in order to efficiently separate the sludge from the treated effluent.

Applicability

The technique is applicable to existing and new installations where a biological treatment is available and where solids are fully retained in the clarification system. A microfilter is to be added when there is a risk that solids could escape with the effluent.

The addition of the adsorbent (activated carbon) and coagulant can be done at any point where the utilisation is most effective (cost, performance) and do not necessarily need to be added directly in the aerobic aerator; this is because the countercurrent-flow from coagulation, adsorption and filtration has the effect of returning to the biological system the adsorbent and coagulant containing the substances removed from the water.

Reactivation using hydrogen peroxide allows the re-use of carbon and iron. The technique is most interesting for pretreating hot concentrates (somewhat comparable with the technique described in Section 4.10.7, but simpler because there is no need to inject oxygen gas) and for reactivating sludges from biological, physical and coagulation processes.

Economics

The following additional equipment is needed:

- dosing systems for powdered carbon and iron-sulphate
- dosing system for peroxide
- microfiltration
- reactor for reactivation of concentrated streams.

Special types of activated carbon are known to give the best performance. Cost depends on the dosage (less than 100 g/m³ of mixed effluent is needed, when reactivation of the activated carbon is carried out).

Hydrogen peroxide is consumed in stoichiometric amounts to transform the concentrated substances into bioeliminable substances (under conditions of optimal pH and temperature).

Iron is added as iron sulphate. It is introduced as a coagulant but it also serves as a catalyst, nutrient and precipitant for sulphides and phosphates.

Driving forces for implementation

PARCOM Recommendations 94/5, after critical review of the PACT process, supports the implementation of the PACT3+ concept as one of the most promising upcoming technologies (based on advanced oxidation processes, technologies for the nineties).

Reference plants

Different PACT processes to treat dyestuff containing effluents are in place world-wide.

The PACT® system has been in operation since 1980 for textile effluents in the city of Vernon.

The PACT+ system has been implemented by Desso, who has also evaluated the PACT++ system (no info about future directions).

PACT3+ is a concept that combines existing applied techniques.

Reference literature

[314, L. Bettens, 2002], [292, US Filter-Zimpro, 2002].

4.10.4 Recycling of textile waste water by treatment of selected streams with membrane techniques

Description

Membrane techniques are applied in various ways for the treatment of segregated streams to allow water reclamation and re-use closely integrated with the process. Two case studies are presented where membrane techniques are applied to effluents from dyeing operations. These case studies, however, are examples only. Membrane techniques can also be applied to other types of effluents, such as, for example, the desizing effluents (see Section 4.5.1), including those resulting from the enzymatic desizing of fabrics treated with starch- and modified starch sizes [192, Danish EPA, 2001].

Plant A) [179, UBA, 2001]

The company treats woven fabric, mainly consisting of cotton. The process sequence includes pretreatment, dyeing (cold pad batch), pigment printing and finishing (application of softeners or fluorocarbon resins). Rinsing operations account for most of the waste water produced.

The next figure shows the flow sheet of the treatments applied to the segregated streams. Membrane techniques applied include ultrafiltration, nanofiltration and reverse osmosis.

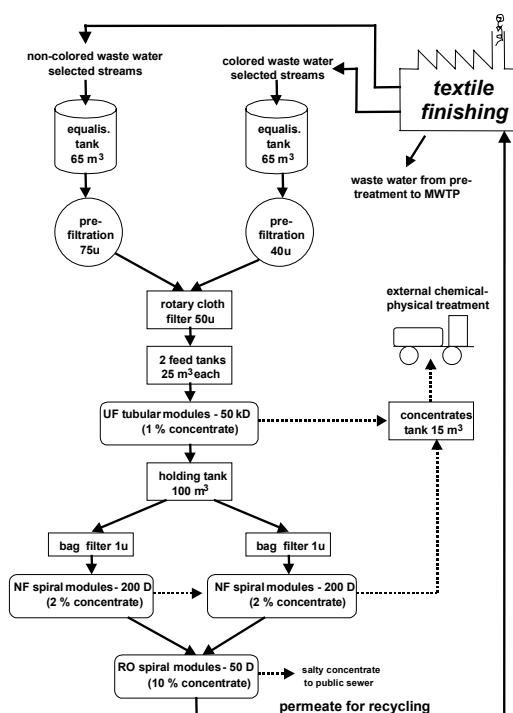


Figure 4.44: Treatment of selected segregated waste water streams using a series of membrane techniques (ultrafiltration, nanofiltration and reverse osmosis) – the cut-offs are expressed in Dalton (D)

[179, UBA, 2001]

Not all waste water is recycled. Waste water from pretreatment (scouring and bleaching) and finishing (residual padding liquors) is not treated in the membrane plant but is discharged, after neutralisation, to the municipal waste water treatment plant.

In order to assess the potential for re-use, the single process streams have been carefully analysed and segregated according to their suitability for treatment with membranes. For

instance, streams containing pigment pastes cannot be treated with membranes because the binders would lead to irreversible scaling of the equipment. Moreover, some process modifications have been necessary. For example, use of water glass in cold pad batch dyeing had to stop because silicates would also block the membranes.

The first membrane step is an ultrafiltration tubular ceramic module, which is needed in order to remove all residual particles and polymers.

About 90 % of the feed can be recycled for most processes. However, the re-use of the treated water has to be carefully assessed. For example, fresh water and not recycled water is used for the preparation of bleaching, dyeing and finishing liquors.

Plant B) [192, Danish EPA, 2001]

The second example is also of a company finishing cotton fabric. The measures include:

- reclamation and re-use of dye bath and first rinsing water after reactive dyeing by treating the highly coloured and salted water with activated carbon; the carbon retains the dyestuff and other organic chemicals and delivers clear, hot water with sodium chloride and sodium hydroxide for re-use
- reclamation and re-use of rinsing water after dyeing by membrane filtration (with nanofiltration or reverse osmosis).

Main achieved environmental benefits

A reduction in water consumption and waste water discharge of about 60 % is reported in plant A [179, UBA, 2001]. The COD load in the effluent discharged to the municipal treatment plant is reduced by about 50 %. Similar reductions in water consumption and discharge of chemicals (especially salt) are also claimed in the second example plant [192, Danish EPA, 2001].

Operational data

Plant A went into operation at the end of 1995. Many problems had to be tackled, especially the removal of fibres and particles (e.g. dust from singeing) and the identification of chemicals that were causing scaling of the membranes. The ultrafiltration step had to be changed from spiral modules to ceramic tubular modules, which are much less sensitive to scaling.

The reference data for permeate fluxes are:

- ultrafiltration (UF): 85 - 130 l/m² x h
- nanofiltration (NF): 12 - 17 l/m² x h
- reverse osmosis (RO): 11 - 17 l/m² x h

The plant treats about 900 m³/week waste water (which is about 70 % of the overall waste water flow) and recovers about 800 m³/week water which can be used for all washing/rinsing operations.

The plant is operated batch-wise. The concentrate is physico-chemically treated in an external plant. For further optimisation, plans are in hand to treat the concentrate by evaporation (in order to achieve 15 % water content) and then send it to incineration.

The experience with *Plant B* reported by Denmark was a semi-full-scale test. The dimensioning parameters from the activated carbon test-plant were a retention time of 2 hours and a capacity of 4 kg carbon/kg dyestuff. The carbon type used was F400 from Chemviron Carbon. A full-scale plant can consist of two columns connected in series and with reversible flow, so that there is capacity for recharging when they reach dye breakthrough point.

Test dyeings showed that re-using warm, saline and decoloured dye baths was possible with no adverse effects on fabric shade or fastness.

The dimensioning parameters of the membrane treatment from the test-plant based on spiral wound elements were an average production of 25 l/ m²h at 25 °C and 7 - 10 bar. The selected elements in use were 50 mil Duratherm elements from OSMONICS DESAL.

Cross-media effects

Energy consumption seems to be significant. For plant A, the energy consumption of the membrane plant is reported to be about 20 kWh/m³ treated waste water. Moreover, since membrane treatment is a separation technique, correct disposal of the concentrate is a crucial point.

No consumption data are reported for the second case study.

Applicability

The technique is applicable to all textile finishing industries, provided that proper waste water segregation is practised and selection of membrane-compatible single waste water streams is made. Recipes have to be checked in terms of membrane compatibility and have to be changed if necessary (see description above).

Structural changes for additional pipelines are needed in existing mills for waste water segregation. Additional tanks (space demand) for interim storage have to be installed.

For salt re-use (plant B), since the salt will be in the water from the very start, the so-called “all-in” dyeing method has to be applied. This is opposite to the normal way where the dyestuff is evenly distributed before salt is added (see Section 2.7.3 “Reactive dyes”).

Economics

The investment for the 10 m³/h membrane equipment (Plant A) is about 1 million euros. Taking into account capital cost and operating cost (labour, energy, chemicals for membrane cleaning, maintenance and concentrate disposal) the specific costs are 4.5 euros/m³ recycled water (capital cost: 1.3 euros/m³, operating cost: 3.2 euros /m³) [179, UBA, 2001].

In Plant B, payback time is reported as 5 years for reclamation and re-use of dye bath by treatment with activated carbon and 8 months for membrane treatment and recycling of rinsing water from dyeing [192, Danish EPA, 2001].

Driving force for implementation

High costs for fresh water and waste water discharge are the main driving forces.

Reference plants

Membrane techniques for treatment of segregated waste water streams are applied in many plants in Europe. In particular the two examples described here are:

Plant A: Fa. van Clewe GmbH & Co.KG, D-46499 Dingden with a design flow of 10 m³/h

Plant B: Martensens A/S, DK-7330 Brande

Reference literature

[179, UBA, 2001], [192, Danish EPA, 2001].

4.10.5 Treatment and recovery of waste water containing pigment paste

Description

This technique refers to membrane treatment of waste water containing pigment printing pastes with full re-use of the resulting permeate.

In the example described here, waste water comes from the printing paste preparation kitchen (mainly resulting from cleaning operations of stirrers, drums etc.). The pigment pastes contain organic dye pigments, organic thickeners (usually polyacrylates), organic binders (co-polymerisates), fixation agents (organic resins), catalysts and softening agents.

Treatment (see flow sheet in the figure) consists of the following steps:

- coagulation to de-activate the organic dyes, binders and fixation agents (polyaluminium chloride sulphate is added)
- precipitation of the resulting coagulates with bentonite at pH 6
- microfiltration of the precipitate. The applied membranes consist of polypropylene and have a cut off of 0.2 μm . Suspended solids in the concentrate are removed in a tube settler by dosage of a flocculant.

The sludge is sent to physico-chemical treatment offsite. It is planned to send it to incineration in the near future. The permeate is totally free of suspended solids and can be re-used for cleaning operations.

Figure 4.45 indicates that, beside the waste water from the pigment paste preparation station, the effluent from the scrubbers (treatment of off-gases from three stenters) is also sent to the membranes. The core of the plant are two micro-filtration modules consisting of 400 spiral membrane tubes each.

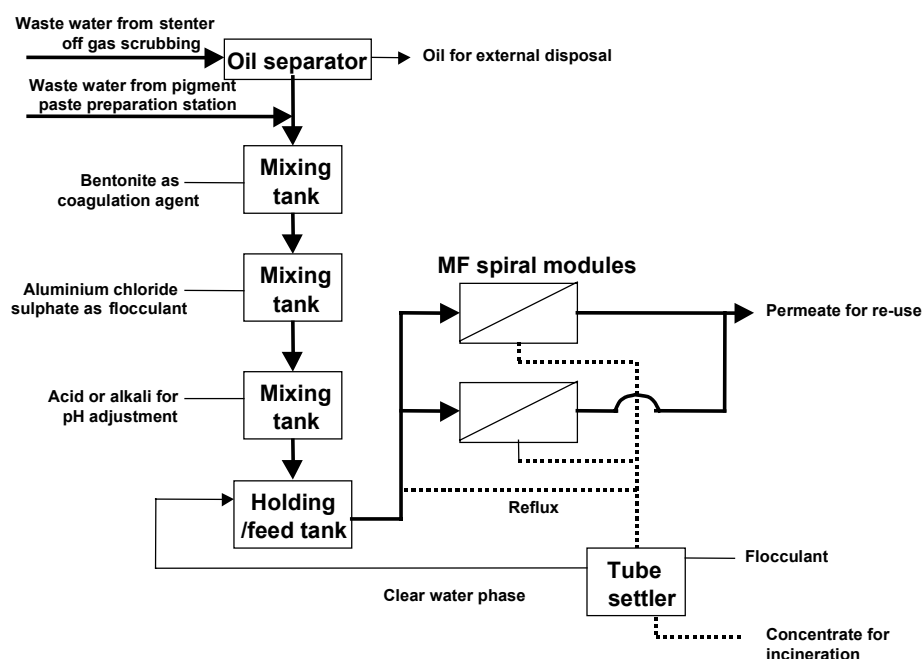


Figure 4.45: Layout of a plant for treatment and recycling of waste water from pigment printing paste preparation kitchen (water from scrubbers is treated in the same plant) [179, UBA, 2001]

Main achieved environmental benefits

More than 90 % of the water is recycled. Non-biodegradable compounds, such as organic thickeners, binders and fixation agents, are completely removed and can then be mineralised by incineration (incineration is not yet done in the example referred to in this section, but it is planned for the near future). It should be noted, however, that due to the presence of chlorides, there is a potential for the production of hazardous substances (dioxins and furans) when the sludge is incinerated [281, Belgium, 2002]. Catalytic and high temperature incinerators are now available to prevent these emissions.

Operational data

COD of input water to the treatment plant varies between 4000 and 10000 mg/l. COD in the permeate is about 600 mg/l, which means a removal efficiency of about 90 %.

Coagulation has to be carried out and controlled very carefully because of organic binders and fixation agents. If these compounds became completely inactivated, they would lead to scaling of the membrane and would block it within a short time.

The pressure difference of microfiltration is about 1 bar.

Cross-media effects

Energy is required for waste water treatment and recycling [179, UBA, 2001]. No data were made available regarding consumption levels.

Applicability

The technique is applicable to existing and new installations preparing pigment pastes for coating or printing operations.

Economics

The described plant with a flow of 2.5 m³/h (comprising the two waste water streams mentioned) needed investment of 180000 euros. Operating cost, including external disposal of the concentrate (which is the major part) is about 4 euro/m³.

Driving force for implementation

The company considered in this example is discharging the waste water to a municipal waste water treatment plant with strong limitations imposed on flow and COD.

Reference plants

A plant for 1.25 m³/h has been operating since 2001 at van Clewe GmbH, D-46495 Dingden, where combined treatment with scrubbing water from purification of stenter off-gas takes place (additional 1.25 m³/h).

Reference literature

[179, UBA, 2001]

4.10.6 Anaerobic removal of residual dyestuff from padding liquors and printing paste residues

Printing pastes and padding liquors for continuous and semi-continuous dyeing contain high concentrations of dyestuffs (see Section 3.3.3.5.4). Residual padding liquors and printing pastes

can be treated in anaerobic digesters, preferably in co-fermentation with primary and excess sludge from biological treatment. In practice, the residues are fed into anaerobic digesters at municipal waste water treatment plants.

When azo dyestuffs are treated under anaerobic conditions, the azo groups (characteristic of this type of dyestuffs) are irreversibly destroyed, causing the dyestuffs to lose their colour. However, the remaining aromatic systems still absorb light, so some slight yellowish colour often remains.

The water-soluble cleavage products (the ones with sulphonic groups) are present in the water phase and reach the activated sludge treatment both as overflow from the anaerobic digester and as filtrate from sludge dewatering. The more-substituted naphthalene derivatives are hardly biodegradable and may still be present in the final effluent. For this reason, the supernatant needs to be subsequently treated in an activated sludge system.

Main achieved environmental benefits

Anaerobic treatments reach colour removal efficiencies of more than 90 % with azo dyes (determined as reduction of spectral absorption coefficients at the wavelengths 436, 525 and 620 nm) [179, UBA, 2001].

Also with printing pastes containing natural thickeners, such as alginates or galactomannans, there is a conversion to biogas thanks to degradation of these biopolymers.

Although the quantity of the mentioned concentrates represents a small percentage of the total discharged waste water (only a few tonnes per week even for large mills), there are cases in which the total residual colour in the effluent of treatment plants could be reduced by about 50 %.

Operational data

In order to derive the most benefit from anaerobic treatment, this technique should be applied in combination with process-integrated techniques aimed at minimising printing paste residues. Moreover, it is important to separate at source the residual padding liquors from other streams in order to keep them concentrated.

The dosage of reactive printing paste should not exceed 10 g/kg sludge because of possible inhibition effects on the anaerobic process. Laboratory tests may assist with determination of inhibition effects.

Padding liquors and printing pastes with heavy metal-containing dyestuffs should be separated unless the sludge resulting from the anaerobic treatment is incinerated or disposed of in appropriate landfill (see Landfill Directive 99/31/EC).

Cross-media effects

The reductive cleavage of the azo bonds leads to aromatic amines. As for the potential for release of carcinogenic aromatic amines, investigations carried out so far have not confirmed this fear [179, UBA, 2001] (with reference to "Kolb, 1988"). Moreover, the supernatant from the anaerobic treatment is normally treated with activated sludge.

Applicability

The technique can be applied to both new and existing installations.

Anaerobic treatment is particularly suitable for azo dyestuffs, which represent 50 % of the colourants currently available on the market.

However, other chromophoric systems cannot be treated substantially. Vat dyes for example, are reduced to the colourless form, but this process is reversible.

Pigment printing pastes cannot be treated in anaerobic digesters because all components are non-biodegradable and scaling problems occur because of polymer binders.

In conclusion, even if anaerobic treatments reach efficiencies of 90 % with azo dyes, for companies using a broader range of dyes this technique has an average overall efficiency.

Economics

The known cost for anaerobic treatment in municipal anaerobic digesters varies between 30 and 60 euros/t of padding liquor or printing paste [179, UBA, 2001].

Driving force for implementation

Pressure related to non-compliance with existing standards for colour in the discharge from treatment plants.

Reference plants

In Germany, residual printing pastes are treated in the anaerobic digesters of the municipal waste water plants of Ravensburg, D-Ravensburg and Bändlegrund, D-Weil. Residual padding liquors for dyeing are treated in the anaerobic digester of the municipal waste water treatment plant of Heidenheim, D-Heidenheim

Reference literature

[179, UBA, 2001]

4.10.7 Treatment of selected and segregated, non-biodegradable waste water stream by chemical oxidation

Description

Highly concentrated waste water streams result from various processes in the textile finishing chain. Depending on the efficiency of the washing machines (water consumption) and load of sizing agents on the fabric, COD-concentrations of desizing baths up to 20000 mg/l can be observed. Depending on the class of dyestuffs, exhausted dye baths have COD-concentrations between 1000 and 15000 mg/l are possible. Residual padding liquors from dyeing and finishing and residual printing pastes show even higher COD-concentrations.

Desizing baths with non-biodegradable sizing agents and exhausted dye baths can be treated by oxidation in a special reactor at 100 – 130 °C and about 3 bars pressure (max. 5 bars). The main oxidising agent is molecular oxygen. Hydrogen peroxide only initiates the oxidation reaction and keeps it running (delivering 1/5 of the reactive oxygen). Iron(II)-salt is added as catalyst in acid medium. With COD of the feed of more than 2500 mg/l, the reaction is exothermic. The process is called “Thermal Fenton Process”. The figure below shows the reactor and reaction conditions. More information about Advanced Oxidation Processes and the Fenton reaction is reported in Section 14.

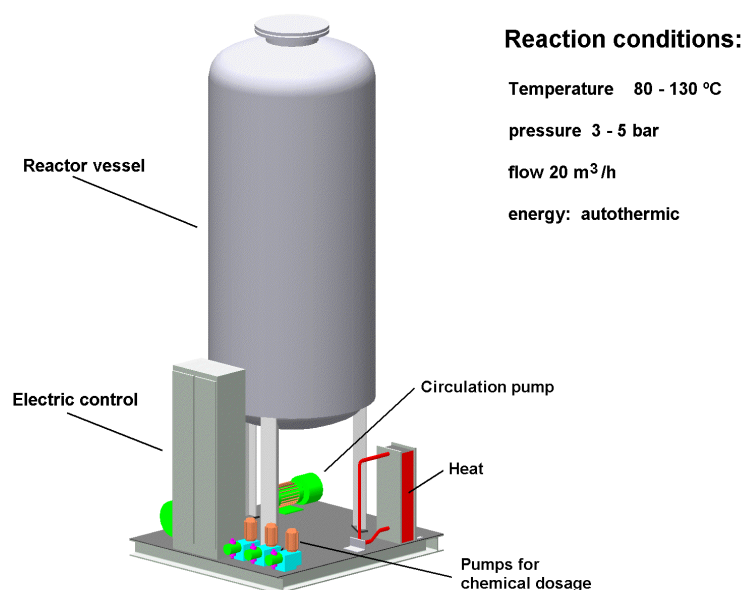


Figure 4.46: Scheme of the reactor for treatment by catalytic oxidation with O₂/H₂O₂ of some segregated highly concentrated streams; on the left, illustration of the reactor at Schoeller AG, CH-Sevelen in operation since 1996 [179, UBA, 2001]

Main achieved environmental performance

COD removal efficiencies of 70 – 85 % are achieved, depending on retention time, applied temperature and pressure and chemical properties of the compounds in the effluent to be treated.

Residual COD is largely biodegradable, because of modification of the compounds during the oxidation process. Given that the effluent is in most cases submitted to subsequent biological treatment (normally in the municipal waste water treatment plant), high COD removal efficiencies (95 % or higher) are achieved. This removal is real mineralisation, that is complete break-down of organic compounds. De-colouration is more than 90 % and treated exhaust dye baths are practically colourless.

Operational data

Waste water streams from different processes (different compounds and concentrations) are treated in sequence to minimise running costs. The treatment is performed continuously and is fully automated. It needs low manpower for operation.

Although recycling of the iron catalyst is possible, it is not always necessary; for example, where subsequent treatment in a waste water treatment plant uses iron for phosphate removal or at least for sludge dewatering.

Typical dosage of chemicals for the oxidation process is (e.g. for COD = 8500 mg/l):

- 13 l H₂O₂-solution (35 %)/m³ waste water (1.53 l H₂O₂-solution/m³ and 1000 mg/l)
- 35 ml H₂SO₄ (30 %)/m³ waste water
- 120 g Fe²⁺/ m³ waste water.

Cross-media effects

The operation of the oxidation reactor requires electricity, but the amount is not significant.

Applicability

The oxidation technique is applicable to both new and existing installations.

Segregation of the selected streams (preferably automatically) is required, along with the necessary pipe-work and equalisation tanks. The space requirement for an oxidation reactor and chemicals feed tanks is not significant and does not represent a limitation.

Economics

Investment cost for a reactor with a flow of 4 - 5 m³/h (including reactor, dosing system for hydrogen peroxide and catalyst, heat exchanger, catalyst preparation unit, automated control and pipe-work) is about 230000 euros. Operation cost, including above-mentioned dosage of chemicals, maintenance, labour and electricity, is about 3 euros/m³. It should be emphasized that this number is for the treatment of the selected high-loaded waste water streams and not for the whole of the mixed waste water.

Driving force for implementation

Difficulty in complying with standards set by municipal waste water treatment plant in terms of COD-load, biodegradability and toxicity.

Reference plants

One plant that has been in operation at Schoeller Textil AG, CH-9475 Sevelen since 1996; the flow is 4 - 5 m³/h. A second and third plant are under construction for Tintoria di Stabio SA, CH-6855 Stabio and Givaudan Vernier SA, CH-1214 Vernier [179, UBA, 2001].

Reference literature

[51, OSPAR, 1994], [179, UBA, 2001]

4.10.8 Waste water treatment by flocculation/precipitation and incineration of the resulting sludge

Description

Treatment of textile waste water by precipitation/flocculation in order to reduce organic load and especially colour has been performed for more than 100 years. However, today there are techniques that minimise the quantity of sludge produced and reduce negative effects associated with its disposal. Instead of landfill disposal, the sludge can be incinerated using state-of-the-art technology.

In modern plants the precipitate is separated from the aqueous phase not just by sedimentation but also by dissolved air flotation. Flocculation agents are specifically selected in order to maximise COD and colour removal, and to minimise sludge formation. In most cases, best performances are obtained with a combination of aluminum sulphate, cationic organic flocculant and very low amounts of an anionic polyelectrolyte.

Although at high concentration (>500 mg/l) sulphates become aggressive against concrete, the use of sulphate is preferred to chloride. Sulphates are easier to remove from water than chlorides. Moreover, the use of sulphate avoids the introduction of chlorides in the waste water and in the sludge to be incinerated [281, Belgium, 2002].

Iron sulphate is equally effective for the removal of COD and can also be considered as coagulant (e.g. it is particularly effective for removing acrylates and other substances from

pigment printing waste water). The introduction of iron has advantages (it is responsible for the activation of redox processes, it can be recycled, etc.), but it forms coloured complexes that remain in solution giving it a yellowish brownish tint [281, Belgium, 2002].

Main achieved environmental benefits

Typically COD removal is only about 40 – 50 %. When the effluent has a high content of water-insoluble compounds (e.g. in waste water from pigment printing sections), COD-removal is higher. De-colouration is more than 90 %.

The sludge is fully mineralised in an incineration plant.

Operational data

Before flocculation/precipitation, the textile waste water is equalised. However equalisation time can be shorter (about 12-h) than with biological treatment. Fibres are removed by a sieve.

The dosage of flocculants (e.g. for a mixed effluent with COD of ca. 1000 mg/l) is about:

- aluminium sulphate: 400 - 600 mg/l
- cationic organic flocculant: 50 - 200 mg/l
- anionic polyelectrolyte: 1 - 2 mg/l.

The quantity of sludge produced is about 0.7 - 1 kg of dry matter/m³ treated waste water. Usually, the sludge is dewatered in a chamber filter press to reach a dry matter content of about 35 - 40 % (3 kg of sludge are therefore produced for 0.5 kg of COD removed).

Cross-media effects

A considerable amount of organic compounds is shifted from the aqueous phase to the sludge. However, the sludge is incinerated and thus mineralised.

Energy is consumed for dewatering, transport and incineration.

Applicability

The technique is applicable to both new and existing installations.

4.10.9 Air emission abatement techniques

Description

The following off-gas abatement techniques can be used in textile finishing:

- oxidation techniques (thermal incineration, catalytic incineration)
- condensation techniques (e.g. heat exchangers)
- absorption techniques (e.g. wet scrubbers)
- particulates separation techniques (e.g. electrostatic precipitators, cyclones, fabric filters)
- adsorption techniques (e.g. activated carbon adsorption).

The description and the performance of these techniques are treated in detail in another BREF ([196, EIPPCB, 2001]). Depending on the type of air stream and pollutants to be treated, they can either be used as single treatments or be applied in combination. Typical applied systems are:

- wet scrubbers
- combination of wet scrubber and electrostatic precipitation
- combination of heat exchanger, aqueous scrubber and electrostatic precipitation
- heat exchangers (primarily used for energy saving, but partial condensation of certain pollutants is also achieved)
- adsorption on activated carbon.

Main achieved environmental benefits

Reduction of volatile organic carbon (VOC), particulates and special toxic substances in the off-gas as well as minimisation of odour nuisances.

Operational data

To achieve high operational reliability, adjustment of the appropriate operating conditions and proper maintenance (in some cases a weekly inspection and cleaning of the devices) of the equipment is crucial [179, UBA, 2001].

Cross-media effects

The high energy demand and corresponding high amounts of CO₂ resulting from thermal and catalytic incineration need to be addressed (greenhouse effect). However, this disadvantage can be considered to be outweighed by the benefit in terms of organic compounds removed [179, UBA, 2001].

In wet scrubbers, the pollutants are shifted from off-gas to the waste water. Efficient waste water treatment (e.g. oil/water separators, biological waste water treatment) is required.

Applicability

Off-gas cleaning can be installed in both new and existing installations. However if existing machinery has to be rebuilt, applicability can be limited by economic, technical and logistical factors.

In each case, for the installation of an off-gas cleaning system, a tailor-made solution using the above-mentioned techniques has to be developed. In general, however, the following considerations about the applicability of the different abatement techniques have to be borne in mind.

Oxidation techniques

The disadvantage of thermal incineration is the high energy consumption for heating the off-gas to at least 750 °C. After incineration, the temperature of the cleaned off-gas is around 200 °C to 450 °C. The textile industry does not have a demand for thermal energy in this sort of amount so most of it would be wasted.

Another problem arises from the gas-air-mixture typical of exhaust air from textile finishing. In the textile industry, most of the emissions to be treated are characterised by high off-gas flows, but relatively low load.

Moreover, the characteristics of the off-gases are often subject to fluctuation, leading to inefficient thermal incineration.

In catalytic incineration, phosphorus compounds, halogens, silicones and heavy metals can poison the catalyst. These compounds are quite common in the textile industry, so special care has to be taken when using catalytic oxidation in this sector.

Catalytic oxidation with full heat recovery is applied in some mills for treating off-gases arising from singeing operations (see Section 2.6.1.1). The hot gas at the outlet of the catalytic afterburner, is drawn through air-to-water heat exchangers: the hot water generated by the cooling process is used in the pretreatment process. The gas (with its remaining thermal content) is further used in the drying step taking place after the pretreatment process [281, Belgium, 2002].

Condensation techniques

Pollutants with a high volatility and, in most cases, odour-intensive substances are removed.

Absorption techniques

The efficiency of wet scrubbers in textile finishing depends strongly on process-specific parameters. Normally the efficiency is in the range of 40 to 60 %. Applicability for water-insoluble pollutants is limited.

Electrostatic precipitation

Electrostatic precipitators can precipitate dusts and aerosols with a size of 0.01 to 20 μm . Maximum efficiency will be reached at around 0.1 μm – 1.5 μm . Manufacturers therefore recommend installing a mechanical filter before the electrostatic filter, which precipitates most of the particles with size $> 20 \mu\text{m}$.

The efficiency of electrostatic precipitators for particle-sized solid and liquid pollutants is in the range of 90 % to 95 %. Gaseous pollutants and odorous substances cannot be precipitated. For best overall efficiency, it is therefore important that almost all condensable substances, emitted as aerosols, are removed before reaching the electrostatic precipitator. This can be achieved by heat exchangers or scrubbers.

Electrostatic precipitation in combination with heat exchangers or scrubbers is successfully applied in the treatment of fumes emitted from the stenters where the fabric is submitted to thermofixation.

The combination of electrostatic precipitation with heat exchangers (dry electrofiltration) is particularly advantageous when this operation is carried out as a first treatment step before washing. The oils and preparation agents present on the grey fabric evaporate and give rise to a dense smoke also associated with odour emissions. This off-gas can be treated in four steps:

- 1) mechanical filtration
- 2) cooling and condensation (the suspended condensable compounds are separated in the form of oily droplets and thermal energy is recovered)
- 3) ionisation/ electrofiltration
- 4) collection of the condensates and separation of the oily phase from the aqueous phase in a static decanter.

One of the advantages of this dry electrofiltration system is that the oily condensates (mineral oils, silicone oils, etc.) are collected separately and thus recovered instead of being transferred to the water effluent (e.g. via a scrubber). Energy recovery is another advantage of this technique. Recovered energy (35 – 40 % of the supplied amount) can be used to preheat the fresh air supplied to the stenter or to heat up process water.

Economics

Installation and running costs have to be considered. In particular, costs of equipment maintenance and energy should be considered. Detailed information about costs is reported in another BREF ([196, EIPPCB, 2001]). Among the above-mentioned techniques, oxidation techniques have by far the highest investment and operating costs.

Specific information about dry electrofiltration (combination of heat exchangers and electrostatic precipitation) has been submitted for the present document. A capital investment of EUR 70000 is reported for a 10000 m³/h unit with a pay-back time of less than 3 years [44, Comm., 2000].

Driving force for implementation

Need to comply with standards set by environmental legislation for air pollution and improving environmental performance in terms of odour nuisances.

Reference plants

Many plants. Systems based on heat exchangers, aqueous scrubbers and electrostatic precipitators dominate [179, UBA, 2001].

Reference literature

[179, UBA, 2001], [281, Belgium, 2002], [44, Comm., 2000].

4.10.10 Waste water treatment in wool scouring installations

Description

The INTERLAINE report describes a number of available options for the management of water emissions arising from wool scouring installations. Clearly not all options can be considered BAT. Nevertheless it is useful to discuss the environmental performances and economic implications involved in each of the following scenarios:

- A. treatment in external municipal sewage treatment plant. It consists of screening the effluent to remove gross solids (>3mm), perhaps cooling the effluent, and/or adjusting its pH to the sewerage undertaker's requirements and disposing of the effluent to sewer
- B. treatment in an integrated dirt removal/grease recovery loop followed by discharge to municipal sewer. It is assumed that the mill installs a dirt removal/grease recovery loop, which recovers 25 % of the grease and removes 50 % of the dirt and a further 10 % of the grease from its effluent as a sludge
- C. treatment by coagulation/flocculation followed by discharge to municipal sewer. This technique supposes that the small scourer, rather than installing a dirt removal/grease recovery loop, opts to install on-site end-of-pipe effluent treatment, using coagulation/flocculation. Treated effluent is discharged to sewer
- D. treatment in an integrated dirt removal/grease recovery loop followed by coagulation/flocculation before discharge to municipal sewer (B+C)
- E. treatment by evaporation. The technique consists of evaporating the effluent, recycling the condensate if practicable and disposing of the residual concentrate or sludge. Not all mills analysed in the survey using evaporators recycle the condensates. It may be significant that the two mills analysed in the survey which do recycle the condensate, both employ a biological treatment as well as evaporation within the effluent recycling loop. One mill uses anaerobic lagooning before evaporation and the other uses a rapid bio-reactor after evaporation. It is possible that the biological treatments destroy the compounds responsible for odours
- F. treatment in an integrated dirt removal/grease recovery loop combined with evaporation (B+E)
- G. biological treatment (no data was made available for this technique).

Achieved emission levels

The environmental performance of the proposed techniques have been estimated based on the following assumptions:

- for coarse greasy wool: 315 g/kg COD with 50 g/kg of grease and 150 g/kg of dirt
- for fine greasy wool: 556 g/kg COD with 130 g/kg of grease and 150 g/kg of dirt
- untreated effluent contains 95 % of the COD and dirt from the fibre
- the sewage treatment plant removes 80 % of the incoming COD
- the dirt/grease recovery loop recovers 25 % of the grease and removes 50 % of the dirt. It is assumed that a further 10 % of the grease is removed from the effluent as a sludge, before discharge to the sewer. For scouring lines fitted with a dirt/grease recovery loop a net water consumption of 6 l/kg greasy wool has been assumed, but levels of 2 - 4 l/kg are possible
- the coagulation/flocculation treatment removes 89 % of the grease and 86 % of the suspended solids from the effluent
- in the absence of a dirt/grease recovery loop, effluent volume is assumed at 13 l/kg greasy wool
- evaporation does not entirely remove pollutants. Here it is assumed that the evaporator removes 99.3 % of the grease and 99.9 % of suspended solids. In trials at one mill, removal of sheep ectoparasiticides was: OCs, 96.5 %; OPs, 71.5 %; SPs 100 %. Water from the evaporator can be recycled. The residual COD (200 - 900 mg/l) and suspended solids (20 - 40 mg/l) in the condensate are no detriment to adding the recovered water to the rinse bowls of the scour (even the final rinse bowl operates at much higher contaminant levels than this). On the other hand, recycling requires an extra treatment process in order to avoid ammonia and odorous compounds being carried back to the scour. Water saving achievable by recycling of the condensate is not considered in the tables below.

The results of the calculations are reported in Table 4.46 and Table 4.47 for coarse and fine wool scourers, respectively.

Coarse wool	Discharge to sewer	Dirt/grease loop	Flocculat.	Dirt/grease loop + flocculat.	Evaporat.	Dirt/grease loop + evaporat.
Unit/t of greasy wool	A	B	C	D	E	F
Net water consumed (m ³)	13	6 ⁽¹⁾	13	6 ⁽¹⁾	13	6
COD from the mill (kg)	299	203 ⁽³⁾	93 ⁽⁴⁾	81	3.2	2.7
COD to environment (kg)	60	41	19	16	0.6	0.5
Sludge to dispose of ⁽²⁾						
- from rec. loop (kg)		152		152		152
- from floccul. (kg)			329	186		
- from evapor. (kg)					378	212
Source: [187, INTERLAINE, 1999]						
(1) 2 - 4 l/kg is possible						
(1) wet weight (50 % dry weight)						
(2) removal of 35 % of the grease and 50 % of the dirt in the loop reduces the COD from 315 kg/t in the incoming wool to 203 kg/t in the effluent						
(3) removal of 89 % of the grease and 86 % of the dirt reduces the COD from 315 kg/t in the incoming wool to 93 kg/t of wool in the effluent						

Table 4.46: Waste water treatment techniques: Environmental performance – coarse wool

Fine wool	Discharge to sewer	Dirt/ grease loop	Flocculat.	Dirt/ grease loop + flocculat.	Evaporat.	Dirt/ grease loop + evaporat.
Unit/t of greasy wool	A	B	C	D	E	F
Net water consumed (m ³)	12	6 ⁽¹⁾	12	6 ⁽¹⁾	12	6 ⁽¹⁾
COD from the mill (kg)	529	352	118	97.4	4.8	3.7
COD to environment (kg)	106	71	24	19.5	1.0	0.7
Sludge to dispose of ⁽²⁾						
- from rec. loop (kg)		167		167		167
- from floccul. (kg)			464	287		
- from evapor. (kg)					529	326

Source: [187, INTERLAINE, 1999]
(1) 2 - 4 l/kg is possible
(2) wet weight (50 % dry weight)

Table 4.47: Waste water treatment techniques: Environmental performance – fine wool

No precise information has been submitted for effluent treatment by biological processes. It is known that there are scourers in Europe using biological processes as their main methods of effluent treatment. Biological treatment of scouring effluent is particularly popular amongst Italian scourers. One medium-sized Italian mill is known to employ anaerobic biological treatment, flocculation and prolonged aerobic biological treatment in succession for effluent treatment (total biological treatment time is approximately 7 days). This mill claims to produce an effluent containing only 650 mg/l COD, which is discharged to sewer. Another Italian mill uses a 3-day anaerobic process, followed by coagulation/flocculation (FeCl₃) to produce an effluent containing 1000 – 1200 mg/l COD, which is again discharged to sewer [187, INTERLAINE, 1999].

Several remotely-situated Australian mills use anaerobic/aerobic lagooning for effluent treatment, but it is doubtful if any European mill has the space for such a process, not to mention the lack of neighbours which its odour generation potential would affect [187, INTERLAINE, 1999].

Operational data

The concentrate or sludge from evaporation contains suint as well as dirt and grease. Sludges from coagulation/flocculation contain only dirt and grease because suint is highly water-soluble and is not flocculated. The presence of suint (largely potassium salts) in the sludge from evaporation appears to alter its physical properties. Flocculated sludge is spadeable and, depending on its water content, varies in consistency from something resembling moist earth to semi-liquid mud. Evaporator condensate, however, may be liquid at relatively high temperature and solid at ambient temperature. It appears that the suint salts act as a flux at the temperatures prevailing in the evaporator. This makes evaporator sludge more difficult to handle and to dispose of.

The sludge has been reported to have been transported as a liquid in a heated tanker for disposal to a landfill accepting heated liquids ([187, INTERLAINE, 1999]). However, the implementation of the Landfill Directive (Council Directive 1999/31/EC) required the cessation of the landfilling of liquids (and other problem wastes) by July 2001. Alternatives need to be sought and include: incineration, pretreatment to an acceptable solid form prior to landfilling (e.g. by composting, see Section 4.10.11), or composting and use on land (see Section 4.10.11), or use in other processes such as brick-making (see Section 4.10.12).

Cross-media effects

Options in which the effluent is treated on-site or off-site in municipal sewer, without dirt removal/grease recovery loop simply produce a shift of the organic load from the aqueous phase to the sludge.

Both mechanical and thermal energy are used in the process of evaporation. However, the mechanical energy is not high and most of the thermal energy is recovered in a well-designed evaporator [187, INTERLAINE, 1999].

Applicability

Apart from option A (treatment in external municipal sewer) which could find applicability only in cases where the discharge of the effluent would not cause environmental harm to the sewer (small scourer discharging effluent in a large sewage treatment plant), the other options are all applicable to any scouring mill.

Economics

The economics aspects involved for each of the proposed options have been discussed in detail (INTERLAINE, 1999 #187]). Table 4.49 and Table 4.50 summarise the information in the reference for a small scouring plant (3500 tonnes/year) and a medium-sized plant (15000 tonnes/year), scouring coarse wool. Similar results can be found for fine wool scourers, except for the factors related to the higher grease content of fine wool: this produces negative on-site running costs (savings) for all options which include grease recovery. Economies of scale are not expected to increase very much for mills with higher throughput than 15000 tonnes/year.

The capital costs for installation of dirt/grease loops used in the tables below are 412500 euros for the small mill and 825000 euros for the medium mills. The loops in the larger mills carry a much greater flow and these costs are believed to be realistic. The capital cost of flocculation plants at the larger mills is believed to be about 275000 euros and it is not believed that a smaller capacity plant would be much less expensive.

The capital costs for evaporators are somewhat more speculative. The following costs are assumed: capacity 21000 m³/year, cost 1.2 million euros; capacity 45500 m³/year, cost 1.8 million euros; capacity 60000 m³/year, cost 2.4 million euros; capacity 90000 m³/year, cost 3.0 million euros; capacity 120000 m³/year, cost 3.6 million euros.

On-site running costs are net of grease sales, hence the negative costs in some cases where grease recovery loops are installed. Calculations were based on the following unit costs.

On-site unit costs	euros
Water	0.68/m ³
Heat	0.51/m ³
Process chemicals	
- Detergent	1400/t
- Soda	268/t
Grease ⁽¹⁾	380/t
Running costs, dirt/grease recovery loop	
- Power	0.56/m ³
- Labour	18000/yr
- Maintenance	45000/yr
Running costs, flocculation plant	
- Chemicals	2.74/m ³
- Power	0.28/m ³
- Labour	12000/yr
- Maintenance	22500/yr
Running costs, evaporation plant	
- Power	1.82/m ³
- Labour	18000/m ³
- Maintenance	65000/m ³
Sludge (50 % dry weight) disposal costs	
- Sludge from flocc. and dirt/grease recovery	41/t
- Concentrate from evaporator	95/t
Source: [187, INTERLAINE, 1999]	
⁽¹⁾ The price of the recovered grease is very variable: in Section 4.4.1 a price of 2 euros/kg (I.M. Russell personal communication) has been assumed for calculations	

Table 4.48: Unit costs

Sludge disposal costs are those prevailing at present in UK for landfill (41 euros/t for wet sludge from flocculation and dirt/grease recovery plant and 95 euros/t for concentrate from the evaporator). They include landfill tax (15 euros per tonne) and transport.

Sludge disposal costs do not take account of any changes consequent to the introduction of the Landfill Directive.

Effluent disposal costs are also values from UK (calculated according to the standard Modgen strength formula) and are believed to reflect full economic cost [187, INTERLAINE, 1999].

Item	Effluent treatment technique					
	Discharge to sewer	Dirt/grease loop	Floccul.	Dirt/grease loop and flocculator	Evaporat.	Dirt/ grease loop and evaporat.
Costs Unit: euro						
Initial capital cost	0	412500	250000	662500	1812500	1612500
Annual capital cost	0	41250	25000	66250	181250	161250
On-site annual running cost	0	17304	166072	115224	139972	118524
Annual sludge disposal cost (50 % dry weight)	0	21812	47305	48498	125845	92576
Annual effluent disposal cost	694515	413775	181982	133450	28881	14900
Total annual cost	694515	494121	420359	363422	475948	387250
Cost/tonne wool	198	141	120	104	136	111
NPV of 10yr cashflow(a)	6.1 m	4.4 m	3.7 m	3.3 m	4.4 m	3.6 m
Source: [187, INTERLAINE, 1999]						
(a) Net present value of 10 year cashflow at 3 % interest rate.						

Table 4.49: Costs of effluent treatment options for a scouring mill processing 3500 t/yr of coarse wool

Item	Effluent treatment technique					
	Discharge to sewer	Dirt/grease loop	Floccul.	Dirt/grease loop and flocculator	Evaporat.	Dirt/grease loop and evaporat.
Costs. Unit: Euro						
Initial capital cost	0	825000	275000	1075000	3625000	3225000
Annual capital cost	0	82500	27500	107500	362500	322500
On-site annual running cost	0	(315615)	300480	(99915)	204980	(123415)
Annual sludge disposal cost (50 % dry weight)	0	102828	285932	279953	754418	567415
Annual effluent disposal cost	4203305	2559983	876175	644386	92852	53648
Total annual cost	4203305	2429696	1490086	931564	1414749	820148
Cost/tonne wool	280	162	99	62	94	55
NPV of 10yr cashflow(a)	36.9 m	21.4 m	13.1 m	8.3 m	12.9 m	7.6 m
Source: [187, INTERLAINE, 1999]						
(a) Net present value of 10 year cashflow at 3 % interest rate.						

Table 4.50: Costs of effluent treatment options for a scouring mill processing 15000 t/yr of coarse wool

For small mills processing coarse wool, from an economic point of view, the installation of a dirt/grease loop and a flocculation plant appears to be the best option. Rapid payback is achieved (versus discharge to sewer) and this option has the lowest total cost over 10 years as well as the lowest NPV of 10-year cashflow.

The environmental performance of an evaporation plant is far superior to that of the flocculation plant. However, the initial cost of the evaporation plant is much higher and payback (versus discharge to sewer) is not achieved for 4 – 5 years.

The value of installing a dirt removal/grease recovery plant is clearly illustrated in the costings, even for this small mill, processing wool with a low grease content. When used in combination

with an evaporator, the loop enables a reduction in capital outlay because a smaller evaporator can be used.

For medium-sized mills, evaporation is slightly cheaper than flocculation over 10 years and has superior environmental performance. Again, the use of a dirt removal/grease recovery loop enables a smaller evaporator to be installed and reduces initial capital outlay.

The use of a dirt removal/ grease recovery loop allows also a reduction in running costs thanks to the proceeds from the sales of the grease. This effect is more significant for fine wool scouring mills because of the higher percentage of good quality grease. The loop also has a significant effect in reducing sludge disposal costs when used in combination with the evaporator. This is because the physical properties of evaporator concentrate make its transport and disposal difficult and expensive, so it is sensible to remove as much material from the effluent as possible before it is evaporated.

Reference literature

[187, INTERLAINE, 1999].

4.10.11 Disposal of wool scouring sludge to agricultural land

Description

In most member states, conditions set in existing regulations make it necessary to pretreat wool scour sludges before disposal to agricultural land. The pretreatment of choice appears to be composting, although anaerobic digestion (with recovery of the evolved methane) might conceivably be considered as an alternative.

Material for composting⁹ should ideally have a C:N ratio of 25 – 30:1, which means that wool scour sludges need an addition of carbon-rich material. Green waste, sawdust, woodchip and straw have reportedly been used successfully. Some “structural material” (size up to 50mm) is needed in the co-composted material in order to allow the ready ingress of air. Optimum moisture content of the material for composting is 50 – 60 %.

Aeration of the material is used to control the rate of composting and therefore the temperature. In the earlier thermophilic phase a temperature of 45 – 60 °C is optimum, whilst in the later mesophilic phase, lower temperatures (20 – 45 °C) are preferred.

There are many methods of composting in commercial production. They include methods described as follows:

- open air, turned windrows
- open air, with forced aeration
- covered building, forced aeration
- simple tunnel, non-turning
- complex tunnel, with turning
- enclosed hall, operating under negative pressure
- reactor systems.

Enclosed, or in-vessel composting systems have advantages over open air systems that make in-vessel composting particularly suited for industrial wastes. First, control of the process is improved, allowing the use of higher temperatures and higher rates of composting. Second,

⁹ *The State of Composting in the UK and A Guide to In-Vessel Composting plus a Directory of Systems*, The Composting Association, Ryton Organic Gardens, Coventry CV8 3LG, UK.

control of odours, dust and leachate is superior, allowing operation closer to industrial waste sources. The disadvantage of enclosed systems is their greater initial cost.

After composting, the compost must be allowed to mature for a number of weeks during which time, further (bio-)chemical changes occur, making the compost more suitable for purpose.

Main achieved environmental benefits

It is believed that composting is a sustainable means of disposal of wool scour sludge, whilst at the same time producing a useful soil conditioner. The carbon which is decomposed by the composting process is converted aerobically into carbon dioxide, rather than methane (as in landfill). Carbon dioxide is a much less potent greenhouse gas than methane [187, INTERLAINE, 1999].

Operational data

For wool scour sludges, the purpose of composting is to destroy, as far as possible, the components of the sludges which would be undesirable if spread on agricultural land. In the main, these are wool grease and ectoparasiticide residues. Composts produced from mixtures containing wool grease should therefore be periodically monitored for grease and ectoparasiticide content.

In composting trials carried out in UK¹⁰ similar results were achieved by composting for 6 – 7 weeks in a 10-tonne open windrow and for 14 days in an enclosed tunnel composter. The grease, organochlorine and synthetic pyrethroid ectoparasiticide content of the compost were reduced by 60 % and organophosphate ectoparasiticides were reduced by 80 %. Further reductions were expected during the maturation phase, but were not monitored. Interestingly, the wood chip and sawdust used as co-compostable material in this trial was found to be contaminated with lindane (OC) [187, INTERLAINE, 1999].

Cross-media effects

Composting can cause air pollution by odours and dust and water pollution via leachate. In a well-conducted composting operation, however, these problems should not occur. The use of compost as a soil conditioner may also cause water pollution if ectoparasiticide residues are present. However, this is thought to be highly unlikely if the composts are used responsibly because of the very poor mobility of sheep ectoparasiticides in soil [187, INTERLAINE, 1999].

Applicability

This measure is applicable on-site by scourers who have the required space. Off-site, it is widely available, though costs of transport (because of distance from merchant composters) might be a problem for some scourers.

Availability of this option, both on-site and merchant may increase after the implementation of the Landfill Directive (1999/31/EC).

Economics

Composting is not an inexpensive technique. Capital costs are reported in the next figure for recent start-ups, while Table 4.51 gives information for in-vessel systems.

¹⁰ M Madden, ENco, personal communication, 1998.

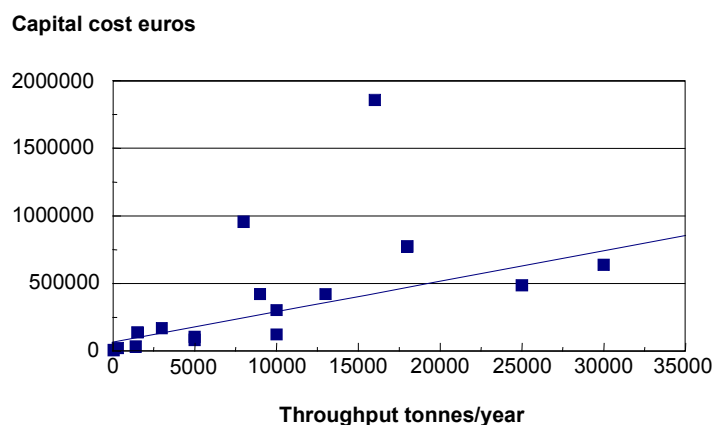


Figure 4.47: Capital cost of recent composting plant start-ups in UK. (Source: The Composting Association, UK)
[187, INTERLAINE, 1999]

System	Composting time days	Maturation time days	Capital cost euros/10000 t/yr	Treatment cost euros/t
Bay	7 – 36	0 – 120	450 – 2250K	9 – 75
Container	10 – 20	30 – 100	450 – 1500K	15 – 45
Tunnel	6 – 30	0 – 56	75 – 3000K	9 – 45

Source:
[187, INTERLAINE, 1999] with reference to “The Composting Association, UK”

Table 4.51: Composting and maturation times, capital and treatment costs, for three types of in-vessel composting plant

The market for compost is uncertain. The Composting Association (UK) reports that no composting plant in the country can recover its costs through sales of compost. In fact, most plants receive no payment at all for their product. The cost of composting therefore has to be met through gate charges, or in the case of local authorities composting municipal waste, through local taxes.

Driving force for this technique

The implementation of the Landfill Directive will stop landfill of liquids. The future landfill of sludge is not clear. Composting provides a relatively low-tech, low cost means of treating wool scour sludge to give a material that can be used or more readily disposed of to landfill.

Reference plants

Mills C, F, G and M in the survey reported in Section 3.2.1 use this method of sludge disposal.

Reference literature

[187, INTERLAINE, 1999]

4.10.12 Use of wool scour sludge in brick-making

Description

Clay for brick-making should contain a certain amount of organic material. The oxidation of this material during the brick-firing process improves the quality of the resulting bricks. Some

clays are deficient in organic content and an addition is desirable. Wool scour sludges are excellent in this application.

Main achieved environmental benefits

The sludge is used in the manufacture of a useful product and the organic material required for admixture with the clay might otherwise be derived from fossil sources.

Operational data

It might be necessary to monitor trial firings using wool scour sludges to check that air emissions from the brickworks are not adversely affected.

Cross-media effects

Air emissions might be increased, although this is believed unlikely. If sludges have to be transported long distances, the question of pollution arising from transport has to be considered.

Applicability

The problems encountered in implementing this measure are logistical rather than technical. The difficulty is to match a scourer's sludge production with a brick-maker's requirements and location.

Economics

This is greatly dependent on the deal struck between the scourer and the brick-maker and the cost of alternative sources of suitable organic material available to the latter. It would seem likely that this technique should be cheaper than landfilling, composting or incineration.

Driving force for implementing this technique

For the scourer, cost would be the driving force. For the brick-maker, the availability of a reasonably consistent source of suitable material (probably available cost-free).

Reference plants

Mills L and N in the survey reported in Section 3.2.1 use this method for disposal of some of their sludge production. It is also known that the technique is utilised by some Italian scourers.

Reference literature

[187, INTERLAINE, 1999]

5 BEST AVAILABLE TECHNIQUES

In understanding this chapter and its contents, the attention of the reader is drawn back to the preface of this document and in particular the fifth section of the preface: “How to understand and use this document”. The techniques and associated emission and/or consumption levels, or ranges of levels, presented in this chapter have been assessed through an iterative process involving the following steps:

- identification of the key environmental issues for the sector
- examination of the techniques most relevant to address those key issues
- identification of the best environmental performance levels, on the basis of the available data in the European Union and world-wide
- examination of the conditions under which these performance levels were achieved; such as costs, cross-media effects, main driving forces involved in implementation of the techniques
- selection of the best available techniques (BAT) and the associated emission and/or consumption levels for this sector in a general sense all according to Article 2(11) and Annex IV of the Directive.

Expert judgement by the European IPPC Bureau and the relevant Technical Working Group (TWG) has played a key role in each of these steps and in the way in which the information is presented here.

On the basis of this assessment, techniques, and as far as possible emission and consumption levels associated with the use of BAT, are presented in this chapter that are considered to be appropriate to the sector as a whole and in many cases reflect current performance of some installations within the sector. Where emission or consumption levels “associated with best available techniques” are presented, this is to be understood as meaning that those levels represent the environmental performance that could be anticipated as a result of the application, in this sector, of the techniques described, bearing in mind the balance of costs and advantages inherent within the definition of BAT. However, they are neither emission nor consumption limit values and should not be understood as such. In some cases it may be technically possible to achieve better emission or consumption levels but due to the costs involved or cross-media considerations, they are not considered to be appropriate as BAT for the sector as a whole. However, such levels may be considered to be justified in more specific cases where there are special driving forces.

The emission and consumption levels associated with the use of BAT have to be seen together with any specified reference conditions (e.g. averaging periods).

The concept of “levels associated with BAT” described above is to be distinguished from the term “achievable level” used elsewhere in this document. Where a level is described as “achievable” using a particular technique or combination of techniques, this should be understood to mean that the level may be expected to be achieved over a substantial period of time in a well maintained and operated installation or process using those techniques.

Where available, data concerning costs have been given together with the description of the techniques presented in the previous chapter. These give a rough indication about the magnitude of costs involved. However, the actual cost of applying a technique will depend strongly on the specific situation regarding, for example, taxes, fees, and the technical characteristics of the installation concerned. It is not possible to evaluate such site-specific factors fully in this document. In the absence of data concerning costs, conclusions on economic viability of techniques are drawn from observations on existing installations.

It is intended that the general BAT in this chapter are a reference point against which to judge the current performance of an existing installation or to judge a proposal for a new installation. In this way they will assist in the determination of appropriate "BAT-based" conditions for the

installation or in the establishment of general binding rules under Article 9(8). It is foreseen that new installations can be designed to perform at or even better than the general BAT levels presented here. It is also considered that existing installations could move towards the general BAT levels or do better, subject to the technical and economic applicability of the techniques in each case.

While the BAT reference documents do not set legally binding standards, they are meant to give information for the guidance of industry, Member States and the public on achievable emission and consumption levels when using specified techniques. The appropriate limit values for any specific case will need to be determined taking into account the objectives of the IPPC Directive and the local considerations.

5.1 Generic BAT (whole textile industry)

The textile industry is a fragmented and heterogeneous sector, composed of a wide number of sub-sectors. The nature of waste generated depends on the type of textile facility, the processes being operated and the fibres used. Despite this complexity, a number of techniques can be defined as general BAT applicable to all types of textile operations, regardless of the processes they use or the products they produce.

Management

Technology by itself is not sufficient; it needs to go together with environmental management and good housekeeping. Management of an installation that uses potentially polluting processes requires the implementation of many of the elements of an Environmental Management System (EMS).

BAT is to:

- implement environmental awareness and include it in training programmes
- apply good practices for maintenance and cleaning (see 4.1.1)
- store each chemical according to the instructions given by the manufacturer in the Material Safety Data Sheets and follow the indications given in the horizontal BREF on Storage (in preparation at the time of writing)
- put in place measures to avoid spillage of chemicals and process liquors. If spillage does occur, containment procedures must be available as well as a means of cleaning up and disposing of the spillage safely. It should be impossible for spillage to enter surface waters or sewer
- implement a monitoring system for process inputs and outputs (both on-site and on-process level), including inputs of textile raw material, chemicals, heat, power and water, and outputs of product, waste water, air emissions, sludges, solid wastes and by-products. A good knowledge of the process inputs and outputs is a prerequisite for identifying priority areas and options for improving environmental performance.

Dosing and dispensing of chemicals (excluding dyes)

BAT is to install automated dosing and dispensing systems which meter the exact amounts of chemicals and auxiliaries required and deliver them directly to the various machines through pipework without human contact. The water used for washing the preparation vessel and supply pipes is taken into account when the quantity of prepared liquor is calculated. Other systems use individual streams for each of the products to be delivered. In this way the chemicals are not premixed before being introduced into the applicator or machine and there is no need to clean containers, pumps and pipes before the next step. More information about automated dosing and dispensing systems is given in Section 4.1.3.

Selection & use of chemicals

BAT is to follow certain general principles in selecting chemicals and managing their use:

- where it is possible to achieve the desired process result without the use of chemicals, then avoid their use altogether
- where this is not possible, adopt a risk-based approach to selecting chemicals and their utilisation mode in order to ensure the lowest overall environmental risk.

There are a number of lists and classification tools for chemicals. Some examples of tools for selecting/ assessing chemicals, according to their relevance to water and air impact are described in Sections 4.3.1 and 4.3.2. Modes of operation that ensure the lowest overall risk include techniques such as closed-loops and the in-loop destruction of pollutants. Of course, it is essential that due recognition be given to relevant Community legislation.

Following these principles, a number of detailed BAT conclusions arise. These are listed below.

For surfactants BAT is to substitute alkylphenol ethoxylates and other hazardous surfactants with substitutes that are readily biodegradable or bioeliminable in the waste water treatment plant and do not form toxic metabolites (as described in Section 4.3.3).

For complexing agents BAT is to:

- avoid or reduce the use of complexing agent in pretreatment and dyeing processes by a combination of:
 - softening of fresh water to remove the iron and the hardening alkaline-earth cations from the process water
 - using a dry process to remove coarse iron particles from the fabric before bleaching (magnetic detectors are installed on continuous pretreatment lines as described in Section 4.5.6). This treatment is convenient when the process starts with an oxidative/desizing step, otherwise a huge amount of chemicals would be required to dissolve the coarse iron particles in a wet process. However, this step is not necessary when an alkaline scouring treatment is carried out as a first step before bleaching
 - removing the iron that is inside the fibre using acid demineralisation, or better, non-hazardous reductive agents (see Section 4.5.6), before bleaching heavily contaminated fabrics
 - applying hydrogen peroxide under optimal controlled conditions as described in Section 4.5.6
- select biodegradable or bioeliminable complexing agents (as described in Section 4.3.4).

For antifoaming agents BAT is to:

- minimise or avoid their use by:
 - using bath-less air-jets, where the liquor is not agitated by fabric rotation
 - re-using treated bath
- select anti-foaming agents that are free from mineral oils and that are characterised by high bioelimination rates, as described in Section 4.3.5.

Selection of incoming fibre raw material

At present, textile manufacturers are not well informed by their suppliers about the quality and quantity of substances (e.g. preparation agents, pesticides, knitting oils) applied on the fibre during the upstream processes. Knowledge of these characteristics is essential to enable the manufacturer to prevent and control the environmental impact resulting from these substances.

BAT is to seek collaboration with upstream partners in the textile chain in order to create a chain of environmental responsibility for textiles. It is desirable to exchange information on the type and load of chemicals that are added and remain on the fibre at each stage of the product's life cycle. Besides specific contract conditions, a number of schemes exist such as the organic certification for cotton, the certification scheme applied in Germany for garments, etc. The table

below lists the BAT identified for a some raw materials for preventing at source the environmental impact arising from pollutants present on the fibre before it enters the finishing process. All measures assume that the fibre raw materials to textile processing are produced with some sort of quality assurance scheme so that the finisher can get the appropriate information about the types and amounts of contaminants.

Raw material	BAT
Man-made fibres	<ul style="list-style-type: none"> ▪ select material treated with low-emission and biodegradable/ bioeliminable preparation agents (see 4.2.1)
Cotton	<ul style="list-style-type: none"> ▪ select material sized with low add-on techniques (pre-wetting of the warp yarn, see 4.2.5) and high-efficiency bioeliminable sizing agents (see 4.2.4) ▪ use the available information to avoid processing fibre material contaminated with the most hazardous chemicals such as PCP ▪ use organically grown cotton when market conditions allow
Wool	<ul style="list-style-type: none"> ▪ use the available information to avoid processing fibre material contaminated with the most hazardous chemicals such as OC pesticides residues (see 4.2.7) ▪ minimise at source any legally used sheep ectoparasiticides by encouraging the development of low pesticide residue wool by continuing dialogue with competent bodies responsible for wool production and marketing in all producing countries (see 4.2.8) ▪ select wool yarn spun with biodegradable spinning agents instead of formulations based on mineral oils and/or containing APEO (see 4.2.2).

Table 5.1: BAT for selection of incoming fibre raw material

Water & energy management

Water and energy savings are often related in the textile industry because the main use of energy is to heat up the process baths. The following is a summary of the selected BAT for water and energy saving. The limitations in the applicability of the listed techniques are discussed in the cross-referenced sections.

BAT is to:

- monitor water & energy consumption in the various processes, as mentioned earlier and described in Section 4.1.2
- install flow control devices and automatic stop valves on continuous machinery (Sections 4.1.4 and 4.9.2)
- install automatic controllers for control of fill volume and liquor temperature in batch machines (Sections 4.1.1 and 4.6.19)
- establish well-documented production procedures in order to avoid wastage of resources from inappropriate work practices (Section 4.1.4)
- optimise scheduling in production and adjust processes in pretreatment to quality requirements in downstream processes (Section 4.1.1)
- investigate the possibility of combining different treatments in one single step (Sections 4.1.1 and 4.1.4)
- install low- and ultra-low liquor ratio machinery in batch processes (Sections 4.6.19 to 4.6.21)
- introduce low add-on application techniques in continuous processes (Section 4.1.4)
- improve washing efficiency in both batch and continuous processing, as described in Sections 4.9.1 and 4.9.2
- re-use cooling water as process water (also allowing heat recovery) (Section 4.1.1)

- investigate possibilities for water re-use and recycling by systematic characterisation of quality and volume of the various process streams in order to identify processes for which the substances contained in the various waste streams are still valuable and/or do not interfere with the quality of the product. For recycling purposes in batch processes it is convenient to install machinery with built-in features that facilitate recovery and re-use of waste streams. Examples of options for water re-use are reported in Sections 4.5.8 and 4.6.22
- fit hoods and covers ensuring full closure of machinery that could give rise to vapour losses (Sections 4.1.1 and 4.6.19)
- insulate pipes, valves, tanks, machines to minimise heat losses (Section 4.1.5)
- optimise boiler houses by applying re-use of condensed water, preheating of air supply, heat recovery from combustion gases (Sections 4.1.1, 4.4.3 and 4.8.1)
- segregate hot and cold waste water streams prior to heat recovery and recover heat from the hot stream (Sections 4.1.1 and 4.6.22)
- install heat recovery systems for off-gases (Sections 4.1.1, 4.4.3 and 4.8.1)
- install frequency-controlled electric motors (Section 4.1.1).

Management of waste streams

BAT is to:

- collect separately unavoidable solid waste
- use bulk or returnable containers.

5.2 Process-integrated measures for unit processes and operations

This section presents process-integrated measures for processes and operations covered in this document. End-of-pipe abatement measures are described in the next section. The presentation follows a unit process-basis approach indicating, where necessary, the sectors/categories of mills where there are limitations in the applicability of the specific measure discussed.

5.2.1 Wool scouring

Wool scouring can be done using water (most common situation) or organic solvent. Both methods are determined as BAT, provided that a number of requirements are satisfied.

Wool scouring with water

BAT is to:

- select raw wool fibre according to the BAT measures identified in Table 5.1
- substitute alkylphenol ethoxylates detergents with alcohol ethoxylates or other readily biodegradable substitutes that do not give rise to toxic metabolites, according to the BAT measures defined in Section 4.3.3
- use dirt removal / grease recovery loops of high capacity as described in Section 4.4.1 (for fine and extra-fine wool, the wool grease recovery loop, when carried out using machinery that has a separate continuous sludge flow output, also allows the elimination of the very fine dirt fraction, without the need for a separate loop for dirt removal). BAT-associated values for water consumption are 2 to 4 l/kg of greasy wool for medium and large mills (processing 15000 tonnes/year of greasy wool) and 6 l/kg for small mills. Associated values for grease recovery range between 25 and 30 % of the grease estimated to be present in the wool scoured
- reduce energy consumption to 4 - 4.5 MJ/kg greasy wool processed, comprising approximately 3.5 MJ/kg thermal energy and 1 MJ/kg electrical energy by a suitable combination of the following techniques (in addition to the grease recovery loop mentioned above):

- fitting covers to scour bowls to prevent heat losses
- optimising the performance of the final squeeze press in order to improve mechanical removal of water before the drying process
- running the last bowl at relatively high temperature. Optimum temperature is shown to be 65°C, except when peroxide bleaching is carried out in the last bowl. In this case the optimum bleaching temperature is 48°C
- controlling automatically the humidity in the dryer via sensors which measure the humidity of the dryer atmosphere or of the wool itself
- retrofitting heat recovery units to dryers.

Due to the lack of data it is not possible to define whether the above-mentioned BAT associated values for water and energy consumption are also applicable to extra-fine wool (fibre diameter typically less than 20µm).

Scouring with organic solvent

Scouring with organic solvent is determined as BAT, provided that all measures described in Section 2.3.1.3 are taken to minimise fugitive losses and prevent any possible contamination of groundwater arising from diffuse pollution and accidents.

5.2.2 Textile finishing and carpet industry

PRETREATMENT

Removing knitting lubricants from fabric

BAT is to do one of following:

- select knitted fabric that has been processed using water-soluble and biodegradable lubricants instead of the conventional mineral oil-based lubricants (see Section 4.2.3). Remove them by water washing. With knitted fabrics made of synthetic fibres the washing step needs to be carried out before thermofixation (to remove the lubricants and avoid them being released in the form of air emissions)
- carry out the thermofixation step before washing and treat the air emissions generated from the stenter frame by dry electrofiltration systems that allow energy recovery and separate collection of the oil. This will reduce the contamination of the effluent (see Section 4.10.9)
- remove the non-water soluble oils using organic solvent washing. The requirements described in Section 4.9.3 are then taken, along with provisions for the in-loop destruction of the persistent pollutants (e.g. by advanced oxidation processes). This will avoid any possible contamination of groundwater arising from diffuse pollution and accidents. This technique is convenient when other non water-soluble preparation agents, such as silicone oils, are present on the fabric.

Desizing

BAT is to do one of the following:

- select raw material processed with low add-on techniques (e.g. pre-wetting of the warp yarn, see 4.2.5) and more effective bioeliminable sizing agents (see 4.2.4) combined with the use of efficient washing systems for desizing and low F/M waste water treatment techniques (F/M <0.15 kg BOD₅/kg MLSS·d, adaptation of the activated sludge and temperatures higher than 15 °C – see 4.10.1) to improve the bioeliminability of the sizing agents
- adopt the oxidative route when it is not possible to control the source of the raw material (see Section 4.5.2)
- combine desizing/scouring and bleaching in one single step, as described in Section 4.5.3
- recover and re-use the sizing agents by ultrafiltration as described in Section 4.5.1.

Bleaching

BAT is to:

- use hydrogen peroxide bleaching as preferred bleaching agent combined with techniques for minimising the use of hydrogen peroxide stabilisers, as described in Section 4.5.6, or using biodegradable/bioeliminable complexing agents described in Section 4.3.4
- use sodium chlorite for flax and bast fibres that cannot be bleached with hydrogen peroxide alone. A two-step hydrogen peroxide-chlorine dioxide bleaching is the preferred option. It must be ensured that elemental chlorine-free chlorine dioxide is used. Chlorine-free chlorine dioxide is produced using hydrogen peroxide as the reducing agent of sodium chlorate (see Section 4.5.5)
- limit the use of sodium hypochlorite only to cases in which high whiteness has to be achieved and to fabrics that are fragile and would suffer depolymerisation. In these special cases, to reduce the formation of hazardous AOX, sodium hypochlorite bleaching is carried out in a two-step process in which peroxide is used in the first step and hypochlorite in the second. Effluent from hypochlorite bleaching is kept separate from the other streams and mixed effluents in order to reduce formation of hazardous AOX.

Mercerising

BAT is to either:

- recover and re-use alkali from mercerising rinsing water as described in Section 4.5.7
- or re-use the alkali-containing effluent in other preparation treatments.

DYEINGDosage and dispensing of dye formulations

BAT is to do all the following:

- reduce the number of dyes (one way to reduce the number of dyes is by using trichromatic systems)
- use automated systems for dosage and dispensing of dyes, only considering manual operation for dyes that are used infrequently
- in long continuous lines where the dead volume of the distribution line is comparable with the volume in the padder, give preference to decentralised automated stations that do not premix the different chemicals with the dyes before the process and that are fully automatically cleaned.

General BAT for batch dyeing processes

BAT is to:

- use machinery fitted with: automatic controllers of fill volume, temperature and other dyeing cycle parameters, indirect heating & cooling systems, hoods and doors to minimise vapour losses
- choose the machinery that is most fitted to the size of the lot to be processed to allow its operation in the range of nominal liquor ratios for which it is designed. Modern machines can be operated at approximately constant liquor ratio whilst being loaded at a level as low as 60 % of their nominal capacity (or even 30 % of their nominal capacity with yarn dyeing machines) (see Section 4.6.19)
- select new machinery according as far as possible to the requirements described in Section 4.6.19:
 - low- or ultra-low liquor ratio
 - in-process separation of the bath from the substrate
 - internal separation of process liquor from the washing liquor
 - mechanical liquor extraction to reduce carry-over and improve washing efficiency
 - reduced duration of the cycle.

- substitute overflow-flood rinsing method in favour of drain and fill or other methods (smart rinsing for fabric) as described in Section 4.9.1
- re-use rinse water for the next dyeing or reconstitution and re-use the dye bath when technical considerations allow. This technique (see Section 4.6.22) is easier to implement in loose fibre dyeing where top-loading machines are used. The fibre carrier can be removed from the dyeing machine without draining the bath. However, modern batch dyeing machines are equipped with built-in holding tanks allowing for uninterrupted automatic separation of concentrates from rinsing water

BAT for continuous dyeing processes

Continuous and semi-continuous dyeing processes consume less water than batch dyeing, but highly concentrated residues are produced.

BAT is to reduce losses of concentrated liquor by:

- using low add-on liquor application systems and minimising volume capacity of the dip trough when using pad dyeing techniques
- adopting dispensing systems where the chemicals are dispensed on-line as separate streams, being mixed only immediately before being fed to the applicator
- using one of the following systems for dosing the padding liquor, based on measurement of the pick up (see 4.6.7):
 - measure the amount of dyeing liquor consumed by reference to the quantity of processed fabric (length of the fabric multiplied by its specific weight); the resulting values are automatically processed and used for the preparation of the next comparable batch
 - use the rapid batch dyeing technique, where rather than being prepared for the whole batch before starting the dyeing batch, the dyestuff solution is prepared just in time, in several steps, based on on-line measurement of the pick up. This second technique is preferred when economic considerations allow (see 4.6.7)
- increase washing efficiency according to the principles of countercurrent washing and reduction of carry-over described in Section 4.9.2.

PES & PES blends dyeing with disperse dyes

BAT is to:

- avoid the use of hazardous carriers by (in order of priority):
 - using non-carrier dyeable polyester fibres (modified PET or PTT-type) as described in Section 4.6.2, when product market considerations allow
 - dyeing in HT conditions without use of carriers. This technique is not applicable to PES/WO and elastane/WO blends
 - substituting conventional dye carriers with compounds based on benzylbenzoate and N-alkylphthalimide, when dyeing WO/PES fibres (see Section 4.6.1)
- substitute sodium dithionite in PES aftertreatment, by applying one of the two proposed techniques (as described in Section 4.6.5):
 - replace sodium dithionite with reducing agent based on sulphinic acid derivatives. This should be combined with measures in order to ensure that only the strict amount of reducing agent needed to reduce the dyestuff is consumed (e.g. by using nitrogen to remove oxygen from the liquor and from the air in the machine)
 - use of disperse dyes that can be cleared in alkaline medium by hydrolytic solubilisation instead of reduction (see Section 4.6.5)
- use optimised dye formulations that contain dispersing agents with high degree of bioeliminability as described in Section 4.6.3.

Dyeing with sulphur dyes

BAT is to (see 4.6.6):

- replace conventional powder and liquid sulphur dyes with stabilised non-pre-reduced sulphide-free dyestuffs or with pre-reduced liquid dye formulations with a sulphide content of less than 1 %
- replace sodium sulphide with sulphur-free reducing agents or sodium dithionite, in that order of preference
- adopt measures to ensure that only the strict amount of reducing agent needed to reduce the dyestuff is consumed (e.g. by using nitrogen to remove oxygen from the liquor and from the air in the machine)
- use hydrogen peroxide as preferred oxidant.

Batch dyeing with reactive dyes

BAT is to:

- use high-fixation, low-salt reactive dyes as described in Sections 4.6.10 and 4.6.11
- avoid the use of detergents and complexing agents in the rinsing and neutralisation steps after dyeing, by applying hot rinsing integrated with recovery of the thermal energy from the rinsing effluent (see Section 4.6.12).

Pad-batch dyeing with reactive dyes

BAT is to use dyeing techniques that perform at equivalent levels to those described in Section 4.6.13. The technique described is more cost effective than pad-batch dyeing in terms of total processing costs, but the initial capital investment in switching to the new technology is significant. However, for new installations and those seeking to replace equipment the cost factor is not so significant. In all cases, BAT is to avoid the use of urea and to use silicate-free fixation methods (see Section 4.6.9).

Wool dyeing

BAT is to:

- substitute chrome dyes with reactive dyes or, where not possible, use ultra-low chroming methods that fulfil all the following requirements as defined in Section 4.6.15:
 - an emission factor of 50 mg chromium per kg of wool treated is achieved, which corresponds to a chromium concentration of 5 mg/l in the spent chroming bath when a 1:10 liquor ratio is used
 - no chromium (VI) is detectable in the waste water (using a standard method able to detect Cr VI at concentrations <0.1 mg/l)
- ensure minimum discharge of heavy metals in the waste water when dyeing wool with metal complex dyes. BAT associated values are emission factors of 10 - 20 mg/kg of treated wool, which correspond to 1 - 2 mg/l of chromium in the spent dye bath when a 1:10 liquor ratio is used. These performances can be achieved by:
 - using auxiliaries that enhance dye uptake like, for instance, the process described in Section 4.6.17 for loose wool and tops
 - using pH control methods to maximise final bath exhaustion for other make-ups
- give preference to a pH-controlled process when dyeing with pH-controllable dyes (acid and basic dyes) so that level dyeing is obtained with maximum exhaustion of dyes and insect resist agents and minimum use of organic levelling agents (see Section 4.6.14).

PRINTINGProcess in general

BAT is to:

- reduce printing paste losses in rotary screen printing by:
 - minimising the volume of printing paste supply systems (see 4.7.4)
 - recovering printing paste from the supply system at the end of each run by adopting the technique described in Section 4.7.5
 - recycling residual printing paste (see Section 4.7.6)

- reduce water consumption in cleaning operations by a combination of (see Section 4.7.7):
 - start/stop control of cleaning of the printing belt
 - re-use of the cleanest part of the rinsing water from the cleaning of the squeegees, screens and buckets
 - re-use of the rinsing water from cleaning of the printing belt
- use digital ink-jet printing machines for the production of short runs (less than 100 m) for flat fabrics, when product market considerations allow (see Section 4.7.9). It is not considered BAT to flush with solvent to prevent blocking while the printer is not in use
- use digital jet printing machines described in Section 4.7.8 for printing carpet and bulky fabrics, except for resist and reserve printing and similar situations.

Reactive printing

BAT is to avoid the use of urea by either:

- the one-step process with the controlled addition of moisture, where the moisture is applied either as foam or by spraying a defined quantity of water mist (see Section 4.7.1)

OR

- the two-steps printing method (see 4.7.2).

For silk and viscose, with the one-step process, the spraying technique is not reliable due to the low moisture add-on required for these fibres. The foaming technique with complete elimination of urea is proven for viscose, but not yet for silk. There is a high initial investment cost of about 200000 euros for a foaming machine related to a production capacity of up to about 80000 linear metres per day. The technique has been operated under economically viable conditions in plants of capacity of about 30000, 50000 and 140000 linear metres per day. There is a question whether the technique is economically viable for smaller plants.

Where the foam technique is not used, the amount of urea consumed can be reduced to about 50 g/kg of printing paste for silk and to 80 g/kg for viscose.

Pigment printing

BAT is to use optimised printing pastes that fulfil the following requirements (see 4.7.3):

- thickeners with low-emission of volatile organic carbon (or not containing any volatile solvent at all) and formaldehyde-poor binders. The associated air emission value is <0.4 g Org.-C/kg textile (assuming 20 m³ air/kg textile)
- APEO-free and high degree of bioeliminability
- reduced ammonia content. Associated emission value: 0.6 g NH₃/kg textile (assuming 20 m³ air/kg textile).

FINISHING

Process in general

BAT is to:

- minimise residual liquor by:
 - using minimal application techniques (e.g. foam application, spraying) or reducing volume of padding devices
 - re-using padding liquors if quality is not affected
- minimise energy consumption in stenter frames by (see Section 4.8.1):
 - using mechanical dewatering equipment to reduce water content of the incoming fabric
 - optimising exhaust airflow through the oven, automatically maintaining exhaust humidity between 0.1 and 0.15 kg water/kg dry air, considering the time taken to reach equilibrium conditions
 - installing heat recovery systems
 - fitting insulating systems
 - ensuring optimal maintenance of the burners in directly heated stenters
- use low air emission optimised recipes. An example for classification/ selection of finishing recipes is the “Emission factor concept” described in Section 4.3.2.

Easy-care treatment

BAT is to use formaldehyde-free cross-linking agents in the carpet sector, and formaldehyde-free or formaldehyde-poor (<0.1 % formaldehyde content in the formulation) cross-linking agents in the textile industry (see Section 4.8.2).

Mothproofing treatments

- Process in general

BAT is to:

- adopt appropriate measures for material handling as described in Section 4.8.4.1
- ensure that 98 % efficiency (transfer of insect resist agent to the fibre) is achieved
- adopt the following additional measures when the insect resist agent is applied from a dye bath:
 - ensure that a pH<4.5 is reached at the end of the process and if this is not possible, apply the insect resist agent in a separate step with re-use of the bath
 - add the insect resist agent after dye bath expansion in order to avoid overflow spillages
 - select dyeing auxiliaries that do not exert a retarding action on the uptake (exhaustion) of the insect-resist agent during the dyeing process (see Section 4.8.4.1).

- Mothproofing of yarn produced via the dry spinning route

BAT is to use one or both of these techniques (described in Section 4.8.4.2):

- combine acid aftertreatment (to increase the uptake of mothproofing active substance) and re-use of the rinse bath for the next dyeing step
- apply proportional over-treatment of 5 % of the total fibre blend combined with dedicated dyeing machinery and waste water recycling systems to minimise active substance emissions to water.

- Mothproofing of loose fibre dyed / yarn scoured production

BAT is to (see Section 4.8.4.3):

- use dedicated low-volume application systems located at the end of the yarn scouring machine
- recycle low-volume process liquor between batches and use processes designed specifically to remove active substance from spent process liquor. These techniques may include adsorptive or degradative treatments
- apply mothproofing directly to the carpet pile (when mothproofing during carpet manufacture) using foam application technology.

- Mothproofing of yarn dyed production

BAT is to (see Section 4.8.4.4):

- use a separate aftertreatment process to minimise emissions from dyeing processes which are carried out under less than optimum conditions for mothproofing uptake
- use semi-continuous low-volume application machinery or modified centrifuges
- recycle low-volume process liquor between yarn batches and processes designed specifically to remove active substance from spent process liquor. These techniques may include adsorptive or degradative treatments
- apply mothproofing directly to the carpet pile (when mothproofing during carpet manufacture) using foam application technology.

- Softening treatments

BAT is to apply the softening agents by pad mangles or better, by spraying and foaming application systems, instead of carrying out this treatment by exhaustion directly in the batch dyeing machine (see Section 4.8.3).

WASHING

BAT is to:

- substitute overflow washing/rinsing with drain/fill methods or “ smart rinsing” techniques as described in Section 4.9.1
- reduce water & energy consumption in continuous processes by:
 - installing high-efficiency washing machinery according to the principle described in Section 4.9.2. The associated values for high-efficiency continuous washing of cellulosic and synthetic fabric in open-width are reported in Table 4.38
 - introducing heat recovery equipment
- when halogenated organic solvent cannot be avoided (e.g. with fabrics that are heavily loaded with preparations such as silicone oils that are difficult to remove with water), use fully closed-loop equipment. It is essential that the equipment fulfil the requirements described in Section 4.9.3 and provisions be taken for in-loop destruction (e.g. by advanced oxidation processes) of the persistent pollutants in order to avoid any possible contamination of groundwater arising from diffuse pollution and accidents.

5.3 Effluent treatment and waste disposal

WASTE WATER TREATMENT

Waste water treatment follows at least three different strategies:

- central treatment in a biological waste water treatment plant on site
- central treatment off site in a municipal waste water treatment plant
- decentralised treatment on site (or off site) of selected, segregated single waste water streams

All three strategies are BAT options when properly applied to the actual waste water situation. Well-accepted general principles for waste water management and treatment include:

- characterising the different waste water streams arising from the process (see Section 4.1.2)
- segregating the effluents at source according to their contaminant type and load, before mixing with other streams. This ensures that a treatment facility receives only those pollutants it can cope with. Moreover, it enables the application of recycling or re-use options for the effluent
- allocating contaminated waste water streams to the most appropriate treatment
- avoiding the introduction of waste water components into biological treatment systems when they could cause malfunction of such a system
- treating waste streams containing a relevant non-biodegradable fraction by appropriate techniques before, or instead of, a final biological treatment.

According to this approach, the following techniques are determined as general BAT for the treatment of waste water from the textile finishing and carpet industry:

- treatment of waste water in an activated sludge system at low food-to-micro organisms ratio as described in Section 4.10.1, under the prerequisite that concentrated streams containing non-biodegradable compounds are pretreated separately
- pretreatment of highly-loaded (COD>5000 mg/l) selected and segregated single waste water streams containing non-biodegradable compounds by chemical oxidation (e.g. Fenton reaction as described in Section 4.10.7). Candidate waste water streams are padding liquors from semi-continuous or continuous dyeing and finishing, desizing baths, printing pastes, residues from carpet backing, exhaust dyeing and finishing baths.

Certain specific process residues, such as residual printing pastes and residual padding liquors are very strong and, where practicable, should be kept out of waste water streams.

These residues should be disposed of appropriately; thermal oxidation can be one suitable method because of the high calorific value.

For the specific cases of waste water containing pigment printing paste or latex from carpet backing, precipitation/flocculation and incineration of the resulting sludge is a viable alternative to chemical oxidation (as described in Section 4.10.5).

For azo-dyes, anaerobic treatment of padding liquor and printing pastes as described in Section 4.10.6 before a subsequent aerobic treatment can be effective for colour removal.

If concentrated water streams containing non-biodegradable compounds cannot be treated separately, additional physical-chemical treatments would be required to achieve equivalent overall performance. These include:

- tertiary treatments following the biological treatment process. An example is adsorption on activated carbon with recycling of the activated carbon to the activated sludge system: this is followed by destruction of the adsorbed non-biodegradable compounds by incineration or treatment with free-radicals (i.e. process generating OH^* , O_2^* , CO_2^*) of the excess sludge (biomass along with the spent activated carbon) (see plant 6 in Section 4.10.1)
- combined biological, physical and chemical treatments with the addition of powdered activated carbon and iron salt to the activated sludge system with reactivation of the excess sludge by “wet oxidation” or “wet peroxidation” (if hydrogen peroxide is used), as described in Section 4.10.3
- ozonation of recalcitrant compounds prior to the activated sludge system (see plant 3 in Section 4.10.1).

For effluent treatment in the wool scouring sector (water-based process)

BAT is to:

- combine the use of dirt removal / grease recovery loops with evaporative effluent treatment, with integrated incineration of the resulting sludge and full recycling of water and energy for: 1) new installations 2) existing installations with no on-site effluent treatment 3) installations seeking to replace life-expired effluent treatment plant. This technique is described in Section 4.4.2
- use coagulation/flocculation treatment in existing mills already using it in conjunction with discharge to sewerage system employing aerobic biological treatment.

Whether or not biological treatment can be considered as BAT must remain an open question until better information on its costs and performance can be assembled.

SLUDGE DISPOSAL

For sludge from waste water treatment of wool scouring effluent

BAT is to:

- use sludge in brick-making (see 4.10.12) or adopt any other appropriate recycling routes
- incinerate the sludge with heat recovery, provided that measures are taken to control emissions of SO_x , NO_x and dust and to avoid emissions of dioxins and furans arising from organically bound chlorine from pesticides potentially contained in the sludge.

6 EMERGING TECHNIQUES

Except where otherwise specified the information in this chapter has been provided by [179, UBA, 2001] and [77, EURATEX, 2000].

Enzyme catalysed finishing processes

Enzymes are proteins that act as biocatalysts activating and accelerating chemical reactions which would otherwise normally need more energy. Their excellent substrate selectivity allows more gentle process conditions compared to conventional processes. Enzymes are present in bacteria, yeasts and fungi.

At present enzymes are used and under study only for natural fibres, the use of enzymes for man-made fibres is not mentioned in literature. Some enzymes, such as the amylases in the desizing process, have been widely applied for a long time; other enzymes are still the object of investigations. Table 6.1 lists the main enzymatic processes already in use or currently emerging in the textile sector.

Fibre	Treatment	Enzymes	Substrate	Degree of development
Cotton	Desizing	Amylases, amyglucosidases	Starch	State of the art
	Scouring	Pectinases	Cotton fibre adjacent material	Available
	Scouring	Enzymatic mixture	Cotton fibre adjacent material	Emerging
	Bleaching	Laccases, glucoseosidases	Lignin, dyestuffs, glucose	Emerging
	Degradation of residual H ₂ O ₂ after bleaching	Peroxidases	H ₂ O ₂	Available
	Bio-polishing	Cellulases	Cellulose	Available
	Bio-stoning	Celluloses	Cellulose	Available
Wool	Scouring	Lipases	Lanolin	Emerging
	Anti-felting	Special enzymes		Emerging
Silk	Degumming	Sericinases	Sericin	Emerging
Flax	Softening	Pectinestearases	Flax fibre adjacent material	Emerging
Jute	Bleaching, softening	Cellulase, xylanases	Jute fibre adjacent material	Emerging

Table 6.1: Enzymatic processes in textile finishing
[77, EURATEX, 2000], [179, UBA, 2001]

Energy savings (lower processing temperatures) and lower water consumption (reduced number of rinsing steps) are some of the promising advantages of enzymatic processes, along with the omission, in some cases, of the use of hazardous/harmful substances. Also enzymes can be used in catalytic amounts and as a biocatalyst they can be recycled.

Plasma technology

A plasma can be described as a mixture of partially ionised gases. Atoms, radicals and electrons can be found in the plasma. The electrons in low temperature plasmas are able to cleave

covalent chemical bonds, thereby producing physical and chemical modifications of the surface of the treated substrate.

Two types of plasma are generally used: the corona plasma and low-pressure plasma.

Plasma treatment can be performed on natural fibres as well as on synthetic fibres, to achieve the following effects:

- wool degreasing
- desizing
- change of fibre wettability (hydrophilic, hydrophobic properties)
- increase in dyestuff affinity
- improved dye levelling properties
- anti-felt finishing in wool
- sterilisation (bactericidal treatment), etc.

Anti-felt finishing effects for wool is one of the most studied applications of plasma technology in the textile sector. Plasma treatment, instead of the conventional anti-felt treatment (see Section 2.9.2.8), is very attractive because this technique causes less degradation of the wool fibre and avoids the presence of AOX in the waste water.

In general the main advantages of plasma technology are the extremely short treatment time and the low application temperature, along with the fact that water and solvents can be avoided and no or less chemicals are required.

Electron-ray treatment

Electron-rays start free-radical initiated polymerisation reactions that can then be used for coating, lamination and for graft co-polymerisation reactions on textiles pre-coated with monomers or pre-polymers.

The advantage over thermal curing is that solvent-free formulations can be used. This reduces the emissions of VOCs during drying operations. The technique is already established in other sectors and therefore its implementation in the textile sector is foreseeable in the next five years.

Use of supercritical CO₂ in dyeing processes

Supercritical fluids are capable of dissolving organic molecules of low to medium polarity.

CO₂ has the advantage over other gases of being non-flammable, non-explosive and non-toxic.

CO₂ dyeing of PES and PP fibre is already developed on an industrial scale, however the application of this technique on wool, PA and cotton is still problematic due to the polar nature of the dyestuffs used to colour these fibres.

CO₂ dyeing of PES and PP can be carried out under optimal isothermal and isobaric conditions at 120 and 300 °C. Dye uptake and fastness properties are very similar to water dyeing. Nevertheless some precautions need to be taken.

Excess dye dissolved in the dyeing medium must be extracted with fresh supercritical CO₂ at the end of the dyeing cycle.

In conclusion, only special dye formulations can be used because dispersing agents and other auxiliaries typically present in conventional dye formulations strongly influence dye uptake in supercritical CO₂.

Hydrophobic preparation agents should be extracted before dyeing because of their solubility in supercritical CO₂. They are first extracted from the fibre during the dyeing process, and then precipitate as oily droplets at the end of the process.

CO₂ dyeing has a number of advantages:

- almost zero water consumption
- zero off-gas emission (CO₂ can be recycled)
- no drying step necessary after dyeing
- levelling and dispersing agents are not needed at all or, in some cases, they are added in very small amounts
- the dyestuff residues can be recycled.

Nevertheless, the investment cost for the equipment is high and this is a significant drawback, especially when considering that PES textiles are normally low-price products.

Ultrasonic treatments

Ultrasonic treatments improve the dispersion of dyestuffs and auxiliaries and enhance their ability to emulsify and solubilise. This allows improved liquor homogenisation, which then results in higher bath exhaustion and level dyeing properties. In addition, ultrasounds produce a de-aeration effect in the liquor and on the fabric, which is normally obtained by adding special auxiliaries (de-aerating agents).

The main environmental benefits achievable with ultrasonic treatments in textile finishing are:

- energy savings (lower process temperatures and shorter cycle times)
- reduction in auxiliaries consumption.

Electrochemical dyeing

Vat and sulphur dyeing involves both a reducing and an oxidising step, which are carried out with chemical oxidants and reducing agents. The environmental concerns associated with the use of these chemicals are described in Section 2.7.8.1. An attractive alternative technique is to reduce and oxidise the dye by means of electrochemical methods.

With direct electrolysis the dye itself is reduced at the surface of the cathode. In indirect electrolysis the reducing power of the cathode is transferred to the solution by a soluble reversible redox system (e.g. based on anthraquinone chemistry or iron complexes). With this reversible redox system the reducing agent is continuously regenerated at the cathode, which thus allows full recycling of the dye bath and the reducing agent.

Direct cathodic reduction in an electrochemical cell is applicable to sulphur dyes. Vat dyes are reduced by indirect electrolysis.

Alternative textile auxiliaries

Complexing agents

The use of polyaspartic acid as a substitute for conventional dispersing and complexing agents is under study.

Cross-linking agents

Polycarbonic acids can be used as an alternative to N-methylol-based cross-linking agents, which are responsible for formaldehyde emissions.

Biopolymers

Besides cellulose, chitin, the main structural component of crustacean shells (crabs, lobster, etc.) and insects, is the second main biopolymer. Its deacetylated derivative, chitosan, which is easier to handle due to its higher solubility, is increasing in importance.

Some examples of potential applications of chitosan and its derivatives in the textile sector include:

- antimicrobial treatment for textiles: a permanent effect can be obtained by blending 10 % of chitosan fibres with cotton fibres to produce a mixed fibre yarn or by spraying chitosan solutions on non-woven fabrics. Compared to other commonly used antimicrobials, chitosan is not toxic to aquatic life nor to humans (it is therefore of special interest for those fabrics that stay in close contact with the skin)
- aftertreatment to improve fastness properties when dyeing with direct dyes: cationic modified derivatives of chitosan are reported to be suitable for this application

Furthermore, chitosan increases the dyestuff uptake and can act as a softening agent or binding agent for non-woven fabrics. It can also be used as an additive in printing pastes and in sizing agents. Its application can also be interesting in waste water treatment.

Fuzzy logic

Significant improvements in process reliability are achievable with the use of fuzzy logic (i.e. expert systems based on self-learning software systems, which auto-enlarge their knowledge by algorithms). The application of fuzzy logic in the textile industry is the object of a number of research projects. Two examples are reported concerning the control of the sizing process and the control of the condensation reaction of cross-linking agents.

The main advantages to be expected are the improved process control, which subsequently can result in increased productivity and enhanced quality of the final product.

Indirect environmental benefits are associated with the potential savings in energy and chemicals as a result of the improved process control.

The main limitation in the implementation of these expert systems in the textile industry is often the lack of a reliable database.

On-line monitoring

Process control by on-line monitoring enhances operation liability in the direction of “right first time production”.

Examples of on-going research in this area are:

- *dyeing*: the concentration of the COD (related with the dyestuff concentration) is measured on-line during washing and rinsing operations in discontinuous dyeing processes. When the dyestuff concentration in the rinsing bath is negligible, the rinsing process is automatically stopped. This *technique allows considerable water and energy savings*.
- *dyeing* and bleaching: by using a special amperometric sensor, the concentration of reducing or oxidising agents on fabrics can be controlled on-line. For example, the completeness of H₂O₂ removal after bleaching or the concentration of reducing agents in vat dyeing can be monitored and excess use of chemicals avoided.
- *dyeing with vat dyes*: by monitoring the redox potential, it is possible to detect exactly the point at which the reducing agent is completely rinsed off. When this point is reached the rinsing process can be stopped and the oxidant added to the bath.

Future development of Advanced Oxidation Processes in the textile industry

Advanced oxidation processes are already applied in the textile industry (see Section 4.10.7) and further research is under way. The BIOFL-UV project is one example. The aim of this research is to develop and test a waste water treatment based on the UV-activated photolysis of hydrogen peroxide (for the decolouration of the spent bath) combined with a bioflotation process (for the destruction of the residual organic load). The combination of these waste water treatment processes is expected to achieve a complete decolourisation of the process waters for every type of wet process (finishing, bleaching, dyeing, etc.). The project will also develop and implement a process-control software based on artificial neural network and systems dynamics. The ultimate goal is the recycling, after filtration of 75 % of the process water and dye destruction [313, BIOFL-UV, 2002].

Reed bed systems for waste water treatment

For a long time researchers have pointed out the high removal capacity of natural environments (soil, wet lands, etc.) and have studied the possibility of using such environments (ecosystems) in order to purify, or at least to complete the waste water purification process. Purification techniques that use these principles in constructed plants (artificially reconstructed and confined) are commonly defined as “RBSs” or “constructed wet lands”. These techniques involve the use of plants for waste water treatment, although plants do not always play a primary role in the process. Indeed, the removal of pollutants and the consequent waste water purification are the results of a series of processes which involve reactions and interactions among substratum, micro-organisms and plants.

At present, industrial testing has proven that reed bed techniques and plants can be applied both for the secondary or tertiary treatment of industrial, municipal and zootechnical waste water.

Two textile finishing mills in Italy (Prisma Ricerche in Belluno and Filati di Ziche in the Treviso area) are assessing this technique. In one mill, the waste water coming from the dye-house (all kind of fibres and dye groups) is treated, after equalisation, in a reed bed system of five tanks in series. It is reported that 90 % COD reduction is achieved [106, Vekos, 2001].

The other company treats the effluent coming from the activated sludge system. This enables a further 51 % reduction of the residual COD [106, Vekos, 2001].

7 CONCLUDING REMARKS

7.1 Timing of the work

The work on this BAT Reference document started with a kick-off meeting of the TWG on the 12th and 13th February 1998. A first draft was sent out for consultation to the Technical Working Group in February 2001, then a second draft was issued in November 2001 and the work concluded with a second TWG meeting on 6 - 8 May 2002. After the second TWG meeting there were short consultation periods on the revised parts of Chapter 4 and Chapter 5 and on the new Chapter 6 “Emerging Techniques”, Chapter 7 “Concluding Remarks” and the Executive Summary. Following this consultation the final redrafting took place.

7.2 Source of information

Many reports from industry and authorities were elaborated on purpose for the EIPPC Bureau to provide targeted information for the development of the BREF. The reports submitted by Germany [179, UBA, 2001], Spain [180, Spain, 2001], Denmark [192, Danish EPA, 2001], Belgium [18, VITO, 1998] and Euratex [77, EURATEX, 2000] can be considered building blocks for the sections about textile finishing. For the carpet sector information was gathered mainly from GuT ([63, GuT/ ECA, 2000], [171, GuT, 2001]) and ENco [32, ENco, 2001], whereas the wool scouring section is largely based on the document submitted by Interlaine [187, INTERLAINE, 1999]. On many different subjects the contributions provided by VITO were fundamental for refining the information received from other sources and also for ensuring the link with the conclusions reached so far by the OSPAR Forum in the textile sector.

Valuable additional contributions were also received from various players outside the TWG (CRAB - Biella in Italy [193, CRAB, 2001] and Australian representatives [201, Wooltech, 2001] as two examples). Useful information, especially on emission and consumption levels, has also been made available through the participation of IPTS in the European Commission funded project “towards effluent zero” (TOWEFO). The companies involved in the survey as part of the TOWEFO project have collected data supplementing the information provided by the Technical Working Group.

7.3 Level of consensus

The exchange information process was successful and a high degree of agreement was reached following the second meeting of the Technical Working Group. No split views were identified during the final discussion. However, the following points need to be highlighted:

1. Speed of implementation of BAT: the textile industry is a very complex and variegated sector not only in terms of size of the mills, but also in terms of the combination of processes carried out and the possible end-products. The technological level is also very variable ranging from highly automated plants to mills where manual operation is still dominant. The BAT conclusions identified in the BREF represent a good level of environmental ambition, but concerns have been raised by some industry members because of the initial capital investment often required. However, most of the identified BAT are process-integrated techniques, which can deliver cost savings because of improved efficiencies and reduction of waste. The speed of implementation will therefore be a particularly sensitive issue for this industry.
2. Selection of incoming fibre raw material: an important point of discussion concerned the determination as BAT of techniques involving the selection of incoming raw fibre according to environmental criteria.

From the outset, industry put forward strong evidence to show that a large fraction of the pollution load comes from upstream processes. Many techniques have been submitted by the TWG on the available preventive measures and described in Chapter 4. These

techniques should be part of a general approach in which at each stage of the product's life cycle the supplier provides information on the type and load of chemicals that are added and that remain on the fibre.

The general principle of this preventive approach is largely accepted. However, objections have been raised by some industry members about the difficulty for the finisher to know what is on the fibre and about the excessive pressure that this approach would put on finishers (especially commission companies) compared to other sectors of the chain.

Mindful of the current difficulties that certain companies may have in controlling/ selecting the source of the fibre raw material, it was recognised that a quality assurance system for incoming textile material is necessary in order to produce an adequate application for an IPPC permit.

It is also evident that the customer is becoming more concerned about the overall environmental impact of the product that he is buying. This is already encouraging brand names (who give their production to commission companies) to ensure that their production satisfies ethical and environmental requirements during the whole production chain, from design to shop-window.

It is consistent with the BAT approach to seek collaboration with upstream partners in the textile chain, not only at a site-specific level, but also at higher levels, such as through trade associations, in order to create a chain of environmental responsibility for textiles.

7.4 Recommendations for future work

Limited data was available at the start of the BREF work about the current consumption and emission levels and about the performance of techniques to be considered in the determination of BAT, especially for water effluents. For water emissions, analytical measurements are carried out on the mixed final effluent after the waste water treatment plant (when this exists), but such data is not useful for the needs of the BREF.

A big effort has been made by some members of the TWG to carry out surveys and analytical campaigns in selected textile mills and thanks to the results of this work the base of data reported in this document is already of high value. Nevertheless, for future BREF reviews, all TWG and interested parties should continue, or start, to collect data for the most problematic processes, with the aim of assessing as far as possible the relationship between the environmental performance of the process and the technology and chemicals used. Initiatives and research projects should also be encouraged with this purpose.

In the future it is also envisaged that more data should come from the application of a systematic monitoring of inputs and outputs at process-specific level at the textile mills.

Another general remark for future work concerns economic data. In some cases the information received was too vague to allow a precise balance of the costs and savings involved. In future more extensive data about costs and savings could be beneficial in assisting the determination of BAT.

Apart from these general considerations, specific areas where data and information are missing are the following:

- biological treatment techniques for wool scouring water effluents: performance data are missing
- scouring of extra-fine wool: specific consumption and emission levels reported in the BREF are not in relation with the technology used and could not be used to reach conclusions on BAT-associated values
- functional finishing: in Chapter 4 a number of techniques have been described for easy-care, mothproofing and softening treatments. However, little information was provided about techniques to be considered in the determination of BAT for other functional finishing treatments

- carpet sector (excluding carpet yarn wet processing): except for air emissions, very little data has been supplied on consumption and emission levels for wet processes (e.g. dyeing, printing, etc.)
- silk, flax and linen: very little information has been provided in general about these fibres
- industry-specific monitoring aspects.

7.5 Suggested topics for future R & D projects

The following might be considered for future Research and Development projects:

Knowledge/ monitoring of the process

- techniques to improve on-line monitoring and understanding of the process: at present textile process parameters are often set more on the basis of human experience than on a real physical/chemical basis
- there are two connected data problems for proprietary chemicals and auxiliaries used in the textile sector that hinder the selection of the most environmentally-sound options:
 - readily-comparable environmental data
 - information on single components, main impurities and by-products present in formulations.

There are obvious commercial confidentiality problems, but this should not prevent further dialogue and development.

Specific processes/ treatments

- desizing: weaving and desizing at the same mill, with the aim of allowing a more extensive application of size recovery
- membrane techniques: treatability studies of single defined and segregated waste water streams by membrane techniques with assessment of the chemical compounds causing scaling/fouling or damage to the membranes
- pesticides: some pesticides are naturally degraded by UV light. The use of artificial UV light to accelerate this degradation in opened fleeces is a technique that warrants further work
- spin finishing agents for man-made fibres: despite recent improvement in this field, further work is necessary to develop alternative compounds easy to remove and with reduced environmental impact both on water and air.

Waste water

- waste water streams containing a significant non-biodegradable fraction should be treated by adequate techniques, before or instead of final biological treatment: R&D is needed to improve techniques for segregating such streams as close as possible to their point of production to maximise effective recovery or targeted treatment
- effluents from the textile industry are complex mixtures of organic and inorganic substances. In most cases, the acute toxicity to test organisms is reduced dramatically by biological treatment. The environmental impact of such mixed effluents, with possible synergistic effects of components, remains difficult to ascertain. Work is needed in two areas:
 - the continuing development of Direct Toxicity Assessment (DTA) on mixed effluents
 - the identification of compounds with residual (sometimes high) toxicity after treatment(s).

The EC is launching and supporting, through its RTD programmes, a series of projects dealing with clean technologies, emerging effluent treatment and recycling technologies and management strategies.

Among these projects, there are some dealing with:

- 1) development of ultrasonic and laser technologies to replace the traditional scouring of wool;
- 2) development of plasma technologies (use of gases instead of liquids for chemical treatments) for the finishing of textiles;
- 3) development of new enzyme-based processes for wool-felting processing, covering the whole chain from carbonisation (replacing sulphuric acid with enzymes) to final felting;
- 4) development of supercritical fluids for dyeing.

In particular, the EC supports research on harmful properties on dyes used in textile industry, especially by SMEs. Most of these dyes are "existing substances", thus not having been tested for any harmful effects. Dyes widely used in textile industry are being tested for their mutagenic effects. When possible, substitutes are identified.

Potentially these projects could provide a useful contribution to future BREF reviews. Readers are therefore invited to inform the EIPPCB of any research results which are relevant to the scope of this document (see also the preface of this document).

REFERENCES

- 3 RIZA, (1998). "Dutch notes on BAT for the textile and carpet industry", .
- 4 Tebodin, (1991). "Technical and economic aspects of measures to reduce water pollution from the textile finishing industry", .
- 5 OSPAR (1994). "PARCOM Recommendation 94/5 concerning Best Available Techniques and Best Environmental Practice for Wet Processes in the Textile Processing Industry".
- 7 UBA, (1994). "Reduction of Waste Water in the Textile Industry", Texte 3/94.
- 8 Danish EPA, (1997). "Environmental Assessment of Textiles", Environmental project n. 369.
- 11 US EPA, (1995). "Manual - Best Management Practices for Pollution Prevention in the Textile Industry", .
- 18 VITO, J. B. D. G. D., (1998). "Beste Beschikbare Technieken (BBT) voor de Textielveredeling (BAT for the textile processing)", .
- 31 Italy, (2000). "Information submitted by Italy - Emission and Consumption Levels in Prato District", .
- 32 ENco, D. A., (2001). "Best Available Techniques in Wool and Wool Blend Carpet Yarn Wet Processing", .
- 36 BASF, (2000). "Technical Information about BASF Products for Resin Finishing", TI/T 344.
- 37 TEGEWA, (2000). "Presentation of the "Method of Classification of Textile Auxiliaries according to their Relevance to Water"", .
- 44 Comm., P., (2000). "Technical information submitted by HRS Engineering about HRS technology for waste fumes treatment (condensing + dry electrostatic cleaning)", .
- 48 VITO, (2001). "Information submitted by L. Bettens on behalf of VITO about spin finishes and lubricants", .
- 50 OSPAR, (1997). "PARCOM Recommendation 97/1 Concerning Reference values for Effluent Discharges from Wet Processes in the Textile Processing Industry", Annex 12.
- 51 OSPAR, (1994). "PARCOM Recommendation 94/5 Concerning Best Available Techniques and Best Environmental Practice for Wet Processes in the Textile Processing Industry", Annex 9.
- 52 European Commission (1999). "Commission Decision of 17 February 1999 establishing the ecological criteria for the award of the Community eco-label to textile products".
- 59 L. Bettens, (2000). "A summary of findings of the assessed documentation, including conclusions and proposals", .
- 61 L. Bettens, (1999). "Evolution in Chemical Use since 1992 within the Textile Processing Industry", .

References

- 63 GuT/ ECA, (2000). "Production Process for Textile Floorcoverings (draft) - Contribution for the IPPC BREF (Chapter 1-2)", .
- 64 BASF, (1994). "Products for Textile Finishing: Ecological Evaluation", .
- 65 TEGEWA, (2000). "International Textile Auxiliaries Buyers' Guide", .
- 66 CRIT, P., (1999). "IPPC - Italian Wool Textile Industry", .
- 69 Corbani, F. (1994). "Nobilitazione dei tessili", .
- 71 Bozzetto, (1997). "Servizio Informazioni Tecniche: Tintura della lana", .
- 76 Colorservice, (2001). "Technical information submitted by Colorservice about automatised dosing and laboratory linked on line with the dyeing department", .
- 77 EURATEX, E.-D. , (2000). "Textile Industry BREF document (Chapter 2-3-4-5-6)", .
- 78 Danish EPA, (1999). "Cleaner Technology Transfer to the Polish Textile Industry", .
- 97 CSIRO (2000). "Technical brochure about Wool Residue Testing".
- 102 ETAD, (2001). "Guidance for the User Industry on the Environmental Hazard Labelling of Dyestuffs", .
- 103 G. Savage, (1998). "The Residue Implications of Sheep Ectoparasiticides", .
- 106 Vekos, (2001). "Information brochure about waste water treatment systems (Reed Bed Systems, Bi-Air Float, Bi-Sand Filter)", .
- 113 EURATEX, (1997). "Importance of the Textile and Clothing Industry in Europe", .
- 116 MCS, (2001). "Information brochure about "Multiflow"", .
- 120 Brazzoli, (2001). "Information brochure about "Sirio" dyeing machines", .
- 127 Loris Bellini, (2001). "Information brochure about "Loris Bellini" dyeing machines (General Catalogue)", .
- 146 Energy Efficiency Office UK, (1997). "Good Practice Guide 168 - Cutting your energy costs - A guide for the textile dyeing and finishing industry", .
- 161 Comm., P., (2001). "Information submitted by CRAB - Biella about "Low-chrome dyeing techniques"", .
- 163 Comm., P., (2001). "Information submitted by CRAB about "Sostituzione dei coloranti al cromo con coloranti reattivi per la tintura della lana"",
- 167 Comm., P., (2000). "Information submitted by Vincenzo Bellini - Texcel about "Washing Efficiency in Discontinuous, Semi- and Continuous Processes for Cotton and Cotton Blends fabric" (II document)",
- 169 European Commission, (2001). "The European Eco-Label at a Glance", .
- 171 GuT, (2001). "Information submitted by L. Bettens on behalf of GuT about "Carpet Manufacturing"", .

- 176 VITO, (2001). "Information and comments submitted by L. Bettens on behalf of VITO about "Discontinuous Dyeing"", .
- 177 Comm., P., (2001). "Information submitted by MCS about the "Multiflow Dyeing Machine"", .
- 178 VITO, (2001). "Information submitted by L. Bettens on behalf of VITO about CORTERRA PTT", .
- 179 UBA, (2001). "BAT Reference Document - Germany", .
- 180 Spain, -. P. J. M. C., Mr. L. Alier, Ms. Cristina Canal, (2001). "Information submitted by Spanish TWG "Posición Técnica Española en relacion al 1 Draft of the BREF on Textiles" including "Nuevas Aportaciones a los Capítulos 4 Y 5 del Draft 1 Documento BREF"", .
- 181 VITO, (2001). "Information submitted by L. Bettens on behalf of VITO about "Reducing Agents"", .
- 182 VITO, (2001). "Information submitted by L. Bettens on behalf of VITO about "Alkali-dischargeable azo disperse dyes containing phthalimide moieties"", .
- 183 VITO, (2001). "Information submitted by L. Bettens on behalf of VITO about "Ecological Sulphur Dye & Dyeing Techniques"", .
- 185 Comm., P., (2001). "Information submitted by Vincenzo Bellini - Texcel about "Efficienza di asciugamento, ottimizzazione dell'aria di espulsione da un tipico asciugatoio e da una rameuse"", .
- 186 Ullmann's (2000). "Ullmann's Encyclopedia of Industrial Chemistry", .
- 187 INTERLAINE, (1999). "Best Available Techniques in Wool Scouring", .
- 188 VITO, (2001). "Information and comments submitted by L. Bettens on behalf of VITO about "Wool Chrome Dyeing Techniques"", .
- 189 D. Levy, (1998). "Peroxide desizing: a new approach in efficient, universal size removal", .
- 190 VITO, (2001). "Information submitted by L. Bettens on behalf of VITO about "Fibre reactive dye(ing)"", .
- 191 VITO, (2001). "Information and comments submitted by L. Bettens on behalf of VITO about "Wool chrome dyeing or reactive dyeing?"", .
- 192 Danish EPA, (2001). "Danish experiences: Best Available Techniques - BAT- in the clothing and textile industry - Preliminary Version - Document prepared for the European IPPC Bureau and the TWG on Textiles", .
- 193 CRAB, (2001). "Information submitted by CRAB about Emission and Consumption Levels in some Textile Finishing & Wool Scouring Mills in the Region of Biella-Italy", .
- 194 Comm., P. (2001). "Information submitted by BOZZETTO about "Typical add-on and COD content of the preparation agents applied on the fibre and yarn during the production process"".

References

- 195 Germany, (2001). "Comment to the First Draft of the BREF about "Softeners"", .
- 196 EIPPCB, (2001). "Draft Reference Document on Best Available Techniques in Common Waste Water and Waste Gas Treatment / Management Systems in the Chemical Sector", .
- 197 Comm., P., (2001). "Information submitted by Paolo Zanaroli - Sperotto Rimar, Italy about "The Use of Fully Closed-Loop Solvent Treatment Installations for Continuous Textile Webs"",
- 198 TOWEFO, -. E.--., (2001). "Questionnaires submitted textile mills within the TOWEFO Project (EVK1-CT-2000-00063 - Evaluation of the effect of the IPPC directive on the sustainable waste management in textile industries)", .
- 199 Italy, (2001). "Information submitted by Italy about Emission and Consumption Levels in one Textile Finishing Mill", .
- 200 Sweden, (2001). "Information submitted by Sweden about Emission and Consumption Levels in some Textile Finishing Mills", .
- 201 Wooltech, (2001). "Detailed description of Wooltech Processes and Techniques - Document A1", .
- 202 Ian M. Russel, C.-T. a. F. T. (2000). "Meeting the IPPC needs of European Processors: An Australian Perspective by Ian M. Russell - Commercial technology Forum - Nice meeting, Novembre 2000".
- 203 VITO, (2001). "Information submitted by L. Bettens on behalf of VITO about "The Application of the Oxidative Route"", .
- 204 L. Bettens, (2000). "OSPAR POINT 2000-Conclusions", .
- 205 M. Bradbury, (2000). "Smart rinsing: a step change in reactive dye application technology" JSDC Volume 116 May/June 2000, , .
- 206 Italy, (2001). "Comments made by Italy to the First Draft of the BREF on textiles - Information submitted about "Pretreatment of silk"", .
- 207 UK, (2001). "Comments made by UK to the First Draft of the BREF Textiles", .
- 208 ENco, (2001). "Comments made by ENco to the First Draft of the BREF Textiles", .
- 209 Germany, (2001). "Comments made by Germany to the First Draft of the BREF Textiles", .
- 210 L. Bettens, (1995). "Environmentally Friendly Bleaching of Natural Fibres by Advanced Techniques (SYNBLEACH EV5V -CT 94 - 0553)" European Workshop on Technologies for Environmental Protection, .
- 211 Kuster (2001). "Dye/ finish applicators - Information submitted by L. Bettens on behalf of VITO".
- 218 Comm., P., (2000). "Comments and contributions submitted by Bozzetto about "Applied Processes and Techniques in the Textile Sector"",
- 247 Comm., P., (2001). "Comment made by L. Bettens about the "BAT Document" submitted by UBA - Germany",

- 278 EURATEX, (2002). "Information submitted by EURATEX about the Textile Finishing Sector (data source: CRIET - European Textile Finishing Association)",
- 279 L. Bettens (2001). "Comments made by L. Bettens to the First Draft of the BREF on Textiles".
- 280 Germany (2002). "Comments made by Germany to the Second Draft of the BREF Textiles".
- 281 Belgium (2002). "Comments made by Belgium to the Second Draft of the BREF".
- 287 Germany, (2002). "Comments to the Second Draft of the BREF on Textiles - Emission Concept Factor" , , .
- 288 MCS, (2002). "Personal communication submitted by MCS about "Low liquor ratio machinery" and "New development on rinsing techniques"",
- 289 Comm., P., (2002). "Contribution given by Color Service about "Application of automated dosing and dispensing systems for chemicals and dyes in IPPC companies" - Answer to the comments made by the TWG on the Second Draft of the BREF",
- 292 US Filter-Zimpro, (2002). "PACT systems" , , .
- 293 Spain, (2002). "Comments made by Spain to the First Draft of the BREF",
- 294 ETAD, (2001). "Comment made by ETAD to the First Draft of the BREF",
- 295 Spain, (2002). "Contribution made by Spain to the Second Draft of the BREF: "Substitution of conventional lubricants with hydrosoluble oils in knitted fabric manufacturing"", .
- 297 Germany, (2002). "Contribution by Germany after the second TWG meeting - Answers to open questions on "Alkali Clearable Dyestuffs", "Sulphur Dyestuffs", "Hot rinsing of reactive dyestuffs", "Econtrol process"",
- 298 Dyechem Pharma, (2001). "Textile Softeners" , , .
- 299 Environment Daily 1054, (2001). "MEPs demand broad flame retardant ban - Environment Daily 06/09/01" Environment Daily, , .
- 301 CIA, C. I. A., (2002). "Comments made by CIA on the Second Draft of the BREF",
- 302 VITO, (2002). "Information provided by L. Bettens on behalf of VITO about Flame Retardants",
- 303 Ullmann's (2001). "Flame retardants".
- 304 Danish EPA, C. L., S. Lokke, et al., (1999). "Brominated Flame Retardants - Substance Flow analysis and Assessment of Alternatives", Environment Project 494.
- 308 Spain, (2002). "Attachment to comments made by Spain to the Second Draft of the BREF - Annex I - Contribution for Chapter 4", .
- 311 Portugal, (2002). "Comments made by Portugal to the Second Draft of the BREF",

References

- 312 ANT, A. T. I., (2002). "Urea consumption levels collected in three printing houses in Italy for silk and viscose",
- 313 BIOFL-UV, (2002). "Textile water recycling by means of bio-flotation and UV irradiation treatments - Proposal for financial support from the EC for SME specific measures COOPERATIVE RESEARCH CRAFT", .
- 314 L. Bettens, (2002). "Information submitted by L. Bettens on behalf of VITO about "Combined biological, physical and chemical treatment of mixed waste water effluent """,
- 315 EURATEX, (2002). "Data submitted by EURATEX - Share of the EU-15 Textile and Clothing Industry Sector in the Manufacturing Industry (data 2000 source: EUROSTAT)",
- 316 Sweden, (2001). "Comments made by Sweden to the First Draft of the BREF",
- 317 Comm., P., (2002). "Information submitted by Wooltech - Economic data for the Wooltech Technology",
- 318 Sperotto Rimar, (2002). "Comments made by Sperotto Rimar - Italy to the Second Draft of the BREF",
- 319 Sweden, (2002). "Comments made by Sweden to the Second Draft of the BREF",
- 320 Comm., P., (2002). "Information provided by Germany - "Lanaset TOP" process",
- 321 CEN Draft, (1999). "European Standard Draft prEN 13725 - Air quality - Determination of odour concentration by dynamic olfactometry", .

GLOSSARY

Adsorbable Organic Halogens (AOX)

A measure of the adsorbable organically bound halogens in water. The analytical test consists in adsorbing the organic substances contained in the water sample on activated charcoal (halogen-free). The charcoal is then eluted with sodium nitrate solution to completely remove chloride ions (non-organically bound halogen). Afterwards, the charcoal is burned in a stream of oxygen and the resultant hydrogen chloride is quantitatively determined. Only chlorine, bromine and iodine (not the ecologically important fluorine compounds) are determined with this analytical method. Bromine and iodine are calculated as Cl. The analytical values are expressed as AOX in:

- mg Cl/l of water or
- mg Cl/g of substance.

Aquatic toxicity

A measure of the effects of a given pollutant on aquatic life. The most common parameters are:

IC₁₀ = inhibition concentration of bacterial growth (10 % inhibition). Concentrations above the IC₁₀ value may strongly affect the efficiency of a biological treatment plant or even completely poison the activated sludge.

LC₅₀ = lethal concentration (50 % mortality). It is used for fish and represents the water concentration at which a given substance causes the mortality of 50 % of the population.

EC₅₀ = effect concentration (50 % effect). It is used for particularly sensitive organisms such as daphnia and algae.

The level of aquatic toxicity of a given pollutant is defined as follows:

- highly toxic: <0.1 mg/l
- very toxic: 0.1 - 1 mg/l
- toxic: 1.0 - 10 mg/l
- moderately toxic: 10 - 100 mg/l
- non toxic: >100 mg/l.

Biochemical Oxygen Demand (BOD)

A measure of the oxygen consumed by bacteria to biochemically oxidise organic substances present in water to carbon dioxide and water.

The higher the organic load, the larger the amount of oxygen consumed. As a result, with high organic concentrations in the effluent, the amount of oxygen in water may be reduced below acceptable levels for aquatic life.

BOD tests are carried out at 20 °C in dilute solution and the amount of oxygen consumed is determined after 5, 7 or, less commonly, 30 days. The corresponding parameters are called BOD₅, BOD₇ and BOD₃₀.

The analytical values are usually expressed in:

- mg O₂/l (effluent) or
- mg O₂/g (substance).

Biodegradability

A measure of the ability of an organic substance to be biologically oxidised by bacteria. It is measured by BOD tests (OECD tests 301 A to F) and relates to the biodegradation mechanisms taking place in biological waste water treatment works. It is usually expressed in % (of the substance).

Bioeliminability	<p>A measure of the ability of an organic substance to be removed from the effluent as a consequence of all elimination mechanisms that can take place in a biological plant (including biodegradation). It is measured by the bio-elimination test OECD 302 B, which determines the total effect of all elimination mechanisms in a biological treatment plant:</p> <ul style="list-style-type: none">- biodegradation (measured over a long period - up to 28 days - in order to account for the biodegradation of substances that necessitate the development of specially acclimatised bacteria capable of digesting them)- adsorption on activated sludge- stripping of volatile substances- hydrolysis and precipitation processes <p>It is usually expressed in % (of the substance).</p>
Bleaching agent	<p>The active substance providing the bleaching effect. The bleaching agent is formed/ produced by activating the bleach.</p>
Bleach	<p>The formulation used in the bleaching process.</p>
Chemical Oxygen Demand (COD)	<p>A measure of the amount of oxygen required to chemically oxidise organic and inorganic substances in water. COD tests are carried out at ca. 150 °C in the presence of a strong oxidant (usually potassium dichromate). To evaluate the oxygen consumption, the amount of chromium VI reduced to chromium III is determined and the obtained value is converted into oxygen equivalent. The analytical values are usually expressed in:</p> <ul style="list-style-type: none">- mg O₂/l (effluent) or- mg O₂/g (substance).
Dye	<p>The formulation (commercial product) containing the dyestuff together with other dyeing auxiliaries</p>
Dyestuff	<p>The colouring agent in the dye formulation: a planar molecule which contains chromophoric group(s) capable of interacting with light.</p>
DDT	<p>An organochlorine pesticide which has been banned in most European countries. The isomer used as pesticide is: p,p'-DDT 1,1,1-trichloro-2,2-bis(4-chlorophenyl)ethane. In the production process o,p'-DDT is also formed as a by-product. DDT and its metabolites, DDE (1,1-dichloro-2,2-bis(4-chlorophenyl)ethylene) and DDD (1,1-dichloro-2,2-bis(4-chlorophenyl)ethane) are persistent compounds which have demonstrated hormonal effects. In environmental samples, the concentration of DDT is often given as sDDT, which is the sum of DDT, DDE and DDD.</p>

EMAS	Eco-Management and Audit Scheme. It is a management tool for companies and other organisations to evaluate, report and improve their environmental performance. Applied in the EU since 1995 after Council Regulation (EEC) No 1836/93 of 29 June 1993, the scheme was initially restricted to manufacturing industries. Since 2001 EMAS has been open to all economic sectors including public and private services (Regulation (EC) No 761/2001 of the European Parliament and of the Council of 19 March 2001). In addition, EMAS was strengthened by the integration of EN/ISO 14001 as the environmental management system required by EMAS. Participation is voluntary and extends to public or private organisations operating in the European Union and the European Economic Area (EEA) — Iceland, Liechtenstein, and Norway.
European Odour unit	That amount of odorant(s) that, when evaporated into 1 cubic metre of neutral gas at standard conditions, elicits a physiological response from a panel (detection threshold) equivalent to that elicited by one Reference Odour Mass evaporated in one cubic metre of neutral gas at standard conditions [321, CEN Draft, 1999].
Finishing	This term can address both the sequence of wet treatments that are carried out to give the fibre the required colour and final properties, and any specific operation to apply functional finishes (easy-care, anti-felting, mothproofing agents, etc.).
Fixation rate	Ratio of the dye fixed on the fibre to the total dye applied.
Fixation efficiency	Ratio of the dye fixed on the fibre to the dye exhausted from the bath.
Liquor ratio	Weight ratio between the total dry material and the total liquor within a batch machine. So, for example, a liquor ratio of 1:10 means 10 litres of water per 1 kg of textile material (or 10 l/kg).
Hazardous substances	Substances or groups of substances that have one or several dangerous properties such as toxicity, persistence and bioaccumulability, or are classified as dangerous to humans or environment according to Directive 67/548 (Dangerous Substances Directive).
Make-up	Generic term used in the textile industry to name the different forms in which a textile material can exist. Examples are floc, yarn, woven and knitted fabric.
Nylon	Generic name for polyamide fibres.
Odour concentration	The number of odour units in a cubic metre of gas at standard conditions [321, CEN Draft, 1999].
Odour Unit	The amount of (a mixture of) odorants present in a cubic metre of odorous gas (under standard conditions) at the panel threshold [321, CEN Draft, 1999].

Rayon	A generic name for man-made continuous filament fibres, obtained from regenerated cellulose. The term rayon is used for fibres produced by both cupra-ammonium and viscose processes.
Reference Odour Mass	One Reference Odour Mass is equivalent to 123 µg of n-butanol. Evaporated in 1 cubic metre of neutral gas this produces a concentration of 0.040 µmol/mol [321, CEN Draft, 1999].
Scouring	Removal of foreign impurities from textiles. In the case of wool, this term can address both the removal of the grease and dirt present on raw wool (wool scouring process) and the removal of spinning oils and residual contaminants from yarn or fabric in the wet treatments that are carried out before the dyeing process.
Texturised fibres	Filament yarns that have undergone a special treatment aimed at giving the fibre a greater volume and surface interest than the conventional yarn of the same fibre.
Top	A continuous untwisted strand or sliver of wool fibres.

Abbreviations and acronyms

Acronym/ abbreviation	Explanation
AC	Cellulose acetate
AC	Absorption coefficient
AE	Alcohol ethoxylates
AOX	Adsorbable organic halogens
APE	Alkyl phenol ethoxylates
APEO	Alkyl phenol ethoxylates
BAT	Best available techniques
BOD	Biochemical oxygen demand
BREF	BAT reference document
C.I.	Colour index
CMC	Carboxymethyl cellulose
CO	Cotton
COD	Chemical oxygen demand
Conc.	Concentration
CSIRO	Commonwealth Scientific and Industrial Research Organisation
CT	Cellulose triacetate
CU	Cupro
CV	Viscose
DAF	Dissolved air flotation
DOC	Dissolved Organic Carbon
DTPA	Diethylenetriamine pentaacetate
DTPMP	Diethyletriamine penta(methylenephosphonic acid)
EDTA	Ethylenediamine tetraacetate
EDTMP	Ethylenediamine tetra(methylenephosphonic acid)
E-Fac	Emission factor
EL	Elastane
EPER	European Pollutant Emission Register (defined in Council Decision 2000/479/EC)
EO/PO	Ethylene oxide/propylene oxide (group of copolymers)
ETAD	Ecological and Toxicological Association of the Dyestuffs manufacturing industry

EUR	The euro, unit of european currency
EVA	Ethylene vinyl acetate
FR	Flame retardant
HC	Hydrocarbons
HCH	Hexachlorocyclohexane (pesticide)
HT	High temperature (process, machine)
IGR	Insect growth regulators (group of pesticides)
IK	Indanthren cold (group of vat dyes)
IN	Indanthren normal (group of vat dyes)
IR	Infra red (light)
IW	Indanthren warm (group of vat dyes)
L.R.	Liquor ratio
MEL	Minimum Effect Level
n.a	Not available
n.d.	Not determined
NPE	Nonyl phenol ethoxylates
NRA	National Registration Authority (Australia)
NTA	Nitrilotriacetate
o.w.b	On the weight of the bath
o.w.f	On the weight of the fibre
OC	Organochlorines (group of pesticides)
OECD	Organisation for Economic Co-operation and Development
OEL	Observable Effect Level
OP	Organophosphates (group of pesticides)
PA	Polyamide fibres
PAC	Polyacrylonitrile fibres
PBT	Polybutylene terephthalate
PCP	Pentachloro phenol
PE	Polyethylene
PES	Polyester fibres
PET	Polyethylene terephthalate
PP	Polypropylene
PTT	Polytrimethylene terephthalate
PU	Polyurethane
PVA	Polyvinyl alcohol
PVC	Polyvinyl chloride
Qww	Waste water flow
SBR	Styrene butadiene rubber
SI	Silk
SP	Synthetic pyrethroids (group of pesticides)
SS	Suspended solids
TEGEWA	Verband der Textilhilfsmittel-, Lederhilfsmittel-, Gerbstoff- und Waschrohstoff-Industrie e.V. (Industry Association)
TFI	Textile finishing industry
TOC	Total organic carbon
UF	Ultra filtration
ULLR	Ultra Low Liquor Ratio
US EPA	United States environmental protection agency
UV	Ultra violet (light)
VOC	Volatile organic compounds
WO	Wool
WW	Waste water
x-SBR	Carboxylated SBR

8 ANNEX I TEXTILE AUXILIARIES

8.1 Surfactants

The description of surfactants in this section is somehow anomalous because they do not represent a category of auxiliaries, but rather a category of organic compounds. The reason for dedicating a section to these compounds is that they are used in the textile industry for many different purposes (e.g. lubricants, antistatics, wetting agents, etc.). Dealing with them in a common section such as this avoids repetitions in other parts of this annex.

Surfactants can be the essential active substance in a textile auxiliary or can be used as additives in the formulation of auxiliaries, dyes, printing pastes, coating pastes (e.g. dispersing agents in dyestuffs, emulsifiers in preparation agents, etc.).

The surfactants used in the textile industry are classified under four major headings, namely: scouring agents, dye bath additives, softeners and antistatic agents.

Surfactants are organic polar compounds containing in their molecule at least one hydrophobic and one hydrophilic group. According to their chemical structure, surfactants are classified as non-ionic, anionic, cationic and amphoteric.

Non-ionic surfactants

Non-ionic surfactants are widely used in the textile industry for various purposes (e.g. as washing/ dispersing agents, as levelling agents, etc.). Some examples of commonly used non-ionic surfactants are:

- fatty alcohol ethoxylates
- fatty amines ethoxylates
- fatty acids ethoxylates
- triglyceride ethoxylates
- alkylphenol ethoxylates
- ethylene oxide/propylene oxide adducts.

Ethoxylated fatty alcohols, acids and triglycerides are generally easy to biodegrade. On the other hand, ethylene oxide/propylene oxide adducts, fatty amines and alkylphenol ethoxylates (APEO) are examples of surfactants that are difficult to biodegrade and, due to their solubility in water, are also difficult to eliminate.

The APEO in particular and the well-known nonyl phenol ethoxylates (NPE), which are the most commonly used surfactants in the group of alkyl phenol ethoxylates, pose serious environmental concerns. APEO degrade by stepwise removal of the ethoxy groups. In this way they form the corresponding alkyl phenols, which are bioaccumulative due to their lipophilic character and poor degradability. Alkyl phenols (particularly octyl- and nonyl phenols) are highly toxic to aquatic life and are reported to influence the reproduction of aquatic species by disrupting the endocrine system.

Even with highly effective effluent treatment systems, which allow only trivial amounts of APEO or their metabolites to enter the aquatic environment, concerns arise from the resultant sludge. Unless these sludge are subject to treatments such as incineration or pyrolysis, capable of destroying the organic material, the APEO or their metabolites may enter surface water or groundwaters in run-off from composting, spreading of treated or untreated sludge on agricultural land, or in leachate from landfill.

Several countries have already placed restrictions on the use of NPE. Moreover, these surfactants are on the list of "Priority Hazardous Substances" targeted for priority regulatory action under the Water Framework Directive.

Anionic surfactants

Anionic surfactants commonly used in textile processing are:

- sulphates (e.g. alcohol ethoxysulphates, alkanolamides sulphates, sulphated vegetable oils)
- sulphonates (e.g. alkylbenzene sulphonates, sulphonated vegetable oils, naphthalene sulphonates, ligninsulphonates)
- alkyl ether phosphates
- carboxylates (fatty acid condensation products, alkali salts of fatty acids).

The linear, more biodegradable compounds are the most commonly used (e.g. alkylbenzene sulphonates, fatty alkyl sulphates, etc.). Examples of recalcitrant anionic surfactants are the common lignin sulphonates and condensation products of naphthalene sulphonic acid with formaldehyde, which are widely used as dispersants for vat, sulphur and disperse dyes.

Anionic surfactants have several advantages: they are good oil emulsifiers and dye dispersants, they are excellent wetting agents and they are not expensive. In turn, they generate high levels of foam, and sulphate surfactants can be sensitive to calcium and magnesium [11, US EPA, 1995].

Cationic surfactants

Cationic surfactants are relatively uncommon in textile processing. One example is quaternary ammonium compounds (salts) used as retarders for cationic dyes, which are water-soluble recalcitrant substances. Cationic surfactants have by far the highest toxicity of all classes of surfactants [179, UBA, 2001].

Amphoteric surfactants

Amphoteric surfactants are not widely used in the textile industry. Their main advantage is the fact that they can be used in alkaline and acidic media and in combination with either cationic or anionic surfactants.

Quaternary ammonium compound derivatives are very rarely applied, while other low-toxicity types are increasing in use. Examples are:

- betaine derivatives
- imidazolines
- modified fatty amino ethylates (they have very good emulsifying and dissolving capacity for removing oligomers in the reductive cleaning of polyester fibres).

Amphoteric surfactants are expensive and their use is required only in specialised situations where wide ranges of compatibility are needed.

8.2 Auxiliaries and finishing agents for fibre and yarn manufacturing

Within this class are included those organic compounds that are applied to the fibre during its manufacturing and yarn formation processes. The names used for these auxiliaries in this section are taken from the TEGEWA nomenclature ("TEGEWA nomenclature, 1987"). They are classified as follows:

- spinning solution additives, spinning additives and spinning bath additives
- preparation agents for primary spinning
- preparation agents for secondary spinning (conditioning agents and lubricants)
- coning oils, warping oils and twisting oils.

Special attention is given to them because they are removed during textile pretreatment, in most cases contributing to a significant proportion of the emissions to water and to air at finishing mills.

The general chemical composition of yarn and fibre preparation agents is based on four main classes of components, the proportions depending on the function of the specific preparation agent:

- lubricants
- emulsifiers
- wetting agents
- antistatic agents
- additives (e.g. biocides, antioxidants, agents for the compactness of the thread).

Lubricants

Typical applied lubricants are:

- mineral oils
- ester oils
- synthetic lubricants (which include synthetic esters, EO/PO adducts, silicones, etc.).

The term "*mineral oils*" is used to indicate lubricants derived from refined crude oil. They are mixtures of hydrocarbons with C₁₂ – C₅₀ chain length, having a range of boiling points between 220 °C and 450 °C. Due to the presence of undesirable and unstable impurities, mineral oils smoke and give rise to air emissions during high-temperature treatments.

Mineral oils are hardly biodegradable and can only be removed by absorption. However, as regards water pollution, the main concern is over the presence of polyaromatic hydrocarbons (these compounds are included in the list of priority hazardous substances to be controlled through EU-wide measures under the Water Framework Directive).

The amount of polyaromatic compounds in mineral oils varies according to the refining process adopted and decreases as the oils become less polydisperse (refined mineral oils are commonly known as white oils). Pharmaceutical-grade mineral oils contain less than 0.1 ppm of polyaromatic hydrocarbons, but they are about three times more expensive than conventional mineral oils.

The use of mineral oils is declining. Because of their low cost, however, they are still widely used in applications where cheap products are needed (mainly as coning oils and, to a lesser extent nowadays, as wool processing auxiliaries).

Esters oils are usually fatty acids esterified with fatty alcohols, alcohols or polyhydroxylic alcohols. They are normally obtained by saponification of natural fats or oils.

Ester oils are used as lubricants as an alternative to mineral oils. Compared to mineral oils, ester oils are more thermally stable, biodegradable and easier to emulsify. They are increasingly substituting mineral oils in primary spinning, but mineral oils still have the highest market share in secondary spinning.

Synthetic lubricants (so-called synthetic oils) are synthetic base fluids especially tailored to the lubrication function. Because synthetic oils are composed of molecules that are uniform in weight and structure, they can withstand temperatures exceeding 200 °C, which also results in higher oxidative and thermal stability than mineral oils. For these reasons they outperform mineral oil-based products in many respects, allowing for higher operating temperatures, less lubricant loss and improved flexibility in a wide range of operating conditions.

Synthetic oils are free of all metals, sulphur, phosphorus and wax. Certain lubricants are highly biodegradable, thereby having reduced negative impact on the environment.

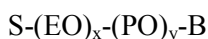
There are several major classes of synthetic lubricants:

- synthesised hydrocarbons, such as polyalphaolefins (PAO) and dialkylated benzenes, which are the most common type
- synthetic esters, such as dibasic acid and polyol esters
- polyglycols
- silicones.

Synthetic esters are synthesised from relatively pure and simple starting materials to produce predetermined molecular structures designed specifically for high performance lubrication. Compared to ester oils obtained from natural fats and oils, these molecules are more uniform in size, which means that they are more thermally and oxidatively stable.

EO/PO copolymers are used for texturised chemical fibres because they do not interfere with the process as mineral oils do.

The chemical structure of these synthetic lubricants can be schematised as follows:



S = starting component which can be short-chain alcohols (e.g. C₄-), polyols, organic acids or primary amines;

B = block component which can be ethers (OR), esters (COOR), acetals CH(OR)₂ or OH

The high molecular EO/PO-adducts (sum of EO and PO units is more than 15 moles and the sequence of PO units is higher than 5) are non- or hardly biodegradable.

Silicones are used as lubricants in several areas, including the manufacturing of fibres such as elastane and polyamide. They are chemically inert, non-toxic, fire resistant and water repellent. They are of great value in applications involving extreme temperatures, where high oxidative and thermal stability is required.

Silicones show the highest level of COD of all lubricants and they are hardly biodegradable, but they are bioeliminable and not dangerous to aquatic life. The main disadvantage is that they are difficult to emulsify and remove from the fibre. APEO are usually used to remove them and quite a high percentage (approximately 40 %) remains on the fibre after washing, giving rise to air emissions in the subsequent high-temperature treatments.

Emulsifiers

In order to apply the preparation agent as an aqueous system when the lubricant is not soluble in water, an emulsifier is normally present in the formulation. Anionic and non-ionic surfactants are used as emulsifiers. The main surfactants employed are:

Anionic surfactants: - sulphonated and sulphated vegetable oils

Non-ionic surfactants: - ethoxylated fatty alcohols
- ethoxylated fatty acids
- ethoxylated sorbitan esters
- alkyl phenol ethoxylates (APEO)
- partial glycerides and ethoxylated triglycerides.

Wetting agents

These are usually short-chain alkyl phosphates.

Antistatic agents

The anionic surfactants also have anti-electrostatic properties. Mono and diesters of phosphorus pentoxides (mainly their potassium salts) are in use as special anti-electrostatic agents as well as amphoteric surfactants such as sarcosides, amine oxides and sulpho succinates.

Additives

Aqueous systems can be attacked by bacteria and so must incorporate a bactericide. Biocides such as formaldehyde-containing compounds are applied as preservatives with a load of about 50 mg/kg fibre. Heterocyclic compounds (imidazolinone and isothiazolinone derivatives) with a load of about 2 mg/kg fibre are also encountered.

When the preparation agents are applied as neat oils or sufficiently stable solutions, instead of aqueous emulsions, the addition of biocides can be avoided, unless they are needed to protect the yarn during storage.

The amounts of active substances added to the fibres and the composition of the applied formulations may vary widely with fibre type and end-use. A rough overview is given in Table 8.1, but a more detailed description of typical formulations used and the load applied on the substrate is given in the following sections (based on an updated version of [7, UBA, 1994]). In Table 8.1 no distinction has been made between the different types of fibres; only elastomeric fibres and fibres destined for the manufacturing of knitted fabric have been considered separately because of the higher amount applied to the substrate in these cases. Furthermore, the load indicated under the column "Yarn manufacturing" refers to the overall amount of preparation agents applied to the fibre after the production of the fibre itself (including coning oils, twisting oils, oils applied to the filament after the texturing process, etc.).

		Fibre manufacturing		Yarn manufacturing		Total	
		g/kg substrate	COD mgO ₂ /g	g/kg substrate	COD mgO ₂ /g	g/kg substrate	COD mgO ₂ /g
Flat filament	Non-elastomeric	10	2000	20	3000	30	2700
	Elastomeric	100	1000	50	1000	150	1000
	Filament for knitted fabric	10	2000	30	3000	40	2750
Texturised filament	Non-elastomeric	8	2000	20	3000	28	2700
	Filament for knitted fabric	8	2000	30	3000	38	2800
Staple fibres	Non-elastomeric	3	2000	20	3000	23	2850
	Elastomeric	50	1000	50	1000	100	1000
	Yarn for knitted fabric	3	2000	30	3000	33	2900
Source: [194, Comm., 2001]							

Table 8.1: Overview of the loads of auxiliary agents applied on the fibre and yarn during the production process

8.2.1 Spinning solution additives, spinning additives and spinning bath additives

Within this group of auxiliaries only those that are washed off during pretreatment operations are mentioned. In this respect, the so-called “modifiers” used for viscose are most relevant. The applied load varies between 5 mg/kg fibres to a few grams per kg of fibre depending on the application field. They mainly consist of ethoxylated fatty amines or polyethylene glycol ethers with molecular weights of about 1500. During pretreatment, more than 90 % of these substances are washed off.

8.2.2 Preparation agents for primary spinning

These preparation agents are applied (mainly as aqueous solutions) during the manufacture of chemical fibres, directly after primary spinning (see Section 2.2). They enable subsequent processes such as drawing, twisting, warping, texturing and further spinning (secondary spinning, in the case of staple fibres).

The preparation agents give the chemical fibres the necessary properties (optimal friction, avoidance of electrostatic charging and cohesion in the case of multifilament yarns) not only between the fibres, but also between the fibres and the guide elements of the machines.

In general the substances applied have high affinity with water, either because the emulsifiers are already contained in the formulations or because the lubricant molecules themselves are self-emulsifying systems.

The application loads and the characteristics of the formulations applied are given for:

- non-texturised filament fibres (Table 8.2)
- texturised filament fibres (Table 8.3)
- staple fibres (Table 8.4).

Textile substrate	Load (g/kg textile substrate)	Explanations
PES	5 – 10	The content of lubricants is 40 - 70 %, the remaining fraction consists of emulsifiers (mixtures of non-ionic and anionic surfactants such as fatty alcohols and fatty acids ethoxylates, sulphonated and sulphated vegetable oils), wetting agents (short chain alkyl phosphates), antistatic agents (e.g. mono and diesters of phosphorous pentoxides, sarcosides, amine oxides and sulphosuccinates)
PA	8 – 12	Same composition as above
CA	20	The content of lubricants in the formulations is about 60 - 85 %. Less refined mineral oils can be used than for PES and PA fibres
CV	10	
PP	5 – 15	Preparation agents consist of 100 % surfactants (typically 90 % alkoxyated components, 10 % phosphoric esters as anti-electrostatic agents and additives)
EL	30 - 70	Preparation agents mainly consist of dimethyl polysiloxanes
Source: [179, UBA, 2001]		
Notes: The reported loads relate to the quantity of active substance, not to the quantity of applied aqueous emulsion		

Table 8.2: Load of preparation agents on non-texturised filament yarns (flat yarns)

Textile substrate	Load (g /kg textile substrate)	Explanations
PES	3 - 8	Spinning preparation agents consist of 50 - 90 % EO/PO-adducts. As with flat filaments, they contain non-ionic and anionic components (see Table 8.2)
PA	3.5 – 5.5	Preparation agents are based on EO/PO-adducts as well as on ester oils (mineral oils are not used).
	7 - 12	Load used for carpet yarn. In the past, preparation agents consisted of emulsified mineral oils, but today these formulations are very rarely used. They have been substituted by ester oils (trimethylol propane ester and pentaerythril ester) applied together with non-ionic surfactants
PP	8 – 12	The preparation agents consist of 100 % surfactants (the same used for flat filaments - see Table 8.2)
	8 - 15	Load used for carpet yarns
Source: [179, UBA, 2001] Notes: The reported loads relate to the quantity of active substance, not to the quantity of applied aqueous emulsion		

Table 8.3: Load of preparation agents applied on texturised filament yarns (texturised yarns)

Textile substrate	Load (g /kg textile substrate)	Explanations
PES - CO-type - WO-type	1 – 1.8	They consist of 50 – 80 % phosphoric esters and their salts and of 20 – 50 % non-ionic surfactants such as fatty acid ethoxylates and fatty alcohol ethoxylates and various additives in minor amounts
	2 – 2.5	
PA	4 – 6	PA staple fibres are normally used for carpet yarns. Their preparation agents have compositions similar to those used for PES. Mineral oils and ester oils can also be part of the recipes
CV	3 – 6	Non-ionic surfactants (fatty acid ethoxylates) are used; fatty acid soaps and phosphoric ester salts are additional typical ingredients
PP	5 – 10	The formulations have the same composition as those used for filament yarns (see Table 8.2)
PAC	3 - 8	Different types of formulations are used (e.g. polyamine fatty condensates, short-chain quaternary ammonium compounds). These compounds are difficult to remove in the subsequent processes. Anionic systems as well as non-ionic systems are applied (the same used for PES).
Source: [179, UBA, 2001] Notes: The reported loads relate to the quantity of active substance, not to the quantity of applied aqueous emulsion		

Table 8.4: Load of preparation agents applied on chemical staple fibres

8.2.3 Preparation agents for secondary spinning (conditioning agents and spinning lubricants)

For these agents there is no clear definition. In the following, preparation agents for secondary spinning of synthetic staple fibres and cotton are referred to as "conditioning agents", while preparation agents for wool will be referred to as "spinning lubricants".

Conditioning agents are also required during secondary spinning of synthetic fibres, when the fibres have been previously submitted to bleaching or dyeing processes. The amount initially applied is in fact lost during these processes.

The chemical composition of conditioning agents for synthetic fibres is similar to that of the preparation agents used for primary spinning of staple fibres (see Table 8.4). The load ranges between 1 and 10 g/kg fibres.

Spinning lubricants are applied to wool fibres to assist efficient mechanical processing during yarn manufacturing (spinning). They are generally applied as aqueous emulsions and for this reason they also contain an emulsifier and a biocide to prevent bio-attack. In most cases the emulsification system is based on APEO [66, CRIT, 1999], although according to other sources ([32, ENco, 2001]) the major suppliers have sought to eliminate alkylphenol ethoxylates by substituting them with linear alcohol ethoxylates.

When the spinning lubricant is to be applied to wool blends with synthetic fibres, an antistatic agent is also needed.

As regards wool and blends of wool with synthetic fibres, four basic types of spinning lubricants can be identified [32, ENco, 2001]:

- emulsifiable mineral wool oils based on a mixture of refined mineral oil (<1 % polyaromatic content) and an emulsification system
- water-dispersible lubricants (sometimes referred to as "Super Mineral Oils" or "Semi synthetics") based on a mixture of refined mineral oil, saponifiable fatty oils and an emulsification system. These formulations generally contain a higher proportion of emulsifiers than emulsifiable wool oils
- synthetic water-soluble lubricants based on polyethylene- polypropylene glycols, which are particularly useful when the yarn is to be scoured in the dye bath, but may also be used on yarns that will be scoured in a separate operation
- dry spinning lubricants (only for carpet yarn – see Section 2.14.5.1), which differ from the above in that they are applied at lower levels and they remain on the yarn following conversion to carpet. These materials generally contain a higher proportion of antistatic agents.

The loads for cotton, viscose staple fibres and wool are reported in Table 8.5

Textile substrate	Load (g /kg textile substrate)	Explanations
WO and CO-wool-type; (staple fibre length > 60 mm)	30 - 50	Load applied during “oil spinning” of carded yarns
	8 – 10	Load applied during “dry spinning” of carded yarns without subsequent dyeing
	<10	Load applied during spinning of semi-worsted yarn (oil at a level of less than 1 % is normally not removed from the yarn before dyeing)
CO or CV	4	Many recipes are in use, mostly containing white oils and ester oils (30 – 40 %) and non-ionic surfactants. Mineral oil-free systems are also available.
Source: [179, UBA, 2001] Notes: The reported loads relate to the quantity of active substance, not to the quantity of applied aqueous emulsion		

Table 8.5: Load of conditioning agents and lubricants applied on cotton, viscose (staple fibres) and wool

If further processing of dyed yarns or flocs is planned, an additional amount of conditioning agents (3 - 5 g/kg) is applied normally in discontinuous by bath exhaustion at the textile finishing mill. Thereby the exhaustion rates for PES and PA can be very low (10 – 30 %). Conversely, they are relatively high for CO and PAC (>80 %).

8.2.4 Coning oils, warping and twisting oils

For processes such as coning, twisting and warping of flat and texturised filament yarns as well as of staple fibre yarns, chemicals have to be applied in order to enhance smoothness, lubrication and antistatic properties.

Oils for coning, warping, twisting and those applied to the filament after the texturing process (sometimes called overlay oils) consist of 70 – 95 % white oils and of 5 – 30 % non-ionic surfactants, especially fatty alcohols and fatty acids ethoxylates. Twisting oils often consist of ester oils which are more biodegradable than white oils. Ester oils are used especially if evaporation has to be avoided or minimised, especially during heat-setting.

The load of coning oils depends on the further processing and the volume of the yarn. It varies for PES from 5 to 30 g/kg (15 g/kg average). For common PA the load is 5 g/kg and in the case of highly elastic PA it is up to 15 - 20 g/kg. It is reported that imported fabric can have loads of coning oils above 50 g/kg.

The load for warping oils and twisting oils is about 5 g/kg.

8.2.5 Knitting oils

The needles of knitting machines have to be lubricated with so-called knitting machine oils. Due to machine losses, these oils remain on the knit fabric (about 4 – 8 % of the weight of the fibre). They should now be based on synthetic oils, but in practice mineral oil-based formulations are

still common. This also means that surfactant aids need to be added in the scouring bath in order to emulsify them.

8.3 Sizing agents

In this section the following information is presented:

- characteristics of the most common sizing agents
- typical amounts of sizing agents applied on the different substrates (Table 8.6)
- specific COD and BOD₅ values for the most common sizing agents (Table 8.7).

Starch

Starch is the most common natural size and can be derived from various substances, especially corn and potatoes. It is not always suitable for high performance weaving mills. When stored at lower temperatures, it tends to solidify to pulpy mass and loose the hydration water (retrogradation). This retrogradation leads to poor storage properties, skin formation, formation of deposits on the rollers and reduced adhesive strength. As a result natural starch is commonly used in formulation with other sizes [186, Ullmann's, 2000].

Starch is completely biologically removed, but it is only sparingly soluble in water; the action of animal or vegetable enzymes is needed. These enzymes decompose the starch into water-soluble sugars, which are then removed by washing before scouring. As a result starch cannot be recycled and is responsible for most of the COD load in finishing effluents. Moreover, in comparison with other sizing agents, starch must be applied at about twice the rate of carboxymethyl cellulose, because of the poorer sizing effect, thereby leading to a higher COD in the waste water.

Starch derivatives

Starch derivatives include dextrans, starch esters and starch ethers. They are increasingly replacing natural starches, as their tendency to retrograde is considerably reduced.

The starch esters most commonly used are the esters with phosphoric acid (phosphate starches) and acetic acid (acetyl starches).

The three most important starch ethers are the hydroxyethyl, hydroxypropyl and carboxymethyl starches.

Starch derivatives based on esters can, to a great extent be biologically reduced, while starches based on ethers are more difficult to biodegrade. However, the great variety of possible chemical modifications makes it possible to produce good slashing agents, which can be virtually completely biodegraded.

Like natural starch, starch derivatives must be also applied at about twice the rate of CMC or synthetic agents, thereby leading to higher COD in the effluents.

Cellulose derivatives (carboxymethyl cellulose)

Sodium carboxymethyl cellulose (CMC) is the only water-soluble cellulose derivative used as a sizing agent. It is produced by reacting cellulose with sodium hydroxide and sodium chloroacetate, whereby the cellulose polymer is also depolymerised.

CMC is the preferred additive for increasing the adhesion of starch sizes for cotton.

Its chain length and degree of substitution influence the level of biological reduction. However, carboxymethylcellulose (CMC) must be classified as being very difficult to degrade.

According to UBA, only 20 % of the initial amount is eliminated after 7 days. However, it is also reported that CMC can be reduced after long periods of adaptation (>4 weeks) and favourable conditions (especially higher temperatures) [7, UBA, 1994]. Other sources mentioned by UBA state that a biological reduction rate of 60 % is attained after 7 days.

Galactomannan derivatives

Hydroxypropyl and carboxymethyl galactomannan derivatives are water-soluble and easy to remove by washing. In general they can reach high levels of biological reduction (greater than 90 %). However, biodegradability as well as other properties can vary significantly with molecular weight and the mannose/ galactose ratio.

Polyvinyl alcohol (PVA)

Since the monomeric vinyl alcohol does not exist, poly(vinyl alcohol) is produced by the hydrolysis of the poly(vinyl acetate).

The parameters that determine sizing properties are the degree of polymerisation and the degree of hydrolysis. There are two grades: the partly hydrolysed grade with a degree of hydrolysis of ca. 88 % and the fully hydrolysed grade with a degree of hydrolysis of ca. 98 %.

Partially hydrolysed PVA grades are preferred for use as sizing agents because they show maximum water solubility and they adhere strongly to non-polar fibres such as PES. In addition to these conventional poly(vinyl alcohol) grades, copolymers with methyl methacrylate or with co-monomers having carboxyl groups are also used as sizing agents.

The degree of polymerisation and the degree of hydrolysis lead to significant differences in terms of biodegradability between the individual types of polyvinyl alcohols. PVA is not acutely toxic to micro-organisms and does not inhibit nitrification. It can be quantitatively eliminated by biological degradation after adaptation of the sludge. The conditions for a 90 % reduction are: relatively high concentrations (20 mg/l), temperature above 18 °C and a regular load over a long period of time (in wintertime and in the holiday period problems can occur) [7, UBA, 1994]. Given such adaptation, PVA can be classified as having good bioeliminability.

Poly(meth)acrylates

Poly(meth)acrylates show considerable variation in chemical structure (the building blocks can be: acrylic acid, acrylic esters, acrylamide, acrylonitrile, methacrylic acid) and therefore have a very wide range of applications. Hydrophilic monomers like methacrylic acid and its salts and acrylamide give good adhesion to polar fibres and ease of removal by washing. Hydrophobic monomers such as the acrylic esters increase the elasticity of the sizing film and improve the ease of removal from waste water.

Poly(methacrylates) cannot be reduced biologically, not even after a period of adaptation. Hydrophilic products cannot even be eliminated from the aqueous phase, because they behave as hydrophilic polyelectrolytes.

An improvement is represented by poly(methacrylates) based on esters. In this case, thanks to the presence of hydrophobic groups, the poly(methacrylates) can be 90 % bio-eliminated by adsorption onto sludge after a residence time of 6 – 9 hours (which in practice is secured many times over) [18, VITO, 1998]. However, it is important to point out that the bio-elimination curve gives rise to a number of questions about the elimination mechanisms (the elimination mechanisms are not clear).

Polyesters

Polyesters are generally condensates of aromatic dicarboxylic acids with diols (e.g. ethylene glycol, diethylene glycol) and sulphonated aromatic dicarboxylic acids (the latter provide solubility or dispersability in water, they are mainly added to improve dyeability).

Their biodegradability is bad, but they show a certain degree of bioelimination [77, EURATEX, 2000]. They are mainly used for sizing flat filament yarns. They are also found as co-components in sizing agents for staple fibres made of polyester blends.

Textile substrate	Load (g /kg warp yarn) ⁽¹⁾	Explanations
<u>Staple fibres</u>		
- CO and CO/PES	80 – 200	As sizing agents starch and starch derivatives, very often in combination with PVA, CMC or polyacrylates are applied. Thereby the ratio of starch/starch derivatives to synthetic sizing agents is generally 3:1, and 1:1 for air jet weaving machines. The loads depend especially on the density of warp yarns and on the kind of sizing agent (for starch/starch derivatives is significantly higher (150 – 200 g/kg)).
- CV	40 – 120	The load is 60 g/kg average. Normally combinations of all available sizing agents are applied, e.g. polyacrylates in combination with CMC and/or starch derivatives
- WO	0 – 20 ⁽²⁾	Woven fabric consisting of wool is usually produced with twisted yarn, so the warp yarns for the weaving process do not need to be sized. In the case of simple yarns (in practice not very significant) up to 200 g/kg starch/starch derivative (80 %) in combination with synthetic sizing agents are applied.
<u>Filament yarns</u>		
- PES	40 – 60	For 90 % of PES flat yarns polyester sizing agents (which can be dispersed) are applied; the rest is sized with modified PVA and polyacrylate.
	80 – 120	This is the load for texturised yarns; about 80 g/kg for polyester sizing agents, about 120 g/kg for PVA and about 100 g/kg for polyacrylates
- PA	20 – 50	Polyacrylic acid is used as sizing agent; 50 g/kg is applied for very thin fabric only
- CV	15 – 30	Mostly for linings for which polyacrylates are used as sizing agents
- CA	15 - 60	Polyacrylates and polyvinyl acetate are applied
Source: [179, UBA, 2001]		
Notes:		
⁽¹⁾ the figures refer to woven fabrics with 60 % of warp yarn		
⁽²⁾ as wax		

Table 8.6: Amounts of sizing agents applied on different types of substrates

Knowing the loads of sizing agents on the different substrates the calculation/estimation of organic loads as BOD₅ and COD is possible, provided that specific BOD₅ and COD values are available. These values are given in Table 8.7.

Kind of sizing agent	Specific COD-value (mg O ₂ /g)	Specific BOD ₅ -value (mg O ₂ /g)
Starch	900 – 1000 * ¹	500 – 600
CMC	800 – 1000 * ¹	50 – 90
PVA	c. 1700 * ¹	30 – 80 * ²
Polyacrylates	900 – 1650	< 50
Galactomannans	1000 – 1150 * ¹	400
PES-dispersions	1450 – 1700	< 50
Protein sizing agents	1200	700 – 800
Protein sizing agents	1200	700 – 800

Source: [179, UBA, 2001]
Notes:
*¹ Considering the usual moisture content of commodity
*² For non-adapted "inocula"

Table 8.7: Specific COD and BOD₅ values for the most common sizing agents

8.4 Detergents/ wetting agents

These auxiliaries are mainly used in pretreatment operations (scouring, mercerising, bleaching) in order to allow:

- thorough wetting of the textile material
- emulsification of lipophilic impurities
- dispersion of insoluble matter and degradation products.

Non-ionic and anionic surfactants are the compounds more frequently used for this purpose (see also Section 8.1). Some examples of products available on the market are listed in Table 8.8.

Class	Examples of products available on the market	Bio-degradability (1)	Bio-eliminability (2)
Non-ionic	Alcohol and fatty alcohols ethoxylates	>90 %	80 – 85 %
	Fatty acids ethoxylates	>90 %	80 – 85 %
	Alkylphenol ethoxylates (APEOs)	~60 %	54 – 58 % (toxic metabolites)
	Fatty amines ethoxylates	60 – 80 %	72 – 73 %
Anionic	Alkyl sulphonates	>98 %	
	Alkyl aryl sulphonates	>98 %	
	Alkyl sulphates	>98 %	
	Dialkylsulphosuccinates	>98 %	
	Alkyl carboxylates (e.g. sodium palmitate, -stearate)	>98 %	
	Sulphated alkanolamides	n.d.	

Notes:
(1) OECD-test 301 E
(2) OECD-test 302 B
Source: [77, EURATEX, 2000], [218, Comm., 2000]

Table 8.8: Typical compounds used as detergents/ wetting agents

8.5 Auxiliaries containing sequestering agents

The presence of ions of alkaline earth metals (calcium and magnesium) and/or other metals (especially iron) may have important negative effects on various wet processes not only in pretreatment, but also in dyeing. Purified and softened water is used in textile finishing mills, but often this is not enough and specific auxiliary formulations containing complexing agents need to be added to the baths.

Auxiliaries with this effect are often classified according to the specific process for which they are applied (*extractants, sequestering agents/ dispersants*, etc.). Commonly used complexing agents are EDTA, NTA, DTPA, phosphonic acid and gluconic acid derivatives.

The *hydrogen peroxide stabilisers* represent another important category of auxiliaries containing complexing agents. The uncontrolled decomposition of hydrogen peroxide gives rise to OH* radicals. These radicals attack the cellulose fibre starting with oxidation of the hydroxyl groups and eventually ending with the cleavage of the cellulose molecules, decreasing the degree of polymerisation. This reaction is catalysed by heavy metals such as iron, manganese, copper and cobalt.

In order to inhibit these reactions, bleach stabilisers, containing sequestering agents, are usually applied. EDTA, DTPA, NTA, gluconates, phosphonates and polyacrylates are typical stabilisers.

Environmental problems associated with sequestering agents arise from the same properties for which they are used, which is their ability to form stable complexes with heavy metals. EDTA, NTA, and DTPA in particular form very stable metal complexes. EDTA and DTPA are also poorly eliminable compounds. There is therefore there is the risk they can pass undegraded through the common waste water treatment system and then eventually release the metals into the receiving effluent or that they may remobilise heavy metals in aquatic sediments.

NTA is biodegradable (when treated in waste water treatment plants under nitrifying conditions) and recent studies have shown that it only plays a minor role, if any, in the remobilisation of heavy metals in aquatic sediments [280, Germany, 2002].

Concerning the other organic substances used as complexing agents, gluconates are biodegradable; phosphonates are not biodegradable, but they are bioeliminable (photocatalytic degradation is also observed [77, EURATEX, 2000]).

8.6 Dyeing auxiliaries

8.6.1 General characteristics and environmental aspects

Auxiliaries are essential components in dyeing processes. This section describes the ones most commonly used to assist the dyeing process. They are presented based on their function in the process as follows:

- wetting, penetrating agents
- dispersing agents
- levelling agents
- acid donors
- antifoaming
- carriers.

Other auxiliaries such as, for example, the complexing agents that are also commonly used in dyeing processes but that can also be encountered in other operations, are described in other parts of this annex.

Commercial products are in general preparations containing several components. These are mainly surfactants, but non-surface-active substances such as water-soluble polymers and oligomers and polymer dispersions are also frequently employed.

With a few exceptions dyeing auxiliaries are released to waste water. Some of them are biodegradable (e.g. fatty alcohol ethoxylates, linear alkylbenzene sulphonates), while others have poor biodegradability, but they are sparingly soluble in water and are therefore largely eliminated by absorption on the activated sludge in waste water treatment plants. There is, however, a list of substances that are soluble in water and poorly eliminable in common waste water systems. Compounds that belong to this category and that are frequently encountered in dyeing auxiliaries are listed as follows:

	Additional remarks
- Condensation products of beta-naphthalene sulphonic acids and formaldehyde	Modified condensation products of naphthalene sulphonic acid with formaldehyde are reported to have about 70 % bioeliminability, according to test method OECD 302 B (see also Section 4.6.3)
- Lignin sulphonates	
- Acrylic acid-maleic acid co-polymers	Elimination rate depends on the content of Ca ⁺⁺ ions in the waste water
- o-phenylphenol derivatives - Methyl-naphthalene derivatives	Also toxic for aquatic species
- Cyanamide-ammonia salt condensation products	
- Polyvinylpyrrolidones	
- Quaternary ammonium compounds	Also toxic for aquatic species
- Ethoxylated fatty amines	
- Alkylphenol ethoxylates	Metabolites of alkylphenol ethoxylates are reported to influence the reproduction of aquatic species by disrupting the endocrine system (see also Section 8.1)
- Chlorinated aromatic compounds such as trichlorobenzenes or dichlorotoluene (carriers)	Also characterised by high acute toxicity
- Biphenyl derivatives (carriers)	Also characterised by high acute toxicity

8.6.2 Wetting, penetrating and de-aerating agents

This group of products is perhaps the most difficult to define in terms of technical function. Wetting and de-aerating agents often perform the same function: that of expelling air from the textile assembly contained in the dye bath. The use of penetrating agents is invariably associated with the dyeing of yarns with a high twist factor, where they enhance transport of the dye into the yarn assembly. In this respect it could be argued that they are in fact a levelling agent. All the products in this class are invariably powerful surfactants.

Commonly used commercial products are mainly readily bio-eliminable compounds such as alcohol polyglycol ethers and esters (also in blends with alkane sulphone), but poorly degradable products such as ethoxylated amines can also be encountered.

8.6.3 Dispersing agents

Vat, disperse and sulphur dyes already have a high content of dispersing agents in their formulation, which allows the application of these colourants in the form of aqueous dispersions. Additional amounts of dispersants are usually added (also for other classes of dyes) in the subsequent steps of the dyeing process to maintain the stability of the dispersion throughout the dyeing (or printing) process.

Substances commonly used as dispersing agents are condensation products of naphthalene sulphonic acid with formaldehyde, lignosulphonates. Anionic and non-ionic surfactants (e.g. ethoxylated alcohols, phosphated alcohols and naphthalene sulphonates) are also applied. Environmental aspects of these substances are reported in Section 8.6.1, whereas more general information about surfactants can also be found in Section 8.1. Dispersing agents with improved bioeliminability are now available for some dye formulations (see Section 4.6.3).

8.6.4 Levelling agents

Levelling agents are used in batch dyeing processes to improve the uniform distribution of the dye in the fibre. They are probably the most important class of dyeing auxiliaries, as a grossly unlevel dyeing is of no commercial value and is difficult to correct. They are employed for different types of fibres, therefore the substances employed can be different. Nevertheless two main groups of levelling agents can be identified: products which have an affinity for the fibre and products which have an affinity for the dye. Products which have an affinity for the fibre compete with the dye for dye-sites on the fibre. In this way they reduce the rate of absorption of the dye and improve their migration. To the second group belong substances that form loosely bound complexes with the dye, reducing its mobility and in some cases neutralising the electrostatic attraction between the dye and the fibre.

The most common substances used as levelling agents are reported below, divided on the basis of the fibre to which they are applied and dyestuff.

Fibre	Dye	Possible components
Cellulose fibres	Vat dyes	Fatty alcohol ethoxylates Fatty amines ethoxylates Polyamide amines Polyvinylpyrrolidone
	Direct dyes	Non-ionic surfactants such as ethoxylated fatty alcohols, fatty amines, fatty acids, alkylphenols or propylene oxide polymers Anionic surfactants such as fatty alcohol sulphates and alkyl aryl sulphates Polyvinylpyrrolidone
Wool	Acid, metal complex and reactive dyes	Ethoxylated fatty amines Quaternary ammonium compounds Bisulphate anion (HSO_4^-) Other non-ionic surfactants such as ethoxylated fatty alcohols, fatty acids, alkylphenol and fatty mercaptans may also be found in specific products
Polyamide	Acid and metal complex dyes	Anionic, cationic and non-ionic surfactants used for wool Condensation products of aromatic sulphonic acids, alkyl sulphates (also called "PA reserving/ blocking agents")
	Disperse dyes	Non-ionic surfactants
Polyester	Disperse dyes (at HT conditions)	Ethoxylated castor oil, stearic acid, alkylphenols Mixtures of alcohols, esters or ketones of medium chain length with emulsifying systems Hazardous carriers were used in the past as levelling agents, today they are no longer used in high-temperature dyeing processes
Polyacrylonitrile	Basic dyes	Quaternary ammonium salts with C_{12} - C_{14} fatty alkyl side chains (also known as retarders) Quaternary ammonium salts with aromatic ring systems

Table 8.9: Typical compounds encountered in levelling agents

Consideration of the environmental aspects associated with the use of these compounds is reported in Section 8.6.1 and more general information about surfactants can be found in Section 8.1.

8.6.5 Acid donors

The so-called acid donors represent a more sophisticated range of formulated products designed to create shifts in dye bath pH. They are hydrolysable acid esters which break down during dyeing, progressively lowering the pH. The shift of pH occurs as the acid is released by hydrolysis during heating or as one of the acid/base components is transferred to another phase such as the fibre or the air, e.g. ammonia release to air with ammonium sulphate.

They are widely used for wool and/or polyamide fibres to control the absorption of anionic dye onto the fibre. They are also employed for cotton and polyester blends when dyeing with disperse and reactive dyes in the one-bath one-step procedure.

Organic acid esters, fatty alcohol ethoxylates and aromatic sulphonates are commonly found in commercial products. They usually have good bio-eliminability.

8.6.6 Antifoaming agents

Formulated products designed to suppress foam formation are used, which do not adversely influence the quality of the resultant dyeing. The majority are based on silicone derivatives.

8.6.7 Carriers

Dyeing accelerants (so-called carriers) are used in batch dyeing of synthetic fibres (particularly polyester fibres) to promote the absorption and diffusion of disperse dyes into the fibre under low-temperature conditions. They are still important for dyeing blended fibres of wool and polyester, as wool cannot withstand dyeing under high temperature conditions (above 100 °C). Typical carrier formulations contain 60 – 80 % of active substance and 10 – 30 % of emulsifier and sometimes a small percentage of solvent.

Typical active substances for dyeing accelerants include:

- halogenated benzenes (1,2 dichlorobenzene; 1,2,4-trichlorobenzene; dichlorotoluene)
- aromatic hydrocarbons such as alpha- and beta-methylnaphthalene, diphenyl, trimethyl benzene, etc.
- phenols such as o-phenylphenol, benzylphenol, etc.
- carboxylic acid and their esters such as methyl, butyl and benzyl benzoate, methylsalicylate, phthalic acid, dimethylphthalate, dibutylphthalate and diethylhexylphthalate
- alkyl phthalimides such as N-butylphthalimide.

Most of the above-mentioned substances are toxic to humans, aquatic organisms and sewage sludge. *Hydrophobic* carriers exhaust at about 75 – 90 % onto the substrate, while *hydrophilic* types like phenols (e.g. o-phenylphenol), benzoate derivatives, N-alkylphthalimides and methylnaphthalene are mainly found in waste water. Exception made for benzoates (biodegradable) and N-alkylphthalimide derivatives (bioeliminable), the others are all poorly degradable and may pass undegraded through the waste water treatment system. On the other hand the carriers that remain on the textile material (hydrophobic types) are partially volatilised during the subsequent heat treatments (drying or fixing processes), thus producing air emissions.

Carboxylic acid esters and alkylphthamides derivatives are the substances that are most frequently used in Europe today as carriers. However, it is reported that carriers such as methyl naphthalene, mono-, di-, tri-chlorobenzene, biphenyl, orthophenyl phenol and benzyl alcohol are still found in use [61, L. Bettens, 1999].

8.7 Printing auxiliaries

8.7.1 Auxiliaries for dye printing

Thickening agents

Thickening agents are essential components of printing pastes. They are responsible for preventing capillary flow between the threads of the fabric, thus inhibiting dye diffusion. Oil/water emulsions, used in the past as thickeners, have now been largely replaced by formulations similar to those used for warp sizes. Standard components of modern thickeners include natural polysaccharides, both unmodified and chemically modified (e.g. seed derivatives, starch degradation products, alginates) and fully synthetic polymers (mainly based on polyacrylic acid). Thanks to the improvements made in the characteristics of the starting materials, thickening agents are now supplied almost exclusively in cold-soluble form.

8.7.2 Auxiliaries for pigment printing

Thickening agents

Water-in-oil emulsions were widely used in the past as thickeners. They contained up to 70 % of white spirit (mixture of aliphatic hydrocarbons with C₁₂-C₅₀ chain length), which resulted in emissions of volatile organic carbon in the exhaust air from drying and curing ovens. Half-emulsion printing pastes (oil in water) are only occasionally employed today. Nevertheless, modern thickeners can still contain approximately 10 % of mineral oils, which are ultimately found in exhaust air. New generation thickeners have been developed which do not contain any volatile solvents. They are supplied in the form of non-dusting granules [64, BASF, 1994].

Binders

The pigment has no affinity for the fibre. Therefore, in order to coat the pigment and protect it from mechanical abrasion, a binder is added to the printing paste. Binders are in general self-cross-linking polymers which reticulate during the fixation step. They are supplied as aqueous polymer dispersions, based mainly on acrylates and less commonly on butadiene and vinyl acetate.

Fixing agents

Additional fixing agents are sometimes necessary to enhance the level of wet-fastness, especially with smooth fibres such as PES. Melamine-formaldehyde condensates are used for this purpose. In order to reduce the consequent formaldehyde emissions, modified compounds of the same chemical type, but with a low formaldehyde content, are now common.

Plasticisers

Plasticisers are mainly silicones or fatty acid esters, which are used to improve the dry rubbing fastness and give a smooth dry handle to the fabric.

Emulsifiers

In high- and low solvent pigment printing pastes, the emulsifiers serve to stabilise the solvent (white spirit). In solvent-free pigment printing they are used to prevent agglomeration of the pigment, screen blocking and separation of components of the print paste [186, Ullmann's, 2000]. Non-ionic surfactants such as aryl- and alkyl polyglycol ethers are the most commonly used for this purpose.

8.8 Finishing auxiliaries

8.8.1 Easy-care finishing agents

Easy-care finishing agents are chemical finishes which are applied to woven and knitted fabrics composed of cotton, other cellulosic fibres and their blends with synthetic fibres. Their function is to reduce the propensity of cellulose-containing fabrics for wrinkling when treated under wet and dry conditions and to stabilise them against progressive shrinkage during laundering. Their action is based on the introduction of cross-links between the cellulose molecules of cotton and viscose, thus reducing swellability and extensibility of the fibre (the fabric tends to return to the state in which it was when the cross-links were introduced).

Other names also commonly used to name these finishing agents are: resin-finishing, wash-and-wear finishing, no-iron, wrinkle resistant, etc.

Recipes for resin-finishing liquors are in general aqueous solutions or dispersions which consist of a cross-linking agent, a catalyst, a wetting agent/emulsifier (mainly a non-ionic surfactant) and a number of additives.

Among the additives a distinction is drawn between those that are used to improve the handle and to compensate the adverse effects of the cross-linking agent and some others that serve to impart additional functional properties to the final textile good (e.g. water-repellents, hydrophilising agents, etc.). Only the first group of additives is discussed in this section while the others, being less specific to this finishing treatment, are described in other parts of this Annex.

Cross-linking agents

The cross-linking agents play an essential role in this finishing treatment: they are also the major components in the formulation (they represent approximately 60 to 70 % of the total preparation).

From a chemical point of view there are three distinct groups:

- cross-linking agents based on melamine and formaldehyde
- cross-linking agents based on urea and formaldehyde
- heterocyclic linking agents based on urea, formaldehyde and various other substances such as diamines and, in particular, glyoxal.

All these products may potentially produce emissions of free formaldehyde and methanol. In particular, formaldehyde is suspected of carcinogenicity and its presence in these finishing agents represents a potential risk not only for waste water and exhausted air, but also for the workplace and the final user of the textile good.

Manufacturers have put much effort into producing cross-linking agents with a low to very low content of free formaldehyde and one compound is also available on the market, which is formaldehyde-free.

Existing cross-linking agents are therefore better classified as:

- formaldehyde-rich
- formaldehyde-poor or very poor
- formaldehyde-free.

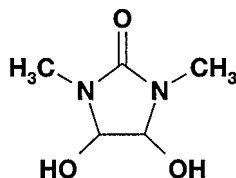
The first group includes compounds (so-called “self-crosslinking” agents) like (HOCH₂-NH-CO-NH-CH₂OH) hydroxymethyl urea and (CH₃OCH₂-NH-CO-NH-CH₂OCH₃) (bis(methoxymethyl) urea or the correspondent melamine derivatives (hydroxymethyl melamine and bis(methoxymethyl) melamine).

Low to very low levels of free formaldehyde are achievable with heterocyclic compounds (so-called “reactant cross-linking” agents) which are mainly based on the derivatives of the molecule better known as bis(hydroxymethyl)-dihydroxyethylene urea (see Figure below).



Modified derivatives of this compound with methanol and diethyleneglycol are among those reported to have a very low free-formaldehyde content in the product (<0.5 %, but also <0.1 % for some products is now achievable).

Among the formaldehyde-free cross-linking agents, only the compounds based on dimethyl urea and glyoxal (see Figure below) have gained a small share of the market [36, BASF, 2000]. In the absence of other sources of formaldehyde such as fixing agents and preservatives, the finishes obtained using these cross-linking agents are formaldehyde-free.



The emissions of formaldehyde, methanol and other volatile organic substances in the exhaust air (from curing and drying operations) and in the workplace (especially with melamine resins) represent the main environmental issue in the application of these agents.

Water pollution is also an issue since these active substances (ethylene urea and melamine derivatives), when in their not-cross-linked form, are water-soluble and in general hardly biodegradable. This problem is, however, restricted to residual liquors, which as a fundamental rule should not be discharged together with the other effluents in order to avoid contamination with these concentrated liquors.

Catalyst

The function of the catalyst in the resin-finishing recipe is to allow the curing reaction to be carried out at the usually employed curing temperatures (130 – 180 °C) and times.

The most commonly used catalyst is magnesium chloride. In many cases liquid mixtures are used, based on magnesium chloride and organic acids (e.g. alpha-hydroxycarboxylic acids) or inorganic Lewis acids.

Ammonium salts (e.g. chloride, sulphate and nitrate) commonly used in the past, particularly with cross-linkers based on urea and formaldehyde or melamine, are in decline today, following the corresponding decline in importance of these cross-linking agents.

Additives (softeners, stiffening agents, etc.)

As mentioned above, easy-care recipes contain various different additives. Attention is given here only to:

- products that are added to easy-care recipes to offset the reduction in softness, tear strength and abrasion resistance that is produced on the fibre as a secondary effect of the cross-linking reaction (their content in easy-care recipes is in general in the range of 10 – 40 %): these can be dispersions of polyacrylates, polysiloxanes, polyethylene waxes (partially oxidised polyethylenes), polyurethanes
- products that are added as softeners to improve the handle of the fabric: fatty acid condensation products (cationic softeners) represent the most important group. They can also be supplied as emulsified mixtures with other products (e.g. polyethylene wax)
- products that are used as stiffeners, hand builders: these can be dispersions of polyvinyl acetate, polyacrylate derivatives.

These substances are responsible for emissions of VOCs in the exhaust air from curing and drying operations.

The poor biodegradability of the above-mentioned polymer dispersions has also to be taken into account when considering water pollution.

8.8.2 Biocides

Some commonly used biocides are those that are applied in the carpet sector to impart wool fibre lifetime protection against a range of textile pests. These auxiliaries are usually known as mothproofing agents.

Currently used mothproofing agents are formulated from the following active ingredients:

- permethrin (synthetic pyrethroid)
- cyfluthrin (synthetic pyrethroid)
- sulcofuron (halogenated diphenylurea derivative).

Permethrin-based formulations account for approximately 90 % of the market. Cyfluthrin based products are only available in the UK, while sulcofuron-based products are currently not used to any significant degree.

Permethrin and synthetic pyrethroids in general are reported to have low toxicity to humans but high aquatic toxicity. Diphenylurea derivatives may exhibit less aquatic toxicity but, in some cases, are less biodegradable [11, US EPA, 1995].

Other types of biocides are used in the textile industry, mainly as antimicrobial finishes, (e.g. hospital textile material), or as odour suppressants for socks and hosiery. The active substances used for this purpose are most commonly [77, EURATEX, 2000]:

- zinc organic compounds
- tin organic compounds
- dichlorophenyl(ester) compounds
- benzimidazole derivatives
- triclosane
- isothiazolinones (the most commonly used today).

All biocides give rise to environmental concern when they are discharged in waste water, because of their toxicity to aquatic life.

8.8.3 Antistatic agents

This section focuses on the antistatic agents that are applied as functional finishes to selected textile materials for use in static-sensitive environments. They are commonly used in the carpet sector.

From a chemical point of view, formulated products are mostly based on:

- quaternary ammonium compounds
- phosphoric acid ester derivatives.

Quaternary ammonium compounds are highly toxic to aquatic life. Furthermore, the discharge of these substances in waste water can give rise to high levels of AOX due to incomplete quaternisation (epichlorohydrin and chloromethane are often used as initial reagents).

Alkylphosphates and alkyl ether phosphates used as antistatic agents are water-soluble, hard-to-treat substances which may pass undegraded through common waste water systems. Nevertheless the use of phosphoric acid esters in antistatic finishing treatment leads to emissions loads that are negligible if compared with other potential sources of this pollutant. According to [77, EURATEX, 2000], in fact, the pollution load released during pretreatment and attributable to antistatics from preparation agents is more than 100 times higher compared to the amount of antistatics discharged in waste water from antistatic finishing treatments.

On the other hand, for air emissions, the use of phosphoric esters-based antistatics may lead to the release of non-reacted alcohols (mostly n-butanol, which is very odour intensive) and phosphoric acid (corrosive).

8.8.4 Flame-retardants

When speaking about flame-retardant finishing it is useful to differentiate between durable and non-durable treatments. Durable flame-retardants react with the fibre, thereby providing permanent fire retardancy properties to the treated product. This is not the case with non-durable retardants, which although effective, are removed by laundering and are thus suitable only for fabrics which are seldom or never laundered or which can be re-treated whenever laundering is carried out.

Flame retardant (FR) agents function by different mechanisms depending on their chemical characteristics. The most commonly used FR agents in the textile sector belong to the following chemical classes:

- inorganic compounds
- halogenated organic compounds
- organo-phosphorus compounds.

Inorganic FR agents

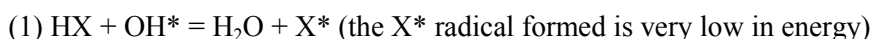
Inorganic FR agents, used for cellulosic fibres, are water-soluble salts such as diammonium phosphate, aluminum sulphate, ammonium sulphate, etc. They are applied from aqueous solution by padding or spraying followed by drying. They are non-durable retardants, which means that they render the product flame retardant until it is laundered or otherwise exposed to water.

Other types of inorganic FR agents are used in the wool carpet sector. Although wool may be generally regarded as resistant to burning, the introduction of stringent flammability standards for floorcoverings fitted in aircraft and public service buildings necessitates the use of FR agents in some specific cases. Zirconium and titanium salts have been developed to meet the needs of this specialised market. Zirconium salts, commonly referred to as "Zirpro treatments", are the most widely used (potassium hexafluorozirconate). They do not give rise to significant water pollution. However, emissions of zirconium- and fluorine-containing compounds along with fairly high water consumption levels (four rinsing-baths are needed with the conventional IWS procedure) should be taken into account [281, Belgium, 2002].

Aluminum hydroxide ($\text{Al}_2\text{O}_3 \cdot 3\text{H}_2\text{O}$) is another flame-retardant widely used in the carpet sector. It is commonly added to the foam coating of the carpet, partially replacing CaCO_3 (inactive filler). Aluminum hydroxide starts to break down at 180 to 200°C, the conversion to aluminium oxide taking place in an endothermic reaction. Aluminum hydroxide treatments do not pose significant environmental concerns.

Halogenated FR agents

Halogenated flame-retardants react in the gas phase by free-radical inhibition. The hydrogen and hydroxyl free radicals formed during the combustion process are high in energy and give rise to highly exothermic chain radical reactions (flame propagation). Halogenated flame-retardants are capable of interrupting this radical reaction. The halogen deactivates the free radical in the vapour phase according to the reaction (1):



The effectiveness of halogen-containing flame-retardants increases in the order $\text{F} < \text{Cl} < \text{Br} < \text{I}$. However, only brominated and chlorinated compounds are used in practice. Fluorine and iodine based flame retardants are not used because neither of them interfere with the combustion process at the right point (the bond between the halogen atom and carbon is too strong for fluorine, and too loose for iodine).

Brominated compounds are the most effective ones. Bromine can be bound aliphatically or aromatically; the aromatic derivatives are widely used because of their high thermal stability.

Chlorinated flame-retardants include chlorinated aliphatic and cycloaliphatic compounds. Chlorinated flame-retardants are less expensive than the brominated homologues, but higher amounts of active substance are required in order to achieve an equivalent performance. Chlorinated compounds are thermally less stable and more corrosive to the equipment compared to the brominated forms.

Compounds in which *antimony trioxide* (Sb_2O_3) is used together with halogens represent another group of halogen-containing FR. Antimony trioxide is almost totally ineffective if used on its own. However, it shows a good synergistic effect with halogens, particularly chlorine and bromine. Antimony trioxide acts as a radical interceptor and with HBr forms a dense white smoke (SbBr_3) that snuffs the flame by excluding oxygen from the front of the flame [303, Ullmann's, 2001]. Decabromodiphenyl ether, hexabromocyclodecane and chloroparaffins are typically used as synergistic agents.

Halogenated flame-retardants have come under intense environmental scrutiny in recent years. Their properties and their effects on the environment vary depending on the different type of chemicals used.

Polybrominated flame-retardants include the following compounds:

- polybrominated diphenyl ethers (PBDE, sometimes also referred to as PBBE)
 - pentabromodiphenyl ether (penta-BDE)
 - octabromodiphenyl ether (octa-BDE)
 - decabromodiphenyl ether (deca-BDE)
- polybromo biphenyls (PBB)
 - decabromobiphenyl
- tetrabromobisphenol A (TBBA)

Polybrominated FR used for textiles applications are almost mainly diphenyl ethers. Commercially available, technical grade PBDE, are mixtures and contain molecules with different numbers of bromine atoms. For example, technical grade octabromodiphenyl ether contains penta-BDE in low concentrations and hepta-BDE.

Penta-BDE is a persistent substance liable to bioaccumulate. The risk assessment, which has been carried out under Council Regulation (EEC) 793/93 on the evaluation and control of the risks of existing substances, identified a need for specific measures for reducing risks of penta-BDE to the environment.

As a consequence of this risk assessment there is already EU agreement for a ban on penta-BDE, which is confirmed by the inclusion of this chemical under the “Priority Hazardous Substances” targeted for priority regulatory action under the Water Framework Directive 2000/60/EC.

Penta-BDE is not reported as being used in the textiles sector. There are suspicions that deca-BDE, the major PBDE for textile applications, and octa-BDE could break down to penta-BDE and tetra-BDE after release into the environment. This theory is the subject of the EU risk assessment and OSPAR Working Groups. A ban covering deca-BDE and octa-BDE is being considered following the conclusions of the official EU risk assessments for these compounds. Deca-BDE should be prohibited from 1 January [299, Environment Daily 1054, 2001]. At Member States level, countries such as Sweden, the Netherlands and Norway are already taking actions to implement wide-ranging marketing restrictions covering the octa and deca forms of BDE, as an application of the precautionary principle.

As for chlorinated flame-retardants, short chain- (SCCP C10-13) and medium chain chlorinated paraffins (MCCP C14-17) have been the object of a risk assessment under the Council Regulation 793/93/EEC. SCCP and MCCP are acutely toxic for aquatic life. For SCCP long-term toxicity is observed in algae, fish and mussels. Medium-chain chlorinated paraffins are toxic to *Daphnia*, whereas no toxicity has been observed in the available experiments with fish, other invertebrates or algae. For both classes of compounds the hormonal effects seen in animals are considered unlikely to be relevant to humans [301, CIA, 2002]. No studies have been carried out on long-chain chlorinated paraffins.

Short-chain chloroparaffins (C₁₀₋₁₃) have been identified as “Priority Hazardous Substances” targeted for priority regulatory action under the Water Framework Directive 2000/60/EC. Moreover, both SCCP and MCCP are included on the List of Substances for Priority Action set under the OSPAR Convention.

Discharges of halogenated FR into waste water from textile finishing operations may come from excess liquor dumps, end-of-run bath drops and draining of washing water.

Deca-BDE is poorly water-soluble and should be largely retained by the sludge in the waste water treatment system. Chlorinated paraffins are also potentially bioeliminable by adsorption to the sludge (93 % removal from water during waste water treatment has been reported) [301, CIA, 2002]. However, since the amount/load of active substance applied on the fabric is typically in the order of 20 – 30 % w/w, the amount of FR not retained by the sludge and therefore potentially released into the environment may be significant. Process design and operation should avoid the discharge of concentrated liquors to waste water, minimise losses to the effluent, and ensure that adsorption to the sludge is effective in the waste water treatment plant.

Furthermore, special care should be taken for the disposal of the sludge and solid waste containing these halogenated compounds. All halogenated FR (less for aliphatic derivatives), are involved in the formation of dioxins and furans when submitted to high temperature treatments. Dioxins and furans can be formed in small amounts during the synthesis of these compounds and as a side reaction when they are subjected to combustion/ burnt for disposal [302, VITO, 2002]. Incineration should therefore only be carried out in properly constituted incinerators, running at consistently optimal conditions.

For the widely used antimony-organo-halogen FR systems, in addition to the considerations reported above for brominated and chlorinated compounds, dust emissions of Sb₂O₃

(carcinogenic) from dried pastes and mechanical treatment (cutting, etc.) on finished fabrics also need to be taken into account.

Phosphor-organic FR agents

Phosphorus-based flame retardants can be active in the vapour phase or in the condensed phase. Phosphine oxides and phosphate esters are thought to act in the vapour phase through the formation of PO* radicals, which terminates the highly active flame propagating radicals (OH* and H*). The condensed phase mechanism arises as a consequence of the thermal generation of phosphoric acids from the flame retardant, e.g. phosphoric acid or polyphosphoric acid. These acids act as dehydrating agents on the polymer (they decompose to form water vapour and phosphorus oxides which then react with the polymer matrix and dehydrate it, reforming phosphoric acids). The fire retardancy effect is produced via the alteration of the thermal degradation of the polymer and the formation of a very high melting point char at the interface of the polymer and the heat source [303, Ullmann's, 2001].

Organo-phosphorus compounds used in textile applications, particularly for cotton, are available as reactive (durable) and non-reactive (non-durable) systems.

There are two principle chemical types of *reactive phosphor-organic* FR agents. Both of them are halogen-free formulations.

One type (fibre-reactive systems) is widely commercialised under trade names as Pyrovatex® and Spolapret®. The phosphor-organic compound is represented by the molecule: phosphonic acid, (2-((hydroxymethyl)carbonyl)ethyl)-dimethyl ester.

The FR is applied to cotton via the pad-dry-bake technique in combination with a melamine resin, a fabric softener and phosphoric acid. After padding, the fabric is dried and cured thermally to achieve fixation. No ammonia is used in curing. Because of the presence of melamine resins as cross-linking agents, formaldehyde and methanol are evolved as off-gases (emissions are normally abated via scrubbers). Following the curing process, the fabric is washed off, resulting in some unreacted P-containing reagents being discharged to the waste water. These compounds are non-readily biodegradable and water-soluble (they are not bioeliminated by adsorption on the sludge). According to one source, this product is not toxic or harmful to aquatic organisms and shows no potential to bioaccumulate [301, CIA, 2002]. Another source concludes that too little is known about the toxicology of the compound for a health risk assessment to be made. The same source states that no summaries of the environmental toxicity and fate have been identified [304, Danish EPA, Lokke et al., 1999].

Residual finishing liquors and rinse water containing phosphor-organic flame retardant of this type should be collected and not mixed with the other effluent in the waste water treatment system [200, Sweden, 2001].

With the other type of reactive phosphor-organic FR (self-reactive systems), the fabric is impregnated with phosphonium salt and urea precondensates. The subsequent drying process step does not require complete drying. Processing temperatures are therefore low (between 60 and 100°C). After drying, the fabric is treated with ammonia to produce an insoluble polymer within the fibres. The fabric is subsequently oxidised with hydrogen peroxide and washed. In this process there is no curing treatment other than the treatment with ammonia.

The levels of formaldehyde evolved during drying are reported to be within the OEL limits for worker exposure over an eight hour period and maximum concentration limits over a fifteen minute reference period [301, CIA, 2002]. According to the same source, limits set for atmospheric emission of formaldehyde (20 mg/m³) are achieved at the majority of finishing sites without the need to install a scrubber.

No methanol is present in the emissions and no melamine resins or cross-linking agents are used in the process.

Phosphonium salt and urea precondensates have been shown to have levels of fixation of 95 % or higher [301, CIA, 2002]. However, since washing is necessary with these flame-retardants to remove unreacted agents and by-products, some residual phosphorous organic compounds end up in the waste water treatment plant. These compounds are non-readily biodegradable and because of their water-solubility they may pass undegraded through the waste water treatment system.

Concentrated padding liquors and rinse water containing phosphor-organic flame retardants of this type should be collected and not discharged with the other effluents in the waste water treatment [200, Sweden, 2001].

According to FR manufacturers, the phosphorous compounds from these treatments do not have the capability to bioaccumulate. It is also stated that the effluent can be converted to an inorganic phosphorous effluent [301, CIA, 2002]. In this way phosphorous can be removed as phosphate, which would prevent the release of organo-phosphorous compounds into the environment.

Non-durable phosphor-organic flame-retardants do not react with the fibre. It has been reported that some of them release organic volatile compounds like glycols, alcohols, glycolether or parts of the active substances [77, EURATEX, 2000]. This information is contradicted by EFRA and CIA FR manufacturers who state that non-durable flame-retardants of this chemical classification produced by EFRA and CIA member companies do not release any of the above-mentioned compounds [301, CIA, 2002].

As articles treated with *non-durable phosphor-organic* flame-retardants are not washed after the finishing treatment (and also as the final product is rarely washed), this results in a minimisation of any release of P-containing reagents to waste water [301, CIA, 2002].

8.8.5 Hydrophobic/ Oleophobic agents

The most commonly applied commercial formulations fall under the following categories:

- wax-based repellents (paraffin -metal salt formulations)
- resin-based repellents (fatty modified melamine resins)
- silicone repellents
- fluorochemical repellents.

Wax-based repellents

These formulations consist of ca. 25 % of a paraffin and 5 – 10 % of zirconium-, aluminium-based salts. They are usually applied to natural and synthetic fibres by padding and drying without curing. The discharge of residual liquors leads to emissions of metals. Concentrations can be high in some cases. However, from a global point of view the amounts discharged can be considered negligible compared to emissions of metals from dyeing and printing.

Moreover metals like Zr and Al should not be confused with more hazardous metals such as Cu, Ni, Co, Cr used in dyeing processes (note that Zr is also used in the “Zirpo process” in carpets – see Section 8.8.4) [281, Belgium, 2002].

Concerning exhaust air emissions, the presence of paraffin waxes may produce fumes and high levels of volatile organic carbon during heat treatments.

Resin-based repellents

Resin-based repellents (mainly applied as “extenders”) are produced by condensing fatty compounds (acids, alcohols or amines) with methylolated melamines. Formulations often also contain paraffin wax. They are applied by the pad-dry-cure process, often together with cross-linking agents in the presence of a catalyst.

Depending on the degree of completeness of the cross-linking reaction and on the temperature employed in heat treatments, different levels of formaldehyde and aliphatic alcohols are found in the exhaust air. The presence of paraffin wax contributes to increased levels of volatile organic carbon in the emissions.

Silicone repellents

These products are generally supplied as aqueous emulsions consisting of polysiloxane-active substances (dimethylpolysiloxane and modified derivatives), emulsifiers, hydrotropic agents (glycols) and water.

In the case of modified polysiloxanes with reactive functional groups, and depending on the drying and curing conditions, cyclic dimethylsiloxanes can be released in the exhaust air.

Fluorochemical repellents

The success of these agents, despite their high cost compared to other types of water repellents, is especially due to the fact that they are permanent and they provide both oil and water repellency.

Commercial fluorochemical repellents are mostly copolymers of fluoroalkyl acrylates and methacrylates. Marketed formulations contain the active agent together with emulsifiers (ethoxylated fatty alcohols and acids, but also fatty amines and alkylphenols) and other by-products which are often solvents such as:

- acetic acid esters (e.g. butyl/ethyl acetate)
- ketones (e.g. methylethyl ketone and methylisobutyl ketone)
- diols (e.g. ethandiol, propandiol)
- glycolethers (e.g. dipropylenglycol).

Fluorochemical repellents are usually applied in combination with other finishing auxiliaries by a pad-dry-cure process. In many cases they are applied with “extenders” which can be other repellents themselves (e.g. melamine resins repellents or polyisocyanates). The use of these “extenders” allows a reduction in the required amount of fluorochemical, with a corresponding reduction in costs for this treatment.

Finishing treatments with fluorochemical repellents produce emissions of volatile organic compounds in exhaust air. These emissions are attributable to:

- the solvents contained in the formulations (as regards ketones, esters, alcohols, diols)
- the “extenders”, which under high-temperature conditions give rise to cracked by-products such as alcohols and ketones, but also oximes and in particular butanoxime (which is carcinogenic)
- the organo-fluoro components which also release cracked fluor-organic by-products.

As regards water pollution, it has to be taken into account that polysiloxanes, melamine and fluorocarbon resins are all characterised by poor biodegradability and bio-eliminability.

8.8.6 Softeners

This group of chemicals is designed for hand modification of fabric. Softeners reduce the fibre/fibre friction, an effect which hand-feel describes as “soft or smooth”.

Quite often softeners are used together with resins and/or optical brighteners in sometimes complex finishing recipes.

Fabric softeners are water-based emulsions or dispersions of water-insoluble active materials such as:

- non-ionic surfactants
- cationic surfactants
- paraffin and polyethylene waxes
- organo-modified silicones.

Note that phthalates are plasticisers for e.g. PVC, but never textile softeners [195, Germany, 2001].

The formulation of the above-mentioned ingredients often requires additives such as emulsifiers and compatibilisers (e.g. glycols). Problematic APEO emulsifiers are no longer used by European producers.

As for surfactant-type softeners the trend is towards mainly non-ionic and cationic compounds.

Non-ionic softeners do not have substantivity for the fibres and are as wash-fast as the cationics. In spite of this, their usage is increasing as the volume of textiles with more permanence and increased wrinkle resistance is growing. Non-ionic surfactants such as fatty acids, fatty esters and fatty amides belong to this group.

Because of their substantivity, cationic softeners produce a more permanent softening effect than non-ionic compounds. Furthermore, they are more effective at much lower concentrations. Their substantivity for synthetic hydrophobic fibres is limited, increasing in the order: polyester, polyamide, acetate, cotton, viscose and wool. Some disadvantages of cationic agents are their lack of compatibility with anionic compounds typically employed as detergents and soaps, etc. As such, cationic softeners are applied after the complete removal of anionic detergents from the fabric [298, Dyechem Pharma, 2001].

Cationics used as softeners are [298, Dyechem Pharma, 2001]:

- quaternary ammonium compounds such as stearyl or distearyl dimethyl ammonium chloride
- amido amines formed by reaction of a fatty acid or a glyceride and a substituted or unsubstituted short chain polyamine (e.g. diethylene triamine, N, N-diethyl ethylenediamine). The amide thus formed is quaternised with acetic acid or hydrochloric acid to give the cationic softener (especially used for chlorinated wool)
- imidazolines which can be acetylated or reacted with ethylene oxide.

Polyethylene wax emulsions are widely used for towelling, where a good “bunch” hand is required, rather than in applications such as dress apparel. Among the advantages, it is worth mentioning their compatibility with cationic, non-ionic and anionic softeners [298, Dyechem Pharma, 2001].

Silicone softeners, used as emulsions or additives to other softeners, are increasing in importance. They have good effectiveness and besides softening they impart to the fabric additional properties such as water repellency.

Softeners are mostly applied by forced application (padding, spraying) from relatively concentrated solutions, which transfers all of the liquor onto the fabric [195, Germany, 2001].

In batch processing softeners are often applied by exhaustion from diluted baths on machines such as jet, overflow or winch. Here the exhaustion rate is relevant to ecological considerations of waste water loads. Machine technology with extremely short liquor ratios and skilled formulation of products help to minimise losses of active material [195, Germany, 2001].

If softeners enter the waste water, their behaviour in biological waste water treatment has to be taken into account.

Fatty derivatives generally are highly biodegradable. Cationic softeners are known to be toxic to aquatic life. Silicones and waxes are partially removed from the waste water by adsorption onto the sludge, after the stabilising emulsifiers have been degraded.

As the active ingredients of softener formulations are chemicals with high molecular weight (even polymers), the volatility is low. Volatile by-products of silicones (cyclics) are stripped before the production of the softener. Some waxes or fatty ingredients, however, may have some sensitivity towards cracking, if stenter temperatures are too high [195, Germany, 2001].

8.9 Coating compounds and auxiliaries

According to their chemical composition, coating agents can be classified as follows [179, UBA, 2001].

Coating powders

They can be based on polyolefins (especially polyethylene), polyamide 6, polyamide 6.6, copolyamides, polyester, polyurethane, polyvinylchloride, polytetrafluoroethylene.

Coating pastes

They are based on the chemicals mentioned above, but they also contain additives such as:

- dispersing agents (surfactants, often alkylphenolethoxylates)
- solubilising agents (glycols, N-methylpyrrolidone, hydrocarbons)
- foaming agents (mineral oils, fatty acids, fatty acid ammonia salts)
- softeners (especially phthalates, sulphonamides)
- thickeners (polyacrylates)
- ammonia.

Polymer dispersions (aqueous formulations)

They contain approximately 50 % water and are based on:

- poly(meth)acrylate (butyl, ethyl, methyl etc.)
- polyacrylic acid
- polyacrylonitrile
- polyacryloamide
- 1,3-polybutadiene
- polystyrene
- polyurethane
- polyvinylchloride
- polyvinylacetate
- and copolymeres of the above-mentioned polymers.

Additives are also present, as they are in coating pastes.

Melamine resins

They are produced by reaction of melamine and formaldehyde and subsequent etherification mainly with methanol in aqueous medium (water content 50 – 70 %).

Polymers dispersions (organic solvent-based formulations)

They are based on polyurethane and silicones dispersed in organic solvent.

9 ANNEX II DYES AND PIGMENTS

Textile dyes can be classified according to their chemical composition (azo, anthraquinone, sulphur, triphenylmethane, indigoid, phtalocyanine, etc.) or according to their application class. At the industrial level the second method is preferred.

9.1 Acid dyes

Applicability

Acid dyes are mainly applied to polyamide (70 – 75 %) and wool (25 – 30 %). They are also used for silk and some modified acrylic fibres. Acid dyes exhibit little affinity for cellulose and polyester fibre.

Properties

Colours are generally bright and fastness to light and washing range from poor to excellent, depending on the chemical structure of the dyestuff.

Chemical characteristics and general application conditions

Acid dyes are azo (the largest group), anthraquinone, triphenylmethane, Cu phthalocyanine chromophoric systems which are made water-soluble by the introduction in the molecule of up to four sulphonate groups.

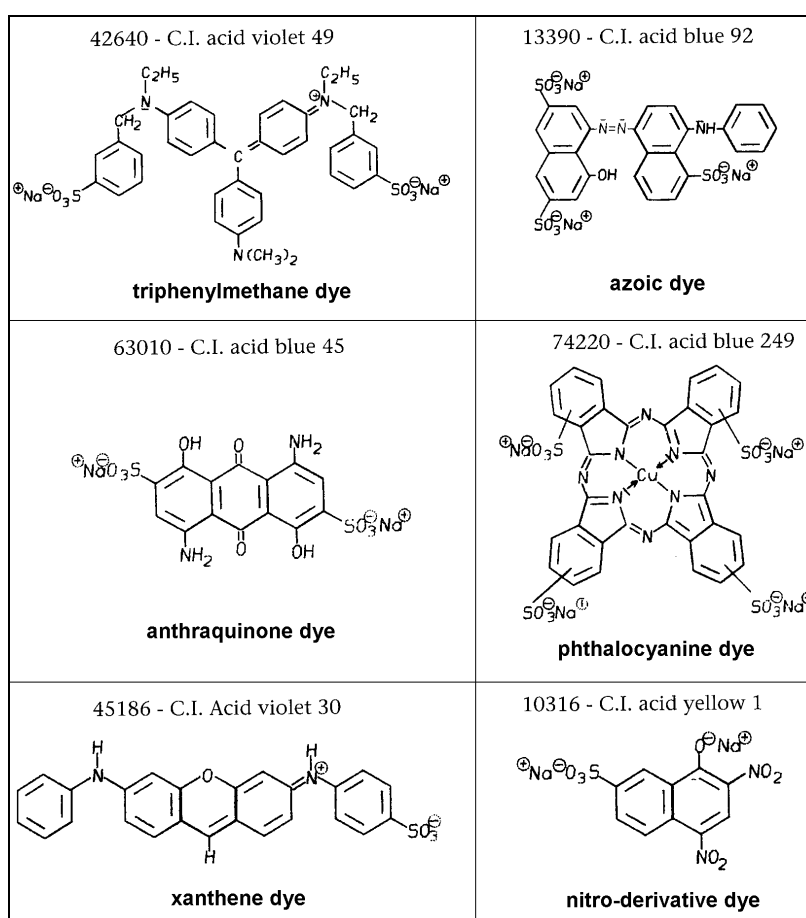
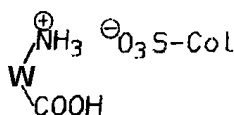
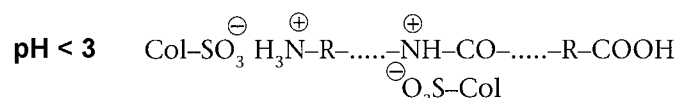
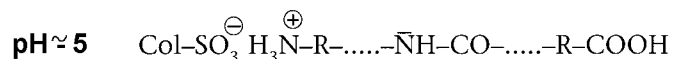


Figure 9.1: Examples of acid dyes

Their interaction with the fibre is based partly on ionic bonds between sulphonate anions and the ammonium groups of the fibre, as shown below for wool



and for polyamide, at different pH conditions.



Moreover, the fibre/dye interaction is based on secondary bonds such as Van der Waals forces. Secondary bonds are established in particular in the case of higher molecular weight dyes, which form aggregates with high affinity for the fibre.

In use, acid dyes are classified by their dyeing behaviour and wet fastness properties, rather than chemical composition, hence the generic term acid dyes includes several individual dye classes. The arbitrary classification normally adopted, in order of increasing fastness is:

- level-dyeing or equalising acid dyes
- fast acid, half-milling or perspiration-fast dyes
- acid milling dyes
- supermilling dyes.

Level-dyeing or equalising dyes are subdivided into two classes, monosulphonated (mainly for PA) and disulphonated (mainly for wool). Due to their poor affinity for the fibre, they all have very good levelling properties. Their wet fastness is, however, sometimes poor, limiting their use to pale/medium shades.

Fast acid dyes (also known as half-milling dyes or perspiration-fast dyes) are only used for PA. They are generally monosulphonated and exhibit superior fastness properties to level-dyeing acid dyes, while retaining some of the migration properties. The shade range available in this class is not as wide as that of the levelling or milling dyes and they therefore tend only to be used when alternatives would have poorer fastness properties.

Acid milling dyes are so named because they have a degree of fastness to the wet treatments employed when milling (mild felting) woollen fabrics. The class is further subdivided to include supermilling dyes, which have good wet fastness properties, arising from long alkyl side-chains attached to the chromophore. Due to their high molecular weight, milling dyes have a good affinity for the fibre and do not migrate well at the boil. Milling dyes are used mainly for wool for those applications where good wet fastness is required, for example in the dyeing of loose fibre which will receive a further wet treatment during hank scouring.

Depending on the class they belong to, acid dyes are applied under pH conditions that vary from strongly acidic to more neutral ones (3 – 7.5). For low-affinity dyes it is necessary to increase the level of cationisation of the fibre (by acidification) in order to improve dye uptake. Conversely, dyes with higher molecular weight and high affinity would adsorb too rapidly on the fibre if applied under such strongly acidic conditions.

The most common *chemicals and auxiliaries* applied *when dyeing* with acid dyes are:

- sodium sulphate (for level-dyeing and fast acid dyes), sodium acetate and ammonium sulphate (for acid milling dyes)
- pH regulators: acetic, formic and sulphuric acid, but also (typically for PA in the carpet sector) NaOH, NH₃ salts, phosphoric acid salts and higher (hydroxy)carboxylates
- levelling agents, mainly cationic compounds such as ethoxylated fatty amines.

The most common *chemicals and auxiliaries* applied *when printing* with acid dyes are:

- thickening agents
- solubilising agents such as urea, thiourea, thiodiglycol, glycerine
- acid donors: ammonium sulphate, tartrate or oxalate
- defoamers (e.g. silicone oils, organic and inorganic esters) and “printing oils” (mainly mineral oils)
- aftertreatment agents such as formaldehyde condensates with aromatic sulphonic acids.

Environmental issues

The environmental properties of acid dyes are assessed under the following parameters. Note, however, that the following table does not consider the environmental issues related to chemicals and auxiliaries employed in the dyeing process.

Parameters of concern	Comments
Bio-eliminability	
Organic halogens (AOX)	
Eco-toxicity	Acid dyes are in general not toxic. However, two dyes (Acid orange 156 and Acid orange 165) have been classified as <i>toxic</i> by ETAD. Acid Violet 17(triphenylmethane dye) is reported to have an <i>allergenic effect</i>
Heavy metals	
Aromatic amines	
Unfixed colourant	Degrees of fixation in batch dyeing are found to be in the range of 85 - 93 % for monosulphonated dyes and in the range of 85 - 98 % for di- and tri-sulphonated dyes
Effluent contamination by additives in the dye formulation	

Table 9.1: Overview of the ecological properties of acid dyes

9.2 Basic (cationic) dyes

Applicability

Basic dyes were initially used to dye silk and wool (using a mordant), but they exhibited poor fastness properties. Nowadays these dyestuffs are almost exclusively used on acrylic fibres, modified polyamide fibres, and blends.

Properties

On acrylic fibres fastness performances are excellent.

Chemical characteristics and general application conditions

Cationic dyes contain a quaternary amino group which can be an integral part (more common) or not of the conjugated system. Sometimes a positively-charged atom of oxygen or sulphur can be found instead of nitrogen.

Ionic bonds are formed between the cation in the dye and the anionic site on the fibre.

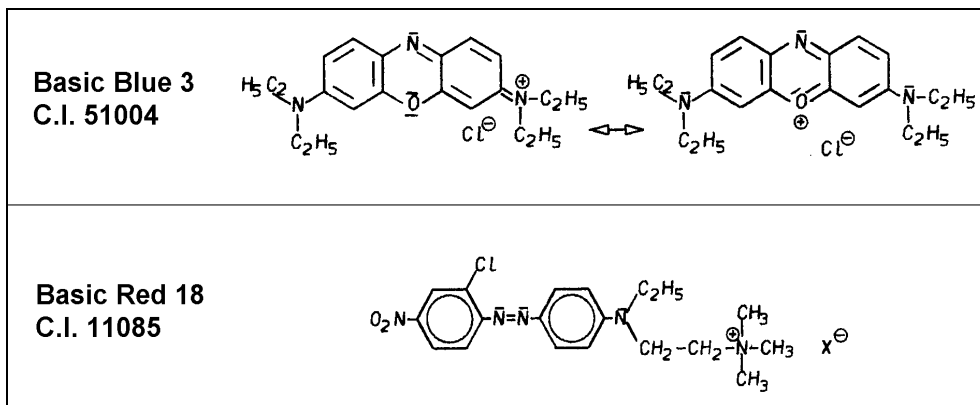


Figure 9.2: Examples of typical basic dyes

Cationic dyes are slightly soluble in water, while they show higher solubility in acetic acid, ethanol, ether and other organic solvents. In dyeing processes, they are applied in weak acid conditions. Basic dyes are strongly bound to the fibre and do not migrate easily. In order to achieve level dyeing, specific levelling auxiliaries, (also called retarders) are normally employed (unless a pH controlled absorption process is used). The most important group of retarders is represented by quaternary ammonium compounds with long alkyl side-chains (cationic retarders). Electrolytes and anionic condensation products between formaldehyde and naphthalenesulphonic acid may also be found.

Environmental issues

Many basic dyes exhibit high aquatic toxicity but, when applied properly, they show fixation degrees close to 100 %. Problems are more often attributable to improper handling procedures, spill clean-up and other upsets [11, US EPA, 1995].

The following dyestuffs have been classified as toxic by ETAD:

- Basic Blue 3, 7, 81
- Basic Red 12
- Basic Violet 16
- Basic Yellow 21.

9.3 Direct (substantive) dyes

Applicability

Direct dyes are used for dyeing cotton, rayon, linen, jute, silk and polyamide fibres.

Properties

Colours are bright and deep, but light-fastness can vary greatly depending on the dyestuff. Wash-fastness properties are also limited unless the textile is after-treated. Only occasionally are direct dyes used in direct printing processes.

Chemical characteristics and general application conditions

Direct dyes (also called substantive dyes) can be azo compounds, stilbenes, oxazines, or phtalocyanines. They always contain solubilising groups (mainly sulphonic acid groups, but carboxylic and hydroxyl groups can also be found) that ionise in aqueous solution.

Direct dyes are characterised by long planar molecular structures that allow these molecules to align with the flat cellulose macromolecules, the dye molecules being held in place mainly through Van der Waals forces and hydrogen bonds.

Direct dyes may require the use of the following *chemicals and auxiliaries* for satisfactory dyeing:

- electrolytes, usually sodium chloride or sodium sulphate. Their function is to favour the aggregation of dye ions on the fibre
- wetting and dispersing agents: mixtures of non-ionic and anionic surfactants are used for this aim
- aftertreatment agents: they are used to improve wet-fastness properties. So-called fixative cationic agents are the most commonly used. They are usually quaternary ammonium compounds with long hydrocarbon chains. Formaldehyde condensation products with amines, polynuclear aromatic phenols, cyanamide or dicyandiamide may also be used for this purpose.

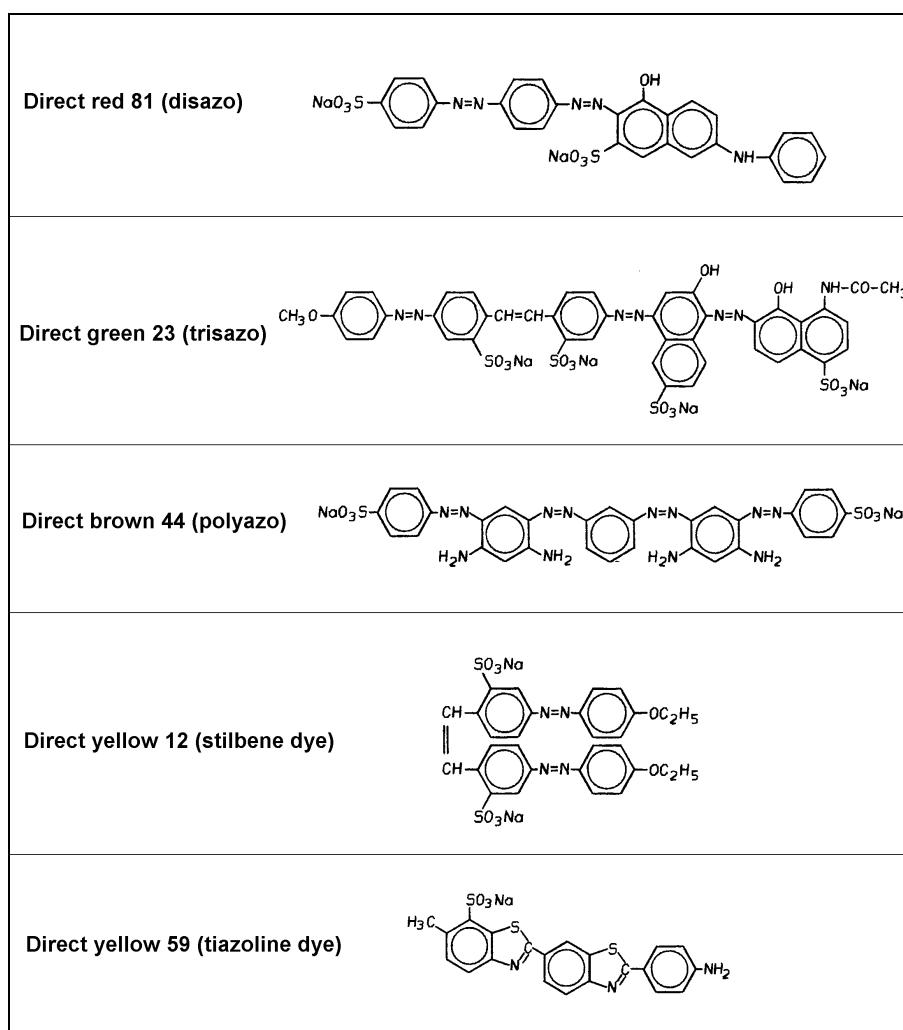


Figure 9.3: Examples of typical direct dyes

Environmental issues

The environmental properties of direct dyes are assessed under the following parameters. Note, however, that Table 9.2 does not consider the environmental issues related to chemicals and auxiliaries employed in the dyeing process because these issues are dealt with in a specific annex.

Parameters of concern	Comments
Bio-eliminability	
Organic halogens (AOX)	
Eco-toxicity	Direct Orange 62 has been classified as toxic by ETAD
Heavy metals	
Aromatic amines	The main emphasis of research for direct dyes was actually on the replacement of possibly carcinogenic benzidine dyes [186, Ullmann's, 2000]
Unfixed colourant	Degree of fixation in batch dyeing processes ranges from 64 - 96 % [77, EURATEX, 2000] (70 - 95 % according to [11, US EPA, 1995])
Effluent contamination by additives in the dye formulation	

Table 9.2: Overview of the ecological properties of direct dyes

9.4 Disperse dyes

Applicability

Disperse dyes are used mainly for polyester, but also for cellulose (acetate and triacetate), polyamide and acrylic fibres.

Properties

Fastness to light is generally quite good, while fastness to washing is highly dependent on the fibre. In particular, in polyamides and acrylics they are used mostly for pastel shades because in dark shades they have limited build-up properties and poor wash fastness.

Chemical characteristics and general application conditions

Disperse dyes are characterised by the absence of solubilising groups and low molecular weight. From a chemical point of view more than 50 % of disperse dyes are simple azo compounds, about 25 % are anthraquinones and the rest are methine, nitro and naphthoquinone dyes.

The dye-fibre affinity is the result of different types of interactions:

- hydrogen bonds
- dipole-dipole interactions
- Van der Waals forces.

Disperse dyes have hydrogen atoms in their molecule, which are capable of forming hydrogen bonds with oxygen and nitrogen atoms on the fibre.

Dipole-dipole interactions result from the asymmetrical structure of the dye molecules, which makes possible electrostatic interactions between dipoles on the dye molecules and polarised bonds on the fibre.

Van der Waals forces take effect when the molecules of the fibre and colourant are aligned and close to each other. These forces are very important in polyester fibres because they can take effect between the aromatic groups of the fibre and those of the colourant.

Disperse dyes are supplied as powder and liquid products. Powder dyes contain 40 – 60 % of dispersing agents, while in liquid formulations the content of these substances is in the range of 10 – 30 %. Formaldehyde condensation products and ligninsulphonates are widely used for this purpose.

Dyeing with disperse dyes may require the use of the following chemicals and auxiliaries:

- dispersants: although all disperse dyes already have a high content of dispersants, they are further added to the dyeing liquor and in the final washing step
- carriers: for some fibres, dyeing with disperse dyes at temperatures below 100 °C requires the use of carriers. This is the case with polyester, which needs the assistance of carriers to enable an even penetration of disperse dyes below boiling temperature. Because of environmental problems associated with the use of these substances, polyester is preferably dyed under pressure at temperature >100 °C without carriers. However, carrier dyeing is still important for polyester-wool blends, as wool must not be submitted to wet treatment at temperatures significantly above 100 °C
- thickeners: polyacrylates or alginates are usually added to the dye liquor in padding processes. Their function is to prevent migration of the dye liquor on the surface during drying
- reducing agents (mainly sodium hydrosulphite): they are added in solution with alkali in the final washing step.

Disperse dyes are widely used not only for dyeing, but also for printing synthetic fibres.

Environmental issues

The environmental properties of disperse dyes are assessed under the following parameters. Note, however, that Table 9.3 does not consider the environmental issues related to chemicals and auxiliaries employed in the dyeing process because these issues are dealt with in a specific annex.

Parameters of concern	Comments
Bio-eliminability	Owing to their low water-solubility, they are largely eliminated by absorption on activated sludge in the waste water treatment plant
Organic halogens (AOX)	Some disperse dyes can contain organic halogens, but they are not expected to be found in the effluent after waste water treatment (because they are easily eliminated by absorption on the activated sludge) (see also Section 2.7.8.1)
Toxicology	The following disperse dyes potentially have an allergenic effect: Disperse Red 1, 11, 17, 15; Disperse Blue 1, 3, 7, 26, 35, 102, 124; Disperse Orange 1, 3, 76; Disperse Yellow 1, 9, 39, 49, 54, 64.
Heavy metals	
Aromatic amines	These dyes are still offered by some Far East dealers and manufacturers [294, ETAD, 2001]
Unfixed colourant	Level of fixation is in the range of 88 - 99 % for continuous dyeing and 91 - 99 % for printing
Effluent contamination by additives in the dye formulation	Conventional dispersants (formaldehyde condensation compounds, lignosulphonates, etc.) are poorly biodegradable (<30 % according to [186, Ullmann's, 2000], ca. 15 % according to [18, VITO, 1998]). Some dyes are formulated with more readily eliminable dispersants (albeit not suitable for all formulations). More information is reported in Section 4.6.3

Table 9.3: Overview of the ecological properties of disperse dyes

9.5 Metal-complex dyes

Applicability

Metal-complex dyes (also called pre-metallised dyes) have great affinity for protein fibres. Among metal-complex dyes, 1:2 metal-complex dyes are also suitable for polyamide fibres.

More than 65 % of wool is today dyed with chrome dyes (see next section) or metal-complex dyes and about 30 % of PA is dyed with 1:2 metal-complex dyes.

Properties

Light-fastness is excellent, while washing fastness is not as good as with chrome dyes (particularly in darker shades).

Chemical characteristics and general application conditions

Metal-complex dyes may be broadly divided into two classes, 1:1 metal-complexes, in which one dye molecule is co-ordinated with one metal atom and 1:2 metal complexes, in which one metal atom is co-ordinated with two dye molecules. The dye molecule will be typically a monoazo structure containing additional groups such as hydroxyl, carboxyl or amino groups, which are capable of forming strong co-ordination complexes with transition metal ions,

typically chromium, cobalt, nickel and copper. Note that phthalocyanine dyes cannot be classified as metal-complex dyes.

Typical examples of pre-metallised dyes are shown in Figure 9.4 and Figure 9.5.

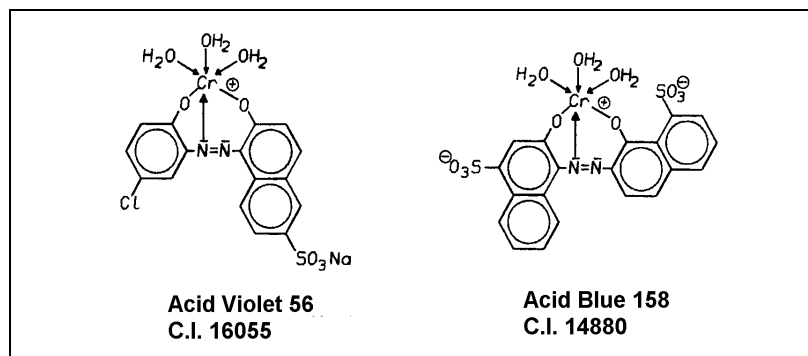


Figure 9.4: Examples of molecular structures typical of 1:1 metal-complex dyes

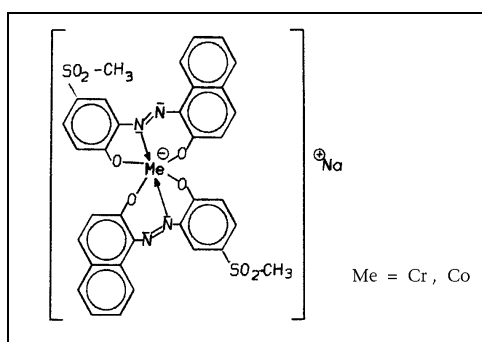


Figure 9.5: Molecular structure typical of 1:2 metal-complex dyes

Metal-complex dyes do not represent a specific application dye class. Metal-complex dyes belong in fact to many application classes of dyes (i.e. they can be found, for example, among acid, direct and reactive dyes). When used in dyeing processes, metal-complex dyes are applied in pH conditions regulated by the user class and the fibre type (wool, polyamide, etc.). The pH levels for wool range from strongly acidic (1.8 - 4 for 1:1 metal-complex dyes) to moderately acidic neutral (4 - 7 for 1:2 metal-complex dyes). For polyamide fibres higher pH conditions are becoming more and more common.

1:1 metal-complex dyes exhibit excellent level dyeing and penetration characteristics and have the ability to cover irregularities in the substrate. Their light and wet fastness properties are good even in deep shades. They are particularly suitable for yarn and for piece dyeing of carbonised wool.

1:2 metal-complex dyes are used for both wool and polyamide. They form the most important group in this class and may be divided into two sub-groups:

- weakly polar 1:2 complexes – solubilised by the inherent anionicity of the complex or containing non-ionic, hydrophilic substituents such as methylsulphone ($-\text{SO}_2\text{CH}_3$). These dyes exhibit excellent fastness to light and wet treatments and excellent penetration properties.
- strongly polar 1:2 complexes – solubilised by one or more sulphonic or carboxylic acid residues, these dyes possess lower levelling power than the weakly polar dyes mentioned above but superior wet fastness properties and are generally suitable for use in those applications where mordant dyes are used. This second group is also more suitable for dyeing polyamide fibres.

Dyeing with metal-complex dyes may require the use of the following *chemicals and auxiliaries*:

- pH regulators: sulphuric, formic, acetic acid
- electrolytes: sodium sulphate, ammonium acetate and sulphate
- levelling agents: mixtures of anionic and non-ionic surfactants (these auxiliaries are not needed when using pH controlled adsorption dyeing techniques).

Environmental issues

The environmental properties of metal-complex dyes are assessed under the following parameters. Note, however, that Table 9.4 does not consider the environmental issues related to chemicals and auxiliaries employed in the dyeing process because these issues are dealt with in a specific annex.

Parameters of concern	Comments
Bio-eliminability	Great differences from dye to dye (bio-eliminability can be <50 %)
Organic halogens (AOX)	Some products contain organic halogens: AOX in waste water, therefore depends on the eliminability of the dyes concerned (see also Section 2.7.8.1)
Eco-toxicity	
Heavy metals	Metals can be found in the effluent due to unfixed dye. However, Cr III and the other transition metals used in metal-complex dyes are an integral part of the chromophore (see also Section 2.7.8.1 "heavy metals")
Aromatic amines	
Unfixed colourant	Degree of fixation ranges from moderate to excellent (from 85 to 98 % and greater in some cases)
Effluent contamination by additives in the dye formulation	Inorganic salts are present in the preparation of powder dyes. These salts, however, do not present any ecological or toxicological problems [64, BASF, 1994]

Table 9.4: Overview of the ecological properties of metal complex dyes

9.6 Mordant dyes (chrome dyes)

Applicability

Mordant dyestuffs are generally used for protein (wool and silk). They are practically no longer used for polyamide fibres or for printing.

Properties

Thanks to their good levelling properties and very good wet fastness after chroming, chrome dyes are used principally to obtain dark shades (greens, blues and blacks) at moderate cost. There are disadvantages, however, in their use: long dyeing times, difficulties with shading, the risk of chemical damage to the fibre during chroming and the potential release of chromium in waste water.

Chemical characteristics and general application conditions

The *Colour Index* classifies these colourants as mordant dyes, but chromium has become the almost universally used mordant and the class is commonly referred to as chrome dyes.

From a chemical point of view they can be regarded as acid dyestuffs that contain suitable functional groups capable of forming metal complexes with chrome. They do not contain chrome in their molecule, which instead is added as dichromate, or chromate salt to allow dye fixation.

Interaction with the fibre is established through ionic bonds formed between the anionic groups of the colourant and ammonium cations available on the fibre. In addition chromium acts as a link between dye and fibre. This gives rise to a very strong bond, which is reflected in the excellent fastness obtained. Figure 9.6 shows the ionic and coordination bonds in the case of wool.

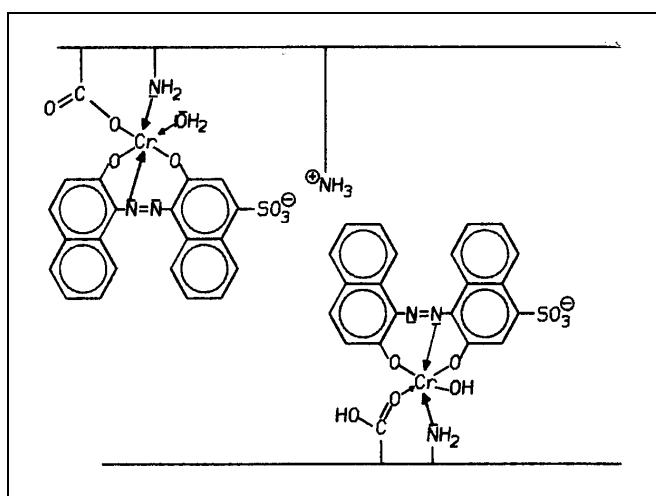


Figure 9.6: Representation of possible ionic and coordination bonds between wool and chrome dyes [69, Corbani, 1994]

The use of chrome dyes in *dyeing* processes requires the use of the following chemicals and auxiliaries:

- potassium and dichromate or chromate
- formic or acetic acid as pH regulators
- other organic acids such as tartaric and lactic acid. They are used to enhance the degree of conversion of Cr VI to Cr III
- sodium or ammonium sulphate.

Environmental issues

The environmental properties of chrome dyes are assessed under the following parameters. Note, however, that Table 9.5 does not consider the environmental issues related to chemicals and auxiliaries employed in the dyeing process because these issues are dealt with in a specific annex.

Parameters of concern	Comments
Bio-eliminability	
Organic halogens (AOX)	
Eco-toxicity	
Heavy metals	Chromium present in the final colourant is <u>not</u> contained in the molecule, being instead added as dichromate, or chromate salt during the dyeing process to allow dye fixation (see also Section 2.7.8.1)
Aromatic amines	
Unfixed colourant	
Effluent contamination by additives in the dye formulation	

Table 9.5: Overview of the ecological properties of chrome dyes

9.7 Naphthol dyes (azoic dyes developed on the fibre)

Applicability

Azoic dyes, also known as naphthol dyes, are used for cellulosic fibres (particularly cotton), but may also be applied to viscose, cellulose acetate, linen and sometimes polyester.

Properties

Azoic dyes have excellent wet fastness properties as well as good light, chlorine and alkali fastness, while rubbing fastness is poor.

Chemical characteristics and general application conditions

From a chemical point of view naphthol dyes are very similar to azo dyes, the main difference being the absence of sulphonic solubilising groups.

They are made up of two chemically reactive compounds that are applied to the fabric in a two-stage process. The insoluble dye is synthesised directly in the fibre as the result of the coupling reaction between a diazotised base (developing agent) and a coupling component.

The coupling components are usually derivatives of the anilides of the 2-hydroxy-3-naphthoic acid (also called naphthol AS). These naphthols are available in powder form or in liquid form (in this case the solution also contains caustic soda, the naphthol concentration ranges between 30 % and 60 %).

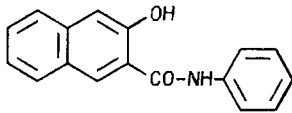
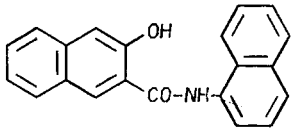
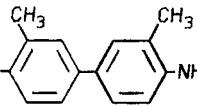
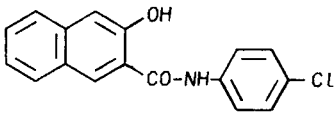
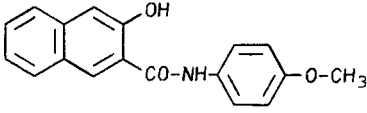
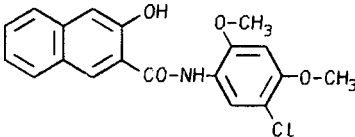
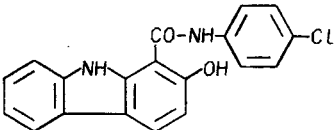
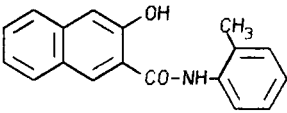
Colour Index III ed.		Formula	Name of the commercial product
Coupling component n°	Chemical composition n°		
2	37505		Naphthol AS (P,L)
4	37560		Naphthol AS-BO (P,L)
5	37610	$CH_3-CO-CH_2-CO-NH$  $-NH-CO-CH_2-CO-CH_3$	Naphthol AS-G (P)
10	37510		Naphthol AS-E (P)
11	37535		Naphthol AS-RL (P)
12	37550		Naphthol AS-ITR (P,L)
15	37600		Naphthol AS-LB (P,L)
18	37520		Naphthol AS-D (P,L)

Figure 9.7: Examples of typical coupling components for naphthol dyes

Developing agents can be derivatives of aniline, toluidine, orto and meta anisidine, diphenyl amine. They are available as:

- free bases (fast colour bases)
- liquid bases (these formulations are aqueous dispersions of the aromatic amines, they are safer and simpler to apply than solid bases)
- fast colour salts (these are already diazotised diazonium compounds that are marketed in stabilised forms and do not need to be diazotised before use in dyeing: some examples are given in the figure below).

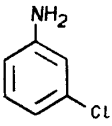
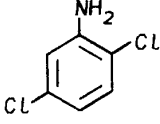
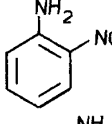
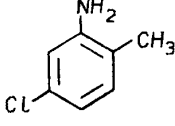
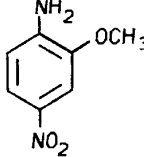
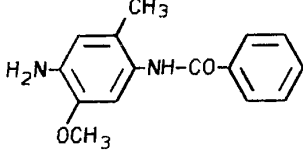
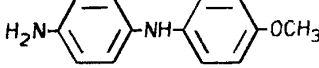
Colour Index		Formula
Diazo component n°	Chemical composition n°	
2	37005	
3	37010	
6	37025	
32	37090	
5	37125	
41	37165	
35	37255	

Figure 9.8: Examples of typical developing agents (fast colour base) for naphthol dyes

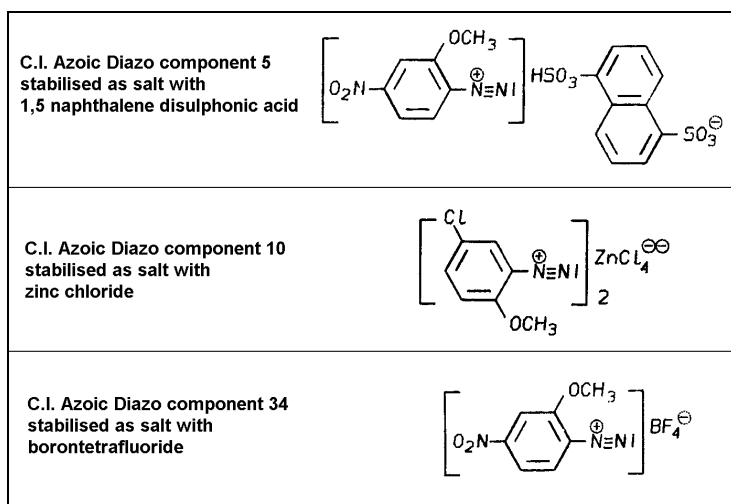


Figure 9.9: Examples of typical fast colour salts

Application of azoic colourants involves a number of steps:

- preparation of the naphtholate solution: naphthol is converted to the naphtholate form to be able to couple with the diazonium salt
- application of the naphtholate to the fibre
- preparation of the diazotised base: in order to make the coupling reaction possible, the base must first be diazotised in the cold, using sodium nitrite and hydrochloric acid (this step can be avoided when using fast colour salts)
- formation of the azoic dye into the fibre.

Environmental issues

The environmental properties of naphthol dyes are assessed under the following parameters. Note, however, that Table 9.6 does not consider the environmental issues related to chemicals and auxiliaries employed in the dyeing process because these issues are dealt with in a specific annex.

Parameters of concern	Comments
Bio-eliminability	
Organic halogens (AOX)	
Eco-toxicity	
Heavy metals	
Aromatic amines	Developing agents are all diazotisable amines or diamines or substituted anilines, toluidines, anisidines, azobenzenes or diphenylamines. Some of these amines and in particular, p-nitroaniline, chloroaniline and β -naphthylamine are on the 1980 US EPA priority list as harmful pollutants and their use is forbidden.
Unfixed colourant	Degree of fixation in continuous dyeing processes ranges between 76 and 89 % and between 80 and 91 % in printing processes [77, EURATEX, 2000]
Effluent contamination by dispersants and additives in the dye	

Table 9.6: Overview of the ecological properties of naphthol dyes

9.8 Reactive dyes

Applicability

Reactive dyes are mainly used for dyeing cellulose fibres such as cotton and viscose, but they are also increasingly gaining importance for wool and polyamide.

Properties

They provide high wet fastness (better than the less expensive direct dyes), but their use is not always viable because of the difficulty in obtaining level dyeing. Chlorine fastness is slightly poorer than that of vat dyes, as is light fastness under severe conditions.

The range of available reactive dyes is wide and enables a large number of dyeing techniques to be used.

Chemical characteristics

Reactive dyes are unique in that they contain specific chemical groups capable of forming covalent links with the textile substrate.

The energy required to break this bond is similar to that required to degrade the substrate itself, thus accounting for the high wet fastness of these dyes.

The structure of Reactive Black 5, one of the most important reactive dyestuffs in terms of volumes consumed, is illustrated in Figure 9.10.

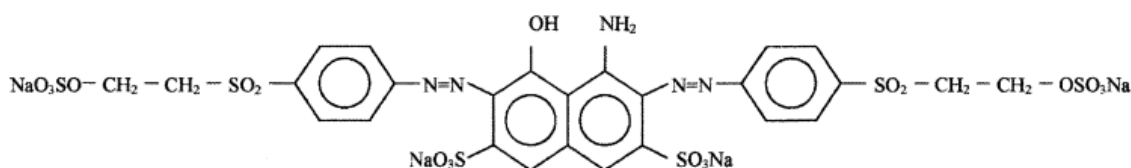


Figure 9.10: Reactive Black 5

Chemical structure of reactive dyes can be schematically represented by the following formula: Col-B-R, where:

- Col is the chromophore that is in general constituted by monoazoic, anthraquinone, phthalocyanine and metal-complex compounds
- B is the linking group between the chromophore and the reactive group
- R represents the reactive group (anchor system with the leaving group). The anchor systems are characterised by their reactivity. Based on this, they are classified as hot, warm or cold dyers.

Some typical examples of reactive systems for cellulose and wool or polyamide fibres are reported in the following tables.

Anchor system	Denomination	Commercial name
	Dichloro-s-triazine (cold dyer)	Procion MX
	Amino-fluoro-s-triazine (warm dyer)	Cibacron F
	Trichloro-pyrimidine (hot dyer)	Cibacron T-E Dimaren X, Z
$-\text{SO}_2-\text{CH}_2-\text{CH}_2-\text{O}-\text{SO}_3\text{Na}$	Beta-sulphate-ethyl-sulphone (warm dyer)	Remazol

Table 9.7: Typical anchor systems for cellulose fibres

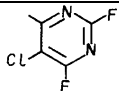
Anchor system	Denomination	Commercial name
	2,4-difluoro 5-chloro pyrimidine	Verofix Drimalan F
$-\text{SO}_2-\text{CH}_2-\text{CH}_2-\text{O}-\text{SO}_3\text{Na}$	Beta-sulphate-ethyl-sulphone	Remazolan
$-\text{SO}_2-\text{NH}-\text{CH}_2-\text{CH}_2-\text{O}-\text{SO}_3\text{H}$	Sulphate-ethyl sulphonamide	Levafix
$-\text{NHCO}-\text{CBr}=\text{CH}_2$	Bromoacrylamide	Lanasol

Table 9.8: Typical anchor systems for wool and polyamide fibres

The reactive groups of the colourant react with the amino groups of the fibre in the case of protein and polyamide fibres, and with the hydroxyl groups in the case of cellulose.

In both cases, depending on the anchor system, two reaction mechanisms are possible: a nucleophilic substitution mechanism or a nucleophilic addition mechanism.

An important issue to consider when dealing with reactive dyes is the fact that two competing reactions are always involved in the colouring process:

1. alcoholysis: dye + fibre \rightarrow dye fixed on the fibre
2. hydrolysis: dye + water \rightarrow hydrolysed dye washed away after dyeing (undesired reaction)

This fact has important consequences, especially in the case of cellulose fibres. In fact, the alkaline conditions in which reactive dyes react with cellulose fibres, increase the rate of the hydrolysis reaction. The characteristics of the resulting hydrolysed dye are such that the dye is no longer a reactive substance and it is therefore discharged in the effluent.

Dyeing cellulose fibres with reactive dyes may imply the use of the following *chemicals* and *auxiliaries*:

- alkali (sodium carbonate, bicarbonate and caustic soda)
- salt (mainly sodium chloride and sulphate)
- urea may be added to the padding liquor in continuous processes in the one-bath method (see also Section 4.6.13 for alternative techniques)
- sodium silicate may be added in the cold pad-batch method (see also Section 4.6.9).

Reactive dyes are applied to wool or polyamide fibres under different conditions. In the case of *wool and polyamide fibres*, reactivity of the amino groups is considerably higher than that of hydroxyl groups in cellulose.

Levelling properties are often achieved with the use of speciality amphoteric levelling agents.

Reactive dyes are generally applied at pH values of between 4.5 and 7, depending on depth of shade, in the presence of ammonium sulphate and the specialised levelling agents mentioned above.

In *cellulose printing*, moderately reactive dyes are generally employed (mainly mochlorotriazine systems). Highly reactive sulphoethyl sulphones are also sometimes used.

Printing with reactive dyes requires the use of:

- thickening agents (mainly polyacrylates in combination with alginates)
- urea
- alkali (e.g. sodium carbonate and bicarbonate)
- oxidising agents (mainly benzenesulphonic acid derivatives): they are used to prevent reduction of more sensitive dyes during steaming.

Environmental issues

Poor dye fixation has been a long-standing problem with reactive dyes in particular in batch dyeing of cellulose fibres, where a significant amount of salt is normally added to improve dye exhaustion (and therefore also dye fixation). On the other hand, shade reproducibility and level dyeing were the major obstacle in “right-first-time” production using the most efficient dyes (high exhaustion and fixation rate).

Research and development has been faced with a number of objectives, all of which have been or are in the process of being successfully achieved. These include [190, VITO, 2001]:

- increasing the robustness of individual dyes and dye combinations (trichromatic systems)
- enhancing reproducibility of trichromatic combinations used in most commonly applied dyeing processes
- reducing salt consumption and/or unused dye in the effluent
- improving fastness properties (e.g. light fastness, fastness to repeated laundering).

With the use of sophisticated molecular engineering techniques it has been possible to design reactive dyes (e.g. bifunctional dyes and low-salt reactive dyes) with considerably higher performances than traditional reactive dyes. These recent developments are described in more detail in Sections 4.6.10, 4.6.11 and 4.6.13.

The environmental properties of reactive dyes are assessed in Table 9.9. Note that the table does not consider the environmental issues related to chemicals (e.g. salt) and auxiliaries employed in the dyeing process because these issues are dealt with in a specific annex.

Parameters of concern	Comments
Bio-eliminability	Because both unfixed reactive dye and its hydrolysed form are readily soluble they are difficult to eliminate in biological waste water treatment plants
Organic halogens (AOX)	Many reactive dyes contain organic halogens. However, a distinction has to be made between halogens bonded to the chromophore and halogens bonded to the anchor group (see Section 2.7.8.1 for more detailed discussion).
Eco-toxicity	
Heavy metals	Heavy metals can be present both as impurities from the production process (limits have been set by ETAD) and as an integral part of the chromophore. The latter concerns phthalocyanine dyes, which are still widely used especially for blue and turquoise shades (substitutes have not yet been found) (see also Section 2.7.8.1)
Aromatic amines	
Unfixed colourant	Fixation rate can be poor ⁽¹⁾ (see also discussion in Section 2.7.8). Efforts have been made to increase the level of fixation. Some reactive dyes can reach >95 % of fixation even for cellulosic fibres (see Sections 4.6.10 and 4.6.11 for recent developments)
Effluent contamination by dispersants and additives already in the dye	
Notes: ⁽¹⁾ [77, EURATEX, 2000] Fixation degree for: <ul style="list-style-type: none"> - cotton batch dyeing: 55 - 80 % - wool batch dyeing: 90 - 97 % - printing (general): 60 % 	

Table 9.9: Overview of the ecological properties of reactive dyes

9.9 Sulphur dyes

Applicability

Sulphur dyes are mainly used for cotton and viscose substrates. They may also be used for dyeing blends of cellulose and synthetic fibres, including polyamides and polyesters. They are occasionally used for dyeing silk. Apart from black shades, sulphur dyes play almost no part in textile printing.

Properties

Bleach and wash fastness properties are very good, while light fastness varies from moderate to good. Although they encompass a broad shade range, sulphur dyes are mostly used for dark shades because lighter shades have poor resistance to light and laundering. Sulphur dyes tend to be dull compared with other dye classes.

Chemical characteristics and general application conditions

Sulphur dyes are made up of high molecular weight compounds, obtained by reaction of sulphur or sulphides with amines and phenols. Many colourants exist that contain sulphur in their molecule, but only dyestuffs which become soluble in water after reaction with sodium sulphide under alkaline conditions can be called sulphur dyes.

The exact chemical structure is not always known because these are mixtures of molecules of a high level of complexity. Amino derivatives, nitrobenzenes, nitro and aminobiphenyls, substituted phenols, substituted naphthalenes, condensed aromatic compounds, indophenols, azines, oxazine, thiazol, azine and thiazine rings can be part of these compounds. Sulphur dyes contain sulphur both as an integral part of the chromophore and in polysulphide side chains.

As has already been mentioned, sulphur dyes are insoluble in water, but after reduction under alkaline conditions they are converted into the leuco form, which is water-soluble and has high affinity for the fibre. After absorption into the fibre they are oxidised and converted to the original insoluble state.

Sulphur dyes are available in various modifications, which are classified under the following names:

- sulphur dyes - available as amorphous powders or dispersible pigments. Amorphous powders are insoluble or partially soluble in water and are brought into solution by boiling with sodium sulphide and water. Dispersible pigments can be used in this form for pad dyeing in presence of a dispersing agent. They can contain a certain amount of reducing agent already in the formulation and in this case are called "partly reduced pigments".
- leuco-sulphur dyes (ready-for-use dyes) - available in liquid form and already contain the reducing agent required for dyeing. Therefore they must simply be diluted with water before application. Low-sulphide types are also available on the market
- water-soluble sulphur dyes - available in the form of Bunte salts ($\text{Col-S-SO}_3\text{Na}$) obtained by treating the dye in its insoluble form (Col-S-S-Col) with sodium hydrosulphite. They can be dissolved in hot water, but they do not have affinity for the fibre. The addition of alkali and reducing agent makes them substantive for the fibre.

Sodium sulphide and sodium hydrogensulphide are generally employed as reducing agents to bring into solution the dye (unless ready-for-use sulphur dyes are applied). Binary systems made of glucose and sodium dithionite (hydrosulphite) or thiourea dioxide are also used as alternative reducing agents.

In all processes the dye is finally fixed on the substrate by oxidation. Nowadays, hydrogen peroxide or halogen-containing compounds such as bromate, iodate and chlorite are the most commonly used oxidising agents.

Apart from the above-mentioned reducing and oxidising agents, additional chemicals and auxiliaries required when dyeing with sulphur dyes are:

- alkali (mainly caustic soda)
- salt (sodium chloride and sulphate)
- dispersing agents: usually they are naphthalenesulphonic acid-formaldehyde condensates, ligninsulphonates and sulphonated oils
- complexing agents: EDTA and polyphosphates are used in some cases to prevent negative effects due to the presence of alkaline-earth ions.

Environmental issues

The environmental properties of sulphur dyes are assessed under the following parameters. Note, however, that Table 9.10 does not consider the environmental issues related to chemicals and auxiliaries employed in the dyeing process because these issues are dealt with in a specific annex.

Parameters of concern	Comments
Bio-eliminability	Most sulphur dyes are water-insoluble after oxidation and therefore they can largely be eliminated by adsorption on the activated sludge in the waste water treatment plant
Organic halogens (AOX)	
Eco-toxicity	
Heavy metals	
Aromatic amines	
Unfixed colourant	Degree of fixation ranges between 60 and 90 % in continuous dyeing and 65 - 95 % in printing [77, EURATEX, 2000]
Effluent contamination by additives in the dye formulation	Poorly biodegradable dispersants are present. New formaldehyde condensation products with higher elimination (>70 %) are already available (see Section 4.6.3)

Table 9.10: Overview of the ecological properties of sulphur dyes

9.10 Vat dyes

Applicability

Vat dyes are used most often in dyeing and printing of cotton and cellulose fibres. They can also be applied for dyeing polyamide and polyester blends with cellulose fibres.

Properties

Vat dyes have excellent fastness properties when properly selected and are often used for fabrics that will be subjected to severe washing and bleaching conditions (towelling, industrial and military uniforms, etc.). The range of colours is wide, but shades are generally dull.

Chemical characteristics and general application conditions

From a chemical point of view, vat dyes can be distinguished into two groups: indigoid vat dyes and anthraquinoid dyes. Indigo dyes are almost exclusively used for dyeing warp yarn in the production of blue denim.

Like sulphur dyes, vat dyes are normally insoluble in water, but they become water-soluble and substantive for the fibre after reduction in alkaline conditions (vatting). They are then converted again to the original insoluble form by oxidation and in this way they remain fixed into the fibre.

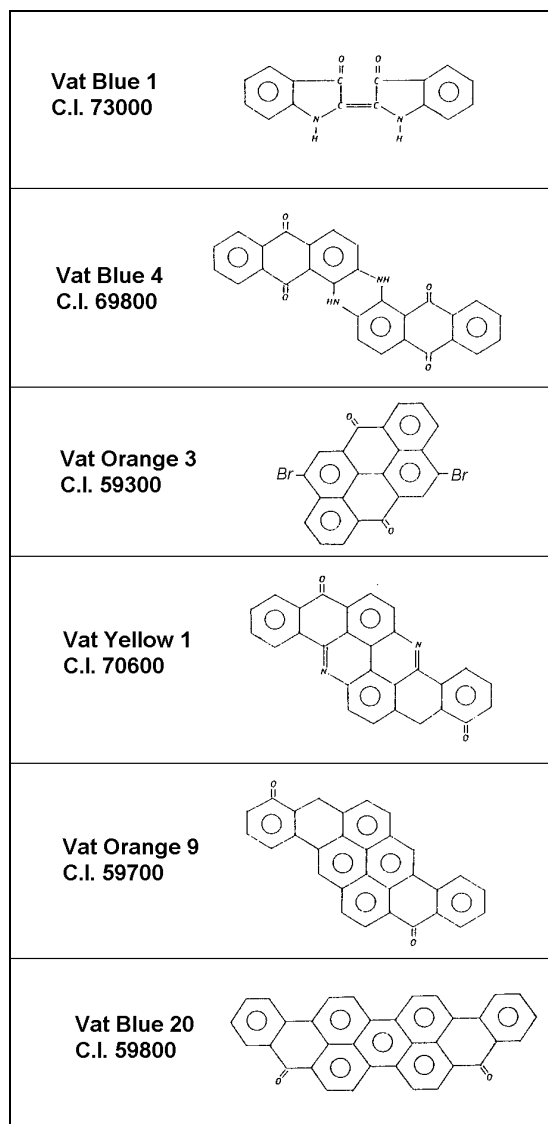


Figure 9.11: Examples of typical vat dyes

Vat dyes are preparations that basically consist of a vatable coloured pigment and a dispersing agent (mainly formaldehyde condensation products and ligninsulphonates). They are generally supplied in powder, granules and paste form.

A wide range of different techniques are used in colouring processes with vat dyes. Nevertheless, all processes involve three steps:

- vatting
- oxidation
- aftertreatment.

The step in which the reduction of the dyestuff into its leuco-form takes place is called *vatting*. Vat dyes are generally more difficult to reduce than sulphur dyes. Various reducing agents are used. Sodium dithionite (hydrosulphite) is still the most widely employed although it has some limits. Sodium dithionite is consumed by reduction of the dye and also by reaction with atmospheric oxygen, therefore an excess of reducing agent has to be used and various techniques have been proposed to reduce these losses (see also Section 4.6.6). In addition sodium dithionite cannot be used for high temperature or pad-steam dyeing processes because over-reduction can occur with sensitive dyes. In these application conditions and also for printing, sulphonylic acid derivatives are normally preferred.

Thiourea dioxide is also sometimes used as a reducing agent, but a risk of over-reduction exists as its reduction potential is much higher than that of hydrosulphite. Furthermore the oxidation products of thiourea dioxide contribute to nitrogen and sulphur contamination of waste water.

Following increasing environmental pressures, biodegradable sulphur-free organic reducing agents such as hydroxyacetone are now available. Their reducing effect, however, is weaker than that of hydrosulphite, so they cannot replace it in all applications. Nevertheless hydroxyacetone can be used in combination with hydrosulphite, thus reducing to a certain extent the sulphite load in the effluent.

After absorption by the fibre, the dye in its soluble leuco form is converted to the original pigment by *oxidation*. This process is carried out in the course of wet treatment (washing) by addition of oxidants such as hydrogen peroxide, perborate or 3-nitrobenzenesulphonic acid to the liquor.

The final step consists in *after-treating* the material in weakly alkaline liquor with a detergent at boiling temperature. This soap treatment is not only aimed at removing pigment particles, but also allows the crystallisation of amorphous dye particles, which gives the material the final shade and the fastness properties typical of vat dyes.

Vat dyeing conditions can vary widely in terms of temperature and the amount of salt and alkali required, depending on the nature of the dye applied. Vat dyes are therefore divided into the following groups, according to their affinity for the fibre and the amount of alkali required for dyeing:

- IK dyes (I = Indanthren, K = cold) have low affinity, they are dyed at 20 – 30 °C and require little alkali and salt to increase dye absorption
- IW dyes (W = warm) have higher affinity, they are dyed at 40 – 45 °C with more alkali and little or no salt
- IN dyes (N = normal) are highly substantive and applied at 60 °C and require much alkali, but no addition of salt.

The following *chemicals and auxiliaries* may be found in *dyeing* processes:

- sodium dithionite, thiourea dioxide and sulphoxilic acid derivatives as reducing agents
- caustic soda
- sodium sulphate
- polyacrylates and alginates as anti-migration agents in padding processes
- formaldehyde condensation products with naphthalenesulphonic acid and ligninsulphonates as dispersing agents
- surfactants (including ethoxylated fatty amines) and other components such as betaines, polyalkylenamines, polyvinylpyrrolidone as levelling agents
- hydrogen peroxide, perborate, 3-nitrobenzenesulphonic acid as oxidants
- soap.

The following *chemicals and auxiliaries* may be found in *printing* processes:

- thickening agents (starch esters with seed flour derivatives)
- reducing agents: various chemicals are used depending on the printing method (all-in or two-phase process), dye selected and steaming conditions. Sulphoxylic acid derivatives are the most common, but hydrosulphite can also be used (in the two-phase process when very short steaming time is required)
- alkali: potassium carbonate, sodium carbonate, sodium hydroxide
- oxidising agents (the same used for dyeing)
- soap.

Environmental issues

The environmental properties of vat dyes are assessed under the following parameters. Note, however, that Table 9.11 does not consider the environmental issues related to chemicals and auxiliaries employed in the dyeing process because these issues are dealt with in a specific annex.

Parameters of concern	Comments
Bio-eliminability	Vat dyes can be regarded as highly eliminable due to the fact that they are water-insoluble and therefore largely adsorbed on the activated sludge in the waste water treatment plant.
Organic halogens (AOX)	
Eco-toxicity	Since they are sparingly soluble they are not bio-available [64, BASF, 1994]
Heavy metals	Vat dyes contain heavy metal impurities (Cu, Fe, Mn, Ba and Pb) due to their production process (in some cases it is still difficult to keep these limits below the ETAD standards) [64, BASF, 1994]
Aromatic amines	
Unfixed colourant	Vat dyes show high exhaustion levels (70 - 95 % in continuous dyeing processes and 70 - 80 % in printing)
Effluent contamination by additives in the dye formulation	Dispersants are present in the dye formulation. As they are water-soluble and poorly degradable, they are found in the waste water. New formaldehyde condensation products with higher elimination (>70 %) are already available and more readily eliminable substitutes are being developed [186, Ullmann's, 2000] (see Section 4.6.3)

Table 9.11: Overview of the ecological properties of vat dyes

9.11 Pigments

Pigments are widely used in printing processes (pigment printing).

Pigments are insoluble in water and organic solvents. Organic pigments are for a large part derived from benzoids. Inorganic pigments are derivatives of metals such as titanium, zinc, barium, lead, iron, molybdenum, antimony, zirconium, calcium, aluminium, magnesium, cadmium or chromium.

10 ANNEX III WET PROCESSES: MACHINERY AND TECHNIQUES

10.1 Loose fibre

10.1.1 Autoclave

Various types of machines are used for processing fibres in loose form. These include conical pan machines, pear-shaped machines and radial flow machines. They are used for all wet operations, that is, pretreatment, dyeing, application of finishing agents and washing.

In conical pan machines (Figure 10.1) the fibre is packed into a removable fibre carrier, which is located onto a central spigot in the base of the vessel. Liquor circulation is provided, via this connection, by an external pump. Associated pipework allows liquor to be circulated either from the base of the pack or from the top.

Pear-shaped machines have a removable perforated base plate through which liquor is circulated via an impeller, returning to the dyeing vessel via a weir. Fibre is loaded directly into these machines and a further perforated plate is positioned on top. Liquor circulation packs the fibre into the base of the machine between the two plates. To unload the machine both plates are removed by crane and the fibre manually removed.

Radial flow machines are characterised by a fibre carrier, equipped with a central perforated column from which liquor flows across the pack to the perforated walls of the carrier.

Loose fibre is typically packed into these machines manually. Capacity varies between 200 - 300 kg, with a working volume equivalent to between 7 and 10 litres per kg fibre. The low packing density in these machines allows liquor to circulate freely through the fibre pack at modest pressures, thus minimising mechanical damage to the fibre while ensuring level dyeing.

The bath is heated by closed steam coils in the base of the machine. In many cases the level of automation on these machines is low and temperature may be controlled manually with a simple steam valve. In other cases electro/pneumatic programmers or logic controllers may be installed to regulate time / temperature and to control the direction of liquor circulation.

Autoclaves can be equipped for operation at higher pressure (this is not the case when they are used for dyeing wool fibres).

Autoclaves of all designs may be fitted with an external holding tank, capable of accommodating at least the volume of the dyeing vessel. Such tanks are used to facilitate re-use of liquors in more than one dyeing. Occasionally more than one dyeing vessel may be connected to a common tank, allowing liquor to be shared between vessels.

The liquor ratio for loose fibre can vary between 1:4 to 1:12, depending on the type of machine, level of loading, type of fibre, etc. [32, ENco, 2001]

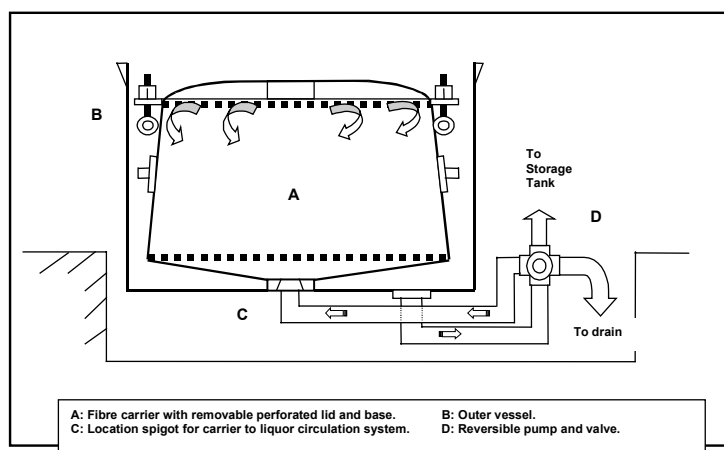


Figure 10.1: Schematic layout of a conical pan loose fibre dyeing machine
 [32, ENco, 2001]

10.2 Yarn

Yarn can be processed either in hank form or in package. Different machines are used depending on the method chosen. They are used for all wet operations, that is, pretreatment, dyeing, application of finishing agents and washing.

10.2.1 Hank dyeing machines

Hank dyeing machines are mostly of the single stick (Hussong) design, in which hanks are hung from the underside of the dyeing vessel lid on removable sticks. (Figure 10.2) The lid is lowered vertically onto the dyeing vessel, which consists of a simple box with a perforated false bottom. Liquor is circulated by a reversible impeller, located vertically in a weir chamber at one end of the machine. Heating is typically by closed steam coils beneath the false bottom and on smaller machines by live steam injection. Temperature control is provided by electro-mechanical or programmable logic controllers. These devices may also control/time the timing of chemical and dye additions and any required cooling cycles. Machine capacities vary from 10 kg sample machines to 1000 kg machines. These larger machines may be coupled together in pairs with interconnecting pipework in such a way that yarn loads of up to 4000 kg can be dyed while still retaining the flexibility to dye individual 1000 kg lots.

Variations of this design may utilise a horizontal circulation impeller passing through a sealing gland at the base of the weir chamber. Such machines invariably have a concave bottom, which is said to improve circulation and reduce fibre to liquor ratio by a small margin. [32, ENco, 2001]

Liquor ratios from 1:15 to 1:25 are typical for these machines.

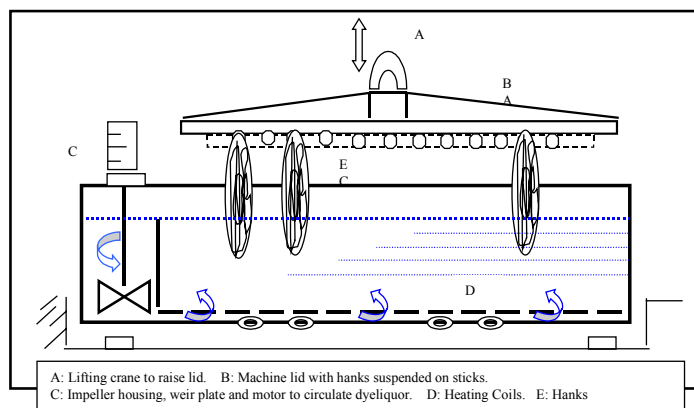


Figure 10.2: Schematic diagram of a Hussong type hank dyeing machine
[32, ENco, 2001]

10.2.2 Package dyeing machines

Three basic types of machine may be used for package dyeing wool yarns: horizontal or vertical spindle machines or tube type machines.

Horizontal spindle machines may be rectangular in design, similar to hank dyeing machines, but modified to take frames, onto which yarn packages are inserted horizontally, or alternatively may be a horizontal autoclave into which is wheeled the carrier containing the yarn packages. Both types operate with high flow rate pumps, which are necessary to give good circulation of the dye liquor. These machines are usually used for bulky yarns, which are wound onto soft packages, again to increase dye liquor penetration.

Vertical spindle machines are the most commonly used (see Figure 10.3). The packages may be press packed onto vertical carrier spindles to increase payload, assist in dye liquor circulation and minimise liquor to fibre ratio.

Tube type machines consist of a number of vertical or horizontal tubes into which package carriers are inserted, the tubes forming individual dyeing vessels linked by common pipework and circulation pumps. These machines are more flexible than the above types because individual tubes can be blanked off to vary the overall load capacity of the machine.

Liquor ratios employed in package dyeing are close to 1:12 (typically from 1:8 to 1:15). Machines with capacities of up to 500 kg are used in dyeing carpet yarns, with the facility to link two or more machine together when dyeing larger single batches. [32, ENco, 2001]

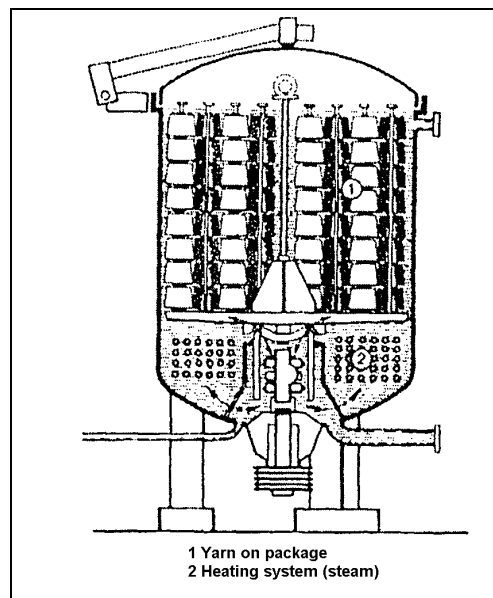


Figure 10.3: Schematic layout of a package dyeing machine
[186, Ullmann's, 2000]

10.3 Fabric in rope form

Wet treatments on fabrics in rope form can be carried out both in batch and in continuous processes.

10.3.1 Batch processes

10.3.1.1 Winch beck

The common element in all winch beck machines is the winch mechanism used to move the fabric. The winch draws the fabric via a guide roller out of the bath and returns it in folds into the bath. In the conventional winch beck (see Figure 10.4), the bath stands still, while the fabric is kept in circulation by a reel positioned in the upper part of the machine. In modern winches both the bath and the fabric are kept in circulation, which improves homogenisation and exchange of the liquor with the fabric.

Greige goods are loaded into the winch either in rope form or in open width, which means that the winches must be 5 - 6 meters in width. The ends of the fabric piece to be dyed are sewn together to form endless loops over the rotating boom (winch).

Winch becks are primarily machines for dyeing, but for practical reasons both preparation and dyeing are normally carried out in the same machine.

These machines are essentially operated at atmospheric pressure although the development of synthetic fibres has led to the production of pressurised machines (HT machines may reach 130 – 140 °C).

Winch beck is a very versatile machine and it can be used for all types of fabric. It is a very common technique for dyeing carpets (they are usually dyed in full width).

Typical bath ratios vary from 1:15 to 1:40 (typically 1:30 in the carpet sector) [171, GuT, 2001], which makes this technique fairly expensive due to high water and energy consumption. However, recent technological developments have been made to improve its environmental performance (see Section 4.6.20)

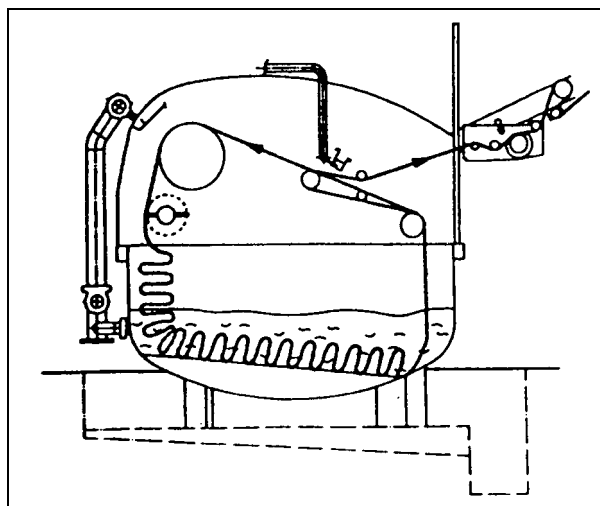


Figure 10.4: Schematic representation of a winch beck dyeing machine [186, Ullmann's, 2000]

10.3.1.2 Jet

Jet machines (see Figure 10.5) have been designed with the aim of eliminating some of the problems associated with the use of winch machines.

The reel is eliminated and the fabric is placed in a closed tubular system. A jet of dye liquor is supplied through a venturi to transport the fabric through the tube. Turbulence created by the jet aids in dye penetration and prevents the fabric from touching the walls of the tube.

Since the fabric is frequently exposed to high liquor concentrations within the transport tube, relatively little dye bath is needed in the bottom of the vessel: just enough to ensure smooth movement from rear to front. Advantages of this machine are therefore low consumption of water and short treatment time (e.g. short dyeing time). Typical liquor ratios vary between 1:4 and 1:20, ranging from 1:4 to 1:10 for fabric and from 1:6 to 1:20 for carpet (lower values apply to synthetic fibres while higher values are typical for cotton) [171, GuT, 2001].

Jets can usually be operated at high temperatures, which makes them very suitable for dyeing polyester fibres. A disadvantage, however, is the high mechanical stress on the textile, caused by the speed difference between the bath and the fabric. For this reason jets are not suitable for some delicate fabrics.

Depending on the shape of the fabric storage area (long shape machine or J-box compact machine), the type of nozzle and its position (above or below the level of the bath) various types of jets exist. Overflow, soft-flow and airflow dyeing machines can be regarded as developments of the conventional jet. The main features of these machines are reported in the following sections, while the latest developments in this dyeing technology are further described in Section 4.6.21.

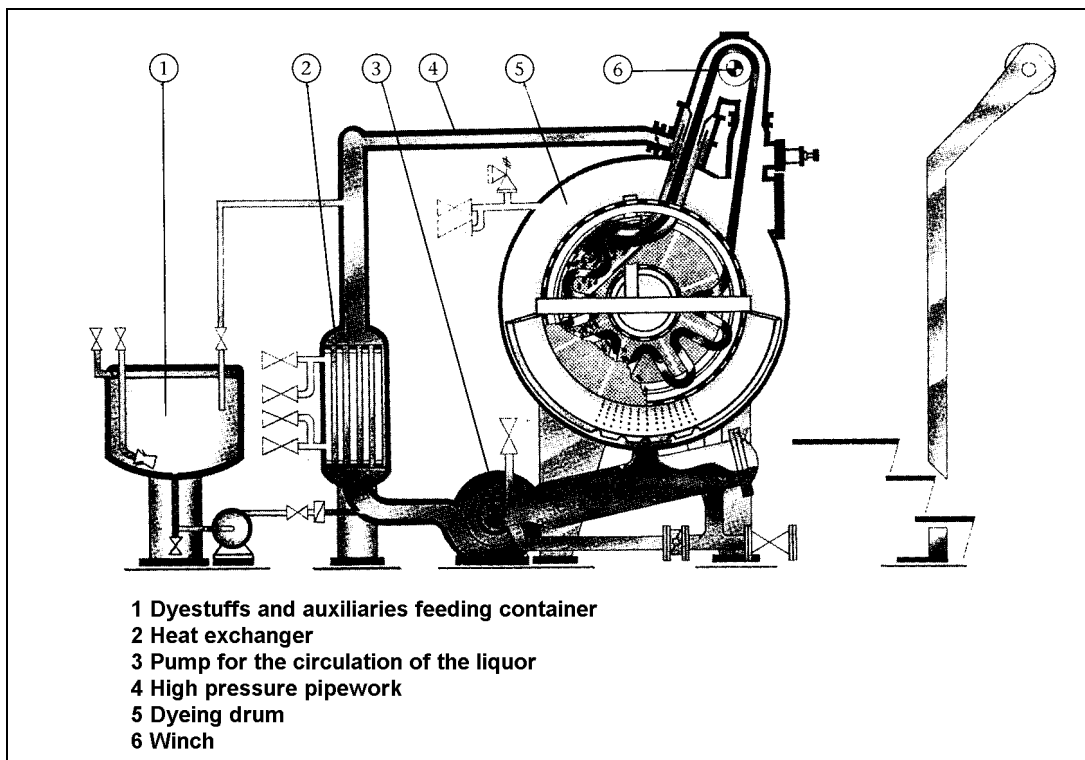


Figure 10.5: Schematic representation of a jet dyeing machine
[186, Ullmann's, 2000]

10.3.1.3 Overflow

Overflows (see Figure 10.6) have been designed for delicate knitted and woven fabrics made of natural and synthetic fibres. They are also found in the carpet sector.

The main difference between jet and overflow machines remains in the fact that in jet machines the fabric is transported by the bath flowing at high speed through the nozzle, while with overflows the fabric is transported by the gravitational force of the liquor overflow.

A winch (usually not motor driven) is located in the upper part of the machine and the fabric hangs over it. A longer length of textile hangs from the exit side of the winch than from the inlet side. Gravitational forces pull the longer length of textile downward more strongly than the shorter. The fabric is therefore soaked in the bath without any tension (transportation is very gentle).

Different designs are available on the market and some of them can operate under pressure and consequently at higher temperatures.

Typical liquor ratios for overflows range between 1:12 and 1:20.

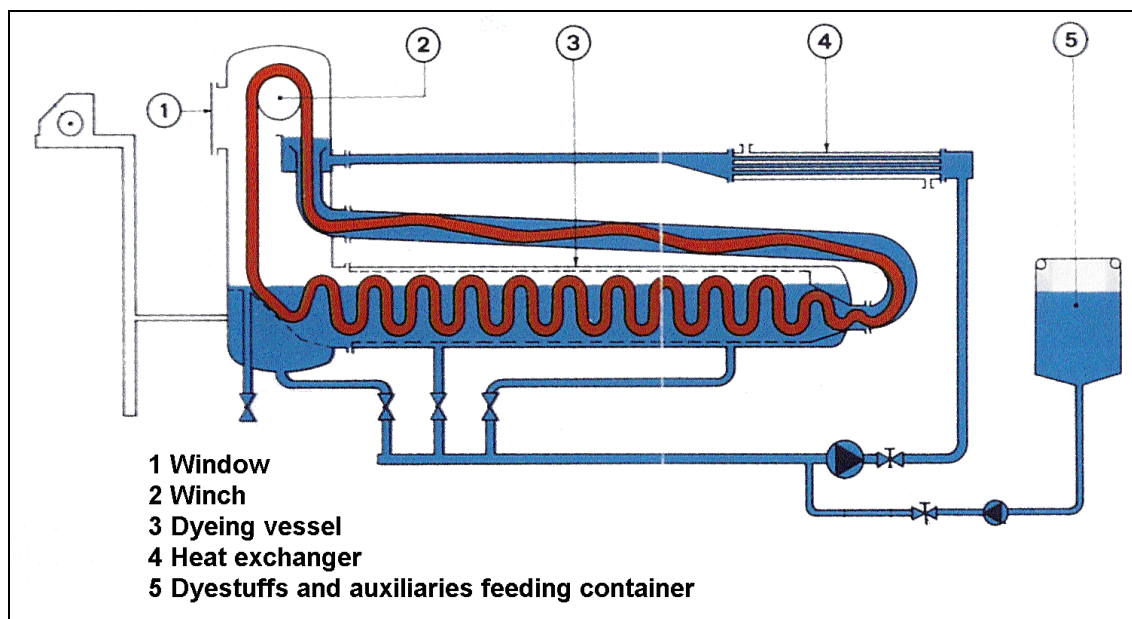


Figure 10.6: Schematic representation of an overflow dyeing machine
[69, Corbani, 1994]

10.3.1.4 Soft-flow

The so-called "soft-flow" machines use the same transport tube principle as overflow machines where the fabric is transported in a stream of dye liquor. However, while in overflow machines the reel is not motor driven, in soft-flow equipment the reel and the jet work in constant harmony to remove the fabric from the front of the storage area, expose it briefly to a high concentration of liquor within the transport tube, then return it to the rear of the vessel. The soft flow machines are more gentle on the fabric than conventional jet overflow machines.

10.3.1.5 Airflow

The difference between air jet (see Figure 10.7) and jet machines is that in the former an air jet instead of a water jet keeps the fabric in circulation. The fabric passes into the storage area which contains a very small amount of free liquor. As a result, a reduction in water, energy and chemicals consumption can be achieved.

Because of the short liquor ratios achievable (from 1:2 to 1:5) the dye must be highly water-soluble.

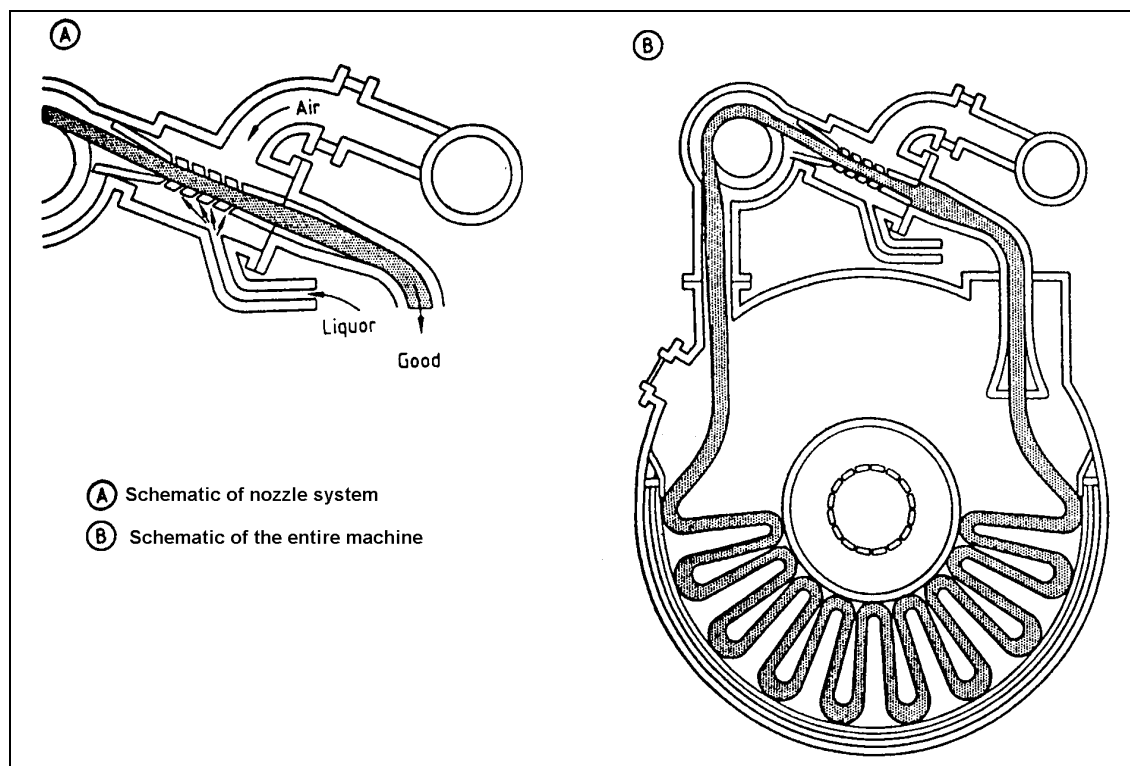


Figure 10.7: Schematic representation of jet dyeing machine
[186, Ullmann's, 2000]

10.3.2 Continuous processes

Machines for treatment in continuous processes of fabrics in rope form are essentially composed of the following parts:

- a padding device for impregnating the fabric in rope form
- a storage area for the fixation of the chemicals applied
- a washing machine for fabric in rope form.

The padding device is composed of a long basin equipped with two or three rotating rollers at the inlet and another two at the outlet. The basin contains a concentrated solution of the chemicals and auxiliaries that have to be applied (desizing agents, bleaching agents, etc.). The fabric is pressed by the rotating rollers at the inlet in order to obtain a homogeneous absorption of the chemicals and the elimination of air. The other two rollers only squeeze the fabric. After squeezing, the fabric retains only a relatively low amount of bath. As a result high concentrations of the chemicals are needed, moreover the solutions must be adequately stabilised to avoid unwanted oxidation reactions, etc.

The storage area (also called reaction chamber) can have different shapes: one typical model is the J-Box. The J-Box is filled to 1/3 of its capacity with the treatment bath.

The main advantage of this technique is the high production capacity. On the other hand there is the risk of longitudinal creases, which can negatively affect the dyeing process. As a result this technique is mainly applied for white end-products for pretreatment operations (e.g. bleaching).

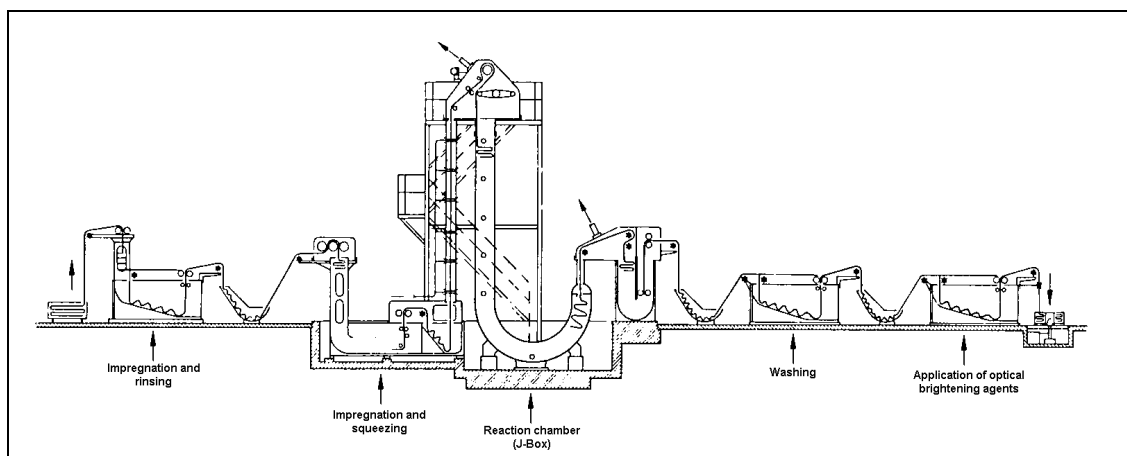


Figure 10.8: Example of continuous process for knitted fabric in rope form [69, Corbani, 1994]

10.4 Fabric in open-width

10.4.1 Batch processes

10.4.1.1 Beam

The fabric is wound in open-width on a perforated cylinder called a beam (see Figure 10.9). The fabric is stationary and the bath is pumped through the beam. The direction of the flow is normally from the inside to the outside of the roll of textile.

The ends of the beam are covered with metal sheets before the fabric is wound on, to prevent a short circuit of the liquor.

Beams can operate both under pressure and at atmospheric pressure.

These machines are suitable for pretreatment operations like scouring and bleaching and also for dyeing of lightweight, wide and delicate goods. One disadvantage is represented by the risk of non-homogeneous penetration of chemicals and auxiliaries used for the treatment.

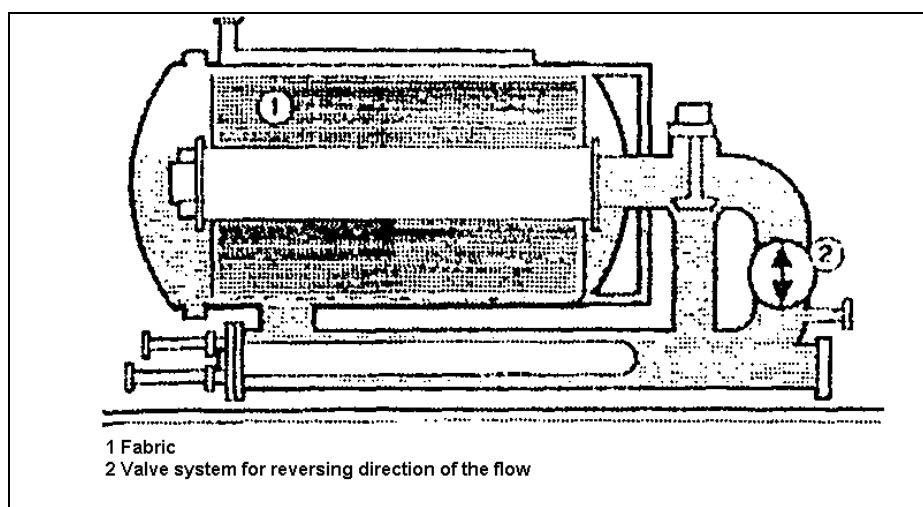


Figure 10.9: Schematic representation of a beam dyeing machine [18, VITO, 1998]

10.4.1.2 Jigger

A jigger (see Figure 10.10) is composed of a trapezoidal tub containing the bath and two rolls on which the fabric is alternatively wound. In this type of machine the bath is stationary while the fabric is in motion. The fabric, initially wound on the first roll, flows through the bath and then is wound on the other one; the rotation is then reversed and the cycle continues. The fabric is led in its path by a few small guide rollers.

HT jiggers are also produced, allowing treatments at temperatures above 100 °C. This type of machine is used not only for dyeing, but also for various wet treatments on fabrics in full width.

The main disadvantage of this system is the risk of non-homogeneity between the initial and final part of the roll. This is due to variations in feed speed and tension of the fabric, or temperature and chemicals concentration in the bath during the period of the treatment. However, in modern jiggers tension of the fabric is kept constant during the whole process, thanks to special devices.

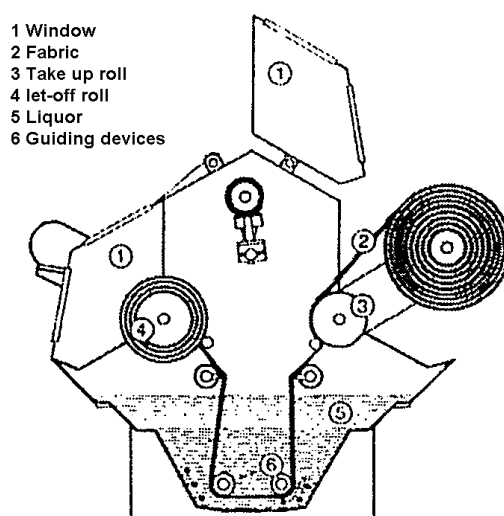


Figure 10.10: Schematic representation of a jigger
[18, VITO, 1998]

10.4.2 Semi-continuous and continuous processes

Some of the most widely used continuous and semi-continuous processes are:

- pad-batch
- pad-roll
- pad-jig
- pad-steam
- pad-dry
- thermosol.

They are briefly described in the following sections.

Typical treatment steps in both semi-continuous and continuous processes are:

- application of the dye or finishing agent either by impregnation (using a padding device) or by means of other types of application systems (see Figure 10.12)
- storage/fixation, which can be carried out in different ways depending on the process applied (e.g. dry heat, steam)
- washing in continuous mode in open width.

Padding machines (foulards) are used to apply dyestuffs or other chemicals onto the fabric in open-width form. The fabric passes through the pad trough where it picks up the liquor. After leaving the pad trough, the fabric is squeezed between rubber rolls. The amount of liquor picked up depends mainly on the pressure produced by the two rolls, the speed at which the fabric is transported and the type of substrate. The level in the trough is automatically maintained to compensate for liquor picked up by the fabric. The liquor is kept in circulation to avoid differences in temperature and/or concentration.

Different designs of foulards exist: some examples are shown in Figure 10.11.

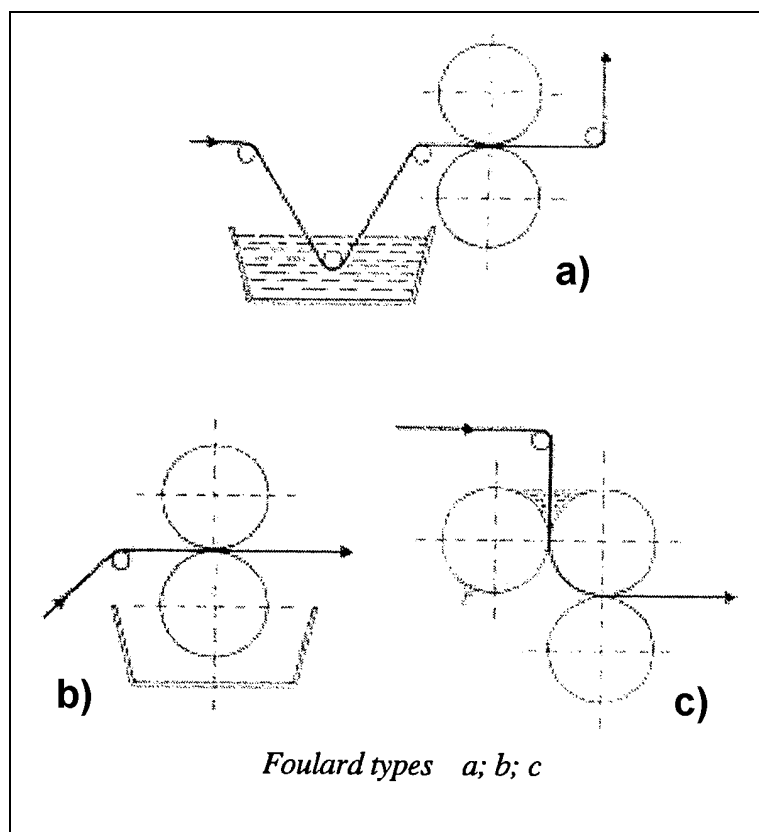


Figure 10.11: Foulard types
[18, VITO, 1998]

Padding is the most common application technique in textile finishing, but other application systems (see figure below) are more common in the carpet industry. Due to their higher ecological performance, some of them are increasingly used in the textile finishing sector.

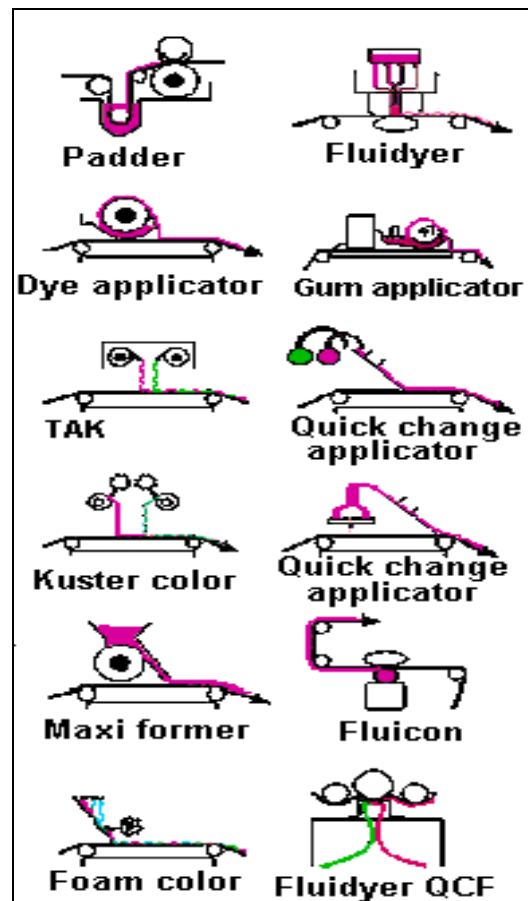


Figure 10.12: Illustration of some of the most important dye/finish applicators [211, Kuster, 2001]

10.4.2.1 Pad-batch process (semi-continuous)

This process includes an impregnation step on a padding machine.

After being squeezed, the fabric is wound onto a roll and stored at room temperature. The roll is kept in slow rotation until the desired chemical processes (e.g. fixation of the dyestuffs, etc.) are complete. At the end the fabric is washed in an open-width washing machine.

This process is commonly used for pretreatment (e.g. desizing) and dyeing (mainly with direct and reactive dyes). It is characterised by low water and energy consumption (about 50 – 80 % less than conventional systems) and good repeatability.

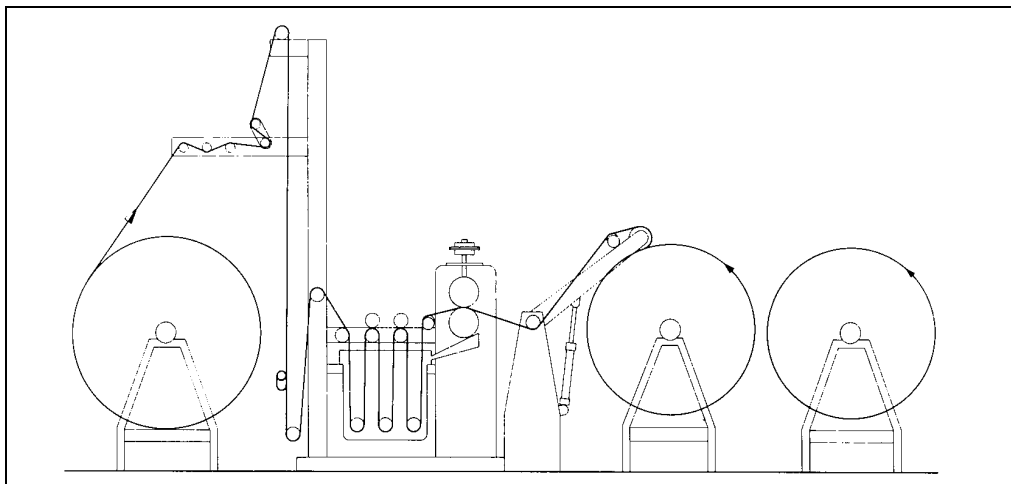


Figure 10.13: Schematic layout of a pad-batch plant
[69, Corbani, 1994]

10.4.2.2 Pad-roll process (semi-continuous)

This process is similar to pad-batch, but in this case the fabric, after padding, passes through an infrared oven. It is then rolled and kept in slow rotation in a hot steam chamber until fixation, or other chemical processes are complete. The fabric is then washed in an open-width washing machine.

10.4.2.3 Pad-jig process (semi-continuous)

This process is generally used as a dyeing technique, mainly used for heavy weight fabrics with direct and reactive dyes.

In this process the fabric passes through a padding machine where it is impregnated with the dyeing bath, then the dyestuff is fixed on a jigger.

Sometimes the fabric can be dried in a hot-flue drier after padding, before entering the jigger.

The application of the dyestuff by padding allows for homogeneous dyeing and time saving when compared to traditional jigger dyeing processes.

10.4.2.4 Pad-steam process (continuous)

This technique is mainly used for scouring woven fabric and dyeing. It is particularly suitable for the application of direct, vat, sulphur and reactive dyestuffs.

It includes the following steps:

- impregnation by padding
- steaming (at about 100 °C)
- additional impregnation of the fabric with developing agents (e.g. reducing agents in vat or sulphur dyeing)
- washing and rinsing.

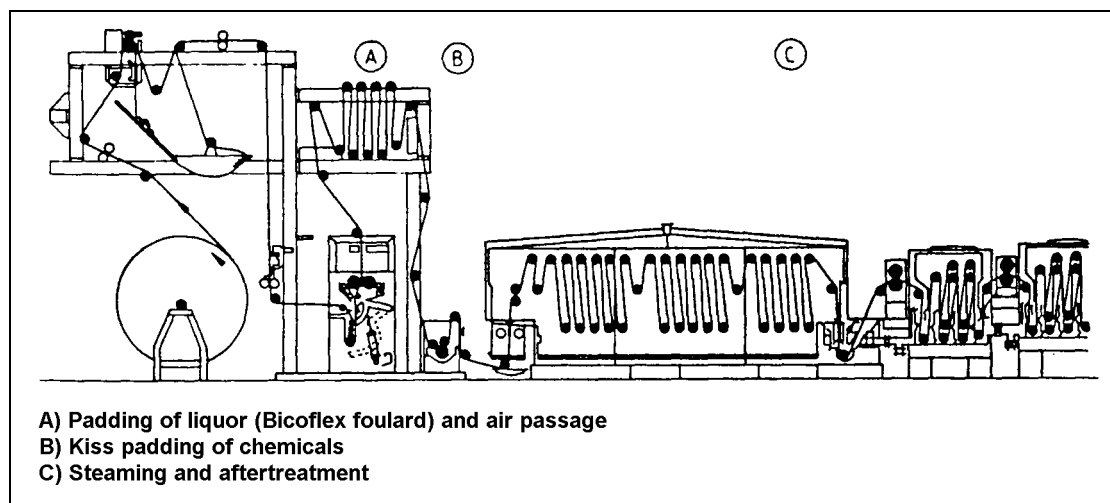


Figure 10.14: Schematic representation of a pad-steam plant (wet steam) for dyeing with vat dyes [186, Ullmann's, 2000]

10.4.2.5 Pad-dry process (continuous)

This process includes the following steps:

- impregnation by padding
- intermediate drying (optional)
- fixation in hot-flue
- washing.

10.4.2.6 Thermosol process (continuous)

This process is specific for dyeing with disperse dyestuffs polyester or cotton/polyester blends.

The process includes the following steps:

- impregnation in the dyeing liquor
- pre-drying in an infrared oven
- drying in hot-flue
- passage through a stenter frame for thermal fixation at 200 °C of the disperse dyes to the PES.

An alkaline reductive aftertreatment is then carried out or, in the case of cotton/polyester blends, the second dye is developed according to the procedure typical of its class, using in general pad-steam, pad-jig or pad-batch processes.

11 ANNEX IV: TYPICAL RECIPES (WITH SOME ASSOCIATED EMISSION FACTOR) IN THE TEXTILE SECTOR

The following information is based on [179, UBA, 2001] with reference to:
 [7, UBA, 1994]
 Schönberger, H.; Kaps, U.
 Reduktion der Abwasserbelastung in der Textilindustrie
 UBA-Texte 3/94 (1994)

11.1 Pretreatment

11.1.1 Cotton and cotton blends

WOVEN FABRIC

Enzymatic desizing

Chemicals	(g Telquel/kg textile substrate)	Remarks
Enzyme	5	
Complexing agent	1	
Surfactant	1 - 8	For discontinuous processes, e.g. desizing in a winch with liquor ratio of 1:20, up to 30 g Telquel/kg textile substrate are applied
Water consumption (l/kg textile substrate)	4 - 6	

Table 1: Standard recipe for enzymatic desizing of woven fabric consisting of CO and CO blends

Removal of water-insoluble sizing agents by cold oxidative desizing

It is a semi-continuous process. The liquor for oxidative desizing is added at room temperature in a paddler with a pick-up of 70 – 80 %. Reaction takes place with a retention time of 16 - 24 h (max. 72 h). The fabric is then thoroughly rinsed.

Chemicals	(g Telquel/kg textile substrate)		Remarks
	Continuous and optimised process	Discontinuous process	
NaOH (100 %)	10 - 20		Usually applied as 33 % or 50 % solution
H ₂ O ₂ (100 %)	15 - 25		Usually applied as 33 % or 50 % solution
Surfactants	1.5 - 3		As surfactants a mixture of non-ionic (about 70 % average, e.g. ethoxylated fatty alcohol) and anionic surfactants (about 30 %, especially alkylsulphonates but also alkyl sulphates and linear alkylbenzene-sulphonates) are applied
Complexing agents	2 - 4		As complexing agents polyacrylates and phosphonates are applied but not EDTA or DTPA
MgSO ₄ (100 %)	0.15 - 0.3		Usually applied as 40 % solution
Water glass (100 %)	5 - 8		Usually applied as 40 % solution
Na-peroxodisulphate (100 %)	3 - 6		Usually applied as 20 % solution
Water consumption (l/kg textile substrate)	4 - 6 or 8 - 12		4 - 6 l/kg in case of multi-usage of water or high efficient washing compartments; otherwise 8 - 12 l/kg

Table 2: Standard recipe for the desizing of woven fabric consisting of CO and CO blends sized with water-insoluble sizing agents

Removal of water-soluble sizing agents

Chemicals	(g Telquel/kg textile substrate)		Remarks
	Continuous and optimised process	Discontinuous process	
Complexing agent	1	3 – 15	As complexing agents polyacrylates and phosphonates are applied but not EDTA or DTPA
Surfactant	1 – 3	4 – 20	As surfactants a mixture of non-ionic (about 70 % average, e.g. ethoxilated fatty alcohol) and anionic surfactants (about 30 %, especially alkylsulphonates but also alkyl sulphates and linear alkylbenzene-sulphonates) are applied; also to a minor extent alkylether sulphates and alkylethoxy-phosphoric esters. For recovery of sizing agents desizing is carried out without surfactants; but then more washing compartments are needed in order to stay under a residual content of sizing agents of 1.2 %. Very often surfactant formulations already contain defoaming agents (0.1 – 1 g/kg); if not dosage of defoaming agents is needed. Usually polysiloxanes are used (very low dosage) and to a minor extent hydrocarbons (higher dosage) and trialkyl phosphoric esters
Soda or NaOH (100 %)	0 - 3 0 - 2	0 – 3 0 – 2	
Water consumption (l/kg textile substrate)	4 – 6 or 8 - 12	ca. 50 (winch)	4 - 6 l/kg for multi-usage of water otherwise 8 - 12 l/kg; in continuous processes washing water from bleaching and/or scouring is used for desizing

Table 3: Standard recipe for the desizing of woven fabric consisting of CO and CO blends sized with water-soluble sizing agents

Scouring

Chemicals	(g Telquel/kg textile substrate)		Remarks
	Continuous and optimised process	Discontinuous process	
NaOH (100 %)	20 – 80	20 - 80	The quantity depends both on the percentage of cotton in blends and on the applied processes.
Complexing agents	1 – 6	3 - 30	<p>Some suppliers for complexing agents do not recommend more than 2 g/kg for continuous processes. The application of complexing agents is necessary to extract calcium. For this purpose NTA is not efficient enough. Normally a mixture of different complexing agents such as phosphonates, gluconates, polyphosphates, NTA, polyacrylates (in some cases are still in use EDTA and DTPA).</p> <p>The use of complexing agents can be reduced significantly if an acidic treatment is carried out prior to scouring (in Germany this possibility is very seldom practised).</p> <p>In some cases combinations of complexing agents and reducing agents are used.</p>
Surfactant	5 - 6	5 - 30	Some suppliers recommend 2 – 4 g/kg for continuous processes. The composition concerns the one which is given for desizing of water-soluble sizing agents (see Table 3)
Water consumption (l/kg textile substrate)	8 - 10	ca. 50	Rinsing is included for continuous processes the consumption can be lower if water-recycling is practised.

Table 4: Standard recipe for scouring of woven fabric consisting of CO and CO blends

Bleaching

Chemicals	(g Telquel/kg textile substrate)		Remarks
	Continuous and optimised process	Discontinuous process	
H ₂ O ₂ (100 %)	5 - 15	5 – 15	Stabilised by phosphoric acid and organic stabilisers
NaOH (100 %)	4 – 10	4 – 30	At the beginning of the bleaching process the phosphoric acid is neutralised and loses its stabilising effect
Complexing agents ⁽¹⁾	0 - 2	0 – 2	For complexing calcium and heavy metal ions the same compounds are used as for scouring; magnesium may not be complexed because it is needed for the stabilisation of H ₂ O ₂
Organic stabiliser ⁽¹⁾	0 - 10	0 –20	For the stabilisation of H ₂ O ₂ , many products are available which contain complexing agents for calcium and heavy metal ions, such as gluconate, NTA/EDTA/DTPA, polyacrylates and phosphonates; in Germany DTPA is no longer applied and EDTA only to a minor extent
Surfactant	2 - 5	2 – 10	The same compounds are applied as for desizing and scouring (see Tables 3 and 4)
Sodium silicate ⁽¹⁾	8 - 20		Sodium silicate acts as pH buffer, alkali supplier, anti-catalyte and stabiliser
Water consumption (l/kg textile substrate)	6 - 12	ca. 50	Rinsing is included

⁽¹⁾ The consumption of complexing agents, organic and inorganic (silicate) stabilisers vary in total from 0 – 20g/kg. As for scouring, the consumption can be significantly reduced by acidic pretreatment.

Table 5: Standard recipe for bleaching of woven fabric consisting of CO and CO blends

Mercerisation

Chemicals	(g Telquel/kg textile substrate)	Remarks
NaOH (100 %)	200 - 300	
Wetting agent	0 - 10	A wetting agent is only applied in case of dry-in-wet-mercerisation (raw mercerisation). They consist of short chain anionic compounds such as alkylsulphates
Complexing agent	2	Only for raw mercerisation. The same chemicals are used as for scouring (see Table 4)

Table 6: Standard recipe for mercerisation of woven fabric consisting of CO and CO blends

Alkali treatment

Chemicals	(g Telquel/kg textile substrate)	Remarks
KOH (100 %) or NaOH (100 %)	200 – 300 60 - 230	
Sandoflex A	60 – 80 ml	The product is a liquid formulation with a concentration of active compounds of 50 %. It consists of sulphuric acid esters, a fatty acid derivate and an alkylsulphonate
Wetting agent	5	

Table 7: Standard recipe for alkali treatment of woven fabric consisting of CO and CO blends

KNIT FABRIC

Pretreatment of knit fabric does not need desizing because sizing agents are not present.

“Light scouring” is applied if bleaching is not needed; i.e. it is applied for fabric to be dyed in dark shades (black, brown, dark marine or turquoise etc.). “Light scouring” is also called “alkali pre-washing”; a precise definition is not available.

Usually bleaching is only applied for full bleach qualities which are not dyed subsequently or which are dyed in light and medium shades. However, because of logistics some mills bleach all kind of qualities. In the case of continuous processes bleaching is usually performed in a single stage. There are exceptional cases in which the combined bleaching process with peracetic acid/hydrogen peroxide/optical brightener is applied.

In many cases so-called combination bleaching, consisting of a two-stage bleaching with sodium hypochlorite and hydrogen peroxide has been replaced by two-stage hydrogen peroxide bleaching and one-stage bleaching with reducing agents. An acidic pretreatment, which requires a lower dosage of complexing agents in the subsequent bleaching stage is usually carried out in one-stage, similarly to woven cotton fabric or cotton blends.

The consumption of chemicals for pretreatment of knit fabric is similar to that for woven fabric.

Neutral/acetic demineralisation

Chemicals	(g Telquel/kg textile substrate)	Remarks
Inorganic or organic acid	0 - 2	
Complexing agents	1 - 3	The same chemicals are applied as for scouring of woven fabric (see Table 4)
Surfactant	1 - 3	The same chemicals are applied as for desizing of water-soluble sizing agents (see Table 3)
Water consumption (l/kg textile substrate)	n.d.	

Table 8: Standard recipe for neutral/acidic demineralisation of knit fabric consisting of CO and CO blends

“Light scouring” process (alkali pre-wash)

Chemicals	(g Telquel/kg textile substrate)	Remarks
Soda or NaOH (as 100 %)	ca. 50 ca. 50	There is a wide range of alkali quantities applied
Surfactant	1 - 3	
Water consumption (l/kg textile substrate)	n.d.	

Table 9: Standard recipe for “light scouring” of knit fabric consisting of CO and CO blends

Bleaching with hypochlorite

Chemicals	(g Telquel/kg textile substrate)		Remarks
	Continuous and optimised process	Discontinuous process	
NaOCl (as active chlorine)	5 – 6	ca. 30	
NaOH (100 %)	1 – 3	5 - 15	
Surfactant	2 – 5	2 - 10	
Water consumption (l/kg textile substrate)	n.d.	n.d.	

Table 10: Standard recipe for bleaching with hypochlorite of knit fabric consisting of CO and CO blends

Bleaching with hydrogen peroxide

Chemicals	(g Telquel/kg textile substrate)		Remarks
	Continuous and optimised process	Discontinuous process	
H ₂ O ₂ (100 %)	5 - 15	5 – 15	
NaOH (100 %)	4 – 10	4 - 30	Usually the lower dosage is applied because for knit fabric seed shells are already removed to a high extent
Complexing agents	0 - 2	0 - 2	See Table 5
Organic stabiliser	0 – 10	0 - 20	See Table 5
Surfactant	2 – 5	2 - 10	See Table 5
Sodium silicate	8 – 20	0 - 20	See Table 5
Water consumption (l/kg textile substrate)	n.d.	n.d.	

Table 11: Standard recipe for bleaching with hydrogen peroxide of knit fabric consisting of CO and CO Blends

11.1.2 Viscose**WOVEN FABRIC**

Usually viscose is treated with alkali. Only exceptionally is subsequent bleaching with hydrogen peroxide carried out. Thereby the applied quantities of chemicals are lower than for cotton because viscose does not contain natural by-products which need to be removed.

Alkali treatment

Chemicals	(g Telquel/kg textile substrate)	Remarks
NaOH (100 %)	40 – 60	Normally strength of applied caustic soda lye is 6°Bé
Surfactant	3 – 20	
Water consumption (l/kg textile substrate)	n.d.	

Table 12: Standard recipe for alkali treatment of woven fabric consisting of viscose**Scouring**

Chemicals	(g Telquel/kg textile substrate)	Remarks
NaOH (100 %)	ca. 30	When the scouring process is applied as a single stage
Surfactant	3 - 20	
Water consumption (l/kg textile substrate)	ca. 10	

Table 13: Standard recipe for scouring of woven fabric consisting of viscose**KNIT FABRIC**

Knit fabric consisting of viscose is not a common product. The standard recipe for bleaching concerns cotton. However the dosage of caustic soda and hydrogen peroxide is reduced to 40 - 70 %.

11.1.3 Man-made fibres (woven and knit fabric)

Woven fabric and knit fabric consisting of man-made fibres are usually washed in order to remove sizing agents and preparation agents which are normally water-soluble. Scouring is not carried out. The application of bleaching of PES and PAN with chlorite is no longer common.

STANDARD RECIPES FOR WASHING (CONTINUOUS AND DISCONTINUOUS PROCESSES)**Woven fabric**

Chemicals	(g Telquel/kg textile substrate)	Remarks
Alkali	0 – 2	For pH-adjustment depending on the kind of sizing agents; normally NaOH, soda or ammonia hydroxide are used, seldom sodium phosphate
Complexing agents	0.5 – 15	
Surfactant	0.5 – 30	
Water consumption (l/kg textile substrate)	4 – 8	In case of micro fibres up to 60 l/kg

Table 14: Standard recipe for washing of woven fabric consisting of man-made fibres**Knit fabric**

Chemicals	(g Telquel/kg textile substrate)	Remarks
Complexing agents	0 – 10	Polyacrylates are predominantly applied, less often polyphosphates
Surfactant	2 – 20	
Water consumption (l/kg textile substrate)	n.d.	

Table 15: Standard recipe for washing of knit fabric consisting of man-made fibres

BLEACHING

Reductive bleaching of polyamide

Chemicals	(g Telquel/kg textile substrate)	Remarks
Sodium dithionite containing formulation	10 – 30	
Optical brightener	5 – 15	
Surfactant	1 – 2	
Water consumption (l/kg textile substrate)	n.d.	

Table 16: Standard recipe for reductive bleaching and optical brightening of polyamid

Bleaching of PES or PAN with sodium chlorite

Chemicals	(g Telquel/kg textile substrate)	Remarks
NaClO ₂ (100 %)	5 – 15	
Formic acid pH 2.5 – 3.5 or oxalic acid pH 2.5	n.d.	Additionally contains buffer salts and stabilisers
Corrosion inhibitor (Chemistry = ?)	10 – 20	
Water consumption (l/kg textile substrate)	n.d.	

Table 17: Standard recipe for the bleaching of PES and PAN with sodium chlorite

11.1.4 Wool

Raw wool scouring

Chemicals	(g Telquel/kg textile substrate)	Remarks
Soda	n.d.	
Surfactant	n.d.	Non-ionic types
Water consumption (l/kg textile substrate)	ca. 4	For optimised continuous process

Table 18: Standard recipe for the raw wool scouring

Carbonising

Chemicals	(g Telquel/kg textile substrate)	Remarks
H ₂ SO ₄ (100 %)	35 – 70	
Surfactant	1 - 3	
Water consumption (l/kg textile substrate)	ca. 3	For optimised continuous process

Table 19: Standard recipe for wool carbonising

Washing and felting

Chemicals	(g Telquel/kg textile substrate)	Remarks
Soda or ammonia (100 %)	0 – 5 ca. 2.5	
Surfactant	3 – 20	
Water consumption (l/kg textile substrate)	n.d.	

Table 20: Standard recipe for wool washing and felting

Bleaching

For full bleach qualities, the standard process for wool bleaching is the application of a combination of oxidation (hydrogen peroxide) with subsequent reductive bleaching (3 g/l reducing agent, e.g. stabilised sodium dithionite and 0.5 g/l surfactant). For wool pre-bleaching either hydrogen peroxide or reducing agents can be used. With regard to the standard recipe for wool bleaching it has to be stressed that the dosage of chemicals can vary considerably depending on time and temperature of the process.

Chemical	(g Telquel/kg textile substrate)	Explanations
H ₂ O ₂ (100 %)	50 - 75	Because of high dosage the process is often carried out on standing bath
Complexing agents (stabiliser)	5 - 30	
Ammonia (100 %)	0 - 20	pH 8 – 9 with buffer system (usually on base of sodium tripolyphosphate)
Water consumption (l/kg textile substrate)	n.d.	

Table 21: Standard recipe for bleaching of wool

In some cases acidic hydrogen peroxide bleaching is applied. Then an activator instead of a stabiliser is used. After bleaching rinsing takes place and reductive bleaching (40 – 80 g reducing agents/kg wool) at 60 °C for 30 minutes is carried out. Finally optical brighteners can be added.

In general, especially for bleaching of yarn and knit fabric with hydrogen peroxide, stabilisers based on protein derivatives and modified phosphoric esters (lecithine types) are used. These stabilisers also act as dispersing agents. Also fatty acid amides are in use; they do not stabilise the bleaching bath only but also serve as a softening agent.

Hercosett-anti-felt-finishing

Chemicals	(g Telquel/kg textile substrate)	Remarks
NaOCl (as active chlorine)	n.d.	
H ₂ SO ₄ (100 %)	n.d.	
Surfactant	n.d.	
Soda	n.d.	
Na ₂ SO ₃	n.d.	
Polyamide resin	n.d.	
Softening agent	n.d.	
NaHCO ₃	n.d.	
Water consumption (l/kg textile substrate)	n.d.	

Table 22: Standard recipe for Hercosett-anti-felt-finishinf of wool

Pretreatment for printing

Pretreatment with chlorine-containing substances

Chemicals	(g Telquel/kg textile substrate)	Remarks
Dichloroisocyanurate (1.2 – 3.8 % active chlorine)	20 - 60	
Formic/acetic/sulphuric acid	10 - 30	
Sodium disulphites or dithionite	20 – 40	
Surfactant	2 – 5	
Polymers (100 %)	10 – 30	Mainly cationic products
Water consumption (l/kg textile substrate)	n.d.	

Table 23: Standard recipe for the pretreatment for printing of wool with chlorine-containing substances

Pretreatment without chlorine-containing substances

Chemicals	(g Telquel/kg textile substrate)	Remarks
Peroxomonosulphates	20 - 60	
Sodium sulphite or dithionite	20 - 60	
Surfactant	2 - 5	
Polymers (100 %)	10 - 30	Mainly cationic but padding with anionic polymers is also common. Cationic and anionic polymers are also applied without pre-oxidation
Water consumption (l/kg textile substrate)	n.d.	

Table 24: Standard recipe for the pretreatment for printing of wool without chlorine-containing substances

11.2 Dyeing

Component	(ml/l)	Remarks
Reactive dyestuffs	x (g/l)	
NaOH 38°Bé	20 - 40	
Water glass 37/40° Bé	30 - 50	Today, there are recipes available without water glass, using alkali only
Wetting agent	1 - 2	
Complexing and sequestering agents	1 - 3	Mainly phosphonates and polyacrylates in order to minimise silicate deposits
Urea (45 %)	about 200 g/l	Applied for reactive dyestuffs with comparatively low water solubility

Table 1: Typical recipe for padding liquors for cold pad batch dyeing of cellulosic fibres (CO and CV) with reactive dyestuffs

Component	(g/l)
Sulphur dyestuffs	x
NaOH 38°Bé	20 - 30
Anti-foaming agent	1 - 2
Wetting agent	1.5 - 3
Reducing agent (liquid)	20 - 30

Table 2: Typical recipe for padding liquors for the application of sulphur dyestuffs (for dyeing of cellulotics (CO and CV))

Component	(g/l)
Vat dyestuffs	x
Wetting agent	1 - 2
Sequestering agents	1 - 3
Anti-migration agent	10 - 15
For reduction	
NaOH 38°Bé	60 - 120
Na-dithionite	60 - 100
Wetting agent	1 - 2

Table 3: Typical recipe for padding liquors for the application of vat dyestuffs (for dyeing of cellulotics (CO and CV))

Component	(g/l)
Vat and disperse dyestuffs	x
Wetting agent	1 - 2
Sequestering agents	1 - 3
Anti-migration agent	10 - 15
Acetic acid (60 %)	0.5 - 1

Table 4: Typical recipe for padding liquors for the application of vat and disperse dyestuffs (for dyeing of cellulotics/PES blends with one padding liquor)

11.3 Printing

Component	Composition %
Reactive dyestuff liquid	7
Alginate thickener	2
Ludigol	1
NaHCO ₃	3
Water	88

Table 1: Typical composition of printing pastes with reactive dyestuffs (COD: ca. 55000 g/kg)

Component	Composition %
Vat dyestuff liquid	4.3
Thickener	5.0
Rongalit C	10.6
K ₂ CO ₃	11
Urea	2
Sorbit	5
De-aerating agent	0.2
Water	61.9

Table 2: Typical composition of printing pastes with vat dyestuffs (COD: ca. 160000 g/kg)

Component	Composition %
Pigment dough	4
Acrylate thickener	3
Emulsifier	1
Binder	12
Cross-linking agent	1
Softening agent	1
Water	78

Table 3: Typical composition of pigment printing pastes (COD: ca. 300000 g/kg)

Component	Composition %
Disperse dyestuff	2.6
Tamarinds thickener	7.0
Dispersing agents	0.5
Monosodium phosphate	2.8
Water	87.1

Table 4: Typical composition of printing pastes with disperse dyestuffs

11.4 Finishing

Typical recipes for padding liquors in textile finishing are summarised in Table 1, while Table 2 to Table 17 report the substrate emission factors to air for some common auxiliary formulations listed in the “Textile Auxiliaries Buyers’ Guide” ([65, TEGEWA, 2000]).

Effect	Substrate	Process temperature (°C)	Recipe
Softening	PES/CV/CO	150	Softening agent: 130 g/l Foaming agent: 15 g/l
Softening	PES	170	Softening agent: 40 g/l
Softening	CO/PES	160	Softening agent: 20 g/l
Softening	PES/WO	130	Softening agent: 5 g/l
Softening, optical brightener, antielectrostatic	PES	185	Softening agent: 5 g/l Optical brightener: 19 g/l Antielectrostatic agent: 6 g/l Wetting agent: 2 g/l Levelling agent: 2 g/l
Softening, stiffening	CO	120	Starch: 50 g/l Softening agent 1: 30 g/l Softening agent 2: 15 g/l Wetting agent: 2 g/l
Hydrophobic, conditioning	PES	160 - 190	Hydrophobic agent: 52 g/l Conditioning agent: 27 g/l
Hydrophobic	PES	160 - 190	Hydrophobic agent: 90 g/l
Hydrophobic	PAC/PES	180	Hydrophobic agent: 40 g/l Acetic acid: 2 g/l
Non-slip	PAC	160	Non-slip agent: 50 g/l
Non-slip	PES/WO	130	Non-slip agent: 30 g/l
Easycare	CO/PES	130 - 170	Crosslinking agent: 50 g/l Catalyst: 7 g/l Acid: 0.5 g/l
Easycare	PES	155	Non-creasing agent (formaldehyde-free): 25 g/l Additive for easycare: 10 g/l Dispersing agent: 1 g/l Levelling agent: 5 g/l
Easycare, softening, optical brightening	CO	100 - 150	Softening agent: 35 g/l Condition agent: 10 g/l Optical brightener: 25 g/l Crosslinking agent: 50 g/l
Easycare, softening, dyeing aftertreatment	CO/EL	170	Softening agent: 30 g/l Crosslinking agent: 20 g/l Dyeing aftertreatment: 10 g/l Catalyst: 8 g/l Acetic acid: 1 g/l
Easycare, softening, optical brightening	CO	150	Crosslinking agent: 100 g/l Softening agent 1: 40 g/l Softening agent 2: 40 g/l Catalyst 1: 30 g/l Catalyst 2: 5 mg/l Optical brightener: 2 g/l
Easycare, softening	CV/PA 6	180	Crosslinking agent: 65 g/l Catalyst 1: 20 g/l Catalyst 2: 0.2 g/l Softening agent 1: 50 g/l Softening agent 2: 15 g/l
Easycare, softening, anti-slip	LI/CO	180	Crosslinking agent: 70 g/l Catalyst: 40 g/l Anti-slip agent: 35 g/l Softening agent 1: 10 g/l Softening agent 2: 40 g/l Deaeration agent: 2 g/l
Anti-electrostatic, anti-slip	PES	100	Anti-slip agent: 90 g/l Anti-electrostatic agent: 5 g/l
Anti-electrostatic, optical brightening	PES	190	Optical brightener: 9 g/l Anti-electrostatic agent: 7 g/l
Flame retardant	CO	145	Flame retarder: 160 g/l

Table 1: Typical recipes in textile finishing

	Active ingredients	Organic-C (g/kg)	Testing conditions (Curing temperature (°C); Curing time (min)); Substrate
A	Mineral oils	500 - 800	190 °C, 2 min (PES)
B	Conventional fatty acid esters	100 - 250	190 °C, 2 min (PES)
C	Steric hindered fatty acid esters	50 - 100	190 °C, 2 min (PES)
D	Polyolesters	20 - 200	190 °C, 2 min (PES)
E	Polyester- /polyethercarbonates	10 - 50	190 °C, 2 min (PES)

Table 2: Textile substrate specific emission factors of different compounds in preparation agents at certain conditions

	Organic-C (g/kg)	Formaldehyde (g/kg)	Testing conditions Curing temperature (°C); Curing time (min); Substrate
A	14	4	170 °C; 4 min (CO)
B	15	5	170 °C; 3 min (CO/PES)
C	2	6	180 °C; 1.5 min (CO)
D	15	4	170 °C; 3 min (CO/PES)
E	20	4	170 °C; 3 min (CO)
F	5	15	190 °C; 1.5 min (PES)
G	23	3	150 °C; 2 min (CO)
H	5	3	170 °C; 3 min (CO)

Table 3: Substance specific emission factors to air (organic carbon and formaldehyde) of easycare finishing agents based on dimethyloldihydroxyethen urea derivatives

	Organic-C (g/kg)	Formaldehyde (g/kg)	Testing conditions Curing temperature (°C); Curing time (min); Substrate
A	13	6	160 °C; 1 min (PES)
B	33	19	190 °C; 1.5 min (PES)
C	24	31	170 °C; 1.5 min (CO)
D	21	51	170 °C; 3 min (CO)
E	7	5	150 °C; 3 min (CO)
F	11	4	170 °C; 3 min (CO)

Table 4: Substance specific emission factors to air (organic carbon and formaldehyde) of easycare finishing agents based on melamine derivatives

	Active ingredients	Organic-C (g/kg)	Testing conditions Curing temperature (°C); Curing time (min); Substrate
A	Fatty acid ethoxylate, hydrocarbons	112	190 °C; 1.5 min (PES)
B	Silicone	22	160 °C; 2 min (PES)
C	Hydrocarbons (80 %)	573	170 °C; 4 min (CO)
D	Hydrocarbons	737	190 °C; 1.5 min (PES)

Table 5: Substance specific emission factors to air of anti-foaming agents

	Active ingredients	Organic-C (g/kg)	Testing conditions Curing temperature (°C); Curing time (min); Substrate
A	Fatty alcohol ethoxylate	64	150 °C; 2 min (WO)
B	Fatty alcohol derivative	31	190 °C; 1.5 min (PES)
C	Tributylphosphate	239	170 °C; 4 min (CO)
D	Tributylphosphate	228	170 °C; 4 min (CO)
E	Tributylphosphate	335	190 °C; 1.5 min (PES)
F	Phosphoric acid esters	45	170 °C; 4 min (BW)
G	Fatty alcohol ethoxylate	81	190 °C; 1.5 min (PES)
H	Fatty alcohol ethoxylate	294	190 °C; 1.5 min (PES)
I	Alkansulphonates	142	150 °C; 1.5 min (PES)

Table 6: Substance specific emission factors to air of wetting agents

	Active ingredients	Organic-C (g/kg)	Testing conditions Curing temperature (°C); Curing time (min); Substrate
A	Polysiloxane	19	170 °C; 4 min (CO)
B	Polysiloxane	10	170 °C; 4 min (CO)
C	Polysiloxane	3	170 °C; 3 min (CO)
D	Polysiloxane	17	160 °C; 0.5 min (CO)
E	Polysiloxane, polyethylene	0.6	170 °C; 4 min (CO)
F	Polysiloxan	17	170 °C; 4 min (CO)
G	Fatty acid derivative	1.9	170 °C; 3 min (CO)
H	Fatty acid derivative	4	170 °C; 4 min (CO)
I	Fatty acid derivative	5	170 °C; 2 min (CO)
K	Fatty acid derivative	2	170 °C; 3 min (CO)
L	Fatty acid derivative	1	170 °C; 4 min (CO)
M	Fatty acid derivative, waxes	38	180 °C; 1.5 min (PES)

Table 7: Substance specific emission factors to air of softening agents

	Active ingredients	Organic-C (g/kg)	Testing conditions Curing temperature (°C); Curing time (min); Substrate
A	Aromatic carboxylic acid derivative	357	150 °C; 4 min (PES)
B	Aromatic esters	219	190 °C; 1 min (PES)
C	o-phenylphenol	354	190 °C; 1.5 min (PES)

Table 8: Substance specific emission factors to air of carriers

	Active ingredients	Organic-C (g/kg)	Testing conditions Curing temperature (°C); Curing time (min); Substrate
A	Phosphonic acid derivative	124	190 °C; 1.5 min (PES)
B	Phosphonic acid derivative	37	100 °C; 1 min (PES)
C	Inorganic salts	2	170 °C; 3 min (CO)
D	Organic-P-compound	19; formaldehyde: 30 g/kg	160 °C; 3.5 min (CO)
E	Organic P-compound	0.2; formaldehyde: 3.6 g/kg	120 °C; 2 min (CO)
F	Alkylphosphate	109	150 °C; 2 min (PES)
G	Inorganic/organic salts	12	110 °C; 2 min (PES)
H	Organic P-compound	24	175 °C; 1 min (PES)
I	N-and P-containing compound	0.2	150 °C; 3 min (CO)
K	Inorganic/organic salts	3	110 °C; 2 min (PES)
L	N-and P-containing compound	30	190 °C; 1.5 min (PES)

Table 9: Substance specific emission factors to air of flame-retardants

	Active ingredients	Organic-C (g/kg)	Testing conditions Curing temperature (°C); Curing time (min); Substrate
A	Fluorocarbon resin	43	190 °C; 1.5 min (PES)
B	Fluorocarbon resin	47 42	190 °C; 1.5 min (PES) 170 °C; 4 min (CO)
C	Fluorocarbon resin	23	150 °C; 4 min (CO)
D	Fluorocarbon resin	19 9	150 °C; 3 min (CO) 170 °C; 3 min (PES)
E	Fluorocarbon resin	22	150 °C; 3 min (PES)
G	Various. Fluorocarbon resins (same producer)	13; 15; 5; 7 22; 8; 13; 37	170 °C; 4 min (CO) 190 °C; 1.5 min (PES)
H	Paraffin, inorganic salt	43	120 °C; 2 min (CO)
I	Paraffin, Zr-salt	15	150 °C; 4 min (CO)
K	Paraffin	29	170 °C; 3 min (CO)
L	Polysiloxane	37	150 °C; 3 min (CO)
M	Polyurethane derivative	25	170 °C; 3 min (CO)
N	Melamine derivative	19; formaldehyde: 2 g/kg	140 °C; 4 min (CO)

Table 10: Substance specific emission factors to air of repellents

	Active ingredients	Organic-C (g/kg)	Testing conditions Curing temperature (°C); Curing time (min); Substrate
A	Paraffin, polyethylene	75	190 °C; 1.5 min (PES)
B	Fatty acid ester	13	170 °C; 4 min (CO)
C	Wax	67	190 °C; 1.5 min (PS)
D	Paraffin	79	190 °C; 1.5 min (PES)
E	Wax	172	190 °C; 1.5 min (PES)
F	Fatty acid derivative	5	170 °C; 1.5 min (CO)
G	Fatty acid derivative	2	140 °C; 2 min (CO)
H	Fatty acid derivative	3	190 °C; 1.5 min (PES)

Table 11: Substance specific emission factors to air of conditioning agents

	Active ingredients	Organic-C (g/kg)	Testing conditions Curing temperature (°C); Curing time (min); Substrate
A	Diaminostilbene disulphonic acid	2	170 °C; 3 min (BW)
B	Pyrazoline derivative	32	190 °C; 1.5 min (PES)
C	Diaminostilbene disulphonic acid	3	170 °C; 3 min (BW)
D	Benzoxazol derivative	2	190 °C; 1.5 min (PS)
E	Distyrylbenzene derivitive	18	190 °C; 1.5 min (PS)
F	Pyrene and oxazol derivatives	22	190 °C; 1.5 min (PS)
G	Benzoxazol derivative	11	190 °C; 1.5 min (PS)

Table 12: Substance specific emission factors to air of optical brighteners

	Active ingredients	Organic-C (g/kg)	Testing conditions Curing temperature (°C); Curing time (min); Substrate
A	Org. salt	72	150 °C; 3 min (PES)
B	Alkylphosphate	27	190 °C; 1.5 min (PES)
C	Polyglykolether	7	150 °C; 3 min (PES)
D	Org. P-compound	14	170 °C; 1 min (PES)
E	Quaternary ammonium compound	4	190 °C; 1.5 min (PES)
F	Alkylphosphate	5	190 °C; 1.5 min (PES)
G	Quaternary ammonium compound	24	190 °C; 1.5 min (PES)

Table 13: Substance specific emission factors to air of anti-electrostatic agents

	Active ingredients	Organic-C (g/kg)	Testing conditions Curing temperature (°C); Curing time (min); Substrate
A	Polyvinyl alcohol	3	170 °C; 1.5 min (CO)
B	Starch derivative	1	160 °C; 4 min (CO)
C	Polyacrylate	2	170 °C; 1.5 min (CO)

Table 14: Substance specific emission factors to air of filling and stiffening agents

	Active ingredients	Organic-C (g/kg)	Testing conditions Curing temperature (°C); Curing time (min); Substrate
A	Quaternary ammonia compound	3	170 °C; 1.5 min (CO)
B	Quaternary ammonia compound	3	170 °C; 4 min (CO)
C	Quaternary ammonia compound	< 1	180 °C; 1 min (CO)
C	Quaternary ammonia compound	17	190 °C; 1.5 min (PES)

Table 15: Substance specific emission factors to air of after-treatment agents for fastness improvement

	Active ingredients	Organic-C (g/kg)	Testing conditions Curing temperature (°C); Curing time (min); Substrate
A	Heterocyclic ompounds	5	170 °C; 4 min (CO)
B	Aromatic compounds	47 241	170 °C; 4 min (CO) 190 °C; 1.5 min (PES)
C	Isothiazolinone	55	190 °C; 1.5 min (PES)
D	Isothiazolinone	46 302	170 °C; 4 min (CO) 190 °C; 1 min (pES)

Table 16: Substance specific emission factors to air of antimicrobionics

	Active ingredients	Organic-C (g/kg)	Testing conditions Curing temperature (°C); Curing time (min); Substrate
A	Silicic acid	0.6 3.7	100 °C; 0.5 min (CO) 170 °C; 3 min (PES)
B	Silicic acid	1.3 2.8	170 °C; 3 min (CO) 170 °C; 1.5 min (PES)

Table 17: Substance specific emission factors to air of non-slip, ladder-proof agents

12 ANNEX V: TYPICAL POLLUTANTS (AND POTENTIAL SOURCES) IN AIR EMISSIONS FROM TEXTILE PROCESSES

Substance	Possible Source
Aliphatic hydrocarbons (C1-C40)	Preparation agents, wetting agents, printing
Aromatic hydrocarbons	Carriers, Machine cleaning
Ketones	Various products
Alcohols (low molecular)	Various products
Esters (low molecular)	Various products
Siloxanes	Softening agents
Carboxylic acids (e.g. acetic acid)	pH-adjustment
Fatty acids	By-product in surfactants
Fatty alcohols	By-product in surfactants
Fatty esters	By-product in surfactants
Fatty amines	By-product in surfactants
Aminoalcohols	By-product in surfactants
Dioles, polyoles	By-product in surfactants
Glycolether	By-product in surfactants
Aliphatic, aromatic ethers	Various products

Table 1: Chemical compounds with less dangerous properties which may be present in waste gas [179, UBA, 2001]

Substance	Possible source
Acetaldehyde	Polyvinylacetate, acetic acid
Acroleine	Decomposition of glycerol
Acrylates (methyl, ethyl, butyl)	Coating agents and binders for non-wovens
Acrylic acid	Polymers, thickeners
Aliphatic amines	Polymers (esp. polyurethanes)
Ammonia	Foaming agents, thickeners
2- aminoethanol	Wetting agents, softeners
Benzylalcohol	Carriers
Biphenyl	Carriers
Bis (2-aminoethyl)-1,2-ethanediamine, N, N	Softeners
Butine-1,4 diol	Fluorocarbon resins
Caprolactam	Polyamide 6 powder/textiles
Chloromethane (methylchloride)	Quaternary ammonium compounds
Chlorinated aromatic hydrocarbons	Carriers
Chloroethanol	Decomposition of flameretardants (chlorinated P-ester)
Chloroparaffins	Flame-retardants
Dichloroethene	Polyvinylidenechloride
Dichloromethane	Solvent cleaning
Diethylenetriamine	Softeners
Di(ethylhexyl)phthalate	Dyeing auxiliaries/polymerdispersinons
Diglycidylether	Epoxide resins
Diisocyanatetoluene, 2,4-	Fluorocarbon resin-extender
Diisocyanatetoluene, 2,6-	Fluorocarbon resin-extender
N,N-dimethylacetamide	Fibre solvent (polyamide 6.6, metaramide)
Dimethylethylamine, 1,1-	Rare
Dioxane, 1,4-	Surfactants (ethoxilate)
Diphenylmethane-2,4 diisocyanate	Extender, polyurethanes
Diphenylmethane-4,4' diisocyanate	Extender, polyurethanes
Dipropylenetriamine	Softeners
Epoxy-1-propanol, 2,3-	Some antistatics
Acetic acid-(2-ethoxyethyl)-ester	Softeners/fluorocarbon resins
Ethoxyethanol	Softeners/fluorocarbon resins
Ethanedialdehyde (glyoxal)	Crosslinkers

Substance	Possible source
Ethylenediamine	Softeners
Fluoroorrganics, low molecular	Fluorocarbon resins
Formaldehyde	Crosslinkers, conservation agent, stenter off-gas
Formic acid	Various recipes
Hexamethylenediamine	Polycondensationproducts
Hexamethylenediisocyanate	Fluorocarbon resins, polyurethane
Hexanone, 2-	Fluorocarbon resins
Hydrogen chloride	Catalyst
Isocyanatomethyl-3,5,5-trimethylcyclohexyl-Isocyanate,3	Fluorocarbon resins, polyurethane
Methoxy-1-propanol, 2-	Rare
Methoxypropylacetate	Rare
Monochloroacetic acid, Na-salt	Rare
Monochloroacetic acid, 1-methylethylester	Rare
Monochloroacetic acid, ethylester	Rare
Monochloroacetic acid, methylester	Rare
N-alkylmorpholine	Non wovens coating
Sodiumtrichloroacetate	Rare
Oxalic acid	Bleaching auxiliary
Tetrachloroethene	Dry cleaning
Thiourea	Dyeing auxiliary
Trichloroacetic acid	Rare
Triethylamine	Special crosslinkers
Trikresylphosphate (ooo, oom, oop, omm, omp, opp)	Flame-retardants
Trimethylphosphate	Flame-retardants
tin derivatives, organic, inorganic	Fluorocarbon resins, Hydrophobing agents biocides
Vinylacetate	Polyvinylacetate

Table 2: Substances with more dangerous properties which may be present in waste gas [179, UBA, 2001]

Substance	Possible source
Polycyclic aromatic hydrocarbons	Crackproducts in off-gass (very low)
PCDD/PCDF (Br, Cl, F)	Crackproducts in off-gass (very low)
Bischloromethylether	Strongest synthetic carcinogenic, spontaneous formation when working with formaldehyde and hydrogenchloride (very low)
Arsenictrioxide/antimonytrioxide	Flame-retardants
Dimethylsulphate	Quaternary ammonium compounds
Ethylenimine	Flame-retardants
Acrylonitrile	Polymer dispersions
1,3-butadiene	Polymer dispersions
2-vinylcyclohexen	Polymer dispersions
Epichlorohydrine	Polycondensation products
1,2-epoxypropane (propyleneoxide)	Surfactants (propoxilate)
Ethyleneoxide	Surfactants (ethoxilate)
Vinylchloride	Polymer dispersions (PVC)
Acrylamide	Reactive polymers, flame-retardants
Butanoneoxime	Fluorocarbon resins, polyurethanes
Pentachlorophenol	Pesticide
Propyleneimine	Flame-retardant and polyurethane crosslinker
N-vinylpyrrolidon	Polyvinylpyrrolidone dispersions

Table 3: Substances with cancerogenic properties which may be present in waste gas [179, UBA, 2001]

13 ANNEX VI: AUXILIARIES CLASSIFICATION TOOLS

13.1 Tegewa scheme

The "Method of classification of textile auxiliaries according to their waste water relevance" provides a logic system for the classification of textile auxiliaries in 3 classes of relevance:

Class I	Minor relevance to waste water
Class II	Relevant to waste water
Class III	High relevance to waste water

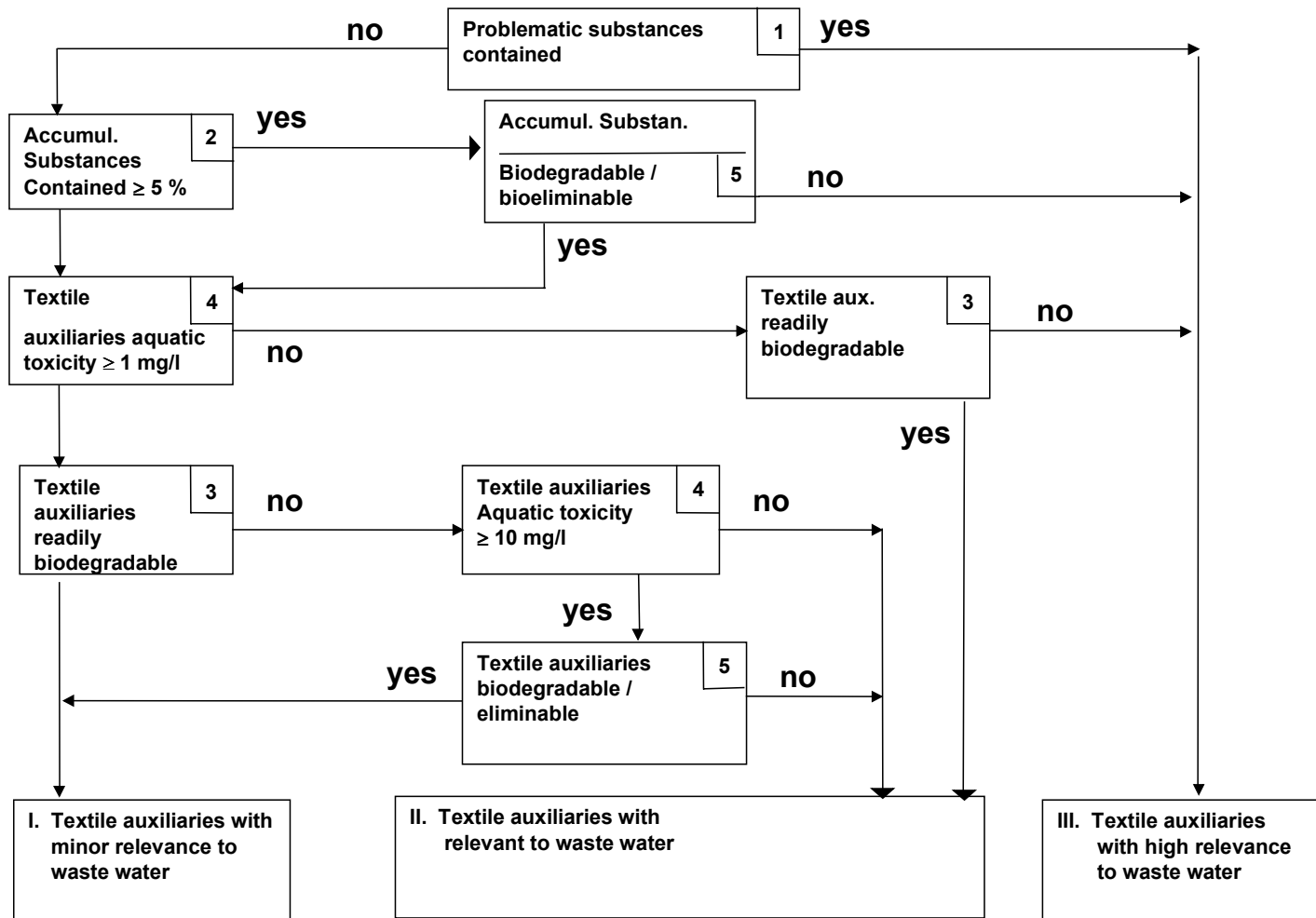
The main criteria for the classification are the content of certain harmful (including bioaccumulative) substances, biological degradation or elimination and aquatic toxicity of the sold products (see scheme on next page).

The introduction of the classification concept rests essentially on the following pillars:

- Classification by producers on their own responsibility, guided by the association of textile auxiliaries suppliers, called TEGEWA (TEGEWA = Verband der TExtilhilfsmittel-, Lederhilfsmittel-, GERbstoff- und WAschrohstoff-Industrie e.V., D-60329 Frankfurt)
- Screening of correct classification of textile auxiliaries in the three classes by an expert.
- A monitoring report on the effectiveness of the voluntary commitment which will be communicated to the authorities. For this purpose numbers and quantities of textile auxiliaries classified in classes I, II and III and sold in Europe are collected by a neutral consultant from the manufacturers.
- The triggering of market mechanisms towards the development of environmentally sounder products.

It is not claimed that the classification concept allows a differentiated ecotoxicological evaluation of textile auxiliaries. The purpose of the classification concept is rather to allow users to select textile auxiliaries also from ecological aspects. Ecological competition is intended to trigger a trend towards the development of environmentally more compatible textile auxiliaries. The German Association of the Textile Finishing Industry (TVI-Verband, D-Eschborn) is officially supporting this concept and has signed and published a self-commitment to recommend the textile finishing industries to use classified products only and preferably such of classes I and II ("TVI-Verband, 1997").

A classification of the textile auxiliary is possible both on the basis of data of the preparation and on the basis of data of the ingredients by calculating mean values for the ingredients. For data to be newly determined, it is recommended to determine those data on the basis of the ingredients.



Footnotes mentioned in the classification scheme:

1. Problematic substances are
 - 1.1 CMR substances which are - according to Annex I to Directive 67/548/EEC -
 - classified as "carcinogenic" cat. 1 or cat. 2 and labelled with R45 (May cause cancer) or R49 (May cause cancer by inhalation),
 - classified as "mutagenic" cat. 1 or cat. 2 and labelled with R46 (May cause heritable genetic damage) or R60 (May impair fertility),
 - classified as "toxic for reproduction" cat. 1 or cat. 2 and labelled with R61 (May cause harm to the unborn child).
 - 1.2 Ingredients which have an aquatic toxicity (definition see footnote 4) of < 0.1 mg/l and are not readily biodegradable (definition see footnote 3),
 - 1.3 Low-molecular halogen hydrocarbons (halogen share > 5 %, chain length C1 - C12),
 - 1.4 Arsenic and arsenic compounds,
 - 1.5 Lead and lead compounds,
 - 1.6 Cadmium and cadmium compounds,
 - 1.7 Tri- and tetra-organotin compounds,
 - 1.8 Mercury and mercury compounds,
 - 1.9 APEO,
 - 1.10 EDTA, DTPA.
2. In connection with classifications made within this voluntary commitment, substances shall be considered "accumulative" which are labelled either with R-phrase 53 "May cause long-term adverse effects in the aquatic environment" alone, or with R53 in combination with other R-phrases.
3. Readily biodegradable = OECD tests 301 A-F with > 60 % BOD/COD or CO₂ formation, respectively, or > 70 % DOC reduction in 28 days.
4. Aquatic toxicity of textile auxiliaries = LC 50 daphnia (if not available to be substituted by fish).
5. Biodegradable/eliminable = OECD test 302 B: > 70 % DOC reduction in 28 days, or OECD test 302 C: > 60 % O₂ consumption, or Proof of a > 70 % reduction in precipitation typical of sewage treatment plants.

Note:

For textile auxiliaries the evaluation "readily biodegradable (3)", "aquatic toxicity" (4), and "biodegradable/bioeliminable" (5) can be made not only on the basis of test data of the ready-for-use preparation but also on the basis of valid data obtained by calculating mean values for the various ingredients.

13.2 SCORE System

1. SUMMARY

The score system is an administrative method of sorting chemicals on the basis of information especially from the chemical supplier's specification sheets. The sorting permits a priority selection of chemicals which, because of actual consumption and information on environmental behaviour, should be subject to closer examination.

The score system is based on the parameters usually considered to be the most interesting in connection with characterisation of substances injurious to the environment of industrial sewage. The parameter A is a score on the estimated amount of chemical, which is discharged into the environment as waste water. B is a score on biodegradability, and C is a score on bioaccumulation. The structure of the score system appears from the table in Chapter 2.

Together, A, B and C indicate the potential presence of the substance in the environment; (exposure); how much of, how long and how is the substance present in the aquatic environment. A influences the effect of B and C, while B influences the effect of C. The total score, which is obtained by multiplying the score for A, B and C, is called the exposure score.

Effects of chemical exposure depend on the toxicity of the chemical. The toxicity (D) should be evaluated concurrently in proportion to the exposure.

Each parameter is given a numerical value between 1 and 4 with 4 indicating the most critical environmental impact. Missing information involves highest score. The result is that each substance can be given a score as to exposure ($A \times B \times C$), and independent of this, a score as to toxicity (D). Subsequently, it will be possible to make a ranking of the chemicals.

Application of the system implies that the system is worked into the waste water permits or environmental approvals of the companies. Hereafter, the companies should send in information on consumption of chemicals as well as environmental data. The first time, information on all chemicals employed should be submitted, but following, reporting of new chemicals may take place concurrently with the employment of these. At least once a year, the statement of consumption should be updated.

The Federation of Danish Textile and Clothing Industries is prepared to act as "consultant" for the individual companies, and it has established a data base management system for storing of information on chemicals and calculation of score. By means of the data base facilities, it will thus be possible to print out a list of the employed chemicals and the calculated score (a Score Report) specifically for each company. This list could subsequently be supplemented with a detailed analysis of the chemicals, which were given a high score.

The information now available should form the basis of the environmental authority's (municipality/county) evaluation as to possible "interventions".

2. DESCRIPTION OF THE SCORE SYSTEM

The score system is an administrative method of sorting chemicals on the basis of information especially from the chemical supplier's specification sheets. The sorting permits a priority selection of those chemicals, which should be subject to closer examination because of actual consumption and environmental behaviour.

The score system is based on the parameters usually considered to be the most interesting in connection with characterisation of substances injurious to the environment of industrial sewage.

-
- A** Discharged amount of substance
 - B** Biodegradability
 - C** Bioaccumulation
 - D** Toxicity

A-score is based on estimated amount of chemical, which is discharged into environment as waste water. B-score is based on biodegradability and C-score on bioaccumulation.

Together the parameters A, B and C indicate the potential presence of the substance (*exposure*) in the environment; how much of, how long and where is the substance present in the aquatic environment. A influences the effect of B and C, while B influences the effect of C. Thus,

exposure score is obtained by multiplying A, B and C.

The effect of presence of a substance in the environment depends on its toxicity (D). The **toxicity score** should be evaluated concurrently and independently in proportion to the exposure score.

The exposure score (AxBxC) and toxicity score (D) are estimated for each chemical. Subsequently it will be possible to make a ranking of the chemicals.

How to use the score system?

On basis of information from especially the chemical supplier's specification sheets each parameter is given a numerical value between 1 and 4 with 4 indicating the most critical environmental impact. Missing information involves highest score.

It is advisable that the data used as score basis have been obtained according to internationally approved methods of examination.

Within the parameters B and C and D, data on different levels are used. The highest level represents data generated on basis of examination conditions, which are most comparable with a natural aquatic environment. As regards the parameter C, data obtained from standardised bioaccumulation tests with fish are thus more realistic than data from examinations based on determination of the distribution of the substance in a two-phased mixture of octanol and water (Pow -data). However, Pow has a more direct correlation with bioaccumulation than solubility data.

EXPOSURE SCORE (AxBxC)

SCORE FIGURE:	1	2	3	4
PARAMETER				
A Discharged amount of substance				
kg/week	< 1	1 - 10	> 10 - 100	> 100
kg/year	< 50	50 - 500	> 500 - 5000	> 5000
B Biodegradability				
Surface water (%)	> 60(50 - 100)	10 - 60	< 10	< 20
Sludge culture (%)		> 70	20 - 70	< 20
BOD/COD ratio		> 0.5		≤ 0.5
C Bioaccumulation				
Bioconcentration Factor (BCF) Or C1, C2, C3	< 100			≥ 100
C1 if MW > 1000 g/mol	*			
C2 if 500 = or <MW = or < 1000 g/mol				
Pow data	< 1000	≥ 1000		
Water solubility g/litre	> 10	10 - 2	< 2	
C3 if MW < 500 g/mol				
Pow data	< 1000			≥ 1000
Water solubility g/litre	> 100	100 - 2	< 2 - 0.02	< 0.02
No information				*

TOXICITY SCORE (D)

SCORE FIGURE:	1	2	3	4
PARAMETER				
D Effect concentration divided by effluent concentration	> 1000	1000 - 101	100 - 10	< 10
No information				*

Implementation

Application of the system implies that the system is worked into the waste water permits or environmental approvals of the companies. Hereafter the companies should send in information on consumption of chemicals as well as environmental data. The first time, information on all chemicals employed should be submitted, but following, reporting of new chemicals may take place concurrently with the employment of these. At least once a year, the statement of consumption should be updated.

The *Federation of Danish Textile and Clothing* is prepared to act as "consultant" for the individual companies, and it has established a data base management system for storing of information on chemicals and calculation of score. By means of the data base facilities, it will thus be possible to print out a list of the employed chemicals and the calculated score (a *Score Report*) specifically for each company. This list could subsequently be supplemented with a detailed analysis of the chemicals, which were given a high score.

The Score Report forms the basis of the environmental authority's (municipality and county) dialog with the companies and evaluation as to possible interventions.

Information

The Score System is worked out by a working group representing the municipalities in Ringkøbing County, Ringkøbing County and Federation of Danish Textile and Clothing in Denmark.

The Score System was implemented in 1992 in Ringkøbing County, it was worked into the waste water permits or environmental approvals of the companies. The reader is wellcome to contact Ringkøbing County, Damstræde 2, 6950 Ringkøbing, Denmark for further information about the system and experiences from the use of the system.

Information including The Compendium with Guidelines to the Sorting System for sorting af Chemicals can also be found on the web site.

13.3 Dutch General Policy Scheme

Summary

The lead-up to the grant of a permit under the Dutch Pollution of Surface Waters Act comprises three phases: information provision, establishing measures to be taken to control emissions, and assessing any residual emissions. The assessment of substances and preparations relates mainly to the 'information provision' phase. However, the data required to assess a substance or preparation are equally relevant to the assessment of residual emissions (immission assessment). The implementation of the Pollution of Surface Waters Act demands an understanding of the toxicity of individual substances and preparations to the aquatic environment.

This report describes both the general method of assessment and the procedure for informing the competent authority (via the user) of the water toxicity of individual substances and preparations. The general method of assessment is designed to apply to direct and indirect discharges under the Pollution of Surface Waters Act, but can also be used to assess substances and preparations involved in indirect discharges falling under the Environmental Protection Act. The method employs parameters and criteria which comply with European regulations regarding the classification and characteristics of substances and preparations, but couples to the properties of substances a set level of effort to limit pollution at source. The method can be used wherever it is necessary to determine the water toxicity of substances and preparations.

This means that companies can use it if they need to supply information on substances and preparations to competent authorities in relation to permit or licence applications under the two aforementioned Acts or, for example, to demonstrate that a decision to use a particular substance or preparation will contribute to the on-going reduction of pressure on the environment.

It should be remembered that the general assessment method is a means of using various properties of substances to categorise them with regard to their toxicity to the aquatic environment. It will not indicate what measures should be taken in a specific case to prevent or reduce emissions. Nor can it be used to assess residual emissions.

With regard to the procedure, it should be stressed that responsibility for supplying information to the competent authority still lies with the applicant for a permit or licence under the relevant Acts. This is a blanket rule and therefore also applies to information about any basic or auxiliary substance, and any intermediate or final product which may find its way into waste water.

However, producers wishing to preserve confidentiality regarding the composition of their preparations do not always provide complete information to users. This means that users are in turn unable to pass it on to the competent authority.

For this reason, and for the sake of efficiency, producers are expected to use the general method of assessment to assess substances and preparations and to supply wholesalers and users with the results of the assessment, together with information about the relevant substances and preparations. The procedure is in line with the widely supported programmes of 'responsible care' and 'product stewardship' within the chemical industry. The private sector is launching international programmes to identify the missing data necessary for the assessment of the toxicity of a large number of substances.

The procedure described in this report can be used to resolve the dilemma between the need of applicants for permits under the Pollution of Surface Waters Act to supply information on the toxicity of preparations and the desire of producers to protect information on the composition of their preparations. The description of the procedure is accompanied by a discussion of possible means of monitoring and enforcement.

In addition to describing the general method of assessment and the procedure, the report focuses on points relevant to their application. It ends with conclusions and recommendations.

1 Procedure

Assessment of substances and preparations within the context of the implementation of the water discharge policy.

This chapter deals with the procedure for providing the authorities with information about substances and preparations by means of the user.

Key issues are the information that must be provided, the verifiability of this information and the enforceability of the procedure.

1.1 Introduction

The Pollution of Surface Waters Act prescribes that anyone applying for a permit under this act is obliged to provide information to enable the competent authorities to review the application. This obligation also applies to information about raw and auxiliary materials and partly processed and finished products that are used by companies and may be discharged into the surface water. Due to the confidentiality of information about the composition of preparations, producers and suppliers are not always willing to provide this information. In this situation, the customer does not have the exact information. A request to observe secrecy with regard to part of the permit applications by the user does not solve this problem, because in the confidential section of the application the water quality manager cannot be provided with any information about the preparation.

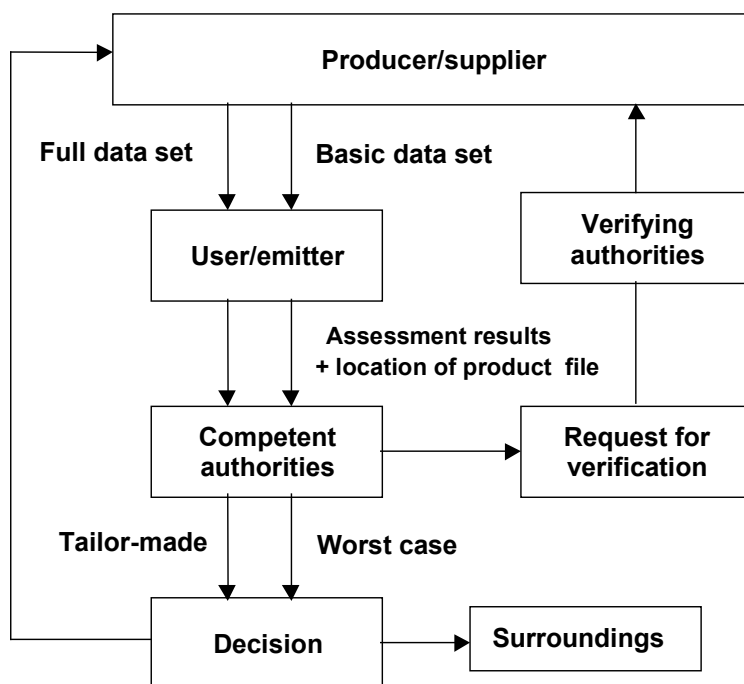
To solve this bottleneck, a procedure has been designed to help users, authorities and third parties to gain sufficient insight into the aquatic harmfulness of a substance or preparation, while guaranteeing the confidentiality of the information vis-à-vis the producer or supplier.

Producers and suppliers of substances and preparations play an important part in the provision of information and the assessment of substances and preparations in accordance with the GAM. The working group dealing with the effects on the market of the deregulation of legislation concerning permits granted under the Pollution of Surface Waters Act has recommended to encourage that in consultation with the corporate sector a system is set up within certain branches, which will make all standard information about raw and auxiliary materials relating to the permit-application procedure accessible to all parties involved. This working group has proposed to link up with the initiatives taken by the Integrated Water Management Committee. The Dutch cabinet has adopted this recommendation.

1.2 Procedure

Producers of substances and preparations play an important part in the procedure. In fact, if there are any details available about substances and preparations, it is most likely the producers who have this information. Besides, it is not efficient to have numerous users collect the data of properties of the same substances and preparations. The most obvious approach is to have the producer/supplier collect the data and assess the substances. This is in line with Directive 86/609/EEC, which deals with the protection of animals used for experimental and other scientific purposes. The procedure distinguishes between the submission of a basic set³ and a full set of information about substances and preparations.

The following figure represents the proposed procedure in diagram form.



1.2.1 Full data set

The full data set for assessing substances and preparations contains the answers to the questions below, plus the results of the assessment. This information must be made available through the commercial chain to the user, who can pass this on to the authorities dealing with the permits.

Substances

The details of each substance required to carry out the GAM are:

- Is the substance carcinogenic (R-45), insofar as is known?
- Is the substance mutagenic (R-46), insofar as is known?
- What is the acute toxicity to water organisms (LC50), preferably for four trophic levels, but in any case for crustaceans or fish.
- What is the degree of biodegradability?
- What is the Log Pow?
- What is the BCF? (optional)
- What is the water solubility if the acute toxicity to water organisms cannot be determined.

Preparations

For preparations, the results of the GAM must be given, as well as the exact composition of the preparation and information about the substances of each component.

! Basic set should not be confused with Base-set according to Annex 7 of the Substances Directive. Assessment of substances and preparations within the context of the implementation of the water discharge policy

1.2.2 Basic data set

Producers may provide only a basic set of information about substances or the composition of a preparation, if the substance or preparation is assessed in accordance with the GAM.

Substances

If the producer/supplier assesses the substance and provides only a basic set of information, then it is in principle enough to indicate its aquatic harmfulness and the place at which the substance file is available for inspection by the (verifying) authorities. In this case, the authorities will apply a worst-case approach to the water quality test (i.e. assessment of residual discharge after introduction of btm/bpm), based on the most harmful properties that have resulted to this category. In other words: if a substance falls into category {6} of aquatic harmfulness according to the GAM, it is assumed that the substance has an acute toxicity to water organisms of 1 mg/l and is persistent. If this results in additional decontamination measures, then a more accurate water quality test may be carried out if the producer provides more exact data about the properties of the substance.

Preparations

In principle, users must be provided with the following basic data set for preparations:

- results of assessment of the preparation in accordance with the GAM
- components in the category of aquatic harmfulness of 'black-list substance, may cause hereditary damage and/or cancer', as well as the rough quantities of the components that make up the preparation
- components with abatement effort A and the rough quantities of these components in the preparation
- the place at which the product file is available for inspection by the (verifying) authorities.

The exact composition of the preparation is only known to the producer or supplier.

In the case of preparations, too, the authorities will base the water quality test on the most harmful properties, which have led to the category of aquatic harmfulness, if the producer fails to state the exact composition.

If this results in additional measures, then the producer may ensure that a more accurate water quality test is carried out by providing more exact data about the composition of the preparation.

1.3 Verifiability

To assess substances and preparations, information is necessary. But it is impossible to verify whether all the information provided is correct.

Users and authorities must be able to trust that the assessment is based on the correct information and that the assessment itself has been carried out correctly. Those who carry out the assessment, the producers of substances and preparations, are responsible for this. The details of properties of substances may be determined by or under the authority of the producer.

For many existing substances, the information stored in databases may be used. In both cases, the details are preferably verified by certified laboratories (Good Laboratory Practice) in accordance with standardised methods. Any information about properties or substances that may have been assessed before standard test methods and the GLP came into force, may be used if valid conclusions can be drawn on the basis of this information. This is dealt with by the technical guidelines in Directive 93/67/EEC and Regulation 1488/94 for risk assessment of new and existing substances.

To reduce the risk of errors in the assessment, a software application has been made of the GAM. However, both the corporate sector and the government value a form of verification, which may be carried out in various ways.

1.3.1 Verification by authorities

In case of doubt (but also simply as a random test), the authorities must be able to verify whether the information provided is correct and whether the assessment is carried out correctly. It is proposed to use the same procedure as that used in the verification of information for the assessment of effects on humans and the environment. In other words, the authorities (for example, in the shape of the Inspectorate for the Environment) will be permitted to inspect the product file, at their request. Of course, the user and the authorities must know by whom and where the product file is kept. This file must also contain the information that has been used for the assessment of preparations.

1.3.2 Verification by the corporate sector

Apart from the authorities, the corporate sector may organise the verification themselves. For example, an independent, certified body may be designated to carry out or verify the assessment. The assessment may also form part of a section of the business operations that may be certified. This means that in environmental audits within the scope of the certification, the auditor will then verify whether the assessment has been carried out correctly. But the protocols for this will have to be set up first.

1.3.3 Product liability

Apart from this, the producer is at all times responsible for the correctness of information provided. On the other hand, the customer must also verify whether the information is correct, for example, by comparing the properties to those of other products. In this way, the user of a hazardous product that has been incorrectly categorised by the producer may prevent the incorrect use of the product.

However, if the user of a product has been misled by its supplier and the user could not reasonably have known this, then the producer can be held liable. According to criminal law, the user will always be liable. But based on product liability, the user is able to recover any damage from the producer in civil proceedings.

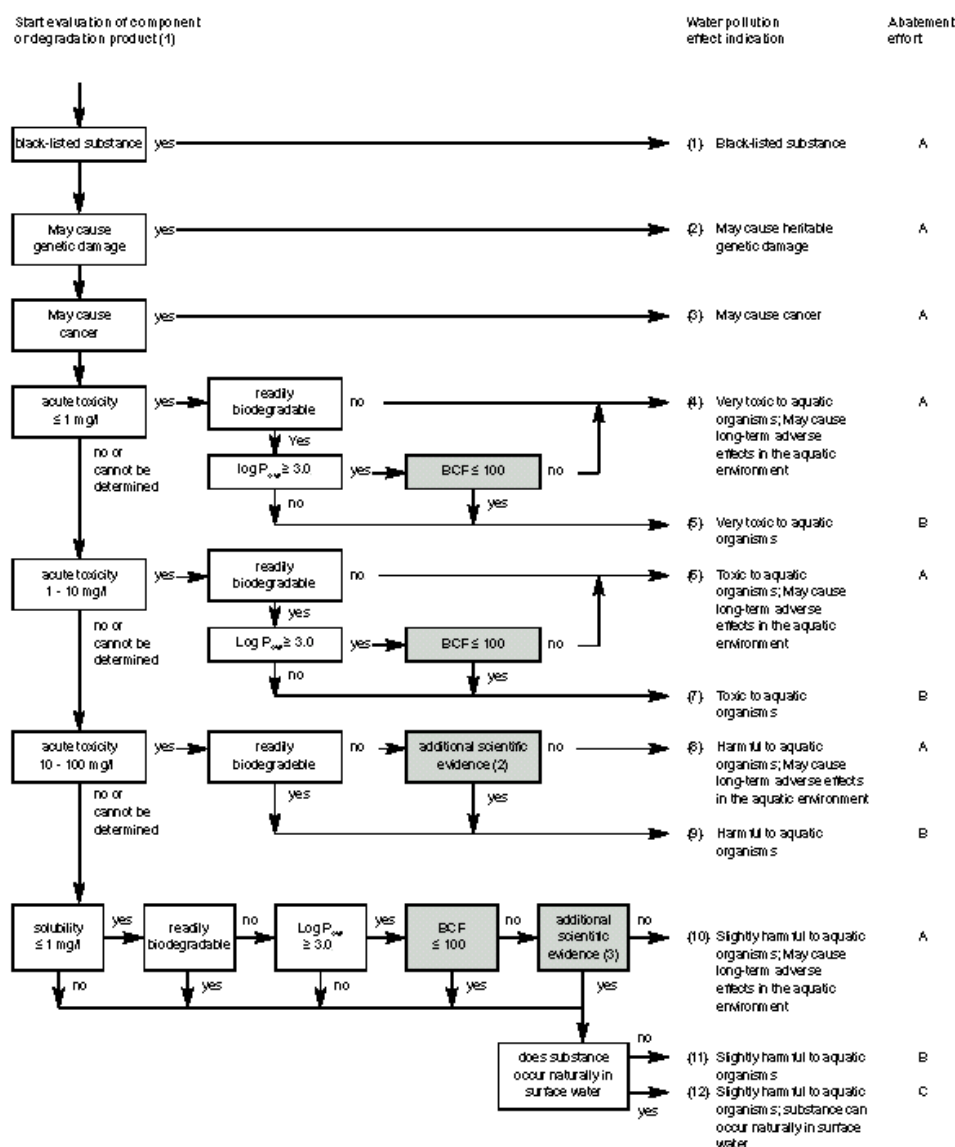
In the Netherlands, the Environment Inspectorate verifies whether the information provided is correct. If misleading information has been provided, steps can be taken. The EU member countries have entered into agreements in the event that companies from EU countries are involved.

1.4 Enforceability

In the permit-application procedure, the information provided must be verified; usually, the body that grants the permits (competent authorities) verifies the information itself. After that, the manner in which the permit is formulated determines its enforceability. For example, the wording of the conditions must provide clear legal grounds to allow for measures to be taken if other substances are discharged than those mentioned in the permit. In enforcing the permit conditions, special attention may be paid, for instance, to the availability of information about raw and auxiliary materials, as well as partly processed and finished products that are used by a company and may be discharged into the waste water.

Enforcers also ought to be alert if the permit allows the holder, for example, to change any raw or auxiliary materials, provided that the authorities are notified, whether in advance or afterwards.

Table B-4.1
Hazard identification test for substances



(1) If research and/or the literature indicates that the degradation products of a substance are harmful, these products must also be subjected to a hazard identification test.

(2) If a substance degradation product does not present a potential long-term and/or delayed danger to the aquatic environment, classification abatement effort A can decay. The additional scientific evidence can comprise the following studies:

1) proof of rapid biodegradation in an aquatic environment;

1) no chronic toxicity effects at a concentration of 1 mg/l.
(See also notes to additional scientific evidence)

(3) See 2, on the understanding that there must be no chronic toxicity effects at the solubility limit instead of 1 mg/l.
(See also notes to additional scientific evidence)

Facultative test, if data lacking follow 'no' route

Abatement effort A: approach as for black-listed substances or substances with comparable characteristics.
Abatement effort B: approach as for relatively hazardous substances.
Abatement effort C: approach as for relatively harmless substances.

Table B-5.1
General Assessment Methodology for preparations

Category of substance	Classification of preparation (category of aquatic harmfulness and decontamination effort)											
	Contains black-list substance	Mutagenic	Carcinogenic	Very toxic to aquatic organisms: contains substances that are harmful to the aquatic environment	Very toxic to aquatic organisms	Toxic to aquatic organisms: contains substances that are harmful to the aquatic environment	Toxic to aquatic organisms	Harmful to aquatic organisms: contains substances that are harmful to the aquatic environment	Harmful to aquatic organisms	Slightly harmful to aquatic organisms: contains substances that are harmful to the aquatic environment	Slightly harmful to aquatic organisms	Slightly harmful to aquatic organisms: contains substances occurring naturally in surface waters
	A	A	A	A	B	A	B	A	B	A	B	C
(1) Black-list substance	≥ 0,1%										< 0,1	
(2) May cause heritable genetic damage		≥ 0,1%										< 0,1
(3) May cause cancer			≥ 0,1%									< 0,1
(4) Very toxic to aquatic organisms; may cause long-term adverse effects in the aquatic environment				≥ 25%		2,5 ≤ conc < 25%		0,25 ≤ conc < 2,5%				< 0,25%
(5) Very toxic to aquatic organisms (in combination with #4)				≥ 25%		2,5 ≤ conc < 25%		0,25 ≤ conc < 2,5%				< 0,25%
(6) Toxic to aquatic organisms; may cause long-term adverse effects in the aquatic environment (in combination with (4))					≥ 25%		2,5 ≤ conc < 25%					< 2,5%
(7) Toxic to aquatic organisms (in combination with (4), (5) and (6))						≥ 25%		2,5 ≤ conc < 25%				< 2,5%
(8) Harmful to aquatic organisms; may cause long-term adverse effects in the aquatic environment (in combination with (4) and (6))							≥ 25%					< 25%
(9) Harmful to aquatic organisms (in combination with #1, (5), (6), (7) and (8))								≥ 25%				< 25%
(10) Slightly harmful to aquatic organisms; may cause long-term adverse effects in the aquatic environment (in combination with (4), (6) and (8))									≥ 25%			< 25%
(11) Slightly harmful to aquatic organisms											≥ 1%	
(12) Slightly harmful to aquatic organisms; natural occurrence in surface water												100%

14 ADVANCED OXIDATION PROCESSES (FENTON REACTION)

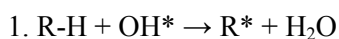
The Fenton reaction involves an advanced oxidation process. Advanced oxidation processes (which are a particular case of chemical oxidation processes) are oxidation processes that produce active oxygen species that react as powerful and clean oxidants.

The Fenton process is based on the redox oxidation of hydrogen peroxide to produce the OH* radical. Other methods to produce the OH* radical from H₂O₂ are for example H₂O₂ and UV, ozone/ H₂O₂ and ozone/UV.

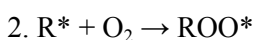
The Fenton reaction is based on H₂O₂ and Fe²⁺ at pH 3. At pH 3, the first hydrolysed form of ferric ion (Fe(OH)⁺⁺) is in equilibrium with water, thereby controlling the rate of production of free OH* radical from the decomposition of H₂O₂.

There is evidence from recent research in advanced oxidation processes to assume the following pathway: Fe²⁺ + HO-OH → Fe(OH)⁺⁺ + OH*.

In the absence of organics the generated OH* radical slowly further reacts consuming hydrogen peroxide. However, in the presence of organics (R-H) the following reaction takes place:



Organic radicals are formed that react further by complex chain mechanisms or become terminated by deactivation and radical-radical combination. This process may occur in the absence or presence of oxygen gas (O₂). In the presence of oxygen gas, the alkyl radicals (R*) produced by advanced oxidation, react very rapidly and the formation of the peroxy radical occurs:



(Ground state molecular oxygen is consumed instead of the oxygen from the more expensive hydrogen peroxide).

The peroxy radical may or may not be stable (which can slow down the oxidation process). In any case, oxygen is chemically introduced into the organic molecule and thus consumed, leading to the oxidation of organic molecules to more hydrophilic and usually more biodegradable intermediates. This is known as a clean route (unlike chlorination where chlorine atoms are introduced into the organic molecule).

The OH* radical is (after fluorine) the most powerful oxidant in nature and reacts in an aspecific way with any substance containing at least one hydrogen atom.

With the Fenton reaction there is no risk of an accumulation of oxygen. Therefore potentially dangerous reactions in the presence of VOCs cannot occur. Moreover as the H₂O₂ is present in very low concentrations (about 0.1 %) it should never be possible to reach explosive mixtures. On the contrary O₂ is consumed by the reaction in the above-mentioned conditions.

It was stated earlier that OH* is a very powerful oxidant. However, there are some dyes or groups that react more slowly than other groups (e.g. anthraquinone dyes react 100 times more slowly than azo dyes because the product of the degradation is regenerated into the original one). However, what is interesting about Fenton is that the dyes that react slowly or not efficiently with the OH* radical are often removable by precipitation or complexation with iron (III), which is a reaction product of the Fenton process. As a result less iron (II) is consumed for nothing!

Moreover, in the enhanced system (the Enhanced Thermal Fenton ETF and the Enhanced Photo Fenton) the intention is to concentrate the reactants and to reactivate the iron(III) by reduction (thermally, via radiation UV-VIS, or via electrochemistry).

In conclusion, the Fenton reaction is a very efficient process for treating highly-loaded segregated streams with a high concentration of non readily biodegradable substances.